

THE  
**IMPERIAL DICTIONARY,**

ENGLISH, TECHNOLOGICAL, AND SCIENTIFIC.



PE  
1625  
03  
1854  
v. 3

**PYTHAG'ORISM**, *n.* The doctrines of Pythagoras.

**PYTHAG'ORIZE**, *v. i.* To speculate after the manner of Pythagoras.

**PYTH'IAN**, *a.* [from *Pythia*, the priestess of Apollo.] Pertaining to the priestess of Apollo, who delivered oracles.—*Pythian games*, one of the four great national festivals of Greece, celebrated every fifth year in honour of Apollo near Delphi.

**PYTHON**, *n.* A genus of ophidian rep-

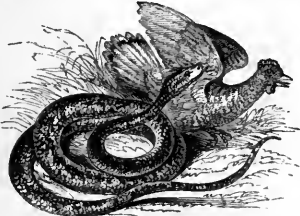

Doubly striped Python (*Python bivittatus*). tiles, which are large serpents, nearly

allied to the Boa, and found in the East Indies, South Africa, and elsewhere. They sometimes attain a length of thirty feet. They are not venomous, but kill their prey, quadrupeds, fowls, &c., by compression.

**PYTH'ONESS**, *n.* [from *L. Pytho*, Gr. *πυθων*, a dragon or serpent.] A sort of witch; also, the female or priestess who gave oracular answers at Delphi, in Greece.

**PYTHON'IC**, *a.* Pretending to foretell future events.

**PYTHONIST**, *n.* A conjurer.

**PYX**, } *n.* [*L. pyxis*; Gr. *πυξίς*.] The  
**PYX'IS**, } box in which the Romanists keep the host.—2. In *anat.*, a name for the *acetabulum* or hip-bone.—*Trial of the pyx*, a trial of the coins previous to their being issued from the Mint; so called from the box (*pyxis*) in which the pieces selected for trial were kept. Also, a trial of the purity of silver plate manufactured by silversmiths. [See *PIX*.]

**PYXID'IUM**, *n.* [*L. pyxis*, a small box.] In *bot.*, a capsule with a lid, as seen in

henbane and in the fruit of *Lecythis ollaria*, the monkey-pot tree.



Yellow Parrot on a Pyxidium of *Lecythis ollaria*.

**PYX'IS NAUTICA**, *n.* The Mariner's Compass, a southern constellation of Lacaille, placed in Argo.

## Q

**Q** is the seventeenth letter of the English Alphabet; an articulation borrowed from the oriental *koph* or *goph*, Ch. and Heb. *ק*, Samaritan *𐤒*, Syriac *ܩ*, Arabic *ق*, *haf*. It is supposed to be an articulation more deeply guttural than that of *K*; indeed, it may have been pronounced as we pronounce *qu*; for we observe that in the Latin language, from which the moderns have borrowed the letter, it is always followed by *u*, as it is in English. This letter is not in the Greek alphabet. In our mother tongue, the Anglo-Saxon, this letter is not used; but in the place of *qu*, *cu*, or more generally, *cw* is used; as in *cwic*, quick; *cween*, queen. This letter is superfluous; for *ku* or *ko*, in English, have precisely the same sounds as *qu*. It is alleged that in expressing *q*, the cheeks are contracted, and the lips put into a canular form, for the passage of the breath; circumstances which distinguish it from *k*. This appears to be a mistake. This position of the organs is entirely owing to the following letter *u*; and *question* and *question* are pronounced precisely alike, and with the same configuration of the organs. For *qu* in English, the Dutch use *kw*, the Germans *qu*, the Swedes and the Danes *qv*, which answer to our *kw*. The Gothic has a character which answers to *qu*. It appears then that *q* is precisely *k*, with this difference in use, that *q* is always followed by *u* in English, and *k* is not. *Q* never ends an English word. Its name *cue*, is said to be from the French *queue*, a tail. As a numeral, *Q* stands for 500, and with a dash, *Q̄*, for 500,000. Used as an abbreviation, *Q*, stands for *quantity* or *quantum*; as, among *physicians*, *q. pl.* *quantum placet*, as much as you please; *q. s.* *quantum sufficit*, as much as is required, or as is sufficient. *Q. V.* stand for *quantum vis*, as much as you will; or *quod vide*, which see; *Q. D.* for *quasi dictum*, as if it were said.

Among *mathematicians*, *Q. E. D.* stand for *quod erat demonstrandum*, which was to be demonstrated; *Q. E. F.* *quod erat faciendum*, which was to be done. In the *notes of the ancients*, *Q.* stands for *Quintus* or *Quintius*; *Quint.* for *Quintillus*; and *Quas.* for *quæstor*. In English, *Q.* is an abbreviation for *question*. *Qy.* or *Qu.* for *query*.

**QUAB**, *n.* [*G. quappe*; *D. kwab*.] A fish of Russian rivers, which delights in clear water.

**QUACHIL'TO**, *n.* A Brazilian fowl of the moor-hen kind, of a fine black colour variegated with white. Its voice resembles the crowing of a cock.

**QUACK**, *v. i.* [*D. kwaaken*, *G. quaken*, *Dan. qvækker*, to croak.] 1. To cry like a duck or goose.—2. To boast; to bounce; to talk noisily and ostentatiously; as, pretenders to medical skill *quack* of their cures.—3. To practise arts of quackery, as a boastful pretender to medical skill.

**QUACK**, *v. i.* To try quack medicines on.

**QUACK**, *n.* [from the verb.] A boaster; one who pretends to skill or knowledge which he does not possess.—2. A boastful pretender to medical skill which he does not possess; an empiric; a tricking practitioner in physic.

**QUACK**, *a.* Falsely pretending, or falsely alleged to cure diseases; as, *quack* medicines.

**QUACK'ERY**, *n.* The boastful pretensions or mean practice of an ignoramus, particularly in medicine; empiricism.

**QUACK'ISH**, *a.* Like a quack; boasting of skill not possessed; trickish.

**QUACK'ISM**, *n.* The practice of quackery.

**QUACK'SALVER**, *n.* [*Sw. qvacksalvare*; *quack* and *salve*.] One who boasts of his skill in medicines and salves, or of the efficacy of his prescriptions; a charlatan.

**QUAD**, *a.* [*D. kwaad*.] Evil; bad.  
**QUADR-** A prefix from the Latin

*quatuor*, implying four; as in the following words.

**QUAD'RA**, *n.* [*It.*] In *arch.*, a square frame or border enclosing a bas-relief, but sometimes used to signify any frame or border.—2. The plinth of a podium.

**QUAD'RÆ**, *n.* The fillets above and below the scotia of the Ionic base.

**QUAD'RAGENE**, *n.* [*L. quadrageni*.] A papal indulgence multiplying remissions by forties.

**QUADRAGES'IMA**, *n.* [*L. quadragesimus*, fortieth, from *quatuor*, four.] Lent; so called because it consists of forty days.—*Quadragesima Sunday*, the first Sunday in Lent, and about the fortieth day before Easter.

**QUADRAGES'IMAL**, *a.* Belonging to Lent; used in Lent.

**QUADRAGES'IMALS**, *n. plur.* Offerings formerly made to the mother church on mid-lent Sunday.

**QUAD'RANGLE**, *n.* [*L. quadratus*, square, from *quatuor*, four, and *angulus*, angle.] In *geom.*, a quadrilateral figure;

a square; a figure consisting of four sides and four angles.—2.

In *arch.*, a square surrounded by buildings, as a cloister, or the buildings of a college.

**QUADRAN'GULAR**, *a.* [*supra*.] Square; having four sides and

four angles.—2. In *bot.*, having four prominent angles, as a leaf.

**QUAD'RANS**, *n.* [*L.*] A division of the Roman *as* or one fourth part of it.

—2. A farthing, or fourth part of a penny. Before the time of Edward I. the smallest coin was a starling or penny, which was marked with a cross, so as to admit of being quartered; but to avoid unfair cutting, halfpence and farthings were coined in distinct round pieces during the above reign.

**QUAD'RANT**, *n.* [*L. quadrans*,



Quadrangle.

fourth.] 1. The fourth part; the quarter.—2. In *geom.*, the quarter of a circle; the arc of a circle containing ninety degrees; also the space or area included between this arc and two radii drawn from the centre to each extremity.—3. An instrument for taking the altitudes of the sun or stars, of great use in astronomy and navigation. Quadrants are variously made, but they all consist of the quarter of a circle, whose limb is divided into ninety degrees; or, as in Hadley's reflecting



Hadley's Quadrant.

quadrant, an arc of forty-five degrees is made to serve the same purpose as an arc of ninety degrees. *Hadley's quadrant*, in its principle and application, is the same as the sextant, by which it has been superseded. [See **SEXTANT**.] For astronomical purposes the quadrant has, of late years, been entirely superseded by the *mural circle*, it having been found that the circle, on account of the symmetry of its form and the advantage which it possesses of allowing the readings to be made at different parts of the limb, is an instrument much more to be relied on.—

*Quadrant*, in *gunnery*, or the *gunner's square*, an instrument used for elevating and pointing cannon, mortars, &c. It consists of two rectangular branches of wood or brass, having a quadrantal arch between them divided into ninety degrees, and furnished with a thread and plummet.—*Quadrant of altitude*, an appendage of the artificial globe, consisting of a slip of brass of the length of a quadrant of one of the great circles of the globe, and graduated. It is fitted to the meridian and movable round to all points of the horizon. It serves as a scale in measuring altitudes, azimuths, &c.

**QUADRANTAL**, *a.* [snpra.] Pertaining to a quadrant; also included in the fourth part of a circle; as, *quadrantal space*.—*Quadrantal triangle*, in *trigonometry*, a spherical triangle which has one side equal to a quadrant or ninety degrees.

**QUADRANTAL**, *n.* [snpra.] A vessel used by the Romans; originally called *amphora*. It was square and contained eighty pounds of water.

**QUADRANT ELECTROMETER**, *n.* An instrument adapted to measure the

intensity of the electricity contained in any electrified body, otherwise called *Henley's Electrometer*. It consists of a slender rod of very light wood, serving as an index, terminated by a small pith-ball, and suspended from the upper part of an upright stem of wood, the lower end of which is fitted to a hole in the upper surface of the conductor of an electric machine. An ivory semicircle or quadrant is affixed to the stem, having its centre coinciding with the axis of motion of the rod. When the instrument is electrified, by being placed on the electrified conductor, the index is made to diverge from the stem by repulsion, and the number of degrees which it passes over on the semicircle indicates the amount of electricity with which the apparatus is charged.



Quadrant Electrometer.

**QUADRAT**, *n.* [L. *quadratus*, squared.] 1. In *printing*, a piece of metal used to fill the void spaces between words, &c. Quadrats are of different sizes; as, *m-quadrats*, *n-quadrats*, &c.—2. A mathematical instrument, called also a *geometrical square*, and *line of shadows*. It is furnished with sights, a plummet, and index, and is used for measuring altitudes, but it is superseded by the more perfect instruments in modern use.

**QUADRATE**, *a.* Square; having four equal and parallel sides.—2. Divisible into four equal parts.—3. Square; equal; exact.—4. Suited; fitted; applicable; correspondent.

**QUADRATE**, *n.* A square; a surface with four equal and parallel sides.—2. In *astrol.*, an aspect of the heavenly bodies, in which they are distant from each other ninety degrees, or the quarter of a circle; the same as *quartile*.

**QUADRATE**, *v. i.* [L. *quadro*; Fr. *quadrer*, *cadrer*.] To suit; to correspond; to agree with; to be accommodated; followed by *with*.

Aristotle's rules for epic poetry...cannot be supposed to *quadrate* exactly with modern heroic poems. *Addison*.

**QUADRATIC**, *a.* Square; denoting a square or pertaining to it.—*Quadratic equation*, in *alge.*, an equation in which the unknown quantity is of two dimensions or raised to the second power; or one in which the highest power of the unknown quantity is a square. Quadratic equations are of two kinds, *incomplete*, or *pure*, and *complete*, or *affected*. The incomplete equation is that which contains only terms affected by the square, and not by the simple power of the unknown quantity; as,  $ax^2 = b$ . The complete or *affected* quadratic equation consists of three terms containing the square of the unknown quantity in one, the simple power in another, and the known quantity in a third. Its general form is  $ax^2 + bx = c$ , and it is always reducible to the form  $x^2 \pm ax = \pm b$ . Every quadratic equation has necessarily two roots or values of the unknown quantity.

**QUADRATIC**, *n.* A quadratic equation.

**QUADRATO**, or **QUADRO**, *n.* [It.]

A name given in music to the note B in the natural or diatonic scale, marked thus  $\flat$ , being a semitone minor higher than B mol or  $\flat$ .

**QUADRATRIX**, *n.* A square or squared figure.—2. In *geom.*, a mechanical line by means of which we can find right lines equal to the circumference of circles or other curves and their several parts.

**QUADRATURE**, *n.* [L. *quadratura*.] 1. The act of squaring; the reducing of a figure to a square. Thus the finding of a square which shall contain just as much area as a circle or a triangle, is the *quadrature* of that circle or triangle. The quadrature of the circle is a problem of great celebrity in the history of mathematical science. The whole circular area being equal to the rectangle under the radius, and a straight line equal to half the circumference, the quadrature would be obtained if the length of the circumference were assigned; and hence the particular object aimed at in attempting to square the circle is the determination of the ratio of the circumference to the diameter. This ratio can only be expressed by infinite series. The method of *quadratures* forms a branch of the Integral Calculus.—2. A quadrature; a square.—3. In *astron.*, the aspect of the moon when distant from the sun ninety degrees or a quarter of the circle; or when the moon is at an equal distance from the points of conjunction and opposition.—*Quadrature of curves*, in *math.*, the finding of rectilinear figures containing the same areas as figures bounded by curved lines.

**QUADRATUS**, *n.* [L.] A term applied to several muscles on account of their square figure; as, the *quadratus femoris*, *quadratus lumborum*.

**QUADREL**, *n.* [It. *quadrello*.] In *arch.*, a square stone, brick, or tile. The term is sometimes restricted in its application to a kind of artificial stone or brick formed of a chalky earth moulded to a square form and dried in the shade for two years.

**QUADRIENNIAL**, *a.* [L. *quadriennium*; *quadra* or *quadrans*, from *quatuor*, four, and *annus*, year.] 1. Comprising four years; as, a *quadriennial* period.—2. Occurring once in four years; as, *quadriennial* games.

**QUADRIENNIALLY**, *adv.* Once in four years.

**QUADRIBLE**, *a.* [L. *quadro*, to square.] That may be squared.

**QUADRICAPSULAR**, *a.* [L. *quadra* and *capsula*.] In *bot.*, having four capsules.

**QUADRICORNIOUS**, *a.* Having four horns.

**QUADRICORNS**, or **QUADRICORNIA**, *n.* [L. *quadra* or *quatuor*, and *cornu*, a horn.] A family of apterous insects, comprehending those which have four antennae.

**QUADRIDECIMAL**, *a.* [L. *quadra* and *decem*.] In *crystallography*, designating a crystal whose prism or the middle part has four faces and two summits, containing together ten faces.

**QUADRIDENTATE**, *a.* [L. *quadra* and *dentatus*, toothed.] In *bot.*, having four teeth on the edge.

**QUADRIENNIUM UTILE**, *n.* [L.] In *Scots law*, the four years allowed after majority, within which an action

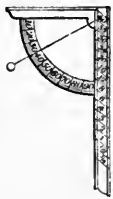

Gunner's Quadrant.

of reduction of any deed, done to the prejudice of a minor, may be instituted.

**QUADRIFID**, *a.* [L. *quadrifidus*; *quadra* and *findo*, to divide.] In *bot.*, four-cleft, i. e. divided about half-way from the margin to the base; as, a *quadrifid* perianth; cut about half-way into four segments, with linear sinuses and straight margins; as, a *quadrifid* leaf.

**QUADRIFOLIATE**, *a.* In *bot.*, having four leaves attached laterally to a common stalk.

**QUADRIGA**, *n.* [L. *quadra* and *jugum*, a yoke.] In *antiquity*, a car or chariot drawn by four horses, which were harnessed all abreast, and not in pairs. The *quadriga* is often met with on the reverse of medals.

**QUADRIGENARIOUS**, *a.* Consisting of forty.

**QUADRIGLANDULAR**, *a.* Having four glands.

**QUADRIGATE**, } *a.* [L. *quadra* and *quadrifidus*, } *jugum*, yoke.]

In *bot.*, pinnate, with four pairs of leaflets; as, a *quadrifid* leaf.

**QUADRILATERAL**, *a.* [L. *quadra*, or *quatuor*, four, and *latus*, side.] Having four sides and four angles.

**QUADRILATERAL**, *n.* A figure having four sides and four angles; a quadrangular figure. It comprehends the square, parallelogram, rectangle, rhombus, rhomboid, and trapezium.



Quadrilateral.

**QUADRILATERALNESS**, *n.* The property of having four right-lined sides, forming as many right angles.

**QUADRILITERAL**, *a.* [L. *quadra*, or *quatuor*, four, and *littera*, letter.] Consisting of four letters.

**QUADRILLE**, *n.* (*quadril'*, or *cadril'*.) [Fr.] Literally, that which consists of four, or contains four or fours; applied originally as a name to a company of foot soldiers who exhibited in a tournament or other public show.—2. A game played by four persons with 40 cards, being the remainder of the pack after the four tens, nines, and eights are discarded.—3. A kind of dance made up of sets of dancers, four in each set. Pieces of music composed for this dance are also termed *quadrilles*.

**QUADRILION**, *n.* [L. *quadra*, square, and *millio*.] The fourth power of a million, according to English arithmeticians; but, according to the French, the square of a million or the fourth power of 1000.

**QUADRILOBATE**, } *a.* [L. *quadra*, or *quadrilobed*, } *quatuor*, four, and *lobus*, Gr. *λοβος*.] In *bot.*, having four lobes; as, a *quadrilobed* leaf.

**QUADRILOCULAR**, *a.* [L. *quadra*, *quatuor*, and *loculus*, a cell.] Having four cells; four-celled; as, a *quadrilocular* pericarp.

**QUADRIN**, } *n.* [L. *quadrinus*.] A mite; a small piece of money, in value about a farthing.

**QUADRINO'MIAL**, *a.* [L. *quadra*, *quatuor*, and *nomen*, name.] Consisting of four denominations or terms.

**QUADRINOMICAL**, *a.* Of four denominations or terms.

**QUADRIPARTITE**, *a.* [L. *quadra*, *quatuor*, and *partitus*, divided.] Divided to the base into four parts, as a *quadrupartite* leaf.

**QUADRIPARTITELY**, *adv.* In four divisions; in a quadrupartite distribution.

**QUADRIPARTITION**, *n.* A division by four or into four parts; or the taking the fourth part of any quantity or number.

**QUADRIPHYLLOUS**, *a.* [L. *quadra*, or *quatuor*, and Gr. *φυλλα*, a leaf.] In *bot.*, having four leaves; four-leaved.

**QUADRIPPLICATE**, } *a.* [L. *quadra*, *quadruplicate*, } or *quatuor*, and *plica*, a fold.] In *conchology*, having four plaits or folds.

**QUADRIREME**, *n.* [L. *quadriremis*; *quatuor*, four, and *remus*, oar.] A galley with four benches of oars or rowers, in use among the ancient Greeks and Romans.

**QUADRISULCATES**, or **QUADRISULCATA**, *n.* [L. *quadra*, or *quatuor*, and *sulcus*, a furrow.] A name given to those ungulate quadrupeds, in which the hoof is divided into four parts, corresponding to the four digits.

**QUADRISYLLABLE**, *n.* [L. *quadra*, *quatuor*, and *syllable*.] A word consisting of four syllables.

**QUADRIVALVE**, } *a.* In *bot.*, *quadrivalvular*, } having four valves; four-valved; as, a *quadrivalve* pericarp.

**QUADRIVALVES**, *n. plur.* [L. *quadra*, *quatuor*, and *valva*, valve.] A door with four folds or leaves.

**QUADRIVIAL**, *a.* [L. *quadrivium*; *quatuor*, four, and *via*, way.] Having four ways meeting in a point.

**QUADRIVIUM**. [L.] In *the lan. of the schools*, the four lesser arts,—arithmetic, music, geometry, and astronomy.

**QUADROON**, } *n.* [L. *quadra*, *quateron*, } *tuor*.] In Spanish America, the offspring of a mulatto woman by a white man; a person quarter-blooded.

**QUADRUMAN**, *n.* [L. *quadra* and *manus*, hand.] An animal having four hands that correspond to the hands of a man, as a monkey.

**QUADRUMANA**, or **QUADRUMANES**, *n. plur.* Animals having four hands, as monkeys. Among the *quadrumana* are those forms approaching the nearest — though the distance is still great — to man. The hinder extremities are terminated by more perfect hands than the fore extremities, having free thumbs, which are opposable to the other fingers. In the fore extremities the thumb is sometimes wanting, or in the case of the South American monkeys, incapable of being opposed to the other digits. They climb trees with facility, but they do not stand or walk erect except with difficulty. The liberty of their fore arms, and the complication of their hands, enable them to perform many actions and gestures similar to those of man. In Cuvier's arrangement, *quadrumana* constitute the second order of mammiferous animals, embracing the Simia, or Apes, Linn., including the Orang; the Onistitis, and the Lemurs.

**QUADRUMANOUS**, *a.* Having four hands; four-handed.

**QUADRURUNE**, *n.* A gritstone with a calcareous cement.

**QUADRUPED**, *a.* [L. *quadrupes*; *quadra*, *quatuor*, four, and *pes*, foot.] Having four legs and feet. Formerly, all vertebrate animals with four legs were termed quadrupeds, but as there are reptiles having four legs, the term quadruped is no longer used in a strict zoological sense as indicative of a particular group of animals.

**QUADRUPED**, *n.* An animal having four legs and feet; as a horse, an ox, a lion, &c.

**QUADRUPLE**, *a.* [L. *quadruplus*; *quadra*, *quatuor*, and *plico*, to fold.] Fourfold; four times told; as, to make *quadruple* restitution for trespass or theft.—*Quadruple alliance*, the name given to the alliance concluded between Austria, Great Britain, Russia, and Prussia, March 1st, 1814; and which was so called from the number of the contracting parties. Its avowed object was to maintain the peace of Europe.

**QUADRUPLE**, *n.* Four times the sum or number; as, to receive *quadruple* the amount in damages or profits.

**QUADRUPLE**, *v. t.* To make four times as much, or as many.

**QUADRUPLED**, *pp.* Made four times as much or many.

**QUADRUPPLICATE**, *a.* Fourfold; four times repeated; as, a *quadruplicate* ratio or proportion.

**QUADRUPPLICATE**, *v. t.* [L. *quadruplico*; *quatuor* and *plico*, to fold.] To make fourfold; to double twice.

**QUADRUPPLICATED**, *pp. or a.* Having four plaits or folds; made fourfold.

**QUADRUPPLICATION**, *n.* The act of making fourfold and taking four times the simple sum or amount.

**QUADRUPPLING**, *ppr.* Making four times as much or many.

**QUADRUPPLY**, *adv.* To a fourfold quantity; as, to be *quadruply* recompensed.

**QUAERE**. The imperative of the Latin verb *quaero*, signifying search, inquire. When placed before a proposition it implies a doubt of its truth. [See **QUERY**.]

**QUESTOR**. See **QUESTOR**.

**QUAFF**, *v. t.* [Fr. *coiffer*, to cap or hood; *se coiffer*, to fuddle, or be fuddled, from *coiffe*, a hood. But qu. In the Ethiopic, *quaf* or *hwaf*, is to draw, to draw out. In Arabic, *kauba* or *kwaba*, is to drink largely, or to devour, as food.] To drink; to grope for food in the water, as a duck; to swallow in large draughts.

He *quaffs* the muscadel. *Shak.*  
They in communion sweet  
*Quaff* immortality and joy. *Milton.*

**QUAFF**, *v. i.* To drink largely or luxuriously.

**QUAFFED**, *pp.* Drank; swallowed in large draughts.

**QUAFFER**, *n.* One that quaffs or drinks largely.

**QUAFFER**, } *v. t.* To feel out.

**QUAFFING**, *ppr.* Drinking; swallowing draughts.

**QUAGGA**, *n.* A pachydermatous mammal, the *Equus Quagga*, nearly allied



Quagga (Equus Quagga).

to the ass on the one hand, and the

zebra on the other. It inhabits southern Africa.

**QUAG'GY**, *a.* [supposed to be from the root of *Quake*.] Yielding to the feet or trembling under the foot, as soft wet earth.

**QUAG'MIRE**, *n.* [that is, *quake-mire*.] Soft wet land, which has a surface firm enough to bear a person, but which shakes or yields under the feet.

**QUAG'MIRE**, *v. t.* To whelm as in a quagmire.

**QUAHAUG**, *a.* (quaw'hog.) In New England, the popular name of a large species of clams or bivalvular shells. [This name is probably derived from the natives.]

**QUAICH**, *n.* [Irish Gaelic *cuach*, a cup or bowl.] A small and shallow drinking cup or vessel, with two ears for handles; generally of wood, but sometimes of silver. [Scotch.]

**QUAID**, *† a. or pp.* [for *Quailed*.] Crushed, subdued, or depressed.

**QUAIL**, *v. i.* [*Quail*, in English, signifies to sink or languish, to curdle, and to crush or quell. The Italian has *quagliare*, to curdle, and the Sax. *cuellan*, to quell, and the D. *kwaal* is disease. If these are of one family, the primary sense is to shrink, to withdraw, and transitively, to beat down. In W. *cwl* signifies a flagging or drooping; *cuola*, faint, languid.] 1. To sink into dejection; to languish; to fail in spirits.—2. *†* To fade; to wither.

**QUAIL**, *v. i.* [Fr. *cailler*; It. *quagliare*, to curdle; W. *caul*, a calf's maw, rennet, chyle, a curd; *ceulaw*, to curdle. The sense is to contract.] To curdle; to coagulate; as milk.

**QUAIL**, *v. t.* [Sax. *cuellan*.] To crush; to depress; to sink; to subdue.

**QUAIL**, *n.* [It. *quaglia*; Fr. *caille*; Arm. *coail*.] A vague English popular name of certain gallinaceous birds. It is applied to more than twenty different species, and of more than one genus. According to the arrangement of Latham, a bird of the genus *Perdix*, in which he includes the partridge and



Common Quail (*Coturnix vulgaris*).

quail. Quails differ from partridges in being smaller, in having a more delicate beak, shorter tail, no red eyebrows, and no spur on the legs. They are migratory birds, and found in every country from the Cape of Good Hope to the North Cape. Their flesh is deemed excellent food. Quails constitute the genus *Coturnix* of Cuvier, and belong to the genus *Tetrao*, Linn. **QUAILING**, *ppr.* Failing; languishing. **QUAILING**, *n.* The act of failing in spirit or resolution; decay.

**QUAIL-PIPE**, *n.* A pipe or call for alluring quails into a net; a kind of leathern purse in the shape of a pear, partly filled with horse hair, with a whistle at the end.

**QUAINT**, *a.* [Old Fr. *coigt*, Arm. *coent*, *coant*, pretty. In Norman French,

*coint* is familiar, affable, and *accointet*, is very necessary or familiar. The latter word would lead us to refer *quaint* to the Latin *accinctus*, ready, but Skinner thinks it more probably from *comptus*, neat, well dressed.] 1. Nice, dainty, curious; scrupulously and superfluously exact; having petty elegance; as, a *quaint* phrase; a *quaint* fashion.

To show how *quaint* an orator you are.

*Shak.*

2. *†* Subtle; artful.—3. Fine-spun; artfully framed; neat, pretty, exact.

—4. Affecting; as, *quaint* fopperies.—5. In common use, odd; fanciful; singular; and so used by Chaucer.—6. Unusual; wonderful.

**QUAINTLY**, *adv.* Nicely; exactly; with petty neatness or spruceness; as, hair *quaintly* curled.—2. Artfully.

Breathe his faults so *quaintly*. *Shak.*

3. Ingeniously; with dexterity.

1 *quaintly* stole a kiss. *Gay.*

**QUAINTNESS**, *n.* Niceness; petty neatness or elegance.—2. Oddness; peculiarity.

**QUAKE**, *v. i.* [Sax. *cvacian*; G. *quacheln*; Eth. *huyha*, to shake, to agitate.] 1. To shake; to tremble; to be agitated with quick but short motions continually repeated; to shudder. Thus we say, a person *quakes* with fear or terror, or with cold; Heb. xii.—2. To shake with violent convulsions, as well as with trembling; as, the earth *quakes*; the mountains *quake*; Neh. i.—3. To shake, tremble or move, as the earth under the feet, through want of solidity or firmness; as, the *quaking* mud.

**QUAKE**, *† v. t.* To frighten; to throw into agitation.

**QUAKE**, *n.* A shake; a trembling; a shudder; a tremulous agitation.

**QUAKER**, *n.* One that quakes; but usually applied to one of the religious sect called the *Society of Friends*. This sect had its origin in England about the middle of the seventeenth century. Its founder was George Fox, a native of Drayton in Leicestershire. He proposed but few articles of faith, insisting chiefly on moral virtue, natural charity, the love of God, and a deep attention to the inward motions and secret operations of the Spirit. The quakers reject all sacraments, and they appoint no *order* of ministers, but consider the instruction and edification of their congregations to be the province of any person of either sex, who conceives himself or herself to be called to the service. When satisfied of their being thus divinely qualified, they are acknowledged ministers; but the Quakers believe such can only exercise their gift acceptably, or profitably, by the assistance of the Holy Spirit at the time. They exhibit great sobriety of behaviour, a singular probity and uprightness in their dealings, a great frugality at their tables, and a remarkable plainness and simplicity in their dress. They refuse to take judicial oaths, but from these the law exempts them. The name, *quakers*, was given in reproach, by a persecuting Justice, because Fox admonished him to *tremble* at the word of the Lord; and on account of some of them being seen to tremble while preaching—but it was never adopted by the Society.

**QUAKERISM**, *n.* The peculiar manners, tenets, or worship of the quakers.

**QUAKERLY**, *a.* Resembling quakers.

**QUAKERY**, *† n.* Quakerism.

**QUAKING**, *ppr.* Shaking; trembling. **QUAKING**, *n.* A shaking; tremulous agitation; trepidation; Dan. x.

**QUAKING BOG**, *n.* Peat bog in a growing state, and so saturated with water that a considerable extent of surface will quake or shake when pressed on by the foot, or any other body.

**QUAKING-GRASS**, *n.* Various species of graminaceous plants of the genus *Briza*. They are so named from their spikelets being always in a state of tremulous motion, in consequence of the weakness of the footstalks by which they are supported. Two species are found in Britain.

**QUALIFIABLE**, *a.* [from *qualify*.] That may be qualified; that may be abated or modified.

**QUALIFICATION**, *n.* [Fr. See *QUALIFY*.] Any natural endowment or any acquirement which fits a person for a place, office, or employment, or enables him to sustain any character with success. Integrity and talents should be considered as indispensable *qualifications* for men intrusted with public affairs; but private interest and party-spirit will often dispense with these and all other *qualifications*.

There is no *qualification* for government but virtue and wisdom, actual or presumptive. *Burke.*

2. Any property or possession which gives one a right to exercise the elective franchise, or furnishes one with any legal power or capacity.—3. Abatement; diminution.—4. Modification; restriction; limitation. Words or expressions may be used in a general sense, without any *qualification*.

**QUALIFIED**, *pp.* Fitted by accomplishments or endowments; modified; furnished with any legal power or capacity; possessed of the elective franchise; as a person duly *qualified* to vote at an election for a member of parliament.—*Qualified fee*, in law, a base fee, or an estate which has a qualification annexed to it, and which ceases with the qualification, as a grant to A. and his heirs, *tenants of the manor of Dale*.—*Qualified negative*, in American legislation, the power of negating bills which have passed the two houses of the legislature; a power vested in the president, governor or other officer, but subject to be overruled and defeated by a subsequent vote of the two houses, passed in conformity with the provisions of the Constitution.—*Qualified property* is that which depends on temporary possession, as that in wild animals reclaimed. *Qualified oath*, in *Scots law*, the oath of a party on a reference where circumstances are stated which must necessarily be taken as part of the oath, and which therefore qualify the admission or denial.

**QUALIFIEDNESS**, *n.* The state of being qualified or fitted.

**QUALIFIER**, *n.* He or that which qualifies; that which modifies, reduces, tempers or restrains.

**QUALIFY**, *v. t.* [Fr. *qualifier*; It. *qualificare*; Sp. *calificar*; L. *qualis*, such, and *facio*, to make.] 1. To fit for any place, office, occupation, or character; to furnish with the knowledge, skill, or other accomplishment necessary for a purpose; as, to *qualify* a man for a judge, for a minister of state or of the gospel, for a general or admiral. Holiness alone can *qualify* men for the society of holy beings.—



2. To make capable of any employment or privilege; to furnish with legal power or capacity; as, to *qualify* a man to kill game; to *qualify* persons for exercising the elective franchise.—3. To abate; to soften; to diminish; as, to *qualify* the rigour of a statute. I do not seek to quench your love's hot fire.

But *qualify* the fire's extreme rage. *Shak.*  
4. To ease; to assuage.—5. To modify; to restrain; to limit by exceptions; as, to *qualify* words or expressions, or to *qualify* the sense of words or phrases.—6. To modify; to regulate; to vary; as, to *qualify* sounds.

QUALIFY, v. i. To take the necessary steps for rendering one capable of holding any office, or enjoying any privilege; to establish a claim or right to exercise the elective franchise; followed by *for*; as, to *qualify* for a juror, or for a justice of the peace; to *qualify* for a parliamentary elector.

QUALIFYING, *ppr.* Furnishing with the necessary qualities, properties, or accomplishments for a place, station, or business; furnishing with legal power; abating; tempering; modifying; restraining.

QUALITATIVE, *a.* Estimable according to quality.—*Qualitative analysis*, in *chem.*, that species of analysis the object of which is to ascertain the quality of the constituent parts of any compound. [See QUANTITATIVE.]

QUALTIED, *a.* Disposed as to qualities or passions.

QUALITY, *n.* [L. *qualitas*, from *qualis*, such; Fr. *qualité*; Ir. *caíl*.] 1. Property; that which belongs to a body or substance, or can be predicated of it. Qualities are *natural* or *accidental*. Thus whiteness is a *natural quality* of snow; softness is a *natural quality* of wool and fur; hardness is a *natural quality* of metals and wood; figure and dimension are the *natural qualities* of solids; but a particular figure, as a cube, a square, or a sphere, is an *accidental* or *adventitious quality*. The fluidity of metals is an *accidental quality*. *Essential* qualities are such as are necessary to constitute a thing what it is. *Sensible* qualities are such as are perceptible to the senses, as the light of the sun, the colour of gold, the taste of salt or sugar, &c.—*Occult qualities*. [See OCCULT.] Among the ten categories of Aristotle, *quality* forms the third; but in the philosophy of Kant, it forms the second (there being four in all), comprising the motions of existence or reality, non-existence or negation, and limitation.—2. Nature, relatively considered; as, the *quality* of an action, in regard to right and wrong.

Other creatures have not judgment to examine the *quality* of that which is done by them. *Hooker.*

3. Virtue or particular power of producing certain effects; as, the *qualities* of plants or medicines.—4. Disposition; temper. To-night we'll wander through the streets, and note

The *qualities* of people. *Shak.*

5. Virtue or vice; as, good *qualities*, or bad *qualities*.—6. Acquirement; accomplishment; as, the *qualities* of horsemanship, dancing, and fencing.—7. Character.

The attorney partakes of both *qualities*: that of a judge of the court, and that of attorney-general. *Bacon.*

8. Comparative rank; condition in relation to others; as, people of every *quality*.

We obtained acquaintance with many citizens not of the meanest *quality*. *Bacon.*

9. Superior rank; superiority of birth or station; as, persons of *quality*; ladies of *quality*.—10. Persons of high rank, collectively.

I shall appear at the masquerade dressed up in my feathers, that the *quality* may see how pretty they will look in their travelling habits. *Addison.*

QUÄLM, *n.* (quäm.) [D. *kwaal*, disease; *kwaalyh*, sick; G. *quälen*, to pain or vex. In G. *quälm* is steam, vapour, exhalation; D. *kwaalm*, id. The Danish *quälm* signifies vapour, steam, fume, exhalation; *quälmer*, to ramble; *det giver quälme*, it rises in the stomach. The latter is the English word.] 1. A rising in the stomach, as it is commonly called; a fit of nausea, or a disposition or effort of the stomach to eject its contents.—2. A sudden fit or seizure of sickness at the stomach; a sensation of nausea; as, *quälms* of heart-sick agony.

For who, without a *quälm*, have ever look'd On holy garbage, though by Homer cook'd? *Roscommon.*

3. A scruple of conscience, or uneasiness of conscience.

QUÄLMISH, *a.* (quämish.) [supra.] Sick at the stomach; inclined to vomit; affected with nausea or sickly language.

QUÄLM'ISHLY, *adv.* In a *quälmish* manner.

QUÄLM'ISHNESS, *n.* Nausea. QUAMASH, *n.* The North American name of an eatable bulb, found in the plains of the Missouri, and called *Camassia esculenta* by botanists. It is a liliaceous plant, nearly allied to the European squill.

QUAMDIU SE BENE GESSERIT. [L.] During good behaviour.

QUAM'OELIT, *n.* A genus of climbing ornamental plants; nat. order Convolvulaceæ, chiefly found in the hot parts of America, but the species are indigenous both in India and China.

QUAN'DARY, *n.* [Fr. *Qu'en dirai-je?* what can I say to it?] Doubt; uncertainty; a state of difficulty or perplexity.

QUAN'DARY, *v. t.* To bring into a state of uncertainty or difficulty.

QUANT, *n.* A small piece of board at the bottom of a jumping pole, or pole by which persons in fenny places are enabled to jump across ditches and drains. The use of the quant is to prevent the pole sinking into the mud by the weight of the jumper's body. The same name is also given to the pole itself.

QUANTITATIVE, *a.* [See QUANTITY.] Estimable according to quantity.—*Quantitative analysis*, in *chem.*, that species of analysis the object of which is to ascertain the quantity of the ingredients in any given compound.

QUANTITATIVE, *a.* [See QUANTITY.] Estimable according to quantity.

QUANTITY, *n.* [Fr. *quantité*; from L. *quantitas*, from *quantus*, how much, or as much as; Pers. *chand*, how much; *chandi*, quantity.] 1. That property of any thing which may be increased or diminished. This definition is defective, and as applicable to many other properties as to quantity. A definition strictly philosophical can-

not be given. In common usage, *quantity* is a mass or collection of matter of indeterminate dimensions or weight, but consisting of particles which cannot be distinguished, or which are not customarily distinguished, or which are considered in the aggregate. Thus we say, a *quantity* of earth, a *quantity* of water, a *quantity* of air, of light, of heat, of iron, of wood, of timber, of corn, of paper. But we do not say, a *quantity* of men, or of horses, or of houses; for as these are considered as separate individuals or beings, we call an assemblage of them, a *number* or *multitude*. *Quantity* is distinguished into *continued* and *discrete*. It is continued when the parts are connected together, and is then called *magnitude*, which is the object of geometry. It is discrete when the parts have an unconnected and independent existence, forming *multitude* or *number*, which is the object of arithmetic.—2. An indefinite extent of space.—3. A portion or part.

If I were sawed into *quantities*. *Shak.*  
4. A large portion; as, a medicine taken in *quantities*, that is, in *large quantities*.—5. In *math.*, any thing which can be multiplied, divided, or measured. Thus mathematics is called the science of quantity. In algebra, quantities are *known* and *unknown*. *Known quantities* are usually represented by the first letters of the alphabet, as *a, b, c*, and *unknown quantities* are expressed by the last letters, *x, y, z*, &c. Letters thus used to represent quantities are themselves called *quantities*. A simple quantity is expressed by one term, as  $+a$ , or  $-abc$ ; a compound is expressed by more terms than one, connected by the signs,  $+plus$ , or  $-minus$ , as  $a+b$ , or  $a-b+c$ . Quantities which have the sign  $+$  prefixed, are called *positive* or *affirmative*; those which have the sign  $-$  prefixed are called *negative*.—*Similar quantities* are such as consist of the same letters, and the same powers of the letters; as *abc*,  $-3abc$ ,  $+6abc$ ,  $-9abc$ . *Unlike or dissimilar quantities* are those which consist of different combinations of letters; as *ab*, *ab<sup>2</sup>*, *3abc*, *4xy*, &c.—6. In *gram.*, the measure of a syllable; that which determines the time in which it is pronounced.—7. In *logic*, a category, universal, or predicament; a general conception.—8. In *music*, the relative duration of a note or syllable.—*Quantity of matter*, in a body, is the measure arising from the joint consideration of its magnitude and density. Or the quantity of matter in a body is proportional to the magnitude and density of the body conjointly, and is measured by its absolute weight. [See MASS.] *Quantity of motion*, in a body, is used synonymously with *momentum*, to denote the product of the quantity of matter in the moving body by its velocity.

QUANTUM, *n.* [L.] The quantity; the amount.—*Quantum meruit*. In law, an action grounded on a promise that the defendant would pay to the plaintiff for his service as much as he should deserve.—*Quantum sufficit*. Sufficient; as much as is needed.—*Quantum valet*. An action to recover of the defendant for goods sold, as much as they were worth.

QUA-QUA-VER'SAL, *a.* [See QUANTUM] Inclined towards every side; facing all

ways.—*Quaquaversal dip*, in *geol.*, a term applied to the dip of a bed which is inclined facing all sides.

**QUAR'ANTAIN**, or **QUAR'ANTAINÉ**, *n.* The space of forty days.—*See* QUARANTINE.

**QUAR'ANTINE**, *n.* [It. *quarantina*, forty; Fr. *quarantaine*; from the root of *L. quartus*, fourth, Fr. *carreau*, a square, *carrer*, to square, Arm. *carrea*, to square, W. *cwar*, square, Eng. *quart*. *See* QUART and SQUARE.] 1. Properly, the space of forty days during which a ship arriving in port and suspected of being infected with a malignant, contagious disease, is obliged to forbear all intercourse with the city or place. Hence,—2. Restraint of intercourse to which a ship is subjected on the presumption that she may be infected, either for forty days or for any other limited term. It is customary for the proper officers to determine the period of restraint at their discretion, according to circumstances. Hence we hear of a *quarantine* of five days, of ten, of thirty, &c. as well as of forty. We say, a ship performs *quarantine*, or rides at *quarantine*. We also apply the word to persons. The passengers and crew perform *quarantine*.—3. In *law*, the period of forty days, during which the widow of a man dying seized of land, has the privilege of remaining in the mansion house, provided it be not a castle.—4. The season of Lent, which is the forty days preceding Easter.

**QUARANTINE**, *v. t.* To prohibit from intercourse with a city or its inhabitants; to compel to remain at a distance from shore for forty days, or for other limited period, on account of real or supposed infection; applied to ships, or to persons and goods.

**QUARANTINED**, *pp.* Restrained from communication with the shore for a limited period; as a ship or its crew and passengers.

**QUARANTINING**, *ppr.* Prohibiting from intercourse with the port; as a ship or its crew and passengers.

**QUA'RE IMPEDIT**. [L.] In *law*, a writ lying for one who has a right of advowson against a person who hinders or disturbs him in his right, by presenting a clerk when the church is void.

**QUARE**, for *Quarry*, not in use.

**QUAR'REL**, *n.* [W. *cueryl*; Fr. *querelle*; L. and It. *querela*; L. *queror*, to complain, that is, to cry out with a loud voice. Hence we see the primary sense is the same as *brawl*. The L. *queror* coincides in elements with the Ir. *gairim*, to call, to bawl, to shout, and *gearan*, a complaint; Sax. *ceorian*, to complain or murmur; G. *girren* and *hirren*; D. *hirren* and *horren*; Dan. *herrer*. The latter signifies to complain, to expostulate, and *herrer sig efter*, to care, to take heed of, a sense which would unite the word with the L. *curo*, *cura*, and in Saxon, *cearig* signifies complaining, and careful, solicitous; Heb. Ch. Syr. and Ar. קָרָה, *kara*.] 1. A brawl; a petty fight or scuffle; from its noise and uproar.—2. A dispute, a contest.

On open seas their quarrels they debate.

*Dryden.*

3. A breach of friendship or concord; open variance between parties.—4. Cause of dispute.

The king's quarrel is honourable. *Shak.*

5. Something that gives a right to mischief, reprisal, or action.

He thought he had a good quarrel to attack him.† *Holingshead.*

6. Objection; ill will, or reason to complain; ground of objection or dispute.

Herodias had a quarrel against him; Mark vi.

7.† Something peevish, malicious, or disposed to make trouble.

**QUAR'REL**, *n.* [W. *gwarel*, a dart or javelin, a kernel; *gwarelu*, to dart, to kern, to curdle; from *gwar*, a quick rise, a puff; Fr. *carreau*, a bolt. The primary sense is to shoot, throw, or drive.] 1. A dart discharged by a cross-bow. Quarrels or quarreaux were so called from their heads, which were square pyramids of iron.—2. A pane of glass, or a lozenge-shaped pane of glass placed vertically, and used in lead casements; also the opening in the window in which the pane is set.—3. A small paving stone or tile of the square or lozengeform. [*See* QUARRY and SQUARE.]

**QUAR'REL**, *v. i.* [Fr. *quereller*. *See* the Noun.] 1. To dispute violently or with loud and angry words; to wrangle; to scold. How odious to see husband and wife quarrel!—2. To fight; to scuffle; to contend; to squabble; used of two persons or of a small number. It is never used of armies and navies in combat. Children and servants often quarrel about trifles. Tavern-hunters sometimes quarrel over their cups.—3. To fall into variance.

Our people quarrel with obedience. *Shak.*

4. To find fault; to cavil.

I will not quarrel with a slight mistake.

Quarrel.



*Roscommon.*

Men at enmity with their God, quarrelling with his attributes—quarrelling with the Being that made them, and who is constantly doing them good. *Eliph. Steele.*

5. To disagree; to be at variance; not to be in accordance in form or essence. Some things arise of strange and quarrelling kind.

The forepart lion, and a snake behind. *Cowley.*

**QUAR'REL**, *v. t.* To quarrel with.—2. To compel by a quarrel; as, to quarrel a man out of his estate or rights.

**QUAR'RELLER**, *n.* One who quarrels, wrangles, or fights.

**QUAR'RELLING**, *ppr.* Disputing with vehemence or loud angry words; scolding; wrangling; fighting; finding fault; disagreeing.

**QUAR'RELLING**, *n.* [*supra.*] Contention; dispute in angry words; breach of concord; a cavilling or finding fault; disagreement.

**QUAR'RELLOUS**, *a.* Apt or disposed to quarrel; petulant; easily provoked to enmity or contention. [*Little used.*]

**QUAR'RELSOME**, *a.* Apt to quarrel; given to brawls and contention; inclined to petty fighting; easily irritated or provoked to contest; irascible; choleric; petulant.

**QUAR'RELSOMELY**, *adv.* In a quarrelsome manner; with a quarrelsome temper; petulantly.

**QUAR'RELSOMENESS**, *n.* Disposition to engage in contention and brawls; petulance.

**QUAR'RIED**, *pp.* Dug from a pit or cavern.

**QUAR'RY**, *n.* [Fr. *carré*, for *quarré*; Arm. *id.* *See* QUARANTINE.] 1.† A

square; as, a quarry of glass.—2.† An arrow with a square head. [*See* QUARREL.—3. In *falconry*, the game which a hawk is pursuing or has killed; hence any thing pursued for prey. [Perhaps from *L. quarro*, Fr. *querir*, to seek.—4. Among hunters, a part of the entrails of the beast taken, given to the hounds; also, a heap of game killed.—5. A small square paving flag or brick.

**QUAR'RY**, *n.* [Fr. *carrière*, formerly Norm. *quarrier*. We doubt whether the original sense of this word was a pit or mine, from *digging*, or whether the sense was a place for squaring stone. The Fr. *carrière* signifies not only a quarry, but a career, course, race, from the *L. curro*, which cannot be from squaring. If the sense was a pit, it may be referred to the Heb. Ch. and Eth. כָּרָה, *herah*, to dig; Ar. *kara* or *hwara*, to dig, to run violently, to leap. If the sense is from squaring. *See* SQUARE.] 1. A place, cavern, or pit where stones are dug from the earth, or separated from a large mass of rocks. We generally apply the word *mine* to the pit from which are taken metals and coals; from quarries are taken stones for building, as marble, freestone, slate, &c.

**QUAR'RY**, *v. i.* To prey upon, as a vulture or harpy. [*A low word and not much used.*]

**QUAR'RY**, *v. t.* To dig or take from a quarry; as, to quarry marble.

**QUAR'RYING**, *ppr.* Digging stones from a quarry.

**QUAR'RYING**, *n.* The operation of extracting from the ground or detaching from the sides of rocks, marble, stone, or other minerals, in considerable masses, for the purposes chiefly of sculpture and architecture.

**QUAR'RYMAN**, *n.* A man who is occupied in quarrying stones.

**QUART**, *n.* (quort.) [It. *quarta*; Fr. *quarte*, from *quart*, a fourth, L. *quartus*; G. *quart*; from W. *cwar*, the root of square, or from the root of Gr. *αειν*, to fit or suit, to square. We see in the Amharic, the ancient dialect of the Ethiopic, *art* is four, and *arten* is fourth, L. *quartus*. This with the Celtic pronunciation, as *guerre* for *war*, becomes *quart*.] 1.† The fourth part; a quarter.—2. The fourth part of an imperial gallon; two pints, equal to 69.3185 cubic inches. The old English quart for wine and spirits contained 57.75 cubic inches; that for beer and ale, 70.5 cubic inches; and that for dry measure 67.2 cubic inches nearly.—3. A vessel containing the fourth of a gallon.—4. A sequence of four cards in the game of piquet.

**QUARTAN**, *a.* (quort'an.) [L. *quartanus*, the fourth.] Designating the fourth; occurring every fourth day; as, a *quartan* ague or fever.

**QUART'AN**, *n.* An intermitting ague that occurs every fourth day, or with intermissions of seventy-two hours.—2. A measure containing the fourth part of some other measure.

**QUARTATION**, *n.* In *chem.* and *metallurgy*, the operation by which the quantity of one thing is made equal to the fourth part of another thing; or it is the alloying of one part of gold that is to be refined, along with three parts of silver, so that the gold shall constitute one *quartier* of the whole, and thereby have its particles too far separated to be able to protect the silver originally associated with it from the action of the nitric or sulphuric acid

employed in the subsequent parting process.—2. The separation of silver from gold by means of nitric acid.

**QUARTER, n.** (quor'ter.) [Fr. *quart*, *quartier*; G. *quartier*; L. *quartus*, the fourth part; from W. *cwâr*, a square.] 1. The fourth part; as, the *quarter* of an hour or of a mile; one *quarter* of the expense. Living is a *quarter* dearer in the city than in the country.—2. In *avoirdupois weight*, the fourth part of a hundredweight, or of 112 pounds, that is, twenty-eight pounds; as a *quarter* of sugar.—3. As a *standard measure of capacity*, for liquid and dry goods, a *quarter* is eight bushels, equal to 17745.536 cubic inches. Four *quarters* make a chaldron, and ten *quarters* a last. In old English dry measure, the *quarter* contained 17203.36 cubic inches.—4. In *dry measure*, eight bushels; as, a *quarter* of wheat.—5. In *astron.*, the fourth part of the moon's period or monthly revolution; as, the first *quarter* after the change or full.—6. A region in the hemisphere or great circle; primarily, one of the four cardinal points; as, the four *quarters* of the globe; but used indifferently for any region or point of the compass. From what *quarter* does the wind blow? Hence,—7. A particular region of a town, city, or country; as, all *quarters* of the city; in every *quarter* of the country or of the continent. Hence,—8. Usually in the plural, *quarters*, the place of lodging or temporary residence; appropriately, the place where officers and soldiers lodge, but applied to the lodgings of any temporary resident. The place furnished good winter *quarters* for the troops. I saw the stranger at his *quarters*.—9. Proper station. Swift to their several *quarters* hasten then.

*Milton.*  
Bacon uses the word in the singular. "Make love keep *quarter*."—10. On board of ships, *quarters* signifies the stations or places where the officers and men are posted in action. Pipe all hands to *quarters*.—11. In *milit. affairs*, the remission or sparing of the life of a captive or an enemy when in one's power; mercy granted by a conqueror to his enemy, when no longer able to defend himself.

Begging of *quarter* originated from an agreement, anciently made between the Dutch and Spaniards, that the ransom of a soldier should be the *quarter* of his pay.

*Dr Trusler.*  
12. Treatment shown to an enemy; indulgence.

To the young, if you give tolerable *quarter*, you indulge them in idleness and ruin them. [Rarely used.] *Collier.*

13.† Friendship; amity; concord.—14. In the *slaughter house*, one limb of a quadruped with the adjoining parts; or one-fourth part of the carcass of a quadruped, including a limb; as, a fore *quarter*, or hind *quarter*.—15. In *furriery*, the *quarters* of a horse's foot are the sides of the coffin, between the toe and the heel. *False quarters* are a cleft in the horn of the hoof, extending from the coronet to the shoe, or from top to bottom. When for any disorder one of the *quarters* is cut, the horse is said to be *quarter-cast*.—16. In a siege, *quarters* are the encampment on one of the principal passages round the place besieged, to prevent relief and intercept convoys.—17. In *seminaries of learning*, a fourth part of the year, or three months. Tuition and board at

11.

five guineas the *quarter*. This is a moderate *quarter* bill.—18. The *quarter* of a ship, is the part of a ship's side which lies toward the stern, or the part between the aftmost end of the main-chains and the sides of the stern, where it is terminated by the quarter-pieces.—19. In *her.*, one of the divisions of a shield, when it is divided cross-wise. It is an ordinary of a quadrangular form resembling a banner, and laid as a charge upon the field, of which it contains one-fourth part, as the term implies.—20. In *arch.*, a square panel enclosing a quatrefoil, or other ornament. *Quarters* are the upright posts in partitions to which the laths are nailed. They should never be more than fourteen inches apart.—

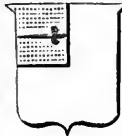

Quarter.

On the *quarter*, in *seamen's lan.*, is a point in the horizon considerably abaft the beam, but not in the direction of the stern.—*Quarter-bill*, among *seamen*, is a list containing the different stations where the officers and crew are to take post in time of action, and the names of the men assigned to each.—*Quarter-cloths*, in *ships*, long pieces of painted canvas, extended on the outside of the *quarter-netting* from the upper part of the gallery to the gangway.—*Quarter-deck*, that part of the deck of a ship which extends from the stern to the mainmast. But in some kinds of vessels, the *quarter-deck* does not extend to the mainmast, but is raised above the main deck.—*Quarter-gallery*, a sort of balcony on the *quarters* of a ship.—*Quarter-master*, in an army, an officer whose business is to attend to the *quarters* for the soldiers, their provisions, fuel, forage, &c.; in the navy, an officer who assists the mates in their duties, in stowing the hold, coiling the cables, attending the steerage, and keeping time by the watch glasses.—*Quarter-master-general*, in *milit. affairs*, is an officer whose duty is to mark the marches and encampments of an army, the head-quarters, the place for the artillery, and procure supplies of provisions and forage, &c.—*Quarter-point*, in *navigation*, the fourth part of a point of the compass, or 2° 48'.—*Quarter-railing*, narrow moulded planks, reaching from the top of the stern to the gangway, serving as a fence to the *quarter-deck*.—*Quarter-round*, in *arch.*, the echinus or ovolo.—*Quarter-seal*, a seal kept by the director of the Scottish chancery. It is in shape and impression the fourth part of the great seal. Commissions of tutory and of briefs issuing from the chancery pass by the *quarter seal*, so do all gifts and presentations to land of bastardy, forfeiture, or *ultimus hæres*, where the lands hold of a subject.—*Quarter-days*, the days usually regarded in England as beginning the four *quarters* of the year. They are, 1. Lady-day (25th March); 2. Midsummer-day (24th June); 3. Michaelmas-day (29th September); and 4. Christmas-day (25th December).—*Quarter-sessions*, in *England*, a general court held quarterly by the justices of peace of each county, with jurisdiction to try and determine felonies and trespasses; but capital offences are seldom or never tried in this court.—*Quarter-*

*sessions of justices of the peace*, in *Scotland*, meetings of the justices of the peace, which take place four times in the year at the county town, namely, on the first Tuesdays of May, August, and March, and the last Tuesday of October. At these quarterly courts the justices have power to review the sentences pronounced at the occasional meetings of justices called special or petty sessions, when the sentence is of a nature subject to review.—*Quarter-staff*, a long staff borne by foresters and park-keepers, as a badge of office and a weapon.—2. A staff of defence, so called from the manner of using it,



Playing at Quarter Staff.

one hand being placed in the middle, and the other equally between the middle and end.—*Head quarters*, the tent or mansion of the commander-in-chief of an army. [See HEAD-QUARTERS.]

—21. The part of a shoe forming the side from the heel to the vamp. **QUARTER, v. t.** To divide into four equal parts.—2. To divide; to separate into parts.—3. To divide into distinct regions or compartments.—4. To station soldiers for lodging; as, to *quarter* troops in the city, or on the inhabitants.—5. To lodge; to fix on a temporary dwelling.—6.† To diet.—7. To bear as an appendage to the hereditary arms.—*To quarter arms.* See QUARTERING.

**QUARTER, v. i.** To lodge; to have a temporary residence.

**QUARTERAGE, n.** A quarterly allowance.

**QUARTER-CLEFT ROD, n.** A rod cleft at one end, the cleft extending to one-fourth of its length. It is also called a *brochen ligger*,—which see.

**QUARTER-DAY, n.** The day that completes three months, the *quarter* of a year; the day when quarterly payments are made of rent or interest.

**QUARTERED, pp.** Divided into four equal parts or quarters; separated into distinct parts; lodged; stationed for lodging. In *her.*, a term sometimes applied to the cross when voided in the centre; as, a cross *quartered*.



A Cross quartered.

3 T

**QUARTER GRAIN**, *n.* In *arch.*, that position of splitting timber, which is cloven in the direction of the annular plates or rings. When timber is cloven in a direction transverse to the annular plates, or towards the centre, this position is termed the *felt grain*.

**QUARTERING**, *ppr.* Dividing into quarters or into distinct parts; stationing for lodgings. *Quartering* is said of a ship when sailing at large so that she neither goes by the wind, nor before the wind, but directly between both.

**QUARTERING**, *n.* A station.—2. Assignment of quarters for soldiers.—3. In *her.*, the marshalling or disposal

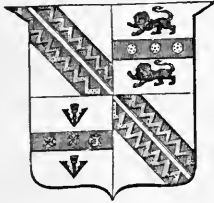

Quarterings, Arms quartered.

of various coats of arms in one shield, thereby to denote the several alliances of one family, with the heiresses of others. When more than three other arms are to be quartered with those of the family, it is usual to divide the shield into a suitable number of compartments; and still the arms are said to be *quartered*.—4. In *arch.*, forming a partition with quarters; applied also to the quarters themselves.—5. In *gunnery*, a term applied when a piece of ordnance is so traversed that it will shoot on the same line, or on the same point of the compass, whereon the ship's quarter has its bearing.

**QUARTERLY**, *a.* Containing or consisting of a fourth part; as, *quarterly seasons*.—2. Recurring at the end of each quarter of the year; as, *quarterly payments of rent*; a *quarterly visitation* or examination.

**QUARTERLY**, *adv.* Once in a quarter of a year. The returns are made *quarterly*. In *her.*, the term used for the field when divided into four equal parts.—*Quarterly pierced*, perforated of a square form in a saltier, cross, moline, &c., through which aperture the field is seen.

**QUARTERN**, *n.* The fourth part of a pint; a gill.

**QUARTEROONS**, or **QUADROONS**, *n.* The name given in America to the descendants of a mulatto and a white; the descendants of a quarteroon and a white are called *quateroons*.

**QUARTER PACE**, *n.* In *arch.*, the name given to the foot-pace of a staircase, when it occurs at the angle-turns of the stairs.

**QUARTER PARTITION**, *n.* In *arch.*, a partition consisting of quarters.

**QUARTERS**, *n.* In *carpentry*, the common posts used in forming a wooden partition, and to which the laths are nailed. Also a name sometimes given to any small scantlings of timber. *Quarters* are also termed *studs*, and in Scotland, *standards*.

**QUARTETT**, } *n.* [It.] A piece of **QUARTETTO**, } music arranged for four voices or four instruments.—2. In *poetry*, a stanza of four lines.

**QUARTILE**, or **QUARTILE ASPECT**, *n.* An aspect of the planets, when they are distant from each other a quarter of the circle, or when their longitudes differ by ninety degrees. [See **ASPECT**.]

**QUARTINE**, *n.* In *bot.*, the fourth integument of the nucleus of a seed, reckoning the outermost as the first. It is only occasionally that there are more than two integuments.

**QUARTO**, *n.* [L. *quartus*.] A book of the size of the fourth of a sheet; a size made by twice folding a sheet, which then makes four leaves. It is abbreviated thus, *4to*.

**QUARTO**, *a.* Denoting the size of a book, in which a sheet makes four leaves.

**QUARTZ**, *n.* [G. *quarz*; Fr. *quartz*.] The name given by mineralogists to numerous varieties of rock crystal, the native oxides of silicium, called also silicious or flint earth, and silicic acid. Quartz is most comprehensive in its varieties. It occurs both crystallized and massive, and in both states is most abundantly diffused throughout nature, and is especially one of the constituents of granite and the older rocks. It generally occurs in hexagonal prisms, terminated by hexagonal pyramids. It scratches glass readily, gives fire with steel, becomes positively electrical by friction, and two pieces when rubbed together become luminous in the dark. The colours are various, as white, gray, reddish, yellowish or brownish, purple, blue, green. Horn stone, amethyst, siderite, agate, aventurine, flint, opal, chalcedony, onyx, sardonyx, and jasper are varieties.

**QUARTZ OZE**, **QUARTZ OSE**, or **QUARTZ OUS**, *a.* Containing quartz; composed of quartz; resembling quartz, or having the properties of quartz.

**QUARTZ Y**, *a.* Pertaining to quartz; partaking of the nature or qualities of quartz; resembling quartz. [*Quartz* is the regular adjective, and *quartzose* and *quartzous* may be dispensed with.]

**QUAS**, *n.* In *Russia*, a drink of common domestic use; being a liquor prepared from pollard, meal, and bread, or from meal and malt, by an acid fermentation.

**QUASH**, *v. t.* [Sax. *cwysan*; G. *quetschen*; Fr. *casser*; L. *quasso*, *quatio*. See **SQUEEZE**.] 1. Properly, to beat down or beat in pieces; to crush.

The wholes Against sharp rocks, like reeling vessels *quash'd*. *Wall-r.*

2. To crush; to subdue; as, to *quash* a rebellion.—3. In *law*, to abate, annul, overthrow, or make void for insufficiency, or for other cause; as, to *quash* an indictment. He prays judgment of the writ or declaration that the same may be *quashed*.

**QUASH**, *v. i.* To be shaken with a noise; to make the noise of water when pressed or shaken.

**QUASH**, *n.* A species of cucurbita; so called probably from its softness. [See the verb.] In *America* it is called a *squash*.

**QUASH'ED**, *pp.* Crushed; subdued; abated.

**QUASH'ING**, *ppr.* Crushing; subduing; abating.

**QUASH'ING**, *n.* In *law*, the annulling or overthrowing of any thing on account of informality or irregularity; as, the *quashing* of an indictment.

**QUASI**, as if. This Latin word is

sometimes used before English words to express resemblance; as, *quasi-argument*, that which resembles or is used as an argument.

**QUASI CONTRACT**, *n.* In *law*, an implied contract; an act which has not the strict form of a contract, but yet has the force of one, as when one employs a person to do any business for him or perform any work, the law implies that the former undertook or contracted to pay as much as the labour of the latter deserves. In *Scots law*, a *quasi contract* is said to differ from a proper contract in this, that it is not constituted by express consent, but *ex re*; that is, by one of the parties doing deeds which import an obligation on him in favour of the other party, or *vice versa*. Thus, a person contracts a *quasi contract*, which infers an obligation to account, by entering on office of tutory; from serving heir; from *negotiorum gestio*; *jactus mercium*, and the like.

**QUASI DELICT**, *n.* In *Scots law*, a term applied to that degree of culpable negligence amounting almost to crime, and inferring an obligation to repair the injury, although there may be no ground for a criminal prosecution.

**QUASIMODO SUNDAY**. In the *Roman catholic calendar*, the first Sunday after Easter; so called because the *Introit* for that day begins with the words "*Quasi modo, geniti infantem*."

**QUASSATION**, *n.* [L. *quassatio*.] The act of shaking; concussion; the state of being shaken.

**QUASSIA**, *n.* [A name formed in remembrance of a negro named Quassy, who first made known the medicinal virtues of one of the species.] A genus of South American tropical plants, consisting of trees; nat. order Simarubaceae. The wood of two species is known in commerce by the name of *Quassia*; *Q. amara*, a native of Suri-



Quassia amara.

nam; and *Q. excelsa* (*Picranea excelsa*, Lindley), a native of Jamaica. Both kinds are imported in billets, and are inodorous, but intensely bitter, especially the Jamaica Quassia. The active principle has been termed *quassite*, a neutral body readily soluble in alcohol. Quassia is a pure and simple bitter, possessing marked tonic properties, and hence useful in debility, particularly of the stomach and muscular system. It is generally given in the form of infusion. An infusion of quassia sweetened with sugar is useful to destroy flies. The wood of *Q. excelsa* is employed by fraudulent brewers in adulterating beer.

QUAT, † *n.* A pustule or pimple.

QUATER. A Latin adverb signifying four times, and employed as a prefix in the following words.

QUATER-COUSINS, *n.* [ka'ter-cuzns.] [L. *quator*, four, and *cousin*.] Those within the first four degrees of kindred.

QUATERFOIL. See QUATREFOIL.

QUATERN, *a.* [L. *quaterni*, four, from *quator*, four.] Consisting of four; fourfold; growing by fours; as, *quatern* leaves.

QUATERNARY, *n.* [L. *quaternarius*, from *quator*, four.] The number four.

QUATERNARY, *a.* Consisting of four.—2. In *geol.*, a term applied to the upper tertiary strata. The faluns and marls of Touraine and the Loire are *quaternary* formations.

QUATERNATE, *a.* Consisting of four.—*Quaternate leaf*, one that consists of four leaflets.

QUATERNION, *n.* [L. *quaternio*, from *quator*, four.] 1. The number four.—2. A file of four soldiers; Acts xii.

QUATERNION, *v. t.* To divide into files or companies.

QUATERNITY, *n.* [supra.] The number four.

QUATERON. See QUADROON.

QUATRIN, *n.* [Fr. from *quatre*, L. *quator*, four.] A stanza of four lines rhyming alternately.

QUATREFOIL, *n.* [Fr. *Quatre-feuille*.] In *arch.*, cross-quarter. A piercing or panel divided by cusps or foliations into four leaves, or more correctly the leaf-shaped figure formed by the cusps. It is an ornament representing the four leaves of a cruciform flower, frequently



Quatrefoils.

used as a decoration in a hollow moulding in the Early English and Decorated styles, but which it has been proposed to distinguish by the term *quatrelobe*.—In *her.*, four-leaved grass; a frequent bearing in coat armour.

QUAVE, for *Quaver*, is not used.

QUAVEMIRE, for *Quagmire*, is not used.

QUA'VER, *v. i.* [W. *cwibiau*, to quaver, to trill; Sp. *quiebro*, a musical shake or trill; *quiebra*, a break, fracture, failure. It coincides in elements with *quibble*, *quiver*, *whiffle*, *wabble*. The primary sense is to move; hence to break, applied to motion and sound. See *QUIVER* and *VIBRATE*.] 1. To shake the voice; to utter or form sound with rapid vibrations, as in singing; to sing with tremulous modulations of voice; to produce a shake on a musical instrument.—2. To tremble; to vibrate. The finger...moved with a *quavering* motion.

Newton.

QUA'VER, *n.* A shake or rapid vibration of the voice, or a shake on an instrument of music.—2. A note and measure of time in music, equal to half a crotchet or the eighth of a semibreve.



Quaver.

QUA'VERED, *a.* or *pp.* Distributed into quavers.

QUA'VERER, *n.* One that quavers; a warbler.

QUA'VERING, *ppr.* Shaking the voice or the sound of an instrument.

QUA'VERING, *n.* The act of shaking the voice, or of making rapid vibrations of sound on an instrument of music.

QUAY, *n.* (ke.) [Fr. *quai*; Arm. *qae*; Ir. *ceigh*. If this word is radically the same as *key*, the sense is that which fastens or secures.] A bank or wharf formed towards the sea or on the side of a river, and paved, for free passage, or securing vessels and receiving goods unladen or to be shipped on board.

QUAY, *v. t.* To furnish with quays.

QUAY'AGE, *n.* Duty paid for repairing a quay, or for the use of a quay.

QUEACH, † *n.* A thick bushy plot.

QUEACH, † *v. i.* To stir; to move. [See *QUICK*.]

QUEACHY, *a.* [from *queach*.] Shaking; moving, yielding, or trembling under the feet, as moist or boggy ground.

The *queachy* fens. *Drayton.*  
Godwin's *queachy* sands. *Ib.*

[If the word is from the root of *quick*, we recognize the application of it in *quicksand*.]—2. † Thick; bushy.

QUEAN, *n.* [Sax. *cwæn*, or *cwen*, a woman. See *QUEEN*.] A worthless woman; a slut; a strumpet. [Not in common use.]

In *Scotch*, this word is often used in familiar style to signify a young woman without any intentional disrespect; as a sturdy *quean*; a thriving *quean*. When it bears a bad sense it is usually accompanied by some epithet which determines its application; as a *worthless quean*.

QUEASINESS, *n.* (s as z.) [from *queasy*.] Nausea; qualmishness; inclination to vomit.

QUEASY, *a.* (s as z.) [allied perhaps to the W. *chudy*, Corn. *huedzha*, Arm. *chueda* or *huyda*, to vomit.] 1. Sick at the stomach; affected with nausea; inclined to vomit.—2. Fastidious; squeamish; delicate.—3. Causing nausea; as, a *queasy* question.

QUECK, † *v. i.* [G. *quackeln*, to quake, to be unsettled; to flinch.] To shrink; to flinch.

QUEEN, *n.* [Sax. *cwæn*, or *cwen*, Goth. *queins*, *quens*, Sw. *quinna*, a woman; Sans. *kanya*. Qu. Ir. *coinne* and Gr. *quinn*.] 1. The consort of a king.—2. A woman who is the sovereign of a kingdom, entitled *queen regnant*, or *queen regent*. She has, in Great Britain, the same power, prerogatives, &c., as a king.—*Queen consort*, the wife of a king.—*Queen dowager*, the widow of a deceased king.—*Queen mother*, a queen dowager who is also mother of the reigning sovereign.—3. The sovereign of a swarm of bees, or the female of the hive.

A hive of bees cannot subsist without a *queen*. *Encyc.*  
4. Figuratively, a female who is chief or pre-eminent among others; one who presides; as *queen* of beauty; *queen* of love.—5. A card on which a queen is depicted.—6. One of the pieces at chess.—*Queen of the meadows*, meadow-sweet, a plant of the genus *Spiræa*, the *S. ulmaria*, Linn.

QUEEN, *v. i.* To play the queen; to act the part or character of a queen.

QUEEN BEE, *n.* The sovereign of a swarm of bees, the only fully developed female insect in the hive; all the other inhabitants being either males or drones and neuters. [See *BEE*.] The queen is the parent of the hive; and her sole occupation consists in laying the eggs from which the young bees are pro-

duced. Her fertility is so great that in the height of the season she lays 200 eggs per day, and even more when the



Queen Bee.

season is particularly warm and genial and flowers are abundant.

QUEEN'S BENCH. See *KING'S BENCH*.

QUEEN-CLOSER, *n.* In *bricklaying*, a quarter brick or bat interposed near the angles, in order to break the vertical joints, and preserve the continuity of the bond in the heading course. A similar preservation of the bond may be obtained by inserting a three quarter bat at the angle in the stretching course; this is called a *king-closer*.

QUEEN-DOW'AGER, *n.* The widow of a king.

QUEEN-GOLD, *n.* A royal duty or revenue once belonging to every queen of England during her marriage to the king.

QUEENLIKE, *a.* Resembling a queen.

QUEENLY, *a.* Like a queen; becoming a queen; suitable to a queen.

QUEEN POST, *n.* In *arch.*, the suspending posts in the framed principal of a roof, or in a trussed partition, or

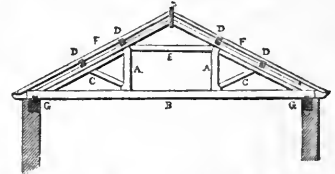

A, A, Queen posts. E, Collar beams.  
B, Tie beam. F, Common rafters.  
C, Struts or Braces. G, G, Wall plates.  
D, Furlins. H, Ridge piece.

other truss where there are two. When there is only one post it is called a king post or crown post.

QUEEN'S YELLOW, *n.* An ancient name of Turbith mineral.

QUEENS, *n.* In *slating*, slates three feet long and two feet wide.

QUEER, *a.* [G. *quer*, cross, oblique, traverse; *querkopf*, a *queer* fellow; *querlen*, to twirl. The primary sense is probably to turn.] Odd; singular; hence, whimsical.

QUEERLY, *adv.* In an odd or singular manner.

QUEERNESS, *n.* Oddity; singularity; particularity. [Thus, and the two foregoing words, are familiar but not elegant.]

QUEEST, *n.* A ring dove, a species of pigeon.

QUEINT, † *pret.* and *pp.* of *Quench*.

QUELL, *v. t.* [Sax. *cwellan*, to kill; Dan. *quæler*, to stifle, suffocate, choke, stop, quell, gall, tease, torment, vex; Sw. *quälja*, id.; G. *quälen*. The primary sense is to stop, to press or force down, and thus cause action or motion to cease.] 1. To crush; to subdue; to cause to cease; as, to *quell* an insurrection or sedition.—2. To quiet; to allay; to reduce to peace; as, to *quell* the tumult of the soul.—3. To subdue; to reduce.

QUELL, v. i. To die; to abate.  
 QUELL, † n. Murder.  
 QUELL'ED, pp. Crushed; subdued; quieted.  
 QUELL'ER, n. One that crushes or subdues.  
 QUELL'ING, ppr. Crushing; subduing; reducing to peace.  
 QUELQUE-CHOSE, n. (keck-shows.) [Fr. something.] A trifle; a kickshaw.  
 QUEME, † v. t. [Sax. *cweman*] To please.  
 QUENCH, v. t. [Sax. *cwencan*.] 1. To extinguish; to put out; as, to quench flame.—2. To still; to quiet; to repress; as, to quench a passion or emotion.—3. To allay or extinguish; as, to quench thirst.—4. To destroy.—5. To check; to stifle; as, to quench the Spirit; 1 Thess. v.  
 QUENCH, v. i. To cool; to become cool. Dost thou think, in time She will not quench? † Shak.  
 QUENCH'ABLE, a. That may be quenched or extinguished.  
 QUENCH'ED, pp. Extinguished; allayed; repressed.  
 QUENCH'ER, n. He or that which extinguishes.  
 QUENCH'ING, ppr. Extinguishing; quieting; stifling; repressing.  
 QUENCH'LESS, a. That cannot be quenched or repressed; inextinguishable; as, quenchless fire or fury.  
 QUENCH'LESSLY, adv. In a quenchless manner.  
 QUENCH'LESSNESS, n. State of being quenchless.  
 QUER'CITRON, n. [L. *quercus*, an oak, and *citrina*, lemon-coloured.] 1. The *Quercus nigra*, black oak, or *dyer's oak*, which grows from Canada to Georgia, and west to the Mississippi. It frequently attains the height of seventy or eighty feet, and is one of the largest trees of the American forests.—2. The bark of the *Quercus nigra*, or American oak; it is a highly valuable dye-stuff, and is used in the production of some of the most durable yellows. It was first brought before the public by Dr. Bancroft. Although this oak affords a yellow colour, yet it is not the yellow oak, that name being commonly applied to *Quercus Castanea*.  
 QUER'CUS, n. [L.] The most important genus of trees found in the cold countries of the world, on account of its producing the various kinds of timber called oak. [See OAK.]  
 QUER'ELE, or QUERE'LA, † n. [L. *querela*; Fr. *querelle*.] A complaint to a court. [See AUDITA QUERELA.]  
 QUER'ENT, † n. [L. *querens*, *queror*, to complain.] The complainant; the plaintiff.  
 QUER'ENT, n. [L. *querens*, *quero*, to inquire.] An inquirer. [Not *mu. us.*]  
 QUERIMONIOUS, a. [L. *querimonia*, complaint, from *queror*.] Complaining; querulous; apt to complain.  
 QUERIMONIOUSLY, adv. With complaint; querulously.  
 QUERIMONIOUSNESS, n. Disposition to complain; a complaining temper.  
 QUER'IST, n. [from L. *quero*, to inquire.] One who inquires or asks questions.  
 QUERK. See QUIRK.  
 QUERK'ENED, † a. Choked.  
 QUERL, v. t. [G. *querlen*.] To twirl; to turn or wind round; to coil; as, to querl a cord, thread, or rope. [An American term.]  
 QUERN, n. [Sax. *cwyrn*, *cwern*; Goth.

*quairn*. Qu. W. *cwyrn*, a quick motion, a whirl.] A hand-mill for grinding grain; a mill, the stone of which



Grinding with the Quern.

was turned by hand, used before the invention of windmills and watermills.  
 QUERP'O, n. [Sp. *cuerpo*, the body, L. *corpus*; Sp. *en cuerpo de camisa*, half dressed, having on a shirt only.] A waistcoat or garment close to the body.  
 QUER'QUEDULE, n. [L. *querquedula*.] An aquatic fowl, a species of teal of the genus *Anas*.  
 QUER'RY, n. A groom. [See EQUERRY.]  
 QUER'ULOUS, a. [L. *querulus*, from *queror*, to complain. See QUARREL.] 1. Complaining, or habitually complaining; disposed to murmur; as, a querulous man or people.—2. Expressing complaint; as, a querulous tone of voice.  
 QUER'ULOUSLY, adv. In a complaining manner.  
 QUER'ULOUSNESS, n. Disposition to complain, or the habit or practice of murmuring.  
 QUER'RY, n. [from L. *quere*, imperative of *quero*; perhaps Ch. and Heb. *קָרַר*, *chakar*, to seek, to search, to inquire; *קָרַר*, *kakar*, id.; Ar. *karau*, to follow, to seek. The sense is to press on, to follow, to urge.] A question; an inquiry to be answered or resolved. Abbreviated into *Qy.* or *Qu.*  
 I will conclude by proposing some queries. Newton.  
 QUERY, v. i. To ask a question or questions. Three Cambridge sophs .. Each prompt to query, answer, and debate. Pope.  
 2. To express doubts.  
 QUERY, v. t. To seek; to inquire; as, query the sum or amount; query the motive or the fact.—2. To examine by questions.—3. To doubt of.—4. To mark with a query.  
 QUEST, n. [Fr. *quête*, for *queste*; L. *quero*, *quæstus*. As the letter *r* is rarely changed into *s*, perhaps the L. *quesivi*, *quæstus*, may be from the root of *quæso*, W. *ceisaw*, to seek, to endeavour, *cais*, effort.] 1. The act of seeking; search; as, to rove in quest of game; to go in quest of a lost child; in quest of property, &c.—2. † Inquest; a jury.—3. † Searchers, collectively.—4. † Inquiry; examination.—5. Request; desire; solicitation. Gad not abroad, at every quest and call Of an untrain'd hope or passion. Herbert.  
 QUEST, † v. i. To go in search.  
 QUEST, v. t. To search or seek for.  
 QUEST'ANT, † n. [supra.] A seeker.

QUESTION, n. (ques'chun.) [Fr. and Sp. *question*; L. *questio*. See QUEST.] 1. The act of asking; an interrogatory; as, to examine by question and answer.—2. That which is asked; something proposed which is to be solved by answer. What is the question?—3. Inquiry; disquisition; discussion. It is to be put to question, whether it is lawful for Christian princes to make an invasive war, simply for the propagation of the faith. Bacon.  
 4. Dispute or subject of debate. There arose a question between some of John's disciples and the Jews, about purifying; John iii.  
 5. Doubt; controversy; dispute. The story is true beyond all question. This does not bring their truth in question. Locke.  
 6. Trial; examination; judicial trial or inquiry. Of the hope and resurrection of the dead I am called in question; Acts xxiii. xxiv.  
 7. Examination by torture, or the application of torture to prisoners under criminal accusation in order to extort confession. This species of examination has long since been abolished in this country.—8. † Endeavour; effort; act of seeking.—9. In logic, a proposition stated by way of interrogation.—In question, in debate; in the course of examination or discussion; as, the matter or point in question.  
 QUESTION, v. i. To ask a question or questions; to inquire by interrogatory or proposition to be answered. He that questioneth much, shall learn much. Bacon.  
 2. To debate by interrogatories.  
 QUESTION, v. t. To inquire of by asking questions; to examine by interrogatories; as, to question a witness.—2. To doubt of; to be uncertain of. And most we question what we most desire. Prior.  
 3. To have no confidence in; to treat as doubtful. If a man is frustrated in his designs, his prudence is questioned.  
 QUESTIONABLE, a. That may be questioned; doubtful; uncertain; disputable. The deed is of questionable authority. It is questionable whether Galen ever saw the dissection of a human body. Baker.  
 2. Suspicious; liable to be doubted or disputed; liable to suspicion. His veracity is questionable. Thou com'st in such a questionable shape, That I will speak to thee. Shak.  
 QUESTIONABLENESS, n. The quality or state of being doubtful, questionable, or suspicious.  
 QUESTIONARY, a. Inquiring; asking questions; as, questionary epistles.  
 QUESTIONED, pp. Interrogated; examined by questions.—2. Doubted; disputed.  
 QUESTIONER, n. One that asks questions; an inquirer.  
 QUESTIONING, ppr. Interrogating; calling in question; doubting.  
 QUESTIONIST, n. A questioner; an inquirer.—2. A candidate for a bachelor's degree at Cambridge.  
 QUESTIONLESS, adv. Beyond a question or doubt; doubtless; certainly.  
 QUEST'MAN, † n. In law, a person chosen to inquire into abuses and misdemeanours, especially such as relate to weights and measures; specially a church-warden.  
 QUESTMONGER, n. One who de-

lights in judicial quests; a starter of law-suits.

**QUESTOR**, *n.* [L. *questor*. See **QUEST** and **QUERY**.] In *Roman antiquity*, an officer who had the management of the public treasure; the receiver of taxes, tribute, &c.

**QUESTORSHIP**, *n.* The office of a questor or Roman treasurer.—2. The term of a questor's office.

**QUESTRIST**, *† n.* A seeker; a pursuer.

**QUESTUARY**, *a.* Studious of profit.

**QUESTUARY**, *n.* One employed to collect profits.

**QUESTUS**, *n.* [L.] In law, land which does not descend by hereditary right, but is acquired by one's own labour and industry.

**QUEUE**, *n.* [Fr. *tail*.] In *her.*, the tail of a beast.—2. The tie of a wig. [See **CUE**.]

**QUEY**, } *n.* [Dan. *quic*; Suio Goth. *quiga*, a young cow

**QUOY**, } which has not yet

**QUE'OCK**, } brought forth young.]

**QUOYA'ACH**, } A young cow or heifer; a cow of two years old. [Scotch.]

**QUA EMPTORES**, *n.* [L.] The English statute, Westm. 3, 18 Ed. 1, St. 1, so named from the introductory words. Its intention was to put a stop to infendations, by declaring that a vassal might sell his lands, provided he sold them to be held of his superior by the tenure and services due.

**QUIB**, *n.* [W. *cwip*, a flirt; a quirk, or *quib*, a quick course or turn; *quiwaw*, to move quickly, to whip; as we say, he *whipped* round the corner.] A sarcasm; a bitter taunt; a quip; a gibe.

**QUIBBLE**, *n.* [It seems to be from the root of *quib*, supra, W. *quiwaw*, to turn or move rapidly, or *quiwaw*, to wander. See **WABBLE**.] 1. A start or turn from the point in question, or from plain truth; an evasion; a cavil; a pretence; as, to answer a sound argument by *quibbles*.

Quirks and quibbles have no place in the search after truth. *Watts*.

2. A pun; a low conceit.

**QUIBBLE**, *v. i.* To evade the point in question, or plain truth, by artifice, play upon words, cavilling, or any conceit; to trifle in argument or discourse.—2. To pun.

**QUIBBLER**, *n.* One who evades plain truth by trifling artifices, play upon words, or cavils.—2. A punster.

**QUIBBLING**, *ppr.* Evading the truth by artifice or play upon words; punning.

**QUICK**, *† v. i.* [Sax. *cwic*, alive; *cwic-cian*, to vivify.] To stir; to move.

**QUICK**, *a.* [Sax. *cwic*, living, alive; G. *quick*; Qu. W. *cig*, Arm. *qicq*, flesh. If *q* is a dialectical prefix, as supposed, this word coincides with the L. *vigeo*, *vegeo*, and *vig*, *veg*, radical, coincide with *wag*. Now the Dutch call a wag-tail, *hwijsstaart*.] 1. Primarily, alive; living; opposed to *dead* or *unanimated*; as, *quick* flesh; Lev. xiii.

The Lord Jesus Christ, who shall judge the *quick* and the *dead*; 2 Tim. iv.

[In this sense, the word is obsolete, except in some compounds or in particular phrases.] 2. Swift; hasty; done with celerity; as *quick* dispatch.—3. Speedy; done or occurring in a short time; as, a *quick* return of profits.

Off he to her his charge of *quick* return Repeated. *Milton*.

4. Active; brisk; nimble; prompt; ready. He is remarkably *quick* in his

motions. He is a man of *quick* parts. 5. Moving with rapidity or celerity; as, *quick* time in music.—*Quick with child*, pregnant with a living child.

**QUICK**, *adv.* Nimbly; with celerity; rapidly; with haste; speedily; without delay; as, run *quick*; be *quick*.

If we consider how very *quick* the actions of the mind are performed. *Locke*. 2. Soon; in a short time; without delay. Go and return *quick*.

**QUICK**, *n.* [Sw. *qviga*, a heifer; Dan. *qvæg*, cattle; that is, living.] 1 $\frac{1}{2}$ . A living animal.—2. The living flesh; sensible parts; as, penetrating to the *quick*; stung to the *quick*; cut to the *quick*.—3. A live fence or hedge formed of some growing plant, usually hawthorn.

**QUICK**, *† v. t.* [Sax. *cwiccian*.] To revive; to make alive.

**QUICK**, *† v. i.* To become alive.

**QUICK'-BEAM**, } *n.* A plant of the

**QUICK'-EN-TREE**, } genus *pyrus* or

*sorbus*, the *P. aucuparia*, or *S. aucuparia*, belonging to the nat. order Rosaceæ; known also by the names of service-tree, mountain ash, or roan or rowan tree. [See **MOUNTAIN ASH**.]

**QUICKEN**, *v. t.* (*quik' n.*) [Sax. *cwic-cian*; Dan. *qvæger*.] 1. Primarily, to make alive; to vivify; to revive or resuscitate, as from death or an inanimate state; Rom. iv.

Hence flocks and herds, and men and beasts and fowls,

With breath are *quicken'd*, and attract their souls. *Dryden*.

2. To make alive in a spiritual sense; to communicate a principle of grace to.

You hath he *quicken'd*, who were dead in trespasses and sins; Eph. ii.

3. To hasten; to accelerate; as, to *quicken* motion, speed, or flight.—4. To sharpen; to give keener perception to; to stimulate; to incite; as, to *quicken* the appetite or taste; to *quicken* desires.—5. To revive; to cheer; to reinvigorate; to refresh by new supplies of comfort or grace; Ps. cxix.

**QUICKEN**, *v. i.* (*quik' n.*) To become alive.

The heart is the first part that *quickeneth*, and the last that dies. *Ray*.

2. To move with rapidity or activity. And keener lightning *quickeneth* in her eye. *Pope*.

3. To be in that state of pregnancy in which the child acquires life.

**QUICK'ENED**, *pp.* Made alive; revived; vivified; reinvigorated.—2. Accelerated; hastened.—3. Stimulated; incited.

**QUICK'ENER**, *n.* One who revives, vivifies, or communicates life.—2. That which reinvigorates.—3. That which accelerates motion or increases activity.

**QUICK'ENING**, *ppr.* Giving life; accelerating; inciting.

**QUICK'ENING**, *a.* Giving new life and vigour; animating; as, the *quicken-ing* influences of the Spirit.

**QUICK'-EYED**, *a.* Having acute sight; of keen and ready perception.

**QUICK'-GRASS**. See **QUITCH-GRASS**.

**QUICK'-HEDGE**, or **QUICK**, *n.* A live fence or hedge formed of some growing plant, as hawthorn.

**QUICK'LIME**, *n.* [See **LIME**.] The protoxide of calcium. Any carbonate of lime deprived of its carbonic acid, becomes quicklime; as, chalk, limestone, oyster shells, &c. These calcareous stones and shells are reduced to

quicklime by being subjected for a considerable time to intense heat, which expels the carbonic acid, the aqueous, and the animal matter.

**QUICK'LY**, *adv.* Speedily; with haste or celerity.—2. Soon; without delay.

**QUICK'-MATCH**, *n.* [See **MATCH**.] A combustible preparation formed of cotton strands dipped in a boiling composition of white vinegar, saltpetre, and mealed gunpowder, used by artillerymen.

**QUICK'NESS**, *n.* Speed; velocity; celerity; rapidity; as, the *quickness* of motion.—2. Activity; briskness; promptness; as, the *quickness* of the imagination or wit.—3. Acuteness of perception; keen sensibility; as, *quickness* of sensation.—4. Sharpness; pungency.

**QUICK'SAND**, *n.* Sand easily moved or readily yielding to pressure; loose sand abounding with water.—Unsolid ground.

**QUICK'SCENTED**, *a.* Having an acute perception by the nose; of an acute smell.

**QUICK'SET**, *n.* A living plant set to grow, particularly for a hedge.—*Quickset hedge*, a hedge formed of sets of plants that are quick, that is, alive.

**QUICK'SET**, *v. t.* To plant with living shrubs or trees for a hedge or fence; as, to *quickset* a ditch.

**QUICK'SETTED**, *pp.* Planted with living shrubs.

**QUICK-SIGHTED**, *a.* Having quick sight or acute discernment; quick to see or discern.

**QUICK-SIGHTEDNESS**, *n.* Quickness of sight or discernment; readiness to see or discern.

**QUICK'SILVER**, *n.* [that is, living silver, *argentum vivum*, so called from its fluidity.] Mercury, a metal found both native and in the state of ore in mines, in various parts of the world, and so remarkably fusible as to be congealable only with the intense cold indicated by 39° or 40° below zero, on Fahrenheit's thermometer. It is the heaviest of the metals, next to platinum, gold, and tungsten. It is used in various arts and in medicine. [See **MERCURY**.]

**QUICK'SILVERED**, *a.* Overlaid with quicksilver.

**QUICK'-WITTED**, *a.* Having ready wit.

**QUICK'-WITTEDNESS**, *n.* Readiness of wit.

**QUID**. A Latin word signifying why or what.

**QUID PRO QUO**. [L.] In law, the giving of one thing of equal value for another; an equivalent. Also the mutual consideration and performance of both parties to a contract. [See **QUI PRO QUO**.]

**QUID**, *n.* A vulgar pronunciation of *quid*; as, a *quid* of tobacco.

**QUID'DAM**, *† n.* [L.] Somebody.

**QUID'DANY**, *n.* [G. *quitte*, a quince; L. *cydonium*.] Marmalade; a confection of quinces prepared with sugar.

**QUID'DATIVE**, *a.* Constituting the essence of a thing.

**QUID'DIT**, *† n.* [L. *quidlibet*, or Fr. *que dit*.] A subtily; an equivocation.

**QUID'DITY**, *n.* [L. *quid*, what.] 1. A barbarous term used in school philosophy for *essence*, that unknown and undefinable something which constitutes its peculiar nature, or answers the question, *quid est?* The essence

of a thing constitutes it *tale quid*, such a thing as it is, and not another.—2. A trifling nicety; a cavil; a captious question.

**QUID'DLE**, *v. i.* [*L. quid*, what.] To spend or waste time in trifling employments, or to attend to useful subjects in a trifling superficial manner.

**QUID'DLER**, *n.* One who spends time in trifling niceties.

**QUID'DLING**, *ppr.* Spending time in trifling employments.

**QUID'DLING**, *n.* The spending of time in trifling employments.

**QUID'NUNC**, *n.* [*L. what now*.] One who is curious to know every thing that passes, and is continually asking "What now?" or "What news?" one who knows or pretends to know all occurrences; a news gossiper.

**QUIESCE**, *v. i.* (*quiesc.*) [*L. quiesco*.] To be silent, as a letter; to have no sound.

**QUIES'CENCE**, *n.* [*L. quiescens, quiescency*.] *esco.* See **QUIET**.

1. Rest; repose; state of a thing without motion.—2. Rest of the mind; a state of the mind free from agitation or emotion.—3. Silence; the having no sound; as of a letter.

**QUIES'CENT**, *a.* [*L. quiescens*.] 1. Resting; being in a state of repose; still; not moving; as, a *quiescent* body or fluid.—2. Not ruffled with passion; unagitated; as the mind.—3. Silent; not sounded; having no sound; as, a *quiescent* letter. Sow, mow, have *v quiescent*; say, day, have *y quiescent*.

**QUIES'CENT**, *n.* A silent letter.

**QUI'ET**, *a.* [*Fr. quiet*, *L. quietus*, *It. quieto*, quiet; *quietare*, to pacify, and *quietare*, to quiet, and to acquit, to quit; *Sp. quieto*, quiet; *quietar*, to appease; *quedo*, quiet, and *quedar*, to stop, to leave, to quit; *Port. quieto*, quiet; *queda*, a fall, declivity; *quedo*, quiet. *Quiet* and *quit* seem to belong to one root.] 1. Still; being in a state of rest; not moving; *Judges xvi.*—2. Still; free from alarm or disturbance; unmolested; as, a *quiet* life.

In his days the land was *quiet* ten years; 2 *Chron. xiv.*

3. Peaceable; not turbulent; not giving offence; not exciting controversy, disorder, or trouble; mild; meek; contented.

The ornament of a meek and *quiet* spirit; 1 *Peter iii*; 1 *Thess. iv.*

4. Calm; not agitated by wind; as, a *quiet* sea or atmosphere.—5. Smooth; unruffled.—6. Undisturbed; unmolested; as, the *quiet* possession or enjoyment of an estate.—7. Not crying; not restless; as, a *quiet* child.

**QUI'ET**, *n.* [*L. quies*.] 1. Rest; repose; stillness; the state of a thing not in motion.—2. Tranquillity; freedom from disturbance or alarm; civil or political repose. Our country enjoys *quiet*.—3. Peace; security; *Judg. xviii.*

**QUI'ET**, *v. t.* To stop motion; to still; to reduce to a state of rest; as, to *quiet* corporeal motion.—2. To calm; to appease; to pacify; to lull; to tranquillize; as, to *quiet* the soul when agitated; to *quiet* the passions; to *quiet* the clamours of a nation; to *quiet* the disorders of a city or town.—3. To allay; to suppress; as, to *quiet* pain or grief.

**QUI'ETED**, *ppr.* Made still; calmed; pacified.

**QUI'ETER**, *n.* The person or thing that quiets.

**QUI'ETING**, *ppr.* Reducing to rest or stillness; appeasing; tranquillizing.

**QUI'ETISM**, *n.* Peace or tranquillity of mind; apathy; dispassion; indisturbance; inaction. In history, *quietism* is the system of the quietists, who maintained that religion consists in the internal rest or recollection of the mind; employed in the continual contemplation and love of God, and submission to his will.

**QUI'ETIST**, *n.* One of a sect of mystics, originated by Molinos, a Spanish priest, who maintained the principles of quietism.

**QUI'ETIST'IC**, *a.* Pertaining to a quietist, or to quietism.

**QUI'ETLY**, *adv.* In a quiet state; without motion; in a state of rest; as, to lie or sit *quietly*.—2. Without tumult, alarm, dispute, or disturbance; peaceably; as, to live *quietly*.—3. Calmly; without agitation or violent emotion; patiently. Submit *quietly* to unavoidable evils.

**QUI'ETNESS**, *n.* A state of rest; stillness.—2. Calm; tranquillity; as, the *quietness* of the ocean or atmosphere.—3. Freedom from agitation or emotion; calmness; coolness; as, the *quietness* of the mind.—4. Freedom from disturbance, disorder, or commotion; peace; tranquillity; as, the *quietness* of a city or state.

**QUI'ETSOME**, *† a.* Calm; still; undisturbed.

**QUI'ETUDE**, *n.* [*Fr.*] Rest; repose; quiet; tranquillity.

**QUI'ETUS**, *n.* [*L.*] Rest; repose; death; hence, a final discharge or acquittance; that which silences claims.

**QUILL**, *n.* [*Ir. cuille*, a reed or quill; *Corn. cuilan*; *L. calamus*; *W. calaw*; probably a shoot.] 1. Quills are the large strong feathers of the wings of geese, swans, turkeys, crows, &c.; used much for writing pens. Hence,—2. The instrument of writing; as, the proper subject of his *quill*.—3. The spine or prickle of a porcupine.—4. A piece of small reed or other hollow plant, on which weavers wind the thread which forms the woof of cloth.—5. The instrument with which musicians strike the strings of certain instruments.—*To carry a good quill*, to write well.—*Quill driver*, a trivial name for a lawyer's or merchant's clerk.

**QUILL**, *v. t.* To plait, or to form with small ridges like quills or reeds; as, a woollen stuff *quilled*. [This word is generally, if not universally, pronounced *twilled*.]

**QUIL'LET**, *† n.* [*L. quilibet*, what you please.] Subtlety; nicety; fraudulent distinction; petty cant.

**QUILT**, *n.* [*It. coltre*; *L. culcita*; *Ir. cuilt*, a bed-tick, a bed; *Port.* and *Sp. colcha*, *Sp. colchar*, *acolchar*, to quilt; perhaps from uniting, gathering, or holding.] A cover or garment made by putting wool, cotton, or other substance between two cloths and sewing them together; as, beds covered with magnificent *quilts*.

**QUILT**, *v. t.* To stitch together two pieces of cloth with some soft and warm substance between them; as, a *quilted* bed-cover; a *quilted* coat.—2. To sew in the manner of a quilt.

**QUILT'ED**, *ppr.* Stitched together, as two pieces of cloth, with a soft substance between them.

**QUILT'ING**, *ppr.* Stitching together, as two cloths with some soft substance between them.

**QUILT'ING**, *n.* The act or operation of forming a quilt; the method of sew-

ing two pieces of silk, linen, or stuff, on each other, with wool or cotton between them, by working them all over in the form of chequer or diamond work, or in flowers. The same name is also given to the stuff so worked.—2. In *New England*, the act of quilting by a collection of females who bestow their labour gratuitously to aid a female friend, and conclude with an entertainment.—3. Among seamen, the operation of weaving a sort of coating formed of the strands of rope, about the outside of any vessel to contain water, as a jar, bottle, &c., also the coating so woven.

**QUIN'ARY**, *a.* [*L. quinarus*, from *quinque*, five.] Consisting of five; as, a *quinary* number.

**QUIN'ATE**, *a.* [*from L. quinque*.] *Ir. bot.*, a *quinate* leaf is a sort of digitate leaf having five leaflets on a petiole.

**QUINCE**, *n.* (*quins*.) [*Fr. coin* or *coing*; *Arm. aval-couign*, the cornered apple or wedge-apple; *G. quille* or *quitten-appfel*, which seems to be a different word, and rather allied to the *L. cydonius*.] The fruit of the *Cydonia vulgaris*, nat. order Rosaceæ, so named from *Cydonia*, a town of Crete, famous for abounding with this fruit. The quince tree is now cultivated through-



Quince (*Cydonia vulgaris*).

out Europe, and in many parts of the United States, for its fruit, which, though hard and austere when plucked from the tree, becomes excellent when boiled and eaten with sugar, or preserved in syrup, or made into marmalade. Quinces, when mixed with other fruit, in cookery, communicate a very pleasant flavour.

**QUINCH**, *† v. i.* [probably a vulgar pronunciation of *wince* or *winch*.] To stir, wince, or flounce.

**QUIN'CUN'CIAL**, *a.* [*from L. quincunx*.] Having the form of a *quincunx*.—*Quincuncial* *astivation*, a term applied in *bot.* when there are five petals; two outer, two inner, and one covering the latter by one of its sides.

**QUIN'CUNX**, *n.* [*L.* composed of *quinque*, five, and *uncia*, ounce.] In *gardening*, the *quincunx* order is a plantation of trees disposed in a square, consisting of five trees, one at each corner and a fifth in the middle, thus:— This order, repeated indefinitely, forms a regular grove or wood, which viewed by an angle of the square or parallelogram, presents equal or parallel alleys. In ancient times troops were frequently drawn up in this order.

**QUINDEC'AGON**, *n.* [*L. quinque*, five, *Gr. deka*, and *gonia*, angle.] In *geom.*, a plane figure with fifteen sides and fifteen angles.

**QUINDECIM'VIR**, *n. plur.* *Quinde-*



*cem' viri.* [L. *quinque*, five, *decem*, ten, and *vir*, man.] In *Roman history*, one of a collection or body of fifteen magistrates, whose business was to preside over the sacrifices.

**QUINDECIMVIRATE**, *n.* The body of fifteen magistrates, or their office.

**QUIN'NINA**, **QUIN'IA**, or **QUIN'INE**, *n.* A most important vegetable alkali, contained in the three well known varieties of Cinchona or Peruvian bark, but principally in the yellow bark. [See **CINCHONA**.] It was discovered in 1820 by Pelletier and Caventon, along with Cinchonine. It is colourless, inodorous, and extremely bitter. With acids it forms crystallizable salts, the most important of which is the sulphate, so extensively used in medicine. It is difficultly soluble in water and intensely bitter. It is administered as a tonic and febrifuge in doses of from one to five or six grains.

**QUINQUAGESIMA**, *n.* [L. *fifty*.] *Quinquagesima Sunday*, so called as being about the fiftieth day before Easter; Shrove Sunday.

**QUINQUAN'GULAR**, *a.* [L. *quinque*, five, and *angulus*, angle.] Having five angles or corners; as, a *quinquangular leaf*.

**QUINQUARTICULAR**, *a.* [L. *quinque*, five, and *articulus*, article.] Consisting of five articles. [*Little used*.]

**QUINQUECAPSULAR**, *a.* [L. *quinque*, five, and *capsula*, a little chest.] In *bot.*, having five capsules.

**QUINQUEDENTATE**, *a.* [L. *quinque*, five, and *dentatus*, toothed; *dens*, tooth.] In *bot.*, five-toothed.

**QUINQUEFARIOUS**, *a.* [L. *quinque*, five, and probably *Sax. faran*, to go, Eng. to *fare*, or from the root of *vary*.] In *bot.*, opening into five parts.

**QUINQUERID**, *a.* [L. *quinque*, five, and *findo*, to split.] In *bot.*, five-cleft; cut about half way from the margin to the base into five segments with linear sinuses and straight margins; as a leaf.

**QUINQUEFOLIATED**, *a.* [L. *quinque*, five, and *folium*, leaf.] Having five leaves.

**QUINQUELITERAL**, *a.* [L. *quinque*, five, and *litera*, letter.] Consisting of five letters.

**QUINQUELOBATE**, } *a.* [L. *quinque*,  
**QUINQUELOBED**, } five, and *lobus*,  
lobe.] Five-lobed; divided nearly to the middle, into five distinct parts with convex margins.

**QUINQUELOEULAR**, *a.* [L. *quinque*, five, and *loculus*, a cell.] Five-celled; having five cells; as a pericarp.

**QUINQUENNIAL**, *a.* [L. *quinquennalis*, *quinquennis*; *quinque*, five, and *annus*, year.] Occurring once in five years, or lasting five years.

**QUINQUEPARTITE**, *a.* [L. *quinque*, five, and *partitus*, divided.] 1. Divided into five parts almost to the base.—2. Consisting of five parts.

**QUINQUEREME**, *n.* [L. *quinque*, five, and *remus*, oar.] A galley having five seats or rows of oars, used by the Romans.

**QUINQUEVALVE**, } *a.* [L. *quin-*  
**QUINQUEVALVULAR**, } *que*, five,  
and *valva*, valves.] Having five valves, as a pericarp.

**QUINQUEVIR**, *n.* [L. *quinque*, five, and *vir*, man.] One of an order of five priests in Rome.

**QUINQUINA**, *n.* Peruvian bark. The bark of various species of cinchona.

**QUIN'SY**, *n.* (*s* as *z*.) [corrupted from *Fr. esquinancie*, *squinancie*; *L. cyan-*

*che*; Gr. *κωσάχχ*, an inflammation of the throat.] 1. An inflammation of the tonsils.—2. Any inflammation of the throat, or parts adjacent.

**QUINT**, *n.* [L. *quintus*, fifth, *Fr. quinte*.]

A set or sequence of five; as in piquet.

**QUINTAIN**, *n.* [Fr. *quintaine*.] An ancient tilting block. It consisted of an upright post, on the top of which was a horizontal bar turning on a pivot; on one end of this a sand bag was



An ancient Quintain at Offham, Kent.

placed, on the other a broad board; and it was a trial of skill to strike or tilt at the broad end with a lance, and avoid being struck by the sand bag, which was thus driven round to the assailant's back.

**QUINT'AL**, *n.* [Fr. *quintal*; from the root of *L. centum*, a hundred.] An old denomination of foreign weight. The French ordinary *quintal* was about fifty kilogrammes; the metrical *quintal* (*quintal métrique*) twice that amount. As the *cwt. avoirdupois* is equivalent to 50.78 kilogrammes of France, it follows that the ordinary *quintal* may usually stand for our hundredweight, or thereabouts, viz., 112 lbs.

**QUINTESSENCE**, *n.* [L. *quinta essentia*, fifth essence.] 1. In *alchemy*, the fifth or last and highest essence of power in a natural body. Hence,—2. An extract from any thing, containing its virtues or most essential part in a small quantity.—3. Among the *older chemists*, a term applied to alcoholic tinctures or essences made by digestion at common temperatures, or in the sun's heat.—4. The pure essential part of a thing.

**QUINTESSENTIAL**, *a.* Consisting of quintessence.

**QUINTETT'**, } *n.* [It.] In *music*, a  
**QUINTETTO**, } vocal or instrumental  
composition in five parts, in which each part is obligato, and performed by a single voice or instrument.

**QUINTILE**, *n.* [L. *quintus*, fifth.] The aspect of planets when distant from each other, the fifth part of the zodiac, or seventy-two degrees.

**QUINTILION**, *n.* A number produced by involving a million to the fifth power.

**QUINTIN**. See **QUINTAIN**.

**QUINTINE**, *n.* [L. *quintus*.] A name given, in *bot.*, to the fifth, or innermost envelope of the vegetable ovulum, the most external being the first or primine.

**QUINTUPLE**, *a.* [L. *quintuplus*, fivefold; *quintus* and *plico*.] Fivefold;

containing five times the amount.—2. In *music*, designating a species of time, now seldom used, containing five crotchets in a bar.

**QUINTUPLE**, *v. t.* To make five fold.

**QUINTUPLED**, *pp.* Made five times as many.

**QUINZAINE**, *n.* [Fr.] In *chronol.*, the fourteenth day after a feast day, or the fifteenth, if the day of the feast be included.—2. A stanza consisting of fifteen lines.

**QUIP**, *n.* [W. *quip*, a quick flirt or turn; *quippaw*, to move briskly, to *whip*; as we say, to *whip round* a corner in running.] A smart sarcastic turn; a taunt; a severe retort.

**QUIP**, *v. t.* To taunt; to treat with a sarcastic retort.

**QUIP**, *v. i.* To scoff.

**QUI PRO QUO**, or **QUID PRO QUO**. [L. one for another.] A phrase borrowed from the French, who use it to indicate an error committed by mistaking one thing or person for another; and still oftener for a verbal ambiguity. In this country, however, the more general meaning attached to the phrase is giving an equivalent for something received.—2. In *med.*, a succedaneum, one medicine substituted for another. [See **QUID**.]

**QUIRE**, *n.* [Fr. *chœur*; L. *chorus*; Gr. *χορος*.] 1. A body of singers; a chorus. [See **CHORUS** and **CHORUS**.]—2. The part of a church where the service is sung.

**QUIRE**, *n.* [Qu. from the root of *chorus*, or from *Fr. cahier*, a sheet of paper, or rather a book of loose sheets.] A collection of paper consisting of twenty-four sheets, each having a single fold.

**QUIRE**, *v. i.* To sing in concert or chorus.

**QUIRINALIA**, *n. plur.* [L.] Feasts observed at Rome in honour of Romulus, who was called *Quirinus*.

**QUIRINUS**, *n.* An Italian warlike divinity, supposed to be the same as Mars. Also the name given by the Romans to Romulus, after he was deified.

**QUIRISTER**, *n.* One that sings in concert; more generally, the leader of a choir, particularly in divine service; a chorister. The word used is *chorister*.

**QUIRTATION**, } *n.* [L. *quiratio*,  
from *quiritio*, from *queror*.] A crying for help.

**QUIRTES**, *n. plur.* [L.] A name given to the populace of Rome, as distinguished from the soldiery.

**QUIRK**, *n.* (*quirk*.) [from the root of *W. quired*, a sudden start or turn, craft, deceit; *quyrn*, a *whirl*.] 1. Literally, a turn; a starting from the point or line; hence, an artful turn for evasion or subterfuge; a shift; a quibble; as, the *quirks* of a pettifogger.—2. A fit or turn; a short paroxysm; as, a *quirk* of joy or grief.—3. A smart taunt or retort.

I may chance to have some odd *quirks* and remnants of wit broken on me. *Shak.* 4. A slight conceit or quibble.—5. † A flight of fancy.—6. An irregular air; as, light *quirks* of music.—7. In *building*, a piece of ground taken out of any regular ground-plot or floor, as to make a court or yard, &c.; thus, if the ground-plot were square or oblong, and a piece were taken out of the corner, such piece is called a *quirk*.—8. In *arch.*, a turn or twist; a deep indentation; the hollow under the abacus.

**QUIRKISH**, *a.* Consisting of quirks, turns, quibbles, or artful evasions.—2. Resembling a quirk.

**QUIRK MOULDINGS**, *n.* Mouldings whose apparent projection is increased by the addition of a quicker curve.

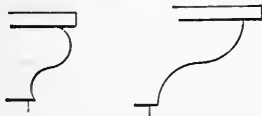

Quirked Ogee.

Plain Ogee.

**QUIR'PELE**, *n.* The Indian ferret, an animal of the weasel kind.

**QUIS'QUALIS**, *n.* A genus of plants belonging to the nat. order Combretaceæ, which is indigenous in Amboyna, Java, and the Malayan peninsula, and extends into India. The species are shrubs with climbing branches. *Q. indica* is the most common; its fruit is reckoned a vermifuge.

**QUIT**, *v. t. pret. and pp. quit or quitted.* [Fr. *quitter*; It. *quitare* and *chitare*; G. *quittiren*; W. *gadw* and *gadaw*, to quit; Ir. *cead*, leave; *cuithim*, to requite. This is the L. *cedo*. The sense of *quit* is to leave, to withdraw from; but the primary sense of the root must have been to move or to send; for to *requite* is to send back.] 1. To leave; to depart from, either temporarily or forever. It does not necessarily include the idea of *abandoning*, without a qualifying word. A man *quits* his house for an hour, or for a month. He *quits* his native country on a voyage, or he *quits* it for ever; he *quits* an employment with the intention of resuming it.—2. To free; to clear; to liberate; to discharge from.

To *quit* you of this fear, you have already looked death in the face. [Nearly obsolete.] *Wake.*

3. To carry through; to do or perform something to the end, so that nothing remains; to discharge or perform completely.

Never a worthy prince a day did *quit* With greater hazard, and with more renown. *Daniel.*

4. To *quit one's self*, reciprocally, to clear one's self of incumbent duties by full performance.

Samson hath *quit himself* Like Samsou. *Milton.*

In this sense, *acquit* is generally used.—5. To repay; to requite.

Enkindle all the sparks of nature To *quit* this horrid act. *Shak.*

In this sense, *quit* is now rarely used. We use *requite*.—6. To vacate obligation; to release; to free from.

Dangers of law, Actions, degrees, judgments against us *quitted.* *B. Jonson.*

7. To pay; to discharge; hence, to free from; as, to *quit* the debt of gratitude.—8. To set free; to release; to absolve; to acquit.

Guiltless I *quit*, guilty I set them free. *Fairfax.*

In this sense, *acquit* is now used.—9. To leave; to give up; to resign; to relinquish; as, to *quit* an office.—10. To pay.

Before that Judge that *quits* each soul his hire.† *Fairfax.*

11. To forsake; to abandon.

Such a superficial way of examining is to *quit* truth for appearance. *Locke.*

To *quit cost*, to pay; to free from by an equivalent; to reimburse; as, the

cultivation of barren land will not always *quit cost*.—To *quit scores*, to make even; to clear mutually from demands by mutual equivalents given. We will *quit scores* [marks of charges] before we part.

Does not the earth *quit scores* with all the elements in her noble fruits? *South.*

**QUIT**, *a. Free*; clear; discharged from; absolved.

The owner of the ox shall be *quit*; Exod. xxi.

2. To be on even terms, or released from obligation.

To John I owed great obligation;

But John, unhappily, thought fit

To publish it to all the nation—

Now I and John are fairly *quit*. *Prior.*

**QUI TAM**. [L.] In *law*, a penal action in which half the penalty is given to the crown, and the rest to the informer. In *England* the plaintiff in a penal action describes himself as one, *qui tam pro domino rege quam pro seipso*, &c., who sues, as well for himself as for the king, for any penalty, half of which is given to the crown, and half to the informer. Hence such actions are called *qui tam*.

**QUITCH'-GRASS**, *n.* Couch grass,—which see.

**QUITCLAIM**, *v. t.* [*quit* and *claim*.]

To release a claim by deed without covenants of warranty; to convey to another who hath some right in lands or tenements, all one's right, title, and interest in the estate, by relinquishing all claim to them. The words used in the instrument are, "A. hath remised, released, and for ever *quitclaimed* all his right, title, and interest to a certain estate."

**QUITCLAIM**, *n.* A deed of release; an instrument by which all claims to an estate are relinquished to another without any covenant or warranty, express or implied.

**QUITCLAIMED**, *pp.* Released by deed.

**QUITCLAIMING**, *ppr.* Conveying by deed of release.

**QUITE**, *adv.* [from *quit*; that is, primarily, free or clear by complete performance.] Completely; wholly; entirely; totally; perfectly. The work is not *quite* done; the object is *quite* accomplished.

He hath sold us and *quite* devoured also our money; Gen. xxxi.

The same actions may be aimed at different ends, and arise from *quite* contrary principles. *Spectator.*

**QUIT'RENT**, *n.* [L. *quietus redditus*.] A small rent or acknowledgement payable by the tenants of most manors, in token of subjection.

**QUITS**, *adv.* [from *quit*.] An exclamation used when mutual demands are adjusted and the parties are even, each *quit* of the other.

**QUITTABLE**, *a.* That may be *quitted* or vacated.

**QUIT'TAL**, *n.* Return; repayment.

**QUIT'TANCE**, *n.* [Fr.] Discharge from a debt or obligation; an acquittance. [See *ACQUITANCE*, which is chiefly used.]—2. Recompense; return; repayment.

**QUIT'TANCE**,† *v. t.* To repay.

**QUIT'TED**, *pp.* Left; relinquished; acquitted.

**QUIT'TER**, *n.* One who *quits*.—2.† A deliverer.—3. Scoria of tin.

**QUIT'TER-BONE**, or **QUIT'TER**, *n.* In *farriery*, a hard round swelling on

the coronet, between the heel and the quarter, usually on the inside of the foot.

**QUIVER**, *n.* [Qu. Fr. *couverir*, to cover.] A case or sheath for arrows.

Take thy *quiver* and thy bow; Gen. xxvii.

**QUIVER**,† *a.* Nimble; active.

**QUIVER**, *v. i.* [D. *huiveren*, to shiver. This word seems to belong to the family of *quaver*, W. *gwibiau*, to trill, to quiver, *gwiv*, a whirl or turn, *gwiviau*, to fly about, to wander, *gwipiau*, to move briskly, *gwvaw*, to stir, move, agitate.] 1. To shake or tremble; to quake; to shudder; to shiver. This word expresses that tremulous motion of the body which proceeds from loss of heat or vigor. Thus persons *quiver* with fear or with cold.

And left the limbs still *quivering* on the ground. *Addison.*

2. To play or be agitated with a tremulous motion.

The green leaves *quiver* with the cooling wind. *Shak.*

The lakes that *quiver* to the curling breeze. *Pope.*

**QUIVERED**, *a.* [from the noun *quiver*.] Furnished with a quiver; as, the *quivered* nymph.—2. Sheathed as in a quiver.

Whose quills stand *quivered* at his ear. *Pope.*

**QUIVERING**, *ppr.* Trembling, as with cold or fear; moving with a tremulous agitation.

**QUIVERING**, *n.* The act of shaking or trembling; agitation; as, to be seized with a *quivering*.

**QUIVERINGLY**, *adv.* With quivering.

**QUI VIVE**. [Fr.] Literally, "who lives?" The challenge of the French sentries to those who approach their posts; equivalent to the English "Who goes there?" Hence, to be on the *qui vive*, is to be on the alert; to be all activity.

**QUIXOT'IC**, *a.* Like Don Quixote; romantic to extravagance.

**QUIX'OTISM**, *n.* Romantic and absurd notions; schemes or actions like those of Don Quixote, the hero of Cervantes.

**QUIX'OTRY**, *n.* Quixotism; visionary scheme.

**QUIZ**, *n.* An obscure question; something to puzzle.—2. One whom an observer cannot make out; an odd fellow. The more general use of the word, however, is to signify one addicted to mockery and jesting in simulated gravity; and also the act itself. This word and its derivatives are used only in colloquial or vulgar language. It is said to have originated in a joke. Daly, the manager of a Dublin play-house, wagered that he would make a word of no meaning to be the common talk and puzzle of the city in twenty-four hours; in the course of that time the letters *q, u, i, z* were chalked or pasted on all the walls of Dublin, with such an effect that the wager was won.

**QUIZ**, *v. t.* To puzzle; to examine narrowly with an air of mockery; to jest with simulated gravity.—2. To look at a person through a quizzing-glass.

**QUIZ'ZICAL**, *a.* Partaking of the nature of a quiz: addicted to quizzing

**QUIZ'ZING**, *n.* The act of mocking by a narrow examination, or by pretended seriousness of discourse. *Quizzing* is frequently accomplished by administering seeming-serious flattery, which being accepted by the individual flattered, exhibits him in a ridiculous light.

**QUIZ'ZING**, *a.* Fitted for quizzing; a quizzing-glass, an eye-glass.

**QUO ANIMO**. [L.] With what intent; purpose.

**QUOAD HOC**. [L.] As to this; as it regards this particular thing named.

**QUOB**, *v. i.* [W. *gwapiaw*, to strike.] To move, as the fetus in utero; to throb. [*Local, vulgar, and little used.*]

**QUOD ERAT DEMONSTRANDUM**. [L.] What was the point to be proved.

**QUOD LIBET**, *n.* [L. what you please.] A nice point; a subtlety. *Quodlibets*, things thrown together without order or connection.

**QUODLIBETA'RIAN**, *n.* One who talks and disputes on any subject at pleasure.

**QUODLIBET'ICAL**, *a.* Not restrained to a particular subject; moved or discussed at pleasure for curiosity or entertainment.

**QUODLIBET'ICALLY**, *adv.* At pleasure; for curiosity; so as to be debated for entertainment.

**QUOIF**, *n.* [Fr. *coiffe*.] A cap or hood. [See **COIF**.]

**QUOIF**, *v. t.* To cover or dress with a coif. [See **COIF**.] [*This word may be discarded with advantage.*]

**QUOIF'FURE**, *n.* [Fr. *coiffure*.] A head dress.

**QUOIL**. See **COIL**, the better word.

**QUOIN**, *n.* [Fr. *coin*, a corner; Sp. *cuna*. See **COIN**.] 1. A corner.—2. An instrument to raise anything; a wedge employed to raise cannon to a proper level, and for other purposes.—3. In *printing*, *quoins* are small wedges of wood used in locking up forms.—4. In *arch.*, the external angle of a building. The term is generally applied to the stones of which the angle is formed, and when these project beyond the general surface of the wall, and have their corners chamfered off, they are called *rustic quoins*.

**QUOIT**, *n.* [D. *coite*.] 1. A flat ring of iron, or kind of horse-shoe, to be pitched or thrown at a fixed object in play.—2. In the plural, the game itself. It is a game resembling that of the ancient *discus*.

**QUOIT**, *v. i.* To throw quoits; to play at quoits.

**QUOIT**, *v. t.* To throw.

**QUO JURE**. [L.] In law, a writ that lies for a person who has lands wherein another claims common of pasture,

time out of mind; and is brought in order to compel the person to show by what title (*quo jure*) he challenges it.

**QUOLL**, *n.* An animal of New Holland, resembling the polecat.

**QUON'DAM**, *used adjectively*. [L.] Having been formerly; former; as, a *quondam* king or friend. [*Used colloquially.*]

**QUOOK**, *pret. of Quake.*

**QUORUM**, *n.* [L. *gen. plur. of qui*, who.] 1. A bench of justices, or such a number of officers or members as is competent by law or constitution to transact business.—2. A special commission of justices. A special of the peace is of the *quorum*, when his commission expresses that he is one of those whose presence is necessary to constitute a bench, as at quarter-sessions. The term *quorum* is derived from the words used in the Latin form of the commission issued to justices of the peace; in which the expression occurred, "*quorum unum A. B. esse volumus*," "of whom we will that A. B. be one;" thus rendering it necessary that certain individuals (said to be of the quorum) should be present at the transaction of business. Hence when in an assembly, committees, &c., it is necessary that a certain number should be present to give validity to its acts, that number is generally said to constitute a quorum.

**QUORUM PARS FUL**. [L.] Of which or whom I was a part; or in which I took or had a part.

**QUO'TA**, *n.* [L. *quotus*; It. and Sp. *quota*; Ir. *cod, cota*, a part.] Share or proportion assigned to each. The part which each member of a society has to contribute or receive in making up or dividing a certain sum.

**QUO'TABLE**, *a.* That may be quoted or cited.

**QUO'TATION**, *n.* [from *quote*.] The act of quoting or citing.—2. The passage quoted or cited; the part of a book or writing named, repeated, or adduced as evidence or illustration.—3. In *mercantile lan.*, the current price of commodities or stocks, published in prices-current, &c.—4. † Quota; share.

**QUOTE**, *v. t.* [Fr. *quoter*, now *coter*; connected with *quoth*.] 1. To cite, as a passage from some author; to name, repeat, or adduce a passage from an author or speaker, by way of authority

or illustration; as, to *quote* a passage from Homer; to *quote* the words of Peter, or a passage of Paul's writings; to *quote* chapter and verse.—2. In *com.*, to name, as the price of an article.—3. To note.

**QUOTE**, *† n.* A note upon an author.

**QUOTE**, *n.* The result of dividing one number by another; a quotient.

**QUOTED**, *pp.* Cited; adduced; named.

**QUOTELESS**, *a.* That cannot be quoted.

**QUOTER**, *n.* One that cites the words of an author or speaker.

**QUOTH**, *v. i.* [Sax. *cythan, cythan, Goth. quithan*, to say, to tell; W. *gwed, gwedyd*; Ir. *ccadach*. Qu. L. *inquo*, contracted.] To say; to speak. This verb is defective, being used only in the first and third persons in the present and past tenses; as, *quoth I, quoth he*, and the nominative always follows the verb. It is used only in ludicrous language, and has no variation for person, number, or tense.

**QUOTID'IAN**, *a.* [L. *quotidianus*; *quotus* and *die*.] Daily; occurring or returning daily; as, a *quotidian* fever.

**QUOTID'IAN**, *n.* A fever whose paroxysms return every day.—2. Any thing returning daily.

**QUO'TIENT**, *n.* [Fr. from L. *quoties*, how often.] In *arith.*, the number resulting from the division of one number by another, and showing how often a less number is contained in a greater. Thus 3|12(4. Here 4 is the *quotient*, showing that 3 is contained 4 times in 12. Or *quotient* is an expression denoting a certain part of a unit; as †.

[See **DIVISION**.]

**QUOTING**, *ppr.* Citing; adducing; naming.

**QUO WARRANTO**, in Law Latin, a writ that lies against any person or corporation that has usurped, or unjustly claims any public office or other franchise or liberty; or, that having originally had a grant of one, has forfeited it by abuse or neglect. Proceedings under it are prosecuted before the judges of the court of king's (queen's) bench, and the defendant is called upon to show by what warrant (*quo warranto*) he exercises the office, liberty, or franchise in question. The writ itself is fallen into disuse, but the same end is attained by the attorney-general filing an information in the nature of a *quo warranto*.

R

**R** IS the eighteenth letter of the English Alphabet, and an articulation *sui generis*, having little or no resemblance in pronunciation to any other letter. But from the position of the tongue in uttering it, it is commutable with *l*, into which letter it is changed in many words by the Spaniards and Portuguese, and some other nations; as *l* is also changed into *r*. It is numbered among the liquids and semi-vowels, and is sometimes called the canine letter. It is uttered with a guttural extrusion of the breath, and in some words, particularly at the end or after a labial and a dental letter, with a sort of quivering motion or slight jar of the tongue. Its English

uses, which are uniform, may be understood by the customary pronunciation of *rod, room, rose, bar, bare, barren, disturb, catarrh, free, brad, pride, drip, drag, drown*. In words which we have received from the Greek language, we follow the Latins, who wrote *h* after *r*, as the representative of the aspirated sound with which this letter was pronounced by the Greeks. It is the same in the Welsh language. But as the letter is not aspirated in English, *h* is entirely superfluous; *rhapsody, rheum, rhetoric* being pronounced *rapsody, reum, retoric*. As an abbreviation, *R*, in English, stands for *rex*, king, as George R., or for *regina*, queen; as Victoria R., also for

*royal*; as R. N., Royal Navy; R. A., Royal Academy or Academician; R. M., Royal Marines. *R. M.* also stand for Ready Money. In the notes of the ancients, *R.* or *RO.* stands for *Roma*; R. C. for *Romana civitas*; R. G. C. for *rei gerendæ causa*; R. F. E. D. for *recte factum et dictum*; R. G. F. for *regius filius*; R. P. *respublica*, or *Romani principes*. As a numeral, *R*, in Roman authors, stands for 80, and with a dash over it, *R̄*, for 80,000. But in Greek, *ρ*, with a small mark over it, thus *ρ̄*, signifies 100, and with the same mark under it, it denoted 1000 × 100, or 100,000. In Hebrew, *ר* denoted 200, and with two horizontal points

over it,  $\sim$ , 1000  $\times$  200, or 200,000. Among physicians, R. or  $\beta$  stands for *recipe*, take.

RA, as an inseparable prefix or preposition, is the Latin *re*, coming to us through the Italian and French, and primarily signifying *again, repetition*. [See RE.]

RABATE, *v. t.* [Fr. *rabattre*; It. *rabattere*; *ra* and *battere*, *battere*, to beat. See BEAT and ABATE.] In *falconry*, to bring down or recover a hawk to the fist.

RABA'TO,  $\dagger$  *n.* [Fr. *rabat*.] A neck-band or ruff.

RAB'BET, } *v. t.* See REBATE,  
RAB'BETED, }  
RAB'BETING, } REBATING, &c.

RAB'BI, } *n.* [Ch.  $\text{רַב}$ , *rabba*, lord,  
RAB'BIN, } master.] A title assumed by the Jewish doctors, signifying master or lord. This title is not conferred by authority, but assumed or allowed by courtesy to learned men.

RABBIN'IC, } *a.* Pertaining to the  
RABBIN'ICAL, } Rabbins, or to their opinions, learning, and language. The term *rabbinitical* has been given to all the Jewish writings composed after the Christian era.

RABBIN'IC, *n.* The language or dialect of the Rabbins; the later Hebrew.

RAB'BINISM, *n.* A Rabbinic expression or phraseology; a peculiarity of the language of the Rabbins.

RAB'BINIST, *n.* Among the Jews, one who adhered to the Talmud and the traditions of the Rabbins, in opposition to the Caraites, who rejected the traditions.

RAB'BINITE, *n.* The same as *Rabbinitist*.  
RAB'BIT, *n.* [said to be from the Belgic *robbe, robbehen*.] A rodent mammal, and a small quadruped, the *Lepus cuniculus*, which feeds on grass or other herbage, and burrows in the earth. The rabbit is said to be less sagacious than the hare; it is also of smaller size, and has shorter ears and hinder legs. In its wild state the fur is of a brown colour; but when domesticated, the colours vary much, being white, pied, ash-coloured, black, &c. Rabbits are reared in warrens or in hutches. They are extremely prolific, producing young seven times a year, the litter usually being eight. Their fur is used in the manufacture of hats, and their flesh is more juicy than that of the hare.—*Welsh rabbit*, a familiar name given to bread and cheese, when toasted together.

RAB'BIT, [Fr. *rabot*.] A wooden implement used in mixing mortar.

RAB'BLE, *n.* [L. *rabula*, a brawler, from *ra*, to rave; Dan. *raaber*; D. *rabblen*.] 1. A tumultuous crowd of vulgar, noisy people; the mob; a confused disorderly crowd.—2. The lower class of people, without reference to an assembly; the dregs of the people. Countrymen will ye relent, and yield to mercy.

Or let a *rabble* lead you to your deaths. *Shak.*

RAB'BLE, *n.* A rhapsody, idle incoherent discourse.—*To rabble*, to talk incoherently; to utter nonsense. [Scotch.]

RAB'BLE-CHARMING, *a.* Charming or delighting the rabble.

RAB'BLEMENT,  $\dagger$  *n.* A tumultuous crowd of low people.

The *rabblement* shouted, clapp'd their chopt-hands, and uttered a deal of stinking breath. *Shak.*

RABDOL'OGY, *n.* [Gr.  $\text{ραβδος}$ , a rod, and  $\text{λογος}$ , discourse.] The method of

computing or numbering by rods; particularly according to the contrivance called *Napier's bones or rods*,—*which see*.

RAB'ID, *a.* [L. *rabidus*, from *rabio*, *rabio*, to rage; W. *rhaib*.] Furious; raging; mad; as, a *rabid* dog or wolf. It is particularly applied to animals of the canine genus affected with the distemper called *rabies*, and whose bite communicates hydrophobia.

RAB'IDNESS, *n.* Furiousness; madness.

RA'BIES, *n.* [L.] Madness; generally applied to the disease in dogs otherwise called *hydrophobia*.

RAB'INET,  $\dagger$  *n.* A kind of smaller ordnance.

RACA, *n.* A Syriac word signifying empty, beggarly, foolish; a term of extreme contempt; *Matt. v.*

RACCOON, *n.* An American quadruped, the *Procyon lotor*, a carnivorous mammal. It is somewhat larger than a fox, and its fur is deemed valuable, next to that of the beaver, being prin-



Raccoon (*Procyon lotor*).

cipally used in the manufacture of hats. This animal lodges in a hollow tree, feeds occasionally on vegetables, and its flesh is palatable food. It inhabits North America, from Canada to the tropics.

RACE, *n.* [Fr. *race*, from the It. *razza*; Sp. *raza*, a race, a ray, and *raiz*, a root, L. *radix*; Russ. *rod*, a generation, race; *roju*, to beget. The primary sense of the root is to thrust or shoot; the L. *radix* and *radius* having the same original. This word coincides in origin with *rod*, *ray*, *radiate*, &c.] 1. The lineage of a family, or continued series of descendants from a parent, who is called the stock. A race is the series of descendants indefinitely. Thus all mankind are called the *race* of Adam; the Israelites are of the *race* of Abraham and Jacob. Thus we speak of a *race* of kings, the *race* of Clovis or Charlemagne; a *race* of nobles, &c.

Hence the long *race* of Alban fathers come. *Dryden*.

2. A generation; a family of descendants.

A *race* of youthful and unhandled colts. *Shak.*

3. A particular breed; as, a *race* of mules; a *race* of horses; a *race* of sheep.

Of such a *race*, no matter who is king. *Murphy*.

4. A root; as, a *race* of ginger; hence *race*-ginger is ginger in the root or not pulverized.—5. A small artificial canal or water course, leading from the dam of a stream, to the machinery which it drives.—6. A particular strength or taste indicating the root, stock, or soil of some natural production; as, the *race* of wine, which implies a distinguishing flavour by which its sort is known. Hence,—7. A strong flavour, as of wine, with a degree of tartness.

RACE, *n.* [D. *ras*; Sw. *resa*, to go; Dan. *rejse*, a going or course; L. *gra-*

*dior*, *gressus*, with the prefix *g*; Ir. *ratha*, running; *reathum*, to run; W. *graz*, a step, from *rhaz*, a going; allied to W. *rhed*, a race; *rhedu*, to run, to race; allied to Eng. *ride*.] 1. A running; a rapid course or motion, either on the feet, on horseback, or in a carriage, &c.; particularly, a contest in running; a running in competition for a prize.

The *race* was one of the exercises of the Grecian games. *Encyc.*  
I wield the gauntlet, and I run the *race*. *Pope*

2. Any running with speed.  
The flight of many birds is swifter than the *race* of any beast. *Bacon*.

3. A progress; a course; a movement or progression of any kind.  
My *race* of glory run. *Pope*.  
Let us run with patience the *race* that is set before us; Heb. xii.

4.  $\dagger$  Course; train; process; as, the prosecution and *race* of the war.—

5. A strong or rapid current of water, or the channel or passage for such a current; as, a mill-*race*; also a name given to a strong rippling tide or current caused by the projection of the land, and the unevenness of the ground over which the tide flows; as, Portland *Race*.—6. *By way of distinction*, a contest in the running of horses; generally in the plural. The *racers* commence in October. [See RACES.]

RACE, *v. t.* To run swiftly; to run or contend in running. The animals *race* over the ground.

RACE-GIN'GER, *n.* Ginger in the root or not pulverized.

RACE-HORSE, *n.* A horse bred or kept for running in contest; a horse that runs in competition, called also a *blood-horse* and a *thorough-bred horse*. The English race-horse, though far inferior to the Arab in point of endurance, is, perhaps, the finest horse in the world for moderate heats, such as those on the common race grounds in this country. This animal is of foreign extraction, improved and perfected by the influence of the climate, and by careful crossing.

RACEMA'TION, *n.* [L. *racemus*, a cluster.] 1. A cluster, as of grapes.—

2. The cultivation of clusters of grapes.

RA'CEME, *n.* [L. *racemus*, a bunch of berries.] In *bot.*, a species of inflorescence, consisting of a common peduncle with short and equal lateral pedicels, as in the hyacinth. It is simple or compound, naked or leafy, &c.

RA'CEMED, *a.* Having a raceme.

RACEMIC ACID, *n.* An acid found, together with the tartaric acid, in the tartar obtained from certain vineyards on the Rhine. It is also called *paratartronic acid*.

RACEMIF'EROUS, *a.* [L. *racemus*, a cluster, and *fero*, to bear.] Bearing racemes, as the currant.

RAC'EMOUS, } *a.* Growing in ra-  
RAC'EMOSE, } cemes.

RA'CEMER, *n.* [from *race*.] A runner; one that contends in a race.

And bade the nimble *racers* seize the prize. *Pope*.

2. A race-horse.



Raceme.

**RA'CFES**, *n. plur.* [See **RACE**.] In the usual acceptance, public trials of the speed of horses. The usual trial of speed in English *races* is a single mile; of continuance or bottom, four miles. There are also *ass-races*, *foot-races* by men, boys, and even women, sometimes in sacks. In *Rome*, there are *races* of horses without riders.

**RACH**, *n.* [Sax. *ræc*; D. *brak*; Fr. *braque*.] A setting dog.

**RACHIL'LA**, *n.* [Gr. *ραχις*, a spine.] In *bot.*, a branch of inflorescence; the zigzag centre upon which the florets are arranged in the spikelets of grasses.

**RA'CHIS**, *n.* [Gr. *ραχις*, a spine.] In *bot.*, a branch which proceeds nearly in a straight line from the base to the apex of the inflorescence of a plant. It is also applied to the petioles of the leaves of ferns.—2. In *zool.*, a term sometimes applied to the vertebral column of mammals and birds.

**RACHIT'IC**, *a.* Pertaining to the muscles of the back; rickety.

**RACHI'TIS**, *n.* [Gr.] This term implies inflammation of the spine, but it is applied to the disease called *Rickets*, which is a mere corruption of *rachitis*.

**RA'GINESS**, *n.* [See **RACY**.] The quality of being racy.

**RA'RING**, *ppr.* Running swiftly; running or contending in a race.

**RA'RING**, *n.* The riding for a plate or other premium, at the public contests in the running of horses.

**RACK**, *n.* [D. *rek*, rack, stretch; *reker*, to stretch; Sax. *racan*, *ræcan*, Eng. *to reach*; G. *recken*, to stretch; *reckbank*, a rack. See **REACH** and **BREAK**.] In a *general sense*, something used for stretching; something stretched; something in which things are spread out for use. Particularly,—1. An engine furnished with pulleys, cords, and other means of torture, used for extorting

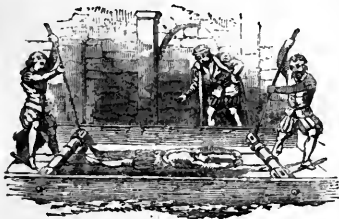

Tortured on the Rack.

confessions from criminals or suspected persons. It was formerly much used by civil authorities in cases of traitors and conspirators; and by the members of the Inquisition, for extorting a recantation from imputed heretical opinions.—2. Torture; extreme pain; anguish.

A fit of the stone puts a king to the *rack*, and makes him as miserable as it does the meanest subject. *Temple.*

3. Insupportable irksomeness of position. [Said ironically.]

Set on the *rack* of a too easy chair. *Pope.*  
4. Any instrument for stretching, extending, or bending anything; as, a *rack* for bending a bow.—5. A grating on which *hacon* is laid; also a framework for storing bottles, earthenware, &c., as a *bottle rack*.—6. A framework placed above a manger in which hay or fodder is placed for horses or cattle.—7. The frame of bones of an animal; a skeleton. We say, a *rack* of bones.—8. A frame of timber on a ship's bowsprit, containing several sheaves to

direct the sailors to the respective ropes passing through it.—9. In *mech.*, a straight metallic bar, with teeth on one of its edges, adapted to work into the



Rack and Pinion.

teeth of a wheel or pinion, for the purpose of converting a circular into a rectilinear motion, or *vice versa*. The *rack* may be considered as a toothed wheel whose radius is infinite.—10.† The distaff on which the wool or flax is placed, which is to be spun. [See **ROCK**, the modern word.]—11. In the *manege*, a pace in which a horse neither trots nor ambles. [See **RACKING PACE**.]

**RACK**, *n.* [Sax. *hracca*, the neck; Gr. *ραχις*, the spine; W. *rhae*; G. *hragen*, Sw. and Dan. *hrage*, a collar; Old Eng. *crag*.] The neck and spine of a fore quarter of veal or mutton. [The two foregoing words are doubtless from one original.]

**RACK**, *n.* [Sax. *rec*, steam; *reacan*, to exhale; D. *rook*, *rooken*; G. *rauch*, *rauchen*. See **REEK**.] Properly, vapour; hence, thin flying broken clouds, or any portion of floating vapour in the sky.

The winds in the upper region, which move the clouds above, which we call the *rack*... *Bacon.*

The great globe itself, And, like this unsubstantial pageant, faded, Leave not a *rack* behind. *Shak.* [It is disputed, however, whether *rack* in this passage should not be *wreck*.]

**RACK**, *n.* [for *arrack*. See **ARRACK**.] Among the Tartars, a spirituous liquor made of mare's milk which has become sour and then is distilled, generally called *koumiss*.

**RACK**, *v. i.* [Sax. *reacan*. See the Noun.] 1. Properly, to steam; to rise, as vapour. [See **REEK**, which is the word used.] 2. To fly, as vapour or broken clouds.

**RACK**, *v. t.* [from the noun.] To torture; to stretch or strain on the rack or wheel; as, to *rack* a criminal or suspected person, to extort a confession of his guilt, or compel him to betray his accomplices.—2. To torment; to torture; to affect with extreme pain or anguish; as, *racked* with deep despair.—3. To harass by exaction.

The landlords there shamefully *rack* their tenants. *Spenser.*

4. To stretch; to strain vehemently; to wrest; as, to *rack* and stretch Scripture; to *rack* invention.

The wisest among the heathens *racked* their wits. *Tillotson.*

5. To stretch; to extend.—To *rack* a *tackle*, to fasten the two opposite parts of it together with a seizing, so that any weighty body suspended thereby shall not fall down, though the rope which forms the tackle should be loosened by accident or neglect.

**RACK**, *v. i.* [Ar. *rauka*, to clear, to strain.] To draw off from the lees; to draw off, as pure liquor from its sediment; as, to *rack* cider or wine; to *rack* off liquor.

**RACK'ED**, *pp.* Tortured; tormented; strained to the utmost.—2. Drawn off, as liquor.

**RACK'ER**, *n.* One that tortures or torments; one that racks.

**RACK'ET**, *n.* [This word belongs to the root of *crack*, Fr. *cracquer*. See **ROCKET**.] 1. A confused, clattering noise, less loud than *uproar*; applied to the confused sounds of animal voices, or such voices mixed with other sound. We say, the children make a *racket*; the *racket* of a flock of fowls. 2. Clamour; noisy talk. [*Colloq.*]

**RACK'ET**, *n.* A snow-shoe.

**RACK'ET**, *n.* [Fr. *raquette*; G. *racket*.] The instrument with which players at tennis strike the ball; a bat, usually consisting of a net-work of catgut strained very tight in a circle of wood, with a handle.—2. The game of tennis.—*Racket-court*, the area in which rackets is played.

**RACK'ET**, *v. i.* To make a confused noise or clamour; to frolic; to move about in scenes of tumultuous pleasure.

**RACK'ET**, *v. t.* To strike as with a racket.

**RACK'ETED**, *pp.* Struck with a racket.

**RACK'ETING**, *ppr.* Striking with a racket.

**RACK'ETY**, *a.* Making a tumultuous noise.

**RACK'ING**, *ppr.* Torturing; tormenting; straining; drawing off.—2. *a.* Tormenting; excruciating; as, a *rack*-ing pain.

**RACK'ING**, *n.* Torture; a stretching on the rack.—2. Torment of the mind; anguish; as, the *rackings* of conscience.—3. The act of stretching cloth on a frame for drying.—4. The act of drawing from the sediment, as liquors.

**RACK'ING**, *ppr.* Flying as vapour or broken clouds.

And drive the *racking* clouds along the liquid space. *Dryden.*

**RACK'ING-PACE**, *n.* The racking-pace of a horse is an amble, but with a quicker and shorter tread.

**RACKOON**. See **RACCOON**.

**RACK-RENT**, *n.* An annual rent of the full value of the tenement, or near it.

**RACK'-RENTED**, *a.* Subjected to the payment of rack-rent.

**RACK'-RENTER**, *n.* One that is subjected to pay rack-rent.

**RACODIUM**, *n.* A genus of fungi, some of the species of which are found in old wine-cellars. One is called *Racodium cellare*.

**RACCOON**. See **RACCOON**.

**RA'CY**, *a.* [This word, if the sense of it is strong, vigorous, would seem to belong to the family of Sax. *hræs*, force; *ræsan*, to rush. But the application of it by Cowley in the passage below, seems to indicate its connection with the Sp. and Port. *raiz*, root, L. *radix*.] Strong; flavorous; tasting of the soil; as, *racy* cider; *racy* wine.—2. Having a strong radical or distinctive character of thought or language; as, a *racy* style.

Rich *racy* verses, in which we The soil from which they come, taste, smell, and see. *Cowley.*

**RAD**, the *old pret.* of *Read*.

**RAD**, **RED**, **ROD**, an initial or terminating syllable in names, is the D. *raad*, G. *rath*, counsel; as, in *Conrad*, powerful in counsel; *Ethelred*, noble counsel.

**RAD'DLE**, *v. t.* [probably from Sax. *wrad*, *wrad*, or *wrath*, a band or

wreath, or from the same root.] To interweave; to twist; to wind together. **RAD'DLE**, *n.* [supra.] A long stick used in hedging; also, a hedge formed by interweaving the shoots and branches of trees or shrubs. In *New England*, an instrument consisting of a wooden bar, with a row of upright pegs set in it, which is employed by domestic weavers, to keep the warp of a proper width, and prevent it from becoming entangled, when it is wound upon the beam of the loom.

**RAD'DOCK**, } *n.* [from *red*, *radly*,—  
**RUD'DOCK**, } *which see.*] A bird, the red-breast of Europe.

**RAD'DIAL**, *a.* [from *L. radius*, a ray, a rod, a spoke. See **RADIUS** and **RAY**.]

1. Having the quality or appearance of a rod, a ray, or a radius; shooting out as from a centre.—2. Pertaining to the radius, one of the bones of the fore arm of the human body; as, the *radial artery* or nerve. The *radial muscles* are two muscles of the fore arm, one of which bends the wrist, the other extends it.—*Radial curves*, in *geom.*, curves of the spiral kind, whose ordinates all terminate in the centre of the including circle, and appear like so many semidiameters.

**RAD'DIANCE**, } *n.* [*L. radians*, *radio*,  
**RAD'DIANCY**, } to beam or shoot rays. See **RADIUS** and **RAY**.] Properly, brightness shooting in rays or beams; hence in general, brilliant or sparkling lustre; vivid brightness; as, the *radiance of the sun*.

The Son  
Girt with omnipotence, with radiance  
crown'd

*Milton.*

**RAD'DIANT**, *a.* Shooting or darting rays of light as from a centre; shining; sparkling; beaming with brightness; emitting a vivid light or splendour; as, the *radiant sun*.

Mark what *radiant* state she spreads.

*Milton.*

*Radiant* in glittering arms and beamy pride.

*Milton.*

**Radiant heat**. When a hot body is suspended in the air, a quantity of heat is emitted in all directions by its surface, passing off in right lines like the radii of a circle. The heat so emitted is termed *radiant heat*, and its quantity is greatly dependent upon the nature of the heated surface. It is smallest from polished metallic surfaces, and greatest from rough and unmetallic surfaces.—*Radiant point*, in *optics*, the point from which rays proceed; also called the *radiating point*.—*Radiant flower*, in *bot.* [See **RADIATE**.]—*Radiant*, in *her.*, is an epithet for a charge when it is represented with rays or beams about it.



A Chief Radiant.

**RAD'DIANT**, *n.* In *optics*, the luminous point or object from which light emanates, that falls on a mirror or lens.—2. In *geom.*, a straight line proceeding from a given point or fixed pole, about which it is conceived to revolve.

**RAD'DIANTLY**, *adv.* With beaming brightness; with glittering splendour.

**RAD'DIATA**, } *n.* [*L. radius*.] The  
**RAD'DIARIES**, } name given by Cuvier to the fourth great division of the animal kingdom, including those animals whose parts are arranged round an axis, and on one or several radii, or on

one or several lines extending from one pole to the other. This division comprehends the echinodermata, the entozoa, the acalapha, the polypi or poly-podes, and the infusoria.

**RAD'DIATE**, *v. i.* [*L. radio*. See **RAY**.] 1. To issue in rays, as light; to dart, as beams of brightness; to shine.

Light *radiates* from luminous bodies directly to our eyes. *Locke.*

2. To send out in rays as from a centre. **RAD'DIATE**, *v. t.* To enlighten; to illuminate; to shed light or brightness on. [Usually *irradiate*.]

**RAD'DIATE**, *a.* In *bot.*, a *rayed* or *radiate flower*, is a compound flower consisting of a disk, in which the corollas or florets are tubular, and of a ray, in which the florets are ligulate or strap-shaped, as the daisy, marigold, &c. Or a flower with several semifloretulous florets, set round a disk in form of a radiant star.

**RAD'DIATED**, *pp.* Adorned with rays of light.—2. Having rays, or lines proceeding as from a centre.—3. In *min.*, having crystals or fibres diverging as from a centre.—4. In *zool.*, belonging to the division *Radiata*.

**RAD'DIATED IRON PYRITES**. A variety of sulphuret of iron of a pale bronze yellow. It occurs, regularly crystallized, in radiated, granular, and lamellar concretions. But more frequently its form is globular, botryoidal, reniform, tuberoso, &c.

**RAD'DIATING**, *ppr.* Darting rays of light; enlightening.—*Radiating point*, in *optics*, any point from which rays of light proceed.

**RAD'DIATION**, *n.* [*L. radiatio*.] 1. The emission and diffusion of rays of light; beamy brightness.—2. The shooting of any thing from a centre, like the diverging rays of light.—3. In *physics* and *meteorology*, the emission of rays of light and heat from a luminous or heated body. The theory of the radiation and conduction of heat has been reduced by the successive labours of Prevost, Leslie, Fourier, Biot, Laplace, Poisson, Forbes, and others, to a purely mathematical form, and thereby placed in the same rank with physical optics. The intensity of radiation varies with the nature of the radiating body, and the state of its surface with regard to polish, colour, source of heat, &c. Its intensity in a vacuum is inversely as the square of the distance from the radiating point.—*Solar radiation*, the heat which the earth receives from the sun.—*Terrestrial radiation*, the heat which escapes from the earth into the regions of space.

**RAD'DICAL**, *a.* [Fr. from *L. radicalis*, from *radix*, root. See **RACE** and **RAY**.]

1. Pertaining to the root or origin; original; fundamental; as, a *radical truth* or error; a *radical evil*; a *radical difference* of opinions or systems.—2. Implanted by nature; native; constitutional; as, the *radical moisture* of a body.—3. Primitive; original; un-derived; uncompounded; as, a *radical word*.—4. Serving to origination.—5. In *bot.*, proceeding immediately from the root; as, a *radical leaf* or peduncle.—*Radical leaves*, are those which spring from the neck of the root; as in the cowslip and dandelion.—*Radical peduncle*, one that proceeds from the axil of a radical leaf; as in the primrose and cowslip.—*Radical bass*, in *music*, the same as fundamental bass.

—*Radical reformers* or *radicals*, in

*politics*, that political party in this country holding opinions ultra liberal, and occasionally bordering on republican-ism.

**RAD'DICAL**, *n.* In *philology*, a primitive word; a radix, root, or simple undervived uncompounded word.—2. A primitive letter; a letter that belongs to the radix.—3. In *modern politics*, a person who advocates a *radical reform*, or extreme measures in reformation.—4. In *chem.*, the original principle of a compound, or that which constitutes the distinguishing part of an acid or a base, by its union with oxygen, or other acidifying and basifying principles.

The known radicals of acids are certain compounds of carbon and oxygen, cyanogen, mellone, benzule, cinnamule, salicule, acetule, and formule. The radicals forming bases are amide, ethule, methule, cetule, amule, and glycerule.—*Compound radicals*, a certain class of compound bodies possessing the property of uniting with the elements, and of forming with them combinations which are analogous in their properties to the combinations of two simple bodies; combinations, therefore, in which the elementary body may be removed, and its place occupied by the equivalent quantities of other simple bodies. The compound radicals are capable of uniting with each other; they form, with oxygen and sulphur, acids, and bases; many of them unite with hydrogen producing hydracids.—*Radical quantities*, in *alge.*, quantities whose roots may be accurately expressed in numbers. The term is sometimes extended to all quantities under the radical sign.—*Radical sign*, the sign  $\sqrt{\quad}$  placed before any quantity, denoting that its root is to be extracted; thus,  $\sqrt{a}$  or  $\sqrt{a+b}$ . To distinguish the particular root to be extracted a number is prefixed to the sign: thus  $\sqrt[2]{\quad}$ ,  $\sqrt[3]{\quad}$ ,  $\sqrt[4]{\quad}$ , &c., denote, respectively, the square root, cube root, fourth root, &c. In the case of the square root, however, the number is usually omitted, and merely the sign  $\sqrt{\quad}$  written. Fractional exponents are frequently used instead of the radical sign, in which case the index of the quantity forms the numerator, and the root to be extracted the denominator: thus,  $x^{\frac{1}{2}}$  is equivalent to  $\sqrt{x^2}$ .

**RAD'DICALISM**, *n.* The doctrine or principle of making radical reform in government, by overturning the present state of things, and changing it for one supposed to be better.

**RAD'DICALITY**, *n.* Origination.—2. A being radical; a quantity which has relation to a root.

**RAD'DICALLY**, *adv.* Originally; at the origin or root; fundamentally; as, a scheme or system *radically* wrong or defective.—2. Primatively; essentially; originally; without derivation.

These great orbs thus *radically* bright.

*Prior.*

**RAD'DICALNESS**, *n.* The state of being radical or fundamental.

**RAD'DICANT**, *a.* [*L. radicans*.] In *bot.*, rooting; shooting forth roots; as, a *radicant stem* or leaf.

**RAD'DICATE**, *v. t.* [*L. radicans*, *radior*, from *radix*, root.] To root; to

plant deeply and firmly; as, *radicated* opinions; *radicated* knowledge.

Meditation will *radicate* these seeds.

Hummond.

RAD'ICATE, } *pp.* or *a.* Deeply  
RAD'ICATED, } planted.

Prejudices of a whole race of people *radicated* by a succession of ages. Burke.

2. In *bot.*, rooted, or having taken root; as, a *radicated* stem.—*Radicated shell*, in *conchol.*, a shell fixed by the base, or by a byssus to some other body.

RAD'ICATING, *ppr.* or *a.* In *bot.*, taking root from some part above ground, as the joint of a stem, the extremity of a leaf, &c.

RAD'ICATION, *n.* [from *radicate*.] The process of taking root deeply; as, the *radication* of habits.—2. In *bot.*, the disposition of the root of a plant with respect to the ascending and descending caudex.

RAD'ICLE, *n.* [L. *radicula*, from *radix*.] 1. In *bot.*, the conical body which forms one extremity of the embryo, and which, when germination takes place, becomes the descending axis or root of the plant.



Germination of a dicotyledonous seed.

—2. *Radicles*, the fibrous parts of a root which are renewed every year, and which are the parts that absorb the nutriment from the earth.

RAD'ICULE, *n.* In *bot.*, the same as radicle.

RAD'ICULAR, *n.* In *bot.*, pertaining to the radicle.

RAD'YOLA, *n.* A genus of plants of the class and order Tetrاندria tetragynia, Linn.; nat. order Linaceae. The *R. millegrana*, or thyme-leaved flaxseed, or all-seed, is a British plant, very minute, and growing on moist, gravelly, and boggy soils.

RAD'YOLITES, *n.* A genus of fossil shells, obtained from that part of the Pyrenees which is named Les Corbières. They are striated externally; the inferior valve is in the form of a reversed cone; the superior convex.

RADIOMETE, *n.* [L. *radius*, rod, and Gr. *μετρος*, measure.] The staff, an instrument formerly used for taking the altitudes of celestial bodies. It is superseded by the sextant.

RAD'ISH, *n.* [Sax. *radie*; G. *radiess*; Ir. *raidis*; W. *rhuzygyl*, from *rhuzyg*, red. See Ruddy.] The popular name of plants of the genus Raphanus, the roots of which are eaten raw. [See RAPHANUS.] *Horse-radish* is of the genus Cochlearia. *Water-radish* is of the genus Sisymbrium.

RAD'IIUS, *n.* [L. *id.* a ray, a rod, a beam, a spoke, that is, a shoot; *radio*, to shine, that is, to dart beams. See RAY.] 1. In *geom.*, a right line drawn or extending from the centre of a circle to the circumference, or from the centre of a sphere to its surface, and hence the semi-diameter of the circle or sphere. All the radii of the same circle are equal to one another. In *trigonometry*, the radius is the whole sine, or sine of 90°.—2. In *anat.*, the exterior bone of the fore

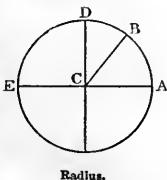

Radius.

arm, descending along with the ulna from the elbow to the wrist.—3. In *bot.*, a ray; the outer part or circumference of a compound radiate flower, or radiated discous flower.—4. The spoke of a wheel.—*Radius of curvature*, in the *higher geom.*, the radius of curvature at any point of a curve line, is the radius of the circle, which osculates the curve at the given point [see OSCULATION], or has the same curvature as the curve at that point.—*Radius vector*, in *astron.*, the straight line drawn from the centre of force (in any curve on which a body is supposed to move by centripetal force) to the point of the orbit where the body is supposed to be. It is a general radius to the curve, and has the addition of *vector* [Lat. a carrier], because it is imagined to carry forward the body to which it is attached. The earth, for example, moves in an elliptic orbit, of which the sun (the centre of force) is in one of the foci; and of consequence the radius vector is continually increasing in length during her course from the perihelion to the aphelion, and decreasing in the same proportion in the progress of her return. It is a law of the planetary motions that the radius vector passes over equal areas of the orbit in equal times.—*Radius bars*, the guide bars of the parallel motion of a steam engine.

RAD'IX, *n.* [L. a root.] In *etym.*, a primitive word from which spring other words.—2. Any number which is arbitrarily made the fundamental number or base of any system. Thus 10 is the radix of the decimal system of numeration; also in Briggs's, or the common system of logarithms, the radix is 10; in Napier's it is 2.7182818284. All other numbers are considered as some powers or roots of the radix, the exponents of which powers or roots constitute the logarithms of those numbers respectively.—3. In *alge.*, radix sometimes denotes the root of a finite expression, from which a series is derived.

RÄFF, *v. t.†* [G. *raffen*, to sweep, to seize, or snatch. It seems to be from the root of Sax. *raefian*, L. *rapio*; Ch. Syr. and Heb. *רפא*, *garaph*, Ar. *jarafa*, to sweep away; Pers. *roftan*, id.] To sweep; to snatch, draw, or huddle together; to take by a promiscuous sweep.

Their causes and effects I thus *raff* up together. Carew.

RÄFF, *n.* The sweepings of society; the rabble; the mob, [coluivies.] This is used chiefly in the compound or duplicate, *riffräff*. [Pers. *roftah*, L. *quisquilia*, sweepings.]—2. A promiscuous heap or collection; a jumble.

RÄF'LE, *v. i.* [Fr. *rafler*, to sweep away; D. *ryffelen*; Sp. *rifar*, to raffle, and to *strive*, to quarrel, to dispute, and to *rive*, to split a sail; Port. *rifa*, a set of cards of the same colour, and a raffle or raffling, also a craggy or steep place; *rifar*, to neigh, as a mettlesome horse; probably from *riuing*, opening with a burst of sound, or as we say, to *rip out* (an oath). The Sp. *rifar*, to strive, is precisely the Heb. *רפא*, *rub*, to strive; Syr. to make a tumult or clamour; all from driving or violence. Pers. *roftan*, to sweep, to clean the teeth. See RAFF.] To try the chance of a raffle; to cast dice for a prize, for which each person concerned in the game lays down a

stake, or hazards a part of the value; as, to *raffle* for a watch.

RÄF'FLE, *n.* A game of chance, or lottery in which several persons deposit a part of the value of the thing, in consideration of the chance of gaining it by casting dice or otherwise. The successful person takes or sweeps the whole.

RÄF'FLER, *n.* One who raffles.

RÄFFLE'SIA, *n.* A genus of parasitical plants with scales in room of leaves, and exhibiting in some degree the structure both of flowering and flowerless plants. It is made the type of the nat. order Rafflesiaceae. *R. arnoldii* is found in the hot damp jungle of Sumatra, growing parasitically on a kind of vine. It consists of a flower only, having neither leaves, branches, nor roots. This flower, however, is of gigantic size, measuring three feet in diameter. It is used in Java as a powerful astringent for certain purposes.

RÄF'FLING, *ppr.* Throwing dice for a prize staked by a number.

RÄFT, *n.* [In Dan. *raft* is a rack for hay; in Sax. *raefian* is the L. *rapio*; qu. from floating, sweeping along, or Gr. *ραπτα*, to sew, that is, to fasten together, and allied to *reeve*; or Gr. *ραψω*, whence *ραψω*, a flooring. See RAFTER and ROOF.] A sort of float or frame-work formed by various planks of timber fastened together side by side, for the convenience of transporting them down rivers, across harbours, &c., and sometimes for the saving of the lives of persons shipwrecked. The timber and planks with which merchant ships are laden in different parts of the Baltic sea, are attached together in this manner, in order to float them down the rivers, and off to the shipping. Mr. Canning's life-raft for the relief of persons in danger of shipwreck, is a valuable contrivance.

RÄFT, *v. t.* To transport on a raft.

RÄFT,† *pp.* [Sax. *raefian*, to seize, L. *rapio*; *bereafian*, to snatch away, to bereave.] Torn; rent; severed.

RÄFTED, *pp.* Floated down a stream, as planks or pieces of timber fastened together.

RÄFTER, *n.* [Sax. *rafter*; Gr. *ραψω*, to cover; *ραψω*, a roof; Russ. *strop*, a roof.] A roof timber. Rafters, in *building*, are pieces of timber which, standing by pairs on the raising plate, meet in an angle at the top, and form the ribs of the roof of a building. They are of various sorts.—*Common rafters*, those to which the boarding or lathing is attached. [See ROOF.]

RÄFTED, *a.* Built or furnished with rafters.

RÄFTERING, *n.* In *carpentry*, the sawing up of planks of trees for rafters to roof buildings.—2. In *agriculture*, the ploughing half of the land, and turning the grass side of the ploughed furrow on the land that is left unploughed.

RÄFT'ING, *n.* The business of floating rafts.

RÄFT'ING, *ppr.* Floating rafts.

RÄFTSMAN, *n.* A man who manages a raft.

RÄG, *n.* [Sax. *hracod*, torn, ragged; *racian*, to rake; Dan. *rager*, to rake; *ragerie*, old clothes; Sw. *raka*, to shave; *ragg*, rough hair; Gr. *ρακος*, a torn garment, *ρακος*, to tear; *ραγας*, a rupture, a rock, a *crag*; *ραγας*, to tear

asunder; W. *rhwygaw*, to rend. The Spanish has the word in the compounds *andrajo*, a rag, *andrajoso*, ragged; It. *straccio*, a rent, a rag; *stracciare*, to tear; Ar. *charaha* or *garaha*, to tear.] 1. Any piece of cloth torn from the rest; a tattered cloth, torn or worn till its texture is destroyed. Linen and cotton rags are the chief materials of paper.—2 In the plural, garments worn out; proverbially, mean dress.

Drowsiness shall clothe a man with rags; Prov. xxiii.

And virtue, though in rags, will keep me warm.

*Dryden.*

3. A fragment of dress; a remnant.—4. Ragstone,—which see.—5. In *Shak.*, rag is used for *rogue*.

RAGAMUFFIN, n. [Qu. *rag* and Sp. *mofar*, to mock, or It. *mufo*, musty.] A paltry fellow; a mean wretch.

RAG-BOLT, n. An iron pin with barbs on its shank to retain it in its place, chiefly used where a common bolt could not be clinched. It is also called *barb-bolt* and *spring-bolt*.



Rag-bolts.

RAGE, n. [Fr. *rage*, whence *erager*, to enrage; Corn. *arratch*; Arm. *arragi*, *arragein*, to enrage. This belongs to the family of *Rg*, to break or burst forth. See *RAG*. Perhaps Heb. Ch. and Syr.  $\text{רָגַג}$ , *charah*, to grind or gnash the teeth; in Ar. to burn, to break, to crack, to grind the teeth, to be angry. The radical sense of *burn* is in many cases to rage or be violent.] 1. Violent anger accompanied with furious words, gestures, or agitation; anger excited to fury. Passion sometimes rises to rage.

Torment and loud lament and furious rage.

*Milton.*

2. Vehemence or violent exacerbation of any thing painful; as, the rage of pain; the rage of a fever; the rage of hunger or thirst.—3. Fury; extreme violence; as, the rage of a tempest.—4. Enthusiasm; rapture.

Who brought green poesy to her perfect age, And made that art which was a rage. *Cowley.*

5. Extreme eagerness or passion directed to some object; violent desire; as, the rage for money.

You purchase pain with all that joy can give, And die of nothing but a rage to live. *Pope.*

RAGE, v. i. To be furious with anger; to be exasperated to fury; to be violently agitated with passion.

At this he inly raged. *Milton.*

2. To be violent and tumultuous.

Why do the heathen rage? Ps. ii.

3. To be violently driven or agitated; as, the raging sea or winds.—4. To ravage; to prevail without restraint, or with fatal effect; as, the plague rages in Cairo.—5. To be driven with impetuosity; to act or move furiously.

The chariots shall rage in the streets; Nah. ii.

The madding wheels of brazen chariots raged. *Milton.*

6. † To toy wantonly; to sport.

RAGEFUL, a. Full of rage; violent; furious.

RAGERY, † n. Wantonness.

RAGG, n. In *min.*, ragstone,—which see. RAGGED, a. [from *rag*.] Rent or worn into tatters, or till its texture is broken; as, a ragged coat; a ragged sail.—2. Broken with rough edges; uneven; as, a ragged rock.—3. Having

the appearance of being broken or torn; jagged; rough with sharp or irregular points.

The moon appears, when looked upon through a good glass, rude and ragged.

*Burnet.*

4. Wearing tattered clothes; as, a ragged fellow.—5. Rough; rugged.

What shepherd owns those ragged sheep? *Dryden.*

RAGGED ROBIN, n. A British plant of the genus *Lychnis*, the *L. flos-cuculi*, called also meadow-lychnis. It grows in moist meadows. [See *LYCHNIS*.] RAGGEDLY, adv. In a ragged condition.

RAGGEDNESS, n. The state of being dressed in tattered clothes.—2. The state of being rough or broken irregularly; as, the raggedness of a cliff.

RAGING, ppr. [from *rage*.] Acting with violence or fury.—2. a. Furious; impetuous; vehemently driven or agitated; as, the raging sea or tempest.

RAGING, n. Fury; violence; impetuosity; Jonah i.

RAGINGLY, adv. With fury; with violent impetuosity.

RAGLET, n. A rectangular groove

RAGLIN, } cut in stone or brick-work. [Local.]

RAGLINS, n. A term used in the north of England for the slender ceiling joists of a building.

RAGMAN, n. A man who collects or deals in rags, the materials of paper.—2. Anciently, a herald; also a scroll or brief; an indenture.

RAGMAN'S-ROLL, n. The name of the collection of those instruments by which the nobility and gentry of Scotland were constrained to subscribe allegiance to Edward I. of England in 1296, and which were more particularly recorded in four large rolls of parchment, consisting of thirty-five pieces sewed together, kept in the Tower of London. In *diplomatic lan.*, *ragman* imports an indenture or other legal deed executed under the seals of the parties. Hence the origin of the term. RAGGOT, n. [Fr. *ragout*; Arm. *RAGGUT*, } *ragoud*.] A sauce or seasoning for exciting a languid appetite; or a high seasoned dish, prepared with fish, flesh, greens, and the like, stewed with salt, pepper, cloves, &c.

RAGSTONE, or RAGG, n. A stone of the silicious kind, so named from its rough fracture. It is also called *Rowley ragg*, and *Dudley basalt*. It is of a gray colour, the texture obscurely laminar or rather fibrous, the laminae consisting of a congeries of grains of a quartz appearance, coarse and rough. It effervesces with acids, and gives fire with steel. It is used for a whetstone without oil or water, for sharpening coarse cutting tools. It is abundant in Kent, at Newcastle, in Northumberland, and at Rowley in Staffordshire.

RAGULY, } a. In *herf.*, terms used RAGULED, } to express any or RAGULATED, } dinary, that is jagged or notched in an irregular manner. A cross *raguled* seems to be made up of two trunks of trees without their branches, of which they show only the stumps.



A Cross Raguly.

RAG-WHEEL, n. In *machinery*, a wheel having a notched or serrated margin.

RAG'WORK, n. A kind of rubble formed of flat-bedded stones about the thickness of a brick.

RAG'WORT, n. The popular name of various species of the genus *Senecio*, found in Britain. They have received this name from the ragged appearance of the leaves. The common ragwort (*S. Jacobae*) is a perennial composite plant with golden yellow flowers, growing by the sides of rivers, and in wet pastures. [See *GROUNDSEL*.]

RA'IA, n. In *ich.*, the rays or skate, or more correctly, perhaps, *Raidia*, the skate family—a very remarkable family of cartilaginous fishes, resembling in their physiology the shark family much more than any other, and following in their forms the angel-fish or monkfish of that family. [See *RAY*.]

RAI'DE, SEE *RAIA*.

RAIL, n. [G. *riegel*, rail, bolt, or bar; W. *rhai*.] 1. A bar of wood or metal extending from one upright post to another, as in fences.—2. In *arch.*, the horizontal timbers in any piece of framing or panelling. Thus, in a door, the horizontal pieces between which the panels lie are called *rails*, whilst the vertical pieces between which the panels are inserted are called *styles*. The same name is given to those pieces that lie under or over the compartments of balustrades, &c. In short, the term *rails* is applied to all pieces lying in a horizontal direction.—3. A series of posts or balusters connected by cross beams, bars, or rods, for enclosure, &c. More usually termed a *railing*.—4. In a ship, a narrow plank nailed for ornament or security on a ship's upper works; also, a curved piece of timber extending from the bows of a ship to the continuation of its stern, to support the knee of the head, &c.—5. One of the iron beams or girders in a railway on which the wheels of the carriages run. [See *RAILS*.]

RAIL, n. A bird of the genus *Rallus*, consisting of many species. [See *RAILUS*.]

RAIL, n. [Sax. *hragle*, *ragle*, from *urigan*, to put on or cover, to *riy*.] A woman's upper garment; retained in the word *nightrail*.

RAIL, v. i. To inclose with rails.—2. To range in a line.

RAIL, v. i. [D. *rallen*, to jabber; Sp. *ralla*, to grate, to molest; Port. *ralhar*, to swagger, to hector, to huff, to scold. This corresponds nearly with the G. *prahlen*, which may be the same word with a prefix, Eng. to *brawl*, Fr. *brailier*; Sw. *ralla*, to prate; Fr. *railler*, to rally. In Dan. *driller* signifies to drill and to banter.] To utter reproaches; to scoff; to use insolent and reproachful language; to reproach or censure in opprobrious terms; followed by *at* or *against*, formerly by *on*.

And rail at arters he did not understand. *Dryden.*

Lesbia for ever on me rails. *Swift.*

RAILE, † v. i. [Probably Fr. *rouler*, to roll.] To run, gush, flow.

The purple blood eke from the hertes vein, Doune railed right fast in most rufful wise. *Chaucer.*

Large floods of blood adowne their sides did rail. *Spenser.*

RAILER, n. One who scoffs, insults, censures, or reproaches with opprobrious language.

RAILING, ppr. Clamouring with insulting language; uttering reproachful



words.—2. *a.* Expressing reproach; insulting; as, a *railing* accusation; 2 Pet. ii.—3. Inclosing with rails of wood or iron.

**RAILING**, *n.* Reproachful or insolent language; 1 Pet. iii.

**RAILING**, *n.* A fence or barrier of wood or iron constructed of posts and rails.

**RAILINGLY**, *adv.* With scoffing or insulting language.

**RAILLERY**, *n.* (usually pronounced rail'ery.) [Fr. *raillerie*.] Banter; jesting language; good humoured pleasantry or slight satire; satirical merriment.

Let *raillery* be without malice or heat.

*B. Jonson.*

...Studies employed on low objects; the very naming of them is sufficient to turn them into *raillery*.

**RAILLEUR**, *n.* [Fr.] A jester; a mocker; one who turns what is serious into ridicule.

**RAILS**, *n.* The parallel tracks which are laid on railways for the purpose of diminishing the resistance, and restricting the course of the carriage wheels which run upon them; the wheels being guided laterally by flanges projecting from the insides of their tires. They are now almost universally formed of wrought iron bars, (though formerly made sometimes of wood and sometimes of cast iron) laid in continuous and uninterrupted lines, and carried, at short intervals, upon cast iron supports

they are frequently termed *tram roads*, or *tram ways*. The modern railway consists of one or more series of pairs of iron beams or girders called rails, laid parallel to each other, and several feet apart. The width between the rails is called the *gauge*. The *narrow gauge* measures 4 feet 8½ inches between the rails; the *broad gauge* 7 feet. A pair of parallel rails constitutes a *single line* of railway, two pairs, a *double line*, and so on; the width between the lines is generally 6 feet. The rails are supported at a little height above the general surface by iron pedestals called *chairs*, which again are firmly fixed to wooden or stone supports called *sleepers*, placed at intervals and imbedded in the material of the roadway. A railway, in general, approaches as nearly to a straight line between its two extremes or *termini* as the nature of the country and the necessities of the intermediate traffic will permit. It is carried over valleys, either by *embankments* or *viaducts*, and through hills or elevated ground by deep trenches called *cuttings*, or by tunnels. In favourable cases the surface line of the railway is so adjusted that the materials excavated from the cuttings will just serve to form the embankments. Such a line is termed the *balancing line*. Should the excavated material be in excess it is termed *spoil*, and deposited in a convenient place, where it forms a *spoil bank*; but should it be in too small quantity to form the embankment, recourse is had to an excavation along the sides of the site of the latter to supply the deficiency. This is termed *side cutting*. The balancing line or surface line of the railway may or may not be level, and its various slopes are termed *gradients*, and the arrangement of the rises and falls is termed the *grading* of the line. A very steep ascent is termed an *incline*. When the line is formed its surface is covered with broken stones or clean gravel called *ballasting*, and in this the wooden *sleepers*, or stone blocks for sustaining the rails, are imbedded. In their simplest form sleepers are pieces of timber 5 or 6 inches by 9 or 12 inches broad, and 9 or 10 feet long, laid across the line at about 3 feet apart from centre to centre, and to them the chairs which sustain the rails are spiked. Sometimes longitudinal wooden sleepers are used along with the transverse sleepers. These consist of beams laid under the rails and secured to the transverse sleepers. When such are used chairs are frequently dispensed with, the rails being formed with a flange at bottom which is fastened directly to the wooden beam. When the railway is thus completed, the work is called the *permanent way*. In the railway of a single line of rail, it is necessary to make provision for permitting meeting carriages to pass each other by means of *sidings*, which are short additional railways laid at the side of the main line, and so connected with it at each extremity that a carriage can pass into the siding in place of proceeding along the main line. In double lines, in addition to sidings, which are in them also required, it is necessary to provide for carriages crossing from one line to another. The change in the direction of the carriage, in both cases, is effected by switches and turntables. The an-

nexed cut shows a system of rails arranged for the junction of one double line of rails with another, and known as a *main-line junction*.

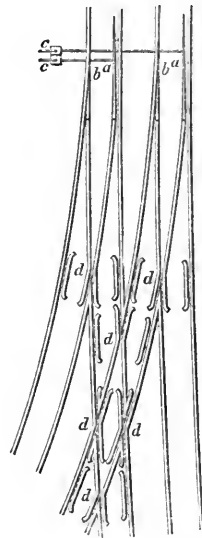

Junction Rails.

*a, b, b', switches or movable rails connected by rods to the reversing handles c, c', a, a', single crossings, the extremities of the rails being formed so as to clear and guide the flanges of the wheels; d, d', double crossings, for the same purpose, with guard or check rails, to assist in guiding the wheels by their flanges through the crossings. [See SWIRREN.]*

The various places along the line of railway, where carriages stop for taking up or depositing goods or passengers, are termed *stations*, with the prefix of *goods* or *passengers*, as they are allotted to the one or the other; and they are termed *road stations*, when they occur at the crossing of a public road, where goods or passengers are transferred to other kinds of conveyance. Where warehouses are attached they are called *dépôts*. At the extremities of the railway, or the *termini*, compartments of the stations are generally allotted to goods and passenger traffic, with branches from the main line carried to each. At stations are *turnplates*, or *turntables*, and other contrivances for removing carriages from one line to another. Either horse or steam power is applied to move the carriages on a railway. When horse power is used, the part between the rails is formed into a road on which the animal walks and drags after it the carriages. Steam power is employed in three different ways. First, the steam engine is mounted on a framework, with wheels made to run upon the rails. The engine is then called a *locomotive engine*, and its pressure on the rails generates a tractive force by which it is enabled to move at a high rate of velocity, and to drag great loads after it. 2nd, A fixed engine is employed to give motion to a rope by which the carriages are dragged along, the rope being either an endless rope stretched over pulleys, or one which winds and unwinds on a cylinder. Such engines are termed *stationary engines*, and are used chiefly on inclined planes, where the ascent is too steep for the locomotive engine. 3rd,

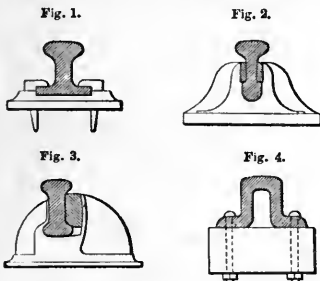

Sections of various forms of Rails.

or *chairs*, resting either upon transverse timber *sleepers* or upon blocks of stone. The annexed figures show some of the most common forms of section of these bars and of their supports. Fig. 4, which is the form employed by Mr. Brunel in the Great Western Railway, rests on continuous longitudinal timber bearings without the intervention of chairs.

**RAILWAY**, *n.* [*rail* and *way*, or *RAILROAD*, *n.* [*road*.] A road or way having parallel tracks along it, formed of wood or iron, on which the wheels of carriages are made to run in order to lessen friction. These tracks were originally formed of wooden beams called rails, and the wheels of the waggons were cylindrical, and had flanges on one side of the periphery, which confined them to the tracks. The wooden rails were succeeded by iron plates, with flanges or upturned ledges along one side, to prevent the wheels leaving them. These were termed *plate rails*, and are now little used, being superseded by the *edge rails* of the modern railway. The wooden rails and plate rails were chiefly used for the accommodation of coal waggons called *trams*, from which circumstance

Engines are placed at intervals along the line, and employed to exhaust the air in a tube laid between the rails by working air-pumps; the tube is fitted with an air tight piston and provided with a longitudinal slit, through which a projection from the piston passes, and can be connected with the carriages outside. The slit is covered with a valve of peculiar construction. When the air is exhausted in the tube in front of the piston the atmospheric pressure forces the piston forward, and along with it the carriages, the valve opening to allow the passage of the projecting connecting part, and closing immediately behind it. This is called the *atmospheric railway*.

**RAIMENT**, *n.* [for *arrayment*; Norm. *araer*, to *array*; *araies*, array, apparel. See **ARRAY** and **RAY**.] 1. Clothing in general; vestments; vesture; garments; Gen. xxiv.; Dent. viii.

Living, both food and *raiment* she supplies. *Dryden.*

2. A single garment. [In this sense it is rarely used, and, indeed, is improper.]

**RÄIN**, *v. i.* [Sax. *hregnan*, *regnan*, *renian*, *rinan*, to rain; D. and G. *regen*, rain; D. *regen*, to rain; Dan. *regn*, rain; *regner*, to rain; G. *beregnet*, to rain on. It seems that *rain* is contracted from *regen*. It is the Gr. *βίβρα*, to rain, to water, which we retain in *brook*, and the Latins, by dropping the prefix, in *rigo*, *irrigo*, to *irrigate*. The primary sense is to pour out, to drive forth, Ar. *baraka*, coinciding with Heb. Ch. and Syr. *barak*.] 1. To fall in drops from the clouds, as water; used mostly with *it* for a nominative; as, *it rains*; *it will rain*; *it rained*, or *it has rained*.—2. To fall or drop like rain; as, tears *rained* at their eyes.

**RÄIN**, *v. i.* To pour or shower down from the upper regions, like rain from the clouds.

Then said the Lord to Moses, Behold, I will *rain* bread from heaven for you; Exod. xvi.

God shall cast the fury of his wrath upon him, and shall *rain* it upon him while he is eating; Job xx.

Upon the wicked he shall *rain* snares, fire, and brimstone, and a horrible tempest; Ps. xi.

**RÄIN**, *n.* [Sax. *regn*, *regn*, *ren*.] The descent of water in drops from the clouds; or the water thus falling. *Rain* is distinguished from *mist*, by the size of the drops, which are distinctly visible. When water falls in very small drops or particles, we call it *mist*, and *fog* is composed of particles so fine as to be not only indistinguishable, but to float or be suspended in the air. *Rain* depends upon the formation and dissolution of clouds. The humidity suspended in the atmosphere, which forms clouds, and is deposited in rain, is derived from the evaporation of water, partly from land, but chiefly from the vast expanse of the ocean. According to Dr. Hutton, the capacity of the air for moisture increases with the temperature, but in a much higher ratio than the temperature; and hence, it follows that, if two equal portions of air at different temperatures, both completely saturated with moisture, are mingled together, a precipitation of rain must take place in consequence of the mixture, which will have the mean temperature of the two portions, being

unable to sustain the mean quantity of vapour. The average quantity of rain which falls in a year at any given place depends on a great variety of circumstances; as, latitude, proximity to the sea; elevation of the region, configuration of the country, and mountain ranges, exposure to the prevailing winds, &c.

**RÄINBAT**, or **RÄINBEAT**, *† a.* Beaten or injured by the rain.

**RÄINBÖW**, *n.* A bow, or an arc of a circle, consisting of all the colours formed by the refraction and reflection of rays of light from drops of rain or vapour, appearing in the part of the hemisphere opposite to the sun. When the sun is at the horizon, the rainbow is a semicircle. The rainbow is called also *iris*. This well known meteor presents, when perfect, the appearance of two concentric arches; the inner being called the *primary*, and the outer the *secondary* rainbow. Each is formed of the colours of the solar spectrum, but the colours are arranged in the reversed order, the red forming the exterior ring of the primary bow, and the interior of the secondary. The primary bow is formed by the sun's rays entering the upper part of the falling drops of rain, and undergoing two refractions and one reflection; and the secondary, by the sun's rays entering the under part of the drops, and undergoing two refractions and two reflections. Hence, the colours of the secondary bow are fainter than those of the primary. The moon sometimes forms a bow or arch of light, more faint than that formed by the sun, and called *lunar rainbow*. Similar bows at sea are called *marine rainbows*, or *sea bows*.

**RÄINBÖWED**, *a.* Formed with a rainbow.

**RÄINBÖW-TINTED**, *a.* Having tints like those of a rainbow.

**RÄIN-DEER**. See **REIN DEER**.

**RÄINE**, *† n.* [Fr. *règne*.] Region. Like as a fearful dove, which through the *raïne* Of the wide ayre her way does cut amaine. *Spenser.*

**RÄIN GAUGE**, *n.* An instrument for measuring or *gauging* the quantity of rain which falls at a given place. *Rain gauges* are variously constructed. One

convenient form consists of a cylindrical tube of copper, with a funnel at the top where the rain enters. Connected with the cylinder at the lower part is a glass tube with an attached scale. The water which enters the funnel, stands at the same height in the cylinder and glass tube, and being visible in the latter the height is read immediately on the scale, and the cylinder and tube being constructed so that the sum of the areas of their sections is a given part, for instance a tenth of the area of the funnel at its orifice, each inch of water in the tube is equivalent to the tenth of an inch of water entering the mouth of the funnel. A stop-cock is added for drawing off the water.

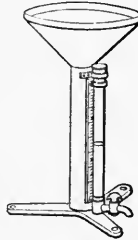

Rain Gauge.

**RÄINNESS**, *n.* [from *rainy*.] The state of being rainy.

**RÄINING**, *ppr.* Pouring or showering down from the upper regions, as water from the clouds.

**RÄINMENT**, *† n.* for *Arraignment*,—which see.

**RÄIN-TIGHT**, *a.* So tight as to exclude rain.

**RÄIN-WÄTER**, *n.* Water that has fallen from the clouds.

**RÄIN WÄTER PIPE**. A pipe usually placed against the exterior of a house to carry off the rain water from the roof.

**RÄINY**, *a.* Abounding with rain; wet; showery; as, *rainy* weather; a *rainy* day or season.

**RÄISE**, *v. t.* (raise.) [Goth. *raisyan*, *ur-raisyan*, to raise, to rouse, to excite; *ur-reisan*, to rise. This word occurs often in the Gothic version of the Gospels, Luke iii. 8; John vi. 40, 44. In Sw. *resa* signifies to go, walk, or travel, and to *raise*; Dan. *rejser*, the same. These verbs appear to be the L. *gradior*, *gressus*, without the prefix; and *gradior* is the Shemitic *רדח*, *redah*, which has a variety of significations, but in Syriac to go, to walk, to pass, as in Latin. Whether the Swedish and Danish verbs are from different roots, blended by usage or accident, or whether the different senses have proceeded from one common signification, to move, to open, to stretch, let the reader judge.] 1. To lift; to take up; to heave; to lift from a low or reclining posture; as, to *raise* a stone or weight; to *raise* the body in bed.

The angel smote Peter on the side and *raised* him up; Acts xii.

2. To set upright; as, to *raise* a mast.

—3. To set up; to erect; to set on its foundations and put together; as, to *raise* the frame of a house.—4. To build; as, to *raise* a city, a fort, a wall, &c.

I will *raise* forts against thee; Is. xxix. Amos ix.

5. To rebuild.

They shall *raise* up the former desolations; Is. lxi.

6. To form to some height by accumulation; as, to *raise* a heap of stones; Josh. viii.—7. To make; to produce; to amass; as, to *raise* a great estate out of small profits.—8. To enlarge; to amplify.—9. To exalt; to elevate in condition; as, to *raise* one from a low estate.—10. To exalt; to advance; to promote in rank or honour; as, to *raise* one to an office of distinction.

This gentleman came to be *raised* to great titles. *Clarendon.*

11. To enhance; to increase; as, to *raise* the value of coin; to *raise* the price of goods.—12. To increase in current value.

The plate pieces of eight were *raised* three pence in the piece. *Temple.*

13. To excite; to put in motion or action; as, to *raise* a tempest or tumult.

He commandeth and *raiseth* the stormy wind; Ps. cvii.

14. To excite to sedition, insurrection, war, or tumult; to stir up; Acts xxiv.

*Aeneas* then employs his pains

In parts remote to *raise* the Tuscan swains. *Dryden.*

15. To rouse; to awake; to stir up.

They shall not awake, nor be *raised* out of their sleep; Job xiv.

16. To increase in strength; to excite from languor or weakness. The pulse is *raised* by stimulants, sometimes by venesection.—17. To give beginning of importance to; to elevate into reputa-

tion; as, to *raise* a family.—18. To bring into being.

God vouchsafes to *raise* another world  
From him. *Milton.*

19. To bring from a state of death to life.

He was delivered for our offences, and *raised* again for our justification; Rom. iv.; 1 Cor. xv.

20. To call into view from the state of separate spirits; as, to *raise* a spirit by spells and incantations.—21. To invent and propagate; to originate; to occasion; as, to *raise* a report or story.—22. To set up; to excite; to begin by loud utterance; as, to *raise* a shout or cry.—23. To utter loudly; to begin to sound or clamour. He *raised* his voice against the measures of administration.—24. To utter with more strength or elevation; to swell. Let the speaker *raise* his voice.—25. To collect; to obtain; to bring into a sum or fund. Government *raises* money by taxes, excise, and imposts. Private persons and companies *raise* money for their enterprises.—26. To levy; to collect; to bring into service; as, to *raise* troops; to *raise* an army.—27. To give rise to.—28. To cause to grow; to procure to be produced or propagated; as, to *raise* wheat, barley, hops, &c. [We now frequently use *grow* in regard to crops; as, to *grow* wheat.]—29. To cause to swell, heave, and become light; as, to *raise* dough or paste by yeast or leaven.

Miss Liddy can dance a jig and *raise* paste.  
*Spectator.*

30. To excite; to animate with fresh vigour; as, to *raise* the spirits or courage.—31. To ordain; to appoint; or to call to and prepare; to furnish with gifts and qualifications suited to a purpose; a *Scriptural* sense.

I will *raise* them up a prophet from among their brethren; Deut. xviii.

For this cause have I *raised* thee up, to show in thee my power; Exod. ix.; Judg. ii 32. To keep in remembrance; Ruth iv.—33. To cause to exist by propagation; Matt. xxii.—34. To incite; to prompt; Ezra i.—35. To increase in intensity or strength; as, to *raise* the heat of a furnace.—36. In *seamen's* lan., to elevate, as an object by a gradual approach to it; to bring to be seen at a greater angle; opposed to *laying*; as, to *raise* the land; to *raise* a point.—To *raise* a purchase, in *seamen's* lan., is to dispose instruments or machines in such a manner as to exert any mechanical force required.—To *raise* a siege, is to remove a besieging army and relinquish an attempt to take the place by that mode of attack, or to cause the attempt to be relinquished.—To *raise* a plan, in *fort.*, to measure with cords, and geometrical instruments, the length of the lines and the angles in order to represent them upon paper, for the purpose of discovering their advantages and disadvantages.—To *raise* a horse, in the *manage*, to make him work at curvets, caprioles, pesades, &c.; also, to place his head right and make him carry well, so that he may not carry low, or arm himself.

RAISED, *pp.* Lifted; elevated; exalted; promoted; set upright; built; made or enlarged; produced; enhanced; excited; restored to life; levied; collected; roused; invented and propagated; increased.

RAISER, *n.* One who raises; that which raises; one that builds; one that levies

or collects; one that begins, produces, or propagates.—2. In *arch.* [See Raiser.]

RAISIN, *n.* (razn.) [Fr. and Ir. *id.*; Arn. *rasin, resin*; D. *rozyn*; G. *rosinc*, a raisin, and *rosinfarbe*, crimson, (raisin-colour;) Dan. *rosin*. In Dan. and Sw. *rosen* signifies the erysipelas. It is evident that the word is from the same root as *red* and *rose*, being named from the colour. See RED and ROSE. This word is in some places pronounced corruptly *reezn*.] A dried grape. Raisins are produced from various species of vines; deriving their names partly from the place where they grow, as Smyrnas, Valencias, &c.; and partly from the species of grape of which they are made, as muscatels, blooms, sultanas, &c. Their quality appears, however, to depend more on the method of their cure than on any thing else. The finest raisins are cured either by cutting the stalk of the bunches half through, when the grapes are nearly ripe, and leaving them suspended on the vine till the sun dries and candies them; or by cutting the grapes when fully ripe, and dipping them in a ley made of the ashes of the burnt tendrils, after which they are exposed to the sun to dry. Those cured in the first way are most esteemed. The inferior sorts are very often dried in ovens.

RAISING, *ppr.* Lifting; elevating; setting upright; exalting; producing; enhancing; restoring to life; collecting; levying; propagating, &c.—*Raising* piece, in *arch.*, a piece of timber laid on a brick wall, or on the top of the posts or puncheons of a timber framed house, to carry a beam or beams. A templet.—*Raising* plate, or *upper* plate, in *arch.*, the plate or longitudinal timber on which the roof stands, or is raised or placed. [Sometimes written *reason* and *reson*.]

RAISING, *n.* The act of lifting, setting up, elevating, exalting, producing, or restoring to life.—2. In *New England*, the operation or work of setting up the frame of a building.

RA'JAH, } *n.* [L. *rex, regis*.] In *India*,  
RA'JA, } a king, prince, chieftain, or nobleman. The name given to the hereditary princes of the Hindoos, who before the subjugation of the country by the Moguls, governed the various countries of Hindostan, as they still continue to do, though they are generally dependent on Great Britain. They belong to the caste of warriors or *Cshatriyas*.

RA'JA MOODA, [young Raja.] Among the *Malays*, a title equivalent to heir-apparent.

RA'JAHSHIP, *n.* The dignity or principality of a rajah.

RAJBANG'SI, *n.* A term which literally signifies descendants of princes, but all over India it is applied to a person of low birth.

RAJ'POOTS, *n.* [from *Raja putra*, the offspring of a king.] In *India*, a name which, strictly speaking, ought to be limited to the higher classes of the military tribe, but which is now assumed on very slender pretences.

RAKE, *n.* [Sax. *raca, race*; G. *rechen*; Ir. *raca*; W. *rhucaci, rhacan*. See the Verb.] An instrument consisting of a head-piece in which teeth are inserted, and a long handle; used for collecting hay, &c.—2. A wooden implement [Fr. *rateau*], shaped like a rake, but not toothed, used by gamblers for drawing money towards the hand.

RAKE, *n.* [Dan. *rakel*; probably from the root of *break*.] A loose, disorderly, vicious man; a man addicted to lewdness and other scandalous vices.

RAKE, *n.* [Sax. *racan*, to reach.] 1. The projection of the upper parts of a ship, at the height of the stem and stern, beyond the extremities of the keel. The distance between a perpendicular line from the extremity of stem or stern to the end of the keel, is the length of the rake; one the *fore-rake*, the other the *rake-aft*.—*Rake* of the *rudder*, the hindermost part of it.—2. The inclination of a mast from a perpendicular direction.—3. The forward inclination of a mill-saw.

RAKE, *v. t.* [Sax. *racian*; Dan. *rager*, to shave, to rake; W. *rhacanu*; Ir. *racam*; G. *rechen*. The D. *harh, harhen*, is our *harrow*, but of the same family, the great family of *breah, crack, L. frico*.] 1. Properly, to scrape; to rub or scratch with something rough; as, to *rake* the ground.—2. To gather with a rake; as, to *rake* hay or barley.—3. To clear with a rake; to smooth with a rake; as, to *rake* a bed in a garden; to *rake* land.—4. To collect or draw together something scattered; to gather by violence; as, to *rake* together wealth; to *rake* together slanderous tales; to *rake* together the rabble of a town.—5. To scour; to search with eagerness all corners of a place.

The statesman *rakes* the town to find a plot. *Swift.*

6. In the *milit. art.*, to enflade; to fire in a direction with the length of any thing; particularly in naval engagements, to *rake* is to cannonade a ship on the stern or head, so that the balls range the whole length of the deck. Hence the phrase, to *rake* a ship fore and aft.—To *rake* up, applied to fire, is to cover the fire with ashes.

RAKE, *v. i.* To scrape; to scratch into for finding something; to search minutely and meanly; as, to *rake* into a dunghill.—2. To search with minute inspection into every part.

One is for *raking* in Chaucer for antiquated words. *Dryden.*

3. To pass with violence or rapidity.

Pas could not stay, but over him did *rake*.  
*Sidney.*

4. To seek by raking; as, to *rake* for oysters.—5. To lead a dissolute, debauched life.—6. In *marine lan.*, to incline from a perpendicular direction; as, a mast *rakes* aft. It is applied to the masts, stem, and stern-post, &c.; the bowsprit, instead of *raking*, is said to *stevee*. Masts generally rake aft, and in peculiar rig, only forward.—7. In *arch.*, to incline from the horizontal, as the two sides of a pediment or the rafters of a roof; to slope.

RAKED, *pp.* Scraped; gathered with a rake; cleaned with a rake; cannonaded fore and aft.

RAKEHELL, *n.* [Dan. *rakel*; now contracted into *rake*; properly *rakel*.] A lewd, dissolute fellow; a debauchee; a rake.

RAKEHELLY, † *a.* Dissolute; wild. RAKE HOT, *v. i.* To steam or reek hot; a term applied to race-horses.

RAKER, *n.* One that rakes.—2. In *bricklaying*, a piece of iron having two knees or angles, dividing it into three parts at right angles to each other, the two end parts being pointed and equally long and standing upon contrary sides of the middle part. Its use is to rake out decayed mortar from the joints of

old walls, in order to replace it with new mortar.

**RAKESHAME**, *n.* A vile dissolute wretch.

**RÄKING**, *ppr.* Scraping; gathering with a rake; cleaning and smoothing with a rake; cannonading in the direction of the length; inclining.

And *raking* chase-guns through our sterns they send. *Dryden.*

2. *a.* That rakes; as, a *raking* fire or shot.—*Raking a horse*, in the *veterinary art*, drawing his ordure with the hand out of the rectum.

**RÄKING**, *n.* The act of using a rake; the act or operation of collecting with a rake, or of cleaning and smoothing with a rake.—2. The space of ground raked at once; or the quantity of hay, &c. collected by once passing the rake.

**RÄKING**, *a.* In *arch.*, inclining from the horizontal.—*Raking mouldings*, those which incline from the horizontal; as, the mouldings of the sloping side of a pediment.—*Raking courses*, diagonal courses of brick laid in the heart of a thick wall between the external or face courses.

**RÄKISH**, *a.* Given to a dissolute life; lewd; debauched.

**RÄKISHLY**, *adv.* In a rakish manner.

**RÄKISHNESS**, *n.* Dissolute practices.

**RÄLLENTAN'DO**. [It.] In *music*, a term indicating that the time of the passage over which it is written is to be gradually decreased.

**RÄLLIANCE**, *n.* Act of rallying.

**RÄLLIDÆ**, *n.* A family of birds belonging to the Grallæ of Linn., and the Grallatores of Illiger. It comprehends the different species of Rails (*Rallus*).

**RÄLLIED**, *pp.* Reunited and reduced to order.—2. Treated with pleasantry.

**RÄLLUS**, *n.* The rails, a genus of stilt birds belonging to Cuvier's macrodactylic or long-toed family. They inhabit sedgy places, the banks of streams, and the moist herbage of corn fields and meadows. The principal species



Water Rail (*Rallus aquaticus*).

are the water-rail (*R. aquaticus*), the land-rail, or corn-crake (*R. crex*), the gigantic rail, which inhabits southern Africa and Australia, and the clapper-rail (*R. crepitans*), a North American bird.

**RÄLLY**, *v. t.* [Fr. *rallier*.] This seems to be a compound of *re*, *ra*, and *lier*, *L. ligo*, to unite.] 1. To reunite; to collect and reduce to order troops dispersed or thrown into confusion.—2. To collect; to recover; to unite; as things scattered.

**RÄLLY**, *v. t.* [Fr. *rallier*. See **RÄLLERY**.] To treat with good humour and pleasantry, or with slight contempt

or satire, according to the nature of the case.

Honeycomb *rallies* me upon a country life. *Addison.*  
Strephon had long confess'd his am'rous pain,  
Which gay Corinna *rallied* with disdain. *Gay.*

**RÄLLY**, *v. i.* To assemble; to unite.

Innumerable parts of matter chased then to rally together and to form themselves into this new world. *Tillotson.*

2. To come back to order.

The Grecians rally and their pow'rs unite. *Dryden.*

3. To use pleasantry or satirical merriment.—4. To resume strength; as, the patient begins to rally.

**RÄLLY**, *n.* The act of bringing disordered troops to their ranks.—2. Exercise of good humour or satirical merriment.

**RÄLLYING**, *ppr.* Reuniting; collecting and reducing to order.—2. Treating with pleasant humour.

**RÄM**, *n.* [Sax. *ram*; D. *ram*; G. *ramm*, but *rammbock*, rambuck, is used. See the Verb.] 1. The male of the sheep or ovine genus; in some parts of England and Scotland called a *top*.—2. In *astr.*, Aries, the sign of the zodiac which the sun enters on the 21st of March, or a constellation of fixed stars in the imagined figure of a ram. It is considered the first of the twelve zodiacal signs.—3. An engine of war, used formerly for battering and demolishing the walls of cities; called a *battering-ram*. [See **BATTERING-RÄM**.]—*Ram's horns*, in *fort.*, the name given by Belidor to the tenailles.—*Ram (hydraulic)*. [See **HYDRAULIC RÄM**.]

**RÄM**, *v. t.* [G. *rammen*; Dan. *ramler*, to ram or drive; *rammer*, to strike, to hit, to touch; W. *ram*, *rkum*, a thrusting, a projection forward. To the same family belong *L. ramus*, a branch, that is, a shoot or thrust, Heb. Ch. and Syr. *ramah*, to throw, to project, Eth. *rami*, to strike; Ar. *ramai*, to shoot, to throw or dart. See **CRÄM**.] 1. To thrust or drive with violence; to force in; to drive down or together; as, to *ram* down a cartridge; to *ram* piles into the earth.—2. To drive, as with a battering-ram.—3. To stuff; to cram.

**RÄM'ADAN**, } *n.* The ninth month  
**RÄM'ADHAN**, } of the Mohammedan  
**RÄHAM'AZAN**, } year. As the Mohammedans reckon by lunar time, it begins each year eleven days earlier than in the preceding year, so that in 33 years it occurs successively in all the seasons. In this month the Mohammedans have their great fast daily, from sunrise to sunset.

**RÄM'ÄGE**, *n.* [L. *ramus*, a branch, whence Fr. *ramage*.] 1. † Branches of trees.—2. The warbling of birds sitting on boughs.—3. [See **RÄMMÄGE**.]

**RÄM'BEH**, *n.* The Malay name of the fruit of the *Pierardia dulcis*; nat. order Sapindaceæ. A tree common in the peninsula of Malacca.

**RÄM'BLE**, *v. i.* [It. *rambengare*, to ramble, to rove; Arm. *rambreal*, to rave; W. *rhempiaw*, to run to an extreme, to be infatuated, and *rhawu*, to rise or reach over, to soar. These seem to be allied to *roam*, *romp*, *rampant*.] 1. To rove; to wander; to walk, ride, or sail from place to place, without any determinate object in view; or to visit many places; to rove carelessly or irregu-

larly; as, to *ramble* about the city; to *ramble* over the country.

Never ask leave to go abroad, for you will be thought an idle *rambling* fellow. *Swift.*

2. To go at large without restraint and without direction.—3. To move without certain direction.

O'er his ample sides, the *rambling* sprays Luxuriant shoot. *Thomson.*

**RÄM'BLE**, *n.* A roving; a wandering; a going or moving from place to place without any determinate business or object; an irregular excursion.

Coming home after a short Christmas *ramble*, I found a letter upon my table. *Swift.*

**RÄM'BLER**, *n.* One that rambles; a rover; a wanderer.

**RÄM'BLING**, *ppr.* Roving; wandering; moving or going irregularly.

**RÄM'BLING**, *n.* A roving; irregular excursion.

**RÄM'BLINGLY**, *adv.* In a rambling manner.

**RÄMBOO'TAN**, } *n.* A fruit of the  
**RÄMBU'TAN**, } Malayan archipelago; genus *Nephelium*, and nat. order Sapindaceæ. It is about the size of a pigeon's egg, and of a red colour. It is said to be rich and of a pleasant acid.

**RÄM'BOOZE**, } *n. †* A drink made of  
**RÄM'BUSE**, } wine, ale, eggs, and sugar in winter, or of wine, milk, sugar, and rose water in summer.

**RÄ'MEAL**, *a.* The same as rameous,—which see.

**RÄMEKIN**, } *n.* [Fr. *ramequin*.] In  
**RÄMEQUINS**, } *cookery*, small slices of bread covered with a farce of cheese and eggs.

**RÄMENTA'CEOUS**, *a.* In *bot.*, covered with ramenta.

**RÄMENTS**, } *n.* [L. *ramenta*, a chip.]  
**RÄMENTA**, } 1. † Scrapings; shavings.—2. In *bot.*, thin brown foliaceous scales, appearing sometimes in great abundance on young shoots, and particularly numerous and highly developed upon the petioles and the backs of the leaves of ferns.

**RÄ'MEOUS**, } *a.* [L. *ramus*, a branch.]  
**RÄ'MEAL**, } In *bot.*, belonging to a branch; growing on or shooting from a branch; as, *rameal* leaves.

**RÄMFEEZ'LED**, *a.* Fatigued; exhausted. [Scotch.]

**RÄMIFICATION**, *n.* [Fr. from L. *ramus*, a branch.] 1. The process of branching or shooting branches from a stem.—2. A branch; a small division proceeding from a main stock or channel; as, the *ramifications* of a family; the *ramifications* of an artery.—3. A division or subdivision; as, the *ramifications* of a subject or scheme.—4. In *bot.*, the manner in which a tree produces its branches or boughs.—5. The production of figures resembling branches.

**RÄMIFIED**, *pp.* Divided into branches.

**RÄMIFY**, *v. t.* [Fr. *ramifier*; L. *ramus*, a branch, and *facio*, to make.] To divide into branches or parts; as, to *ramify* an art, a subject, or scheme.

**RÄMIFY**, *v. i.* To shoot into branches, as, the stem of a plant.

When the asparagus begins to *ramify*. *Arbutinot.*

2. To be divided or subdivided; as a main subject or scheme.

**RÄMIFYING**, *ppr.* Shooting into branches or divisions.

**RÄM'LINE**, *n.* A long line in masting, used to gain a straight middle line on a mast or tree.

**RAMMED**, *pp.* [See **RAM**.] Driven forcibly.

**RAMMER**, *n.* One that rams or drives.—2. An instrument for driving any thing with force; as, a *rammer* for driving stones or piles, or for beating the earth to more solidity.—3. A gunstick; a ramrod; a rod for forcing down the charge of a gun.

**RAMMING**, *ppr.* Driving with force.  
**RAMMISH**, *a.* [Dan. *ram*, bitter, strong scented.] Rank; strong scented.  
**RAMMISHNESS**, *n.* [from *ram*.] Rankness; a strong scent.

**RAMMY**, *a.* Like a ram; strong scented.

**RAMOLLES' CENCE**, *n.* [Fr. *ramollir*.] A softening or mollifying.

**RAMOON**, *n.* A tree of America.  
**RAMOSE**, *a.* [L. *ramosus*, from *RAMOSUS*,] *mus*, a branch.] 1. In *bot.*, branched, as a stem or root; having lateral divisions.—2. Branchy; consisting of branches; full of branches. Applied also to flowers growing on the branches; to peduncles proceeding from a branch, and also to leaves growing on branches when they differ from those on the stems.

**RAMP**, *v. i.* [Fr. *rampier*, to creep; It. *rampa*, a paw; *rampare*, to paw; *rampicure*, to creep; W. *rhamp*, a rise or reach over; *rhamant*, a rising up, a vaulting or springing; *rhamu*, to reach over, to soar, to vault. See **RAMBLE** and **ROMANCE**.] 1. To climb, as a plant; to creep up.

Plants furnished with tendrils catch hold, and so *ramping* on trees, they mount to a great height.

2. To spring; to leap; to bound; to prance; to frolic.

Their bridles they would champ—  
And trampling the fine element, would fiercely *ramp*. *Spenser*.  
Sporting the lion *ramp'd*. *Milton*.

[In the latter sense, the word is usually written and pronounced *romp*; the word being originally pronounced with a broad.]

**RAMP**, *n.* [Fr. *rampe*.] A leap; a spring; a bound.—2. A flight of steps, or a line tangential to the steps. A sloping line or surface.—3. The talus of a fortification which serves as a gentle sloping road to the rampart. Among *masons* ramp also signifies any concave sweep connecting a higher and lower portion of work, as the coping of a wall; and in *hand-railing* it is used in the same sense to denote the concave sweep that connects the higher and lower parts of a railing at a half or quarter pace.

**RAMPAL'LIAN**, *† n.* A mean wreath.  
**RAMP'ANCY**, *n.* [from *rampant*] Excessive growth or practice; excessive prevalence; exuberance; extravagance; as, the *rampancy* of vice.

**RAMP'ANT**, *a.* [Fr. from *rampier*; Sax. *rempend*, headlong. See **RAMP** and **RAMBLE**.] 1. Overgrowing the usual bounds; rank in growth; exuberant; as, *rampant* weeds.—2. Overleaping restraint; as, *rampant* vice.—3. In *her.*, a lion *rampant* is a lion combatant, rearing upon one of his hinder feet, and attacking a man. It differs from *saliant*, which indicates the posture of springing or making a sally.

The lion *rampant* shakes his brinded mane.

*Rampant sejant* is said of the lion when

in a sitting posture with the fore legs raised.—*Rampant passant*, said of a lion when walking with the dexter fore-paw raised somewhat higher than the more *passant* position.—*Rampant*



Rampant.



Rampant gardant.



Rampant regardant.



Rampant sejant.

*gardant*, when the lion stands upright on his hinder legs, looking full-faced.—*Rampant regardant*, when the lion in a rampant position looks behind.—*Rampant arch*, in *arch.*, an arch whose abutments or springings are not on the same level.

**RAMP'ANTLY**, *adv.* In a rampant manner.

**RAMP'ART**, *n.* [Fr. *rempart*; Arm. *rampariz*, *ramparzi*; Fr. *se remparer*, to fence or intrench one's self; It. *riparamento*, from *riparare*, to repair, to defend, to stop; Port. *reparo*; *reparar*, to repair, to parry in defence. Hence we see *rampart* is from L. *reparari*; *re* and *paro*. See **PARRY** and **REPAIR**.] 1. In *fort.*, an elevation or mound of earth round a place, capable of resisting cannon shot, and formed into bastions, curtains, &c. The rampart is built of the earth taken out of the ditch, though the lower part of the outer slope is usually constructed of masonry. The usual height of the rampart is about three fathoms, and its thickness about ten or twelve feet.

No standards from the hostile *ramparts* torn.

2. That which fortifies and defends from assault; that which secures safety.  
**RAMP'ART**, *† v. t.* To fortify with ramparts.

**RAMP'E**, *pp.* In **RAMPED**, } *her.*, broken or separated.

**RAMPHAS'TIDÆ**, *n.* The Toucans, a family of Scansorial birds, comprising, according to Swainson, the genera *Ramphastos*, *Pteroglossus*, *Aulacorhynchus*, and *Scythrops*.

**RAMPHAS'TOS**, *n.* [Gr. *ραμφος*, a beak.] The Toucans, a genus of scansorial birds, and type of the family *Ramphastidae*. They are distinguished by their enormous beak, in some species nearly as thick and as long as the whole body. The birds do not appear to be incommoded by the apparently unwieldy size of the powerful beak, in the use of which they are very expert. Their plumage is brilliant. They are natives of tropical America, living chiefly in small companies in the deep forests;

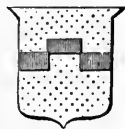

A fesse Rampee.

and are omnivorous, but delight especially in eggs and young birds.



Ramphastos maximus.

**RAMP'ION**, *n.* [from *ramp*.] *Phytentema*, a genus of plants; nat. order *Campanulaceæ*. The round-headed *rampion* (*P. orbiculare*), and spiked *rampion* (*P. spicatum*), are British plants, the roots and young shoots of the latter being occasionally used as an article of food. *Rampion bell-flower* is a plant of the genus *Campanula* (*C. rapunculus*), indigenous to Britain, as well as to various parts of the continent of Europe. Its root may be eaten in a raw state like radish, and is by some esteemed for its pleasant nutty flavour. Both leaves and root may also be cut into winter salads.

**RAMP'IRE**, *n.* The same as *rampart*; but seldom used except in poetry.

The Trojans round the place a *rampire* cast.

*Dryden*.  
**RAMP'PIRED**, *a.* Fortified with a rampart.

**RAMP'ROD**, *n.* The rammer of a gun.  
**RAMP'S HEAD**, *n.* An iron lever for raising up great stones.—2. In *ships*, a great block or pulley into which the ropes called halliards are put.

**RAMP'SONS**, *n.* The *Allium ursinum*, a species of garlic found wild in many parts of Britain, and formerly cultivated in gardens, but its use is now superseded by the *Allium sativum*, which is the garlic now in cultivation.

**RAMP'STAM**, *a.* Forward; thoughtless. [Scotch.]

**RAMP'TIL'LA**, *n.* A genus of Indian plants, *Guizotia oleifera*; nat. order *Compositæ*, and sub-order *Heliantheæ*. It is cultivated for the sake of the seed, from which an oil is expressed, which is used both in dressing food and as a lamp oil.

**RAN**, the *pret.* of *Ran*. In *old writers*, open robbery.

**RAN**, *n.* In *rope-making*, a term used to imply twenty cords of twine wound on a reel, and every cord so parted by a knot as to be easily separated.

**RAN'NA**, *n.* [L. a frog.] The generic name of the tailless *Batrachian* reptiles, which have the hind legs larger than the fore, and webbed toes fitted for swimming, and not expanded at the extremity. It comprehends the frogs and toads.

**RANCE**, *n.* A shore or prop acting as a strut for the support of any thing. [Scotch.]

**RANCE**, *v. t.* To shore or prop.  
**RANCES'CENT**, *a.* [L. *ranceo*, to be rank.] Becoming rancid or sour.

RANCH, † *v. t.* [corrupted from *wrench*.] To sprain; to injure by violent straining or contortion.

RAN'CID, *a.* [*L. rancidus*, from *ranceo*, to be rank. This is the Eng. rank, luxuriant in growth.] Having a rank smell; strong scented; sour; musty; as, *rancid* oil.

RANCID'ITY, } *n.* The quality of be-  
RAN'CIDNESS, } ing rancid; a strong  
sour scent, as of old oil.

The *rancidity* of oils may be analogous to the oxidation of metals. *Ure.*

RAN'COUS, *a.* Deeply malignant; implacably spiteful or malicious; intensely virulent.

So flamed his eyes with rage and *ranc'rous* ire. *Spenser.*

*Rancorous* opposition to the Gospel of Christ. *West.*

RAN'COUSLY, *adv.* With deep malignity or spiteful malice.

RAN'COUR, *n.* [*L.* from *ranceo*, to be rank.] 1. The deepest malignity or spite; deep seated and implacable malice; inveterate enmity. [This is the strongest term for enmity which the English language supplies.] It issues from the *rancour* of a villain. *Shak.*

2. Virulence; corruption.

RAND, † *n.* [*G. D.* and *Dan.* *rand*, a border, edge, brink.] A border; edge; margin; as, the *rand* of a shoe.

RAN'DIA, *n.* A genus of evergreen shrubs, natives chiefly of South America; nat. order *Cinchonaceæ*. The powdered fruit of *R. dumetorum* is a powerful emetic, and an infusion of the bark of the root is administered to nauseate in bowel complaints.

RAN'DOM, *n.* [*Norm. randon*; *Sax. randun*; *Fr. randonné*, a round, or sweeping circuit, made by a hunted animal, ere it is killed, caught, or regains its covert.] 1. A roving motion or course without direction; hence, want of direction, rule, or method; hazard; chance; used in the phrase, *at random*, that is, without a settled point of direction; at hazard.—2. Course; motion; progression; distance of a body thrown; as, the furthest *random* of a missile weapon.

RAN'DOM, *a.* Done at hazard or without settled aim or purpose; left to chance; as, a *random* blow.—2. Uttered or done without previous calculation; as, a *random* guess.—*Random courses*; in *masonry* and *paving*, courses of stones of unequal thickness.—*Random tooling*, forming the face of a stone to a nearly smooth surface by hewing it over with a broad pointed chisel, which produces a series of minute waves at right angles to its path. It is called *droving* in Scotland.

RAN'DOM-SHOT, *n.* A shot not directed to a point, or a shot with the muzzle of the gun elevated above a horizontal line.

RAN'DY, } *n.* A sturdy beggar or  
RAN'DIE, } vagrant; called also a  
Randie beggar; and who exacts alms by threatenings and abusive language.—2. A scold; appropriated to a female, and often applied to an indelicate, romping maiden. [*Scotch.*]

RAN'DY, *a.* Disorderly; riotous. [*Scotch.*]

RANE, }  
RANDEER, } See REINDEER.

RAN'FORCE, † *n.* The ring of a gun next to the vent

RANG, the old *pret.* of *Ring*, but often used for *Rung*.

RÄNGE, *v. t.* [*Fr. ranger*; *W. rhenciau*,

from *rhenc*, *reng*, rank,—which see.]

1. In *arch.*, to set objects so that their edges shall coincide with a given line or surface.—2. To set in a row or in rows; to place in a regular line, lines, or ranks; to dispose in the proper order; as, to *range* troops in a body; to *range* men or ships in the order of battle.—3. To dispose in proper classes, orders, or divisions; as, to *range* plants and animals in genera and species.—4. To dispose in a proper manner; to place in regular method; in a *general sense*. *Range* and *Arrange* are used indifferently in the same sense.—5. To rove over; to pass over.

Teach him to *range* the ditch and force the brake. *Gay.*

[This use is elliptical, *over* being omitted.]—6. To sail or pass in a direction parallel to or near; as, to *range* the coast, that is, *along* the coast.

RÄNGE, *v. i.* To rove at large; to wander without restraint or direction. As a roaring lion and *-ranging* bear;

Prov. xxviii.

2. To be placed in order; to be ranked.

'Tis better to be lowly born,

And *range* with humble livers in content.

*Shak.*

[In this sense, *rank* is now used.]—3.

To lie in a particular direction.

Which way thy forests *range*. *Dryden.*

We say, the front of a house *ranges* with the line of the street.—4. To sail or pass near or in the direction of; as, to *range* along the coast.—5. To pass from one point to another; as, the price of wheat *ranges* between 50s. and 60s.

RÄNGE, *n.* [*Fr. rangée*. See RANK.]

1. A row; a rank; things in a line; as, a *range* of buildings; a *range* of mountains; *ranges* of colours.—2. A class; an order.

The next *range* of beings above him are the immaterial intelligences. *Hale.*

3. A wandering or roving; excursion.—

4. Space or room for excursion.

A man has not enough *range* of thought.

*Addison.*

5. Compass or extent of excursion; space taken in by any thing extended or ranked in order; as, the *range* of Newton's thought. No philosopher has embraced a wider *range*.

Far as creation's ample *range* extends.

*Pope.*

6. The step of a ladder. [Corrupted in popular language to *rung*.]

7. A kitchen grate.—8. A bolting-sieve to sift meal.—9. In *gunnery*, the path of a bullet or bomb, or the line it describes from the mouth of the piece to the point where it lodges, or the whole horizontal distance to which it is carried. When a cannon lies horizontally, it is called the right level, or point blank range; when the muzzle is elevated to 45 degrees, it is called the utmost range. To this may be added the ricochet, the rolling or bounding shot, with the piece elevated from three to six degrees.—10. In *ships*, a certain quantity of cable drawn in upon the deck, equal in length to the depth of water, in order that the anchor, when let go, may reach the bottom without being checked. Also a name given to a large cleat with two arms or branches, bolted in the waist of ships to belay the tacks and sheets to.

RÄNGED, *pp.* Disposed in a row or

line; placed in order; passed in roving; placed in a particular direction.

RÄNGER, *n.* One that ranges; a rover;

a robber. [*Now little used.*]

2. A dog that beats the ground.—3. In *England*, formerly a sworn officer of a forest, appointed by the king's letters patent, whose business was to walk through the forest, watch the deer, prevent trespasses, &c.; but now merely an officer of state.

RÄNGERSHIP, *n.* The office of the keeper of a forest or park.

RÄNGING, *pp.* Placing in a row or

line; disposing in order, method or

classes; roving; passing near and in

the direction of.

RÄNGING, *n.* The act of placing in

lines or in order; a roving, &c.

RANIDÆ, *n.* [*L. rana*, a frog.] The

family of Batrachian reptiles, having

as the type the frog.

RANIN'AIANS, *n.* M. Milne Edwards'

name for a tribe of the family Apteru-

ra, belonging to the section of Anom-

ourous Decapod Crustaceans. They

are found in the Indian seas and the

Isle of France.

RANK, *n.* [*Ir. ranc*; *W. rhenc*; *Fr.*

*rang*, a row or line; *It. rango*, rank,

condition; *Port.* and *Sp. rancho*, a

mess or set of persons; *D. Dan.* and

*G. rang*. In these words, *n* is proba-

bly casual; *Ar. raka*, to set in order;

*Heb.* and *Ch. 𐤓𐤓*, *arak*, *id.* The pri-

mary sense is probably to *reach*, to

*stretch*, or to pass, to stretch along.

Hence *rank* and *grade* are often syn-

onymous.] 1. A row or line, applied to

troops; a line of men standing abreast

or side by side, and as opposed to *file*,

a line running the length of a company,

battalion, or regiment. Keep your

*ranks*; dress your *ranks*.

Fierce fiery warriors fight upon the clouds

In *ranks* and squadrons and right form of

war. *Shak.*

2. *Ranks*, in the plural, the order of

common soldiers; as, to reduce an

officer to the *ranks*.—3. A row; a line

of things, or things in a line; as, a

*rank* of osiers.—4. Degree; grade; in

*military affairs*; as, the *rank* of cap-

tain, colonel, or general; the *rank* of

vice-admiral.—5. Degree of elevation

in civil life or station; the order of

elevation or of subordination. We

say, all *ranks* and orders of men; every

man's dress and behaviour should cor-

respond with his *rank*; the highest

and the lowest *ranks* of men or of

other intelligent beings.—6. Class;

order; division; any portion or num-

ber of things to which place, degree, or

order is assigned. Profligate men, by

their vices, sometimes degrade them-

selves to the *rank* of brutes.—7. De-

gree of dignity, eminence, or excellence;

as, a writer of the first *rank*; a law-

yer of high *rank*.

These are all virtues of a meaner *rank*.

*Addison.*

8. Dignity; high place or degree in

the orders of men; as, a man of *rank*.

—*Rank and file*, the order of common

soldiers. Ten officers and three hun-

dered *rank and file* fell in the action.—

To *fill* the *ranks*, to supply the whole

number, or a competent number.—To

*take rank*, to enjoy precedence, or to

have the right of taking a higher place.

In Great Britain, the sovereign's sons

*take rank* of all the other nobles.

RANK, *a.* [*Sax. ranc*, proud, haughty;

*Sp.* and *It. rancio*; *L. rancidus*, from

*ranceo*, to smell strong. The primary

sense of the root is to advance, to shoot

forward, to grow luxuriantly, whence

the sense of strong, vigorous; *W.*

*rhac, rhag*, before; *rhacu, rhaciaw*, to advance, to put forward. This word belongs probably to the same family as the preceding.] 1. Luxuriant in growth; high-growing; being of vigorous growth; as, *rankgrass*; *rank weeds*.

Seven ears came up upon one stalk, *rank* and good; Gen. xli.

2. Causing vigorous growth; producing luxuriantly; very rich and fertile; as, land is *rank*.—3. Strong-scented; as, *rank* smelling rue.—4. Rancid; musty; as, oil of a *rank* smell.—5. Inflamed with venereal appetite.—6. Strong to the taste; high tasted.

Divers sea fowls taste *rank* of the fish on which they feed.

7. Rampant; high grown; raised to a high degree; excessive; as, *rank* pride; *rank* idolatry.

I do forgive

Thy *rankest* faults.

8. Gross; coarse.—9. Strong; clinching. Take *rank* hold. Hence.—10. Excessive; exceeding the actual value; as, a *rank* modus in law.—*To set rank*, as the iron of a plane, to set it so as to take off a thick shaving.

**RANK**, *adv.* Strongly; fiercely.

**RANK**, *v. t.* To place abreast or in a line.—2. To place in a particular class, order, or division.

Poets were *ranked* in the class of philosophers.

Heresy is *ranked* with idolatry and witchcraft.

3. To dispose methodically; to place in suitable order.

Who now shall rear you to the sun, or *rank* your tribes?

*Ranking* all things under general and special heads.

**RANK**, *v. i.* To be ranged; to be set or disposed; as in a particular degree, class, order, or division.

Let that one article *rank* with the rest.

2. To be placed in a rank or ranks.

Go, *rank* in tribes, and quit the savage wood.

3. To have a certain grade or degree of elevation in the orders of civil or military life. He *ranks* with a major. He *ranks* with the first class of poets.—4. To put in a claim against the estate of a bankrupt person; as, he *ranked* upon the estate.

**RANK'ED**, *pp.* Placed in a line; disposed in an order or class; arranged methodically.

**RANK'ER**, *n.* One that disposes in ranks; one that arranges.

**RANKING**, *ppr.* Placing in ranks or lines; arranging; disposing in orders or classes; having a certain rank or grade.—*Ranking and sale*. In *Scots law*, the action of ranking and sale is the process whereby the heritable property of an insolvent person is judicially sold, and the price divided amongst his creditors, according to their several rights and preferences. This is the most complex and comprehensive process known in the law of Scotland.

**RANK'LE**, *v. i.* [from *rank*.] To grow more rank or strong; to be inflamed; to fester; as, a *rankling* wound.

A malady that burns and *rankles* inward.

2. To become more violent; to be inflamed; to rage; as, *rankling* malice; *rankling* envy. Jealousy *rankles* in the breast.

**RANK'LING**, *n.* The act or process of becoming more virulent.

**RANK'LY**, *adv.* With vigorous growth; as, grass or weeds grow *rankly*.—2. Coarsely; grossly.

**RANK'NESS**, *n.* Vigorous growth; luxuriance; exuberance; as, the *rankness* of plants or herbage.—2. Exuberance; excess; extravagance; as, the *rankness* of pride; the *rankness* of joy.—3. Extraordinary strength.

The crane's pride is in the *rankness* of her wing.

4. Strong taste; as, the *rankness* of flesh or fish.—5. Rancidness; rank smell; as, the *rankness* of oil.—6. Excessiveness; as, the *rankness* of a composition or modus.

**RAN'NY**, *n.* The shrew-mouse.

**RAN'SACK**, *v. t.* [Dan. *randsager*; Sw. *ransaka*; Gaelic, *ransuchadh*. *Rand*, in Danish, is edge, margin, Eng. *rand*, and *ran* is rapine. The last syllable coincides with the English verb to *sack*, to pillage, and in Spanish, this verb, which is written *saquear*, signifies to ransack.] 1. To plunder; to pillage completely; to strip by plundering; as, to *ransack* a house or city.

Their vow is made to *ransack* Troy.

2. To search thoroughly; to enter and search every place or part. It seems often to convey the sense of opening doors and parcels, and turning over things in search; as, to *ransack* files of papers.

I *ransack* the several caverns.

3. † To violate; to ravish; to deflower; as, *ransacked* chastity.

**RAN'SACKED**, *pp.* Pillaged; searched narrowly.

**RAN'SACKING**, *ppr.* Pillaging; searching narrowly.

**RAN'SOM**, *n.* [Dan. *ranzon*; G. *ranzion*; Fr. *rançon*. In French, the word implies not only redemption, but exaction. Qu. Dan. *ran*, a *pillaging*, and G. *sühne*, atonement.] 1. The money or price paid for the redemption of a prisoner or slave, or for goods captured by an enemy; that which procures the release of a prisoner or captive, or of captured property, and restores the one to liberty and the other to the original owner.

By his captivity in Austria, and the heavy *ransom* he paid for his liberty. Richard was hindered from pursuing the conquest of Ireland.

2. Release from captivity, bondage, or the possession of an enemy. They were unable to procure the *ransom* of the prisoners.—3. In *law*, a sum paid for the pardon of some great offence and the discharge of the offender; or a fine paid in lieu of corporeal punishment.—4. In *Script.*, the price paid for a forfeited life, or for delivery or release from capital punishment.

Then he shall give for the *ransom* of his life, whatever is laid upon him; Exod. xxi.

5. The price paid for procuring the pardon of sins and the redemption of the sinner from punishment.

Deliver him from going down to the pit; I have found a *ransom*; Job xxxiii.

The Son of man came...to give his life a *ransom* for many; Matth. xx; Mark x.

**RAN'SÖM**, *v. t.* [Sw. *ransonera*; Fr. *rançonner*.] 1. To redeem from captivity or punishment by paying an equivalent; applied to persons; as, to *ransom* prisoners from an enemy.—2. To redeem from the possession of an enemy by paying a price deemed equivalent; applied to goods or property.

—3. In *Script.*, to redeem from the bondage of sin, and from the punishment to which sinners are subjected by the divine law.

The *ransomed* of the Lord shall return; Is. xxxv.

4. To rescue; to deliver; Hos. xiii.

**RAN'SOMED**, *pp.* Redeemed or rescued from captivity, bondage, or punishment by the payment of an equivalent.

**RAN'SOMER**, *n.* One that redeems.

**RAN'SOMING**, *ppr.* Redeeming from captivity, bondage, or punishment by giving satisfaction to the possessor; rescuing; liberating.

**RAN'SOMLESS**, *a.* Free from ransom.

**RANT**, *v. i.* [Heb. and Ch.  $\text{רָנַן}$ , *ranna*, to cry out, to shout, to sound, groan, murmur; W. *rhonta*, to frisk, to gambol, a sense of the Hebrew also.] To rave in violent, high-sounding, or extravagant language, without correspondent dignity of thought; to be noisy and boisterous in words or declamation; as, a *ranting* preacher.

Look where my *ranting* host of the Garter comes.

**RANT**, *n.* High-sounding language without dignity of thought; boisterous, empty declamation; as, the *rant* of fanatics.

This is stoical *rant*, without any foundation in the nature of man, or reason of things.

**RANT'ER**, *n.* A noisy talker; a boisterous preacher.—2. One of a denomination of Christians which sprang up in 1645. They set up the light of nature under the name of *Christ in men*. They were called *Ranters* by way of reproach, *Seekers* being the name which they assumed. The name *Ranters* is also applied to a sect of Methodists, called *Primitive*, who are disowned by the Wesleys.

**RANT'ERISM**, *n.* The practice or tenets of ranters.

**RANT'ING**, *ppr.* Uttering high sounding words without solid sense; declaiming or preaching with boisterous empty words.

**RAN'T'IPOLE**, † *a.* [from *rant*.] Wild; roving; rakish.

**RAN'T'IPOLE**, † *v. i.* To run about wildly.

**RAN'T'ISM**, *n.* The practice or tenets of ranters.

**RAN'T'Y**, *a.* Wild; noisy; boisterous.

**RAN'ULA**, *n.* [L. from *rana*, a frog, to which it has been said to bear some resemblance.] An inflammatory or indolent tumour under the tongue, which sometimes affects children as well as adults.

**RANUNCULA'CEÆ**, *n.* [*Ranunculus*, one of the genera.] A nat. order of Exogenous polypetalous plants, in almost all cases herbaceous, inhabiting the colder parts of the world, and unknown in hot countries except at considerable elevations. They have usually poisonous qualities, as evinced by aconite and hellebore in particular, the roots of several species of which are drastic purgatives. Some of them are objects of beauty, as the larkspurs, ranunculus, anemone, and peony.

**RANUN'GULUS**, *n.* [L. from *rana*, a frog.] A genus of herbaceous plants, the type of the nat. order Ranunculaceæ. The species are numerous and almost exclusively inhabit the northern hemisphere. Almost all the species are acrid and caustic, and poisonous when taken internally, and, when ex-

ternally applied, will raise blisters, which are followed by deep ulcerations, if left too long. The various species found wild in this country are known by the common names of Crow-foot and Spearwort. *R. flammula*, and *sceleratus*, are powerful epispastics, and are used as such in the Hebrides, producing a blister in about an hour and a half. Beggars use them for the purpose of forming artificial ulcers.

RAP, *v. i.* [Sax. *hrepan*, *hreppan*, to touch; *repan*, to touch, to seize, *L. rapio*; Dan. *rapp*, to snatch away, and *rapp* sig, to hasten; *rap*, a stroke, Sw. *rapp*; Fr. *frapper*, to strike. The primary sense of the root is to rush, to drive forward, to fall on; hence, both to strike and to seize. That the sense is to drive or rush forward, is evident from *L. rapidus*, rapid, from *rapio*.] To strike with a quick sharp blow; to knock; as, to *rap* on the door.

RAP, *v. t.* To strike with a quick blow; to knock.

With one great peal they rap the door.

*Prior.*

To rap out, to utter with sudden violence; as, to rap out an oath. *Addison*. [Sax. *hreapan*, to cry out, that is, to drive out the voice. This is probably of the same family as the preceding word.]

RAP, *v. t.* To seize and bear away, as the mind or thoughts; to transport out of one's self; to affect with ecstasy or rapture; as, *rap* into admiration. I'm *rap* with joy to see my Marcia's tears.

*Addison.*

*Rap* into future times the bard begun.

*Pope.*

2. To snatch or hurry away.

And *rap* with whirling wheels. *Spenser.*  
*Rap* in a chariot drawn by fiery steeds.

*Milton.*

3. To seize by violence.—4. To exchange; to truck. [*Low and not used.*] To rap and rend, to seize and tear or strip; to fall on and plunder; to snatch by violence. They brought off all they could rap and rend. [See *REND*.]

RAP, *n.* A quick smart blow; a knock; as, a rap on the knuckles.—2. A small Swiss copper coin [*rapp*], value a 7th of a penny; hence, not worth a rap.

RAPACIOUS, *a.* [*L. rapax*, from *rapio*, to seize. See *RAF*.] 1. Given to plunder; disposed or accustomed to seize by violence; seizing by force; as, a rapacious enemy.

Well may thy lord, appeased,

Redeem thee quite from death's rapacious claim.

*Milton.*

2. Accustomed to seize for food; subsisting on prey or animals seized by violence; as, a rapacious tiger; a rapacious fowl.

RAPACIOUSLY, *adv.* By rapine; by violent robbery or seizure.

RAPACIOUSNESS, *n.* The quality of being rapacious; disposition to plunder or to exact by oppression.

RAPACITY, *n.* [Fr. *rapacité*; *L. rapacitas*, from *rapax*, *rapio*.] 1. Adictiveness to plunder; the exercise of plunder; the act or practice of seizing by force; as, the rapacity of a conquering army; the rapacity of pirates; the rapacity of a Turkish pasha; the rapacity of extortioners.—2. Ravenousness; as, the rapacity of animals.—3. The act or practice of extorting or exacting by oppressive injustice.—4. Exorbitant greediness of gain.

RAPADU'RA, *n.* [Port.] The name given in Brazil to a kind of native coarse unclarified sugar, which is run into moulds about the size and shape of a common brick. It is much used as an article of food by the inhabitants of the northern provinces.

RAPE, *n.* [*L. rapio*, *raptus*; *W. rhaib*, a snatching; *rhebiaw*, to snatch. See *RAF*.] 1. In a general sense, a seizing by violence; also, a seizing and carrying away by force, as females.—2. In law, the carnal knowledge of a woman forcibly and against her will. Capital punishment for rape was abolished in 1841.—3. Privation; the act of seizing or taking away.

And ruin'd orphans of thy rapet complain.

*Sandys.*

4. Something taken or seized and carried away.

Where now are all my hopes? oh, never more

Shall they revive, nor death her rapet restore.

*Sandys.*

5. Fruit plucked from the cluster.—6. A division of a county in Sussex, in England; or an intermediate division between a hundred and a shire, and containing three or four hundreds. Sussex is divided into six rapes, every one of which, besides its hundreds, has a castle, a river, and a forest belonging to it. The like parts in other counties are called tithings, lathes, or wapentakes.

RAPE, *n.* [*Ir. raib*; *L. rapa*, *rapum*; *Gr. ραπις*; *D. raap*; *G. rübe*.] A plant of the cabbage family, the *Brassica Napus*, Linn. It is cultivated like cole or colza for its seeds, from which oil is extracted by grinding and pressure. It is also extensively cultivated in England for the succulent food which its thick and fleshy stem and leaves supply to sheep when other fodder is scarce. The oil obtained from the seed is used for various economical purposes, for making green soap, for burning in lamps, by clothiers and others; also in medicine, &c. &c. *Rape cake*, a hard cake formed of the residue of the seed and husks, after the oil has been expressed. This is used on the Continent to feed cows and pigs with, as we use the linseed cakes; but it is also used as a rich manure, and for this purpose it is imported in large quantities.

The broom-rape is of the genus *Orobanche*.

RAPE-ROOT. See *RAPE*.

RAPE-SEED, *n.* The seed of the *Brassica Napus*, or the rape, from which oil is expressed.

RAPHANUS, *n.* A cruciferous genus of plants, only remarkable for containing the common radish (*R. sativus*). This plant is a native of China, and has been cultivated in this country for upwards of 250 years. The tender leaves are used as a salad in early spring, the green pods are used as a pickle, and the succulent roots are much esteemed. Sea radish (*R. maritimum*), and field radish (*R. raphanistrum*) are British plants.

RAPHÉ, *n.* [*Gr. ραφή*, a seam or suture.] In *bot.*, the vascular cord communicating between the nucleus of an ovule and the placenta, when the base of the former is removed from the base of the ovulum.—2. In *anat.*, a term applied to parts which look as if they had been sewed or joined together.

RAPHIDES, *n.* [*Gr. ραφίς*.] Certain

needle-like transparent bodies found lying in the tissue of plants. They are crystals of various salts.

RAPHID'IA, *n.* A genus of neuropterous insects belonging to the sector *Filicornes*, and known in this country by the name of snake-fly. The head is of a horny substance and depressed; the tail is armed with a slender horny weapon. It is common in meadows in July.

RAP'ID, *a.* [*L. rapidus*, from *rapio*, the primary sense of which is to rush.] 1. Very swift or quick; moving with celerity; as, a rapid stream; a rapid flight; a rapid motion.

Part shun the goal with rapid wheels.

*Milton.*

2. Advancing with haste or speed; speedy in progression; as, rapid growth; rapid improvement.—3. Of quick utterance of words; as, a rapid speaker.

RAPID'ITY, *n.* [*L. rapiditas*; *Fr. rapidité*, supra.] 1. Swiftmess; celerity; velocity; as, the rapidity of a current; the rapidity of motion of any kind.—2. Haste in utterance; as, the rapidity of speech or pronunciation.—3. Quickness of progression or advance; as, rapidity of growth or improvement.

RAP'IDLY, *adv.* With great speed, celerity, or velocity; swiftly; with quick progression; as, to run rapidly; to grow or improve rapidly.—2. With quick utterance; as, to speak rapidly.

RAP'IDNESS, *n.* Swiftmess; speed; celerity; rapidity.

RAP'IDS, *n. plur.* The part of a river where the current moves with more celerity than the common current. Rapids imply a considerable descent of the earth, but not sufficient to occasion an abrupt fall of the water, or what is called a cascade or cataract.

RA'PIER, *n.* [*Fr. rapide*; *Ir. roipeir*; from thrusting, driving, or quick motion.] A small sword used only in thrusting.

RA'PIER-FISH, *n.* The sword-fish.

RAP'IL, } *n.* Pulverized volcanic

RAP'ILLO, } substances.

RAP'INE, *n.* [*Fr. from L. rapina*; *rapio*, to seize.] 1. The act of plundering; the seizing and carrying away of things by force.—2. Violence; force.

RAP'INE,† *v. t.* To plunder.

RAP'INED,† *pp.* Plundered.

RAP'ING, *a.* In *her.*, a term used when any ravenous animal is borne feeding or devouring its prey.

RAP'LOCH, } *n.* Coarse woollen cloth,

RAP'LOCK, } made from the worst

RAP'LAËH, } kind of wool, home-

spun, and not dyed. As an adjective it signifies coarse. [*Scotch.*]

RAPPAREE,† *n.* A wild Irish plunderer; so called from *rapery*, a half pike that he carried.

RAPPEE, *n.* A coarse kind of snuff.

RAP'PER, *n.* [from *rap*.] One that raps or knocks.—2.† The knocker of a door.—3.† An oath or a lie.

RAP'PORT,† *n.* [*Fr. from re and porter*, to bear.] Relation; proportion.

RAP'T, *pp.* [from *rap*.] Transported; ravished.

RAP'T, *v. t.* To transport or ravish. [*Not legitimate nor in use.*]

RAPT, *n.* An ecstasy; a trance.—2.† Rapidity.

RAPTATO'RES, *n.* Illiger's name for his third order of birds, comprehending the birds of prey. [See *RAPTORES*.]

RAP'TER, } *n.* [*L. raptor*.] A ravisher;

RAP'TOR, } a plunderer.



**RAPTORES**, *n.* [L. *raptor*, a robber.] Rapacious birds, or raveners. The name of the order of birds called *accipitres* by Linnæus and Cuvier, including those which live by rapine, and are characterized by a strong, curved, sharp-edged, and sharp-pointed beak, and robust short legs, with three toes before and one behind, armed with long, strong, and crooked talons. The vultures and falcons are examples.

**RAPT'ORIOUS**, *a.* An epithet applied to birds which dart upon and seize their prey, as the *raptores*. Applied also to certain parts of insects, as legs which are adapted to the seizing of prey.

**RAPTURE**, *n.* [L. *raptus*, *rapio*.] 1. A seizing by violence. [*Little used*.]—2. Transport; ecstasy; violence of a pleasing passion; extreme joy or pleasure.

Music, when thus applied, raises in the mind of the hearer great conceptions; it strengthens devotion and advances praise into *rapture*. *Spectator*.

3. Rapidity with violence; a hurrying along with velocity; as, rolling with torrent *rapture*.—4. Enthusiasm; uncommon heat of imagination.

You grow correct, that once with *rapture* writ. *Pope*.

**RAPTURED**, *a.* Ravished; transported. [But *enraptured* is generally used.]

**RAPTURIST**, *n.* An enthusiast.  
**RAPTUROUS**, *a.* Ecstatic; transporting; ravishing; as, *rapturous* joy, pleasure, or delight.

**RA'RA AVIS**, *n.* [L.] A rare bird; an unusual person; an uncommon object.

**RARE**, *a.* [L. *rarus*, thin; Fr. *rare*; G. and Dan. *rar*.] 1. Uncommon; not frequent; as, a *rare* event; a *rare* phenomenon.—2. Unusually excellent; valuable to a degree seldom found.

*Rare* work, all fill'd with terror and delight. *Cowley*.

Above the rest I judge one beauty *rare*. *Dryden*.

3. Thinly scattered.  
Those *rare* and solitary, these in flocks. *Milton*.

4. Thin; porous; not dense; as, a *rare* and attenuate substance. *Rare*, in *physics*, is a relative term, the reverse of dense; being used to denote a considerable porosity or vacuity between the particles of a body, as the word dense implies a contiguity or closeness of the particles.

Water is nineteen times lighter and by consequence nineteen times *rarer* than gold. *Newton*.

5. [Sax. *hrere*.] Nearly raw; imperfectly roasted or boiled; as, *rare* beef or mutton; eggs roasted *rare*. [See **REAR**.]

**RA'REESHOW**, *n.* [*rare* and *show*.] A rare-show; a peep-show; a show carried about in a box. As these shows were chiefly exhibited by foreigners, they received the name *raree* from the mode in which the exhibitors pronounced the word *rare*.

**RAREFACTION**, *n.* [Fr. See **RAREFY**.] The act or process of expanding or distending bodies, by separating the parts and rendering the bodies more rare or porous, by which operation they appear under a larger bulk, or require more room, without an accession of new matter; or, *rarefaction* is an augmentation of the intervals between the particles of matter, whereby the same number of particles

occupy a larger space. The term is chiefly used in speaking of the æriform fluids, the terms *dilatation* and *expansion* being applied in speaking of solids and liquids. The limits to which rarefaction may be carried are not known; but it has been proved by experiments with the air-pump, that air may be rarefied so as to occupy a volume 13,000 times greater than it occupies under the ordinary pressure. Rarefaction is opposed to *condensation*, and is used in the same sense as dilatation.

**RAREFIABLE**, *a.* Capable of being rarefied.

**RAREFIED**, *pp.* Made thin or less dense.

**RAREFY**, *v. t.* [Fr. *rarefier*; L. *rarefacio*; *rarus*, rare, and *facio*, to make.] To make thin and porous or less dense; to expand or enlarge a body without adding to it any new portion of its own matter; opposed to *condense*.

**RAREFY**, *v. i.* To become thin and porous.

**RAREFYING**, *ppr.* Making thin or less dense.

**RARELY**, *adv.* Seldom; not often; as, things *rarely* seen.—2. Finely; nicely. [*Little used*.]

**RARENESS**, *n.* The state of being uncommon; uncommonness; infrequency.

And let the *rareness* the small gift commend. *Dryden*.

2. Value arising from scarcity.—3. Thinness; tenuity; as, the *rareness* of air or vapour.—4. Distance from each other; thinness.

**RARERIPE**, *a.* [Sax. *araran*, to excite, to hasten.] Early ripe; ripe before others, or before the usual season.

**RARERIPE**, *n.* An early fruit, particularly a kind of peach which ripens early.

**RARITY**, *n.* [Fr. *rareté*; L. *raritas*.] 1. Uncommonness; infrequency.

Far from being fond of a flower for its rarity. *Spectator*.

2. A thing valued for its scarcity.

I saw three *rarities* of different kinds, which pleased me more than any other shows in the place. *Addison*.

3. Thinness; tenuity; opposed to *density*; as, the *rarity* of air.

**RAS'CAL**, *n.* [Sax. *id*.] This word is said to signify a lean beast.] A mean fellow; a scoundrel; in *modern usage*, a trickish dishonest fellow; a rogue; particularly applied to men and boys guilty of the lesser crimes, and indicating less enormity or guilt than *villain*. I have sense to serve my turn in store, And he's a *rascal* who pretends to more. *Dryden*.

2. A plebeian.

My blood Has crept through veins of *rascals* since the Flood. *Pope*.

**RAS'CAL**, *a.* Lean; as, a *rascal* deer.—2. Mean; low.

**RASCALITY**, *n.* 1. In *old authors*, the low mean part of the populace.—2. Mean trickishness or dishonesty; base fraud; the act or acts of a rascal.

**RASCALION**, *n.* [from *rascal*.] A low mean wretch.

**RAS'CALLY**, *a.* Meanly trickish or dishonest; vile.—2. Mean; vile; base; worthless; as, a *rascally* porter.

**RASE**, *v. t.* (*s* as *z*.) [Fr. *raser*; It. *rasare* and *raschiare*; L. *rasus*, *rado*.] With these words accord the W. *rhathu*, to rub off; *rhathell*, a rasp, Eth. *root*, to rub or wipe. See the verb *row*, which is radically the same word If

*g* in *grate* is a prefix, the word is formed on the same radix.] 1. To pass along the surface of a thing, with striking or rubbing it at the same time; to *graze*.

Might not the bullet which *rased* his cheek, have gone into his head?† *South*. 2. To erase; to scratch or rub out; or to blot out; to cancel. [In this sense, *erase* is generally used.]—3. To level with the ground; to overthrow; to destroy; as, to *rase* a city. [In this sense *rase* is generally used. This orthography, *rase*, may therefore be considered as nearly obsolete; *graze*, *erase* and *rase* having superseded it.] **RASE**,† *n.* A cancel; erasure.—2.† A slight wound.

**RASED**. See **RAZED**.

**RASH**, *a.* [D. and G. *rasch*, quick; Sax. *hrad*, *hræd*, *hræth*, quick, hasty, ready, and *hræs*, *ras*, impetus, force, and *hreoasan*, *reasan*, *rasan*, to *rush*. See **READY** and **RUSH**.] The sense is advancing, pushing forward.] 1. Hasty in council or action; precipitate; resolving or entering on a project or measure without due deliberation and caution, and thus encountering unnecessary hazard; applied to persons; as, a *rash* statesman or minister; a *rash* commander.—2. Uttered or undertaken with too much haste or too little reflection; as, *rash* words; *rash* measures.—3. Requiring haste; urgent.

I have scarce leisure to salute you, My matter is so *rash*. *Shak*.

4.† Quick; sudden; as, *rash* gunpowder.

**RASH**, *n.* Corn so dry as to fall out with handling. [*Local*.]

**RASH**, *n.* [It. *raschia*.] 1.† A kind of silk stuff.—2. An eruption or efflorescence on the skin. It consists of red patches on the skin, diffused irregularly over the body. [In Italian, *raschia* is the itch.]

**RASH**, *v. t.* [It. *raschiare*, to scrape or grate; W. *rhâsg*, *rhâsgyl*, *rhâsgliaw*; from the root of *rash*, *graze*.] To slice; to cut into pieces; to divide.

**RASH'ED**, *pp.* Cut into slices; divided.

**RASH'ER**, *n.* In *cooking*, a *rasher* of bacon is a slice of bacon fried, broiled, or toasted.

**RASH'LING**,† *n.* A rash person.

**RASH'LY**, *adv.* With precipitation; hastily; without due deliberation.

He that doth any thing *rashly*, must do it willingly. *L'Estrange*.

So *rashly* brave, to dare the sword of Theseus. *Smith*.

**RASH'NESS**, *n.* Too much haste in resolving or in undertaking a measure; precipitation; inconsiderate readiness or promptness to decide or act, implying disregard of consequences or contempt of danger; applied to persons. The failure of enterprises is often owing to *rashness*.

We offend by *rashness*, which is an affirming or denying before we have sufficiently informed ourselves. *South*.

2. The quality of being uttered or done without due deliberation; as, the *rashness* of words or of undertakings.

**RA'SING**, *n.* Among *ship-carpenters*, the act of marking by the edges of moulds any figure upon timber, &c., with a rasing-knife, or with the points of compasses.—*Rasing-knife*, a small edged-tool fixed in a handle, and used for making particular marks on timber, lead, tin, &c.

**RASO'RES**, *n.* [L. *rado*, to scratch.] Gallinaceous birds or scratchers. The

name of an order of birds, including those which have strong feet, provided with strong claws for scratching up grains, &c., and the upper mandible vaulted, with the nostrils pierced in a



Rasores.

1. Head and foot of Gallus Bankiva. 2. Do. of Common Pheasant. 3. Do. of Wild Turkey. 4. Do. of Common Grouse.

membranous space at its base, and covered by a cartilaginous scale.

**RÄSP**, *n.* [Sw. and D. *rasp*; G. *raspel*; Fr. *rape*, for *raspe*. See RASE.] 1. A species of file on which the cutting prominences are distinct, being raised by punching with a point, instead of cutting with a chisel. It is used in rubbing down the rough edges, or surfaces of different articles of wood and metal that are manufactured.—2. A raspberry,—which see.—3. The rough bark of a tree.

**RÄSP**, *v. t.* [D. *raspen*; Fr. *räper*; W. *rhathell*, in a different dialect. See RASE.] To rub or file with a rasp; to rub or grate with a rough file; as, to *rasp* wood to make it smooth; to *rasp* bones to powder.

**RÄSP**'ATORY, *n.* A surgeon's rasp.

**RÄSP**'BERRY, *n.* [from *rasp*, so named from the roughness of the fruit. G. *kratzebeere*, from *kratzen*, to *scratch*.] The well-known fruit of a plant of the genus *Rubus*, the *R. idaeus*, a native of Britain, and also of various other parts of Europe. The fruit of the raspberry is extensively used in a variety of ways both by the cook and the confectioner, and also in the preparation of cordial spirituous liquors.

**RÄSP**ED, *pp.* Rubbed or filed with a rasp; grated to a fine powder.

**RÄSP**'ER, *n.* A scraper.

**RÄSP**'ING, *ppr.* Filing with a rasp; grating to a fine powder.

**RÄS**URE, *n.* (*s* as *z*.) [L. *rasura*, from *rado*, *rasus*. See RASE.] 1. The act of scraping or shaving; the act of erasing.—2. The mark by which a letter, word, or any part of a writing is erased, effaced, or obliterated; an erasure.

**RAT**, *n.* [Sax. *rat*; G. *ratze*; Fr. *rat*; Sp. *rato*; Port. *id.* a rat, and *ratos*, sharp stones in the sea that wear cables; probably named from gnawing, and from the root of L. *rado*.] A genus of rodent mammalia (*Mus*, Linn.) one or other of the species of which is familiar to every one, and they are

among the greatest animal pests in dwellings, ships, store-houses, and magazines of provisions. Two species are found in habitations in Britain, and in most temperate countries, the black rat (*M. decumanus*), and the brown rat (*M. rattus*). The first is the oldest inhabitant of this country; the other, which was introduced from Asia, and is amazingly prolific, has multiplied at the expense of the black rat.—To smell a rat, to be suspicious, to be on the watch from suspicion; as a cat by the scent or noise of a rat.—To rat, is a cant term of modern use, applied to one who deserts his political party from some interested motive; also, in the workshop, applied to one who takes employment in an establishment while the regular workmen have struck work.

**RÄTABLE**, *a.* [from *rate*.] That may be rated, or set at a certain value; as, a Danish ore *ratable* at two marks.—2. Liable or subjected by law to taxation.

**RÄTABLE**, *adv.* By rate or proportionally; proportionally.

**RÄTÄFY**'A, *n.* [Sp.] A fine spirituous liquor flavoured with the kernels of several kinds of fruits, particularly of cherries, apricots, and peaches. *Rätäfia*, in France, is the generic name of liqueurs compounded with alcohol, sugar, and the odoriferous and flavouring principles of plants.

**RÄTAN**', *n.* [Malay, *rotan*; Java, *rotanang*.] A genus of palms, but widely differing in habit from the rest of that family, and in this respect somewhat resembling the grasses. The species have all perennial, long, round, solid, jointed, unbranching stems, extremely tough and pliable. They grow in profusion along the banks of rivers in tropical Asia and the neighbouring islands. All the species are very useful, and are employed for wicker-work, seats of chairs, walking-sticks, withes and thongs, ropes, cables, &c.

**RÄTANY**, **RÄTANY**, or **RÄTAN**-**HIA**, *n.* The *Krameria triandra* of



Rätany (*Krameria triandra*).

botanists, a half shrubby plant found in Peru, whose root is excessively astringent. It is used medicinally in this country as an astringent medicine in passive bloody or mucous discharges, weakness of the digestive organs, and even in putrid fevers.

**RÄT**'-CATCHER, *n.* One who makes it his business to catch rats.

**RÄTCH**, *n.* In clock work, a sort of wheel having twelve fangs, which serve to lift the detents every hour and thereby cause the clock to strike. In *mech.*, a bar having angular teeth, into

which a paul drops, to prevent machines from being reversed in motion.

**RÄTCH**'ET, *n.* In *mech.*, an arm or piece of mechanism, one extremity of which abuts against the teeth of a ratchet-wheel, called also a *click*, *paul*, or *detent*. [See RÄTCHET-WHEEL.]

**RÄTCH**'ET-WHEEL, *n.* In *mech.*, a wheel with pointed and angular teeth,

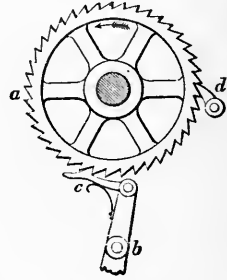

Rätchet-Wheel.

against which a ratchet abuts, used either for converting a reciprocating into a rotatory motion on the shaft to which it is fixed, or for admitting of its motion in one direction only. For both of these purposes, an arrangement similar to that shown in the engraving is employed. *a* is the ratchet-wheel; *b* the reciprocating lever, to the end of which is jointed a small ratchet, *c*, furnished with a catch of the same form as the teeth of the wheel, and which, when the lever is moved in one direction, slides over the teeth, but in returning draws the wheel with it. The other ratchet, *d*, which may either be used separately or in combination with the first, permits of the motion of the wheel in the direction of the arrow, but opposes its return in the opposite direction.

**RÄTCH**'IL, *n.* Among miners, fragments of stone.

**RÄTE**, *n.* [Norm. *rate*; L. *ratus*, *reor*, contracted from *retor*, *redor*, or *resor*. See RATIO and REASON.] 1. The proportion or standard by which quantity or value is adjusted; as, silver valued at the *rate* of six shillings and eightpence the ounce.

The *rate* and standard of wit was different then from what it is in these days.

*South.*  
2. Price or amount stated or fixed on any thing. A king may purchase territory at too dear a *rate*. The *rate* of interest is prescribed by law.—3. Settled allowance; as, a daily *rate* of provisions; 2 Kings xxv.—4. Degree; comparative height or value.

I am a spirit of no common *rate*. *Shak.*  
In this did his holiness and godliness appear above the *rate* and pitch of other men's, in that he was so infinitely merciful. *Calamy.*

5. Degree in which any thing is done. The ship sails at the *rate* of seven knots an hour. A ship's *rate* of sailing is ascertained by means of the log, and half-minute glass.

Many of the horse could not march at that *rate*, nor come up soon enough.

*Clarendon.*  
6. Degree of value; price. Wheat is often sold at the *rate* of sixty shillings the quarter. Wit may be purchased at too dear a *rate*—7. A tax or sum

assessed by authority on property for public use, according to its income or value; as, *poor rates* [see POOR], *high-way rates*. *Church rates*, in England, an assessment levied upon parishioners and occupiers of the land, within a parish, for the purpose of repairing, maintaining, and restoring the body of the church and the belfry, the churchyard fence, the bells, seats, and ornaments, and of defraying the expenses attending the service of the church.—8. In *the navy*, the order or class of a ship, according to its magnitude or force. The navy is divided into three classes. Rate-ships commanded by captains; sloops and vessels by commanders; and the third class by lieutenants. Rate-ships are divided into six classes. [See NAVY.]  
**RATE**, *v. t.* To settle or fix the value, rank, or degree; to estimate, to value, to appraise.  
 You seem not high enough your joys to rate.  
*Dryden.*

Instead of *rating* the man by his performances, we too frequently *rate* the performance by the man.  
*Rambler.*

2. To fix the magnitude, force, or order, as of ships. A ship is *rated* in the first class, or as a ship of the line.

**RATE**, *v. i.* To be set or considered in a class, as a ship. The ship *rates* as a ship of the line.—2. To make an estimate.

**RATE**, *v. t.* [Sw. *rata*, to refuse, to find fault; *ryta*, to roar, to huff; Ice. *retia*, or G. *bereden*, from *reden*, to speak, Sax. *radan*. See READ. It is probably allied to *rattle*, and perhaps to L. *rudo*.] To chide with vehemence; to reprove; to scold; to censure violently.  
 Go, rate thy minions, proud insulting boy.  
*Shak.*

An old lord of the council *rated* me the other day in the street about you, Sir.  
*Shak.*

**RATED**, *pp.* Set at a certain value; estimated; set in a certain order or rank.—2. Chid; reproved.

**RATER**, *n.* One who sets a value on or makes an estimate.

**RATH**, *n.* [Ir. *rath*, a hill, mount, or fortress.] A hill.

**RATH**, *a.* [Sax. *rath*, *ræthe*, *hræth*, *hræthe*, *hræd*, or *hrad*, quick, hasty; Ir. *ratham*, to grow or be prosperous; from the same root as *ready* and *rash*, from the sense of shooting forward. See READY.] Early; coming before others, or before the usual time.  
 Bring the *rath* primrose, that forsaken dies.  
*Milton.*

*Rath ripe*, early ripe.—*Rath ripe barley*, an alteration of the common barley, occasioned by being long cultivated upon warm gravelly soils, so that it ripens a fortnight earlier than common barley under different circumstances.

**RATH**, *adv.* Soon; betimes.

**RATHER**, *adv.* [Sax. *rathor*, *hrathor*; comp. of *rath*, quick, prompt, hasty, *ready*. So we use *sooner* in an equivalent sense. I would *rather* go, or *sooner* go. The use is taken from pushing or moving forward.] 1. More readily or willingly, with better liking; with preference or choice.  
 My soul chooseth strangling, and death rather than life; Job vii.

Light is come into the world, and men loved darkness rather than light, because their deeds were evil; John iii.; Ps. lxxxiv.

2. In preference; preferably; with better reason. Good is *rather* to be  
 11.

chosen than evil. [See Acts v.]—3. In a greater degree than otherwise.  
 He sought throughout the world, but sought in vain,  
 And nowhere finding, *rather* fear'd her slain.  
*Dryden.*

4. More properly, more correctly speaking.

This is an art  
 Which does mend nature, change it *rather*;  
 but  
 The art itself is nature.  
*Shak.*

5. Noting some degree of contrariety in fact.

She was nothing better, but *rather* grew worse; Mark v; Matth xxvii. \*

*The rather*, especially; for better reason; for particular cause.

You are come to me in a happy time,  
*The rather* for I have some sport in hand.  
*Shak.*

*Had rather*, is supposed to be a corruption of *would rather*.

I *had rather* speak five words with my understanding; 1 Cor. xiv.

This phrase may have been originally, "I'd rather," for *I would rather*, and the contraction afterward mistaken for *had*. Correct speakers and writers generally use *would* in all such phrases; *I would rather*, I prefer; I desire in preference.

**RATHOFFITE**, *n.* A mineral brought from Sweden, of the garnet kind. Its colour is a dingy brownish black, and it is accompanied with calcareous spar and small crystals of hornblend.

**RATIFICATION**, *n.* [Fr.; from *ratify*.] The act of ratifying; confirmation.—2. The solemn act by which a competent authority gives validity to an instrument, agreement, &c. The term is ordinarily used in international law for the sanction given by governments to treaties contracted by their representatives. A ratification by a person having attained his majority, is either express or tacit; the latter resulting by implication from his silence for ten years after attaining his majority. *Ratification by a wife*, in *Scots law*, a declaration on oath made by a wife in presence of a judge (her husband being absent), that the deed she has executed has been made freely, and that she has not been induced to make it by her husband through force or fear.

**RATIFIED**, *pp.* Confirmed; sanctioned; made valid.

**RATIFIER**, *n.* He or that which ratifies or sanctions.

**RATIFY**, *v. t.* [Fr. *ratifier*; L. *ratum facio*, to make firm.] 1. To confirm; to establish; to settle.

We have *ratified* to them the borders of Judea; 1 Macc.

2. To approve and sanction; to make valid; as, to *ratify* an agreement or treaty.

**RATIFYING**, *ppr.* Confirming; establishing, approving, and sanctioning.

**RATING**, *ppr.* [from *rate*.] Setting at a certain value; assigning rank to; estimating.—2. Chiding; reproving.

**RATIO**, *n.* (ra'sho.) [L. *ratus*, *reor*, to think or suppose, to set, confirm, or establish. *Reor* is contracted from *redor* or *retor*, and primarily signifies to throw, to thrust, hence to speak, to set in the mind, to think, like L. *suppono*; and *setting* gives the sense of a fixed rate or rule. See REASON.] Proportion, or the relation of homogeneous things which determines the quantity of one from the quantity of another, without the intervention of a

third. In *geom.*, Euclid defines *ratio* to be "a mutual relation of two magnitudes of the same kind to one another in respect of quantity." In arithmetic and algebra, a *ratio* may be defined as the function whose numerator is the antecedent, and denominator the consequent of the ratio. Thus the ratio of 4 to 2 is  $\frac{4}{2}$  or 2; and the ratio of 5 to 6 is  $\frac{5}{6}$ . Also the ratio of A to B is

$\frac{A}{B}$ . In comparing two subjects with regard to some quality which they have in common, and which admits of being measured, that measure is their *ratio*. It is the rate in which one exceeds the other. *Proportion* is the *portions* or parts of one magnitude that are contained in another. When the ratio is commensurable (that is, when it is reducible to numbers), it is equivalent to proportion; but the latter term is usually employed in the comparison of ratios, in which case two equal ratios are said to be proportionals. Thus 3 has to 4 a certain ratio or proportion; but the expression 3 is to 4 in the same proportion as 6 to 8, denotes that the ratios of 3 to 4 and 6 to 8 are equal, 3 being the same proportion of 4 as 6 is of 8; that is, of three-fourths.—*Direct ratio*. When two quantities or magnitudes have a certain ratio to each other, and are at the same time subject to increase or diminution; if while one increases the other increases in the same ratio; or if, while one diminishes, the other diminishes in the same ratio; the proportions or comparisons of ratios remain unaltered, and those quantities or magnitudes are said to be in a *direct ratio* or proportion to each other. Thus in uniform motion the space is in the direct ratio of the time.—*Inverse ratio*. When two quantities or magnitudes are such that when one increases the other necessarily diminishes; and *vice versa*, when the one diminishes the other increases, the ratio or proportion is said to be *inverse*. Thus in uniform motion the time is in the inverse ratio of the velocity.—*Compound ratio*. When one quantity is connected with two others in such a manner that if the first be increased or diminished, the product of the other two is increased or diminished in the same proportion, then the first quantity is said to be in the *compound ratio* of the other two. Thus the momentum of a moving body is in the *compound ratio* of the quantity of matter and the velocity.—*Duplicate ratio*. When three quantities are in continued proportion, the first is said to have to the third the *duplicate ratio* of that which it has to the second, or the first is to the third as the square of the first to the square of the second. Also, when any number of quantities are in continued proportion, the ratio of the first to the last is said to be compounded of the several intermediate ratios. *Ratio* respects magnitudes of the same kind only. One line may be compared with another line, but a line cannot be compared with a superficies, and hence between a line and a superficies there can be no *ratio*.—2. *Prime and ultimate ratios*, terms first introduced, at least in a system, by Newton, who preferred them to the terms suggested by his own method of fluxions. The method of prime and ultimate ratios is a method of calculation which may be considered as an

extension of the ancient method of exhaustions. It may be thus explained: Let there be two variable quantities constantly approaching each other in value, so that their ratio or quotient continually approaches to unity, and at last differs from unity by less than any assignable quantity; the *ultimate ratio* of these two quantities is said to be a ratio of equality. In general, when different variable quantities respectively and simultaneously approach other quantities, considered as invariable, so that the differences between the variable and invariable quantities become at the same time less than any assignable quantity, the ultimate ratios of the variables are the ratios of the invariable quantities or *limits* to which they continually and simultaneously approach. They are called *prime ratios* or *ultimate ratios*, according as the ratios of the variables are considered as receding from, or approaching to, the ratios of the limits. The first section of Newton's *Principia* contains the development of *prime and ultimate ratios*, with various propositions enunciated in their language.

**RATIOCINATE**, *v. t.* [L. *ratiocinor*, from *ratio*, reason.] To reason; to argue. [*Little used.*]

**RATIOCINATION**, *n.* [L. *ratiocinatio*.] The act or process of reasoning, or of deducing consequences from premises. [See **REASONING**.]

**RATIOCINATIVE**, *a.* Argumentative; consisting in the comparison of propositions or facts, and the deduction of inferences from the comparison; as, a *ratiocinative* process. [*A bad word, and little used.*]

**RATIO DECIDENDI**. [L.] In *Scots law*, the reason or ground upon which a judgment is rested.

**RATION**, *n.* [Fr. from L. *ratio*, proportion.] A portion or fixed allowance of provisions, drink, ammunition, and forage, assigned to each soldier in an army for his daily maintenance, and for the maintenance of horses. Officers have several *rations* according to their rank or number of attendants. Seamen in the navy also have *rations* of certain articles.

**RATIONAL**, *a.* [Fr. *rationnel*; L. *rationalis*.] 1. Having reason or the faculty of reasoning; endowed with reason; opposed to *irrational*; as, man is a *rational* being; brutes are not *rational* animals.

It is our glory and happiness to have a *rational* nature.

2. Agreeable to reason; opposed to *absurd*; as, a *rational* conclusion or inference; *rational conduct*.—3. Agreeable to reason; not extravagant.—4. Acting in conformity to reason; wise; judicious; as, a *rational* man.—5. In *arith.* and *alge.*, a term applied to an expression in finite terms; or one on which no extraction of a root is left; or, at least, none such indicated which cannot be actually performed by known processes. The contraries of these are called *surd* or *irrational* quantities. Thus 2, 9, 12, are *rational* quantities, and

$\sqrt{2}$ ,  $\sqrt[3]{4}$ , &c., are *irrational* or *surd* quantities, because their values can only be approximately and not accurately assigned. *Rational* horizon, in *geography*, the plane passing through the centre of the earth parallel to the *sensible horizon* of the place to which it is referred. [See **HORIZON**.]

**RATIONAL**, *n.* A rational being.

**RATIONAL**, *n.* A detail with reasons; a series of reasons assigned; as, Dr. Sparrow's *rational* of the Common Prayer.—2. An account or solution of the principles of some opinion, action, hypothesis, phenomenon, &c.

**RATIONALISM**, *n.* A system of opinions deduced from reason, as distinct from inspiration or opposed to it; the interpretation of Scripture truths upon the principles of human reason, which has become notorious in the present day by the theological systems to which it has given birth in Germany. From the middle of the last century there has arisen in that country a succession of divines—Baumgarten, Michaelis, Semler, Eichhorn, Paulus, Bretschneider, &c., who have endeavoured either to affix a lower and more human character to the invisible operations of God upon men through Christianity, or to reduce the accounts which we have of the foundation of our religion to the mixture of truth and error natural to fallible men. They have questioned the genuineness of almost all the separate parts of Scripture; and the accuracy of all their supernatural narratives. Of late years, however, a much more spiritual conception of the nature of Scripture promises and Christian assistances is observable in the writings of German divines, under the operation of which their theological criticism has already assumed a more wholesome and exalted tone.

**RATIONALIST**, *n.* One who proceeds in his disquisitions and practice wholly upon reason.—2. "*Rationalists* may be said to comprehend those latitudinarians, who consider the supernatural events recorded in the Old and New Testaments, as events happening in the ordinary course of nature, but described by the writers, without any real ground, as supernatural; and who consider the morality of the Scriptures as subject to the test of human reason."

**RATIONALITY**, *n.* The power of reasoning.

God has made *rationality* the common portion of mankind. *Gov. of the Tongue*.  
2. Reasonableness.

Well directed intentions, whose *rationalities* will not bear a rigid examination.

*Brown*.

**RATIONALIZE**, *v. t.* To convert to rationalism.

**RATIONALLY**, *adv.* In consistency with reason; reasonably. We *rationaly* expect every man will pursue his own happiness.

**RATIONALNESS**, *n.* The state of being rational or consistent with reason.

**RATLIN**, *n.* In *ships*, ratlines are **RATLINE**, the small lines which traverse the shrouds horizontally from the deck upwards, thus forming the steps of ladders for going up and down the rigging and masts.

**RATOON**, *n.* [Sp. *retono*; *retonar*, to sprout again.] 1. A sprout from the root of the sugar-cane, which has been cut.—2. The heart leaves in a tobacco plant.

**RATSBANE**, *n.* [*rat* and *bane*.] Poison for rats; arsenous acid.

**RATSBANED**, *a.* Poisoned by ratsbane.

**RAT TAIL**, or **RAT'S TAIL**, *n.* In *furriery*, an excrescence growing from

the pastern to the middle of the shank of a horse.

**RATTAN**. See **RATAN**.

**RATTANY**. See **RATANY**.

**RATTEEN**, *n.* [Sp. *ratina*, ratteen, and a musk mouse.] A thick woollen stuff quilled or twilled.

**RATTINET**, *n.* A woollen stuff thinner than ratteen.

**RATTLE**, *v. i.* [D. *ratelen*, *reutelen*; G. *rasseln*; Gr. *ρεσσα*, *ρεσσαλος*, with a prefix. *Qu. raté*.] 1. To make a quick sharp noise rapidly repeated, by the collision of bodies not very sonorous. When bodies are sonorous, it is called *gingling*. We say, the wheels *rattle* over the pavement.

And the rude hail in *rattling* tempest forms.

*Addison*.

He fagoted his notions as they fell,  
And if they rhymed and *rattled*, all was well.

*Dryden*.

2. To speak eagerly and noisily; to utter words in a clattering manner.

Thus turbulent in *rattling* tone she spoke.

*Dryden*.

He *rattles* it out against popery. *Swift*.  
To *rattle* down the shrouds, in marine language, to fix the ratlines to them, in order to prevent them from slipping down by the weight of the sailors.

**RATTLE**, *v. t.* To cause to make a rattling sound or a rapid succession of sharp sounds; as, to *rattle* a chain.—2. To stun with noise; to drive with sharp sounds rapidly repeated.

Sound but another, and another shall,  
As loud as thine, *rattle* the welkin's ear.

*Shak.*

3. To scold; to rail at clamorously; as, to *rattle* off servants sharply.

**RATTLE**, *n.* A rapid succession of sharp clattering sounds; as, the *rattle* of a drum.—2. A rapid succession of words sharply uttered; loud rapid talk; clamorous chiding.—3. An instrument with which a clattering sound is made; a toy to please children.

The *rattles* of Isis and the cymbals of Brasilea nearly enough resemble each other.

*Raleigh*.

The rhymes and *rattles* of the man or boy.

*Pope*.

4. In *bot.*, the common name of two agricultural weeds found in Britain, belonging to the genus *Pedicularis* or *Lousewort*. [See **LOUSEWORT**.] *Yellow rattle*, a plant of the genus *Rhinanthus*.

**RATTLE-HEADED**, *a.* Noisy; giddy; unsteady.

**RATTLE PATE**, *n.* A noisy empty

**RATTLE SKULL**, *n.* fellow. [*Colloq.*]

**RATTLES**, *n. plur.* The popular name of the croup, or cynanche trachealis of Cullen.—2. The gurgling sound in the windpipe of a dying person.

**RATTLE-SNAKE**, *n.* A snake that has rattles at the tail, of the genus *Crotalus*. The rattles consist of arti-



Rattle-Snake (*Crotalus horridus*).

culated horny cells, which the animal vibrates in such a manner as to make

a rattling sound. The rattle-snake is one of the most deadly of poisonous serpents. The genus is peculiarly American.

**RATTLE-SNAKE-ROOT**, *n.* A plant or root of the genus *Polygala*; and another, of the genus *Prenanthes*.

**RATTLE-SNAKE-WEED**, *n.* A plant of the genus *Eryngium*.

**RATTLING**, *ppr.* Making a quick succession of sharp sounds.

**RATTLING**, *n.* A rapid succession of sharp sounds; Nah. iii.

**RAT TRAP**, *n.* A trap for catching rats.

**RAUCHWA'CKE**, *n.* [Ger.] In *geol.*, one of the calcareous members of the zechstein formation of Germany, the equivalent of the magnesian limestone formation in England.

**RAUCITY**, *n.* [L. *raucus*, hoarse. *Raucus* is the Eng. *rough*,—*which see*.] 1. Hoarseness; a loud rough sound; as, the *raucity* of a trumpet.—2. Among physicians, hoarseness of the human voice.

**RAUCLE**, *a.* [Old Eng. *rahel*, hasty, rash.] Rash, stout, fearless, [Scott.]

**RAUCOUS**, *† a.* Hoarse; harsh.

**RAUGHT**, *†* the old participle of *Reach*.

**RAUNCH**. See **WRENCH**.

**RAVAGE**, *n.* [Fr. from *ravir*, to rob or spoil, L. *rapio*.] 1. Spoil; ruin; waste; destruction by violence, either by men, beasts, or physical causes; as, the *ravage* of a lion; the *ravages* of fire or tempest; the *ravages* of an army.

Would one think 'twere possible for love To make such *ravage* in a noble soul?

*Addison.*

2. Waste; ruin; destruction by decay; as, the *ravages* of time.

**RAVAGE**, *v. t.* [Fr. *ravager*.] 1. To spoil; to plunder; to pillage; to sack.

Already Cesar

Has *ravaged* more than half the globe!

*Addison.*

2. To lay waste by any violent force; as, a flood or inundation *ravages* the meadows.

The shatter'd forest and the *ravaged* vale.

*Thomson.*

3. To waste or destroy by eating; as, fields *ravaged* by swarms of locusts.

**RAVAGED**, *pp.* Wasted; destroyed; pillaged.

**RAVAGER**, *n.* A plunderer; a spoiler; he or that which lays waste.

**RAVAGING**, *ppr.* Plundering; pillaging; laying waste.

**RAVE**, *v. i.* [D. *revelen*, to rave, Eng. to *revel*; L. *rabio*, to rave, to rage or be furious; *rabies*, rage; It. *rabbia*, whence *arrabbiare*, to enrage; Fr. *réver*, if not a contracted word; Dan. *raver*, to reel.] 1. To wander in mind or intellect; to be delirious; to talk irrationally; to be wild.

When men thus *rave*, we may conclude their brains are turned.

*Gov. of the Tongue.*

2. To utter furious exclamations; to be furious or raging; as a madman.

Have I not cause to *rave* and beat my breast?

*Addison.*

3. To dote; to be unreasonably fond; followed by *upon*; as, to *rave upon* antiquity. [*Hardly proper*.]

**RAVEL**, *v. t.* (rav'l.) [D. *raffelen* and *ravelen*. This word is used in opposite senses.] 1. To entangle; to entwine together; to make intricate; to involve; to perplex.

What glory's due to him that could divide Such *ravel'd* int'rests, has the knot untied?

*Waller.*

2. To untwist; to unweave or unknot; to disentangle; as, to *ravel out* a twist; to *ravel out* a stocking.

Sleep, that knits up the *ravel'd* sleeve of care.

*Shak.*

3. † To hurry or run over in confusion.

**RAVEL**, *v. i.* (rav'l.) To fall into perplexity and confusion.

Till by their own perplexities involved, They *ravel* more, still less resolved.

*Millon.*

2. To work in perplexities; to busy one's self with intricacies; to enter by winding and turning.

It will be needless to *ravel* far into the records of elder times.

The humour of *ravelling* into all these mystical or entangled matters...produced infinite disputes.

*Temple.*

3. To be unwoven.

**RAVELIN**, *n.* [Fr. *rid*; It. *ravellino*.] In *fort.*, a work composed of two lines of rampart meeting in a salient angle,

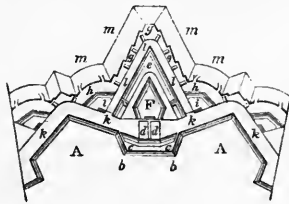

Ravelin.

- |                            |                                   |
|----------------------------|-----------------------------------|
| A, A, Bastions.            | e, g, Covert way.                 |
| b, b, Curtain.             | h, h, Be-entering places of arms. |
| c, c, Tonnelles.           | i, i, Redoubts in do.             |
| d, d, Caponniers.          | k, k, Ditch.                      |
| e, Ravelin.                | l, l, Ditch of Ravelin.           |
| F, Redoubt in the Ravelin. | m, m, m, m, Glacis.               |

and usually constructed beyond the main ditch of a fortress, and in front of the curtain between two bastions.

**RAVELLED**, *pp.* Twisted together; made intricate; disintangled.

**RAVELLING**, *ppr.* Twisting or weaving; untwisting; disintangling.

**RAVEN**, *n.* (ra'vn.) [Sax. *hrafn*, *hrefn* or *raefn*; G. *rabe*; D. *raaf*. Qu. Heb. *oreb*, from its colour. But this may be L. *corvus*. The Saxon orthography would indicate that this fowl is named from pilfering; *hreaflan*, *reaflan*, to plunder, to rob, L. *rapio*.] A large bird of a black colour, of the



Raven (*Corvus corax*),

genus *Corvus*. (*C. corax*, Linn.) Its plumage is entirely black, the tail is rounded, and the back of the upper mandible arcuated near the point. It flies high, scents carrion at the distance of several miles, and feeds also on fruit

and small animals. It is found in every part of the globe.

**RAVEN**, *v. t.* (rav'n.) [G. *rauben*; Sax. *reaflan*, *hreaflan*. But it is more nearly allied to Ar. *raffa*, to eat much, to pluck off in feeding.] 1. To devour with great eagerness; to eat with voracity.

Our natures do pursue, Like rats that *raven* down their proper bane,

A thirsty evil, and when we drink, we die.

*Shak.*

Like a roaring lion *ravening* the prey;

2. To obtain by violence.

**RAVEN**, *v. i.* (rav'n.) To prey with rapacity.

Benjamin shall *raven* as a wolf; Gen. xlix.

**RAVEN**, *n.* (rav'n.) Prey; plunder; food obtained by violence; Nah. ii.—2. Rapine; rapacity.

**RAVENED**, *pp.* Devoured with voracity.

**RAVENER**, *n.* One that ravens or plunders.—2. An order of fowls, as the owl, kite, hawk, and vulture.

**RAVENING**, *ppr.* Preying with rapacity; voraciously devouring; as, a *ravening* wolf.

**RAVENING**, *n.* Eagerness for plunder; Luke xi.

**RAVENOUS**, *a.* Furiously voracious; hungry even to rage; devouring with rapacious eagerness; as, a *ravenous* wolf, lion, or vulture.—2. Eager for prey or gratification; as, *ravenous* appetite or desire.

**RAVENOUSLY**, *adu.* With raging voracity.

**RAVENOUSNESS**, *n.* Extreme voracity; rage for prey; as, the *ravenousness* of a lion.

**RAVEN'S-DUCK**, *n.* [G. *ravenstuck*.] A species of sail cloth.

**RAVEL**, *n.* [from *rave*.] One that raves or is furious.

**RAVET**, *n.* An insect shaped like a cockchafer, which infests the West Indies.

**RAVIN**, *n.* Prey; food got by violence. [See **RAVEN**.]

**RAVIN**, *† a.* Ravenous.

**RAVING**, *n.* Furious exclamation; irrational incoherent talk.

**RAVINE**, *n.* [Fr. *ravin*, from *ravir*, to snatch or tear away.] A long deep hollow worn by a stream or torrent of water; hence, any long deep hollow or pass through mountains, &c.

**RAVING**, *ppr.* or *a.* Furious with delirium; mad; distracted.

**RAVINGLY**, *adv.* With furious wildness or frenzy; with distraction.

**RAVISH**, *v. t.* [Fr. *ravir*; Sax. *hreaflan*; W. *rheibaw*; L. *rapio*.] 1. To seize and carry away by violence.

These hairs which thou dost *ravish* from my chin,

Will quicken and accuse thee.

*Shak.*

This hand shall *ravish* thy pretended right.

*Dryden.*

2. To have carnal knowledge of a woman by force and against her consent; Is. xliii; Zech. xiv.—3. To bear away with joy or delight; to delight to ecstasy; to transport.

Thou hast *ravished* my heart; Cant. iv; Prov. v.

**RAVISHED**, *pp.* Snatched away by violence; forced to submit to carnal embrace; delighted to ecstasy.

**RAVISHER**, *n.* One that takes by violence.—2. One that forces a woman to his carnal embrace.—3. One that transports with delight.

**RAV'ISHING**, *ppr.* Snatching or taking by violence; compelling to submit to carnal intercourse; delighting to ecstasy.—2. *a.* Delighting to rapture; transporting.

**RAV'ISHING**, *n.* A seizing and carrying away by violence.—2. Carnal knowledge by force against consent.—3. Ecstatic delight; transport.

**RAV'ISHINGLY**, *adv.* To extremity of delight.

**RAV'ISHMENT**, *n.* The act of forcing a woman to carnal connection; forcible violation of chastity.—2. Rapture; transport of delight; ecstasy; pleasing violence on the mind or senses.

All things joy with *ravishment*  
Attracted by thy beauty still to gaze.

*Milton.*  
3. The act of carrying away; abduction; as, the *ravishment* of children from their parents, of a ward from his guardian, or of a wife from her husband.

**RAW**, *a.* [Sax. *kræw*, *reaw*; G. *roh*; L. *crudus*; Fr. *crû*; W. *eraw*, blood; *cri*, raw. In the Teutonic dialects, the last radical is lost or sunk to *w* or *h*, but the Saxon initial *h* represents the L. *c*. Ar. *aradza*, to eat or corrode, L. *rado*, also to become raw.] 1. Not altered from its natural state; not roasted, boiled, or cooked; not subdued by heat; as, *raw* meat.—2. Not covered with skin; bare, as flesh.

If there is quick *raw* flesh in the risings, it is an old leprosy; Lev. xiii.

3. Sore.

And all his sinews waxen weak and *raw*  
Through long imprisonment. *Spenser.*

4. Immature; unripe; not concocted.—5. Not altered by heat; not cooked or dressed; being in its natural state; as, *raw* fruit.—6. Unseasoned; inexperienced; unripe in skill; as, people while young and *raw*. So we say, *raw* troops; and new seamen are called *raw* hands.—7. New; untried; as, a *raw* trick.—8. Bleak; chilly; cold; or rather cold and damp; as, a *raw* day; a *raw* cold climate.

Once upon a *raw* and gusty day. *Shak.*

9. † Not distilled; as, *raw* water.—10. Not spun or twisted; not worked up; not manufactured; as *raw* silk, *raw* cotton, *raw* material.—11. Not mixed or adulterated; as, *raw* spirits.—12. Bare of flesh.—13. Not tried or melted and strained; as, *raw* tallow.—14. Not tanned; as, *raw* hides.

**RAW'-BONED**, *a.* Having little flesh on the bones.

**RAW'HEAD**, *n.* The name of a spectre, mentioned to frighten children; as, *rawhead* and bloody bones.

**RAW'ISH**, *a.* Somewhat raw; cool and damp. [Not much used.]

**RAW'LY**, *adv.* In a raw manner.—2. Unskillfully; without experience.—3. Newly.

**RAW'NESS**, *n.* The state of being raw; uncooked; unaltered by heat; as, the *rawness* of flesh.—2. Unskillfulness; state of being inexperienced; as, the *rawness* of seamen or troops.—3. Hasty manner. [Not legitimate.]—4. Chilliness with dampness.

**RAX**, *v. i.* [A. Sax. *raecan*; Suio Goth. *raecha*; Heb. רָחַץ, *rahah*, to extend.] To reach; to extend the bodily members, as one when fatigued or awaking; to stretch, to admit of extension; as, raw leather *razes*. [Scotch.]

**RAX**, *v. t.* To stretch; to extend in a general sense; to stretch out the body; to reach; as, *raz* me that hammer. [Scotch.]

**RAY**, *n.* [Fr. *raie*, *rayon*; It. *razzo*, *raggio*, *radio*; from L. *radius*; W. *rhaiz*; Ir. *riodh*; Sans. *radina*. It coincides with *rod* and *row*, from shooting; extending. Hence in W. *rhaiz* is a spear, as well as a ray.] 1. A line of light, or the right line supposed to be described by a particle of light. A collection of parallel rays constitutes a *beam*; a collection of diverging or converging rays, a *pencil*. The mixed solar beam contains, 1st. *colorific rays*, producing heat and expansion, but not vision and colour; 2nd. *colorific rays*, producing vision and colour, but not heat nor expansion; 3rd. *chemical rays*, producing certain effects on the composition of bodies, but neither heat, expansion, vision, nor colour; 4th. a power producing magnetism, but whether a distinct or associated power, is not determined. It seems to be associated with the *violet*, more than with the other rays. [See LIGHT, PRISMATIC.]—2. Figuratively, a beam of intellectual light.—3. Light; lustre.

The air sharpen'd his visual *ray*. *Milton.*  
4. In *bot.*, the outer part or circumference of a compound radiate flower. A plate of compressed parallelograms of cellular tissue, connecting the texture of the stem, and maintaining a communication between the centre and the circumference.—5. In *ich.*, a bony or cartilaginous ossicle in the fins of fishes, serving to support the membrane.—6. A plant, (*lolium*).—7. † Ray, for *Array*.—*Pencil of rays*, a number of rays of light issuing from a point and diverging.—*Principal ray*, in *persp.*, the perpendicular distance between the eye and the perspective plane.

**RAY**, *n.* [Fr. *raie*; Sp. *raya*; G. *roche*.] Raia, a genus of cartilaginous plagiostomous fishes, recognized by the horizontally flattened body, which resembles a disk, from its union with the extremely broad and fleshy pectorals, which are joined to each other before or to the snout, and which extend behind the two sides of the abdomen, as far as the base of the ventrals, resembling the rays of a fan. In the various subdivisions of this genus we find the sting-ray, spotted torpedo, thornback, skate, &c.



Starry Ray (*Raia radiata*).

**RAY**, *n.* A disease of sheep, called also scab, shah, or rubbers.

**RAY**, *v. t.* To streak; to mark with long lines.—2. † To foul; to beray.—3. † To array.—4. To shoot forth.

**RAYED**, *a.* Having rays; adorned with rays; radiated.—*Rayed* or *Radiated animals*, Radiaries or Radiata,—*which see*.

**RAYLESS**, *a.* Destitute of light; dark; not illuminated.

**RAYONNANT'**, } *a.* In *her.*, the same  
**RAYON'NED**, } as *Radiant*,—*which*  
**RAYON'E'**, } *see*.

**RAZE**, *n.* A root. [See RACE-GINGER, under RACE.]

**RAZE**, *v. t.* [Fr. *raser*; L. *rasus*, *rado*.

See RASE and ERASE.] 1. To subvert from the foundation; to overthrow; to destroy; to demolish; as, to *raze* a city to the ground.—2. To erase; to efface; to obliterate. [In this sense, *rase* and *erase* are now used.]—3. To extirpate. *Shak.*

**RÄZED**, *pp.* Subverted; overthrown; wholly ruined; erased; extirpated. In *her.*, broken, with jagged splinters; termed also *ragged*.

**RAZEE'**, *n.* [Fr.] A ship of war cut down to a smaller size; as, a seventy-four to a frigate, &c.

**RÄZING**, *ppr.* Subverting; destroying; erasing; extirpating.

**RA'ZOR**, *n.* [Fr. *rasoir*; It. *rasoio*; from Fr. *raser*, L. *rasus*, *rado*, to scrape.] An instrument for shaving off beard or hair.—*Razors of a boar*, a boar's tusks.

**RA ZORABLE**, † *a.* Fit to be shaved.

**RA'ZOR-BILL**, *n.* An aquatic fowl,



Razorbill Auk (*Alca torla*).

the *Alca torla*; also, the *Rhynchops nigra* or Cut-water.

**RA'ZORED**, *a.* Formed like a razor.

**RA'ZOR-FISH**, *n.* A species of fish with a compressed body.

**RA'ZOR-SHELLS**, *n.* The vernacular name for the shells of some species of the genus *Solen*.

**RAZURE**, *n.* [Fr. *rasure*; L. *rasura*, from *rado*.] The act of erasing or effacing; obliteration. [See RASURE.]  
**RAZ'ZIA**, *n.* (*räd-zia*.) An Arabic word lately much employed in connection with Algerine affairs, to signify an incursion made by military into an enemy's country, for the purpose of carrying off cattle and destroying the standing crops. It always conveys the idea of pillage. Its meaning is sometimes extended to other sorts of incursions.

**RE**. A prefix from the Latin, denoting iteration; return; repetition. It is contracted from *red*, which the Latins retained in words beginning with a vowel, as in *redamo*, *redeo*, *redintegratio*; Ar. *radda*, to return, restore, bring back, *repl*, to answer. From the Latin or the original Celtic, the Italians, Spanish, and French have their *re*, *ra*, as prefixes. In a few English words, all or most of which, as believed, we receive from the French, it has lost its appropriate signification, as in *rejoice*, *recommend*, *receive*.

**RE**, *n.* In *music*, the name given by the Italians and French to the second note of the diatonic scale, and generally throughout Europe to the second of the syllables used in *soltmization*.

**RE-ABSORB'**, *v. t.* [*re* and *absorb*.] To draw in or imbibe again what has been effused, extravasated, or thrown off; used of fluids; as, to *reabsorb* chyle, lymph, blood, gas, &c.—2. To swallow up again.

**RE-ABSORB'ED**, *pp.* Imbided again.

RE-ABSORB'ING, *ppr.* Reimbibing.  
 RE-ABSORP'TION, *n.* The act or process of imbibing what has been previously thrown off, effused, or extravasated; the swallowing a second time.

RE-ACCESS', *n.* [*re* and *access.*] A second access or approach; a visit renewed.

REACH, *v. t.* *Raught*, the ancient preterite, is obsolete. The verb is now regular; *pp.* *reached*. [*Sax. racan, recan, racan, or hræcan; Ir. righim, roichim; G. reichen, rechen; Gr. ὀφείλω: It. recere, to reach, retch, or vomit; L. rego, to rule or govern, to make right or straight, that is, to strain or stretch, the radical sense. The English sense of reach appears in L. porrigo and porricio. We find in the Shemitic languages, Ch. 22, regag, to desire, to long for; Syr. ragi, and aragi, to desire. This is the Greek ὀφείλω, to reach, to stretch, the radical sense of desiring. The latter Syriac word is the Hebrew 228, arag, to weave; but the primary sense is to stretch or strain. This verb, in Arabic ariga, signifies to send forth a grateful smell, to breathe fragrance, the root of the L. fragro. But the primary sense is the same, to reach, to extend, to shoot forth. The same word in Ethiopic, raga, San. rich'h, signifies to congeal or condense, to make stiff or rigid. This is the L. rigeo, Gr. ψύω, and hence L. frigeo, whence frigid. This sense also is from stretching or drawing, making tense or rigid. The radical sense of 227, raka, is the same, whence region, and the Heb. 227, rahi, the expanse of heaven or the firmament. The L. rogo has the same radical sense, to reach, to urge.] 1. To extend; to stretch; in a general sense; sometimes followed by *out* and *forth*; as, to reach *out* the arm. Hence,—2. To extend to; to touch by extending, either the arm alone, or with an instrument in the hand; as, to reach a book on the shelf; I cannot reach the object with my cane; the seaman reaches the bottom of the river with a pole or a line.—3. To strike from a distance.*

O patron power, thy present aid afford,  
 That I may reach the beast. *Dryden.*

4. To deliver with the hand by extending the arm; to hand. He reached (to) me an orange.

He reached me a full cup; 2 Esdras.

5. To extend or stretch from a distance. Reach hither thy finger. . . reach hither thy hand; John xx.

6. To arrive at; to come to. The ship reached her port in safety. We reached London on Thursday. The letter reached me at seven o'clock.—7. To attain to or arrive at, by effort, labour, or study; hence, to gain or obtain. Every artist should attempt to reach the point of excellence.

The best accounts of the appearances of nature which human penetration can reach, come short of its reality. *Cheyne.*

8. To penetrate to.

Whatever alterations are made in the body, if they reach not the mind, there is no perception. *Locke.*

9. To extend to, so as to include or comprehend in fact or principle.

The law reached the intention of the promoters, and this act fixed the natural price of money. *Locke.*

If these examples of grown men reach not the case of children, let them examine. *Ib.*

10. To extend to.

Thy desire leads to no excess that reaches blame. *Milton.*

11. To extend; to spread abroad. Trees reach'd too far their pamp'rd' boughs. *Ib.*

12. To take with the hand. Lest therefore now his bolder hand Reach also of the tree of life and eat. [*Unusual.*] *Ib.*

13. To overreach; to deceive.

REACH, *v. i.* To be extended.

The new world reaches quite across the torrid zone. *Boyle.*

The border shall descend, and shall reach to the side of the sea of Chimmereth eastward; Num. xxxiv.

And behold, a ladder set on the earth, and the top of it reached to heaven; Gen. xxviii.

2. To penetrate.

Ye have slain them in a rage that reacheth to heaven; 2 Chron. xxviii.

3. To make efforts to vomit. [*See RETCH.*]—To reach after, to make efforts to attain to or obtain.

He would be in a posture of mind, reaching after a positive idea of infinity. *Locke.*

REACH, *n.* In a general sense, extension; a stretching extent.—2. The power of extending to, or of taking by the hand, or by any instrument managed by the hand. The book is not within my reach. The bottom of the sea is not within the reach of a line or cable.—3. Power of attainment or management, or the limit of power, physical or moral. He used all the means within his reach. The causes of phenomena are often beyond the reach of human intellect.

Be sure yourself and your own reach to know, *Pope.*

4. Power intellectual; contrivance; deep thought; effort of the mind in contrivance or research; scheme.

... Drawn by others who had deeper reaches than themselves to matters which they least intended. *Hayward.*

5. A fetch; an artifice to obtain an advantage.

The Duke of Parma had particular reaches and ends of his own underhand, to cross the design. *Bacon.*

6. Tendency to distant consequences.

Strain not my speech  
 To grosser issues, nor to larger reach  
 Than to suspicion. *Shak.*

7. Extent.

And on the left hand, hell  
 With long reach interposed. *Milton.*

8. Among seamen, the distance between two points on the banks of a river, in which the current flows in a straight course.—9. An effort to vomit.

REACHED, *pp.* Stretched out; extended; touched by extending the arm; attained to; obtained.

REACHER, *n.* One that reaches or extends; one that delivers by extending the arm.

REACHING, *ppr.* Stretching out; extending; touching by extension of the arm; attaining to; gaining; making efforts to vomit.

RE-ACT', *v. t.* [*re* and *act.*] To act or perform a second time; as, to react a play. The same scenes were reacted at Rome.

RE-ACT', *v. i.* To return an impulse or impression; to resist the action of another body by an opposite force. Every elastic body reacts on the body that impels it from its natural state.—2. To act in opposition; to resist any influence or power.

RE-ACT'ED, *pp.* Acted or performed a second time.

RE-ACT'ING, *ppr.* Acting again; in physics, resisting the impulse of another body.

RE-ACT'ION, *n.* In physics, counteraction; the resistance made by a body to the action or impulse of another body, which endeavours to change its state, either of motion or rest. It is an axiom in mechanics that "action and reaction are always equal and contrary," or that the mutual actions of two bodies are always equal, and exerted in opposite directions. Thus, in driving a nail with a hammer the stroke acts as powerfully against the face of the hammer as against the head of the nail; and, in pressing the hand upon a stone, the stone presses the hand equally. Also, when two bodies attract or repel each other they approach or recede with equal momenta. [*See ACTION.*]

2. Any action in resisting other action or power.

RE-ACTION WHEEL, *n.* In mech., the reactive force of a stream of water issuing, with greater or less velocity, through hollow curved arms attached to a vertical axis, has been recently applied to a considerable extent as an economical source of power for driving mill-stones and other machinery. Such contrivances are called reaction wheels.

RE-ACT'IVE, *a.* Having power to react; tending to reaction.

RE-ACT'IVELY, *adv.* By reaction.

RE-ACT'IVENESS, *n.* The quality of being reactive.

READ, *n.* [*Sax. red.* See the verb.] 1.† Counsel.—2.† Saying; sentence.

READ, *v. t.* The preterite and *pp.* read, is pronounced *red*. [*Sax. red, read, red, speech, discourse, counsel, advice, knowledge, benefit, reason; radan, redan, to read, to decree, to appoint, to command, to rule or govern, to conjecture, to give or take counsel; arædan, to read, to tell, to narrate; gerædan, to read, to consult; gerad, mode, condition, or state, reason, ratio, or account, knowledge, instruction, or learning, and as an adjective or participle, knowing, instructed, ready, suited; gerad bean, to be ready, to accord or agree; geradod, excited, quick. These significations unite this word with ready,—which see. G. rede, speech, talk, account; reden, to speak; D. rede, speech; reden, reason; Dan. rede, account, and ready; G. bereden, to berate; rath, advice, counsel, a council or senate; rather, to advise, to conjecture or guess, to solve a riddle; D. raad, counsel, advice; raaden, to counsel; Sw. rad, Dan. raad, counsel; rada, raader, to counsel, to instruct; W. rhaiith, straight, right, that is, set right, decision, verdict; rhetheg, rhetoric, from rhaiith; Dan. ret, law, justice, right, reason; Sw. rati, ratta, id.; Ir. radh, a saying; radham, to say, tell, relate; W. adrawez, to tell or rehearse; Gr. ῥητορ, to say or tell, to flow; ῥητορ, a speaker, a rhetorician; Goth. rodyan, to speak. The primary sense of read is to speak, to utter, that is, to push, drive, or advance. This is also the primary sense of ready, that is, prompt or advancing quick. The Sax. gerad, ready, accords also in elements with the W. rhad, L. gratia, the primary sense of which is prompt to favour, advancing towards, free. The elements of these words are the same as those of ride and L. gradior, &c. The sense of reason is secondary, that which is uttered, said,*

or set forth; hence counsel also. The Sw. *raita*, Dan. *ret*, if not contracted words, are from the same root. See **READY**.] 1. To utter or pronounce written or printed words, letters, or characters in the proper order; to repeat the names or utter the sounds customarily annexed to words, letters, or characters; as, to *read* a written or printed discourse; to *read* the letters of an alphabet; to *read* figures; to *read* the notes of music, or to *read* music.—2. To inspect and understand words or characters; to peruse silently; as, to *read* a paper or letter without uttering the words; to *read* to one's self.—3. To discover or understand by characters, marks, or features; as, to *read* a man's thoughts in his countenance.

To *read* the interior structure of the globe. *Journ. of Science.*

An armed course did lie,  
In whose dead face he *read* great magnanimity. *Spenser.*

4. To learn by observation. Those about her  
From her shall *read* the perfect ways of honour. *Shak.*

5. To know fully. Who is't can *read* a woman? *Shak.*

6.† To suppose; to guess; to imagine; to fancy.—7.† To advise.

**READ**, *v. i.* To perform the act of reading.

So they *read* in the book of the law of God distinctly, and gave the sense; Neh. viii.

2. To be studious; to practise much reading.

It is sure that Fleury *reads*. *Taylor.*

3. To learn by reading.—4.† To tell; to declare.—To *read off* is to read aloud, briefly, enumerated particulars; as, the auctioneer *read off* the names of the lots in his catalogue.

**READ**, *pp.* (redd.) Uttered; pronounced, as written words in the proper order; as, the letter was *read* to the family.—2. Silently perused.

**READ**, *a.* (redd.) Instructed or knowing by reading; versed in books; learned. *Well read* is the phrase commonly used; as, *well read* in history; *well read* in the classics.

A poet *well read* in Longinus. *Addison.*

**READABLE**, *a.* That may be read; fit to be read.

**READABLENESS**, *n.* The state of being readable.

**READABLY**, *adv.* So as to be legible.

**RE-ADER'TION**, *n.* [from *L. re* and *aderptus*, obtained.] A regaining; recovery of something lost. [*Not mu. us.*]

**READER**, *n.* One that reads; any person who pronounces written words. In ecclesiastical matters, *reader* is one of the five inferior orders in the Romish church. In the church of England, a *reader* is a deacon appointed to perform divine service in churches and chapels, of which no one has the cure. There are also readers (priests) attached to various eleemosynary and other foundations.—2. In *typography*, a corrector of the press; as, a printer's *reader*.—3. By way of distinction, one that reads much; one studious in books.

**READERSHIP**, *n.* [See **READ**.] The office of reading prayers in a church.

**READILY**, *adv.* (red'yly.) [See **READY**.] Quickly; promptly; easily. I *readily* perceive the distinction you make.—2. Cheerfully; without delay or objection; without reluctance. He *readily* granted my request.

**READINESS**, *n.* (red'iness.) [from

*ready*.] 1. Quickness; promptness; promptitude; facility; freedom from hinderance or obstruction; as, *readiness* of speech; *readiness* of thought; *readiness* of mind in suggesting an answer; *readiness* of reply.—2. Promptitude; cheerfulness; willingness; alacrity; freedom from reluctance; as, to grant a request or assistance with *readiness*.

They received the word with all *readiness* of mind; Acts xvii.

3. A state of preparation; fitness of condition. The troops are in *readiness*.

**READING**, *pp.* Pronouncing or perusing written or printed words or characters of a book or writing.—2. Discovering by marks; understanding.

**READING**, *n.* The act of reading; perusal.—2. Study of books; as, a man of extensive *reading*.—3. A lecture or prelection.—4. Public recital.

The Jews had their weekly *readings* of the law. *Hooker.*

5. In *criticism*, the manner of reading the manuscripts of ancient authors, where the words or letters are obscure. No small part of the business of scholiasts is to settle the true *reading*, or real words used by the author; and the various *readings* of different scholiasts are often perplexing.—6. A commentary or gloss on a law, text, or passage.—7. In *legislation*, the formal recital of a bill by the proper officer, before the house which is to consider it. In *parliament*, a bill must usually have three several *readings* on different days, before it can be passed into a law.

**READING-ROOM**, *n.* A room or apartment furnished with newspapers, periodicals, &c., where people are admitted to read for payment.

**RE-ADJOURN'**, *v. t.* [*re* and *adjourn*.] To adjourn a second time.—2.† To cite or summon again.

**RE-ADJOURN'ED**, *pp.* Adjourned a second time.

**RE-ADJUST'**, *v. t.* [*re* and *adjust*.] To settle again; to put in order again what had been discomposed.

**RE-ADJUST'ED**, *pp.* Adjusted again; resettled.

**RE-ADJUST'ING**, *pp.* Adjusting again.

**RE-ADJUST'MENT**, *n.* A second adjustment.

**RE-ADMIS'SION**, *n.* [*re* and *admission*.]

The act of admitting again what had been excluded; as, the *readmission* of fresh air into an exhausted receiver; the *readmission* of a student into a seminary.

**RE-ADMIT'**, *v. t.* [*re* and *admit*.] To admit again.

Whose ear is ever open and his eye Gracious to *readmit* the suppliant. *Milton.*

**RE-ADMIT'TANCE**, *n.* A second admittance; allowance to enter again.

**RE-ADMIT'TED**, *pp.* Admitted again.

**RE-ADMIT'TING**, *pp.* Allowing to enter again.

**RE-ADOPT'**, *v. t.* [*re* and *adopt*.] To adopt again.

**RE-ADORN'**, *v. t.* To adorn anew; to decorate a second time.

**RE-ADORN'ED**, *pp.* Adorned anew.

**RE-ADVERT'ENCY**, *n.* [*re* and *advertency*.] The act of reviewing.

**READY**, *a.* (red'y.) [Sax. *ræd*, *hræd*, *hræd*, quick, brisk, prompt, ready; *geræd*, prepared, ready, prudent, learned; *hrædian*, *gehrædian*, to hasten, to accelerate; *gerædian*, to make ready; D. *reden*, to prepare; *reed*, pret. of *ryden*,

to ride; *reede*, a road; *bereid*, ready; *bercheiden*, to prepare; *gereed*, ready; G. *berreit*, id.; *berreiten*, to prepare, and to ride; *reede*, a road; Dan. *rede*, ready; *reder*, to make the bed, to rid; *rede*, an account; Sax. *ræd*, from the root of *read*; *bereder*, to prepare; *rid*, *berider*, to ride; Sw. *reda*, to make ready, to clear or disentangle, Eng. to *rid*; *redo*, ready; *rida* to ride; *bereda*, to prepare; Ir. *reidh*, ready; *reidhim*, to prepare, to agree; Gr. *βᾶσις*, easy; W. *rhedu*, to run. The primary sense is to go, move, or advance forward, and it seems to be clear that *ready*, *ride*, *read*, *riddle*, are all of one family, and probably from the root of *L. gradior*. See **READ** and **RED**.] 1. Quick; prompt; not hesitating; as, *ready* wit; a *ready* consent.—2. Quick to receive or comprehend; not slow or dull; as, a *ready* apprehension.—3. Quick in action or execution; dexterous; as, an artist *ready* in his business; a *ready* writer; Ps. xlv.—4. Prompt; not delayed; present in hand. He makes *ready* payment; he pays *ready* money for every thing he buys.—5. Prepared; fitted; furnished with what is necessary, or disposed in a manner suited to the purpose; as, a ship *ready* for sea.

My oxen and fatlings are killed, and all things are *ready*; Matt. xxii.

6. Willing; free; cheerful to do or suffer; not backward or reluctant; as, a prince always *ready* to grant the reasonable requests of his subjects.

The spirit is *ready*, but the flesh is weak; Mark xiv.

I am *ready* not to be bound only, but also to die at Jerusalem for the name of the Lord Jesus; Acts xxi.

7. Willing; disposed. Men are generally *ready* to impute blame to others. They are more *ready* to give than to take reproof.—8. Being at the point; near; not distant; about to do or suffer.

A Syrian *ready* to perish was my father; Deut. xxvi.; Job xxix.; Ps. lxxxviii. 9. Being nearest or at hand.

A sapling pine he wrench'd from out the ground.

The *readiest* weapon that his fury found.

10. Easy; facile; opportune; short; near, or most convenient; the Greek sense, *βᾶσις*.

Sometimes the *readiest* way which a wise man has to conquer, is to flee. *Hooker.* Through the wild desert, not the *readiest* way. *Milton.*

The *ready* way to be thought mad, is to contend you are not so. *Spectator.*

To *make ready*, to prepare; to provide and put in order.—2. An elliptical phrase, for *make things ready*; to make preparations; to prepare.

**READY**, *adv.* (red'y.) In a state of preparation, so as to need no delay.

We ourselves will go *ready* armed before the house of Israel; Num. xxxii.

**READY**, *n.* (red'y.) For *ready money* [*Vulgar*.]

**READY**,† *v. t.* (red'y.) To dispose in order; to prepare.

**READY-MADE**, *a.* Already made; made beforehand, in prospect of being used or sold; as, *ready-made* clothes, by sailors, called *slops*.

**READY-WIT'TED**, *a.* Having ready wit.

**RE-AFFIRM'**, *v. t.* [*re* and *affirm*.] To affirm a second time.

**RE-AFFIRM'ANCE**, *n.* A second confirmation.



RE-AFFIRMED, *pp.* Affirmed a second time.

RE-AFFIRMING, *ppr.* Affirming again.

RE-A'GENT, *n.* [*re* and *agent.*] In *chem.*, a substance employed to detect the presence of other bodies. In chemical analysis, the component parts of bodies may either be ascertained in quantity as well as in quality by the operations of the laboratory, or their quality alone may be detected by the operations of certain bodies called *re-agents*. Thus, the infusion of galls is a reagent which detects iron by a dark purple precipitate; the prussiate of potash is a reagent which exhibits a blue with the same metal, &c.

Bergmann reckons barytic muriate to be one of the most sensible *reagents*. *Fourcroy*.  
RE-AGGRAVATION, *n.* [*re* and *aggravation.*] In the *Romish eccles. law*, the last monetary, published after three admonitions and before the last excommunication. Before proceeding to fulfilminate the last excommunication, an aggravation and a reagravation are published.

REAK, † *n.* A *rush*.

REAL, *a.* [Low *L. realis*; *Sp. real*; *Fr. reel*; from *L. res, rei*, *Ir. raod, rod*. *Res* is from the root of *read*, *ready*, from rushing, driving, or falling. *Res*, like *thing*, is primarily that which comes, falls out, or happens, corresponding with *event*, from *L. evento*. *Res* then denotes that which actually exists. The *L. res* and *Eng. thing* coincide exactly in signification with the *Heb. דבר, dabar*, a word, a thing, an event. See READ and THING.] 1. Actually being or existing; not fictitious or imaginary; as, a description of *real life*. The author describes a *real scene* or transaction.—2. True; genuine; not artificial, counterfeit, or factitious; as, *real Madeira wine*; *real ginger*.—3. True; genuine; not affected; not assumed. The woman appears in her *real character*.—4. Relating to things, not to persons; not personal.

Many are perfect in men's humours, that are not greatly capable of the *real part* of business. [*Little used or obsolete.*] *Bacon*.

5. In *law*, pertaining to things fixed, permanent, or immovable, as to lands and tenements; as, *real estate*, opposed to *personal or movable property*.—*Real property*, is commonly said to consist in lands, tenements, and hereditaments. It is legally distinguished from *personality*, principally in two respects: first, its permanent, fixed, and immovable quality; and secondly, that the interest therein must be not less than the term of the life of the owner, or of another person or persons; whereas, *personality* is either movable or readily capable of being so; or, as in the case of a lease for years, is considered as of so inferior a nature that it is not allowed the incidents and privileges of *real property*.—*Real action*, in *law*, is an action which concerns *real property*.—*Real assets*, assets consisting in *real estate*, or lands and tenements descending to an heir, sufficient to answer the charges upon the estate created by the ancestor.—*Chattels real* are such chattels as concern or savour of the *reality*; as a term for years of land, the next presentation to a church, &c.—*Real composition* is when an agreement is made between the owner of lands and the parson or vicar, with consent of the ordinary, that such lands shall be dis-

charged from payment of tithes, in consequence of other land or recompense given to the parson in lieu and satisfaction thereof.—*Real presence*, in the *Romish church*, the alleged actual presence of the body and blood of Christ in the eucharist, or the conversion of the substance of the bread and wine into the *real body* and blood of Christ.—*Real burden*, in *Scots law*, a burden in money imposed on the subject of a right, as on an estate, in the deed by which the right is constituted, and thus distinguished from a *personal burden*, which is imposed merely on the receiver of the right.—*A real action*, in *Scots law*, is founded on a right of property in a subject; the object of the action being the recovery of the property. It is so termed in contradistinction to a *personal action*, which is founded only on a *personal obligation*, and the object of which is to enforce implement of the obligation.—*Real right*, in *Scots law*, a right of property in a subject, or as it is termed a *jus in re*, in virtue of which the person vested with the *real right* may pursue for possession of the subject. [See PERSONAL.]

REAL, } *n.* A scholastic philosopher, who maintains that things and not words, are the objects of dialectics; opposed to *nominal* or *nominalist*. Under the denomination of *Realists* were comprehended the Scotists and Thomists, and all other sects of schoolmen, except the followers of Occam and Abelard, who were nominalists. Among *school divines*, the term has been sometimes used to distinguish the orthodox Trinitarians from the Socinians and Sabellians.

REAL, *n.* [*Sp.*] The name of a Spanish coin, either of silver or mixed metal. When of the former, it is worth about 5*d.*; if the latter (called *billon*), only 2*d.* It is sometimes written *rial*.

REALGAR, *n.* [*Fr. reagal* or *realgal*; *Port. rosalgar*, red algar.] A combination of sulphur and arsenic in equal equivalents; red sulphuret of arsenic, which is found native. *Realgar* differs from *orpiment* in the circumstance that *orpiment* is composed of two equivalents of arsenic and three of sulphur.

REALISM, *n.* In *philosophy*, the opposite of *Idealism*; that philosophical system which conceives external things to exist independently of our conceptions of them; but realism becomes materialism, if it considers matter or physical substance, as the only original cause of things, and the soul itself as a material substance.

REALITY, *n.* [*Fr. réalité.*] 1. Actual being or existence of any thing; truth; fact; in distinction from mere appearance.

A man may fancy he understands a critic, when in *reality* he does not comprehend his meaning. *Addison*.

2. Something intrinsically important, not merely matter of show.

And to *realities* yield all her shows.

*Milton*.

3. In *scholastic philosophy*, that may exist of itself, or which has a full and absolute being of itself, and is not considered as a part of any thing else.—

4. In *law*, immobility, or the fixed, permanent nature of property; as, *chattels which savour of the reality*. [This word *reality* is so written in *law*, for *reality*.]

REALIZABLE, *a.* That may be realized.

REALIZATION, *n.* [from *realize*.]

The act of realizing or making real.—2. The act of converting money into land.—3. The act of believing or considering as real.—4. The act of bringing into being or act.

REALIZE, *v. t.* [*Sp. realizar*; *Fr. réaliser*.] 1. To bring into being or act; as, to *realize* a scheme or project.

We *realize* what Archimedes had only in hypothesis, weighing a single grain of sand against the globe of earth. *Glanville*.

2. To convert money into land, or personal into *real estate*.—3. To impress on the mind as a reality; to believe, consider, or treat as real. How little do men in full health *realize* their frailty and mortality.

Let the sincere Christian *realize* the closing sentiment. *T. Scott*.

4. To bring home to one's own case or experience; to consider as one's own; to feel in all its force. Who, at his fire-side, can *realize* the distress of shipwrecked mariners?

This allusion must have had enhanced strength and beauty to the eye of a nation extensively devoted to a pastoral life, and therefore *realizing* all its fine scenes and the tender emotions to which they gave birth. *Dwight*.

5. To bring into actual existence and possession; to render tangible or effective. He never *realized* much profit from his trade or speculations.

REALIZED, *pp.* Brought into actual being; converted into *real estate*; impressed, received, or treated as a reality; felt in its true force; rendered actual, tangible, or effective.

REALIZING, *ppr.* Bringing into actual being; converting into *real estate*; impressing as a reality; feeling as one's own or in its real force; rendering tangible or effective.—2. *a.* That makes real, or that brings home as a reality; as, a *realizing* view of eternity.

RE-ALLÈGE, *v. t.* (*reallé*.) [*re* and *allege*.] To allege again.

RE-ALLIANCE, *n.* A renewed alliance.

REALLY, *adv.* With actual existence.—2. In truth; in fact; not in appearance only; as, things *really* evil.

The anger of the people is *really* a short fit of madness. *Swift*.

In this sense, it is used familiarly as a slight corroboration of an opinion or declaration.

Why, *really*, sixty-five is somewhat old.

*Young*.

REALM, *n.* (*reilm*.) [*Fr. royaume*; *It. reame*; from *Fr. roi*, *It. re*, *L. rex*, king, whence *regalis*, royal.] 1. A royal jurisdiction or extent of government; a kingdom; a king's dominions; as, the *realm* of England.—2. Kingly government; as, the *realm* of bees. [*Unusual.*]

REALM'-BOUNDING, *a.* Bounding a realm.

REALTY, *n.* [*It. realtà*, from *re*, king, *L. rex*.] 1. † Loyalty.—2. † Reality.—3. In *law*, immobility, or the fixed, permanent nature of that kind of property termed *real*. [See PERSONALTY.]

REAM, *n.* [*Sax. ream*, a band; *D. riem*; *Dan. rem* or *reem*; *Sw. rem*; *W. rheym*, a bond or tie. The Dutch word signifies a strap, thong, or girdle, and an oar, *L. remus*. In *Fr. rame* is a ream and an oar, and if the English *ream* and the *L. remus* are the same word, the primary sense is a shoot, *L. ramus*, a branch, for the shoots of trees or shrubs were the first bands used by men. See GIRD and WITHIE. The

Italian has *risma*, and the Sp. and Port. *resma*, a ream, *G. riess*.] A bundle or package of paper, consisting generally of twenty quires of twenty-four sheets each; but what is called the printer's ream contains 21½ quires, or 516 sheets.

REAM, *n.* Cream. [*Scotch.*]

REAMING, *n.* In *bloch-making*, the act of increasing the size of a hole with a large instrument.

RE-ANIMATE, *v. t.* [*re* and *animate.*] To revive; to resuscitate; to restore to life; as a person dead or apparently dead; as, to *reanimate* a drowned person.—2. To revive the spirits when dull or languid; to invigorate; to infuse new life or courage into; as, to *reanimate* disheartened troops; to *reanimate* drowsy senses or languid spirits.

RE-ANIMATED, *pp.* Restored to life or action.

RE-ANIMATING, *ppr.* Restoring life to; invigorating with new life and courage.

RE-ANIMATION, *n.* The act or operation of reviving from apparent death; the act or operation of giving fresh spirits, courage, or vigour.

RE-ANNEX, *v. t.* [*re* and *annex.*] To annex again; to reunite; to annex what has been separated.

RE-ANNEXATION, *n.* The act of annexing again.

RE-ANNEXED, *pp.* Annexed or united again.

RE-ANNEXING, *ppr.* Annexing again; reuniting.

REAP, *v. t.* [*Sax. rip, hrippe, gerip*, harvest; *ripan*, to reap; *ripe*, ripe; *rypan*, to rip; allied probably to *reafian*, to seize, spoil, lay waste, *L. rapio*, *G. reif*, ripe, *D. raapen*, to reap, *ryp*, ripe, *Gr. ῥίπην*, a sickle, ῥίπαια, to reap, *L. carpo*, *Eng. crop.*] 1. To cut grain with a sickle; as, to *reap* wheat or rye.

When ye *reap* the harvest, thou shalt not wholly *reap* the corners of thy field; *Lev. xix.*

2. To clear of a crop by reaping; as, to *reap* a field.—3. To gather; to obtain; to receive as a reward, or as the fruit of labour or of works; *in a good or bad sense*; as, to *reap* a benefit from exertions.

He that soweth to the flesh, shall from the flesh *reap* corruption; *Gal. vi.*

Ye have plowed wickedness; ye have *reaped* iniquity; *Ilos. v.*

REAP, *v. i.* To perform the act or operation of reaping. In England, farmers *reap* in July and August.—2. To receive the fruit of labour or works.

They that sow in tears, shall *reap* in joy; *Ps. cxxvi.*

REAPED, *pp.* Cut with a sickle; received as the fruit of labour or works.

REAPER, *n.* One that cuts grain with a sickle.

REAPING, *ppr.* Cutting down corn, or any other grain crop, with a sickle, or scythe, or by a reaping machine; receiving as the fruit of labour, or the reward of works. The operation of reaping grain crops is more advantageously performed when the grain is not quite ripe, than when it is thoroughly ripe; because in the latter case the seeds are apt to drop out in the process of handling and drying.

REAPING-HOOK, *n.* An instrument used in reaping; a sickle; a shearing-hook. [*The last term is Scotch.*] This useful implement, shaped, in all ages,

pretty nearly as we now see it, is among the oldest implements used by civilized man. It is seen in many frescoes of the Egyptian tombs; and the sickle of Bible times, early and late, was certainly the same.

The reapers in Palestine and Syria still make use of the *reaping-hook* in cutting down their crops; and "fill their hand" with the corn, and those who bind up the sheaves, their "bosom"; *Ps. cxxix. 7*; *Ruth ii. 5.*  
*Dr. Kitto.*

REAPING MACHINE, *n.* A machine for cutting down corn, &c., with more expedition than by the ordinary methods. Several such machines have been contrived, but without much success in use.

RE-APPAR'EL, *v. t.* [*re* and *apparel.*] To clothe again.

RE-APPAR'ELLED, *pp.* Clothed again.

RE-APPAR'ELLING, *ppr.* Clothing again.

RE-APPEAR, *v. i.* [*re* and *appear.*] To appear a second time.

RE-APPEARANCE, *n.* A second appearance.

RE-APPEARING, *ppr.* Appearing again.

RE-APPLICA'TION, *n.* [*See RE-APPLY.*] A second application.

RE-APPLY, *v. t. or i.* [*re* and *apply.*] To apply again.

RE-APPLYING, *ppr.* Applying again.

RE-APPOINT, *v. t.* To appoint again.

RE-APPOINTED, *pp.* Appointed again.

RE-APPOINTING, *ppr.* Appointing again.

RE-APPOINTMENT, *n.* A second appointment.

RE-APPORTION, *v. t.* To apportion again.

RE-APPORTIONED, *pp.* Apportioned again.

RE-APPORTIONING, *ppr.* Apportioning again.

RE-APPORTIONMENT, *n.* A second apportionment.

REAR, *n.* [*Fr. arriere*; but this is compound; *Arm. refr, rever, rear*, the seat, the fundament; *W. rhêv*, something thick, a bundle; *rhévyr*, the fundament. *Rear* is contracted from *rever.*] 1. In a general sense, that which is behind or backward; the hind part; *appropriately*, the part of an army which is behind the other, either when standing on parade or when marching; also, the part of a fleet which is behind the other. It is opposed to *front* or *vam*. Bring up the *rear*.—2. The last class; the last in order.

Coins I place in the *rear*. *Peacham.* In the *rear*, behind the rest; backward, or in the last class. In this phrase, *rear* signifies the part or place behind.—*Rear half files*, the three hindmost ranks of a battalion when it is drawn up six deep.

REAR, *a.* [*Sax. hrere.*] 1. Little cooked; raw; rare; not well roasted or boiled.—2. [*Sax. araran*, to hasten; *hreran*, to excite.] Early. [*A provincial word.*]

REAR, *v. t.* [*Sax. raran, reran, araran*, to erect, to hasten; *hreran*, to excite; *Sw. röra*, to move; *Dan rörer*, to move, stir, shake; *rörig*, quick, lively, rising in the stomach.] 1. To raise.

Who now shall *rear* you to the sun, or rank

Your tribes? *Milton.*

2. To lift after a fall.

In adoration at his feet I fell  
Submit; he *rear'd* me. *Milton.*

3. To bring up or to raise to maturity, as young; as, to *rear* a numerous offspring.—4. To educate; to instruct.

He wants a father to protect his youth,  
And *rear* him up to virtue. *Southern.*

5. To exalt; to elevate.  
Charity, decent, modest, easy, kind,  
Softens the high, and *rears* the abject mind. *Prior.*

6. To rouse; to stir up.  
And seeks the tusked boar to *rear*.

*Dryden.*

7. To raise; to breed; as cattle.—8. To achieve; to obtain.—*To rear the steps*, to ascend; to move upward.

REAR, *v. i.* To rise on the hind legs; as a horse.

REAR, *adv.* Early soon. [*Provincial.*]

REAR-AD'MIRAL. *See* ADMIRAL.

REARED, *pp.* Raised; lifted; brought up; educated; elevated.

REAR-GUARD, *n.* The body of an army that marches in the rear of the main body to protect it. The march of an army is always composed of an advanced guard, a main body, and a rear-guard; the first and last commanded by a general.

REARING, *ppr.* Raising; educating; elevating. In *her.*, *rearing* is said of the horse, when standing on the hind-legs, with the fore-legs raised.

REAR-LINE, *n.* The line in the rear of an army.

REAR-MOUSE, *n.* [*Sax. hrove-mus.*] The rere-mouse; the bat.

REAR-RANK, *n.* The rank of a body of troops which is in the rear; the last rank of a battalion when drawn up in open order.

REARWARD, *n.* [*from rear.* *See* REReward.] The last troop; the rear-guard.—2. The end; the tail; the train behind.—3. The latter part.

RE-ASCEND, *v. i.* [*re* and *ascend.*] To rise, mount, or climb again.

RE-ASCEND, *v. t.* To mount or ascend again.

He mounts aloft and *reascends* the skies. *Addison.*

RE-ASCEND'ED, *pp.* Ascended again.

RE-ASCEND'ING, *ppr.* Ascending again.

RE-ASCEN'SION, *n.* The act of re-ascending; a remounting.

RE-ASCENTY, *n.* A returning ascent; acclivity.

REASON, *n.* (*re'zn.*) [*Ir. reasun*; *W. rheswm*; *Fr. raison*; *L. ratio*; *Goth. rathyo*, an account, number, ratio; *rathyan*, to number; *garathyan*, to number or count; *rodyan*, to speak; *D. rede*, speech; *reden*, reason, argument; *redenkunst*, rhetoric; *G. rede, reden*; *Sax. ræd, ræda*, speech, reason; *ræsvian*, to reason. We find united the *Sax. ræd*, speech, *radan*, *redan*, to read, the *Gr. ρῆσις*, to say or speak, whence *rhetoric*, and the *L. ratio*, which is from *ratus*, and which proves *rear* to be contracted from *redo, redor*, and all unite with *rod, l. radius*, &c. Primarily, *reason* is that which is uttered. *See* READ. So *Gr. λογος*, from *λογω*.] 1. That which is thought or which is alleged in words, as the ground or cause of opinion, conclusion, or determination. I have *reasons* which I may choose not to disclose. You ask me my *reasons*. I freely give my *reasons*. The judge assigns good *reasons* for his opinions.

reasons which justify his decision. Hence in general,—2. The cause, ground, principle, or motive of any thing said or done; that which supports or justifies a determination, plan, or measure.

Virtue and vice are not arbitrary things; but there is a natural and eternal reason for that goodness and virtue, and against vice and wickedness; 1 Pet. iii. *Tillotson*.  
3. Efficient cause. He is detained by reason of sickness.

Spain is this sown of people, partly by reason of its sterility of soil. *Bacon*.

The reason of the motion of the balance in a wheel-watch is by motion of the next wheel. *Hale*.

4. Final cause.

Reason, in the English language, is sometimes taken for true and clear principles; sometimes for clear and fair deductions; sometimes for the cause, particularly the final cause. *Locke*.

5. A faculty of the mind by which it distinguishes truth from falsehood, and good from evil, and which enables the possessor to deduce inferences from facts or from propositions; and to combine means for the attainment of particular ends. Reason is the highest faculty of the human mind, by which man is distinguished from brutes, and which enables him to contemplate things spiritual as well as material, to weigh all that can be said or thought for and against them, and hence to draw conclusions and to act accordingly. A man may therefore be said to possess reason in proportion as he actually exercises that power, that is, reasons and acts according to the conclusions or results at which he has arrived. In the language of English philosophy, the terms reason and understanding are nearly identical, and are so used by Stewart; but in the critical philosophy of Kant, a broad distinction is drawn between them. Self-love, the spring of motion, acts the soul,

Reason's comparing balance rules the whole...

That sees immediate good by present sense, Reason the future and the consequence. *Pope*.

Reason is the director of man's will. *Hooker*.

6. Ratiocination; the exercise of reason.

But when by reason she the truth has found. *Davies*.

7. Right; justice; that which is dictated or supported by reason. Every man claims to have reason on his side. I was promised on a time

To have reason for my rhyme. *Spenser*.

8. Reasonable claim; justice.

God brings good out of evil, and therefore it were but reason we should trust God to govern his own world. *Taylor*.

9. Rationale; just account.

This reason did the ancient fathers render, why the church was called Catholic. *Pearson*.

10. Moderation; moderate demands; claims which reason and justice admit or prescribe.

The most probable way of bringing France to reason, would be by the making an attempt on the Spanish West Indies. *Addison*.  
In reason, in all reason, in justice; with rational ground.

When any thing is proved by as good arguments as a thing of that kind is capable of, we ought not in reason to doubt of its existence. *Tillotson*.

REASON, v. i. [Fr. *raisonner*; Sax. *raswian*.] 1. To exercise the faculty of reason; to deduce inferences justly from premises. Brutes do not reason; children reason imperfectly.—2. To argue; to infer conclusions from premises, or to deduce new or unknown propositions from previous propositions which are known or evident. To reason justly, is to infer from propositions which are known, admitted, or evident, the conclusions which are natural, or which necessarily result from them. Men may reason within themselves; they may reason before a court or legislature; they may reason wrong as well as right.—3. To debate; to confer or inquire by discussion or mutual communication of thoughts, arguments, or reasons.

And they reasoned among themselves; *Matth. xvi*.

To reason with, to argue with; to endeavour to inform, convince, or persuade by argument. Reason with a profligate son, and if possible, persuade him of his errors.—2. To discourse; to talk; to take or give an account.

Stand still, that I may reason with you before the Lord, of all the righteous acts of the Lord; 1 Sam. xii.

REASON, v. t. To examine or discuss by arguments; to debate or discuss. I reasoned the matter with my friend.

When they are clearly discovered, well digested and well reasoned in every part, there is beauty in such a theory. *Burnet*.  
2. To persuade by reasoning or argument; as, to reason one into a belief of truth; to reason one out of his plan; to reason down a passion.

REASONABLE, a. Having the faculty of reason; endued with reason; as, a reasonable being. [In this sense, rational is now generally used.] 2. Governed by reason; being under the influence of reason; thinking, speaking, or acting rationally or according to the dictates of reason; as, the measure must satisfy all reasonable men.—3. Conformable or agreeable to reason; just; rational.

By indubitable certainty, I mean that which does not admit of any reasonable cause of doubting. *Wilkins*.

A law may be reasonable in itself, though a man does not allow it. *Swift*.

4. Not immoderate.

Let all things be thought upon, That may with reasonable swiftness add More feathers to our wings. *Shak*.

5. Tolerable; being in mediocrity; moderate; as, a reasonable quantity.

—6. Not excessive; not unjust; as, a reasonable fine; a reasonable sum in damages.—Reasonable cause, in *Scots law*, a reasonable cause for granting a deed, is one which is a ground for executing the deed, though not one which could have been used to compel the grantor to execute it.

REASONABLENESS, n. The faculty of reason. [In this sense, little used.] 2. Agreeableness to reason; that state or quality of a thing which reason supports or justifies; as, the reasonableness of our wishes, demands, or expectations.

The reasonableness and excellency of charity. *Law*.

3. Conformity to rational principles.

The whole frame and contexture of a watch carries in it a reasonableness...the passive impression of the reason or intellectual idea that was in the artist. [Unusual.] *Hale*.

4. Moderation; as, the reasonableness of a demand.

REASONABLY, adv. In a manner or degree agreeable to reason; in consistency with reason. We may reasonably suppose self-interest to be the governing principle of men.—2. Moderately; in a moderate degree; not fully; in a degree reaching to mediocrity.

If we can by industry make our deaf and dumb persons reasonably perfect in the language. *Holder*.

REASONED, pp. Examined or discussed by arguments.—2. Persuaded by reasoning or argument.

REASONER, n. One who reasons or argues; as, a fair reasoner; a close reasoner; a logical reasoner.

REASONING, ppr. Arguing; deducing inferences from premises; debating; discussing.

REASONING, n. The act or process of exercising the faculty of reason; that act or operation of the mind by which new or unknown propositions are deduced from previous ones which are known and evident, or which are admitted or supposed for the sake of argument; argumentation; ratiocination; as, fair reasoning; false reasoning; absurd reasoning; strong or weak reasoning. The reasonings of the advocate appeared to the court conclusive.

REASONLESS, a. Destitute of reason; as, a reasonless man or mind.—2. Void of reason; not warranted or supported by reason.

This proffer is absurd and reasonless. *Shak*.

RE-ASSEMBLAGE, n. Assemblage a second time.

RE-ASSEMBLE, v. t. [re and assemble.] To collect again.

RE-ASSEMBLE, v. i. To assemble or convene again.

RE-ASSEMBLED, pp. Assembled again.

RE-ASSEMBLING, ppr. Assembling again.

RE-ASSERT, v. t. [re and assert.] To assert again; to maintain after suspension or cessation.

Let us hope...we may have a body of authors who will reassert our claim to respectability in literature. *Walsh*.

RE-ASSERTED, pp. Asserted or maintained anew.

RE-ASSERTING, ppr. Asserting again; vindicating anew.

RE-ASSERTION, n. A second assertion of the same thing.

RE-ASSIGN, v. t. [re and assign.] To assign back; to transfer back what has been assigned.

RE-ASSIGNED, pp. Assigned back.

RE-ASSIGNING, ppr. Transferring back what has been assigned.

RE-ASSIMILATE, v. t. [re and assimilate.] To assimilate or cause to resemble anew; to change again into a like or suitable substance.

RE-ASSIMILATED, pp. Assimilated anew; changed again to a like substance.

RE-ASSIMILATING, ppr. Assimilating again.

RE-ASSIMILATION, n. A second or renewed assimilation.

RE-ASSUME, v. t. [re and assume.] To resume; to take again.

RE-ASSUMED, pp. Resumed; assumed again.

RE-ASSUMING, ppr. Assuming or taking again.

RE-ASSUMPTION, *n.* A resuming; a second assumption.

RE-ASSURANCE, *n.* [See SURE and ASSURANCE.] A second assurance against loss, or the assurance of property by an underwriter, to relieve himself from a risk he has taken.

RE-ASSURE, *v. t.* [reassh'ure.] [re and assure; Fr. rassurer.] 1. To restore courage to; to free from fear or terror.

They rose with fear,  
Till dauntless Pallas reassured the rest.

*Dryden.*

2. To insure a second time against loss, or rather to insure by another what one has already insured; to insure against loss that may be incurred by taking a risk.

RE-ASSURED, *pp.* Restored from fear; re-encouraged. — 2. Insured against loss by risk taken, as an underwriter.

RE-ASSURER, *n.* One who insures the first underwriter.

RE-ASSURING, *ppr.* Restoring from fear, terror, or depression of courage. — 2. Insuring against loss by insurance.

REASTINESS, *n.* Rancidness. [Not in use or local.]

REASTY, *a.* [Qu. rusty.] Covered with a kind of rust and having a rancid taste; applied to dry meat. [Not in use or local.]

REATE, *n.* A kind of long small grass that grows in water and complicates itself. [Not in use or local.]

RE-ATTACH, *v. t.* [re and attach.] To attach a second time.

RE-ATTACH'ED, *pp.* Attached a second time.

RE-ATTACHMENT, *n.* A second attachment.

RE-ATTEMPT, *v. t.* [re and attempt.] To attempt again.

RE-ATTEMPT'ED, *pp.* Attempted a second time.

RE-ATTEMPT'ING, *ppr.* Attempting again.

REAVE,† *v. t.* [Sax. reafian.] To take away by stealth or violence; to bereave. [See BEREAVE.]

REAV'ER,† *n.* A robber.

REAVOW,† *v. t.* To avow again.

REBAPTISM, *n.* A second baptism.

REBAPTIZATION, *n.* [from rebaptize.] A second baptism.

REBAPTIZE, *v. t.* [re and baptize.] To baptize a second time.

REBAPTIZED, *pp.* Baptized again.

REBAPTIZING, *ppr.* Baptizing a second time.

REBATE, *v. t.* [Fr. rebattre; re and battre; It. ribattere.] To blunt; to beat to obtuseness; to deprive of keenness. He doth rebate and blunt his natural edge.

*Shak.*

The keener edge of battle to rebate.

*Dryden.*

REBATE, *n.* Frequently written *Rab-**bet.* In construction, a rectangular longitudinal recess made in the edge of any substance. Thus the rectangular recess made in a door-frame, into which the door shuts, is a rebate.—*Rebate*



Rebates.

joint, in joinery, a joint formed by making rebates or longitudinal recesses

in the opposite edges of the boards to be joined.

REBATE, *n.* A kind of hard free stone used in pavements; also a piece of wood fastened to a long stick for beating mortar.

REBATE, *v. t.* [Fr. raboter.] To form rebates; to join by rebates. In the technical sense, to rebate, means simply to diminish.

REBATE, } *n.* Diminution.—2.  
REBATEMENT, } In com., abatement in price; deduction.—3. In her., a diminution or abatement of the bearings in a coat of arms.—*Rebate and discount*, a rule, in arith., by which abatements and discounts upon ready-money payments are calculated.

REBATE PLANES, *n.* Planes used in forming and finishing rebates in joiner work; or, as it is technically termed, sinking rebates. Of these there are the moving fillister, used, in sinking rebates, on the edge of the board next to the workman, and the sash fillister in sinking the rebate on the edge furthest from him; and the guillames, skewed and square, the former for finishing the rebate across the direction of the fibre, and the latter for finishing it in the direction of the fibre.

REBATING, *ppr.* Joining by rebates.  
REBATO, *n.* A sort of ruff. [See RABATO.]

REBEC, } *n.* [Fr. rebec; It. ribeca.]  
REBECK, } A stringed-instrument somewhat similar to the violin, having three strings tuned in fifths, and played with a bow. It was introduced by the Moors into Spain.

REBEL, *n.* [Fr. rebelle, from *L. rebellis*, making war again.] 1. One who revolts from the government to which he owes allegiance, either by openly renouncing the authority of that government, or by taking arms and openly opposing it. A rebel differs from an enemy, as the latter is one who does not owe allegiance to the government which he attacks; Num. xvii.—2. One who wilfully violates a law.—3. One who disobeys the king's proclamation; a contemner of the king's laws.—4. A villain who disobeys his lord.

REBEL, *a.* Rebellious; acting in revolt.  
REBEL, *v. i.* [*L. rebello*, to make war again; *re* and *bello*; *W. rhyvela*, to make war; *rhy* and *bel*, war.] 1. To revolt; to renounce the authority of the laws and government to which one owes allegiance. Subjects may rebel by an open renunciation of the authority of the government, without taking arms; but ordinarily, rebellion is accompanied by resistance in arms.

Ye have built you an altar, that ye might rebel this day against the Lord; Josh. xxii.; Is. i.

2. To rise in violent opposition against lawful authority.

How could my hand rebel against my heart? How could your heart rebel against your reason? *Dryden.*

REBELLED, *pp.* or *a.* Rebellious; guilty of rebellion.

REBELLER, *n.* One that rebels.

REBELLING, *ppr.* Renouncing the authority of the government to which one owes allegiance; rising in opposition to lawful authority.

REBELLION, *n.* [Fr. from *L. rebellio*. Among the Romans, rebellion was originally a revolt or open resistance to their government by nations that had been subdued in war. It was a re-

newed war.] 1. An open and avowed renunciation of the authority of the government to which one owes allegiance; or the taking of arms traitorously to resist the authority of lawful government; revolt. *Rebellion* differs from *insurrection* and from *mutiny*. *Insurrection* may be rising in opposition to a particular act or law, without a design to renounce wholly all subjection to the government. *Insurrection* may be, but is not necessarily, rebellion. *Mutiny* is an insurrection of soldiers or seamen against the authority of their officers.

No sooner is the standard of rebellion displayed, than men of desperate principles resort to it. *Ames.*

2. Open resistance to lawful authority.—*Civil rebellion.* In *Scotch law*, by a peculiar fiction a debtor who disobeys a charge, on letters of horning, to pay or perform in terms of his obligation, is accounted a rebel, by reason of his disobedience to the king's command contained in the writ, and this disobedience is termed *civil rebellion*.—*Commission of rebellion*, in law, a commission awarded against a person who treats the king's authority with contempt, in not obeying his proclamation according to his allegiance, and refusing to attend his sovereign when required; in which case, four commissioners are ordered to attend him wherever he may be found.

REBELLIUS, *a.* Engaged in rebellion; renouncing the authority and dominion of the government to which allegiance is due; traitorously resisting government or lawful authority; Deut. ix. xxi.

REBELLIOUSLY, *adv.* With design to throw off the authority of legitimate government; in opposition to the government to which one is bound by allegiance; with violent or obstinate disobedience to lawful authority.

REBELLIUSNESS, *n.* The quality or state of being rebellious.

REBELLOW, *v. i.* [re and bellow.] To bellow in return; to echo back a loud roaring noise.

The cave rebellow'd and the temple shook. *Dryden.*

REBELLOWING, *ppr.* Bellowing in return or in echo.

REBENDING, *ppr.* [re and bend.] In her., the same as bowed, embowed, bent first one way, and then another, like the letter S.

REBLOSSOM, *v. i.* [re and blossom.] To blossom again.

REBLOSSOMING, *ppr.* Blossoming again.

REBOATION,† *n.* [*L. reboo*; *re* and *boo*.] The return of a loud bellowing sound.

REBOIL,† *v. i.* [*L. re and bullio*.] To take fire; to be hot.

REBOIL,† *v. t.* To boil again.

REBOIL'ED, *pp.* Boiled a second time.

REBOUND,† *v. i.* [Fr. rebondir; re and bondir.] To spring back; to start back; to be reverberated by an elastic power resisting force or impulse impressed; as, a rebounding echo.

Bodies absolutely hard, or so soft as to be void of elasticity, will not rebound from one another. *Newton.*

REBOUND,† *v. t.* To drive back; to reverberate.

Silenus sung; the vales his voice rebound. *Dryden.*

REBOUND,† *n.* The act of flying back

in resistance of the impulse of another body; resilience.

Put back as from a rock with swift rebound.

*Dryden.*

REBOUNDED, *pp.* Sprung back; reverberated.

REBOUNDING, *ppr.* Springing or flying back; reverberating.

REBRACE, *v. t.* [re and brace.] To brace again.

REBREATHE, *v. i.* [re and breathe.] To breathe again.

REBUFF, *n.* [It. *rabuffo*; Fr. *rebuffade*; re and It. *buffa*, *buffare*, Fr. *bouffer*.] 1. Repercussion; or beating back; a quick and sudden resistance. The strong *rebuff* of some tumultuous cloud.

*Milton.*

2. Sudden check; defeat.—3. Refusal; rejection of solicitation.

REBUFF, *v. t.* To beat back; to offer sudden resistance to; to check.

REBUFFED, *pp.* Beaten back; resisted suddenly; checked.

REBUILD, *v. t.* [re and build.] To build again; to renew a structure; to build or construct what has been demolished; as, to *rebuild* a house, a wall, a wharf or a city.

REBUILD'ER, *n.* [from *rebuild*.] One who reconstructs, or builds again.

REBUILDING, *ppr.* Building again.

REBUILT, *pp.* Built again; reconstructed.

REBUKABLE, *a.* [from *rebuhe*.] Worthy of reprehension.

REBUKE, *v. t.* [Norm. *rebuquer*; Arm. *rebechat*, to reproach. Qu. Fr. *reboucher*, to stop; re and *boucher*, to stop. The Italian has *rimbeccare*, to repulse or drive back, to *pech*, from *becco*, the beak. See PACK and IMPEACH.] 1. To chide; to reprove; to reprehend for a fault; to check by reproof. The proud he tamed, the penitent he cheer'd. Nor to *rebuhe* the rich offender fear'd.

*Dryden.*

Thou shalt in any wise *rebuhe* thy neighbour; Lev. xix.

2. To check or restrain.

The Lord *rebuhe* thee, O Satan; Zech. iii.; Is. xvii.

3. To chasten; to punish; to afflict for correction.

O Lord, *rebuhe* me not in thine anger; Ps. vi.

4. To check; to silence.

Master, *rebuhe* thy disciples; Luke xix.

5. To check; to heal.

And he stood over her and *rebuked* the fever; Luke iv.

6. To restrain; to calm.

He arose and *rebuked* the winds and the sea; Matt. viii.

REBUKE, *n.* A chiding; reproof for faults; reprehension.

Why bear you these *rebukes* and answer not? *Shak.*

2. In *scrip*, chastisement; punishment; affliction for the purpose of restraint and correction; Ezek. v.; Hos. v.—

3. In *lovo lan*, any kind of check.—To suffer *rebuke*, to endure the reproach and persecution of men; Jer. xv.—To be without *rebuke*, to live without giving cause of reproof or censure; to be blameless.

REBUKED, *pp.* Reproved; reprehended; checked; restrained; punished for faults.

REBUKEFUL, *a.* Containing or abounding with rebukes.

REBUKEFULLY, *adv.* With reproof or reprehension.

REBUKER, *n.* One that rebukes; a chider; one that chastises or restrains.

REBUKING, *ppr.* Chiding; reproof; checking; punishing.

REBUKINGLY, *adv.* By way of rebuke.

REBULLITION, *n.* [See EBULLITION and BOIL.] Act of boiling or effervescing. [Little used.]

REBURY, *v. t.* [reber'ry.] [re and bury.] To inter again.

REBUS, *n.* [L. from *res*, which is of the same family as *riddle*. See RIDDLE, READ, and REAL.] 1. An enigmatical representation of some name, &c. by using figures or pictures instead of words. A gallant in love with a woman named *Rose Hill*, painted on the border of his gown, a rose, a hill, an eye, a loaf, and a well, which reads, *Rose Hill I love well*.—2. A sort of riddle.—3. In some chemical writers, sour milk; sometimes, the ultimate matter of which all bodies are composed.—4. In *her*, a coat of arms which bears an allusion to the name of the person; as three cups, for *Butler*.

REBUT, *v. t.* [Fr. *rebuter*; Norm. *rebutter*; from the root of *but*, Fr. *bout*, end; *bouter*, to put; *boulder*, to pout; It. *ributtare*, to drive back, also to vomit. See BUTT and POUT.] To repel; to oppose by argument, plea, or countervailing proof. [It is used by lawyers in a general sense.]

REBUT, † *v. i.* To retire back.—2. To answer, as a plaintiff's sur-rejoinder.

The plaintiff may answer the rejoinder, by a sur-rejoinder; on which the defendant may *rebut*. *Blackstone.*

REBUTTED, *pp.* Repelled; answered.

REBUTTER, *n.* In *law pleadings*, the answer of a defendant to a plaintiff's sur-rejoinder. [See PLEADING.]

If I grant to a tenant to hold without impeachment of waste, and afterward implead him for waste done, he may debar me of this action by showing my grant, which is a *rebutter*. *Encyc.*

REBUTTING, *ppr.* Repelling; opposing by argument, countervailing allegation or evidence.

RECAL, *v. t.* [re and call.] To call back; to take back; as, to *recal* words or declarations.—2. To revoke; to annul by a subsequent act; as, to *recal* a decree.—3. To call back; to revive in memory; as, to *recal* to mind what has been forgotten.—4. To call back from a place or mission; as, to *recal* a minister from a foreign court; to *recal* troops from India.

RECAL, *n.* A calling back; revocation.—2. The power of calling back or revoking.

'Tis done, and since 'tis done, 'tis past *recal*. *Dryden.*

RECALLABLE, *a.* That may be recalled.

Delegates *recallable* at pleasure. *Madison.*

RECALLED, *pp.* Called back; revoked.

RECALLING, *ppr.* Calling back; revoking.

RECA'NT, *v. t.* [L. *recanto*; re and *canto*. See CANT.] To retract; to recall; to contradict a former declaration.

How soon would ease *recant* Vows made in pain, as violent as void. *Milton.*

RECA'NT, *v. i.* To recall words; to revoke a declaration or proposition; to unsay what has been said. Convince me I am wrong, and I will *recant*.

RECA'NTATION, *n.* The act of recalling; retraction; a declaration that contradicts a former one.

RECA'NT'ED, *pp.* Recalled; retracted.

RECA'NT'ER, *n.* One that recants.

RECA'NT'ING, *ppr.* Recalling; retracting.

RECAPACITATE, *v. t.* [re and *capacitate*.] To qualify again; to confer capacity on again.

RECAPACITATED, *pp.* Capacitated again.

RECAPACITATING, *ppr.* Confering capacity again.

RECAPITULATE, *v. t.* [Fr. *recapituler*; re and L. *capitulum*. See CAPITULATE.] To repeat the principal things mentioned in a preceding discourse, argument, or essay; to give a summary of the principal facts, points, or arguments.

RECAPITULATED, *pp.* Repeated in a summary.

RECAPITULATING, *ppr.* Repeating the principal things in a discourse or argument.

RECAPITULATION, *n.* The act of recapitulating.—2. A summary or concise statement or enumeration of the principal points or facts in a preceding discourse, argument, or essay.

RECAPITULATORY, *a.* Repeating again; containing recapitulation.

RECA'PTION, *n.* [L. *re* and *capcio*; *capio*, to take.] The act of retaking; reprisal; the retaking of one's own goods, chattels, wife, or children from one who has taken them and wrongfully detains them.—*Writ of recaption*, a writ to recover property taken by a second distress, pending a replevin for a former distress for the same rent or service.

RECA'PTOR, *n.* [re and *captor*.] One who retakes; one that takes a prize which had been previously taken.

RECA'PTURE, *n.* [re and *capture*.] The act of retaking; particularly, the retaking of a prize or goods from a captor.—2. A prize retaken.

RECA'PTURE, *v. t.* To retake; particularly, to retake a prize which had been previously taken.

RECA'PTURED, *pp.* Retaken.

RECA'PTURING, *ppr.* Retaking, as a prize from the captor.

RECA'RNIFY, *v. t.* [re and *carnify*, from L. *caro*, flesh.] To convert again into flesh. [Not much used.]

RECA'RRIED, *pp.* Carried back or again.

RECA'RRY, *v. t.* [re and *carry*.] To carry back.

RECA'RRYING, *ppr.* Carrying back.

RECAST, *v. t.* [re- and *cast*.] To cast again; as, to *recast* cannon.—2. To throw again.—3. To mould anew.—4. To compute a second time.

RECAST, *pp.* Cast again; moulded anew.

RECASTING, *ppr.* Casting again; moulding anew.

RECEDE, *v. i.* [L. *recedo*; re and *cedo*.] 1. To move back; to retreat; to withdraw.

Like the hollow roar Of tides *receding* from th' insulted shore. *Dryden.*

All bodies moved circularly endeavour to *recede* from the centre. *Bentley.*

2. To withdraw a claim or pretension; to desist from; to relinquish what had been proposed or asserted; as, to *recede* from a demand; to *recede* from terms or propositions.

RECEDE, *v. t.* [re and *cede*.] To cede back; to grant or yield to a former possessor; as, to *recede* conquered territory. [American.]

RECEDED, *pp.* Ceded back; regranted.  
RECEDING, *pp.* Withdrawing; re-  
treating; moving back.—2. Ceding  
back; regrating. [*American.*]

RECEIPT, *n.* (rece'pt.) [It. *ricetta*, from  
the L. *receptus*.] 1. The act of receiv-  
ing; as, the receipt of a letter.—2. The  
place of receiving; as, the receipt of  
custom; Matt. ix.—3. Reception; as,  
the receipt of blessings or mercies.—  
4. † Reception; welcome; as, the kind  
receipt of a friend. [In this sense,  
*reception* is now used.]—5. Recipe;  
prescription of ingredients for any com-  
position, as of medicines, &c.—6. In  
*com.*, a written discharge of a debtor  
on payment of money due, or, it is an  
acknowledgment in writing of having  
received a sum of money, or other  
valuable consideration. It is a voucher  
either of an obligation or debt dis-  
charged, or of one incurred. A receipt  
of money may be in part or in full  
payment of a debt, and it operates as  
an acquittance or discharge of the debt  
either in part or in full. A receipt of  
goods makes the receiver liable to  
account for the same, according to the  
nature of the transaction, or the tenor  
of the writing. A receipt, though evi-  
dence of payment, is not absolute proof,  
and this evidence may be rebutted by  
showing that it has been given under  
mistake, or obtained by fraud.

RECEIPT, *v. t.* (rece'pt.) To give a  
receipt for.

RECEIVABLE, *a.* That may be re-  
ceived.

RECEIVABLENESS, *n.* Capability of  
being received.

RECEIVE, *v. t.* [Fr. *recevoir*; L. *re-  
cipio*; *re* and *capio*, to take.] 1. To take,  
as a thing offered or sent; to accept.  
He had the offer of a donation, but he  
would not receive it.—2. To take as  
due or as a reward. He received the  
money on the day it was payable. He  
received ample compensation.—3. To  
take or obtain from another in any  
manner, and either good or evil.

Shall we receive good at the hand of God,  
and shall we not receive evil? Job ii.

4. To take, as a thing communicated;  
as, to receive a wound by a shot; to  
receive a disease by contagion.

The idea of solidity, we receive by our  
touch. *Locke.*

5. To take or obtain intellectually; as,  
to receive an opinion or notion from  
others.—6. To embrace.

Receive with meekness the ingrafted  
word; James i.

7. To allow; to hold; to retain; as, a  
custom long received.—8. To admit.

Thou shalt guide me with thy counsel,  
and afterward receive me to glory; Ps.  
lxxiii.

9. To welcome; to lodge and entertain;  
as a guest.

They kindled a fire and received us every  
one, because of the present rain and because  
of the cold; Acts xxviii.

10. To admit into membership or fel-  
lowship.

Him that is weak in the faith, receive ye;  
Rom. xiv.

11. To take in or on; to hold; to con-  
tain.

The brazen altar was too little to receive  
the burnt-offering; 1 Kings viii.

12. To be endowed with.

Ye shall receive power after that the Holy  
Spirit has come upon you; Acts i.

13. To take into a place or state.

After the Lord had spoken to them, he  
was received up into heaven; Mark xvi.

14. To take or have as something  
ascribed; as, to receive praise or blame;  
Rev. iv. 5.—15. To bear with or suffer;  
2 Cor. xi.—16. To believe in; John i.  
—17. To accept or admit officially or  
in an official character. The minister  
was received by the emperor or court.  
—18. To take stolen goods from a thief,  
knowing them to be stolen.

RECEIVED, *pp.* Taken; accepted; ad-  
mitted; embraced; entertained; be-  
lieved.

RECEIVEDNESS, *n.* General allow-  
ance or belief; as, the receivedness of  
an opinion.

RECEIVER, *n.* One who takes or re-  
ceives in any manner.—2. An officer  
appointed to receive public money; a  
treasurer. A person appointed by the  
court of chancery to receive the rents  
and profits of land, or the produce of  
other property, which is in dispute in a  
cause in that court.—3. One who takes  
stolen goods from a thief, knowing  
them to be stolen, and incurs the guilt  
of partaking in the crime.—4. A vessel  
for receiving and containing the pro-  
duct of distillation.—5. The glass ves-  
sel placed on the plate of an air-pump,  
in order to be exhausted of air, being  
so named from its being the recipient  
of those things on which experiments  
are made. [See AIR-PUMP.]—6. One  
who partakes of the sacrament.

RECEIVING, *pp.* Taking; accepting;  
admitting; embracing; believing; en-  
tertaining.

RECEIVING, *n.* The act of receiving;  
that which is received.—*Receiving stolen  
goods*, in *Eng. law*, the receiving any  
chattels, money, valuable securities,  
and other property whatsoever, know-  
ing the same to have been stolen. It  
is punishable with transportation or  
imprisonment. It corresponds to *reset  
of theft* in *Scots law*. [See RESET.]

RECELEBRATE, *v. t.* [*re* and *cele-  
brate*.] To celebrate again.

RECELEBRATED, *pp.* Celebrated  
anew.

RECELEBRATING, *pp.* Celebrating  
anew.

RECELEBRATION, *n.* A renewed  
celebration.

RE'CENCY, *n.* [L. *recens*.] 1. New-  
ness; new state; late origin; as, the  
*recency* of a wound or tumour.—2.  
Lateness in time; freshness; as, the  
*recency* of a transaction.

RE'CNSE, *v. t.* (recens') [L. *recenseo*;  
*re* and *censeo*.] To review; to revise.

RE'CN'SION, *n.* [L. *recensio*.] Re-  
view; examination; enumeration.

RE'CENT, *a.* [L. *recens*.] 1. New;  
being of late origin or existence.

The ancients believed some parts of  
Egypt to be recent, and formed by the mud  
discharged into the sea by the Nile.

*Woodward.*

2. Late; modern; as, great and worthy  
men ancient or recent. [*Modern* is now  
used.]—3. Fresh; lately received; as,  
*recent* news or intelligence.—4. Late;  
of late occurrence; as, a *recent* event  
or transaction.—5. Fresh; not long  
dismissed, released, or parted from; as  
Ulysses, *recent* from the storms.—*Re-  
cent formation*. In *geol.*, any formation  
whether igneous or aqueous, which  
can be proved to be of a date posterior  
to the creation of man, is called *recent*.

Recent formations, are marine, fresh-  
water, and volcanic. A fine specimen  
of *recent* limestone from Guadeloupe,  
containing a fossil human skeleton, may  
be seen in the British museum.—*Recent*

*period*, the period of time commencing  
with the creation of man.

RE'CENTLY, *adv.* Newly; lately;  
freshly; not long since; as, advices *re-  
cently* received; a town *recently* built  
or repaired; an isle *recently* discovered.

RE'CENTNESS, *n.* Newness; fresh-  
ness; lateness of origin or occurrence;  
as, the *recentness* of alluvial land; the  
*recentness* of news or of events.

RECEP'TACLE, *n.* [L. *receptaculum*,  
from *receptus*, *recipio*.] 1. A place or  
vessel into which something is received  
or in which it is contained, as a vat, a  
tun, a hollow in the earth, &c. The  
grave is the common *receptacle* of the  
dead.—2. In *bot.*, the name usually  
given to that part of a flower upon  
which the carpels are situated; or, in  
other words, the apex of the peduncle,  
or summit of the floral branch which  
generally expands in some degree so as  
to form a kind of disk from which the  
floral verticels proceed. But the term  
*receptacle* is used by botanists in dif-  
ferent senses. Thus, it is used to signify  
the axis of the theca among ferns; that  
part of the ovarium from which the  
ovula arise, commonly called the pla-  
centa; and also that part of the axis of  
a plant which bears the flowers when  
it is depressed in its development, so  
that it forms a flattened area over  
which the flowers are arranged; as in  
Compositæ. A *proper receptacle* be-  
longs only to one set of parts of fructi-  
fication; a *common receptacle* bears  
several florets or distinct sets of parts  
of fructification.—3. In *anat.*, the *re-  
ceptacle* of the chyle is situated on the  
left side of the upper vertebra of the  
loins, under the aorta and the vessels  
of the left kidney.

RECEP'TAC'ULAR, *a.* In *bot.*, per-  
taining to the receptacle or growing  
on it, as the nectary.

RE'CEPTARY, † *n.* Thing received.

RE'CEPTIBILITY, *n.* The possibility  
of receiving or of being received.

RE'CEPTION, *n.* [Fr.; L. *receptio*.]

1. The act of receiving; in a *general  
sense*; as, the *reception* of food into the  
stomach, or of air into the lungs.—2.  
The state of being received.—3. Ad-  
mission of any thing sent or communi-  
cated; as, the *reception* of a letter; the  
*reception* of sensation or ideas.—4. Re-  
admission.

All hope is lost

Of my reception into grace. *Milton*

5. Admission of entrance for holding or  
containing; as, a sheath fitted for the  
*reception* of a sword; a channel for the  
*reception* of water.—6. A receiving or  
manner of receiving for entertainment;  
entertainment. The guests were well  
pleased with their *reception*. Nothing  
displeases more than a cold *reception*.

—7. A receiving officially; as, the  
*reception* of an envoy by a foreign court.  
—8. Opinion generally admitted.

Philosophers who have quitted the popu-  
lar doctrines of their countries, have fallen  
into as extravagant opinions as ever  
common *reception* countenanced. *Locke.*

† Recovery.

RE'CEPTIVE, *a.* Having the quality  
of receiving or admitting what is com-  
municated.

Imaginary space is *receptive* of all bodies.  
*Glanville.*

RE'CEPTIVITY, *n.* The state or qua-  
lity of being receptive.

RE'CEPTORY, † *a.* Generally or popu-  
larly admitted or received.

**RECESS', n.** [*L. recessus*, from *recedo*. See *RECEDE*.] 1. A withdrawing or retiring; a moving back; as, the *recess* of the tides.—2. A withdrawing from public business or notice; retreat; retirement.

My *recess* hath given them confidence that I may be conquered. *K. Charles*.

And every neighbouring grove  
Sacred to soft *recess* and gentle love.

*Prior*.

3. Departure.—4. Place of retirement or secrecy; private abode.

This happy place, our sweet

*Recess*. *Milton*.

5. State of retirement; as, lords in close *recess*.

In the *recess* of the jury, they are to consider their evidence. *Hale*.

6. Remission or suspension of business or procedure. Also, the time or period during which public business is suspended; as, the Christmas *recess*.—7. Privacy; seclusion from the world or from company.

Good verse *recess* and solitude requires.

*Dryden*.

8. Secret or abstruse part; as, the difficulties and *recesses* of science.—9.

A withdrawing from any point; removal to a distance.—10.† [*Fr. recéz*.] An abstract or registry of the resolutions of the imperial diet of Germany.

Also, the result of the deliberations of the imperial diet, its finding or resolution come to, the decree; as, the *recess* of the diet of Worms, of Spire, or of Augsburg.—11. The retiring of the shore of the sea or of a lake from the general line of the shore, forming a bay.—12. In *arch.*, a small cavity or niche formed in the wall of a building.

Recesses come under the denomination of exhedræ, tribunes, alcoves, and afford considerable additional space. They add to the commodiousness of dining-rooms, drawing-rooms, libraries, &c.—13. In *bot.*, recesses are the bays or sinuses of lobed leaves.

**RECES'SED, a.** Having a recess or recesses.—*Recessed arch*, one arch within another; such arches are sometimes called double, triple, &c., and sometimes compound arches.

**RECES'SION, n.** [*L. recessio*.] 1. The act of withdrawing, retiring, or retreating.—2. The act of receding from a claim, or of relaxing a demand.—3. A cession or granting back; as, the *recession* of conquered territory to its former sovereign.—*Recession of the equinoxes*, the same as *Precession*,—*which see*.

**RE'CHABITES, n.** A religious order among the ancient Jews, instituted by Jonadab the son of Rechab. It comprised only the family and posterity of the founder, who was anxious to perpetuate among them the nomadic life; and with this view, prescribed to them several rules, the chief of which were—to abstain from wine, from building houses, and from planting vines. These rules were observed by the Rechabites with great strictness. [See *Jer.* xxxv. 6.] In recent times, a branch of the body called *tee-totallers* has assumed the name of *Rechabites*.

**RECHARGE, v. t.** [*Fr. recharger*; *re* and *charge*.] To charge again.

**RECHARG'ED, pp.** Charged again.

**RECHARG'ING, ppr.** Charging again.

**RECHARGE, v. t.** [*Fr. recharger*; *re* and *charge*.] 1. To charge or accuse in return.—2. To attack again; to attack anew.

**RECHARG'ED, pp.** Accused in return; attacked anew.

**RECHARG'ING, ppr.** Accusing in return; attacking anew.

**RECHASTENED, a.** Chastened again.

**RECHÊAT, n.** [said to be from old French.] Among *hunters*, a lesson which the huntsman winds on the horn when the hounds have lost the game, to call them back from pursuing a counter scent.

**RECHÊAT, v. t.** To blow the recheat.

**RECHERCHE', a.** [*Fr.*] Much sought after; out of the common; as the book is very *recherché*.

**RECHOOSE, v. t.** (rechooz'.) To choose a second time.

**RECHÔSEN, pp. or a.** (recho'zn.) Re-elected; chosen again.

**RECIDI'VATE, v. i.** [*L. recidivo*.] To backslide; to fall again.

**RECIDI'VATION, n.** [*L. recidivus*, from *recido*, to fall back; *re* and *cado*, to fall.] A falling back; a backsliding. [Not much used.]

**RECIDI'VOUS, a.** [*L. recidivus*.] Subject to backslide. [Little used.]

**RECIPE, n.** (res'ipy.) [*L.* imperative of *recipio*, to take.] The first word of a physician's prescription; hence, the prescription itself. Its abbreviation is *R* or *℞*, which is a relic of the astrological symbol of Jupiter.

**RECIP'IENT, n.** [*L. recipiens*, *recipio*.] 1. A receiver; the person or thing that receives; he or that to which any thing is communicated.—2. The receiver of a still.

**RECIP'ROCAL, a.** [*L. reciprocus*; *Fr. réciproque*.] 1. Acting in vicissitude or return; alternate.

Corruption is *reciprocal* to generation.

*Bacon*.

2. Mutual; done by each to the other; as, *reciprocal* love; *reciprocal* benefits or favours; *reciprocal* duties; *reciprocal* aid.—3. Mutually interchangeable.

These two rules will render a definition *reciprocal* with the thing defined. *Watts*.

*Reciprocal terms*, in *logic*, those terms that have the same signification, and consequently are convertible and may be used for each other.—*Reciprocal quantities*, in *math.*, are those which, multiplied together, produce unity.—*Reciprocal figures*, in *geom.*, are two figures of the same kind (triangles, parallelograms, prisms, pyramids, &c.) so related that two sides of the one form the extremes of an analogy of which the *means* are the two corresponding sides of the other.—*Reciprocal ratio* is the ratio between the reciprocals of two quantities; as, the *reciprocal ratio* of 4 to 9, is that of  $\frac{1}{4}$  to  $\frac{1}{9}$ .—*Reciprocal proportion* is when of four terms taken in order, the first has to the second the same ratio which the fourth has to the third; or when the first has to the second the same ratio which the reciprocal of the third has to the reciprocal of the fourth. In works of arithmetic the case which gives rise to this class of relations is called *Inverse Proportion*, or the *Rule of Three Inverse*.—*Reciprocal equations*, those which contain several pairs of roots which are the reciprocal of each other.

**RECIP'ROCAL, n.** The *reciprocal* of any quantity is unity divided by that quantity. Thus, the *reciprocal* of 4 is  $\frac{1}{4}$ , and conversely the *reciprocal* of  $\frac{1}{4}$  is 4. A fraction made by inverting the terms of another fraction is called the

*reciprocal* of that other fraction; thus,  $\frac{4}{3}$  is the reciprocal of  $\frac{3}{4}$ .

**RECIP'ROCALLY, adv.** Mutually; interchangeably; in such a manner that each affects the other and is equally affected by it.

These two particles do *reciprocally* affect each other with the same force. *Bentley*.

2. In *math.* and *physics*, an epithet for quantities which are so related that when one increases the other diminishes in the same proportion, and *vice versa*: thus, in bodies of the same weight the density is *reciprocally* as the magnitude; that is, the greater the magnitude the less the density, and the less the magnitude the greater the density. *Inversely* is used in the same sense. [See *RATIO*.] In *geom.*, two magnitudes are said to be *reciprocally* proportional to two others, when one of the first pairs is to one of the second as the remaining one of the second is to the remaining one of the first.

**RECIP'ROCALNESS, n.** Mutual return; alternateness.

**RECIP'ROGATE, v. i.** [*L. reciprocō*; *Fr. réciproquer*.] To act interchangeably; to alternate.

One bravuwy smith the puffing bellows plies,  
And draws and blows *reciprocating* air.

*Dryden*.

**RECIP'ROGATE, v. t.** To exchange; to interchange; to give and return mutually; as, to *reciprocate* favours.

**RECIP'ROGATED, pp.** Mutually given and returned; interchanged.

**RECIP'ROGATING, ppr.** Interchanging; each giving or doing to the other the same thing.

**RECIP'ROGATING MOTION, n.** In *mech.*, a mode of action frequently employed in the transmission of power from one part of a machine to another. A rigid bar is suspended upon a centre or axis, and the parts situated on each side of the axis take alternately the positions of those on the other. The working beam of a steam engine is a familiar example.—*Reciprocating system*, in *railways*, the method of communicating motion to trains by means of stationary engines, instead of locomotive ones.

**RECIPROCA'TION, n.** [*L. reciprocatio*.] 1. Interchange of acts; a mutual giving and returning; as, the *reciprocation* of kindnesses.—2. Alternation; as, the *reciprocation* of the sea in the flow and ebb of tides.—3. Regular return or alternation of two symptoms or diseases.

**RECIPROCI'TY, n.** [*Fr. réciprocity*.] Reciprocal obligation or right; equal mutual rights or benefits to be yielded or enjoyed. The commissioners offered to negotiate a treaty on principles of *reciprocity*.—*Law of reciprocity*, a term employed by Legendre in his "Théorie des Nombres" to denote a reciprocal law that has place between prime numbers of different forms, which is this, that *m* and *n* being prime odd

numbers, the remainder of  $u^{\frac{n-1}{2}} \div n$

= the remainder of  $n^{\frac{m-1}{2}} \div m$ .

**RECIS'ION, n.** (*s* as *z*.) [*L. recisio*, from *recido*, to cut off; *re* and *cado*.] The act of cutting off.

**RECITAL, n.** [from *recite*.] Rehearsal; the repetition of the words of another or of a writing; as, the *recital* of a deed; the *recital* of testimony.—2. Narration; a telling of the particulars of

an adventure or of a series of events.—

3. Enumeration.

**RECITATION**, *n.* [L. *recitatio*.] 1. Rehearsal; repetition of words.—2. In colleges and schools, the rehearsal of a lesson by pupils before their instructor. **RECITATIVE**, *a.* [Fr. *recitatif*; It. *recitativo*. See **RECITE**.] Reciting; rehearsing; pertaining to musical pronunciation.

**RECITATIVE**, *n.* Language delivered in musical tones; or, as the Italians define it, speaking music. It is used in operas, &c. to express some action or passion, or to relate a story or reveal a secret or design. It differs from an air in having no fixed time or measure; and it is not governed by any principal or predominant key, though its final cadence or close must be in some cognate key of the air which follows, or, at least, in no very remote key. There are two kinds of recitative, *unaccompanied* and *accompanied*. The first is when a few occasional chords are struck by the piano-forte or violoncello to give the singer the pitch, and intimate to him the harmony. The second is when all, or a considerable portion, of the instruments of the orchestra accompany the singer, either in sustained chords or florid passages, in order to give the true expression or colouring to the passion or sentiment to be expressed.

**RECITATIVELY**, *adv.* In the manner of recitative.

**RECITATIVO**, *n.* [Ital.] Recitative, —*which* see.

**RECITE**, *v. t.* [L. *recito*; *re* and *cito*, to call or name.] 1. To rehearse; to repeat the words of another or of a writing; as, to *recite* the words of an author or of a deed or covenant.—2. In writing, to copy; as, the words of a deed are *recited* in the pleading.—3. To tell over; to relate; to narrate; as, to *recite* past events; to *recite* the particulars of a voyage.—4. To rehearse, as a lesson to an instructor.—5. To enumerate.

**RECITE**, *v. i.* To rehearse a lesson. The class will *recite* at eleven o'clock.

**RECITE**, *f.* for **Recital**.

**RECITED**, *pp.* Rehearsed; told; repeated; narrated.

**RECITER**, *n.* One that recites or rehearses; a narrator.

**RECITING**, *ppr.* Rehearsing; telling; repeating; narrating.

**RECK**, *v. i.* [Sax. *reccan*, *reccan*, to say, to tell, to narrate, to reckon, to care, to rule or govern, L. *rego*. The primary sense is to strain. *Care* is a straining of the mind. See **RACK** and **RECKON**.] To care; to mind; to heed; to rate at much; as we say, to *reckon* much of; followed by *of*.

Thou'st but a lazy loorde,  
And *recks* much of thy swinke. *Spenser*.  
I *reck* as little what betideth me,  
As much I wish all good befortune you. *Shak.*

Of night or loneliness it *recks* me not. *Millon*.

**RECK**, *v. t.* To heed; to regard; to care for.

This son of mine not *recking* danger. *Sidney*.

[This verb is obsolete unless in poetry. We observe the primary sense and application in the phrase "it *recks* me not," that is, it does not strain or distress me; it does not *reck* my mind; it is not estimated by me; or, I care not. To *reck* danger is a derivative

form of expression, and a deviation from the proper sense of the verb.]

**RECKLESS**, *a.* Careless; heedless; mindless.

I made the king as *reckless*, as them diligent. *Sidney*.

**RECKLESSNESS**, *n.* Heedlessness; carelessness; negligence.

**RECKON**, *v. t.* (rek'n.) [Sax. *reccan*, *reccan*, to tell, to relate, to *reck* or care, to rule, to *reckon*; D. *rechenen*, to count or compute; G. *rechnen*, to count, to reckon, to esteem, and *rechen*, to stretch, to strain, to *rack*; Sw. *räkna*, to count, to tell; Dan. *regner*, to *reckon*, to count, to rain. The Saxon word signifies not only to tell or count, but to *reck* or care, and to rule or govern; and the latter signification proves it to be the L. *rego*, *rectus*, whence *regnum*, *regno*, Eng. to *reign*, and hence Sax. *reht*, *riht*, Eng. *right*, G. *recht*, &c. The primary sense of the root is to strain, and *right* is strained, stretched to a straight line; hence we see that these words all coincide with *reach*, *stretch* and *rack*; and we say, we are *racked* with care. It is probable that *wreck* and *wretched* are from the same root.] 1. To count; to number; that is, to tell the particulars.

The priest shall *reckon* to him the money, according to the years that remain, even to the year of jubilee, and it shall be abated; Lev. xxvii.

I *reckoned* above two hundred and fifty on the outside of the church. *Addison*.

2. To esteem; to account; to repute; Rom. viii.

For him I *reckon* not in high estate. *Millon*.

3. To repute; to set in the number or rank of.

He was *reckoned* among the transgressors; Luke xxii.

4. To assign in an account; Rom. iv.—5. To compute; to calculate.

**RECKON**, *v. i.* To reason with one's self and conclude from arguments.

I *reckoned* till morning, that as a lion, so will he break all my bones; Is. xxxviii.

2. To charge to account; with *on*.

I call posterity  
Into the debt, and *reckon* on her head. *B. Jonson*.

3. To pay a penalty; to be answerable; to give an account; with *for*.

If they fail in their bounden duty, they shall *reckon for* it one day. *Sanderson*.

4. To think; to suppose.—To *reckon with*, to state an account with another, compare it with his account, ascertain the amount of each and the balance which one owes to the other.

After a long time the lord of those servants cometh, and *reckoneth with* them; Matth. xxv.

2. To call to punishment.

God suffers the most grievous sins of particular persons to go unpunished in this world, because his justice will have another opportunity to meet and *reckon with* them. *Tillotson*.

To *reckon on* or *upon*, to lay stress or dependence on. He *reckons on* the support of his friends.

**RECKONED**, *pp.* (rek'nd.) Counted; numbered; esteemed; reputed; computed; set or assigned to in account.

**RECKONER**, *n.* (rek'ner.) One who reckons or computes.

*Reckoners* without their host must reckon twice. *Camden*.

**RECKONING**, *ppr.* (rek'ning.) Counting; computing; esteeming; reputed; stating an account mutually.

**RECK'ONING**, *n.* The act of counting or computing; calculation.—2. An account of time.—3. A statement of accounts with another; a statement and comparison of accounts mutually for adjustment; as in the proverb, "short *reckonings* make long friends."

The way to make *reckonings* even is to make them often. *South*.

4. The charges or account made by a host in a hotel, tavern, &c.

A coin would have a nobler use than to pay a *reckoning*. *Addison*.

5. Account taken; 2 Kings xxii.—6. Esteem; account; estimation.

You make no further *reckoning* of beauty, than of an outward fading benefit nature bestowed. *Sidney*.

7. In navigation, the estimated place of a ship, calculated from the rate as determined by the log, and the course as determined by the compass, the place from which the vessel started being known. *Dead reckoning* means the same as *reckoning*, due allowance being made for drift, lee-way, currents, &c.

**RECK'ONING-BOOK**, *n.* A book in which money received and expended is entered.

**RECLAIM**, *v. t.* [Fr. *reclamer*; I. *reclamo*; *re* and *clamo*, to call. See **CLAIM**.] 1. To claim back; to demand to have returned. The venter may *reclaim* the goods.—2. To call back from error, wandering or transgression, to the observance of moral rectitude; to reform; to bring back to correct deportment or course of life.

It is the tenention of Providence, in its various expressions of goodness, to *reclaim* mankind. *Rogers*.

3. To reduce to the state desired.

Much labour is required in trees, to tame Their wild disorder, and in ranks *reclaim*. *Dryden*.

4. To call back; to restrain.

Or is her tow'ring flight *reclaimed*,  
By seas from Icarus' downfall named? *Prior*.

5. To recal; to cry out against.

The headstrong horses hurried Octavius along, and were deaf to his *reclaiming* them. [Unusual.] *Dryden*.

6. To reduce from a wild to a tame or domestic state; to tame; to make gentle; as, to *reclaim* a hawk, an eagle or a wild beast.—7. To demand or challenge; to make a claim. [A French use.] 8. To recover.—9. In ancient customs, to pursue and recal, as a vassal.—10. To encroach on what has been taken from one; to attempt to recover possession.

A tract of land [Holland] snatched from an element perpetually *reclaiming* its prior occupancy. *Coxe, Switz*.

**RECLAIM**, *v. i.* To cry out; to exclaim.

**RECLAIMABLE**, *a.* That may be reclaimed, reformed, or tamed.

**RECLAIMANT**, *n.* One that opposes, contradicts, or remonstrates against.

**RECLAIMED**, *pp.* Recalled from a vicious life; reformed; tamed; domesticated; recovered.

**RECLAIMING**, *ppr.* Recalling to a regular course of life; reforming; recovering; taking; demanding.—*Reclaiming note*. In the court of session, the lord ordinary's judgments or interlocutors are subject to the review of the division of the court to which the cause belongs, and such review is prayed for by what is termed a *reclaiming note*. In this note the party dissatisfied states the lord ordinary's



interlocutor, and prays the court to alter the same in whole or in part.—

*Reclaiming Petition* in the court of session prior to the Judicature Act, 1825, a well known mode of submitting the interlocutors of lords ordinary to the review of the inner house, and also of submitting the interlocutors of the inner house to their own review. This mode still prevails in the sheriffs' and other inferior courts.—*Reclaiming days*, the period within which the interlocutor of a lord ordinary may be submitted to the review of the inner house, which is twenty-one days.

RECLAIMLESS, *a.* Not to be reclaimed. RECLAMATION, *n.* Recovery.—2. Demand; challenge of something to be restored; claim made.

RECLINANT, *a.* In *her.*, bowed, or bent backwards.

RECLINATE, *a.* [*L. reclinatus.* See RECLINE.] In *bot.*, reclined, as a leaf; bent downward, so that the point of the leaf is lower than the base. A *reclinate* stem is one that bends in an arch toward the earth.

RECLINATION, *n.* The act of leaning or reclining.—2. In *dialling*, the angle which the plane of the dial makes with a vertical plane, which it intersects in a horizontal line.—3. In *sur.*, one of the operations used for the cure of cataract. It consists in making the crystalline lens to turn over into the middle, and towards the bottom of the vitreous humour; so that the surface of the lens which was previously directed forwards, is then placed upwards, and what was the upper edge is turned backwards.

RECLINE, *v. t.* [*L. reclino; re* and *clino*, to lean.] To lean back; to lean to one side or sidewise; as, to *recline* the head on a pillow, or on the bosom of another, or on the arm.

The mother  
Reclined her dying head upon his breast.

*Dryden.*

RECLINE, *v. i.* To lean; to rest or repose; as, to *recline* on a couch.

RECLINE, *a.* [*L. reclinis.*] Leaning; being in a leaning posture.

They sat recline,

On the soft downy bank damask'd with flowers. [*Little used.*] *Milton.*

RECLINED, *pp.* Inclined back or sidewise.

RECLINING, *ppr.* Leaning back or sidewise; resting; lying. — *Reclining stem*, in *bot.*, a stem ascending at first, and then curved downwards, as in the bramble.

RECLINING DIAL, or RECLINER, *n.* A dial whose plane reclines from the perpendicular; and if, besides reclining, it also declines from any of the cardinal points, it is called a *reclining declining dial*.

RECLÔSE, *v. t.* (*s* as *z.*) [*re* and *close.*] To close or shut again.

RECLOSED, *pp.* Closed again.

RECLÔSING, *ppr.* Closing again.

RECLÔDE, *v. t.* [*L. recludo; re* and *claudo, cludo.*] To open; to unclose. [*Little used.*]

RECLUSE, *a.* [*Fr. reclus*, from *L. reclusus, recludo*, but with a signification directly opposite.] Shut up; sequestered; retired from the world or from public notice; solitary; as, a *recluse* monk or hermit; a *recluse* life.

I all the live long day

Consume in meditation deep, *recluse*

From human converse.

*Philips.*

RECLÛSE, *n.* A person who lives in retirement or seclusion from intercourse with the world; as a hermit or monk.—2. A person who confines himself to a cell in a monastery.

RECLÛSELY, *adv.* In retirement or seclusion from society.

RECLÛSENESS, *n.* Retirement; seclusion from society.

RECLÛSION, *n.* (*s* as *z.*) A state of retirement from the world; seclusion.

RECLÛSIVE, *a.* Affording retirement from society.

RECOAGULATION, *n.* [*re* and *coagulation.*] A second coagulation.

RECOAST, *v. t.* To coast back; to return along the same coast.

RECOASTED, *pp.* Returned along the same coast.

RECOASTING, *ppr.* Coasting again or back.

RECOCT†, *a.* [*L. recoctus, recoquo.*] New vamped.

RECOCTION, *n.* A second coction or preparation.

RECOGNITION, *n.* (reconish'on or reconish'on.) [*L. recognitio.*] 1. Acknowledgment; formal avowal; as, the *recognition* of a final concord on a writ of covenant.—2. Acknowledgment; memorial.—3. Acknowledgment; solemn avowal by which a thing is owned or declared to belong to, or by which the remembrance of it is revived.

The lives of such saints had, at the time of their yearly memorials, solemn *recognition* in the church of God. *Hooker.*

4. Knowledge confessed or avowed; as, the *recognition* of a thing present; memory of it as passed.—5. In *Scots law*, the recovery of lands by the proprietor when they fall to him by the fault of the vassal, or generally any return of the feu to the superior, from whatever ground of eviction.

RECOGNITOR, *n.* (recon'itor, or recog'nitor.) One of a jury upon assize.

RECOGNIZABLE, or RECOGNISABLE, *a.* (recon'izable, or recog'nisable), [*from recognize.*] That may be recognized, known, or acknowledged.

RECOGNIZANCE, or RECOGNISANCE, *n.* (recon'izance, or recog'nissance.) [*Fr. reconnaissance.*] 1. Acknowledgment of a person or thing; avowal; profession; as, the *recognition* of Christians, by which they avow their belief in their religion.—2. In *law*, an obligation of record which a man enters into before some court of record or magistrate duly authorized, with condition to do some particular act, as to appear at the assizes, to keep the peace, or pay a debt. This *recognition* differs from a bond, as it does not create a new debt, but it is the acknowledgment of a former debt on record. This is witnessed by the record only, and not by the party's seal. There was also formerly a *recognition* in the nature of a statute staple, acknowledged before either of the chief justices or their substitutes, the mayor of the staple at Westminster and the recorder of London, which is to be enrolled and certified into chancery.—3. The verdict of a jury unimpeded upon assize.

RECOGNIZE, or RECOGNISE, *v. t.* (rec'onize, or rec'ognise.) [*It. riconoscere; Sp. reconocer; Fr. reconnoître; L. recognosco; re* and *cognosco*, to know.] 1. To recollect or recover the knowledge of, either with an avowal of that knowledge or not. We *recog-*

nize a person at a distance, when we recollect that we have seen him before, or that we have formerly known him. We *recognize* his features or his voice.

Speak vassal; *recognize* thy sovereign queen. *Harte.*

2. To review; to re-examine.

RECOGNIZE, or RECOGNISE, *v. i.* (rec'onize, or rec'ognise.) To enter an obligation of record before a proper tribunal. A. B. *recognized* in the sum of twenty pounds.

RECOGNIZED, or RECOGNISED, *pp.* (rec'onized or rec'ognised.) Acknowledged; recollected as known; bound by recognition.

RECOGNIZEE, or RECOGNISEE, *n.* (reconizee', or recognisee'.) The person to whom a recognition is made.

RECOGNIZER, or RECOGNISER, *n.* (rec'ognizer.) One that recognizes.

RECOGNIZING, or RECOGNISING, *ppr.* (rec'onizing, or rec'ognising.) Acknowledging; recollecting as known; entering a recognition.

RECOGNIZOR, or RECOGNISOR, *n.* (reconizor', or recognisor'.) One who enters into a recognition.

*Note.* When the above words are used in the general sense the *g* is sounded; but when they are used in the legal sense the *g* is usually sunk.

RECOIL, *v. i.* [*Fr. reculer*, to draw back; *recol*, a *recoil*; *Arm. gil, guil*, the back part; *W. ciliau*, to recede; *It. rinculare; Sp. regular.*] 1. To move or start back; to roll back; as, a cannon *recoils* when fired; waves *recoil* from the shore.—2. To fall back; to retire.—3. To rebound; as, the blow *recoils*.—4. To retire; to flow back; as, the blood *recoils* with horror at the sight.—5. To start back; to shrink.

Nature *recoils* at the bloody deed.—6. To return. The evil will *recoil* upon his own head.

RECOIL,† *v. t.* To drive back.

RECOIL, *n.* A starting or falling back; as, the *recoil* of nature or the blood.—2. In *artillery*, the rebound or resilience of a fire-arm, or a piece of ordnance when discharged, arising from the exploded powder acting equally on the gun and the ball. Pieces of ordnance are always subject to a recoil according to their sizes, and the charge which they contain.

RECOLLER, *n.* One who falls back from his promise or profession.

RECOILING, *ppr.* Starting or falling back; retiring; shrinking.

RECOILING, *n.* The act of starting or falling back; a shrinking; revolt.

RECOIL'INGLY, *adv.* With starting back or retrocession.

RECOILMENT, *n.* The act of recoiling.

RE'COIN, *v. t.* [*re* and *coin.*] To coin again; as, to *recoin* gold or silver.

RECOINAGE, *n.* The act of coining anew.—2. That which is coined anew.

RECOIN'ED, *pp.* Coined again.

RECOIN'ING, *ppr.* Coining anew.

RECOLLECT, *v. t.* [*re* and *collect; L. recolligo, recollectus.*] 1. To collect again; *applied to ideas* that have escaped from the memory; to recover or call back ideas to the memory. I *recollect* what was said at a former interview; or, I cannot *recollect* what was said.—2. To recover or recall the knowledge of; to bring back to the mind or memory. I met a man whom I thought I had seen before, but I could not *recollect* his name, or the place where I had seen him. I do not

*recollect* you, Sir.—3. To recover resolution or composure of mind.

The Tyrian queen

Admired his fortunes, more admired the man,  
Then *recollected* stood. *Dryden.*

[In this sense, *collected* is more generally used.]

**RECOLLECT'**, *v. t.* To gather again; to collect what has been scattered; as, to *re-collect* routed troops.

**RECOLLECTED**, *pp.* Recalled to the memory.

**RECOLLECTING**, *ppr.* Recovering to the memory.

**RECOLLECTION**, *n.* The act of recalling to the memory, as ideas that have escaped; or the operation by which ideas are recalled to the memory or revived in the mind. *Recollection* differs from *remembrance*, as it is the consequence of volition, or an effort of the mind to revive ideas; whereas *remembrance* implies no such volition. We often *remember* things without any voluntary effort. *Recollection* is called also *reminiscence*.—2. The power of recalling ideas to the mind, or the period within which things can be recollected; remembrance. The events mentioned are not within my *recollection*.—3. In popular language, *recollection* is used as synonymous with *remembrance*.

**RECOLLECTIVE**, *a.* Having the power of recollecting.

**RECOLLET**, or **RECOLLECT**, *n.* [Sp. and Port. *recoleta*.] A monk of a reformed order of Franciscans.

**RECOLONIZATION**, *n.* A second colonization.

**RECOLONIZE**, *v. t.* To colonize a second time.

**RECOLONIZING**, *ppr.* Colonizing a second time.

**RECOMBINATION**, *n.* Combination a second time.

**RECOMBINE**, *v. t.* [*re* and *combine*.] To combine again.

If we *recombine* these two elastic fluids.

*Lavoisier.*

**RECOMBINED**, *pp.* Combined anew.

**RECOMBINING**, *ppr.* Combining again.

**RECOMFORT**, *v. t.* [*re* and *comfort*.] To comfort again; to console anew.—2. To give new strength.

**RECOMFORTED**, *pp.* Comforted again.

**RECOMFORTING**, *ppr.* Comforting again.

**RECOMFORTLESS**, *†a.* Without comfort.

**RECOMMENCE**, *v. t.* (recomens) [*re* and *commence*.] To commence again; to begin anew.

**RECOMMENCED**, *pp.* Commenced anew.

**RECOMMENCING**, *ppr.* Beginning again.

**RECOMMEND'**, *v. t.* [*re* and *commend*; Fr. *recommander*.] 1. To praise to another; to offer or commend to another's notice, confidence or kindness, by favourable representations.

Mæcenas recommended Virgil and Horace to Augustus. *Dryden.*

[In this sense, *commend*, though less common, is the preferable word.] 2. To make acceptable.

A decent boldness ever meets with friends,  
Succeeds, and e'en a stranger recommends.

*Pope.*

3. To commit with prayers.

Paul chose Silas and departed, being recommended by the brethren to the grace of God; Acts xv.

[*Commend* here is much to be preferred.]

**RECOMMEND'ABLE**, *a.* That may be recommended; worthy of recommendation or praise.

**RECOMMEND'ABLENESS**, *n.* The quality of being recommendable.

**RECOMMEND'ABLY**, *adv.* So as to deserve recommendation.

**RECOMMENDATION**, *n.* The act of recommending or of commending; the act of representing in a favourable manner for the purpose of procuring the notice, confidence, or civilities of another. We introduce a friend to a stranger by a *recommendation* of his virtues or accomplishments.—2. That which procures a kind or favourable reception. The best *recommendation* of a man to favour is politeness. Misfortune is a *recommendation* to our pity.—*Letters of recommendation*, letters recommending a third party to the favour or notice of the party addressed.

**RECOMMENDATORY**, *a.* That commends to another; that recommends.

**RECOMMENDED**, *pp.* Praised; commended to another.

**RECOMMENDER**, *n.* One who commends.

**RECOMMENDING**, *ppr.* Praising to another; commending.

**RECOMMISION**, *v. t.* [*re* and *commission*.] To commission again.

Officers whose time of service had expired, were to be *recommissioned*. *Marshall.*

**RECOMMISSIONED**, *pp.* Commissioned again.

**RECOMMISSIONING**, *ppr.* Commissioning again.

**RECOMMIT'**, *v. t.* [*re* and *commit*.] To commit again; as, to *recommit* persons to prison.—2. To refer again to a committee; as, to *recommit* a bill to the same committee.

**RECOMMITMENT**, *n.* A second or renewed commitment; a renewed reference to a committee.

**RECOMMITTED**, *pp.* Committed anew; referred again.

**RECOMMITTING**, *ppr.* Committing again; referring again to a committee.

**RECOMMUNICATE**, *v. i.* [*re* and *communicate*.] To communicate again.

**RECOMPACT'**, *v. t.* [*re* and *compact*.] To join anew.

*Repair*

And *recompact* my scatter'd body.

*Donne.*

**RECOMPACTED**, *pp.* Joined anew.

**RECOMPACTING**, *ppr.* Joining anew.

**RECOMPENSATION**, *†n.* Recompense. In *Scots law*, where one pursues for a debt, and the defender pleads compensation, to which the pursuer replies by pleading compensation also; this is termed *recompensation*.

**RECOMPENSE**, *v. t.* [Fr. *recompenser*; *re* and *compenser*.] 1. To compensate; to make return of an equivalent for any thing given, done, or suffered; as, to *recompense* a person for services, for fidelity or for sacrifices of time, for loss or damages. The word is followed by the *person* or the *service*. We *recompense* a person for his services, or we *recompense* his kindness. It is usually found more easy to neglect than to *recompense* a favour.—2. To requite; to repay; to return an equivalent; in a bad sense.

*Recompense* to no man evil for evil; Rom. xii.

3. To make an equivalent return in profit or produce. The labour of man is *recompensed* by the fruits of the earth.—4. To compensate; to make amends by any thing equivalent.

Solyman said he would find occasion for them to *recompense* that disgrace.

*Knoller.*

5. To make restitution or an equivalent return for; Num. v.

**RECOMPENSE**, *n.* An equivalent returned for any thing given, done, or suffered; compensation; reward; amends; as, a *recompense* for services, for damages, for loss, &c.—2. Requital; return of evil or suffering, or other equivalent; as a punishment.

To me belongeth vengeance and *recompense*; Deut. xxxii.

And every transgression and disobedience received a just *recompense* of reward; Heb. ii.

**RECOMPENSED**, *pp.* Rewarded; requited.

**RECOMPENSING**, *ppr.* Rewarding; compensating; requiting.

**RECOMPLEMENT**, *n.* [*re* and *compilement*.] New compilation or digest; as, a *recompilement* of laws.

**RECOMPOSE**, *v. t.* (*s* as *z*.) [*re* and *compose*.] 1. To quiet anew; to compose or tranquilize that which is ruffled or disturbed; as, to *recompose* the mind.—2. To compose anew; to form or adjust again.

We produced a lovely purple, which we can destroy or *recompose* at pleasure.

*Boyle.*

**RECOMPOSED**, *pp.* Quieted again after agitation; formed anew; composed a second time.

**RECOMPOSING**, *ppr.* Rendering tranquil after agitation; forming or adjusting anew.

**RECOMPOSITION**, *n.* Composition renewed.

**RECONCILABLE**, *a.* Capable of being reconciled; capable of renewed friendship. The parties are not *reconcilable*.—2. That may be made to agree or be consistent; consistent.

The different accounts of the numbers of ships are *reconcilable*. *Arbutnot.*

3. Capable of being adjusted; as, the difference between the parties is *reconcilable*.

**RECONCILABLENESS**, *n.* The quality of being reconcilable; consistency; as, the *reconcilableness* of parts of Scripture which apparently disagree.—2. Possibility of being restored to friendship and harmony.

**RECONCILE**, *v. t.* [Fr. *reconcilier*; L. *reconcilio*; *re* and *concilio*; *con* and *calo*, to call, Gr. *καλω*. The literal sense is to call back into union.] 1. To conciliate anew; to call back into union and friendship the affections which have been alienated; to restore to friendship or favour after estrangement; as, to *reconcile* men or parties that have been at variance.

Propitious now and *reconciled* by prayer. *Dryden.*

Go thy way; first be *reconciled* to thy brother; Matt. v.

We pray you in Christ's stead be ye *reconciled* to God; 2 Cor. v.; Eph. ii.; Col. i.

2. To bring to acquiescence, content, or quiet submission; with *to*; as, to *reconcile* one's self to afflictions. It is our duty to be *reconciled* to the dispensations of Providence.—3. To make consistent or congruous; to bring to

agreement or suitableness; followed by *with* or *to*.

The great men among the ancients understood how to *reconcile* manual labour with affairs of state.

*Locke.* Some figures monstrous and misshaped appear,

Consider'd singly, or beheld too near; Which, but proportion'd to their light and place,

Due distance *reconciles* to form and grace.

*Pope.* 4. To adjust; to settle; as, to *reconcile* differences or quarrels.

RECONCILE, *v. i.* To become reconciled.

RECONCILED, *pp.* Brought into friendship from a state of disagreement or enmity; made consistent; adjusted.

RECONCILEMENT, *n.* Reconciliation; renewal of friendship. Animositities sometimes make *reconciliation* impracticable.—2. Friendship renewed.

No cloud

Of anger shall remain, but peace assured And *reconciliation*.

*Milton.*

RECONCILER, *n.* One who reconciles; one who brings parties at variance into renewed friendship.—2. One who discovers the consistence of propositions.—3. Among *ship-builders*, a mould sometimes used to form the hollow in the top-timber.

RECONCILIATION, *n.* [Fr. from *L. reconciliatio*.] 1. The act of reconciling parties at variance; renewal of friendship after disagreement or enmity.

*Reconciliation* and friendship with God, really form the basis of all rational and true enjoyment.

*S. Miller.*

2. In *Scripture*, the means by which sinners are reconciled and brought into a state of favour with God, after natural estrangement or enmity; the atonement: expiation.

Seventy weeks are determined upon thy people and upon thy holy city, to finish the transgression and to make an end of sin, and to make *reconciliation* for iniquity; Dan. ix.; Heb. ii.

3. Agreement of things seemingly opposite, different, or inconsistent.

RECONCILIATORY, *a.* Able or tending to reconcile.

RECONCILING, *ppr.* Bringing into favour and friendship after variance; bringing to content or satisfaction; showing to be consistent; adjusting; making to agree.

RECONCILING, *n.* The act of bringing into favour and friendship after the parties have been at variance.—2. In *mast-making*, the making one fair surface of two pieces.

RECONDENSATION, *n.* The act of recondensing.

RECONDENSE, *v. t.* [re and *condense*.] To condense again.

RECONDENSED, *pp.* Condensed anew.

RECONDENS'ING, *ppr.* Condensing again.

RECONDITE, *a.* [*L. reconditus, recondo*; *re* and *condo*, to conceal.] 1. Secret; hidden from the view or mental perception; abstruse; as, *recondite* causes of things.—2. Profound; dealing in things abstruse; as, *recondite* studies.

RECONDITORY, *n.* [supra.] A repository; a storehouse or magazine. [*Little used.*]

RECONDUCT, *v. t.* [re and *conduct*.] To conduct back or again:

RECONDUCTED, *pp.* Conducted back or again.

RECONDUCT'ING, *ppr.* Conducting back or again.

RECONFIRM, *v. t.* [re and *confirm*.] To confirm anew.

RECONFIRMED, *pp.* Confirmed anew.

RECONJOIN, *v. t.* [re and *conjoin*.] To join or conjoin anew.

RECONJOIN'ED, *pp.* Joined again.

RECONJOIN'ING, *ppr.* Joining anew.

RECONNOIS'SANCE, *n.* [Fr.] An examination of a tract of country, or of the sea coast; the latter previously to a disembarkation of troops, and the former preparatory to the march of an army, in order either to meet that of the enemy or to take up quarters for the season.

RECONNOIT'RE, *v. t.* [Fr. *reconnoître; re* and *connoître*, to know.] To view; to survey; to examine by the eye; particularly, in *milit. affairs*, to examine the state of an enemy's army or camp, or the ground for military operations.

RECONNOIT'RED, *pp.* Viewed; examined by personal observation.

RECONNOIT'RING, *ppr.* Viewing; examining by personal observation.

RECONQUER, *v. t.* (recon'ker.) [re and *conquer*; Fr. *reconquérir*.] 1. To conquer again; to recover by conquest.—2. To recover; to regain. [*A French use.*]

RECONQUERED, *pp.* Conquered again; regained.

RECONQUERING, *ppr.* Conquering again; recovering.

RECONQUEST, *n.* A second conquest.

RECONSECRATE, *v. t.* [re and *consecrate*.] To consecrate anew.

RECONSECATED, *pp.* Consecrated again.

RECONSECATING, *ppr.* Consecrating again.

RECONSECRA'TION, *n.* A renewed consecration.

RECONSID'ER, *v. t.* [re and *consider*.] To consider again; to turn in the mind again; to review.—2. To annul; to take into consideration a second time and rescind; as, to *reconsider* a motion in a legislative body; to *reconsider* a vote. The vote has been *reconsidered*, that is, rescinded.

RECONSIDERA'TION, *n.* A renewed consideration or review in the mind.—2. A second consideration; annulment; rescission.

RECONSID'ERED, *pp.* Considered again; rescinded.

RECONSID'ERING, *ppr.* Considering again; rescinding.

RECONSOLEATE, † *v. t.* To console or comfort again.

RECONSTRUCT, *v. t.* To construct again; to rebuild.

RECONSTRUCTED, *pp.* Rebuilt.

RECONSTRUCT'ION, *n.* Act of constructing again.

RECONVENE, *v. t.* [re and *convene*.] To convene or call together again.

RECONVENE, *v. i.* To assemble or come together again.

RECONVENED, *pp.* Assembled anew.

RECONVENING, *ppr.* Assembling anew.

RECONVENTION, *n.* In *law*, a contrary action brought by the defendant. In *Scots law*, when an action is brought in Scotland by a foreigner over whom the courts of the country have otherwise no jurisdiction, his adversary in the suit is entitled, by *reconvention*, to sue the foreigner on a counter claim in compensation or extinction of the demand.

RECONVER'SION, *n.* [re and *conversion*.] A second conversion.

RECONVERT, *v. t.* [re and *convert*.] To convert again.

RECONVERTED, *pp.* Converted again.

RECONVERT'ING, *ppr.* Converting again.

RECONVEY, *v. t.* [re and *convey*.] To convey back or to its former place; as, to *reconvey* goods.—2. To transfer back to a former owner; as, to *reconvey* an estate.

RECONVEYANCE, *n.* The act of reconveying or transferring a title back to a former proprietor.

RECONVEYED, *pp.* Conveyed back; transferred to a former owner.

RECONVEYING, *ppr.* Conveying back; transferring to a former owner.

RECORD, *v. t.* [*L. recorder*, to call to mind, to remember, from *re* and *cor, cordis*, the heart or mind; Sp. *recordar*, to remind, also to awake from sleep; Port. to remind, to con a lesson, or get by heart; Fr. *recorder*, to con a lesson, also to *record*.] 1. To register; to enrol; to write or enter in a book or on parchment, for the purpose of preserving authentic or correct evidence of a thing; as, to *record* the proceedings of a court; to *record* a deed or lease; to *record* historical events.—2. To imprint deeply on the mind or memory; as, to *record* the sayings of another in the heart.—3. To cause to be remembered.

So even and morn *recorded* the third day.

*Milton.*

4. † To recite; to repeat.—5. † To call to mind.—6. To celebrate.

RECORD, † *v. i.* To sing or repeat a tune.

REC'ORD, *n.* A register; an authentic or official copy of any writing, or account of any facts and proceedings whether public or private, entered in a book for preservation; or the book containing such copy or account; as, the *records* of statutes or of judicial courts; the *records* of a town or parish; the *records* of a family. In a *popular sense*, the term *records* is applied to all public documents preserved in a recognised repository; but, in the legal sense of the term, *records* are contemporaneous statements of the proceedings of those higher courts of law which are distinguished as courts of record, written upon rolls of parchment. Records are said to be of three kinds:—1. Judicial records; 2. Ministerial records on oath, being offices or inquisitions found; 3. Records made by conveyance or consent, as fines, recoveries, or deeds enrolled. In the *court of session*, a *record* is a judicial minute subscribed by the counsel of the parties in a cause, and by the lord ordinary, whereby the parties mutually agree to hold certain pleadings, as containing their full and final statement of facts and pleas in law. This record forms the basis of the future argument, and of the decision of the cause. The term *records*, in *Scots law*, is usually applied to public registers for decrees of courts, deeds, instruments, and probative writings of every kind.—2. Authentic memorial; as, the *records* of past ages.—*Court of record*, is a court whose acts and judicial proceedings are enrolled on parchment or in books for a perpetual memorial; and their records are the highest evidence of facts, and their truth cannot be

called in question.—*Debt of record*, is a debt which appears to be due by the evidence of a court of record, as upon a judgment or a recognizance.—*Trial by record* is where a matter of record is pleaded, and the opposite party pleads that there is no such record. In this case, the trial is by inspection of the record itself, no other evidence being admissible.

**RECORDARI FA'CIAS LOQUE'LAM.** [L.] In law, a writ to remove proceedings out of an inferior court to the king's (queen's) bench or common pleas. It is directed to the sheriff, and is the common mode by which an action of replevin is transferred from the sheriff's to the superior courts.

**RECORDATION,** † n. [L. *recordatio*.] Remembrance.

**RECORD'ED,** pp. Registered; officially entered in a book or on parchment; imprinted on the memory.

**RECORD'ER,** n. A person whose official duty is to register writings or transactions; one who enrolls or records.—2. In England, the chief judicial officer of a borough and city, exercising within it, in criminal matters, the jurisdiction of a court of record, whence his title is derived. The appointment of recorders is vested in the crown, and the selection is confined to barristers of five years' standing. Also, the title given to the first judicial officer of great corporations; as, the recorder of London, of Bristol, of Berwick. The first-named is exceptionally appointed, viz., by the court of aldermen.—3. Formerly a kind of flute, flagelet, or wind instrument.

The figures of recorders, flutes, and pipes are straight; but the recorder hath a less bore and a greater above and below. *Bacon*.

**RECORD'ING,** ppr. Registering; enrolling; imprinting on the memory.

**RECORD'ING,** n. Act of placing on record; a record.

**RECOUCH,** v. i. [re and couch.] To retire again to a lodge, as lions.

**RECOUNT,** v. t. [Fr. *recomter*; It. *raccontare*; re and count.] To relate in detail; to recite; to tell or narrate the particulars; to rehearse.

Say from these glorious seeds what harvest flows,  
*Recount* our blessings, and compare our woes. *Dryden*.

**RECOUNT'ED,** pp. Related or told in detail; recited.

**RECOUNT'ING,** ppr. Relating in a series; narrating.

**RECOUNTMENT,** n. Relation in detail; recital. [Little used.]

**RECOUR'ED,** † for Recovered or Recovered.

**RECOURSE,** n. [Fr. *recours*; L. *recursus*; re and *cursum*, to run.] Literally a running back; a return.—1. † Return; new attack.—2. A going to with a request or application, as for aid or protection. Children have *recourse* to their parents for assistance.—3. Application of efforts, art, or labour. The general had *recourse* to stratagem to effect his purpose.

Our last *recourse* is therefore to our art. *Dryden*.

4 Access. [Little used.]—5. Frequent passage.—6. In Scots law, the right competent to an assignee or donee under the warrantice of the transaction to recur on the vendor or cedor for relief in case of eviction or of defects inferring warrantice.

**RECOURSE,** † v. i. To return.

**RECOURSEFUL,** † a. Moving alternately.

**RECOVER,** v. t. [Fr. *recouvrer*; L. *recupero*; re and *capiō*, to take.] 1. To regain; to get or obtain that which was lost; as, to *recover* stolen goods; to *recover* a town or territory which an enemy had taken; to *recover* sight or senses; to *recover* health or strength after sickness.

David *recovered* all that the Amalekites had carried away; 1 Sam. xxx.

2. To restore from sickness; as, to *recover* one from leprosy; 2 Kings v.—

3. To revive from apparent death; as, to *recover* a drowned man.—4. To gain by reparation; to repair the loss of, or to repair an injury done by neglect; as, to *recover* lost time.

Good men have lapses and failings to lament and *recover*. *Rogers*.

5. To regain a former state by liberation from capture or possession.

That they may *recover* themselves out of the snare of the devil; 2 Tim. ii.

6. To gain as a compensation; to obtain in return for injury or debt; as, to *recover* damages in trespass; to *recover* debt and cost in a suit at law.—7. To reach; to come to.

The forest is not three leagues off;  
If we *recover* that, we're sure enough. *Shak.*

8. To obtain title to by judgment in a court of law; as, to *recover* lands in ejectment or common recovery.

**RECOVER,** v. i. To regain health after sickness; to grow well; followed by *of* or *from*.

Go, inquire of Baalzebub, the god of Ekron, whether I shall *recover* of this disease; 2 Kings i.

2. To regain a former state or condition after misfortune; as, to *recover* from a state of poverty or depression.—3. To obtain a judgment in law; to succeed in a lawsuit. The plaintiff has *recovered* in his suit.

**RECOVERABLE,** a. That may be regained or recovered. Goods lost or sunk in the ocean are not *recoverable*.

—2. That may be restored from sickness.—3. That may be brought back to a former condition.

A prodigal course  
Is like the sun's, but not like his *recoverable*. *Shak.*

4. That may be obtained from a debtor or possessor. The debt is *recoverable*.

**RECOVERED,** pp. Regained; restored; obtained by judicial decision.

**RECOVEREE,** n. In law, the tenant or person against whom a judgment is obtained in common recovery,—which see.

**RECOVERING,** ppr. Regaining; obtaining in return or by judgment in law; regaining health.

**RECOVEROR,** n. In law, the demandant or person who obtains a judgment in his favour in common recovery.

**RECOVERY,** n. The act of regaining, retaking, or obtaining possession of any thing lost. The crusades were intended for the *recovery* of the holy land from the Saracens. We offer a reward for the *recovery* of stolen goods.—2. Restoration from sickness or apparent death. The patient has a slow *recovery* from a fever. *Recovery* from a pulmonary affection is seldom to be expected. Directions are given for the *recovery* of drowned persons.—3. The capacity of being restored to health. The patient is past *recovery*.—4. The obtaining of right to something by a

verdict and judgment of court from an opposing party in a suit; as, the *recovery* of debt, damages, and costs by a plaintiff, the *recovery* of cost by a defendant; the *recovery* of land in ejectment.—*Common recovery*, in law, is a species of assurance by matter of record, or a suit or action, actual or fictitious, by which lands are recovered against the tenant of the freehold; which recovery binds all persons, and vests an absolute fee-simple in the recoverer. By 3 and 4 Will. 4, c. 74, common recoveries are abolished, and a new mode of conveyance for the use of tenants in tail substituted for them.

**RECREANCY,** n. A cowardly yielding; mean spiritiveness.

**RECREANT,** a. [Norm. *recreant*, cowardly, properly crying out, from *recrier*; that is, begging. See CRAVEN.]

1. Crying for mercy, as, a combatant in the trial by battle; yielding; hence, cowardly; mean spirited.—2. Apostate; false.

Who for so many benefits received,  
Turn'd *recreant* to God, ingrate and false. *Milton*.

**RECREANT,** n. One who yields in combat and cries craven; one who begs for mercy; hence, a mean spirited, cowardly wretch.

**RECREATE,** v. t. [L. *recreo*; re and *creo*, to create; Fr. *recreer*.] 1. To refresh after toil; to reanimate, as languid spirits or exhausted strength; to amuse or divert in weariness.

Painters when they work on white grounds, place before them colours mixed with blue and green to *recreate* their eyes. *Dryden*.

St. John is said to have *recreated* himself with sporting with a tame partridge. *Taylor*.

2. To gratify; to delight.

These ripe fruits *recreate* the nostrils with their aromatic scent. *More*.

3. To relieve; to revive; as, to *recreate* the lungs with fresh air.

**RECREATE,** v. i. To take recreation.

**RECREATE,** v. t. To create or form anew.

On opening the campaign of 1776, instead of reinforcing, it was necessary to *recreate* the army. *Marshall*.

**RECREATED,** pp. Refreshed; diverted; amused; gratified.

**RECREATED,** pp. Created or formed anew.

**RECREATING,** ppr. Refreshing after toil; reanimating the spirits or strength; diverting; amusing.

**RECREATING,** ppr. Creating or forming anew.

**RECREATION,** n. Refreshment of the strength and spirits after toil; amusement; diversion.—2. Relief from toil or pain; amusement in sorrow or distress.

**RECREATION,** n. A forming anew.

**RECREATIVE,** a. Refreshing; giving new vigour or animation; giving relief after labour or pain; amusing; diverting. Choose such sports as are *recreative* and healthful.

Let the music be *recreative*. *Bacon*.

**RECREATIVELY,** adv. With recreation or diversion.

**RECREATIVENESS,** n. The quality of being refreshing or diverting.

**RECREMENT,** n. [L. *recrementum*; probably *re* and *cerno*, to secrete.] Superfluous matter separated from that which is useful; dross; scoria; spume; as, the *recrement* of ore or of the blood.

RECREMENTAL, } *a. Drossy;*  
 RECREMENTAL, } consisting  
 RECREMENTIOUS, } of superfluous matter separated from that which is valuable.  
 RECRIMINATE, *v. i.* [Fr. *recriminer*; *L. re* and *crimino*, to accuse.] 1. To return one accusation with another.

It is not my business to *recriminate*.

*Stillingfleet.*

2. To charge an accuser with the like crime.

RECRIMINATE, *v. t.* To accuse in return.

RECRIMINATING, *ppr.* Returning one accusation with another.

RECRIMINATION, *n.* The return of one accusation with another.—2. In *law*, an accusation brought by the accused against the accuser upon the same fact.

RECRIMINATOR, *n.* He that accuses the accuser of a like crime.

RECRIMINATORY, } *a. Retorting*  
 RECRIMINATIVE, } accusation.

RECROSS, *v. t.* To cross a second time.

RECROSSED, *pp.* Crossed a second time.

RECROSSING, *ppr.* Crossing a second time.

RECRODENCY. See RECRUDESCENCY.

RECRUDESCENCE, } *n.* [from *L. RECRUDESCENCY, } *recrudescens*; re and *crudescere*, to grow raw; *crudus*, raw.] The state of becoming sore again.*

RECRUDESCENT, *a.* Growing raw, sore, or painful again.

RECRUIT, *v. t.* [Fr. *recruter*; *It. re-utare*.] 1. To repair by fresh supplies any thing wasted. We say, food *recruits* the flesh; fresh air and exercise *recruit* the spirits.

Her cheeks glow the brighter, *recruiting* their colour. *Glennville.*

2. To supply with new men any deficiency of troops; as, to *recruit* an army.

RECRUIT, *v. i.* To gain new supplies of any thing wasted; to gain flesh, health, spirits, &c.; as, lean cattle *recruit* in fresh pastures.—2. To gain new supplies of men; to raise new soldiers.

RECRUIT, *n.* The supply of any thing wasted; chiefly, a new raised soldier to supply the deficiency of an army.

RECRUITED, *pp.* Furnished with new supplies of what is wasted.

RECRUITING, *ppr.* Furnishing with fresh supplies; raising new soldiers for an army.

RECRUITING, *n.* The act of raising men for the military or naval service, either to augment the numerical strength of an army or fleet by new levies, or to make good the complement of any regiment or ship.

RECRUITMENT, *n.* The act or business of raising new supplies of men for an army.

RECRYSTALLIZATION, *n.* The process of a second crystallizing.

RECRYSTALLIZE, *v. i.* To crystallize a second time.

RECTANGLE, *n.* [Fr. from *L. re-angulus*; *rectus*, right, and *angulus*, angle.] 1. A right-angled parallelogram, or a quadrilateral figure having all its angles right angles. When the adjacent sides are equal it becomes a square. Every rectangle is said to be contained by any two of the sides about one of its right angles: thus, if A and B represent the sides about one of the

right angles, the figure is said to be contained by A and B; and sometimes

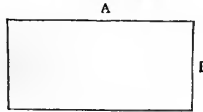

Rectangle.

it is said to be the rectangle under A and B. The area of a rectangle is numerically expressed by the product of the two numbers which express the lengths of its adjacent sides: thus, if the lengths of the two adjacent sides be expressed by 6 feet and 4 feet respectively, the area is equal to  $6 \times 4 = 24$  square feet. The second book of Euclid is devoted to the properties of the rectangle.—2. In *arith.*, the product of two lines multiplied into each other.

RECTANGLED, *a.* Having right angles, or angles of ninety degrees. In *her.*, when the line of length is, as it were, cut off in its straightness by another straight line, which at the intersection makes a right angle, it is then termed *rectangled*.



Rectangled.

RECTANGULAR, *a.* Right angled; having angles of ninety degrees.—*Rectangular figures and solids*, are those which have one or more right angles. With regard to solids, they are commonly said to be rectangular when their axes are perpendicular to the planes of their bases.

RECTANGULARLY, *adv.* With or at right angles.

RECTIFIABLE, *a.* [from *rectify*.] That may be rectified; capable of being corrected or set right; as, a *rectifiable* mistake.

RECTIFICATION, *n.* [Fr. See *RECTIFY*.] The act or operation of correcting, amending, or setting right that which is wrong or erroneous; as, the *rectification* of errors, mistakes, or abuses.—2. In *chem.*, the process of refining or purifying any substance by repeated distillation, which separates the grosser parts; as, the *rectification* of spirits or sulphuric acid.—3. In *geom.*, the determination of a straight line, whose length is equal to a portion of a curve. It is effected by the integral calculus.

RECTIFIED, *pp.* Corrected; set or made right; refined by repeated distillation or sublimation.

RECTIFIER, *n.* One that corrects or amends.—2. One who refines a substance by repeated distillations.—3. In the *English spirit trade*, one who rectifies liquors. [See *RECTIFY*.]—4. An instrument that shows the variations of the compass, and rectifies the course of a ship.

RECTIFY, *v. t.* [Fr. *rectifier*; *L. rectus*, right, and *facio*, to make.] 1. To make right; to correct that which is wrong, erroneous, or false; to amend; as, to *rectify* errors, mistakes, or abuses; to *rectify* the will, the judgment, opinions; to *rectify* disorders.—2. In *chem.*, to refine by repeated distillation or sublimation, by which the fine parts of a substance are separated from the grosser; as, to *rectify* spirit or wine.—3. To *rectify* liquors, in the *English spirit trade*, to convert coarse

corn spirits into gin, brandy, &c., by a sort of factitious process. Turpentine, vitriol, and scores of other ingredients are used to *rectify* (*i. e.* falsify) intoxicating liquors. This is a modern kind of transmutation much practised in London.—4. To *rectify* the globe, is to bring the sun's place in the ecliptic on the globe to the brass meridian, or to adjust it in order to prepare it for the solution of any proposed problem.

RECTIFYING, *ppr.* Correcting; amending; refining by repeated distillation or sublimation.

RECTILINEAL, } *a.* [*L. rectus*, right,  
 RECTILINEAR, } and *linea*, line.] Straight-lined; bounded by straight lines; consisting of a straight line or of straight lines; straight; as, a *rectilinear* figure or course; a *rectilinear* side or way.

RECTILINEOUS, } *a. Rectilinear.*  
 RECTITUDE, *n.* [Fr. from *L. rectus*, right, straight; *It. rettitudine*; *Sp. rectitud*; literally straightness, but not applied to material things.] In *moral-ity*, rightness of principle or practice; uprightness of mind; exact conformity to truth, or to the rules prescribed for moral conduct, either by divine or human laws. Rectitude of *mind* is the disposition to act in conformity to any known standard of right, truth, or justice; rectitude of *conduct* is the actual conformity to such standard. *Perfect rectitude* belongs only to the Supreme Being. The more nearly the *rectitude* of men approaches to the standard of the divine law, the more exalted and dignified is their character. Want of *rectitude* is not only sinful but debasing.

There is a sublimity in conscious *rectitude*—in comparison with which the treasures of earth are not worth naming. *J. Hawes.*

RECTOR, *n.* [*L. rector*, from *rego*, *rectum*, to rule; *Fr. recteur*; *It. rettore*.] 1. A ruler or governor.

God is the supreme *rector* of the world.

*Hale.*

[This application of the word is unusual.]—2. In the *church of England*, a clergyman who has the charge and cure of a parish, and has the parsonage and tithes; or the parson of a parish where the tithes are not inappropriate: in the contrary case, the parson is in a *vicar*.—3. The chief elective officer of some universities, as in France and Scotland. In Scotland, it is still the title of the head-master of a principal school. The heads of Exeter and Lincoln colleges, Oxford, are called *rectors*.—4. The superior officer or chief of a convent or religious house; and among the Jesuits, the superior of a house that is a seminary or college.

RECTORAL, } *a. Pertaining to a*  
 RECTORIAL, } rector.

RECTORSHIP, *n.* The office or rank of a rector.

RECTORY, *n.* A parish church, parsonage, or spiritual living, with all its rights, tithes, and glebes.—2. A rector's mansion or parsonage-house.

RECTRESS, } *n.* [*L. rectorix*.] A  
 RECTRIX, } governess.

RECTRICES, } [*L. rectorix*, a female  
 guide.] The name of the tall feathers of a bird, which like a rudder direct its flight.

RECTUM, *n.* [*L.*] In *anat.*, the third and last of the large intestines, so named from an erroneous notion of the old anatomists that it was straight.

RECTUS, *a.* [*L.* straight.] In *anat.*, a term applied to several parts of the

body, particularly muscles, on account of their direction; as, the *rectus abdominis*; *rectus femoris*; *rectus superior oculi*, &c.

**RECUBATION**, *n.* [*L. recubo*; *re* and *cubo*, to lie down.] The act of lying or leaning. [*Little used.*]

**RECULE**, *v. i.* To recoil. [*See RECOIL.*]

**RECUMB**, *v. i.* [*L. recumbo*; *re* and *cumbo*, to lie down.] To lean; to recline; to repose.

**RECUMBENCE**, *n.* [from *L. recumbens*.] The act of reposing or resting in confidence.

**RECUMBENCY**, *n.* The posture of leaning, reclining, or lying.—2. Rest; repose: idle state.

**RECUMBENT**, *a.* [*L. recumbens*.] 1. Leaning; reclining; as, the *recumbent* posture of the Romans at their meals.—2. Reposing; inactive; idle.—3. In *zool.* and *bot.*, an epithet applied to a part that leans or reposes upon any thing.

**RECUMBENTLY**, *adv.* In a recumbent posture.

**RECUPERABLE**, *a.* Recoverable.

**RECUPERATION**, *n.* [*L. recuperatio*.] Recovery, as of any thing lost.

**RECUPERATIVE**, } *a.* Tending to

**RECUPERATORY**, } recovery; pertaining to recovery.

**RECUR**, *v. i.* [*L. recurro*; *re* and *curro*, to run; *Fr. recourir*.] 1. To return to the thought or mind.

When any word has been used to signify an idea, the old idea will recur in the mind when the word is heard. *Watts.*

2. To resort; to have recourse; followed by *to*.

If to avoid succession in eternal existence, they *recur* to the punctum stans of the schools, they will very little help us to a more positive idea of infinite duration. *Locke.*

**RECÛRE**, *v. t.* [*re* and *cure*] To cure; to recover.

**RECÛRE**, *n.* Cure; recovery.

**RECÛRELESS**, *a.* Incapable of cure or remedy.

**RECURRENCE**, *n.* [*See RECUR.*]

**RECURRENCE**, *n.* Return; as, the *recurrence* of error.—2. Resort; the having recourse.

**RECURRENT**, *a.* [*L. recurrens*.]

1. Returning from time to time; as, *recurrent* pains of a disease.—2. In *crystallography*, a *recurrent* crystal is one whose faces, being counted in annular ranges from one extremity to the other, furnish two different numbers which succeed each other several times, as 4, 8, 4, 8, 4.—3. In *anat.*, the *recurrent nerve* is a branch of the par vagum, given off in the upper part of the thorax, which is reflected and runs up along the trachea to the larynx.

**RECURRING**, *a.* Returning again—

*Recurring or circulating decimals*, in *arith.*, decimals which arise from the expansion of a fraction whose denominator includes one or more prime numbers, as factors, differing from 2 or 5, and not included in the numerator. In this case the same figures are continually repeated in the same order: thus,  $\frac{1}{7} = .181818$ , &c.;  $\frac{1}{11} = .1428571428571$ , &c., *ad infinitum*.

*Recurring series*, in *alge.*, a series in which the coefficients of the successive powers of *x* are formed from a certain number of the preceding coefficients according to some invariable law. Thus,  $x + (a + 1)x + (2a + 2)x^2 + (3a + 3)x^3 + (5a + 5)x^4 + \dots$  is a recurring series.

**RECURSANT**, *a.* [*L. recurso*, to turn backward.] In *her.*, said of an eagle, displayed, with the back toward the spectator's face.—*Recursant volant in pale*, said of an eagle, as it were flying upwards, showing the back to the spectator.



Eagle Recursant displayed.

**RECURSION**, *n.* [*L. recursus*, *recurro*; *re* and *curro*, to run.] Return. [*Little used.*]

**RECURVANT**, *a.* In *her.*, bowed embowed, or curved and recurved.

**RECURVATE**, *v. t.* [*L. recurvo*; *re* and *curvo*, to bend.] To bend back.

**RECURVATE**, } *a.* In *bot.*, bent,

**RECURVATED**, } bowed, or curved

downward; as, a *recurvate* leaf.—2. Bent outward; as, a *recurvate* prickle, awn, petiole, calyx, or corolla.

**RECURVATION**, } *n.* A bending or

**RECURVITY**, } flexure backward.

**RECURVE**, *v. t.* (*recurv'*) [*L. recurvo*, supra.] To bend back.

**RECURVED**, *pp.* Bent back or downward; as, a *recurved* leaf.

**RECURVIROSTRA**, } *n.* [*L. recur-*

**RECURVIROSTRES**, } *vis*, bent

back, and *rostrum*, a beak.] A Linnean genus of birds belonging to the order

Grallatores, and family Longirostres of Cuvier. They are called in English, *avosets*. [*See AVOSET.*]

**RECURVOUS**, *a.* [*L. recurvus*.] Bent backward.

**RECUSANCY**, } *n.* Non-conformity.

**RECUSANCY**, } [*See RECUSANT.*]

**RECUSANT**, } *a.* (*s* as *z*). [*L. recusans*,

**RECUSANT**, } *recuso*, to refuse; *re* and the root of *causa*, signifying to drive. The primary sense is to repel or drive back.] Refusing to acknowledge the supremacy of the king, or to conform to the established rites of the church; as, a *recusant* lord.

**RECUSANT**, } *n.* [*supra.*] In *English*

**RECUSANT**, } *hist.*, a person who refuses to acknowledge the supremacy of the king in matters of religion; as, a popish *recusant*, who acknowledges the supremacy of the pope.—2. One who refuses communion with the church of England; a non-conformist. All that are *recusants* of holy rites. *Holyday.*

*Recusants* are persons who refuse or neglect to attend divine service on Sundays and holidays, according to the forms of the established church. The statutes against recusancy, repealed as regards Roman Catholics and Dissenters, are still unrepealed as to other subjects, though seldom enforced.

**RECUSATION**, *n.* [*L. recusatio*.]

1. Refusal.—2. In *law*, the act of refusing a judge, or challenging that he shall not try the cause, on account of his supposed partiality.

**RECUSE**, *v. t.* (*s* as *z*). [*L. recuso*.] To refuse or reject, as a judge; to challenge that the judge shall not try the cause. [*The practice and the words, under the two foregoing heads, are obsolete.*]

**RED**, *a.* [*Sax. red*, *read*, and *read*, *rude*, *red*, ruddy; *G. roth*; *Ir. ruadh*; *W. rhuz*, red, ruddy; *Sans. rohida*; *Russ. rdeyu*, to redden; *Gr. ερυθρος*, red, and *ρῶδα*, a rose, from its colour; *Ar. warada*, to be present, to enter, to descend, to come, to invade, to blossom, to stain with a rose colour, to

bring to be of a red colour; *Ch. ܪܘܘܘܪܐ*, *verad*, a rose; *Eth. warad*, to descend, to bring down. These Arabic and Ethiopic words are the Heb. and *Ch. ܪܘܘܘܪܐ*, *yarad*, to descend, to bring down, and this is radically the same as *ܪܘܘܘܪܐ*, *redah*, which is rendered in Hebrew, to descend or come down, to decline, to bring down, to subdue, to have dominion; *Ch.* like senses, and to correct, to chastise, to expand or open, to flow, to plough; *Syr.* to go, to walk, to journey, *L. gradior*, also to correct, to teach; [*qu. L. erudio*.] The Arabic gives the sense of *rose*, which may be from opening, as blossoms, a sense coinciding with the Chaldee; and *red* from the same sense, or from the colour of the rose. The Greeks called the Arabian gulf the *Erythraean* or *Red* sea, probably from *Edom* or *Idumea*; improperly applying the meaning of *Edom*, *red*, to the sea, and this improper application has come down to the present time.] Of a bright colour, resembling blood. Red is a simple or primary colour, but of several different shades or hues, as scarlet, crimson, vermilion, orange red, &c. We say, *red* colour, *red* cloth, *red* flame, *red* eyes, *red* cheeks, *red* lead, &c.—*Red book*, the name given to a book containing the names of all persons in the service of the state.—*Red book of the exchequer*, an ancient English record or manuscript containing various treatises relating to the times before the Conquest.—*Red men*, *red people*, *red children*, the aboriginals of America, as distinguished from the *whites*.

**RED**, *n.* A red colour; as, a brighter colour, the best of all the *reds*.—2. In *physics* or *optics*, one of the simple or primary colours of natural bodies, or rather of the rays of light. The red rays are the least refrangible of all the rays of light, and hence Newton concluded that the red rays consist of the largest luminous particles. [*See COLOUR, LIGHT, SPECTRUM.*]

**REDACT**, *v. t.* [*L. redactus*, *redigo*; *red*, *re*, and *ago*.] To force; to reduce to form.

**REDACTEUR**, *n.* [*Fr.*] One who arranges MSS. and prepares them for publication; an editor.

**REDACTION**, *n.* [*Fr.*] Arranging and preparing MS. for the press; editing.

**REDAN**, *n.* [*Fr.* written sometimes *redent* and *redens*; said to be contracted from *L. redens*.] In *field fort.*, the simplest kind of work employed, consisting of two parapets of earth raised



Redan.



Queue d'hyronde.

so as to form a salient angle, with the apex towards the enemy and unprotected on the rear. Two *redans* connected form a *queue d'hyronde*, and three connected, form a *bonnet de prêtre*. Several *redans* connected by certain form lines of intrenchment.—2. A projection in a wall on uneven ground to render it level.

**RED ANTIMONY ORE**. An oxy sulphuret of antimony.

**RED ARGUE**, *v. t.* [*L. redarguo*; *red*, *re*, and *arguo*.] To repute.

**REDARGUTION**, *n.* [*supra.*] Refutation; conviction.

**RED'ASH, n.** A species of ash, the *Frazinus tomentosa*, very common in the northern and middle states of the U. S. of North America.

**RED'BAY, n.** A species of laurel, the *Laurus carolinensis*, found in the Carolinas, in Georgia, and Virginia. Its timber is employed along with red cedar in ship-building.

**RED'BEECH, n.** A species of beech, the *Fagus ferruginea*, found in several of the North American states.

**RED-BERRIED, a.** Having or bearing red berries; as, *red-berried* shrub cassia.

**RED-BIRD, n.** The popular name of several birds in the United States, as the *Tanagra aestiva* or summer red-bird, the *Tanagra rubra*, and the Baltimore oriole or hang-nest.

**RED'BREAST, n.** A bird so called from the colour of its breast, a species of Motacilla, the *M. rubecola*, Linn. The fame of this well known bird has arisen from its habit of seeking the aid of man during the winter season, when it becomes so tame as to enter dwelling houses without dread and pick up crumbs. In this country it is known as the *Robin-redbreast*. It is the *Sylvia rubecola* of modern ornithologists.

**RED'BUD, n.** A plant or tree of the genus Cercis.

**RED-CHALK, n.** A kind of clay iron-stone; reddle.

**RED-COAT, n.** A familiar name given to a soldier; because in most British regiments red coats are worn.

**RED-COATED, a.** Wearing red coats.

**RED'CO'RAL, n.** A branched zoophyte, somewhat resembling in miniature a tree deprived of its leaves and twigs.

**RED'DEER, n.** The common stag (*Cervus elaphus*), a native of the whole of the forests of Europe and Asia where the climate is temperate. Red



Red Deer (*Cervus elaphus*).

deer were in former times very abundant in the forests of England and Scotland, and were special objects of the chase, but they are now rare.

**REDDEN, v. t.** (red'n.) [from *red.*] To make red.

**REDDEN, v. i.** (red'n.) To grow or become red.

The coral *redden*, and the ruby glow.

Pope.

2. To blush from modesty or shamefacedness.—3. To have the visage flushed with anger.

Appius *reddens* at each word you speak.

Pope.

**RED'DENED, pp.** Made red; grown red.

**RED'DENING, ppr.** Making or becoming red.

**REDDEN'DO.** [L.] In *Scots law*, the

technical name of a clause indispensable to an original charter, and usually inserted in charters by progress. It takes its name from the first word of the clause in the Latin charter, *Reddendo inde annuatim*, &c.; and it specifies the feu-duty, and other services which have been stipulated to be paid or performed by the vassal to his superior.

**REDDEND'UM, n.** [L. to be returned.] In *law*, the clause by which rent is reserved in a lease.

**RED'DIDIT SE.** [L.] In *law*, a term used in cases where a man *delivers himself* in discharge of his bail.

**RED'DISH, a.** Somewhat red; moderately red; Lev. xiii.

**RED'DISHNESS, n.** Redness in a moderate degree.

**REDDI'TION, n.** [L. *reddo*, to return.] 1. A returning of any thing; restitution; surrender.—2. Explanation; representation.

**RED'DITIVE, a.** [L. *redditivus*, from *reddo*.] Returning; answering to an interrogative; a *term of grammar*.

**RED'DLE, n.** [from *red.*] Red chalk; a species of argillaceous iron-stone ore. It occurs in opaque masses having a compact texture. It is dry and rough to the touch, adhering to the tongue and yielding an argillaceous odour. It is used as a pigment of a florid colour, but not of a deep red.

**RED DYES, n.** Those substances employed in dyeing to produce red colours; as, *dragon's blood*, or *draconine*, *santaline*, *anchusine*, *safflower*, *madder*, *alizarine*, *hematoxyline*, *breziline*, &c.

**REDE, † n.** [Sax. *red.*] Counsel; advice.

**REDE, v. t.** [A. Sax. *raedan*, to give counsel.] To counsel; to advise; to explain; to unfold. [Scotch.]

**REDE, } v. t.** [Suio-Goth. *reda*, to un-

**REDD, } fold.]** To disentangle; to unravel; to clear away, to put in order. [Scotch.]

**REDEEM, v. t.** [L. *redimo*; *red, re*, and *emo*, to obtain or purchase.] 1. To purchase back; to ransom; to liberate or rescue from captivity or bondage, or from any obligation or liability to suffer or to be forfeited, by paying an equivalent; as, to *redeem* prisoners or captured goods; to *redeem* a pledge.—2. To repurchase what has been sold; to regain possession of a thing alienated, by repaying the value of it to the possessor.

If a man [shall] sell a dwelling-house in a walled city, then he may *redeem* it within a whole year after it is sold; Lev. xxv.

3. To rescue; to recover; to deliver from.

Th' Almighty from the grave  
Hath me *redeem'd*. Sandys.  
*Redeem* Israel, O God, out of all his  
troubles; Ps. xxv; Deut. vii.

The mass of earth not yet *redeem'd* from chaos. S. S. Smith.

4. To compensate; to make amends for.

It is a chance which does *redeem* all sorrows. Shak.

By lesser ills the greater to *redeem*. Dryden.

5. To free by making atonement.

Thou hast one daughter,  
Who *redeems* nature from the general curse. Shak.

6. To pay the penalty of.

Which of you will be mortal to *redeem*  
Man's mortal crime? Milton.

7. To save.

He could not have *redeem'd* a portion of his time for contemplating the powers of nature. S. S. Smith.

8. To perform what has been promised; to make good by performance. He has *redeem'd* his pledge or promise.—9. In *law*, to recall an estate, or to obtain the right to re-enter upon a mortgaged estate by paying to the mortgagee his principal, interest, and expenses or costs.—10. In *theol.*, to rescue and deliver from the bondage of sin and the penalties of God's violated law, by obedience and suffering in the place of the sinner, or by doing and suffering that which is accepted in lieu of the sinner's obedience.

Christ hath *redeem'd* us from the curse of the law, being made a curse for us; Gal. iii.; Tit. ii.

11. In *com.*, to purchase or pay the value in specie, of any promissory note, bill, or other evidence of debt, given by the state, by a company or corporation, or by an individual. The credit of a state, a banking company, or individuals, is good when they can *redeem* all their stock, notes, or bills, at par.—*To redeem time*, is to use more diligence in the improvement of it; to be diligent and active in duty and preparation; Eph. v.

**REDEEMABLE, a.** That may be redeemed; capable of redemption.—2. That may be purchased or paid for in gold and silver, and brought into the possession of government or the original promiser; as, a *redeemable* annuity.—*Redeemable rights*. In *Scots law*, those conveyances in property or in security which contain a clause, whereby the granter, or any other person therein named, may, on payment of a certain sum, redeem the lands or subjects conveyed.

**REDEEMABLENESS, n.** The state of being redeemable.

**REDEEMED, pp.** Ransomed; delivered from bondage, distress, penalty, liability, or from the possession of another, by paying an equivalent.

**REDEEMER, n.** One who redeems or ransoms.—2. The Saviour of the world, JESUS CHRIST.

**REDEEMING, ppr.** Ransoming; procuring deliverance from captivity, capture, bondage, sin, distress, or liability to suffer, by the payment of an equivalent.

**REDEEMING, a.** That does or may redeem; as, a *redeeming* act; *redeeming* love.

**REDELIB'ERATE, v. i.** [*re* and *deliberate*.] To deliberate again.

**REDELIB'ERATE, † v. t.** To reconsider.

**REDELIV'ER, v. t.** [*re* and *deliver*.] To deliver back.—2. To deliver again; to liberate a second time.

**REDELIV'ERANCE, n.** A second deliverance.

**REDELIV'ERED, pp.** Delivered back; liberated again.

**REDELIV'ERING, ppr.** Delivering back; liberating again.

**REDELIV'ERY, n.** The act of delivering back; also, a second delivery or liberation.

**REDEMÄND, v. t.** [*re* and *demand*; Fr. *redemander*.] To demand back; to demand again.

**REDEMÄND, n.** A demanding back again.

**REDEMÄNDABLE, a.** That may be demanded back.

**REDEMÁNDED**, *pp.* Demanded back or again.  
**REDEMÁNDING**, *ppr.* Demanding back or again.  
**REDEMISE**, *v. t.* (*s* as *z.*) [*re* and *demise.*] To convey or transfer back, as an estate in fee simple, fee tail, for life, or a term of years.  
**REDEMISE**, *n.* Reconveyance; the transfer of an estate back to the person who has demised it; as, the demise and *redemise* of an estate in fee simple, fee tail, or for life or years, by mutual leases.  
**REDEMISED**, *pp.* Reconveyed, as an estate.  
**REDEMISING**, *ppr.* Reconveying.  
**REDEMP'TION**, *n.* [Fr.; from *L. redemptio.* See **REDEM.**] 1. Repurchase of captured goods or prisoners; the act of procuring the deliverance of persons or things from the possession and power of captors by the payment of an equivalent; ransom; release; as, the *redemption* of prisoners taken in war; the *redemption* of a ship and cargo.—2. Deliverance from bondage, distress, or from liability to any evil or forfeiture, either by money, labour, or other means.—3. Repurchase, as of lands alienated; *Lev. xxv.*; *Jer. xxxii.*—4. The liberation of an estate from a mortgage; or the purchase of the right to re-enter upon it by paying the principal sum for which it was mortgaged, with interest and costs; also, the right of redeeming and re-entering.—*Equity of redemption.* [See **EQUIT.**] In *Scots law*, redemption is the disencumbrance of property, and is applicable to wadsets, annual rent rights, and rights of reversion. [See **REDEEMABLE RIGHTS.**]—5. Repurchase of notes, bills, or other evidence of debt by paying their value in specie to their holders.—6. In *theol.*, the purchase of God's favour by the death and sufferings of Christ; the ransom or deliverance of sinners from the bondage of sin and the penalties of God's violated law by the atonement of Christ.  
 In whom we have *redemption* through his blood; *Eph. i.*; *Col. l.*  
**REDEMP'TIONER**, *n.* In the *U. States*, formerly one who redeemed himself, or purchased his release from debt or obligation to the master of a ship by his services; or one whose services were sold to pay the expenses of his passage to America.  
**REDEMP'TIVE**, *a.* Redeeming.  
**REDEMP'TORISTS**, *n.* A religious order founded in Naples by Liguori in 1732, and revived in Austria in 1820. They devote themselves to the education of youth and the spread of catholicism. They style themselves members of the order of the Holy Redeemer; whence their name.  
**REDEMP'TORY**, *a.* Paid for ransom; as, Hector's *redemptory* price.  
**REDENT'ED**, *a.* Formed like the teeth of a saw; indented.  
**REDESCEND**, *v. i.* [*re* and *descend.*] To descend again.  
**REDESCENDING**, *ppr.* Descending again.  
**RED'EVABLE**, *a.* [Fr.] Indebted.  
**RED'EYE**, *n.* [*red* and *eye.*] A fish of a red colour, particularly the iris.  
**RED FLOWERING MAPLE**, *n.* A species of maple (*Acer rubrum*), common in the United States. The wood is hard and well adapted for the turning lathe. The French Canadians make sugar from this tree.  
**RED'GUM**, *n.* A disease of new-born

infants; an eruption of red pimples in early infancy.  
**RED'-HAired**, *a.* Having hair of a red or sandy colour.  
**RED'-HOT**, *a.* Red with heat; heated to redness; as *red-hot* iron; *red-hot* balls.  
**RED'IENT**, *a.* [*L. rediens, redeo,* to return.] Returning.  
**REDIGEST'**, *v. t.* To digest or reduce to form a second time.  
**REDIGEST'ED**, *pp.* Digested again.  
**REDIGEST'ING**, *ppr.* Digesting a second time; reducing again to order.  
**REDIN'TEGRATE**, *v. t.* [*L. redintegrare; red, re, and integro,* from *integer, whole.*] To make whole again; to renew; to restore to a perfect state.  
**REDIN'TEGRATE**, *a.* Renewed; restored to wholeness or a perfect state.  
**REDIN'TEGRATED**, *pp.* Renewed; restored to entireness.  
**REDIN'TEGRATING**, *ppr.* Restoring to a perfect state.  
**REDINTEGRA'TION**, *n.* Renovation; restoring to a whole or sound state.—2. In *chem.*, the restoration of any mixed body or matter to its former nature and constitution.  
**REDISBURSE**, *v. t.* (*redisburs'*) [*re* and *disburse.*] To repay or refund.  
**REDISPOSE**, *v. t.* (*s* as *z.*) [*re* and *dispose.*] To dispose or adjust again.  
**REDISPOSED**, *pp.* Disposed anew.  
**REDISPOSING**, *ppr.* Disposing or adjusting anew.  
**REDISSEIZIN**, *n.* [*re* and *disseizin.*] In *law*, a writ of *redisseizin* is a writ to recover seizin of lands or tenements against a redisseizor.  
**REDISSEIZOR**, *n.* [*re* and *disseizor.*] A person who disseizes lands or tenements a second time, or after a recovery of the same from him in an action of novel disseizin.  
**REDISSOLVE**, *v. t.* (*redizolv'*) [*re* and *dissolve.*] To dissolve again.  
**REDISSOLV'ED**, *pp.* Dissolved a second time.  
**REDISSOLV'ING**, *ppr.* Dissolving again.  
**REDISTRIB'UTE**, *v. t.* [*re* and *distribute.*] To distribute again; to deal back again.  
**REDISTRIB'UTED**, *pp.* Distributed again or back.  
**REDISTRIB'UTING**, *ppr.* Distributing again or back.  
**REDISTRIBU'TION**, *n.* A dealing back, or a second distribution.  
**RED-LEAD**, *n.* (*red-led.*) [*red* and *lead.*] Minium, a salt composed of one equivalent of deutoxide of lead, which performs the functions of an acid, and two equivalents of protoxide of lead, which performs the functions of a base. Its proper chemical name is diplumbate of lead.  
**RED LIQUOR**, *n.* A crude acetate of alumina employed in calico-printing, and prepared from pyrolignous acid.  
**RED'LY**, *adv.* With redness.  
**RED MARL**, *n.* In *geol.*, another name for new-red sandstone,—*which see.*  
**RED'NESS**, *n.* [Sax. *readnesse.* See **RED.**] The quality of being red; red colour.  
**RED OAK**, *n.* A species of oak (*Quercus rubra*) found in most parts of the North American continent. It is a tall tree growing to the height of eighty feet. The wood is chiefly used for staves, and the bark is used in tanning.  
**RED'OLENCE**, } *n.* [from *redolent.*]  
**RED'OLENCY**, } Sweet scent.  
**RED'OLENT**, *a.* [*L. redolens, redoleo;*

*red, re, and oleo,* to smell.] Having or diffusing a sweet scent.  
**REDONDIL'LA**, *n.* [Sp.] Formerly, a species of versification used in the south of Enrope, consisting of a union of verses of four, six, and eight syllables, of which generally the first rhymed with the fourth, and the second with the third. At a later period, verses of six and eight syllables in general, in Spanish and Portuguese poetry, were called *redondillas*, whether they made perfect rhymes or assonances only. These became common in the dramatic poetry of Spain.  
**REDOUBLE**, *v. t.* (*redub'l.*) [*re* and *double.*] To repeat in return.—2. To repeat often; as, to *redouble* blows.—3. To increase by repeated or continued additions.  
 And *Etna* rages with *redoubled* heat.  
**REDOUBLE**, *v. i.* (*redub'l.*) To become twice as much.  
 The argument *redoubles* upon us.  
**REDOUBLED**, *pp.* (*redub'ld.*) Repeated in return; repeated over and over; increased by repeated or continued additions.  
**REDOUBLING**, *ppr.* (*redub'ling.*) Repeating in return; repeating again and again; increasing by repeated or continued additions.  
**REDOUBT**, *n.* [It. *ridotto*, a shelter, a retreat; Fr. *redoute, réduit*; *L. reductus, reduco,* to bring back; literally, a retreat.] In *field-fort.*, a general name for nearly every class of works wholly inclosed undefended by re-entering or flanking angles. The word is, however, most generally used for a small fort of a square or polygonal shape. It also means any work constructed within another, to serve as a place of retreat for the defenders; as, the *redoubt* of the re-entering places of arms, and of the ravelin in a fortress. [See **F, i, i**, of figure under **RAVELIN.**]  
**REDOUBT'ABLE**, *a.* [Fr. from *redoubter*, to fear or dread, *Arm. dougea, dougein.*] Formidable; that is to be dreaded; terrible to foes; as, a *redoubtable* hero. Hence, the implied sense is valiant.  
**REDOUBT'ED**, } *a.* Formidable.  
**REDUNDA**, *v. i.* [It. *ridondare*; *L. redunda*; *red, re, and undo,* to rise or swell, as waves.] 1. To be sent, rolled, or driven back.  
 The evil, soon  
 Driven back, *redounded* as a flood on those  
 From whom it sprung. *Milton.*  
 2. To conduce in the consequence; to contribute; to result.  
 The honour done to our religion ultimately *redounds* to God, the author of it. *Rogers.*  
 3. To proceed in the consequence or effect; to result.  
 There will no small use *redound* from them to that manufacture. *Addison.*  
**REDOUND'ING**, *ppr.* Conducing; contributing; resulting.  
**RED OXIDE OF COPPER**. A compound of copper and oxygen, found of peculiar beauty in the mines of Cornwall. It is very similar to copper in colour. Its equivalent is 71.2.  
**RED OXIDE OF MANGANESE**. A compound of manganese and oxygen, which may be formed by exposing the

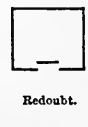

Redoubt



peroxide or sesquioxide to a white heat. It is the cause of the rich colour of the amethyst.

**RED PINE, n.** A species of pine (*Pinus rubra*), also called Norway pine. Its



Red Pine (*Pinus rubra*).

wood is frequently employed in naval architecture, and affords masts for the largest ships.

**RED POLE, n.** A bird with a red head or poll, of the genus *Fringilla*.

**RED PRECIPITATE, n.** The peroxide of mercury, obtained by the decomposition of nitrate of mercury by heat.

**REDRÄFT, v. t.** [*re* and *draft*.] To draw or draft anew.

**REDRÄFT, n.** A second draft or copy.—2. In the *French commercial code*, a new bill of exchange which the holder of a protested bill draws on the drawer or indorsers, by which he reimburses to himself the amount of the protested bill with costs and charges.

**REDRÄFTED, pp.** Drafted again; transcribed into a new copy.

**REDRÄFTING, ppr.** Redrawing; drafting or transcribing again.

**REDRAW, v. t.** [*re* and *draw*.] To draw again. In *com.*, to draw a new bill of exchange, as the holder of a protested bill, on the drawer or indorsers.—2. To draw a second draft or copy.

**REDRESS, v. t.** [*Fr. redresser; re* and *dress*.] 1. To set right; to amend.

In yonder spring of roses,  
Find what to redress till noon. *Milton*.  
[In this sense, as applied to material things, rarely used.]—2. To remedy; to repair; to relieve from, and sometimes to indemnify for; as, to redress wrongs; to redress injuries; to redress grievances. Sovereigns are bound to protect their subjects, and redress their grievances.—3. To ease; to relieve; as, she laboured to redress my pain. [We use this verb before the person or the thing. We say, to redress an injured person, or to redress the injury. The latter is most common.]

**REDRESS, n.** Reformation; amendment.

For us the more necessary is a speedy redress of ourselves. *Hooker*.  
[This sense is now unusual.]—2. Relief; remedy; deliverance from wrong, injury, or oppression; as, the redress of grievances. We applied to government, but could obtain no redress.

There is occasion for redress when the cry is universal. *Davenant*.

3. Reparation; indemnification. [This sense is often directly intended or implied in redress.]—4. One who gives relief.

Fair majesty, the refuge and redress  
Of those whom fate pursues and wants  
oppress. *Dryden*.

**REDRESS'ED, pp.** Remedied; set right; relieved; indemnified.

**REDRESS'ER, n.** One who gives redress.

**REDRESS'IBLE, a.** That may be redressed, relieved, or indemnified.

**REDRESS'ING, ppr.** Setting right; relieving; indemnifying.

**REDRESS'IVE, a.** Affording relief.

**REDRESS'LESS, a.** Without amendment; without relief.

**REDRESS'MENT, n.** Redress; act of redressing.

**RED ROAN, n.** The name given by farmers to the reddish colour on the ears of barley before it is ripe.

**RED SANDAL WOOD, or RED SAUNDERS or SANDERS WOOD.** See SANDAL WOOD.

**REDSEAR, v. i.** [*red* and *sear*.] To break or crack when too hot, as iron under the hammer; a term of workmen.

**RED'SHANK, n.** A bird of the genus *Scolopax*, the *S. calidris* of Linn., belonging to the longirostral tribe of the grallatores.—2. A contemptuous appellation for bare-legged persons, and in former times applied by the English to the Scotch Highlanders.

**RED'SHANKS, n.** A British plant of the genus *Tillæa*, the *T. muscosa*, called also mossy tillæa. It is a minute succulent plant, growing on moist, barren, sandy heaths in various parts of England. Nat. order *Crassulaceæ*.

**RED'SHORT, a.** [*red* and *short*.] Brittle, or breaking short when red hot, as a metal; a term of workmen.

**RED-SIL'VER, n.** Red malacca blend.

**RED'START, n.** [*red* and *start*, Sax.

**RED'TAIL, n.** } *steort*, a tail.] In *ornith.*, a species of warbler, the *Sylvia*



Redstart (*Sylvia phoeniceus*).

*phoeniceus*, also known by the names of red warbler or red robin.

**RED'STREAK, n.** [*red* and *streak*.] A sort of apple, so called from its red-streaked skin.—2. Cyder pressed from the redstreak apples.

**REDUCE, v. t.** [*L. reduco; re* and *duco*, to lead or bring; *Fr. reduire; It. ridurre or ridurre; Sp. reducir*.] 1. † Literally, to bring back; as, to reduce these bloody days again.—2. To bring to a former state.

It were but just  
And equal to reduce me to my dust. *Milton*.

3. To bring to any state or condition, good or bad; as, to reduce civil or ecclesiastical affairs to order; to reduce

a man to poverty; to reduce a state to distress; to reduce a substance to powder; to reduce a sum to fractions; to reduce one to despair.—4. To diminish in length, breadth, thickness, size, quantity, or value; as, to reduce expenses; to reduce the quantity of any thing; to reduce the intensity of heat; to reduce the brightness of colour or light; to reduce a sum or amount; to reduce the price of goods; to reduce the strength of spirit.—5. To lower; to degrade; to impair in dignity or excellence.

Nothing so excellent but a man may fasten on something belonging to it, to reduce it. *Tillotson*.

6. To subdue; to bring into subjection. The Romans reduced Spain, Gaul, and Britain by their arms.—7. To reclaim to order.—8. To bring, as into a class, order, genus, or species; to bring under rules or within certain limits of description; as, to reduce animals or vegetables to a class or classes; to reduce men to tribes; to reduce language to rules.—9. In *arith.*, to change numbers from one denomination into another without altering their value; or to change numbers of one denomination into others of the same value; as, to reduce a shilling to forty-eight farthings, or forty-eight farthings to a shilling.—10. In *alge.*, to reduce equations, is to clear them of all superfluous quantities, bring them to their lowest terms, and separate the known from the unknown, till at length the unknown quantity only is found on one side and the known ones on the other.—11. In *metallurgy*, to bring back metallic substances which have been combined, into their original state of metals.—12. In *sur.*, to restore to its proper place or state a dislocated or fractured bone.—To reduce a figure, design, or draught, to make a copy of it smaller than the original, but preserving the form and proportion. In *Scots law*, to reduce a deed, writing, &c., is to set it aside.

**REDUCED, pp.** Brought back; brought to a former state; brought into any state or condition; diminished; subdued; impoverished.

**REDUCEMENT, n.** The act of bringing back; the act of diminishing; the act of subduing; reduction. [This word is superseded by *Reduction*.]

**REDUC'ENT, a.** Tending to reduce.

**REDUC'ENT, n.** That which reduces.

**REDUCER, n.** One that reduces.

**REDUC'IBLE, a.** That may be reduced.

All the parts of painting are reducible into these mentioned by the author. *Dryden*.

**REDUC'IBLENESS, n.** The quality of being reducible.

**REDUC'ING, ppr.** Bringing back; bringing to a former state, or to a different state or form; diminishing; subduing; impoverishing.

**REDUC'ING SCALE, n.** A broad thin slip of boxwood or ivory, having several lines and scales of equal parts upon it; used by surveyors for turning chains and links into rods and acres by inspection. It is used also for reducing maps and draughts from one dimension to another.

**REDUCT;† v. t.** [*L. reductus, reduco*.] To reduce.

**REDUCT, n.** In *building*, a little place taken out of a larger to make it more regular and uniform, or for some other convenience.

**REDUCTIO AD ABSURD'UM.** See ABSURDUM.

**REDUCTION**, *n.* [Fr. from *L. reductio*.] 1. The act of reducing, or state of being reduced; as, the *reduction* of a body to powder; the *reduction* of things to order.—2. Diminution; as, the *reduction* of the expenses of government; the *reduction* of the national debt.—3. Conquest; subjugation; as, the *reduction* of a province to the power of a foreign nation.—4. In *arith.*, the bringing of numbers of different denominations into one denomination; as, the *reduction* of pounds, ounces, pennyweights and grains, to grains, or the *reduction* of grains to pounds; the *reduction* of days and hours to minutes, or of minutes to hours and days. The change of numbers of a higher denomination into a lower, as of pounds into pence or farthings, is called *reduction descending*; the change of numbers of a lower denomination into a higher, as of farthings and pence into pounds, is called *reduction ascending*. In the first case, multiplication is employed; in the second, division. Hence the rule for bringing sums of different denominations into one denomination is called *reduction*.—5. In *alge.*, *reduction* of equations is the clearing them of all superfluous quantities, bringing them to their lowest terms, and separating the known from the unknown, till the unknown quantity alone is found on one side, and the known ones on the other.—6. *Reduction of a figure, map, &c.* is the making of a copy of it on a smaller scale, preserving the form and proportions. The pentagraph, and the proportional compasses, are the readiest and most accurate helps in performing such reductions.—7. In *sur.*, the operation of restoring a dislocated or fractured bone to its former place.—8. In *metallurgy*, the operation of bringing metallic substances which have been combined, into their natural and original state of metals. This is called also *revivification*.—9. In *Scots law*, an action for setting aside a deed, writing, &c.—*Reduction and reduction-improbation.* The action of simple reduction and the action of reduction-improbation are the two varieties of the rescissory actions of the law of Scotland. The object of this class of actions, is to reduce and set aside deeds, services, decrees, and rights, whether heritable or movable, against which the pursuer of the action can allege and instruct sufficient legal grounds of reduction. [See **IMPROBATION**.]—*Reduction reductive.* An action of reduction reductive is an action in which a decree of reduction, which has been erroneously or improperly obtained, is sought to be reduced.

**REDUCTIVE**, *a.* [Fr. *reductif*.] Having the power of reducing.

**REDUCTIVE**, *n.* That which has the power of reducing.

**REDUCTIVELY**, *adv.* By reduction; by consequence.

**REDUNDANCE**, } *n.* [*L. redundancia*,  
**REDUNDANCY**, } *redundo*. See **REDUNDANT**.] 1. Excess or superfluous quantity; superfluity; superabundance. Labour throws off *redundancies*. *Addition*.  
2. In discourse, superfluity of words.

**REDUNDANT**, *a.* Superfluous; exceeding what is natural or necessary; superabundant; exuberant; as, a *redundant* quantity of bile or food.

Notwithstanding the *redundant* oil in fishes, they do not increase fat so much as flesh.

*Arbutnool.*

*Redundant words*, in writing or discourse, are such as are synonymous with others used, or such as add nothing to the sense or force of the expression.—2. Using more words or images than are necessary or useful.

Where an author is *redundant*, mark those paragraphs to be retrenched. *Watts*.  
3. In *music*, a *redundant* chord is one which contains a greater number of tones, semitones, or lesser intervals, than it does in its natural state, as from *fa* to *sol* sharp. It is called by some authors, a chord extremely sharp.—*Redundant hyperbola*, in *math.*, a line of the third order, having three pairs of asymptotic branches.

**REDUNDANTLY**, *adv.* With superfluity or excess; superfluously; superabundantly.

**REDUPLICATE**, *v. t.* [*L. reduplico*; *re* and *duplico*. See **DUPLICATE**.] To double.

**REDUPLICATE**, *a.* Double.

**REDUPLICATION**, *n.* The act of doubling. In *rhet.*, a figure in which a verse ends with the same word with which the following begins.

**REDUPLICATIVE**, *a.* Double.

**RED WATER**, *n.* A disease in sheep, supposed to be caused by their taking too much watery food, such as turnips, clover, rape, &c. The same name is given by cow-leeches to a disease to which cows are subject, and which is properly inflammation of the kidneys.

**RED WING**, *n.* [*red* and *wing*.] A species of thrush, the *Turdus iliacus*, Linn.

**REDWOOD TREE**, *n.* An East Indian tree of the genus *Soymida*, the *S. febrifuga*, belonging to the nat. order *Cedrelaceae*. It is the *rohuna* of Hindostan, and a useful tonic in intermittent fevers.

**REE**, } *n.* A small Portuguese coin or  
**RE**, } money of account, about one-fifth of an English farthing.

**REE**, } *v. t.* [This belongs to the root of  
**RID**, } *riddle*,—*which see*.] To riddle; to sift; that is, to separate or throw off.

**REE**, *n.* [*A. Sax. reth*, fierce.] Half drunk; tipsy. [*Scotch*.]

**RE-ECH'O**, *v. t.* [*re* and *echo*.] To echo back; to reverberate again; as, the hills *re-echo* the roar of cannon.

**RE-ECH'O**, *v. i.* [*supra*.] To echo back; to return back or be reverberated; as an echo.

And a loud groan *re-echoes* from the main.

*Pope*.

**RE-ECH'O**, *n.* The echo of an echo.

**RE-ECH'OED**, *pp.* [*supra*.] Returned, as sound; reverberated again.

**RE-ECH'OING**, *ppr.* Returning or reverberating an echo.

**REECH'Y**, *a.* [*a* mis-spelling of *Reeky*. See **REEK**.] Tarnished with smoke; sooty; foul; as, a *reechy* neck.

**REED**, *n.* [*Sax. hread*, *reed*; *G. rieth*; *Fr. roseau*; *Ir. readan*; probably allied to *rod*.] 1. A name usually applied indiscriminately to all tall, broad-leaved grasses which grow along the banks of streams, and even to other plants with similar leaves, growing in such situations as the bamboo. Strictly speaking, however, it is the name given to plants of the genus *Arundo*, and especially to the *A. phragmites*, or common reed.

It is the largest of all the grasses of northern climates, and one of the most universally diffused. It is used for various economical purposes, as for thatching, for protecting embankments, or roofing for cottages, &c. There are several other species found in Britain, the most important of which is the *A.*

*arenaria*, sea-reed or mat-grass, which is manufactured into door-mats and floor-brushes. In warm climates, several species acquire a woody stem, which is employed for various economical purposes. The *bur-reed* is of the genus *Sparganium*; the *Indian flowering reed* of the genus *Canna*.—2. A musical pipe, reeds being anciently used for instruments of music.—3. A little tube through which a hautboy, bassoon, or clarinet is blown.—4. An arrow, as made of a reed, headed.—5. Thatch.—6. A weaver's instrument for separating the threads of the warp. It is made of parallel slips of metal or reeds, called dents, which resemble the teeth of a comb. The dents are fixed at their ends into two parallel pieces of wood set a few inches apart.—7. A Jewish measure of three yards, three inches.—*Reed-stops*, the stops of an organ, which consist of pipes furnished with narrow plates of brass.—*Reeds* in fire-ships are made up in small bundles, of about twelve inches in circumference, cut even at both ends, and dipped in a kettle of melted composition to render them easily ignitable.—*Reeds or reedings*, in *arch.*, is the name given to a repetition of equal semi-cylindrical mouldings springing from a plane or cylindrical surface.

**REED BIRD**. See **RICE BIRD**.

**REED-CROWN'ED**, *a.* Crowned with reeds.

**REED**, *a.* Covered with reeds.—2. Formed with channels and ridges like reeds; ornamented with reeds.

**REEDEN**, *a.* (*ree'dn*.) Consisting of a reed or reeds; as, *reeded* pipes.

**REEDGRASS**, *n.* A plant, bur-reed, of the genus *Sparganium*.

**RE-EDIFICATION**, *n.* [from *re-edify*.] Act or operation of rebuilding; state of being rebuilt.

**RE-ED'IFIED**, *pp.* Rebuilt.

**RE-ED'IFY**, *v. t.* [*Fr. réédifier*; *re* and *édify*.] To rebuild; to build again after destruction.

**RE-ED'IFYING**, *ppr.* Rebuilding.

**REEDLESS**, *a.* Destitute of reeds; as, *reedless* banks.

**REEDMACE**, *n.* The *Typha* of Linn., a genus of plants of the class and order *Monœcia triandra*; nat. order *Typhaceæ*. These plants are also known in Britain by the name of cat's tail, and grow in ditches and marshy places, and in the borders of ponds, lakes, and rivers. The great cat's tail or reed-mace (*T. latifolia*) is a very handsome aquatic. On the Continent, the down of the flowers is used for stuffing pillows, &c.; cattle are fond of the leaves, and the roots are sometimes eaten as a salad. The leaves are used by coopers for filling up the interstices between the wood of their casks; also for making mats, chair-bottoms, baskets, &c.

**REEDY**, *a.* Abounding with reeds; as, a *reedy* pool.

**REEF**, *n.* [*D. reef*; *Dan. riv* or *rift*; *Sw. ref*.] These words coincide in orthography with the verb *to rive*; and if from this root, the primary sense is a division, *W. rhiv* and *rhif*. But, in Welsh, *rhêv* signifies a collection or bundle, and thick; *rhervu*, to thicken in compass; and if from this root, a reef is a fold, and *to reef* is to fold.] A certain portion of a sail between the top or bottom and a row of eyelet holes, which is folded or rolled up to contract the sail, when the violence of the wind

renders it necessary. The intention of the reef is to reduce the surface of the sail in proportion to the increase of the wind, for which reason there are several



Wherry with fore-sail reefed, the main-sail showing reef-bands and reef-ties.

reefs parallel to each other in the superior sails, and there are always three or four reefs parallel to the foot or bottom of those main-sails which are extended upon booms.

**REEF**, or **CORAL REEF**, *n.* [G. *riff*; D. *rif*, a reef or sand bank, a carcass, a skeleton. Qn. W. *rhevu*, to thicken.] A chain or range of rocks in various parts of the ocean, lying at or near the surface of the water. [See **CORAL**.]  
**REEF**, *v. t.* [from the noun.] To contract or reduce the extent of a sail by rolling or folding a certain portion of it, and making it fast to the yard.

**REEF-BAND**, *n.* A piece of canvass sewed across a sail, to strengthen it in the part where the eyelet holes are formed. There are usually four reef-bands in each topsail, and two in the fore-sail and main-sail. The reef-band is commonly pierced with two holes in each breadth of canvass in the sail, and through each hole are drawn two reef-points, or short pieces of flat rope.

**REEFED**, *pp.* Having a portion of the top or bottom folded and made fast to the yard.—*Close-reefed*, denotes the position of the sails when all the reefs are taken in.

**REEFING**, *ppr.* Folding and making fast to the yard, as a portion of a sail.  
**REEFING**, *n.* The operation of reducing a sail by taking in one or more reefs.

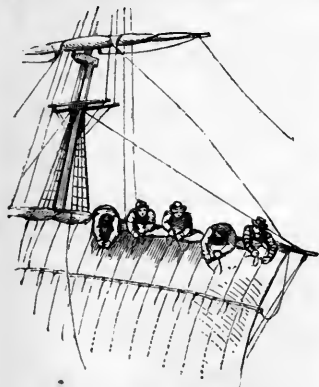

Reefing a Sail.

**REEF-LINE**, *n.* A small rope formerly used to reef the courses by being passed through the holes of the reef spirally.  
**REEF-TACKLE**, *n.* A tackle upon

deck, communicating with its pendant, and passing through a block at the top-mast head, and through a hole in the top-sail-yard-arm, is attached to a cringle below the lowest reef; used to pull the skirts of the top-sails close to the extremities of the yards to lighten the labour of reefing.

**REEFY**, *a.* Full of reefs or rocks.

**REEK**, *n.* [Sax. *rec*; D. *rook*; G. *rauch*; Sw. *rök*; Dan. *rög*.] 1. Vapour; steam. In *Scotland*, smoke.—2. A rick,—*which see*.

**REEK**, *v. i.* [Sax. *recan*, *reocan*; G. *rauchen*; Dan. *röger*, *ryger*, to reek, to smoke; W. *rhogli*, to smell. This may be from the same root as the L. *fragro*, and all coinciding with the Ar. *areega*, to diffuse odour. The primary sense is to send out or emit, to extend, to reach.] To steam; to exhale; to emit vapour; applied especially to the vapour of certain moist substances, rather than to the smoke of burning bodies.

I found me laid

In balmy sweat, which with his beams the sun  
Soon dried, and on the reeking moisture fed.

Milton.

Whose blood yet reeks on my avenging sword.

Smith.

**REEKING**, *ppr.* Steaming; emitting vapour.

**REEKY**, *a.* Smoky; soiled with smoke or steam; foul.

**REEL**, *n.* [Sax. *hreol*, *reol*. See **REEL**, to stagger.] 1. A frame or cylinder turning on an axis, on which lines, threads, &c. are wound. There are various kinds of reels, some very simple, and others very complex. On a reel also seamen wind their log-lines, &c.—2. An angler's instrument attached to the butt of the rod for the purpose of winding in the line when a fish is hooked.—3. A lively dance peculiar to *Scotland*; generally written in common time of four crotchets in a bar, but sometimes in jig time of six quavers.

**REEL**, *v. t.* To gather yarn from the spindle.

**REEL**, *v. i.* [Sw. *ragla*; Ar. *ragala*, to lean.] To stagger; to incline or move in walking, first to one side and then to the other; to vacillate.

He with heavy fumes oppress,

Reel'd from the palace and retired to rest.

Pope.

They reel to and fro, and stagger like a drunken man; Ps. *evii*.

2. To perform the dance called a reel. [See the Noun.]

**RE-ELECT**, *v. t.* [re and *elect*.] To elect again; as, to *re-elect* the former governor.

**RE-ELECTED**, *pp.* Elected again; rechosen.

**RE-ELECTING**, *ppr.* Electing again.

**RE-ELECTION**, *n.* Election a second time, or repeated election; as, the *re-election* of a former representative.

**RE-ELIGIBILITY**, *n.* The capacity of being re-elected to the same office.

**RE-ELIGIBLE**, *a.* [re and *eligible*.] Capable of being elected again to the same office.

**REELING**, *n.* The process of winding thread, silk, cotton, or the like, into a skein, or on a bottom, to prevent its being entangled.

**RE-EMBARK**, *v. t.* [re and *embark*.] To embark or put on board again.

**RE-EMBARK**, *v. i.* To embark or go on board again.

**RE-EMBARKATION**, *n.* A putting on board or a going on board again.

**RE-EMBARKED**, *pp.* Embarked again.

**RE-EMBARKING**, *ppr.* Embarking on board again.

**RE-EMBATTLE**, *v. t.* [re and *embattle*.] To array again for battle; to arrange again in the order of battle.

**RE-EMBATTLED**, *pp.* Arrayed again for battle.

**RE-EMBATTLING**, *ppr.* Arranging again in battle array.

**RE-EMBODIED**, *pp.* Embodied again.

**RE-EMBODY**, *v. t.* [re and *embody*.] To embody again.

**RE-EMBODYING**, *ppr.* Embodying again.

**RE-EMERGE**, *v. i.* To emerge after being plunged, obscured, or overwhelmed.

**REEMING**, *n.* The act of opening the seams between the planks of ships by caulking irons, for the purpose of recaulking them.

**RE-ENACT**, *v. t.* [re and *enact*.] To enact again.

**RE-ENACTED**, *pp.* Enacted again.

**RE-ENACTING**, *ppr.* Enacting anew; passing again into a law.

**RE-ENACTION**, *n.* The passing into a law again.

**RE-ENACTMENT**, *n.* The enacting or passing of a law a second time; the renewal of a law.

**RE-ENFORCE**. See **REINFORCE**.

**RE-ENGAGE**, *v. t.* To engage a second time.

**RE-ENGAGE**, *v. i.* To engage again; to enlist a second time; to covenant again.

**RE-ENGAGED**, *pp.* Engaged a second time.

**RE-ENGAGING**, *ppr.* Covenanting again.

**RE-ENJOY**, *v. i.* [re and *enjoy*.] To enjoy anew or a second time.

**RE-ENJOYED**, *pp.* Enjoyed again.

**RE-ENJOYING**, *ppr.* Enjoying anew.

**RE-ENJOYMENT**, *n.* A second or repeated enjoyment.

**RE-ENKINDLE**, *v. t.* [re and *enkindle*.] To enkindle again; to rekindle.

**RE-ENKINDLED**, *pp.* Enkindled again.

**RE-ENKINDLING**, *ppr.* Enkindling anew.

**RE-ENLIST**, *v. t.* To enlist a second time.

**RE-ENLISTED**, *pp.* Enlisted anew.

**RE-ENLISTING**, *ppr.* Enlisting anew.

**RE-ENLISTMENT**, *n.* A second enlistment.

**RE-ENSTAMP**, *v. t.* To enstamp again.

**RE-ENTER**, *v. t.* [re and *enter*.] To enter again or anew.

**RE-ENTER**, *v. i.* To enter anew.

**RE-ENTER**, *n.* In *engraving*, the passing of the graver into those incisions of the plate, so as to deepen them, where the aquafortis has not bitten in sufficiently.

**RE-ENTERED**, *pp.* Entered again.

**RE-ENTERING**, *ppr.* Entering anew.

—2. Entering in return.—*Re-entering angle*, in *fort.*, the angle of a work whose point turns inwards towards the defended place.

**RE-ENTHrone**, *v. t.* [re and *enthron*.] To enthrone again; to replace on a throne.

**RE-ENTHronED**, *pp.* Raised again to a throne.

**RE-ENTHronEMENT**, *n.* A second enthroning.

**RE-ENTHronING**, *ppr.* Replacing on a throne.

**RE-ENTRANCE**, *n.* [re and *entrance*.] The act of entering again.

**RE-ENTRY**, *n.* In *law*, the resuming

or retaking the possession of lands lately lost.

REERMOUSE, *n.* [Sax. *hreremus.*] A rear-mouse; a bat.

RE-ESTABLISH, *v. t.* [*re* and *establish.*] To establish anew; to fix; or conform again; as, to *re-establish* a covenant; as, to *re-establish* health.

RE-ESTABLISHED, *pp.* Established or confirmed again.

RE-ESTABLISHER, *n.* One who establishes again.

RE-ESTABLISHING, *ppr.* Establishing anew; confirming again.

RE-ESTABLISHMENT, *n.* The act of establishing again; the state of being re-established; renewed confirmation; restoration.

RE-ESTATE, † *v. t.* [*re* and *estate.*] To re-establish.

REEVE, † *n.* [Sax. *gerefu*; G. *graf.*] A steward; a peace officer. This word, though obsolete, enters into the composition of some titles yet in use. Hence, *sheriff*, that is, shire-reeve, the governor of a shire or county, borough-reeve, port-reeve, &c.

REEVE, *n.* A bird, the female of the ruff.

REEVE, *v. t.* In *seamen's lan.*, to pass the end of a rope through any hole in a block, thimble, cleat, ring-bolt, cringle, &c.

REEVING, *n.* In *marine lan.*, the pulling a rope through a block. Hence, to pull a rope out of a block is called *unreeving*.

RE-EXAMINABLE, *a.* That may be re-examined or re-considered.

RE-EXAMINATION, *n.* A renewed or repeated examination.

RE-EXAMINE, *v. t.* [*re* and *examine.*] To examine anew.

RE-EXAMINED, *pp.* Examined again.

RE-EXAMINING, *ppr.* Examining anew.

RE-EXCHANGE, *n.* [*re* and *exchange.*] A renewed exchange.—2. In *com.*, the exchange chargeable on the re-draft of a bill of exchange.

The rate of *re-exchange* is regulated with respect to the drawer, at the course of exchange between the place where the bill of exchange was payable, and the place where it was drawn. *Re-exchanges* cannot be cumulated.

RE-EXPORT, *v. t.* [*re* and *export.*] To export again; to export what has been imported.

RE-EXPORT, *n.* Any commodity re-exported.

RE-EXPORTATION, *n.* The act of exporting what has been imported.

RE-EXPORTED, *pp.* Exported after being imported.

RE-EXPORTING, *ppr.* Exporting what has been imported.

RE-FASHION, *v. t.* To fashion, form, or mould into shape a second time.

RE-FASHIONED, *pp.* Fashioned again.

RE-FASHIONING, *ppr.* Shaping a second time.

REFECT, † *v. t.* [L. *refectus, reficio; re* and *facio*, to make.] To refresh; to restore after hunger or fatigue.

REFECTION, *n.* [Fr. from L. *refectio.*] 1. Refreshment after hunger or fatigue.

—2. A spare meal or repast. In the *lan. of eccles. communities*, a spare meal, sufficient only to maintain life.

REFECTIVE, *a.* Refreshing; restoring.

REFECTIVE, *n.* That which refreshes.

REFECTORY, *n.* [Fr. *refectoire.*] A room of refreshment; properly, a hall or apartment in convents and monasteries, where a moderate repast is taken.

REFEL', *v. t.* [L. *refello.*] To refute; to disprove; to repress; as, to *refel* the tricks of a sophister. [*Little used.*]

REFER', *v. t.* [L. *refero; re* and *fero*, to bear; Fr. *referer.*] 1. To direct, leave, or deliver over to another person or tribunal for information or decision; to betake to for decision or judgment; as when parties to a suit *refer* their cause to another court; or the court *refers* a cause to individuals for examination and report. A person whose opinion is requested, sometimes *refers* the inquirer to another person or other source of information.—2. To reduce as to the ultimate end.

You profess and practice to *refer* all things to yourself.

*Bacon.*  
3. To reduce; to assign; as, to an order, genus, or class. Naturalists are sometimes at a loss to know to what class or genus an animal or plant is to be *referred*.—To *refer one's self*, to betake; to apply. [*Little used.*]

REFER', *v. i.* To respect; to have relation. Many passages of Scripture *refer* to the peculiar customs of the orientals.—2. To appeal; to have recourse; to apply.

In suits it is good to *refer* to some friend of trust.

*Bacon.*  
3. To allude; to have respect to by intimation without naming. I *refer* to a well known fact.

REFERABLE, *a.* That may be referred. [See REFERRIBLE, the proper word.]

REFEREE', *n.* One to whom a thing is referred; particularly, a person appointed by a court to hear, examine, and decide a cause between parties, pending before the court, and make report to the court.

REFERENCE', *n.* A sending, dismissal, or direction to another for information.—2. Relation; respect; view toward.

The Christian religion commands sobriety, temperance, and moderation, in *reference* to our appetites and passions.

*Tillotson.*

3. Allusion to. In his observations he had no *reference* to the case which has been stated.—4. In *law*, the process of assigning a cause depending in court, for a hearing and decision, to persons appointed by the court.

REFERENDARY, *n.* One to whose decision a cause is referred.—2. An officer who delivered the royal answer to petitions.

REFERMENT, † *n.* Reference for decision.

REFERMENT', *v. t.* [*re* and *ferment.*] To ferment again.

REFERRED, *pp.* Dismissed or directed to another; assigned, as to a class, order, or cause; assigned by a court to persons appointed to decide.

REFERRIBLE, *a.* That may be referred; capable of being considered in relation to something else.—2. That may be assigned; that may be considered as belonging to or related to.

It is a question among philosophers, whether all the attractions which obtain between bodies, are *referrible* to one general cause.

*Nicholson.*

REFERRING, *ppr.* Dismissing or directing to another for information; alluding; assigning, as to a class, order, cause, &c.; or assigning to private persons for decision.

REFIND, *v. t.* [*re* and *find.*] To find again; to experience anew.

REFINE, *v. t.* [Fr. *raffiner; re* and *fine.*] 1. To purify; in a general sense; applied to liquors, to dehydrate; to defe-

cate; to clarify; to separate, as liquor, from all extraneous matter. In this sense, the verb is used with propriety, but it is customary to use *fine*.—2. Applied to metals, to separate the metallic substance from all other matter, whether another metal or alloy, or any earthy substance; in short, to detach the pure metal from all extraneous matter.

I will bring the third part through the fire, and will *refine* them as silver is *refined*; Zech. xiii.

3. To purify, as manners, from what is gross, clownish, or vulgar; to polish; to make elegant. We expect to see *refined* manners in courts.—4. To purify, as language, by removing vulgar words and barbarisms.—5. To purify, as taste; to give a nice and delicate perception of beauty and propriety in literature and the arts.—6. To purify, as the mind or moral principles; to give or implant in the mind a nice perception of truth, justice, and propriety in commerce and social intercourse.

This nice perception of what is right constitutes rectitude of principle, or moral refinement of mind; and a correspondent practice of social duties constitutes rectitude of conduct or purity of morals. Hence, we speak of a *refined* mind, *refined* morals, *refined* principles.—To *refine the heart* or *soul*, to cleanse it from all carnal or evil affections and desires, and implant in it holy or heavenly affections.

REFINE, *v. i.* To improve in accuracy, delicacy, or in any thing that constitutes excellence.

Chaucer *refined* on Boccace and mended his stories. *Dryden.*

But let a lord once own the happy lines,  
How the wit brightens, how the sense *refines!*

*Pope.*

2. To become pure; to be cleared of feculent matter. So the pure limpid stream, when foul with stains,  
Works itself clear, and as it runs, *refines.*

*Addison.*

3. To affect nicety. Men sometimes *refine* in speculation beyond the limits of practical truth.

He makes another paragraph about our *refining* in controversy. *Atterbury.*

REFINED, *pp.* Purified; separated from extraneous matter; assayed, as metals; clarified, as liquors; polished; made elegant; separated from what is coarse, rude, or improper.

REFINED, *a.* Pure; elegantly nice; highly polished; as a *refined* taste, *refined* manners.

REFINEDLY, *adv.* With affected nicety or elegance.

REFINEDNESS, *n.* State of being refined; purity; refinement; also, affected purity.

REFINEMENT, *n.* The act of purifying by separating from a substance all extraneous matter; a clearing from dross, dregs, or recrement; as, the *refinement* of metals or liquors.—2. The state of being pure.

The more bodies are of a kin to spirit in subtlety and *refinement*, the more diffusive are they. *Norris.*

3. Polish of language; elegance; purity.

From the civil war to this time, I doubt whether the corruptions in our language have not equalled its *refinements*. *Swift.*

4. Polish of manners; elegance; nice observance of the civilities of social intercourse and of graceful decorum. *Refinement* of manners is often found

in persons of corrupt morals.—5. Purity of taste; nice perception of beauty and propriety in literature and the arts.—6. Purity of mind and morals; nice perception and observance of rectitude in moral principles and practice.—7. Purity of heart; the state of the heart purified from sensual and evil affections. This *refinement* is the effect of Christian principles.—8. Artificial practice; subtlety; as, the *refinements* of cunning.—9. Affectation of nicety, or of elegant improvement; as, the *refinements* of reasoning or philosophy.

**REFINER**, *n.* One that refines metals or other things.—2. An improver in purity and elegance; as, a *refiner* of language.—3. An inventor of superfluous subtleties; one who is over nice in discrimination, in argument, reasoning, philosophy, &c.

**REFINERY**, *n.* The place and apparatus for refining metals.

**REFINING**, *ppr.* Purifying; separating from alloy or any extraneous matter; polishing; improving in accuracy, delicacy, or purity.

**REFINING**, *n.* The use of too much refinement or subtlety; great nicety of speculation.

**REFINING**, *n.* In a general sense, the art of purifying any thing; but the term is commonly understood to apply to the purification of metals, particularly gold and silver, from the alloys with which they may be mixed. In *metallurgy*, the art of obtaining metals from their ores.

**REFIT**, *v. t.* [*re* and *fit*.] To fit or prepare again; to repair; to restore after damage or decay; as, to *refit* ships of war.

**REFITMENT**, *n.* A second fitting out.

**REFITTED**, *pp.* Prepared again; repaired.

**REFITTING**, *ppr.* Repairing after damage or decay; as a ship.

**REFLECT**, *v. t.* [*L. reflecto*; *re* and *flecto*, to bend; *Fr. réfléchir*.] To throw back; to return. In the rainbow, the rays of light are *reflected* as well as refracted.

Bodies close together *reflect* their own colour. *Dryden.*

**REFLECT**, *v. i.* To throw back light; to return rays or beams; as, a *reflecting* mirror or gem.—2. To bend back.—3. To throw or turn back the thoughts upon the past operations of the mind or upon past events. We *reflect* with pleasure on a generous or heroic action; we *reflect* with pain on our follies and vices; we *reflect* on our former thoughts, meditations, and opinions.—4. To consider attentively; to revolve in the mind; to contemplate; as, I will *reflect* on this subject.

And as I much *reflected*, much I mourn'd. *Prior.*

In every action, *reflect* upon the end. *Taylor.*

[To *reflect* on things *future*, is not strictly possible, yet the word is often used as synonymous with *meditate* and *contemplate*.]—5. To bring reproach.

Errors of wives *reflect* on husband still. *Dryden.*

To *reflect* on, to cast censure or reproach.

I do not *reflect* in the least on the memory of his late majesty. *Swift.*

[This verb may be followed by *on* or *upon*.]

**REFLECTED**, *pp.* Thrown back; returned; as, *reflected* light.—*Reflected*

*petal*, one that is curved backwards.—*Reflected stamen*, one that is bent out-



Reflected Petals (Tiger Lily).

wards.—In *her*, *reflected* or *reflexed* means curved or turned round; as the chain or line from the collar of a beast thrown over the back is termed *reflexed*. *Flected* and *reflected* are curvings contrarywise, bending first one way and then another.—*Reflected light*, in *painting*, the subdued light which falls on objects that are in shadow, and serves to make out their forms; it is reflected from some object on which the light falls directly, either seen in the picture or supposed to be acting on it, and is hence called *reflected light*. When there is either no object to reflect the light, or one that reflects feebly, the portions of the picture in shadow are obscure and indistinct; and when there is an object that reflects powerfully, such as a white wall, the shadows of the picture are clear and full of detail.

**REFLECTANT**, *a.* Bending or flying back; as, the ray descendant, and ray *reflectant*.

**REFLECTIBLE**, *a.* That may be reflected or thrown back.

**REFLECTING**, *ppr.* Throwing back.—2. Turning back, as thoughts upon themselves or upon past events.—3. *Reflecting on*, casting censure or reproach.—*Reflecting circle*, an astrono-

mic instrument for the measurement of angles by reflection; a sextant. The term is also applied to a surveying instrument, invented by Sir Howard Douglas, which combines the advantages of Hadley's quadrant and the protractor. The object of it is to contract or lay down on the plan the angles measured with the instrument from the instrument itself, without any intermediate step or even a register of their values.—*Reflecting telescope*,—see

TELESCOPE.

**REFLECT'ING**, *a.* Given to reflection or serious consideration; as, a *reflecting* mind.

**REFLECT'INGLY**, *adv.* With reflection; with censure.

**REFLECT'ION**, *n.* [from *reflect*.] The act of throwing back; as, the *reflection* of light or colours. In *mech.*, the

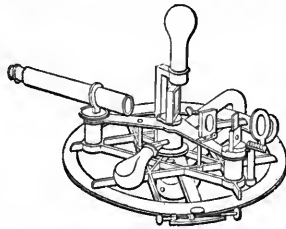

Troughton's Reflecting Circle.

rebound or regressive motion of a body from the surface of another body, against which it impinges. In *nat. phil.*, the term is applied to the analogous motions of light, heat, and sound, when turned from their course by an opposing surface. When a perfectly elastic body strikes a hard and fixed plane obliquely, it rebounds from it, making the angle of reflection equal to the angle of incidence [see *INCIDENCE*], and this law holds true with regard to light, heat, and sound. In the annexed figure, let A B represent a smooth

polished surface, or mirror, and suppose a ray of light proceeding in the direction L P to impinge on the surface at P, and to be reflected from it in the direction P R.

From P draw P Q perpendicular to A B, then the angle L P Q is called the *angle of incidence*, and Q P R the *angle of reflection*. Sometimes, however, the angle L P A is taken for the angle of incidence, and R P B for that of reflection. These two angles are in the same plane, and the angle of reflection is equal to the angle of incidence, and on the opposite side of the perpendicular. This law holds true whatever be the nature of the reflecting surface, or the origin of the light which falls upon it. All the phenomena of reflection from mirrors or polished surfaces, whether plane or having any regular curvature, are readily deduced from this law, as simple geometrical consequences.—2. The act of bending back.—3. That which is reflected.

As the sun in water we can bear; Yet not the sun, but his *reflection* there. *Dryden.*

4. The operation of the mind by which it turns its views back upon itself and its operations; the review or reconsideration of past thoughts, opinions, or decisions of the mind, or of past events.—5. Thought thrown back on itself, on the past, or on the absent; as, melancholy *reflections*; delightful *reflections*.

Job's *reflections* on his once flourishing estate, at the same time afflicted and encouraged him. *Atterbury.*

6. The expression of thought.—7. Attentive consideration; meditation; contemplation.

This delight grows and improves under thought and *reflection*. *South.*

8. Censure; reproach cast.

He died, and oh! may no *reflection* shed Its pois'nous venom on the royal dead. *Prior.*

**REFLECTIVE**, *a.* Throwing back images; as, a *reflective* mirror.

In the *reflective* stream the sighing bride Viewing her charms impair'd. *Prior.*

2. Considering the operations of the mind, or things past; as, *reflective* reason.

**REFLECT'IVELY**, *adv.* By reflection.

**REFLECT'OR**, *n.* One who reflects or considers.—2. That which reflects.—3. A polished surface of metal, or any other suitable material, applied for the purpose of transmitting rays of light, heat, or sound, in any required direction. Reflectors may be either plane or curvilinear; of the former the com-

mon mirror is a familiar example. Curvilinear reflectors admit of a great variety of forms, according to the purposes for which they are employed: they may be either convex or concave, spherical, elliptical, parabolic, or hyperbolic, &c. The parabolic form is, perhaps, the most generally serviceable, being that which is employed in light-houses, and for many other purposes of illumination, as well as for various highly important philosophical instruments. Its property is to transmit, in a parallel stream, and to a great distance, all rays diverging from the focus of the parabola, and conversely. The annexed cut is a section of a ship lantern, fitted with an argand lamp and parabolic reflector. *a a* is the reflector,

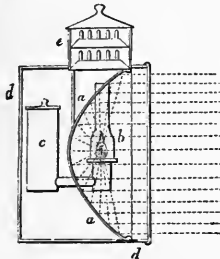

Parabolic Reflector.

tor, *b* the lamp, situated in the focus of the polished concave paraboloid, *c* the oil cistern, *d* the outer frame of the lantern, and *e* the chimney for the escape of the products of the combustion. The speculum of a reflecting telescope is an example of the converse application of the parabolic reflector, the parallel rays proceeding from a distant body being, in this case, concentrated into the focus of the reflector.

**REFLEX**, *a.* [L. *reflexus*.] 1. Directed back; as, a *reflex* act of the soul, the turning of the intellectual eye inward upon its own actions.—2. Designating the parts of a painting illuminated by light reflected from another part of the same picture.—3. In *bot.*, bent back; reflected.—*Reflex vision*, vision by means of reflected light, as from mirrors.

**REFLEX**, *n.* Reflection. †—2. In *painting*, the illumination of one body, or a part of it by light reflected from another body represented in the same piece. The foundation of the law of *reflexes* depends upon the fact that every body in light reflects that light to a certain degree. The stronger, therefore, the light on the body, the stronger will be the *reflex*, the distances being equal.

**REFLEX**, *v. t.* To reflect.—2. To bend back; to turn back. [*Little used.*]

**REFLEXED**, *pp.* Recurved; bent backwards.

**REFLEXIBILITY**, *n.* The quality of being reflexible or capable of being reflected; as, the *reflexibility* of the rays of light. [See **REFRANGIBILITY**.]

**REFLEXIBLE**, *a.* Capable of being reflected or thrown back.

The light of the sun consists of rays differently refrangible and *reflexible*. *Cheyne*.

**REFLEXION**. See **REFLECTION**.

**REFLEXITY**, *n.* Capacity of being reflected.

**REFLEXIVE**, *a.* Having respect to something past.

Assurance *reflexive* cannot be a divine faith. *Hammond*.

**REFLEXIVELY**, *adv.* In a direction backward.

**REFLOAT**, *n.* [*re* and *float*.] Reflux; ebb; a flowing back. [*Little used.*]

**REFLORES'ENCE**, *n.* [*re* and *florescence*.] A blossoming anew.

**REFLOURISH**, *v. i.* (*reflur*'ish.) [*re* and *flourish*.] To flourish anew.

**REFLOUR'ISHING**, *ppr.* Flourishing again.

**REFLOW**, *v. i.* [*re* and *flow*.] To flow back; to ebb.

**REFLOWING**, *ppr.* Flowing back; ebbing.

**REFLUCTUA'TION**, *n.* A flowing back.

**REFLUENCE**, } *n.* [from *refluent*.] A  
**REFLUENCY**, } flowing back.

**REFLUENT**, *a.* [L. *refluens*; *re* and *fluo*.] 1. Flowing back; ebbing; as, the *refluent* tide.—2. Flowing back; returning, as a fluid; as, *refluent* blood.

**REFLUX**, *n.* [Fr. from L. *refluxus*.] A flowing back; the returning of a fluid; as, the flux and *reflux* of the tides; the flux and *reflux* of the Euripus.

**REFOCILLATE**, *v. t.* [It. *refocillare*; L. *refocillo*; *re* and the root of *focus*.] To refresh; to revive; to give new vigour to. [*Little used.*]

**REFOCILLA'TION**, *n.* The act of refreshing or giving new vigour; restoration of strength by refreshment.

[*Little used.*]

**REFOMENT**, *v. t.* [*re* and *foment*.] To foment anew; to warm or cherish again.—2. To excite anew.

**REFOMENTED**, *pp.* Fomented or incited anew.

**REFOMENT'ING**, *ppr.* Fomenting anew; exciting again.

**REFORM**, *v. t.* [Fr. *reformer*; L. *reforma*; *re* and *formo*, to form.] 1. To change from worse to better; to amend; to correct; to restore to a former good state, or to bring from a bad to a good state; as, to *reform* a profligate man; to *reform* corrupt manners or morals.

The example alone of a vicious prince will corrupt an age, but that of a good one will not *reform* it. *Swift*.

2. To change from bad to good; to remove that which is bad or corrupt; as, to *reform* abuses; to *reform* the vices of the age.

**REFORM**, *v. i.* To abandon that which is evil or corrupt, and return to a good state; to be amended or corrected. A man of settled habits of vice will seldom *reform*.

**RE-FORM**, *v. t.* [*re* and *form*.] To form again; to create or shape anew; to mould or model anew; to reconstruct.

**REFORM**, *n.* Reformation; amendment of what is defective, vicious, corrupt, or depraved; as, the *reform* of parliamentary elections; *reform* of government.

**REFORM ACTS**, *n.* In *politics*, the well-known acts which passed the legislature in 1832, by which a considerable change was made in the representation of the people. The act for England received the royal assent June 7, 1832; that for Scotland on July 17; and that for Ireland on August 7 of the same year.

**REFORMA'DO**, *n.* [Sp.] A monk adhering to the reformation of his order; also an officer retained in his regiment when his company is disbanded.

**REFORMALIZE**, † *v. t.* To affect reformation.

**REFORMA'TION**, *n.* The act of reforming; correction or amendment of life, manners, or of any thing vicious or corrupt; as, the *reformation* of manners; *reformation* of the age; *reformation* of abuses.

Satire lashes vice into *reformation*.

*Dryden*.

2. *By way of eminence*, the change of religion from the corruptions of popery to its primitive purity, begun by Luther, A. D. 1517.

**REFORMA'TION**, *n.* The act of forming anew; a second forming in order; as, the *re-formation* of a column of troops into a hollow square.

**REFORMATIVE**, *a.* Forming again; having the quality of renewing form.

**REFORMATORY**, *a.* Tending to produce reformation.

**REFORMED**, *pp.* Corrected; amended; restored to a good state; as, a *reformed* profligate; the *reformed* church.—

*Reformed church* comprises, in a general sense, all those bodies of Christians that have separated from the church of Rome since the era of the Reformation; but it is applied in a restricted sense to those protestant churches which did not embrace the doctrines and discipline of Luther, and more particularly the Calvinistic churches on the Continent.

**RE-FORMED**, *pp.* Formed anew.

**REFORMER**, *n.* One who effects a reformation or amendment; as, a *reformer* of manners or of abuses.—

2. One of those who commenced the reformation of religion from popish corruption; as, Luther, Melancthon, Zuinglius, and Calvin.

**REFORM'ING**, *ppr.* Correcting what is wrong; amending; restoring to a good state.

**RE-FORM'ING**, *ppr.* Forming anew.

**REFORM'IST**, *n.* One who is of the reformed religion.—2. One who proposes or favours a political reform.

**REFORTIFICA'TION**, *n.* A fortifying a second time.

**REFORT'IFIED**, *pp.* Fortified anew.

**REFORT'TIFY**, *v. t.* [*re* and *fortify*.] To fortify anew.

**REFORT'TIFYING**, *ppr.* Fortifying again.

**REFOS'SION**, *n.* The act of digging up.

**REFOUND**, *v. t.* [*re* and *found*.] To found or cast anew.

**REFOUND'ED**, *pp.* Rebuilt or founded again.

**REFOUND'ER**, *n.* One who refounds.

**REFOUND'ING**, *ppr.* Rebuilding.

**REFRACT**, *v. t.* [L. *refractus*, *refringo*; *re* and *frango*, to break.] To break the natural course of the rays of light; to cause to deviate from a direct course. A dense medium *refracts* the rays of light, as they pass into it from a rare medium.

**REFRACTA'RIAS**, *n.* A mineral.

**REFRACT'ED**, *pp.* Turned from a direct course, as rays of light.—2. *In bot.*, bent back at an acute angle; as, a *refracted* corolla.

**REFRACT'ING**, *ppr.* Turning from a direct course.—2. *a.* That turns rays from a direct course; as, a *refracting* medium.—*Refracting telescope*. [See **TELESCOPE**.]

**REFRACT'ION**, *n.* The deviation of a moving body, chiefly rays of light, from a direct course. A ray of light, when it enters a medium of a different

density, deviates from its original path and is bent at the surface of the medium. This deviation or bending is called *refraction*, and is the ultimate fact from which many of the most interesting phenomena of light receive their explanation. Suppose a beam of light proceeding from a luminous point S to be admitted through a

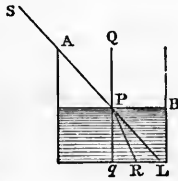

small hole A, in the side of a vessel AB; then, the vessel being empty, the light will fall on the bottom at a point L, in the same straight line with S and A. Now let water be poured into the vessel, and suppose the beam of light to fall on its surface at P; then it will be seen that the light no longer continues its course in the same straight line, but is bent or *refracted* at P, and proceeds through the water in a straight line P R more nearly perpendicular to the surface. A similar deviation takes place in all cases in which light passes from one transparent medium into another; but the magnitude of the angle R P L, or the amount of the refraction, varies according to the nature of the two media, and the degree of obliquity with which the incident ray falls on the surface of separation. If through P, Q P q be drawn perpendicular to the surface; then S P Q is the *angle of incidence*, and R P q the *angle of refraction*, and both these angles are in the same plane, and they are always on opposite sides of the perpendicular. The sine of the angle of incidence has to the sine of the angle of refraction a constant ratio, whatever be the inclination of the incident ray to the surface. When a ray of light passes from a rarer into a denser medium the refraction is towards the perpendicular, or the angle of refraction is less than the angle of incidence. On the contrary, when a ray of light passes from a denser into a rarer medium, the refraction is from the perpendicular, or the angle of refraction is greater than the angle of incidence.—*The index of refraction* of any transparent substance, is the ratio of the sine of incidence to the sine of refraction, when light passes from a vacuum into the substance.—*Astronomical refraction*, the apparent angular elevation of the heavenly bodies above their true places, caused by the refraction of the rays of light in their passage through the earth's atmosphere, so that in consequence of this refraction the heavenly bodies appear higher than they really are. It is greatest when the body is in the horizon, and diminishes all the way to the zenith, where it is nothing.—*Terrestrial refraction*, that refraction which makes terrestrial elevated objects appear to be raised higher than they are in reality. This arises from the air being denser near the surface of the earth than it is at higher elevations, its refractive power increasing as the density increases.—*Double refraction*, the separation of a ray of light into two separate parts, by passing through certain transparent mediums, as the Iceland crystal. All crystals, except those whose primitive form is either a cube

or a regular octahedron, exhibit double refraction.

**REFRACTIVE**, *a.* That refracts or has power to refract or turn from a direct course; as, *refractive densities*.—*Refractive power*, in *optics*, the degree of influence which a transparent body exercises on the light which passes through it.—*Absolute refractive power*, or *absolute refraction*, the ratio of the refractive power of a substance to its density.

**REFRACTOR**, *n.* A refracting telescope.

**REFRACTORINESS**, *n.* [from *refractory*.] Perverse or sullen obstinacy in opposition or disobedience.

I never allowed any man's *refractoriness* against the privileges and orders of the house. *K. Charles.*

**REFRACTORY**, *a.* [Fr. *refractaire*; L. *refractorius*, from *refragor*, to resist; *re* and *frago*, from *frango*.] 1. Sullen or perverse in opposition or disobedience; obstinate in non-compliance; as, a *refractory child*; a *refractory servant*.

Raging appetites that are Most disobedient and *refractory*. *Shak.*  
2. Unmanageable; obstinately unyielding; as, a *refractory beast*.—3. *Applied to metals*, difficult of fusion; not easily yielding to the force of heat.

**REFRACTORY**, *n.* A person obstinate in opposition or disobedience.—2. † Obstinate position.

**REFRAGABLE**, *a.* [L. *refragor*; *re* and *frango*.] That may be refuted, that is, broken.

**REFRAIN**, *v. t.* [Fr. *refréner*; L. *refreno*; *re* and *frano*, to curb; *frœnum*, a rein. See *REIN*.] To hold back; to restrain; to keep from action.

My son...*refrain* thy foot from their path; Prov. i.

Then Joseph could not *refrain* himself before all them that stood by; Gen. xlv.

**REFRAIN**, *v. i.* To forbear; to abstain; to keep one's self from action or interference.

*Refrain* from these men and let them alone; Acts v.

**REFRAIN**, *n.* [Fr. *refrain*.] The burden of a song; a kind of musical repetition.

**REFRAINED**, *pp.* Held back; restrained.

**REFRAINING**, *ppr.* Holding back; forbearing.

**REFRAME**, *v. t.* [*re* and *frame*.] To frame again.

**REFRAMED**, *pp.* Framed anew.

**REFRAMING**, *ppr.* Framing again.

**REFRANGIBILITY**, *n.* [from *refrangible*.] The disposition of rays of light to be refracted or turned out of a direct course, in passing out of one transparent body or medium into another. The term, however, is more usually employed to denote the degree of that disposition possessed by the differently coloured rays. Newton showed that the sun's light consists of rays which differ in refrangibility, as well as in colour, and on this he founded his whole theory of colours.

**REFRANGIBLE**, *a.* [L. *re* and *frango*, to break.] Capable of being refracted or turned out of a direct course in passing from one medium to another; as rays of light.

**REFRACTION**, † *n.* [See *REFRAIN*.] The act of restraining.

**REFRESH**, *v. t.* [Fr. *rafraichir*; *re* 565

and *fraichir*, from *fratche*, fresh. See *FRESH*.] 1. To cool; to allay heat. A dew coming after a heat *refresheth*.

*Erclus.*  
2. To give new strength to; to invigorate; to relieve; to recreate or revive after fatigue, want, or pain; to take refreshment; as, to *refresh* the body. A man or a beast is *refreshed* by food and rest; Exod. xxiii.—3. To revive; to reanimate after depression; to cheer; to enliven.

For they have *refreshed* my spirit and yours; 1 Cor. xvi.

4. To improve by new touches any thing improved.

The rest *refresh* the scaly snakes. *Dryden*

5. To revive what is drooping; as, rain *refreshes* the plants.

**REFRESH**, † *n.* Act of refreshing.

**REFRESHED**, *pp.* Cooled; invigorated; revived; cheered.

**REFRESHER**, *n.* He or that which refreshes, revives, or invigorates.—

2. An extra fee paid to a counsel in advance.

**REFRESHING**, *ppr.* or *a.* Cooling; invigorating; reviving; reanimating.

**REFRESHING**, *n.* Refreshment; relief after fatigue or suffering.

**REFRESHINGLY**, *adv.* So as to refresh, or give new life.

**REFRESHINGNESS**, *n.* The quality of refreshing.

**REFRESHMENT**, *n.* Act of refreshing; or new strength or vigour received after fatigue; relief after suffering; *applied to the body*.—2. New life or animation after depression; *applied to the mind or spirits*.—3. That which gives fresh strength or vigour, as food or rest.—*To take refreshment*, to take relief after fatigue or suffering; to take food.

**REFRET**, *n.* The burden of a song.

**REFRIGERANT**, *a.* [Fr. See *REFRIGERATE*.] Cooling; allaying heat.

**REFRIGERANT**, *n.* Among *physicians*, a medicine which abates heat or cools, or which directly diminishes the force of the circulation, and reduces the heat of the body or a portion of it, without occasioning any diminution of the ordinary sensibility or nervous energy. The agents usually regarded as refrigerants are weak vegetable acids, or very greatly diluted mineral acids; some saline, neutral, or super salts; and cool air, ice-cold water, and externally evaporating lotions.

**REFRIGERATE**, *v. t.* [L. *refrigero*; *re* and *frigus*, cold.] To cool; to allay the heat of; to refresh.

**REFRIGERATED**, *pp.* Cooled.

**REFRIGERATING**, *ppr.* Allaying heat; cooling.

**REFRIGERATION**, *n.* The act of cooling; the abatement of heat; state of being cooled.—2. The operation of cooling worts and other hot fluids without exposing them to evaporation.

This is effected by means of utensils, generally called refrigerators, and so constructed that a quantity of cold water shall be brought in contact with the vessel which contains the heated fluid.—*Refrigeration of the globe*. According to some geologists, the whole of this globe was once in an incandescent state: they believe that the process of gradual *refrigeration* has been constantly going on, and that the centre of the earth is still a molten mass.

**REFRIGERATIVE**, *a.* Cooling.

**REFRIGERATIVE**, *n.* A remedy that allays heat.

**REFRIGERATOR,** } In *chem.* and  
**REFRIG'ERATORY,** } *distillation*, a  
 vessel for cooling liquids, or condensing  
 hot vapour into liquids, by the applica-  
 tion of cold water. The common worm-  
 tube is a specimen, but refrigerators  
 are of numerous other forms, and must  
 of course be varied to suit the peculiar  
 objects for which they are designed.—  
 2. Any thing internally cooling, as a  
 drink or medicine.

**REFRIG'ERATORY, a.** Cooling; miti-  
 gating heat.

**REFRIG'ERIUM,** † *n.* [L.] Cooling  
 refreshment; refrigeration.

**REFT,** † *pp.* of *Reave*. Deprived; be-  
 reft.—2. † *pret.* of *Reave*. Took away.

**REFT,** † *n.* A chink. [See *RIFT*.]

**REF'UGE,** † *n.* [Fr. from *L. refugium*,  
*refugio*; *re* and *fugio*, to flee.] 1. Shel-  
 ter or protection from danger or dis-  
 tress.

...Rocks, dens, and caves, but I in none of  
 these  
 Find place or refuge. *Milton*.

We have made lies our refuge; Is.  
 xviii.

... We might have strong consolation, who  
 have fled for refuge to lay hold on the hope  
 set before us; Heb. vi.

2. That which shelters or protects  
 from danger, distress, or calamity; a  
 stronghold, which protects by its  
 strength, or a sanctuary which secures  
 safety by its sacredness; any place  
 inaccessible to an enemy.

The high hills are a refuge for the wild  
 goats; Ps. civ.

The Lord also will be a refuge for the  
 oppressed; Ps. ix.

3. An expedient to secure protection  
 or defence.

Their latest refuge was to send to him.  
*Shak.*

4. Expedient, in general.

Light must be supplied, among graceful  
*refuges*, by terracing any story in danger  
 of darkness. *Wotton*.

*Cities of refuge*, among the *Israelites*,  
 certain cities appointed to secure the  
 safety of such persons as might com-  
 mit homicide without design. Of these  
 there were three on each side of *Jor-  
 dan*; Josh. xx.

**REF'UGE, v. t.** To shelter; to protect.

**REF'UGE, † v. i.** To take shelter.

**REFUG'EE, n.** [Fr. *réfugié*.] 1. One  
 who flees to a shelter or place of safety.  
 —2. One who, in times of persecution  
 or political commotion, flees to a foreign  
 country for safety; as, the French *refu-  
 gees*, who left France after the revoca-  
 tion of the edict of Nantes, and settled  
 in Flanders, Britain, &c.; the *refugees*  
 from Hispaniola, in 1792.

**REFUL'GENCE,** } *n.* [L. *refulgens*, *re-  
 fulgeo*; *fulgeo*, to shine.] A flood of light; splen-  
 dour.

**REFUL'GENT, a.** Casting a bright  
 light; shining; splendid; as, *refulgent*  
 beams; *refulgent* light; *refulgent* arms.

A conspicuous and *refulgent* truth.

**REFUL'GENTLY, adv.** With a flood  
 of light; with great brightness.

**REFUND,** † *v. t.* [L. *refundō*; *re* and  
*fundo*, to pour.] 1. To pour back.

Were the humours of the eye tingured  
 with any colour, they would refund that  
 colour upon the object. [Unusual or obso-  
 lete.] *Ray*.

2. To return; to return in payment or  
 compensation for what has been taken;

to restore; as, to refund money taken  
 wrongfully; to refund money advanced,  
 with interest; to refund the amount  
 advanced.

**REFUND'ED, pp.** Poured back; repaid.

**REFUND'ER, n.** One who refunds.

**REFUND'ING, ppr.** Pouring back;  
 returning by payment or compensation.

**REFUR'BISH, v. t.** To furnish a second  
 time.

**REFUR'BISHED, pp.** Furbished again.

**REFUR'BISHING, ppr.** Furbishing  
 again.

**REFU'SABLE, a.** (s as z.) [from *refuse*.]  
 That may be refused.

**REFU'SAL, n.** (s as z.) The act of  
 refusing; denial of any thing demanded,  
 solicited, or offered for acceptance.

The first refusal is not always proof  
 that the request will not be ultimately  
 granted.—2. The right of taking in  
 preference to others; the choice of  
 taking or refusing; option; pre-emp-  
 tion. We say, a man has the *refusal*  
 of a farm or a horse, or the *refusal* of  
 an employment.

**REFUSE, v. t.** (s as z.) [Fr. *refuser*; *L.*  
*recuso*; *re* and the root of *causor*, to  
 accuse; *causa*, cause. The primary  
 sense of *causor* is to drive, to throw,  
 or thrust at, and *recuso* is to drive  
 back, to repel, or repulse: the sense of  
*refuse*.] 1. To deny a request, demand,  
 invitation, or command; to decline to  
 do or grant what is solicited, claimed,  
 or commanded.

Thus Edom refused to give Israel passage  
 through his border; Num. xx.

2. To decline to accept what is offered;  
 as, to refuse an office; to refuse an  
 offer.

If they refuse to take the cup at thy  
 hand; Jer. xxv.

3. To reject; as, to refuse instruction  
 or reproof; Prov. x.

The stone which the builders refused is  
 become the head of the corner; Ps. cxviii.

*Note.*—*Refuse* expresses rejection more  
 strongly than *decline*.

**REFU'SE, v. i.** (s as z.) To decline to  
 accept; not to comply.

Too proud to ask, too humble to refuse.  
*Garth*.

**REFUSE, a.** [Fr. *refus*, refusal, denial,  
 and that which is denied.] Literally,  
 refused; rejected; hence, worthless;  
 of no value; left as unworthy of recep-  
 tion; as, the *refuse* parts of stone or  
 timber.

Please to bestow on him the *refuse*  
 letters. *Spectator*.

**REFUSE, n.** That which is refused or  
 rejected as useless; waste matter.

**REFU'SE, † n.** Refusal.

**REFUSED, pp.** Denied; rejected; not  
 accepted.

**REFU'SER, n.** One that refuses or re-  
 jects.

**REFU'SING, ppr.** Denying; declining  
 to accept; rejecting.

**REFU'TABLE, † a.** [from *refute*.] That  
 may be refuted or disproved; that may  
 be proved false or erroneous.

**REFU'TAL, † n.** Refutation.

**REFU'TATION, n.** [L. *refutatio*. See  
*REFUTE*.] The act or process of re-  
 futing or disproving; the act of prov-  
 ing to be false or erroneous; the over-  
 throwing of an argument, opinion,  
 testimony, doctrine, or theory, by argu-  
 ment or countervailing proof.

**REFUTE, v. t.** [Fr. *refuter*; *L.* *refuto*;  
*re* and *futo*.] The primary sense  
 of *futo* is, to drive or thrust, to beat  
 back.] To disprove and overthrow by  
 argument, evidence, or countervailing

proof; to prove to be false or errone-  
 ous; to confute. We say, to *refute*  
 arguments, to *refute* testimony, to *re-  
 fute* opinions or theories, to *refute* a  
 disputant.

There were so many witnesses to these  
 two miracles, that it is impossible to *re-  
 fute* such multitudes. *Addison*.

**REFUTED, pp.** Disproved; proved to  
 be false or erroneous.

**REFUTER, n.** One that refutes.

**REFUTING, ppr.** Proving to be false  
 or erroneous; confuting.

**REGAIN, v. t.** [*re* and *gain*; Fr. *re-  
 gagner*.] To gain anew; to recover  
 what has escaped or been lost.

**REGAINED, pp.** Recovered; gained  
 anew.

**REGAINING, ppr.** Gaining anew; re-  
 covering.

**REG'AL, a.** [Fr. from *L. regalis*, from  
*rex*, Sans. *raja*, connected with *rego*, to  
 govern; Sax. *reacan* or *reccan*, to say,  
 to *rech*, to *reckon*, to rule, to *direct*;  
 the root of *right*, *L. rectus*, Sax. *reht*.  
 See *RECK* and *RECKON*.] Pertaining  
 to a king; kingly; royal; as, a *regal*  
 title; *regal* authority; *regal* state, pomp,  
 or splendour; *regal* power or sway.

But we say, a *royal* or *kingly* govern-  
 ment, not a *regal* one. We never say,  
 a *regal* territory, *regal* dominions, *regal*  
 army, or *regal* navy. *Regal* expresses  
 what is more personal.

**REG'AL, n.** [Fr. *régale*.] A musical  
 instrument; a small portable finger  
 organ.

**REG'ALE, n. plur. regalia,**—which see  
 [Fr. *régale*.] The prerogative of mo-  
 narchy; that which pertains to a king.

**REGALE, n.** [See the verb, below.]  
 A magnificent entertainment or treat  
 given to ambassadors and other persons  
 of distinction.

**REGALE, v. t.** [Fr. *regaler*; Sp. *regalar*,  
 to regale, to refresh, entertain, caress,  
 cajole, delight, cherish; *regalarse*, to  
 entertain one's self, to take pleasure,  
 also to melt, to be dissolved; Port.  
*regalar*, to regale, to treat daintily, to  
 delight; It. *regalare*, to present with  
 gifts, to regale, to season. This word  
 is probably a compound of *re* and the  
 root It. *galloria*, a transport of joy,  
*gallare*, to exult, *gala*, ornament, Port.  
*galhofa*, mirth, good cheer, Sp. *gallardo*,  
 gay, Fr. *gaillard*, &c. In Russ. *jaluju*  
 signifies to regale, to gratify with pre-  
 sents, to visit, &c. The primary sense  
 is to excite, to rouse and be brisk, or  
 to shoot, leap, dart, or rush. We prob-  
 ably see the same root in the Eng.  
*gale*, *gallant*, Gr. *γαλλία*, Fr. *joli*,  
 Eng. *jolly*, and in many other words.]  
 To refresh; to entertain with some-  
 thing that delights; to gratify, as the  
 senses; as, to *regale* the taste, the eye,  
 or the ear. The birds of the forest  
*regale* us with their songs.

**REGALE, v. i.** To feast; to fare sumptu-  
 ously.

**REGALED, pp.** Refreshed; entertained;  
 gratified.

**REGALEMENT, n.** Refreshment; en-  
 tertainment; gratification.

**REGA'LIA, n.** [L. *regalis*, from *rex*.] 1.  
 Ensigns of royalty; the apparatus of a  
 coronation; as the crown, sceptre, &c.  
 The *regalia* of England consist of the  
 crown, sceptre, with the cross, the  
 verge or rod, with the dove, the staff of  
 Edward the Confessor, four several  
 swords, the globe, the orb with the  
 cross, and several other articles. These  
 are preserved in the Jewel-office in the  
 Tower of London. The *regalia* of



Scotland consists of the crown, the sceptre, the sword of state, and a mace. They are deposited within the Crown-Room in the castle of Edinburgh. *Regalia* of the church, in England, the privileges which have been conceded to the church by kings; sometimes, the patrimony of the church.—2. The privileges, prerogative, and right of property, belonging, in virtue of office, to the sovereign of a state. These are reckoned by civilians to be six; viz., the power of judicature; of life and death; of war and peace; of masterless goods; as waifs, estrays, &c.; of assessments; and minting of money.

**REGALING**, *ppr.* Refreshing; entertaining; gratifying.

**REGALITY**, *n.* [from *L. regalis*; *Fr. royauté.*] Royalty; sovereignty; kingship.

He came partly in by the sword and had high courage in all points of *regality*.

*Bacon.*

In *Scotland*, a *regality* was originally a territorial jurisdiction conferred by the king. The lands were said to be given in *liberam regalitatem*, and the persons receiving the right were termed *lords of regality*.

**REGALLY**, *adv.* In a royal manner.  
**REGALS**, *n. plur.* Ensigns of royalty. [See *REGALIA*.]—2. In the *sing.*, a small portable finger-organ, well known during the 16th and 17th centuries.

**REGARD**, *v. t.* [*Fr. regarder*; *It. riguardare*; from *Fr. garder*, to guard, keep, defend; *It. guardare*, to guard, to look, view, behold, to beware, to take heed, to discern. The primary sense of *guard* is to drive off or repel, and thus to protect, or to hold, keep, retain; probably the former. To *regard* is to extend or direct the eye to an object, or to hold it in view. We observe a somewhat similar process of deriving the sense of *looking*, in the *It. scorto*, seen, perceived, prudent, guided, convoyed, wary, crafty, discerning, and as a noun, an abridgement; *scorta*, a guide, an *escort*, a guard.] 1. To look toward; to point or be directed.

It is a peninsula which *regardeth* the main land. *Sandys.*

2. To observe; to notice with some particularity.

If much you note him,  
You offend him; feed, and regard him not. *Shak.*

3. To attend to with respect and estimation; to value.

This aspect of mine,

The best *regarded* virgins of your clime  
Have loved. *Shak.*

4. To attend to as a thing that affects our interest or happiness; to fix the mind on as a matter of importance. He does not *regard* the pain he feels. He does not *regard* the loss he has suffered. He *regards* only the interest of the community.—5. To esteem; to hold in respect and affection. The people *regard* their pastor, and treat him with great kindness; 2 Kings iii.—6. To keep; to observe with religious or solemn attention.

He that *regardeth* the day, *regardeth* it to the Lord; Rom. xiv.

7. To attend to as something to influence our conduct.

He that *regardeth* the clouds shall not reap; Eccles. xi.

8. To consider seriously; to lay to heart.

They *regard* not the work of the Lord; Isa. v.

9. To notice with pity or concern; Deut. xxviii.—10. To notice favourably or with acceptance; to hear and answer.

He will *regard* the prayer of the destitute; Ps. cii.

11. To love and esteem; to practise; as, to *regard* iniquity in the heart; Ps. lxxvi.—12. To respect; to have relation to. The argument does not *regard* the question.—To *regard* the person, to value for outward honour, wealth, or power; Matt. xxii.

**REGARD**, *n.* [*Fr. regard*; *It. riguardo.*] 1. Look; aspect directed to another.

But her with stern *regard* he thus repell'd.  
[*Nearly or quite obsolete.*] *Milton.*

2. Attention of the mind; respect in relation to something. He has no *regard* to the interest of society; his motives are wholly selfish.—3. Respect; esteem; reverence; that view of the mind which springs from value, estimable qualities, or any thing that excites admiration.

With some *regard* to what is just and right  
They'll lead their lives. *Milton.*

To him they had *regard*, because of long time he had bewitched them with sorceries; Acts viii.

4. Respect; account.

Change was thought necessary, in *regard* of the injury the church received by a number of things then in use. *Hooker.*

5. Relation; reference.

To persuade them to pursue and persevere in virtue, in *regard* to themselves; in justice and goodness, in *regard* to their neighbours; and piety toward God. *Watts.*

6. Note; eminence; account.

Mac Ferlagh was a man of meanest *regard* among them. *Spenser.*

7. Matter demanding notice.—8. Prospect; object of sight. [*Not proper in use.*]—9. In the *forest laws*, view; inspection.—*Court of regard*, or *survey of dogs*, a forest court in England, held every third year for the lawing or expeditation of mastiffs, that is, for cutting off the claws and ball of the fore feet, to prevent them from running after deer.

**REGARDABLE**, *a.* Observable; worthy of notice.

**REGARDANT**, *a.* Looking to; looking behind or backward;

watching. In *law*, a villain regardant was one annexed to the land or manor, and had charge to do all base services within the same.—2. In *her.*, looking behind; applied to any animal whose face is turned towards the tail in an attitude of vigilance.

**REGARDED**, *pp.* Noticed; observed; esteemed; respected.

**REGARDER**, *n.* One that regards.—2. In *law*, the regarder of the forest is an officer whose business is to view the forest, inspect the officers, and inquire of all offences and defaults.

**REGARDFUL**, *a.* Taking notice; heedful; observing with care; attentive.

Let a man be very tender and *regardful* of every pious motion made by the Spirit of God on his heart. *South.*

**REGARDFULLY**, *adv.* Attentively; heedfully.—2. Respectfully.

**REGARDING**, *ppr.* Noticing; considering with care; attending to; observing; esteeming; caring for.—2. Respecting; concerning; relating to.

**REGARDLESS**, *a.* Not looking or

attending to; heedless; negligent; careless; as, *regardless* of life or of health; *regardless* of danger; *regardless* of consequences.

*Regardless* of the bliss wherein he sat.

*Milton.*

2. Not regarded; slighted.

**REGARDLESSLY**, *adv.* Heedlessly; carelessly; negligently.

**REGARDLESSNESS**, *n.* Heedlessness; inattention; negligence.

**REGATA**, *n.* [*It. regatta.*] In *REGATTA*, } Venice, a grand rowing match in which many boats are rowed for a prize. This term has been adopted into all the languages of modern Europe, in which it signifies a showy species of boat race.

**REGATHER**, *v. t.* To gather or collect a second time.

**REGATHERED**, *pp.* Collected again.  
**REGATHERING**, *ppr.* Gathered a second time.

**REG'EL**, *n.* A fixed star of the first **REG'IL**, } magnitude in Orion's left foot.

**REG'ENCY**, *n.* [*L. regens*, from *rego*, to govern.] 1. Rule; authority; government.—2. Vicarious government.—

3. The district under the jurisdiction of a vicergerent; as, the *regencies* of Tunis, Egypt, &c., under the real or nominal supremacy of the Ottoman Porte.—4. The body of men intrusted with vicarious government; as, a *regency* constituted during a king's minority, insanity, or absence from the kingdom.

**REGENERACY**, *n.* [See *REGENERATE*.] The state of being regenerated.

**REGENERATE**, *v. t.* [*L. regenero*; *re* and *genero*. See *GENERATE*.] 1. To generate or produce anew; to reproduce.

Through all the soil a genial ferment spreads,

*Regenerates* the plants and new adorns the meads. *Blackmore.*

2. In *theol.*, to renew the heart by a change of affections; to change the heart and affections from natural enmity to the love of God; to implant holy affections in the heart.

**REGENERATE**, *a.* [*L. regeneratus*.] 1. Reproduced.—2. Born anew; renovated in heart; changed from a natural to a spiritual state.

**REGENERATED**, *pp.* Reproduced.—2. Renewed; born again.

**REGENERATENESS**, *n.* The state of being regenerated.

**REGENERATING**, *ppr.* Reproducing.—2. Renovating the nature by the implantation of holy affections in the heart.

**REGENERATION**, *n.* Reproduction; the act of producing anew.—2. In *theol.*, new birth by the grace of God; that change by which the will and natural enmity of man to God and his law are subdued, and a principle of supreme love to God and his law, or holy affections, are implanted in the heart.

He saved us by the washing of *regeneration* and renewing of the Holy Spirit; Tit. iii.

2. In *nat. hist.*, reproduction; the property which some animals possess of reproducing parts which have been destroyed.

**REGENERATORY**, *a.* Renewing; having the power to renew; tending to reproduce or renovate.

**REGENT**, *a.* [*L. regens*, from *rego*, to rule.] 1. Ruling; governing; as, a *regent* principle.—2. Exercising vicarious authority.—*Queen regent*, a queen who governs; as distinguished from a *queen consort*.



Regardant Passant.

REG'ENT, *n.* A governor; a ruler; in a general sense; as Uriel, *regent* of the sun.—2. One invested with vicarious authority; one who governs a kingdom in the minority, absence, or disability of the king. In most hereditary governments the maxim is, that this office belongs to the nearest relative of the sovereign capable of undertaking it; but this rule is subject to many limitations.—3. One of a certain standing who taught in our universities; the word formerly in use for a *professor*.—4. In *English universities*, a master of arts under five years' standing, and a doctor under two. The *regents* form the governing body of the universities, in the convocation and congregation at Oxford, and in the academical senate at Cambridge.—5. In the state of *New York*, the member of a corporate body which is invested with the superintendence of all the colleges, academies, and schools in the state.

REG'ENTESS, *n.* A protectress of a kingdom.

REG'ENTSHIP, *n.* The power of governing, or the office of a regent.—2. Deputed authority.

REGERM'INATE, *v. i.* [*re* and *germinate*.] To germinate again.

Perennial plants *regerminate* several years successively. *Lee.*

REGERM'INATING, *ppr.* Germinating anew.

REGERMINA'TION, *n.* A sprouting or germination anew.

REG'EST, † *n.* A register.

REG'IAM MAJESTA'TEM. The title given to a collection of ancient laws, bearing to have been compiled by the order of David I. king of Scotland. [*See Scott's Border Antiquities.*]

REG'IBLE, † *a.* Governable.

REG'ICIDE, *n.* [*It.* and *Sp.* *regicida*; *Fr.* *régicide*; *L.* *rex*, king, and *cædo*, to slay.] 1. A king-killer; one who murders a king.—2. The killing or murder of a king.

REG'IMEN, *n.* [*L.* from *rego*, to govern.]

1. In *med.*, the regulation of diet with a view to the preservation or restoration of health; or in a more general sense, the regulation of all the "non-naturals" for the same purposes.—2. Any regulation or remedy which is intended to produce beneficial effects by gradual operation.—3. In *gram.*, government; that part of syntax or construction which regulates the dependence of words, and the alterations which one occasions or requires in another in connection with it; the words governed.—4. Orderly government; system of order.

REG'IMENT, *n.* [*L.* *regimen*.] 1. In *milit. affairs*, a body of men, commanded by a colonel, of varying number, but usually about 1000 strong. If infantry, the regiment consists of several *companies*; if cavalry, of several *squadrons*.—2. † Government; mode of ruling; rule; authority; as used by Hooker, Hale, John Knox, and others.

REG'IMENT, *v. t.* To form into a regiment or into regiments with proper officers. [*A military use of the word.*]

REGIMENT'AL, *a.* Belonging to a regiment; as, *regimental officers*; *regimental clothing*.

REGIMENT'ALS, *n. plur.* The uniform worn by the troops of a regiment.

REGION, *n.* (*re*'jun.) [*Fr.* and *Sp.* *región*; *It.* *regione*; *L.* *regio*; *Ir.* *críoch*, with a prefix; from the root of *reach*, *reck*, *L.* *rego*.] 1. A tract of land or

space of indefinite extent, usually a tract of considerable extent; as, the equatorial *regions*; the temperate *regions*; the polar *regions*, &c. It is sometimes nearly synonymous with *country*; as, all the *region* of Argob; *Deut.* iii.

He had dominion over all the *region* on this side the river; 1 Kings iv. So we speak of the airy *region*, the ethereal *regions*, the upper *regions*, the lower *regions*.—2. The inhabitants of a region or district of country; *Matt.* iii.—3. A part of the body; as, the *region* of the heart or liver.—4. Place; rank.

He is of too high a *region*. [*Unusual.*] *Shak.*

REG'ISTER, *n.* [*Fr.* *registre*; *Low L.* *registrum*, from *regero*, to set down in writing; *re* and *gero*, to carry. But Spelman considers the word as formed of *re* and *Norm.* *gister* or *giser*, to lay, and equivalent to *repository*.]

1. A written account or entry of acts, judgments, or proceedings, for preserving and conveying to future times an exact knowledge of transactions. The word appropriately denotes an official account of the proceedings of a public body, a prince, a legislature, a court, an incorporated company and the like, and in this use it is synonymous with *record*. But in a lax sense, it signifies any account entered on paper to preserve the remembrance of what is done. In England there are no general registers of deeds, conveyances, wills, &c.; but in Scotland these are general and are called *records*. [*See RECORD.*]

—2. The book in which a register or record is kept, as a parish *register*; also, a list, as the *register* of seamen.—

3. [*Low L.* *registrarius*.] The officer or person whose business is to write or enter in a book accounts of transactions, particularly of the acts and proceedings of courts or other public bodies; as, the *register* of the high court of delegates; *register* of the arches court of Canterbury; *register* of the court of admiralty; *register* of the prerogative court; *register* of the garter, &c. [*See REGISTRAR.*]

—4. In *chem.* and the *arts*, something that regulates or adjusts; as, an aperture with a lid, stopper, or sliding plate, in a furnace, stove, &c. for regulating the admission of air and the heat of the fire. Grates for fire-places, having an apparatus of this kind, are termed *register* grates.—

5. The inner part of the mould in which types are cast.—

6. In *printing*, the correspondence of columns on the opposite sides of the sheet. *To make register*, to make the pages and lines fall exactly upon each other. *Register-sheet*, a sheet for trying whether the impression of the sides and heads of all the pages agree; which, when done, *register* is said to be made, or it is said to be in *good register*.—

7. A sliding piece of wood, used as a stop in an organ.—

8. In *music*, a term applied to the compass or graduated notes of a voice.—

*Lord register* or *lord clerk register*, a Scottish officer of state who has the custody of the archives; hence, also termed *custos rotulorum*.—

*Parish register*, a book in which are recorded the baptisms of children and the marriages and burials of the parish.—

*Register ship*, a ship which once obtained permission, by treaty, to trade to the Spanish West Indies, and whose capacity, per registry, was attested before sailing.

REG'ISTER, *v. t.* To record; to write

in a book for preserving an exact account of facts and proceedings. The Greeks and Romans *registered* the names of all children born.—2. To enrol; to enter in a list.

REG'ISTER ACTS, or REG'ISTRY ACTS. That body of enactments dictated by the navy policy of Great Britain, as to the registering of all ships which are to have the privileges of British vessels. The requisites of a legal register are various, consisting, generally speaking, of proofs of the build and ownership of the vessel; of a survey of the ship by the officers or the customs, of the registry certificate and bond for the faithful keeping thereof. All merchant and trading vessels are registered under the provisions of the 3 and 4 Will. 4., which commenced on the 1st September, 1833, and consolidated and amended a previous act; viz. the 6 Geo. 4, c. 110.

REG'ISTERED, *pp.* Recorded in a book or register; enrolled.

REG'ISTERING, *ppr.* Recording; enrolling.

REG'ISTERSHIP, *n.* The office of a register or registrar.

REG'ISTER THERMOMETER, *n.* A thermometer which registers or records its own indications in the absence of the observer. Numerous contrivances have been devised for this purpose, but the one most generally used is the *day and night thermometer* of Dr. Rutherford. It consists of two thermometers, the one a mercurial, and the other a spirit thermometer, attached horizontally to the same frame, and each provided with its own scale. The mercurial thermometer contains, as an index, a bit of steel wire which is pushed before the mercury, and is left where the mercury begins to recede, marking how high the temperature had been. The spirit thermometer contains an index of glass half an inch long, with a small knob at each end. This lies in the spirit, which freely passes it when the thermometer rises, but when the spirit recedes the cohesive attraction between the spirit and the glass overcomes the friction arising from the weight of the index, so that it is carried back with the spirit towards the bulb. As there is no force to move it in the opposite direction, it remains at the point nearest the bulb to which it has been brought, and thus indicates the lowest temperature which has occurred during the interval between the observations.

REG'ISTRAR, } *n.* An officer in the  
REG'ISTRARY, } English universi-  
ties, who has the keeping of all the public records. [*Registry* is less used.] Officers in the courts of chancery who enter all decrees and orders made by the chancellor, vice chancellors, and master of the rolls, are called *registrars* or *registers*. Similar officers are appointed in other courts of equity. The same name is also given to the officers appointed to carry into effect the statutes 6 and 7 Will. 4, c. 85, 86, being the "act for marriages in England," and the "act for registering births, deaths, and marriages in England." They consist of the registrar-general, the superintendent registrar, and the registrar and his deputy.

REGISTRA'TION, *n.* The act of inserting in a register; as, the *registration* of deeds; the *registration* of births, deaths, and marriages.—*Registration*

of voters, the enrolment of the names of those persons who are entitled to vote in the election of members of parliament. Without such registration no one is entitled to vote.

**REGISTRY**, *n.* The act of recording or writing in a register; as, the *registry* of wills, of ships, &c.—2. The place where a register is kept.—3. A series of facts recorded.

**REGIUM DONUM**. [*L. royal grant.*]

An annual grant of public money in aid of the income from other sources of the Presbyterian clergy in Ireland.

**REGIUS**, *a.* [*L.*] Royal; appointed by the king.

**REGIUS PROFESSORS**. The name given to those professors in the English universities whose chairs were founded by Henry VIII. In the Scotch universities, the same name is given to those professors whose professorships were founded by the crown.

**REGIUS MORBUS**, *n.* [*L. the king's evil.*] 1. Among *classical Latin authors*, the jaundice.—2. Among the *writers of the middle ages*, scrofula.

**REGLEMENT**, *n.* [*Fr.*] Regulation.

**REGLET**, *n.* [*Fr. from règle, rule, L. regula, rego.*] A kind of printers' furniture, of equal thickness throughout its whole length, used for adjusting pages in their proper place in the chase, and for filling up blanks in posting bills, &c. It is of graduated thickness, and was originally made of wood, but now generally of type metal.—2. In *arch.*, a small moulding, rectangular in its section, a fillet or listel. [*See REGULA.*]

**REGLET-PLANE**, *n.* A plane used in making printers' galleys.

**REGNANCY**, *n.* Reign; predominance.

**REGNANT**, *a.* [*Fr. from regner, L. regno, to reign.*] 1. Reigning; exercising regal authority, by hereditary right, and not as *regent*, but as *queen regnant*.—2. Ruling; predominant; prevalent; having the chief power; as, *vices regnant*. We now say, *reigning vices*.

**REGORGE**, *v. t.* [*Fr. regorger; re and gorge.*] 1. To vomit up; to eject from the stomach; to throw back or out again.—2. To swallow again.—3. To swallow eagerly.

**REGORGED**, *pp.* Ejected again from the stomach or a deep place.

**REGRADE**, *v. i.* [*L. regredior; re and gradior, to go.*] To retire; to go back.

**REGRAFT**, *v. t.* [*re and graft.*] To graft again.

**REGRAFTED**, *pp.* Grafted again.

**REGRAFTING**, *ppr.* Grafting anew.

**REGRANT**, *v. t.* [*re and grant.*] To grant back.

**REGRANT, n.** The act of granting back to a former proprietor.

**REGRANTED**, *pp.* Granted back.

**REGRANTING**, *ppr.* Granting back.

**REGRATE**, *v. t.* [*Fr. regratter, to scratch again, to new-vamp, to regrate, or drive a huckster's trade; re and grater, to grate, to scratch, to rake.*]

1. To offend; to shock. [*Little used.*]

2. To buy provisions and sell them again in the same market or fair, or in any other fair or market within four miles; a practice which by raising the price was formerly a public offence, and punishable. The old statutes providing certain penalties for such acts were all repealed by 12 Geo. 3. c. 7. *Regrating* differs from *engrossing* and *monopolizing*, which signify the buying the whole of certain articles, or large quantities, and from *forestalling*, which

signifies the purchase of provisions on the way, before they reach the market.

**REGRATER, or REGRATOR, n.** One who buys provisions and sells them in the same market or fair.

**REGRATING, ppr.** Purchasing provisions and selling them in the same market.—2. In *masonry*, taking off the outer surface of an old hewn stone in order to whiten and make it look fresh again.

**REGRATING, n.** The act of purchasing provisions and selling them again in the same market.

**REGREET, v. t.** [*re and greet.*] To greet again; to re-salute.

**REGREET, n.** A return or exchange of salutation.

**REGREETED, pp.** Greeted again or in return.

**REGREETING, ppr.** Greeting again; re-saluting.

**REGRESS, n.** [*Fr. regrès; L. regressus, regredior.*] 1. Passage back; return; as, *ingress and regress*.—2. The power of returning or passing back.—3. In *Scots law*, re-entry. Under the *feudal law*, letters of *regress* were granted by the superior of a wadset, under which he became bound to re-admit the wadsetter, at any time when he should demand an entry to the wadset.

**REGRESS, v. i.** To go back; to return to a former place or state.

**REGRESSION, n.** The act of passing back or returning.—*Regression of the moon's nodes, in astron.*, the motion of the line of intersection of the orbit of the moon with the ecliptic, which is retrograde, or contrary to the order of the signs. The whole revolution is accomplished in about 18½ years.

**REGRESSIVE, a.** Passing back; returning.

**REGRESSIVELY, adv.** In a backward way or manner; by return.

**REGRET, n.** [*Fr. regret; either from the root of grate, or more directly from the root of Sp. and Port. gritar, Goth. grietan, W. grydiaw, to scream or cry out, to utter a rough sound; in some dialects to weep or lament. But grate and Sp. gritar are probably of the same family.*] 1. Grief; sorrow; pain of mind. We feel *regret* at the loss of friends, *regret* for our own misfortunes, or for the misfortunes of others.

Never any prince expressed a more lively *regret* for the loss of a servant. *Clarendon.*

Her piety itself would blame,  
If her *regrets* should waken thine. *Prior.*

2. Pain of conscience; remorse; as, a passionate *regret* at sin.—3. Dislike; aversion. [*Not proper nor in use.*]

**REGRETT, v. t.** [*Fr. regretter.*] 1. To grieve at; to lament; to be sorry for; to repent.

Calmly he look'd on either life, and here  
Saw nothing to *regret*, or there to fear. *Pope.*

2. To be uneasy at. [*Not proper nor in use.*]

**REGRETFUL, a.** Full of regret.

**REGRETFULLY, adv.** With regret.

**REGRETTED, pp.** Lamented.

**REGRETTING, ppr.** Lamenting; grieving at; repenting.

**REGUERDON, n.** [*n. (regerd'on.) [re and Fr. guerdon, a reward. See REWARD.]* A reward; a recompense.

**REGUERDON, v. t.** [*n. (regerd'on.)*] To reward.

**REGULA, n.** [*L. a rule.*] In *archæology*, the book of rules or orders of a monastery.—2. In *arch.*, a fillet or listel, by some restricted to the band or fillet

below the tænia in the Doric architecture; a reglet.

**REGULAR, a.** [*Sp. id.; Fr. régulier; L. regularis, from regula, a rule, from rego, to rule.*] 1. Conformed to a rule; agreeable to an established rule, law, or principle, to a prescribed mode or to established customary forms; as, a *regular* epic poem; a *regular* verse in poetry; a *regular* piece of music; *regular* practice of law or medicine; a *regular* plan; a *regular* building.—2. Governed by rule or rules; steady or uniform in a course or practice; as, *regular* in diet; *regular* in attending on divine worship.—3. In *geom.*, a *regular figure* is one whose sides and angles are equal, as a square, a cube, an equilateral triangle, an equilateral pentagon, hexagon, &c. Regular figures of more than four sides are usually called *regular polygons*. Circles can be described within and about all regular figures, and the area of any one may be found by multiplying half its perimeter by the perpendicular let fall from the centre of the inscribed or circumscribed circle upon one of the sides.—*Regular bodies*, those which have all their sides, angles, and faces similar and equal. Of these there are only five: the tetrahedron, hexaedron, octahedron, dodecahedron, icosahedron. They are also termed *Platonic bodies*. [*See PLATONIC.*]

4. Instituted or initiated according to established forms or discipline; as, a *regular* physician.—5. Methodical; orderly; as, a *regular* kind of sensuality or indulgence.—6. Periodical; as, the *regular* return of the night or regular trade wind or monsoon.—7. Pursued with uniformity or steadiness; as, a *regular* trade.—8. Belonging to a monastic order; as, *regular* clergy, in distinction from the *secular* clergy.—9. In *bot.*, applied to parts of plants when regular in their figure and size, and the proportion of their parts; as, a *regular* calyx or corolla.—*Regular troops*, troops of a permanent army; opposed to *militia*.

—*Regular diseases, in pathol.*, a term applied to those diseases which observe their usual course, in opposition to such as are *irregular*, in which the course of symptoms deviate from what is usual; as, *regular* gout; *regular* small-pox, &c.—*Regular drama*, a dramatic piece written according to established rules, and played at the regular theatres; also, the branch of literature, of which such pieces form the groundwork.—*Regular architecture*, that which has its parts symmetrical, or disposed in counterparts.—*Regular curves*, the perimeters of conic sections which are always curved after the same geometrical manner.—*Regular attack*, an attack in a siege which is made in form, and by a regular approach.

**REGULAR, n.** In a *monastery*, one who has taken the vows, and who is bound to follow the rules of the order.—2. A soldier belonging to a permanent army.

**REGULARITY, n.** Agreeableness to a rule or to established order; as, the *regularity* of legal proceedings.—2. Method; certain order. *Regularity* is the life of business.—3. Conformity to certain principles; as, the *regularity* of a figure.—4. Steadiness or uniformity in a course; as, the *regularity* of the motion of a heavenly body. There is no *regularity* in the vicissitudes of the weather.

**REG'ULARLY**, *adv.* In a manner accordant to a rule or established mode; as, a physician or lawyer *regularly* admitted to practice; a verse *regularly* formed.—2. In uniform order; at certain intervals or periods; as, day and night *regularly* returning.—3. Methodically; in due order; as, affairs *regularly* performed.

**REG'ULATE**, *v. t.* To adjust by rule, method, or established mode; as, to *regulate* weights and measures; to *regulate* the assize of bread; to *regulate* our moral conduct by the laws of God and of society; to *regulate* our manners by the customary forms.—2. To put in good order; as, to *regulate* the disordered state of a nation or its finances.—3. To subject to rules or restrictions; as, to *regulate* trade; to *regulate* diet.

**REG'ULATED**, *pp.* Adjusted by rule, method, or forms; put in good order; subjected to rules or restrictions.

**REG'ULATING**, *ppr.* Adjusting by rule, method, or forms; reducing to order; subjecting to rules or restrictions.

**REGULA'TION**, *n.* The art of regulating or reducing to order.—2. A rule or order prescribed by a superior for the management of some business, or for the government of a company or society.—*Regulation roll*, in *Scots law*, one of the rolls of court, called before the lord ordinary for the week in the court of session, in which are enrolled all causes wherein no appearance has been made for the defender.

**REG'ULATIVE**, *a.* Regulating; tending to regulate.

**REG'ULATOR**, *n.* One who regulates.—2. In *mech.*, a general name for any contrivance of which the object is to produce uniformity of motion. The regulators most commonly applied to machines are the *fly-wheel* and the *governor*. The *regulator* of a watch is the spiral spring attached to the balance; and in a clock it is the pendulum.

**REG'ULATOR VALVE**. In *mech.*, the name applied to the mechanism by which the driver of a locomotive engine is enabled to control its motions by admitting a greater or less supply of steam from the boiler to the cylinders.

**REG'ULINE**, *a.* [See **REGULUS**.] Pertaining to regulus or pure metal.

Bodies which we can reduce to the metallic or *reguline* state. *Lavoisier*.

**REG'ULIZE**, *v. t.* To reduce to regulus or pure metal; to separate pure metal from extraneous matter.

**REG'ULIZED**, *pp.* Reduced to pure metal.

**REG'ULIZING**, *ppr.* Separating pure metal from extraneous matter.

**REG'ULUS**, *n.* [L. a petty king; Fr. *regule*.] For the plural, some authors write *reguli*, and others *regulus*.] The name by which the old chemists designated several of the brittle or inferior metals, when freed from impurities by fusion and obtained in their metallic state. Thus, they spoke of the *regulus* of antimony, of arsenic, of bismuth, &c. This term was introduced by the alchemists, who, expecting always to find gold in the metal collected at the bottom of their crucibles after fusion, called this metal thus collected *regulus* [from L. *rex*, a king], as containing gold, the king of metals. This word is still used in commerce, as applied to antimony; as, *star regulus*, *pearl regulus*, both of antimony.—2. A fixed star of the first magnitude in the constellation Leo, sometimes called *Cor Leonis*, or

the Lion's Heart.—3. In *ornithology*, the name of several birds of the genus *Motacilla*.

**REGUR'GATE**, *v. t.* [Fr. *regorger*; L. *re* and *gurges*.] To throw or pour back, as from a deep or hollow place; to pour or throw back in great quantity.

**REGUR'GATE**, *v. i.* To be thrown or poured back.

**REGUR'GATED**, *pp.* Thrown or poured back.

**REGUR'GATING**, *ppr.* Throwing or pouring back.

**REGURITA'TION**, *n.* The act of pouring back.—2. The act of swallowing again; re-absorption.

**REHABIL'ITATE**, *v. t.* [Fr. *rehabilitier*; *re* and *habilitier*.] To restore to a former capacity; to reinstate; to qualify again; to restore, as a delinquent to a former right, rank, or privilege lost or forfeited; a term of the *civil and canon law*.

**REHABILITATED**, *pp.* Restored to a former rank, right, privilege, or capacity; reinstated.

**REHABILITATING**, *ppr.* Restoring to a former right, rank, privilege, or capacity; reinstating.

**REHABILITA'TION**, *n.* The act of reinstating in a former rank or capacity; restoration to former rights.

**REHEAR**, *v. t. pret.* and *pp. reheard*. [re and hear.] To hear again; to try a second time; as, to *rehear* a cause in a law-court.

**REHEARD**, *pp.* (reherd'.) Heard again.

**REHEARING**, *ppr.* Hearing a second time.

**REHEARING**, *n.* A second hearing.—2. In *law*, a second hearing or trial.

**REHEARSAL**, *n.* (rehers'al.) [from *rehearse*.] 1. Recital; repetition of the words of another or of a written work; as, the *rehearsal* of the Lord's Prayer.—2. Narration; a telling or recounting, as of particulars in detail; as, the *rehearsal* of a soldier's adventures.—3. The recital of a piece before the public exhibition of it; as, the *rehearsal* of a comedy.

**REHEARSE**, *v. t.* (rehers'.) To recite; to repeat the words of a passage or composition; to repeat the words of another.

When the words were heard which David spoke, they *rehearsed* them before Saul; 1 Sam. xvii.

2. To narrate or recount events or transactions.

There shall they *rehearse* the righteous acts of the Lord; Judg. v.; Acts xi.

3. To recite or repeat in private for experiment and improvement, before a public representation; as, to *rehearse* a tragedy.

**REHEARSED**, *pp.* (rehers'ed.) Recited; repeated; as words; narrated.

**REHEARSER**, *n.* (rehers'er.) One who recites or narrates.

**REHEARSING**, *ppr.* (rehers'ing.) Reciting; repeating words; recounting; telling; narrating.

**REIF**, *n.* [Anglo-Sax. *reaf*.] Robbery; rapine; spoil; plunder. [Scotch.] In *Scots law*, one of the four pleas of the crown. These are murder, reif, or robbery, rape, and wilful fire-raising.

**REIGLE**, *n.* [Fr. *règle*, rule.] A hollow cut or channel for guiding any thing; as, the *reigle* of a side post for a flood gate.

**REIGN**, *v. i.* (rane.) [L. *regno*, a derivative of *rego*, *regnum*; Fr. *regner*.] 1. To possess or exercise sovereign power or authority; to rule; to exercise government, as a king or emperor;

or to hold the supreme power. George the Third *reigned* over Great Britain more than fifty years.

Behold, a king shall *reign* in righteousness; Is. xxxiii.

2. To be predominant; to prevail.

Pestilent diseases which commonly *reign* in summer or autumn. *Bacon*.

3. To rule; to have superior or uncontroled dominion; Rom. vi.

**REIGN**, *n.* (rane.) [Fr. *règne*; L. *regnum*.] 1. Royal authority; supreme power; sovereignty.

He who like a father held his *reign*. *Pope*.

2. The time during which a king, queen, or emperor possesses the supreme authority. The Spanish armada was equipped to invade England in the *reign* of Queen Elizabeth. Magna Charta was obtained in the *reign* of King John.—3. Kingdom; dominion.

Saturn's sons received the threefold *reign* Of heav'n, of ocean, and deep hell beneath. *Prior*.

4. Power; influence.—5. Prevalence.

**REIGNING**, *ppr.* (ra'ning.) Holding or exercising supreme power; ruling; governing as king, queen, or emperor.

—2. A. Predominating; prevailing; as, a *reigning* vice or disease.—*Reigning winds*, winds that usually prevail in any particular region, or on any particular coast.

**RE-ILLU'MINE**, } *v. t.* To enlighten

**RE-ILLU'MINATE**, } again.

**RE-ILLUMINA'TION**, *n.* Act of enlightening again.

**RE-IMBARK**. See **RE-EMBARK**.

**RE-IMBOD'Y**, *v. i.* [See **EMBODY**.] To imbody again; to be formed into a body anew.

**REIMBURS'ABLE**, *a.* That may be repaid.

**REIMBURSE**, *v. t.* (reimburs'.) [Fr. *rembourser*; *re* and *embourser*; *en*, in and *course*, a purse.] To refund; to replace in a treasury or in a private coffer, an equivalent to the sum taken from it, lost, or expended; as, to *reimburse* the expenses of a war or a canal. The word is used before the person expending, or the treasury from which the advances are made, or before the expenses. We say, to *reimburse* the individual, to *reimburse* the treasury, or to *reimburse* the expenses. To *reimburse* the person, is to repay to him his losses, expenses, or advances; to *reimburse* the treasury, is to refund to it the sum drawn from it; to *reimburse* losses or expenses, is to repay them or make them good.

**RE-IMBURSED**, *pp.* Repaid; refunded; made good, as loss or expense.

**RE-IMBURSEMENT**, *n.* (reimburs'ment.) The act of repaying or refunding; repayment; as, the *reimbursement* of principal and interest.

**RE-IMBURSER**, *n.* One who repays or refunds what has been lost or expended.

**RE-IMBURS'ING**, *ppr.* Repaying; refunding; making good, as loss or expense.

**RE-IMPLANT'**, *v. t.* [re and *implant*.] To implant again.

**RE-IMPLANTED**, *pp.* Implanted anew.

**RE-IMPLANT'ING**, *ppr.* Implanting again.

**RE-IMPORTUNE**, *v. t.* [re and *importune*.] To importune again.

**RE-IMPORTUNED**, *pp.* Importuned again.

**RE-IMPORTUNING**, *ppr.* Importuning again.

RE-IMPREG'NATE, *v. t.* [*re* and *impregnate.*] To impregnate again.

RE-IMPREG'NATED, *pp.* Impregnated again.

RE-IMPREG'NATING, *ppr.* Impregnating again.

RE-IMPRESS', *v. t.* [*re* and *impress.*] To impress anew.

RE-IMPRESSED, *pp.* Impressed again.

RE-IMPRESS'ING, *ppr.* Impressing again.

RE-IMPRES'SION, *n.* A second or repeated impression; reprint of a work.

RE-IMPRINT', *v. t.* [*re* and *imprint.*] To imprint again.

RE-IMPRINT'ED, *pp.* Imprinted again.

RE-IMPRINT'ING, *ppr.* Imprinting anew.

RE-IMPRIS'ON, *v. t.* [*See PRISON.*] To imprison a second time, or for the same cause, or after release from imprisonment.

RE-IMPRIS'ONED, *pp.* Imprisoned a second time for the same cause.

RE-IMPRIS'ONING, *ppr.* Imprisoning again for the same cause.

RE-IMPRIS'ONMENT, *n.* The act of confining in prison a second time for the same cause, after a release from prison.

REIN, *n.* [*Fr. rêne, from resne.* The *It. redine* is evidently from the *L. retina, retinaculum, Sp. rienda.* If contracted from the Latin, it is from *retineo*, otherwise from the root of *arrest.*] 1. The strap of a bridle, fastened to the curb or snaffle on each side, by which the rider of a horse restrains and governs him.—2. The instrument of curbing, restraining, or governing; government.—*To give the reins*, to give license; to leave without restraint.—*To take the reins*, to take the guidance or government.

REIN, *v. t.* To govern by a bridle.—2. To restrain; to control.

RE-INCUR', *v. t.* To incur a second time.

REINDEER, *n.* [*Sax. hrana; Fr. renne; D. rendeir; G. renthier; Basque, orena or orina; so named probably from running.*] A species of deer found in the northern parts of Europe and Asia, the *Cervus tarandus*, Linn.

It has branched, recurved, round antlers, the summits of which are pal-  
mated. These antlers, which are annually shed and renewed by both sexes, are remarkable for the size of the branch which comes off near the

base, called the brow antler. The length of a full-grown male is about nine feet, that of the head is fifteen inches. The reindeer is swift of foot, sharp-sighted, has an acute smell and hearing. He can swim well, and often crosses lakes and rivers. Among the Laplanders, he is a substitute for the horse, the cow, the goat, and the sheep,

as he furnishes food, clothing, and the means of conveyance. This animal will draw a sledge on the snow more than a hundred miles in a day.

REINED, *pp.* Governed by a bridle; controlled.

RE-INFECT', *v. t.* [*re* and *infect.*] To infect again.

RE-INFECTA, [*L.*] The thing not done or accomplished.

RE-INFECT'ED, *pp.* Infected again.

RE-INFECT'ING, *ppr.* Infecting again.

RE-INFEC'TIOUS, *a.* Capable of infecting again.

RE-INFORCE, *v. t.* [*re* and *inforce.*] To strengthen with new force, assistance, or support, as to *reinforce* an argument; but particularly, to strengthen an army or a fort with additional troops, or a navy with additional ships.

RE-INFORCE, *n.* In *artillery*, that part of a gun nearest to the breech, which is made stronger to resist the explosive force of the powder.—*Reinforce rings*, flat hoop-like mouldings on the reinforcements on the side nearest to the breech.

RE-INFORCED, *pp.* Strengthened by additional force, troops, or ships.

RE-INFORCEMENT, *n.* The act of reinforcing.—2. Additional force; fresh assistance; particularly, additional troops or force to augment the strength of an army or of ships.—3. Any augmentation of strength or force by something added.

RE-INFORCING, *ppr.* Strengthening by additional force.

RE-INFUSE, *v. t.* To infuse again.

RE-INGRA'TIATE, *v. t.* [*re* and *ingrati-ate.*] To ingratiate again; to recommend again to favour.

RE-INGRA'TIATED, *pp.* Reinstated in favour.

RE-INGRA'TIATING, *ppr.* Ingratiating again.

RE-INHAB'IT, *v. t.* [*re* and *inhabit.*] To inhabit again.

RE-INHAB'ITED, *pp.* Inhabited again.

RE-INHAB'ITING, *ppr.* Inhabiting a second time.

REINING, *ppr.* Governing by a bridle; controlling.

REINLESS, *a.* Without rein; without restraint; unchecked.

RE-INQUIRE, *v. t.* To inquire a second time.

REINS, *n. plur.* [*Fr. rein, rognon; L. ren, renes.*] 1. The kidneys; the lower part of the back.—2. In *scripture*, the inward parts; the heart, or seat of the affections and passions; Ps. lxxiii.—*Reins of a vault, in arch.*, the sides or walls that sustain the arch.

RE-INSERT', *v. t.* [*re* and *insert.*] To insert a second time.

RE-INSERT'ED, *pp.* Inserted again.

RE-INSERT'ING, *ppr.* Inserting again.

RE-INSERT'ION, *n.* A second insertion.

RE-INSPECT', *v. t.* [*re* and *inspect.*] To inspect again, as provisions.

RE-INSPECT'ED, *pp.* Inspected again.

RE-INSPEC'TION, *n.* The act of inspecting a second time.

RE-INSPIRE, *v. t.* [*re* and *inspire.*] To inspire anew.

RE-INSPIRED, *pp.* Inspired again.

RE-INSPIRING, *ppr.* Inspiring again.

RE-INSPIR'IT, *v. t.* To inspirit anew.

RE-INSTAL', *v. t.* [*re* and *instal.*] To instal again; to seat anew.

RE-INSTAL'ED, *pp.* Installed anew.

RE-INSTAL'ING, *ppr.* Installing again.

RE-INSTAL'MENT, *n.* A second instalment.

RE-INSTATE, *v. t.* [*re* and *instate.*] To place again in possession or in a former state; to restore to a state from which one had been removed; as, to *reinstale* a king in the possession of the kingdom; to *reinstale* one in the affections of his family.

RE-INSTATED, *pp.* Replaced in possession or in a former state.

RE-INSTATEMENT, *n.* The act of putting in a former state; re-establishment.

RE-INSTATING, *ppr.* Replacing in a former state; putting again in possession.

RE-INSURANCE, *n.* [*re* and *insurance.* *See SURE.*] In *com.*, a contract by which the first insurer relieves himself from the risks he had undertaken, and devolves them upon other underwriters, called *reinsurers*. A party may reinsure his policy by expressing it to be a reinsurance, provided the former insurers are insolvent or dead, but otherwise such reinsurance is prohibited by statute.

RE-INSURE, *v. t.* [*re* and *insure.*] To insure the same property a second time by other underwriters.

The insurer may cause the property insured to be *reinsured* by other persons.

*Walsh. French Com. Code.*

RE-INSURED, *pp.* Insured a second time by other persons.

RE-INSURING, *ppr.* Insuring a second time by other persons.

RE-INTEGRATE, *v. t.* [*Fr. réintégrer; L. redintegrare; red, re, and integro, from integer.*] To renew with regard to any state or quality; to restore. [*Little used.*]

RE-INTEGRATION, *n.* A renewing or making whole again

RE-INTERROGATE, *v. t.* [*re* and *interrogate.*] To interrogate again; to question repeatedly.

RE-INTHRONE, *v. t.* [*re* and *inthrone.* *See ENTHRONE.*] To replace on the throne.

RE-INTHRONED, *pp.* Placed again on the throne.

RE-INTHRONING, *ppr.* Replacing on the throne.

RE-INTHRONIZE, *vt. t.* To reinthrone.

RE-INTRODUCE, *v. t.* To introduce again.

RE-INTRODUCTION, *n.* A second introduction.

RE-INUN'DATE, *v. t.* To inundate again.

RE-INVEST', *v. t.* [*re* and *invest.*] To invest anew.

RE-INVEST'ED, *pp.* Invested again.

RE-INVEST'IGATE, *v. t.* To investigate again.

RE-INVESTIGATION, *n.* A second investigation.

RE-INVEST'ING, *ppr.* Investing anew.

RE-INVEST'MENT, *n.* The act of investing anew; a second or repeated investment.

RE-INVIGORATE, *v. t.* To revive vigour in; to reanimate.

REIS EFFEN'DI, *n.* The name given to one of the chief Turkish officers of state. He is chancellor of the empire, and minister of foreign affairs.

RE-IS'SUE, *v. t.* To issue a second time.

RE-IS'SUED, *pp.* Issued again.

REIST, *v. t.* To arrest. [*Scotch.*]

REIST, *v. t.* [*Dan. rister, to broil or toast.*] To dry by the heat of the sun or by smoke, as fish. [*Scotch.*]

REIST, *v. i.* To become restive; as a horse. [*Scotch.*]

REIT, *n.* Sedge; sea weed.

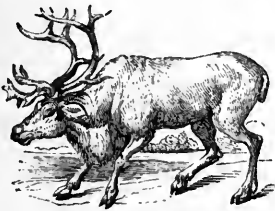

Reindeer (*Cervus tarandus*).

base, called the brow antler. The length of a full-grown male is about nine feet, that of the head is fifteen inches. The reindeer is swift of foot, sharp-sighted, has an acute smell and hearing. He can swim well, and often crosses lakes and rivers. Among the Laplanders, he is a substitute for the horse, the cow, the goat, and the sheep,

REITER, *n.* [Ger.] A rider, a trooper. The German cavalry of the 14th and 15th centuries were called *reiters*, especially in France during the religious wars.

RE-ITERATE, *v. t.* [Fr. *réitérer*; *L. re* and *itero*.] To repeat; to repeat again and again; as, *reiterated* crimes; to *reiterate* requests.

RE-ITERATED, *pp.* Repeated again and again.

RE-ITERATING, *ppr.* Repeating again and again.

RE-ITERATION, *n.* Repetition.

RE-ITEREDLY, *adv.* Repeatedly.

REJECT, *v. t.* [*L. rejicio, rejectus*; and *jacio*, to throw.] 1. To throw away, as any thing useless or vile.—2. To cast off.

Have I *rejected* those that me adored?  
*Brown.*

3. To cast off; to forsake; Jer. vii.—4. To refuse to receive; to slight; to despise.

Because thou hast *rejected* knowledge, I will *reject* thee; Hos. iv.; 1 Sam. xv.

5. To refuse to grant; as, to *reject* a prayer or request.—6. To refuse to accept; as, to *reject* an offer.

REJECTABLE, *a.* That may be rejected.

REJECTAMENTA, *n.* [from *L. rejecto*.] Things thrown out or away. [*Ill formed*.]

REJECTANEOUS, *† a.* [from the *L.*] Not chosen or received; rejected.

REJECTED, *pp.* Thrown away; cast off; refused; slighted.

REJECTER, *n.* One that rejects or refuses.

REJECTING, *ppr.* Throwing away; casting off; refusing to grant or accept; slighting.

REJECTION, *n.* [*L. rejectio*.] The act of throwing away; the act of casting off or forsaking; refusal to accept or grant.

REJECTITIOUS, *a.* That may be rejected.

REJECTIVE, *a.* That rejects, or tends to cast off.

REJECTMENT, *n.* Matter thrown away.

REJOICE, *v. i.* (rejois') [Fr. *réjoir, réjouissant; re* and *joir*, to enjoy; Sp. and Port. *gozar*, to enjoy; *gozo*, joy. In most of the dialects, the last radical of *joy* is lost; but the Spanish and Portuguese retain it in *z*, which is a palatal letter. Hence this word seems to be the D. *juichen*, to rejoice, to shout; G. *jauchzen*. Qu. the Dan. *lujer*, to rejoice; *huj*, a shout, joy, rejoicing, which is the English *hue*, in *hue and cry*; Fr. *huer* and *hucher*. Amidst such changes of letters, it is not easy to ascertain the primary elements. But it is easy to see that the primary sense is to *shout*, or to be animated or excited.] To experience joy and gladness in a high degree; to be exhilarated with lively and pleasurable sensations; to exult.

When the righteous are in authority, the people *rejoice*; but when the wicked beareth rule, the people mourn; Prov. xxix.

I will *rejoice* in thy salvation; Ps. ix.

REJOICE, *v. t.* (rejois') To make joyful; to gladden; to animate with lively pleasurable sensations; to exhilarate.

Whoso loveth wisdom *rejoiceth* his father; Prov. xxix.

While she, great saint, *rejoices* heaven.  
*Prior.*

REJOIC'ED, *pp.* Made glad; exhilarated.

REJOIC'ER, *n.* One that rejoices.

REJOIC'ING, *ppr.* Animating with gladness; exhilarating; feeling joy.

REJOIC'ING, *n.* The act of expressing joy and gladness.

The voice of *rejoicing* and salvation is in the tabernacles of the righteous; Ps. cxviii.

2. The subject of joy.

Thy testimonies have I taken as a heritage forever, for they are the *rejoicing* of my heart; Ps. cxix.

3. The experience of joy; Gal. vi.

REJOIC'INGLY, *adv.* With joy or exultation.

REJOIN, *v. t.* [*re* and *join*; Fr. *rejoindre*.] 1. To join again; to unite after separation.—2. To meet one again.

REJOIN, *v. i.* To answer to a reply.—2. In *law pleadings*, to answer, as the defendant to the plaintiff's replication.

REJOIN'ER, *n.* An answer to a reply; or in general, an answer.—2. In *law pleadings*, the fourth stage in the pleadings in an action, being the defendant's answer to the plaintiff's replication. The next allegation of the plaintiff is called *surrejoinder*.

REJOIN'ED, *pp.* Joined again; reunited.

REJOINING, *ppr.* Joining again; answering a plaintiff's replication.

REJOINT, *v. t.* [*re* and *joint*.] To reunite joints.

REJOINT'ED, *pp.* Reunited in the joints.

REJOINT'ING, *ppr.* Reuniting the joints.

REJOINTING, *n.* In *arch.*, the filling up of the joints of the stones in old buildings, when the mortar has been dislodged by time and the action of the weather.

REJOLT, *† n.* [*re* and *jolt*.] A reacting jolt or shock.

REJOURN, *† v. t.* (rejern') [Fr. *réjournier*. See ADJOURN.] To adjourn to another hearing or inquiry.

REJUDGE, *v. t.* (rejuj') [*re* and *judge*.] To judge again; to re-examine; to review; to call to a new trial and decision.

*Rejudge* his acts, and dignity disgrace.  
*Pope.*

REJUDG'ED, *pp.* Reviewed; judged again.

REJUDG'ING, *ppr.* Judging again.

REJUVENES' CENCE, } *n.* [*L. re* and  
REJUVENES' CENCY, } *juvenescens*;  
                                  } *juvenis*, a youth.] A renewing of youth; the state of being young again.

REJUVENIZE, *v. t.* To render young again.

REJUVENIZED, *pp.* Rendered young again.

REJUVENIZING, *ppr.* Renewing youth.

REKIN'DLE, *v. t.* [*re* and *kindle*.] To kindle again; to set on fire anew.—2. To inflame again; to rouse anew.

REKIN'DLED, *pp.* Kindled again; inflamed anew.

REKIN'DLING, *ppr.* Kindling again; inflaming anew.

RELÄID, *pp.* Laid a second time.

RELAI'S, *n.* [Fr.] In *fort.*, a narrow walk of four or five feet wide, left without the rampart, to receive the earth which may be washed down, and prevent its falling into the ditch.

RELAND, *v. t.* [*re* and *land*.] To land again; to put on land what had been shipped or embarked.

RELAND', *v. i.* To go on shore after having embarked.

RELAND'ED, *pp.* Put on shore again.

RELAND'ING, *ppr.* Landing again.

RELAPSE, *v. i.* (relaps') [*L. relapsus, relabor*, to slide back; *re* and *labor*, to slide.] 1. To slip or slide back; to return.—2. To fall back; to return to a former state or practice; as, to *relapse* into vice or error after amendment.

In *eccles. law*, a heretic is said to *relapse* when he falls back into an error which he had abjured.—3. To fall back or return from recovery or a convalescent state; as, to *relapse* into a fever.

RELAPSE, *n.* (relaps') A sliding or falling back, particularly into a former bad state, either of body or morals; as, a *relapse* into a disease from a convalescent state; a *relapse* into a vicious course of life. [In the sense of a person relapsing, not used.]

RELAPSES' ER, *n.* One that relapses into vice or error.

RELAPS'ING, *ppr.* Sliding or falling back, as into disease or vice.

RELATE, *v. t.* [*L. relatus, refero; re* and *fero*, to produce.] 1. To tell; to recite; to narrate the particulars of an event; as, to *relate* the story of Priam; to *relate* the adventures of Don Quixote.—2. † To bring back; to restore.—3. To ally by connection or kindred.—To *relate one's self*, to vent thoughts in words. [*Ill*.]

RELÄTE, *v. i.* To have reference or respect; to regard; to have some understood position when considered in connection with something else.

All negative words *relate* to positive ideas. *Locke.*

RELÄTED, *pp.* Recited; narrated.—2. *a.* Allied by kindred; connected by blood or alliance, particularly by consanguinity; as, a person *related* in the first or second degree.

RELÄTER, *n.* One who tells, recites, or narrates, an historian.

RELÄTING, *ppr.* Telling; reciting; narrating.—2. *a.* Having relation or reference; concerning.

RELÄTION, *n.* [Fr. from *L. relatio, refero*.] 1. The act of telling; recital; account; narration; narrative of facts; as, an historical *relation*. We listened to the *relation* of his adventures.—2. Respect; reference; regard.

I have been importuned to make some observations on this art, in *relation* to its agreement with poetry. *Dryden.*

3. Connection between things; mutual respect, or what one thing is with regard to another; as, the *relation* of a citizen to the state; the *relation* of a subject to the supreme authority; the *relation* of husband and wife, or of master and servant; the *relation* of a state of probation to a state of retribution.—4. Kindred; alliance; as, the *relation* of parents and children.

*Relations* dear, and all the charities Of father, son, and brother, first were known. *Milton.*

5. A person connected by consanguinity or affinity; a kinsman or kinswoman. He passed a month with his *relations* in the country.—6. Resemblance of phenomena; analogy.—7. In *geom.*, ratio; proportion. The term is sometimes used in a more general sense, indicating any dependence of one quantity upon another.—8. In *logic*, one of the ten predicaments or accidents belonging to substance.—*Inharmonic relation*, in *music*, a term denoting that a dissonant sound is introduced which was not heard in the preceding chord.

—9. In *arch.*, the direct conformity to each other, and to the whole, of the different parts of a building.

**RELA'TIONAL**, *a.* Having relation or kindred.

We might be tempted to take these two nations for *relational* stems. *Tooke.*

**RELA'TIONSHIP**, *n.* The state of being related by kindred, affinity, or other alliance.

**RELATIVE**, *a.* [Fr. *relatif*; *L. relativus*.] 1. Having relation; respecting. The arguments may be good, but they are not *relative* to the subject.—2. Not absolute or existing by itself; considered as belonging to or respecting something else.

Every thing sustains both an absolute and a *relative* capacity; an absolute, as it is such a thing, endowed with such a nature; and a *relative*, as it is a part of the universe, and so stands in such a relation to the whole. *South.*

3. Incident to man in society; as, *relative* rights and duties.—4. † Particular; positive.—*Relative mode*, in *music*, the mode which the composer interweaves with the principal mode in the flow of the harmony.—*Relative terms*, in *logic*, terms which imply relation, as guardian and ward; master and servant; husband and wife.—*Relative word*, in *gram.*, a word which relates to another word, called its antecedent, or to a sentence or member of a sentence, or to a series of sentences. The English language possesses two words for the relative pronoun, viz., *who* or *which*, and *that*.—*Relative gravity*, the same as specific gravity.—*Relative place*, that part of space which is considered with regard to other adjacent objects.—*Relative motion*, the change of the relative place of a moving body with respect to some other body also in motion.—*Relative time*, the sensible measure of any part of duration by means of motion. [See **MOTION**, **TIME**.]

**RELATIVE**, *n.* A person connected by blood or affinity; strictly, one allied by blood; a relation; a kinsman or kinswoman.

Confining our care either to ourselves and *relatives*. *Fell.*

2. That which has relation to something else.—3. In *gram.*, a word which relates to or represents another word, called its antecedent, or to a sentence or member of a sentence, or to a series of sentences, which constitutes its antecedent. "He seldom lives frugally, *who* lives by chance." Here *who* is the relative, which represents *he*, the antecedent. "Judas declared him innocent, *which* he could not be, had he deceived his disciples."—*Porteus*. Here *which* refers to *innocent*, an adjective, as its antecedent. "Another reason that makes me doubt of any innate practical principles, is, that I think there cannot any one moral rule be proposed, whereof a man may not justly demand a reason; *which* would be perfectly ridiculous and absurd, if they were innate, or so much as self-evident, *which* every innate principle must needs be."—*Locke*. If we ask the question, what would be ridiculous and absurd, the answer must be, *whereof* a man may justly demand a reason, and this part of the sentence is the antecedent to *which*. *Self-evident* is the antecedent to *which* near the close of the sentence.

**RELATIVELY**, *adv.* In relation or

respect to something else; with relation to each other and to other things; not absolutely.

Consider the absolute affections of any being as it is in itself, before you consider it *relatively*. *Watts.*

**RELATIVENESS**, *n.* The state of having relation.

**RELA'TOR**, *n.* In *law*, one who brings an information in the nature of a *quo warranto*.

**RELAX**, *v. t.* [*L. relaxo*; *re* and *laxo*, to slacken; *Fr. relâcher, relâcher*. See **LAX**.] 1. To slacken; to make less tense or rigid; as, to *relax* a rope or cord; to *relax* the muscles or sinews; to *relax* the reins in riding.—2. To loosen; to make less close or firm; as, to *relax* the joints.—3. To make less severe or rigorous; to remit or abate in strictness; as, to *relax* a law or rule of justice; to *relax* a demand.—4. To remit or abate in attention, assiduity, or labour; as, to *relax* study; to *relax* exertions or efforts.—5. To unbend; to ease; to relieve from close attention; as, conversation *relaxes* the mind of the student.—6. To relieve from constipation; to loosen; to open; as, medicines *relax* the bowels.—7. To open; to loose.—8. To make languid.

**RELAX**, *v. i.* To abate in severity; to become more mild or less rigorous.

In others she *relax'd* again,

And govern'd with a looser rein. *Prior*.  
2. To remit in close attention. It is useful for the student to *relax* often, and give himself to exercise and amusements.

**RELAX**, † *n.* Relaxation.

**RELAXABLE**, *a.* That may be remitted.

**RELAXATION**, *n.* [Fr. from *L. relaxatio*.] 1. The act of slackening or remitting tension; as, a *relaxation* of the muscles, fibres, or nerves; a *relaxation* of the whole system.—2. Cessation of restraint.—3. Remission or abatement of rigour; as, a *relaxation* of the law.—4. Remission of attention or application; as, a *relaxation* of mind, study, or business.—5. An opening or loosening.—6. In *pathol.*, diminution of the natural and healthy tone of parts.—*Letters of relaxation*, in *Scots law*, letters passing the signet, whereby a debtor is relieved from the horn, that is, from personal diligence. Such letters are not now employed in civil cases, but in criminal prosecutions. One who has been outlawed may apply to the court of justiciary for letters of relaxation, reponing him against the sentence.

**RELAXATIVE**, *a.* Having the quality of relaxing. [See **LAXATIVE**.]

**RELAXATIVE**, *n.* That which has power to relax.

**RELAXED**, *pp.* Slackened; loosened; remitted or abated in rigour or in closeness; made less vigorous; languid.

**RELAXING**, *ppr.* Slackening; loosening; remitting or abating in rigour, severity, or attention; rendering languid.

**RELAXING**, *a.* Tending to relax; adapted to weaken the solids; as, a *relaxing* medicine.

**RELAY**, *n.* [Fr. *relais*.] 1. A supply of horses placed on the road to be in readiness to relieve others, that a traveller may proceed without delay.—2. In *hunting*, a fresh set of dogs or horses, or both, placed in readiness at certain

places, in case the game comes that way, to be cast off, or to mount the hunters in lieu of the horses already weary.—3. An opening left in a piece of tapestry where the figures or colours are to be changed, or which is to be filled up when the other work is done.

**RELAY**, *v. t.* [*re* and *lay*.] To lay again; to lay a second time; as, to *relay* a pavement.

**RELAYING**, *ppr.* Laying a second time.

**RELEASABLE**, *a.* That may be released.

**RELEASE**, *v. t.* [This is usually derived from *Fr. relâcher*, to slacken, to *relax*, *It. rilasciare* and *rilasciare*, and these words have the sense of *release*; but the English word has not the sense of *relax*, but of *re* and *lease*, from *Fr. laisser*, Eng. *let*, a word that has no connection with *relax*. So in *G. freilassen*, *D. vrylâaten*; *free* and *let*. If it is from *relâcher*, it has undergone a strange alteration.] 1. To set free from restraint of any kind, either physical or moral; to liberate from prison, confinement, or servitude; *Matt. xv.*; *Mark xv.*—2. To free from pain, care, trouble, grief, &c.—3. To free from obligation or penalty; as, to *release* one from debt, from a promise or covenant.—4. To quit; to let go, as a legal claim; as, to *release* a debt, or forfeiture; *Deut. xv.*—5. To discharge or relinquish a right to lands or tenements, by conveying it to another that has some right or estate in possession, as when the person in remainder *releases* his right to the tenant in possession; when one co-parcener *releases* his right to the other; or the mortgagee *releases* his claim to the mortgager.—6. † To relax.

**RELEASE**, *n.* Liberation or discharge from restraint of any kind, as from confinement or bondage.—2. Liberation from care, pain, or any burden.—3. Discharge from obligation or responsibility, as from debt, penalty, or claim of any kind; acquaintance.—4. In *law*, properly speaking, a discharge of a right; an instrument in writing, by which estates, rights, titles, entries, actions, and other things, are extinguished and discharged; and sometimes transferred, abridged, or enlarged, and in general it signifies a person's giving up or discharging the right or action he has, or claims to have against another, or his lands. The operative words in a release are, *remise, release, renounce*, and for ever *quit claims*. A release of all demands discharges all sorts of actions, rights, titles, conditions, executions, appeals, covenants, contracts, annuities, rents, recognizances, &c.

**RELEASED**, *pp.* Set free from confinement; free from obligation or liability; freed from pain; acquitted.

**RELEASEE**, *n.* A person to whom a release is given.

**RELEASEMENT**, *n.* The act of releasing from confinement or obligation.

**RELEASER**, *n.* One who releases.

**RELEASING**, *ppr.* Liberating from confinement or restraint; freeing from obligation or responsibility, or from pain or other evil; quitting.

**RELEASOR**, *n.* In *law*, he who quits or renounces that which he has.

**REL'EGATE**, *v. t.* [*L. relego*; *re* and *lego*, to send.] To banish; to send into exile.

**REL'EGATED**, *pp.* Sent into exile.

**REL'EGATING**, *ppr.* Banishing.

**RELEGATION**, *n.* [*L. relegatio.*] The act of banishment; a kind of banishment or exile by which the obnoxious person is commanded to retire to a certain place prescribed, and to remain there, until recalled or removed.

**RELENT**, *v. i.* [*Fr. ralentir; Sp. ablandar; Port. abrandar;* the two latter from *blando, L. blandus*, which unites the *L. blandus* with *lentus*. The English is from *re* and *L. lentus*, gentle, phiant, slow, the primary sense of which is soft or yielding. The *L. lenis* is probably of the same family. See **BLAND**.] 1. To soften; to become less rigid or hard; to give.

In some house, sweetmeats will *relent* more than in others. *Bacon.*

When opening buds salute the welcome day,  
And earth *relenting* feels the genial ray.

*Pop.*

[*This sense of the word is admissible in poetry, but is not in common use.*]—2.† To grow moist; to deliquesce; applied to salts; as, the *relenting* of the air.

Salt of tartar...placed in a cellar, will begin to *relent*. *Boyle.*

3. To become less intense. [*Little used.*]—4. To soften in temper; to become more mild and tender; to feel compassion. [*This is the usual sense of the word.*]

Can you behold

My tears, and not once *relent*? *Shak.*

**RELENT**, *v. t.* To slacken.

†And oftentimes he would *relent* his pace. *Spenser.*

2.† To soften; to mollify.

**RELENT**, † *pp.* Dissolved.

**RELENT**, † *n.* Remission; stay.

**RELENTED**, *pp.* Softened in temper.

**RELENTING**, *pp.* Softening in temper; becoming more mild or compassionate.

**RELENTING**, *n.* The act of becoming more mild or compassionate.

**RELENTLESS**, *a.* Unmoved by pity; un pitying; insensible to the distresses of others; destitute of tenderness; as, a prey to *relentless* despotism.

For this th' avenging power employs his darts,

Thus will persist, *relentless* in his ire.

*Dryden.*

*Relentless thoughts*, in Milton, may signify unremitting, intently fixed on disquieting objects. [*This sense of the word is unusual and not to be countenanced.*]

**RELENTLESSLY**, *adv.* Without pity.

**RELENTLESSNESS**, *n.* The quality of being unmoved by pity.

**RELESSEE'**, *n.* [See **RELEASE**.] The person to whom a release is executed.

**RELESSOR'**, *n.* The person who executes a release.

There must be a privacy of estate between the *releவர்* and *relesee*.

*Blackstone.*

**RELET'**, *v. t.* To let anew, as a house.

**RELEVANCE**, † *n.* [See **RELEVANT**.]

**RELEVANCY**, † *n.* The state of being relevant, or of affording relief or aid.—2. Pertinence; applicableness. [*This is the usual sense of the word.*]—3. In *Scots law*, fitness, pertinency. The *relevancy* of the libel, in *Scots law*, is the justice and sufficiency of the matters therein stated, to warrant a decree in the terms asked. The *relevancy* of the defence is the justice of the allegation therein made to elide the conclusion of the libel, and to warrant a decree of absolvitur.

**RELEVANT**, *a.* [*Fr. from L. relever,* to relieve, to advance, to raise; *re* and

*lever*, to raise.] 1. Relieving; lending aid or support.—2. Pertinent; applicable. The testimony is not *relevant* to the case. The argument is not *relevant* to the question. [*This is the sense in which the word is now generally used.*]—3. In *Scots law*, sufficient to support the cause.

**RELEVATION**, † *n.* A raising or lifting up.

**RELIABLE**, *a.* That may be relied on or trusted.

**RELIABLENESS**, † *n.* The state of **RELIABILITY**, † being reliable.

**RELIANCE**, *n.* [*from rely.*] Rest or repose of mind, resulting from a full belief of the veracity or integrity of a person, or of the certainty of a fact; trust; confidence; dependence. We may have perfect *reliance* on the promises of God; we have *reliance* on the testimony of witnesses; we place *reliance* on men of known integrity, or on the strength and stability of government.

**RELIC**, *n.* [*Fr. relique; L. reliquie,* from *relinguo,* to leave; *re* and *linguo.*]

1. That which remains; that which is left after the loss or decay of the rest; as, the *relics* of a town; the *relics* of magnificence; the *relics* of antiquity. The *relics* of saints, real or pretended, are held in great veneration by the Romanists. They consist of the remains of saints or holy men, or of their garments, &c., and are considered in many instances to be endowed with miraculous powers. They are preserved in the churches, convents, &c., to which pilgrimages are by their means frequently made. The virtues which are attributed to them, are defended by such instances from scripture as that of the miracles which were wrought by the bones of Elisha; 2 Kings xiii. 21.—2. The body of a deceased person; a corpse, under the notion of its being deserted by the soul. [*Usually in the plural.*]

**RELICELY**, *adv.* In the manner of *relics*. [*Little used.*]

**RELICT**, *n.* [*L. relictus, relicta,* from *relinguo,* to leave.] A widow; a woman whose husband is dead.

**RELIED**, *pp.* Reposed on something, as the mind; confided in; depended.

**RELIEF**, *n.* [*Fr. relief; It. rilevo, rilievo,* from *rilevare,* to raise, to lift, to remove; *Sp. relieves, relevar; re* and *llevar,* to raise.] 1. The removal, in whole or in part, of any evil that afflicts the body or mind; the removal or alleviation of pain, grief, want, care, anxiety, toil, or distress, or of any thing oppressive or burdensome, by which some ease is obtained. Rest gives *relief* to the body when weary; an anodyne gives *relief* from pain; the sympathy of friends affords some *relief* to the distressed; a loan of money to a man embarrassed may afford him a temporary *relief*; medicines which will not cure a disease, sometimes give a partial *relief*. A complete *relief* from the troubles of life is never to be expected.—2. That which mitigates or removes pain, grief, or other evil.—3. The dismissal of a sentinel from his post, whose place is supplied by another soldier; also, the person who takes his place.—4. In *sculpt.*, *arch.*, &c., the projection or prominence of a figure above or beyond the ground or plane on which it is formed. Relief is of three kinds; high relief [*alto rilievo*]; low relief [*basso rilievo*]; and half relief

[*mezzo rilievo*.] The difference is in the degree of projection. *High relief* is formed from nature, as when a figure



High Relief.

projects as much as the life. *Low relief* is when the figure projects but



Low Relief.

little, as in medals, festoons, foliages, and other ornaments. *Half relief* is when one half of the figure rises from the plane.—5. In *painting*, the appearance of projection, or the degree of boldness which a figure exhibits to the eye at a distance.—6. In *feudal law*, a fine or composition which the heir of a tenant, holding by knight's service or other tenure, paid to the lord at the death of the ancestor, for the privilege of taking up the estate which, on strict feudal principles, had lapsed or fallen to the lord on the death of the tenant. This relief consisted of horses, arms, money, and the like, the amount of which was originally arbitrary, but afterward fixed at a certain rate by law. It is not payable, unless the heir at the death of his ancestor had attained to the age of twenty-one years.—*Casualty of relief*, in *Scots law*, a sum exigible from an heir on his entry with the superior.—7. A remedy, partial, or total, for any wrong suffered; redress; indemnification. He applied to chancery, but could get no *relief*. He petitioned parliament and obtained *relief*.—8. The exposure of any thing by the proximity of something else.

**RELIEF SYNOD**, *n.* A body of presbyterian dissenters in Scotland, whose ground of separation, from the established church, was the violent exercise of lay-patronage which obtained in the latter. Gillespie, its founder, was deposed in 1752, and the first Relief Presbytery met October 22, 1761. On 13th May, 1847, the Relief Synod united with the United Secession, forming one body, named the United Presbyterian Church.

**RELIEVER**, *n.* [*from rely.*] One who relieves, or places full confidence in.

**RELIEVABLE**, *a.* Capable of being relieved; that may receive relief.

**RELIEVE**, *v. t.* [*Fr. relever; L. relevo.* See **RELIEF**.] 1. To free, wholly, or partially, from pain, grief, want, anxiety, care, toil, trouble, burden, oppression, or any thing that is considered to be an evil; to ease of any thing that



pains the body or distresses the mind. Repose *relieves* the wearied body; a supply of provisions *relieves* a family in want; medicines may *relieve* the sick man, even when they do not cure him. We all desire to be *relieved* from anxiety and from heavy taxes. Law or duty, or both, require that we should *relieve* the poor and destitute.—2. To alleviate or remove; as when we say, to *relieve* pain or distress; to *relieve* the wants of the poor.—3. To dismiss from a post or station, as sentinels, a guard or ships, and station others in their place. Sentinels are generally *relieved* every two hours; a guard is usually *relieved* once in twenty-four hours.—4. To right; to ease of any burden, wrong, or oppression by judicial or legislative interposition, by the removal of a grievance, by indemnification for losses and the like.—5. To abate the inconvenience of any thing by change, or by the interposition of something dissimilar. The moon *relieves* the lustre of the sun with a milder light.

The poet must not encumber his poem with too much business, but sometimes *relieve* the subject with a moral reflection.

*Addition.*

6. To assist; to support.

Parallels or like relations alternately *relieve* each other; when neither will pass asunder, yet they are plausible together.

*Brown.*

7. To set off by contrast; to give the appearance of projection, or prominence to, by the juxtaposition of some contrast. [See RELIEF.]

**RELIEVED**, *pp.* Freed from pain or other evil; eased or cured; aided; succoured; dismissed from watching.

—2. Alleviated or removed; as pain or distress.—3. Set off by contrast.

**RELIEVER**, *n.* One that relieves; he or that which gives ease.—2. In *gunnery*, an iron ring fixed to a handle by means of a socket, which serves to disengage the searcher of a gun, when one of its points is retained in a hole.

**RELIEVING**, *ppr.* Removing pain or distress, or abating the violence of it; easing; curing; assisting; dismissing from a post, as a sentinel; supporting; setting off by contrast.—*Relieving arch*, an arch formed in the substance of a wall, to relieve the part below it from a superincumbent weight. It is also called a discharging arch.—*Relieving tackles*, in *ships*, temporary tackles

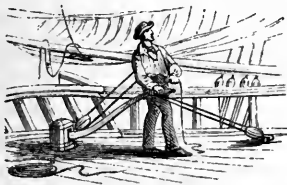

Steering with Relieving Tackles.

attached to the end of the tiller in bad weather to assist the helmsman, and in case of accident happening to the tiller ropes.

**RELIEVO**, *n.* An erroneous spelling for *Rilievo*, which means the real or seeming saliency of a sculptured or depicted figure. [See RELIEF.]

**RELIGHT**, *v. t.* (reli' te). [*re* and *light*.] To light anew; to illuminate again.—2. To rekindle; to set on fire again.

**RELIGHTED**, *pp.* Lighted anew; rekindled.

**RELIGHTING**, *ppr.* Lighting again; rekindling.

**RELIGIEUX**, *n. masc.* } [Fr.] In *Ro-*  
**RELIGIEUSE**, *n. fem.* } *man catholic*  
*countries*, a person engaged by vows to follow a certain rule of life authorized by the church. An inhabitant of a monastery is called a *religieux*; that of a nunnery a *religieuse*. A plurality of the one forms *religieux*, of the other *religieuses*.

**RELIGION**, *n.* (relij' ion.) [Fr. and Sp. *religion*; L. *religio*, from *religo*, to bind anew; *re* and *ligo*, to bind. This word seems originally to have signified an oath or vow to the gods, or the obligation of such an oath or vow, which was held very sacred by the Romans.]

1. Religion, in its most comprehensive sense, includes a belief in the being and perfections of God, in the revelation of his will to man, in man's obligation to obey his commands, in a state of reward and punishment, and in man's accountableness to God; and also true godliness or piety of life, with the practice of all moral duties. It therefore comprehends theology, as a system of doctrines or principles, as well as practical piety; for the practice of moral duties without a belief in a divine lawgiver, and without reference to his will or commands, is not religion.

—2. *Religion*, as distinct from *theology*, is godliness or real piety in practice, consisting in the performance of all known duties to God and our fellow men, in obedience to divine command, or from love to God and his law; James i.

*Religion* will attend you...as a pleasant and useful companion, in every proper place and every temperate occupation of life.

*Buckminster.*

3. *Religion*, as distinct from *virtue*, or *morality*, consists in the performance of the duties we owe directly to God, from a principle of obedience to his will. Hence we often speak of *religion* and *virtue*, as different branches of one system, or the duties of the first and second tables of the law.

Let us with caution indulge the supposition, that morality can be maintained without *religion*.

*Washington.*

4. Any system of faith and worship. In this sense, religion comprehends the belief and worship of pagans and Mohammedans, as well as of Christians; any religion consisting in the belief of a superior power or powers governing the world, and in the worship of such power or powers. Thus we speak of the *religion* of the Turks, of the Hindus, of the Indians, &c., as well as of the Christian *religion*. We speak of *false religion*, as well as of *true religion*.

—5. The rites of religion; in the plural.—*Established religion*, that form of religion in a state which is recognized and sanctioned by the state, in distinction from other forms, and to which certain privileges and distinctions are attached. The episcopal form of religion is established in England, and the presbyterian form in Scotland.

**RELIG'IONARY**, *† a.* Relating to religion; pious.

**RELIG'IONISM**, *n.* The practice of religion; adherence to religion. [Not authorized.]

**RELIG'IONIST**, *n.* A bigot to any religious persuasion; one who deals much in religious terms, discourse, and doctrine.

**RELIG'IOUS**, *a.* [Fr. *religieux*; L. *religiosus*.] 1. Pertaining or relating to religion; as, a *religious* society; a *religious* sect; a *religious* place; *religious* subjects.—2. Pious; godly; loving and reverencing the Supreme Being and obeying his precepts; as, a *religious* man.—3. Devoted to the practice of religion; as, a *religious* life.—4. Teaching religion; containing religious subjects or the doctrines and precepts of religion, or the discussion of topics of religion; as, a *religious* book.—5. Exact; strict; such as religion requires; as, a *religious* observance of vows or promises.—6. Engaged by vows to a monastic life; as, a *religious* order or fraternity.—7. Appropriated to the performance of sacred or religious duties; as, a *religious* house.—*Religious liberty*, liberty of conscience; the freedom of a man to worship God according to his belief and the dictates of his conscience, provided he do not thereby disturb the peace of the commonwealth.

**RELIG'IOUS**, *n.* A person bound by monastic vows, or sequestered from secular concerns and devoted to a life of piety and devotion; a monk or friar; a nun. [The use of this word as a noun is inconvenient from its form being the same as that of the adjective. It is better to adopt the French word RELIGIEUX,

—which see.]

**RELIG'IOUS HOUSES**, *n.* In *catholic countries*, different asylums or habitations for priests, nuns, and poor; as, abbeys, monasteries, nunneries, &c.

**RELIG'IOUSLY**, *adv.* Piously; with love and reverence to the Supreme Being; in obedience to the divine commands.—2. According to the rites of religion.—3. Reverently; with veneration.

—4. Exactly; strictly; conscientiously; as, a vow or promise *religiously* observed.

**RELIG'IOUSNESS**, *n.* The quality or state of being religious.

**RELIN'QUENT**, *a.* Relinquishing. As a noun, one who relinquishes.

**RELIN'QUISH**, *v. t.* [L. *relinquo*; *re* and *linquo*, to leave, to fail, or faint; from the same root as *liqueo*, *liquo*, to melt or dissolve, *deliquim*, a fainting, *Ir. leagham*, to melt. Hence, the sense is to withdraw or give way; to relinquish is to recede from. It is probably allied to *flag* and *stach*; W. *llac*, *llactaw*, to slacken; *llegu*, to flag.] 1. To withdraw from; to leave; to quit. It may be to forsake or abandon, but it does not necessarily express the sense of the latter. A man may *relinquish* an enterprise for a time, or with a design never to resume it. In general, to *relinquish* is to leave without the intention of resuming, and equivalent to *forsake*, but is less emphatical than *abandon* and *desert*.

They placed Irish tenants on the lands *relinquished* by the English. *Dari-s.*

2. To forbear; to withdraw from; as, to *relinquish* the practice of intemperance; to *relinquish* the rites of a church.

—3. To give up; to renounce a claim to; as, to *relinquish* a debt.—*To relinquish back*, or *to*, to give up; to release; to surrender; as, to *relinquish* a claim to another.

**RELIN'QUISHED**, *pp.* Left; quitted; given up.

**RELIN'QUISHER**, *n.* One who leaves or quits.

**RELIN'QUISHING**, *ppr.* Quitting; leaving; giving up.

**RELIN'QUISHMENT**, *n.* The act of

leaving or quitting; a forsaking; the renouncing a claim to.

REL'IQUEARY, *n.* [Fr. *reliquaire*, from *L. reliquo*.] A depository for relics; a casket in which relics are kept; called also a shrine.

RELIQUE, *n.* A relic. [See RELIC.]

RELIQUILÆ, *n.* [L. *remnants*, remains of the dead.] Among *geologists*, a term used to express the fossil remains of various animal, vegetable, and other substances, found in different parts of the globe.

RELIQUIDATE, *v. t.* [*re* and *liquidate*.] To liquidate anew; to adjust a second time.

RELIQUIDATED, *pp.* Liquidated again.

RELIQUIDATING, *ppr.* Liquidating again.

RELIQUIDA'TION, *n.* A second or renewed liquidation; a renewed adjustment.

REL'ISH, *n.* [Fr. *relécher*; *re* and *lécher*, Gr. *λυξω*, to lick.] Taste; or rather, a pleasing taste; that sensation of the organs which is experienced when we take food or drink of an agreeable flavour. Different persons have different *relishes*. *Relish* is often natural, and often the effect of habit.—2. Liking; delight; appetite.

We have such a *relish* for faction, as to have lost that of wit. Addison.

3. Sense; the faculty of perceiving excellence; taste; as, a *relish* for fine writing, or a *relish* of fine writing. Addison uses both *of* and *for* after *relish*; but a *relish of* may be used to signify actual taste, and a *relish for*, a disposition to taste.—4. That which gives pleasure; the power of pleasing. When liberty is gone, Life grows insipid and has lost its *relish*. Addison.

5. Cast; manners.

It preserves some *relish* of old writing. Pope.

6. Taste; a small quantity just perceptible.

Devotion, patience, courage, fortitude, I have no *relish* of them. Shaks.

REL'ISH, *v. t.* To give an agreeable taste to.

A sav'ry bit that serv'd to *relish* wine. Dryden.

2. To like the taste of; as, to *relish* venison.—3. To be gratified with the enjoyment or use of.

He knows how to prize his advantages and to *relish* the honours which he enjoys. Atterbury.

Men of nice palates would not *relish* Aristotle, as dressed up by the schoolmen. Baker.

REL'ISH, *v. i.* To have a pleasing taste.

The greatest dainties do not always *relish*.—2. To give pleasure.

Had I been the finder out of this secret, it would not have *relished* among my other discredits. Shaks.

3. To have a flavour.

A theory which, how much soever it may *relish* of wit and invention, hath no foundation in nature. Woodward

REL'ISHABLE, *a.* Gustable; having an agreeable taste.

REL'ISHED, *pp.* Giving an agreeable taste; received with pleasure.

RELIVE, *v. i.* (*reliv'*) [*re* and *live*.] To live again; to revive.

RELIVE,† *v. t.* (*reliv'*) To recall to life.

REL'ÖAN', *v. t.* [*re* and *loan*.] To lend again; to lend what has been lent and repaid. [American.]

RE-LOAN', *n.* A second lending of the same money. *President's Message, U. S.*

RE-LOAN'ED, *pp.* Lent again.

RE-LOAN'ING, *ppr.* Lending again.

RELO'ÖATE, *v. t.* To locate a second time.

RELOC'ATION, *n.* [L. *reloco*, to let out again.] In *Scots law*, a re-letting; renewal of a lease.—*Tacit relocation*, the tacit or implied renewal of a lease; inferred where the landlord, instead of warning the tenant to remove at the stipulated expiration of the lease, has allowed him to continue without making any new agreement.

RELOVE,† *v. t.* [*re* and *love*.] To love in return.

RELU'CENT, *a.* [L. *relucens*, *reluceo*; *re* and *luceo*, to shine.] Shining; transparent; clear; pellucid; as, a *relucent* stream.

RELU'CT', *v. i.* [L. *reductor*; *re* and *luctor*, to struggle.] To strive or struggle against. [Little used.]

RELU'CT'ANCE, } *n.* [literally, a  
RELU'CT'ANCY, } straining or striving against.] Unwillingness; great opposition of mind; repugnance; with *to* or *against*; as, to undertake a war with *reluctance*. He has a great *reluctance* to this measure.

Bear witness, heav'n, with what *reluctancy* Her helpless innocence I doom to die. Dryden.

RELU'CT'ANT, *a.* Striving against; unwilling; much opposed in heart.

*Reluctant* now I touch'd the trembling string. Tickell.

2. Unwilling; acting with slight repugnance; coy.—3. Proceeding from an unwilling mind; granted with reluctance; as, *reluctant* obedience.

RELU'CT'ANTLY, *adv.* With opposition of heart; unwillingly. What is undertaken *reluctantly* is seldom well performed.

RELU'CT'ATE, *v. t.* To resist; to struggle against.

RELU'CT'ATION, *n.* Repugnance; resistance.

RELU'CT'ING, *ppr.* Striving to resist.—2. *a.* Averse; unwilling.

RELÖME, *v. t.* [Fr. *rallumer*; L. *re* and *lumen*, light.] To rekindle; to light again.

RELÖMED, *pp.* Rekindled; lighted again.

RELÖMINE, *v. t.* [It. *ralluminare*; L. *relumino*; *re* and *lumen*, light, from *luceo*, to shine.] 1. To light anew; to rekindle.—2. To illuminate again.

RELÖMINED, *pp.* Rekindled; illuminated anew.

RELÖMING, *ppr.* Kindling or lighting anew.

RELÖMINING, *ppr.* Rekindling; enlightening anew.

RELY', *v. i.* [*re* and *lie*, or from the root of *lie, lay*.] To rest on something, as the mind when satisfied of the veracity, integrity, or ability of persons, or of the certainty of facts or of evidence; to have confidence in; to trust in; to depend; with *on* or *upon*. We *rely* on the promise of a man who is known to be upright; we *rely* on the veracity or fidelity of a tried friend; a prince *relies* on the affections of his subjects for support, and *on* the strength of his army for success in war; above all things, we *rely* on the mercy and promises of God. That which is the ground of confidence, is a certainty or full conviction that satisfies the mind and leaves it at rest, or undisturbed by doubt.

Because thou hast *relied* on the king of Syria, and not *relied* on the Lord thy God; 2 Chron. xvi.

RELY'ING, *ppr.* Reposing on something, as the mind; confiding in; trusting in; depending.

REMADE, *pret.* and *pp.* of *Remake*.

REMAIN, *v. i.* [L. *remaneo*; *re* and *maneo*, Gr. *μεινω, μανω*; Pers. *mandan*, and *mandan*, to remain, to be left, to delay, to be like, to dismiss, to leave. The sense seems to be to draw out in time, or to be fixed, or to continue. See analogies in *leave*. The sense of likeness may be a drawing.] 1. To continue; to rest or abide in a place for a time indefinite. They *remained* a month in Rome. We *remain* at an inn for a night, for a week, or a longer time.

*Remain* a widow at thy father's house, till Shelah my son be grown; Gen. xxxviii. 2. To be left after others have withdrawn; to rest or abide in the same place when others remove, or are lost, destroyed, or taken away.

Noah only *remained* alive, and they that were with him in the ark; Gen. vii.

3. To be left after a part or others have past. Let our *remaining* time or years be employed in active duties.—4. To continue unchanged, or in a particular state. He *remains* stupid; he *remains* in a low state of health.—5. Not to be lost; not to escape; not to be forgotten.

All my wisdom *remained* with me. Eccus. 6. To be left, out of a greater number or quantity. Part of the debt is paid; that which *remains* will be on interest.

That which *remaineth* over, lay up for you to be kept till the morning; Exod. xvi.

7. To be left as not included or comprised. There *remains* one argument which has not been considered.

That an elder brother has power over his brethren, *remains* to be proved. Locke.

8. To continue in the same state. Childless thou art, childless *remain*.

Milton.

REMAIN, *v. t.* To await; to be left to; as, the easier conquest now *remains* thee. [This is elliptical for *remains* to thee. *Remain* is not properly a transitive verb.]

REMAIN,† *n.* Relic; that which is left; a corpse; also, abode. [See REMAINS.]

REMAINDER, *n.* Any thing left after the separation and removal of a part.

If these decoctions be repeated till the water comes off clear, the *remainder* yields no salt. Arbuthnot.

The last *remainders* of unhappy Dryden.

2.† Relics; remains; the corpse of a human being.—3. That which is left after a part is past; as, the *remainder* of the day or week; the *remainder* of the year; the *remainder* of life.—4. The sum that is left after subtraction or after any deduction.—5. In *law*, an estate limited to take effect and be enjoyed after another estate is determined. A grants land to B for twenty years; *remainder* to D in fee. If a man by deed or will limits his books or furniture to A for life, with *remainder* to B, this *remainder* is good. Remainders are either *vested* or *contingent*. *Vested* or *executed* remainders, are those by which a present interest passes to the party, though it is to be enjoyed in future, and by which the estate is invariably fixed to remain to a determinate person after the particular estate is spent; as if A be tenant for years, remainder to B in fee; hereby B's remainder is vested, which nothing can defeat or set aside. *Contingent remainders*, otherwise called *executory*, are defined to be "where the estate in

remainder is limited to take effect either to an uncertain person, or upon an uncertain event; so that the particular estate may chance to be determined, and the remainder never take effect."—*A writ of formedon in remainder* is a writ which lies where a man gives lands to another for life or in tail, with remainder to a third person in tail or in fee, and he who has the particular estate dies without issue heritable, and a stranger intrudes upon him in remainder and keeps him out of possession; in this case, the remainderman shall have his writ of formedon in the remainder.

REMAINDER, † *a.* Remaining; refuse; left; as, the *remainder* biscuit; the *remainder* viands.

REMAINDER-MAN, *n.* In *law*, he who has an estate after a particular estate is determined.

REMAINED, *pp.* Continued; left after others have withdrawn.

REMAINING, *pp.* Continuing; resting; abiding for an indefinite time; being left after separation and removal of a part, or after loss or destruction, or after a part is passed, as of time.

REMAINS, *n. plur.* That which is left after a part is separated, taken away, or destroyed; as, the *remains* of a city or house demolished.—2. A dead body; a corpse. The singular, *remain*, in the like sense, and in the sense of *abode*, is entirely obsolete.—*Organic remains*,—see ORGANIC.

REMAKE, *v. t. pret. and pp. Remade.* [*re* and *make*.] To make anew.

REMAND, † *v. t.* [*Fr. remander*; *L. re* and *mando*.] To call or send back him or that which is ordered to a place; as, to *remand* an officer from a distant place.—2. In *law*, to send an accused party back to jail, in order to give time to collect more evidence against him.

REMAND'ED, *pp.* Called or sent back.

REMAND'ING, *pp.* Calling or sending back.

REMAND'MENT, *n.* Remanding.

REMANENCE, } *n.* A remaining.  
REMANENCY, }

REMANENT, *n.* [*L. remanens*.] The part remaining. [*Little used*. It is contracted into *remnant*.]

REMANENT, *a.* Remaining. [*Lit. us.*]  
REMANET, *n.* In *Eng. law*, a suit standing over, or a proceeding connected with one which is delayed or deferred.

REMARK, † *n.* [*Fr. remarque*; *re* and *mark*.] Notice or observation, particularly notice or observation expressed in words or writing; as, the *remarks* of an advocate; the *remarks* made in conversation; the judicious or the uncanonid *remarks* of a critic. A *remark* is not always expressed; for we say, a man makes his *remarks* on a preacher's sermon while he is listening to it. In this case the notice is silent, a mere act of the mind.

REMARK, † *v. t.* [*Fr. remarquer*.] 1. To observe; to note in the mind; to take notice of without expression. I *remarked* the manner of the speaker; I *remarked* his elegant expressions.—2. To express in words or writing what one thinks or sees; to express observations; as, it is necessary to repeat what has been before *remarked*.—3. † To mark; to point out; to distinguish.

His manacles *remark* him. *Milton*.

REMARK'ABLE, *a.* [*Fr. remarquable*.] 1. Observable; worthy of notice.

'Tis *remarkable* that they  
Talk most, who have the least to say. *Prior*.

2. Extraordinary; unusual; that deserves particular notice, or that may excite admiration or wonder; as, the *remarkable* preservation of lives in shipwreck.

REMARK'ABLENESS, *n.* Observableness; worthiness of remark; the quality of deserving particular notice.

REMARK'ABLY, *adv.* In a manner or degree worthy of notice; as, the summers of 1826 and 1846 were *remarkably* hot; the winter of 1838 was *remarkably* severe.—2. In an extraordinary manner.

REMARK'ED, *pp.* Noticed; observed; expressed in words or writing.

REMARK'ER, *n.* An observer; one who makes remarks.

REMARK'ING, *pp.* Observing; taking notice of; expressing in words or writing.

REMAR'RIED, *pp.* Married again or a second time.

REMAR'RY, *v. t.* [*re* and *marry*.] To marry again or a second time.

REMAR'RYING, *pp.* Marrying again or a second time.

REMAST, *v. t.* To furnish with a second mast or set of masts.

REMAST'IGATE, *v. t.* [*re* and *masticate*.] To chew or masticate again; to chew over and over, as in chewing the cud.

REMAST'IGATED, *pp.* Chewed again or repeatedly.

REMAST'IGATING, *pp.* Chewing again or over and over.

REMAST'ICATION, *n.* The act of masticating again or repeatedly.

REMB'LAJ, *n.* [*Fr.*] A term used in *fortification* to denote the earth or materials used in filling up a trench or excavation.

REMBLE, *v. t.* To remove. [*Local*.]

REME'DIABLE, *a.* [*from remedy*.] That may be remedied or cured. The evil is believed to be *remediable*.

REME'DIABLY, *adv.* So as to be susceptible of remedy or cure.

REME'DIAL, *a.* [*L. remedialis*.] Affording a remedy; intended for a remedy, or for the removal of an evil.

The *remedial* part of law is so necessary a consequence of the declaratory and directory, that laws without it must be very vague and imperfect. Statutes are declaratory or *remedial*. *Blackstone*.

REME'DIATE, in the sense of *remedial*, is not in use.

REME'DIED, *pp.* [*from remedy*.] Cured; healed; repaired.

REME'DILESS, *a.* 1. Not admitting a remedy; incurable; desperate; as, a *remediless* disease.—2. Irreparable; as, a loss or damage is *remediless*.—3. Not admitting change or reversal; as, a *remediless* doom.—4. Not admitting recovery; as, a *remediless* delusion.

REME'DILESSLY, *adv.* In a manner or degree that precludes a remedy.

REME'DILESSNESS, *n.* Incurableness.

REME'DY, *n.* [*L. remedium*; *re* and *medeor*, to heal; *Fr. remède*.] 1. That which cures a disease; any medicine or application which puts an end to disease and restores health; with *for*; as, a *remedy* for the gout.—2. That which counteracts an evil of any kind; with *for*, *to*, or *against*; usually with *for*. Civil government is the *remedy* for the evils of natural liberty. What *remedy* can be provided for extravagance in dress? The man who shall invent an effectual *remedy* for intemperance, will deserve every thing from his fellow

men.—3. That which cures uneasiness. Our griefs how swift, our *remedies* how slow! *Prior*.

4. That which repairs loss or disaster; reparation.

In the death of a man there is no *remedy*. *Wisdom*.

REME'DY, *v. t.* [*Fr. remédier*.] 1. To cure; to heal; as, to *remedy* a disease.

—2. To cure; to remove, as an evil; as, to *remedy* grief; to *remedy* the evils of a war.—3. To repair; to remove mischief; in a very general sense.

REME'DYING, *pp.* Curing; healing; removing; restoring from a bad to a good state.

REMBELT, † *v. t.* [*re* and *melt*.] To melt a second time.

REMBELT'ED, *pp.* Melted again.

REMBELT'ING, *pp.* Melting again.

REMEMBER, *v. t.* [*Norm. remembre*; *Low L. rememoror*; *re* and *memoror*. See *MEMORR*.] 1. To have in the mind an idea which had been in the mind before, and which recurs to the mind without effort.

We are said to *remember* any thing, when the idea of it arises in the mind with the consciousness that we have had this idea before. *Watts*.

2. When we use effort to recal an idea, we are said to *recollect* it. This distinction is not always observed. Hence, *remember* is often used as synonymous with *recollect*, that is, to call to mind. We say, we cannot *remember* a fact, when we mean, we cannot *recollect* it.

*Remember* the days of old; Deut. xxxii.  
3. To bear or keep in mind; to attend to. *Remember* what I warn thee; shun to taste. *Milton*.

4. To preserve the memory of; to preserve from being forgotten.

Let them have their wages duly paid,  
And something over to *remember* me. *Shak*.

5. † To mention.—6. † To put in mind; to remind; as, to *remember* one of his duty.—7. To think of and consider; to meditate; Ps. lxiii.—8. To bear in mind with esteem; or to reward; Eccles. ix.—9. To bear in mind with praise or admiration; to celebrate; 1 Chron. xvi.—10. To bear in mind with favour, care, and regard for the safety or deliverance of any one; Ps. lxxiv.; Gen. viii.; Gen. xix.—11. To bear in mind with intent to reward or punish; 3 John 10; Jer. xxxi.—12. To bear in mind with confidence; to trust in; Ps. xx.—13. To bear in mind with the purpose of assisting or relieving; Gal. ii.—14. To bear in mind with reverence; to obey.

*Remember* thy Creator in the days of thy youth; Eccles. xii.  
15. To bear in mind with regard; to keep as sacred; to observe.

*Remember* the sabbath-day, to keep it holy; Exod. xx.

To *remember* mercy, is to exercise it; Hab. iii.

REMEMBERED, *pp.* Kept in mind; recollected.

REMEMBERER, *n.* One that remembers.

REMEMBERING, *pp.* Having in mind.

REMEMBRANCE, *n.* [*Fr.*] Retention in memory; recollection; reminiscence; the retaining or having in mind an idea which had been present before, or an idea which had been previously received from an object when present, and which recurs to the mind afterward without the presence of its object.

Technically, *remembrance* differs from *remembrance* and *recollection*, as the former implies that an idea occurs to the mind spontaneously, or without much mental exertion. The latter imply the power or the act of recalling ideas which do not spontaneously recur to the mind. The righteous shall be in everlasting remembrance; Ps. cxiii.

*Remembrance* is when the same idea occurs, without the operation of the like object on the external sensory. *Locke*.  
2. Transmission of a fact from one to another.

Titan

Among the heav'n's the immortal fact displayed,  
Lest the remembrance of his grief should fall.

*Addison*.

3. Account preserved; something to assist the memory.

Those proceedings and remembrances are in the Tower. *Hale*.

4. Memorial.

But in remembrance of so brave a deed,  
A tomb and funeral honours I decreed.

*Dryden*.

5. A token by which one is kept in the memory.

Keep this remembrance for thy Julia's sake.

*Shak.*

6. Notice of something absent.

Let your remembrance still apply to Banquo.

*Shak.*

7. Power of remembering; limit of time within which a fact can be remembered; as when we say, an event took place before our remembrance, or since our remembrance.—8.† Honourable memory.—9. Admonition.—10. Memorandum; a note to help the memory.

REMEMBRANCER, *n.* One that reminds, or revives the remembrance of any thing.

God is present in the consciences of good and bad; he is there a remembrancer to call our actions to mind. *Taylor*.

2. An officer in the exchequer of England, whose business is to record certain papers and proceedings, make out processes, &c.; a recorder. The officers bearing this name were formerly called *clerks of the remembrance*, and were three in number,—the *king's remembrancer*, the *lord treasurer's remembrancer*, and the *remembrancer of first fruits*; but the duties of the second of these offices were merged in the first by 3 and 4 Will. 4. c. 99.

REMEMORATE, † *v. t.* [*L. rememorat-us, rememoror.*] To remember; to revive in the memory.

REMEMORATION, † *n.* Remembrance.

REMER'CIÉ, } † *v. t.* [*Fr. remercier.*]  
REMER'CY, } To thank.

REMIGES, *n.* [*L. remigo, to row.*] The quill feathers of the wings of a bird, which, like oars, propel it through the air.

REMI'GRATE, *v. i.* [*L. remigro; re and migro, to migrate.*] To remove back again to a former place or state; to return. [*See MIGRATE.*]

REMI'GRATION, *n.* Removal back again; a migration to a former place.

REMI'ND, *v. t.* [*re and mind.*] To put in mind; to bring to the remembrance of; as, to remind a person of his promise.—2. To bring to notice or consideration.

Old age reminds us of our mortality.

REMI'NDED, *pp.* Put in mind.

REMI'NDER, *n.* One who reminds; that which reminds.

REMI'NDFUL, *a.* Tending or adapted to remind; careful to remind.

REMI'NDING, *ppr.* Putting in mind; calling attention to.

REMI'NIS'ENCE, *n.* [*Fr. from L. reminiscens, reminiscor, Gr. μνησκειν. See MEMORY.*] 1. That faculty of the mind by which ideas formerly received into it, but forgotten, are recalled or revived in the memory.—2. Recollection; recovery of ideas that had escaped from the memory.—3. Reminiscence seems often to signify recollection expressed; a relation of what is recollected.

REMI'NIS'ENCY, *n.* Reminiscence.

REMI'NIS'CENT, *n.* One who calls to mind, and records past events.

REMI'NISCENT'IAL, *a.* Pertaining to reminiscence or recollection.

REMI'PED, *n.* [*L. remus, an oar, and pes, a foot.*] An aquatic animal, whose feet serve as oars.

REMI'PEDS, *n.* An order of coleopterous insects, including those which have tarsi adapted for swimming.

REMISE, *v. t.* (*s as z.*) [*Fr. remise, from remettre; L. remissus, remitto; re and mitto, to send.*] To give or grant back; to release a claim; to resign or surrender by deed. A. B. hath *remised*, released, and for ever quitclaimed to B. C. all his right to the manor of Dale.

REMISE, *n.* [*Fr.*] In France, a carriage for hire, generally obtained from the *remise* or coach-house where it is kept, and not from the stand.

REMISED, *pp.* Released.

REMI'RING, *ppr.* Surrendering by deed.

REMISS', *a.* [*Fr. remis; L. remissus, supra.*] 1. Relaxed or slackened; slack; dilatory; negligent; slothful; not careful; not performing duty or business; not complying with engagements at all, or not in due time; as, to be *remiss* in attendance on official duties; *remiss* in payment of debts.—2. Slow; slack; languid.—3. Not intense.

These nervous, bold; those languid and *remiss*. *Roscommon*.

REMISS'IBLE, *a.* That may be remitted or forgiven.

REMISSIO INJU'RIÆ. [*L.*] In Scots law, a plea in an action of divorce for adultery, implying that the pursuer has already forgiven the offence.

REMISSION, *n.* [*Fr. from L. remissio, from remitto, to send back.*] 1. Abatement; relaxation; moderation; as, the *remission* of extreme rigour.—2. Abatement; diminution of intensity; as, the *remission* of the sun's heat; the *remission* of cold; the *remission* of close study or of labour.—3. Release; discharge or relinquishment of a claim or right; as, the *remission* of a tax or duty.—4. In *med.*, abatement; a temporary subsidence of the force or violence of a disease or of pain, as distinguished from *intermission*, in which the disease leaves the patient entirely for a time.—5. Forgiveness; pardon; that is, the giving up of the punishment due to a crime; as, the *remission* of sins; Matt. xxvi; Heb. ix.—6.† The act of sending back.

REMISSIVE, *a.* Remitting; forgiving.

REMISS'LY, *adv.* Carelessly; negligently; without close attention.—2. Slowly; slackly; not vigorously; not with ardour.

REMISS'NESS, *n.* Slackness; slowness; carelessness; negligence; want of ardour or vigour; coldness; want of punctuality; want of attention to

any business, duty, or engagement in the proper time or with the requisite industry.

REMIT', *v. t.* [*L. remitto, to send back; re and mitto, to send; Fr. remettre.*]

1. To relax, as intensity; to make less tense or violent.

So willingly doth God remit his ire.

*Milton*.

2. To forgive; to surrender the right of punishing a crime; as, to remit punishment.—3. To pardon, as a fault or crime.

Whosoever sins ye remit, they are remitted to them; John xx.

4. To give up; to resign.

In grievous and inhuman crimes, offenders should be remitted to their prince.

*Hayward*.

5. To refer; as, a clause that remitted all to the bishop's discretion.—6. To send back; to put again into custody.

The pris'ner was remitted to the guard.

*Dryden*.

7. To transmit money, bills, or other things in payment for goods received. American merchants remit money, bills of exchange, or some species of stock, in payment for British goods.—8. To restore.

In this case the law remits him to his ancient and more certain right.

*Blackstone*.

REMIT', *v. i.* To slacken; to become less intense or rigorous.

When our passions remit, the vehemence of our speech remits too.

*Broom*.

So we say, cold or heat remits.—2. To abate in violence for a time, without intermission; as, a fever remits at a certain hour every day.

REMIT', *n.* In Scots law, a remission; a sending back. In judicial procedure, the term is applied to an interlocutor or judgment transferring a cause either totally or partially, or for some specific purpose, from one tribunal or judge to another, or to a judicial nominee, to execute the purposes of the remit.

REMIT'MENT, *n.* The act of remitting to custody.—2. Forgiveness; pardon.

REMIT'TAL, *n.* A remitting; a giving up; surrender; as, the remittal of the first fruits.

REMIT'TANCE, *n.* In *com.*, the act of transmitting money, bills, or the like, to a distant place, in return or payment for goods purchased.—2. The sum or thing remitted in payment.

REMIT'TED, *pp.* Relaxed; forgiven; pardoned; sent back; referred; given up; transmitted in payment.

REMIT'TENT, *a.* [*L. remittens, from remitto, to assuage or lessen.*] Temporarily ceasing. A term applied to diseases, the symptoms of which diminish very considerably, but return again, so as not to leave the person free from the disease, until it changes its character or vanishes.—Remittent fever, any fever which suffers a decided remission of its violence during the twenty-four hours, but without entirely leaving the patient. It differs from an *intermittent* in this, that there is never a total absence of fever.

REMIT'TENT, *n.* A remittent fever.

REMIT'TER, *n.* One who remits, or makes remittance for payment.—2. In law, the restitution of a more ancient and certain right to a person who has right to lands, but is out of possession, and has afterward the freehold cast upon him by some subsequent defective title, by virtue of which he enters.—3. One that pardons.

REMITTING, *ppr.* Relaxing; forgiving; sending back; transmitting in payment.

REM'NANT, *n.* [contracted from *remnant*. See *REMAIN*.] 1. Residue; that which is left after the separation, removal, or destruction of a part.

The *remnant* that are left of the captivity; Neh. i.

2. That which remains after a part is done, performed, told, or passed.

The *remnant* of my tale is of a length To tire your patience. *Dryden.*

Where I may think the *remnant* of my thoughts. *Shak.*

REM'NANT, *a.* Remaining; yet left.

And quiet dedicate her *remnant* life To the just duties of a humble wife. [*Little used.*] *Prior.*

REM'OD'EL, *v. t.* [*re* and *model*.] To model or fashion anew.

REM'OD'ELLED, *pp.* Modelled anew. REM'OD'ELLING, *ppr.* Modelling again.

REM'OL'IENT, *a.* [*Fr.*] Mollifying; softening.

REM'OLTEN, *a.* or *pp.* [*re* and *molten*, from *melt*.] Melted again.

REM'ONSTRANCE, *n.* [*Fr. rémonstrance*. See *REMONSTRATE*.] 1.† Show; discovery.—2. Expostulation; strong representation of reasons against a measure, either public or private; and when addressed to a public body, a prince or magistrate, it may be accompanied with a petition or supplication for the removal or prevention of some evil or inconvenience. A party aggrieved presents a *remonstrance* to the legislature.—3. Pressing suggestions in opposition to a measure or act; as, the *remonstrances* of conscience or of justice.—4. Expostulatory counsel or advice; reproof.—5. In the *Roman catholic church*, the same as *monstrance*,—*which see*.

REM'ONSTRANT, *a.* Expostulatory; urging strong reasons against an act.

REM'ONSTRANT, *n.* One who remonstrates. The appellation of *remonstrants* is given to the Arminians who remonstrated against the decisions of the Synod of Dort, in 1618.

REM'ONSTRATE, *v. i.* [*L. remonstro*; *re* and *monstro*, to show; *Fr. remontrer*. See *MUSTER*.] 1. To exhibit or present strong reasons against an act, measure, or any course of proceedings; to expostulate. Men *remonstrate* by verbal argument, or by a written exposition of reasons.—2. To suggest urgent reasons in opposition to a measure. Conscience *remonstrates* against a profligate life.

REM'ONSTRATE, *v. t.* To show by a strong representation of reasons.

REM'ONSTRATED, *pp.* Opposed by urging strong reasons against a measure.

REM'ONSTRATING, *ppr.* Urging strong reasons against a measure.

REM'ONSTRATION, *n.* The act of remonstrating. [*Little used.*]

REM'ONSTRATOR, *n.* One who remonstrates.

REM'ORA, *n.* [*L.* from *re* and *moror*, to delay.] 1.† Delay; obstacle; hindrance.—2. The sucking-fish, a species of *Echeneis*, having a flattened, oval, adhesive disk on the top of the head, by means of which they are able to attach themselves firmly to the surface of other fishes, or to the bottoms of vessels; but whether for protection or

conveyance, or both, has not been satisfactorily ascertained.

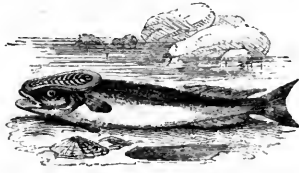

Remora (*Echeneis remora*).

REM'ORATE,† *v. t.* [*L. remoror*.] To hinder; to delay.

REM'ORD',† *v. t.* [*L. remordeo*; *re* and *mordeo*, to gnaw.] To rebuke; to excite to remorse.

REM'ORD',† *v. i.* To feel remorse. REM'ORD'ENCY, *n.* Compunction; remorse.

REMORSE', *n.* (remors'.) [*L. remorsus*, from *remordeo*.] 1. The keen pain or anguish excited by a sense of guilt; compunction of conscience for a crime committed.—2. Sympathetic sorrow; pity; compassion.

Curse on th' unpard'ning prince, whom tears can draw

To no remorse. *Dryden.*

[*This sense is nearly or quite obsolete.*]

REMORS'ED,† *a.* Feeling remorse or compunction.

REMORSEFUL, *a.* (remors'ful.) Full of remorse.—2.† Compassionate; feeling tenderly.—3.† Pitiable.

REMORSE'FULLY, *adv.* With remorse of conscience.

REMORSELESS, *a.* (remors'less.) Unpitiful; cruel; insensible to distress; as, the *remorseless* deep.

*Remorseless* adversaries. *South.*

REMORSELESSLY, *adv.* (remors'lessly.) Without remorse.

REMORSELESSNESS, *n.* (remors'lessness.) Savage cruelty; insensibility to distress.

REM'OTE, *a.* [*L. remotus*, *removeo*; *re* and *moveo*, to move.] 1. Distant in place; not near; as, a *remote* country; a *remote* people.

Give me a life *remote* from guilty courts. *Granville.*

2. Distant in time, past or future; as, *remote* antiquity. Every man is apt to think the time of his dissolution to be *remote*.—3. Distant; not immediate.

It is not all *remote* and even apparent good that affects us. *Locke.*

4. Distant; primary; not proximate; as, the *remote* causes of a disease.—5. Alien; foreign; not agreeing with; as, a proposition *remote* from reason.—6. Abstracted; as, the mind placed by thought amongst or *remote* from all bodies.—7. Distant in consanguinity or affinity; as, a *remote* kinsman.—8. Slight; inconsiderable; as, a *remote* analogy between cases; a *remote* resemblance in form or colour.

REM'OTELY, *adv.* At a distance in space or time; not nearly.—2. At a distance in consanguinity or affinity.—3. Slightly; in a small degree; as, to be *remotely* affected by an event.

REM'OTENESS, *n.* State of being distant in space or time; distance; as, the *remoteness* of a kingdom or of a star; the *remoteness* of the deluge from our age; the *remoteness* of a future event, of an evil, or of success.—2. Distance in consanguinity or affinity.—3. Distance in operation or efficiency; as, the *remoteness* of causes.—4. Slightness; smallness; as, *remoteness* of resemblance.

REM'OTION, *n.* The act of removing; the state of being removed to a distance. [*Little used.*]

REM'OULD, *v. t.* [*re* and *mould*.] To mould or shape anew.

REM'OULD'ED, *pp.* Moulded again. REM'OULD'ING, *ppr.* Moulding anew.

REM'OUNT', *v. t.* [*Fr. remonter*; *re* and *monter*.] To mount again; as, to *remount* a horse.

REM'OUNT', *v. i.* To mount again; to reascend.

REM'OVABILITY, *n.* The capacity of being removable from an office or station; capacity of being displaced.

REM'OVABLE, *a.* [from *remove*.] That may be removed from an office or station.

Such curate is *removable* at the pleasure of the rector of the mother church. *Ayliffe.*

2. That may be removed from one place to another.

REM'OV'AL, *n.* The act of moving from one place to another for residence; as, the *removal* of a family.—2. The act of displacing from an office or post.—3. The act of curing or putting away; as, the *removal* of a disease.—4. The state of being removed; change of place.—5. The act of putting an end to; as, the *removal* of a grievance.

REM'OVE, *v. t.* [*L. removeo*; *re* and *moveo*, to move; *Fr. remuer*.] 1. To set or place away from; to place at a distance; to cause to change place; to put from its place in any manner; as, to *remove* a building.

Thou shalt not *remove* thy neighbour's landmark; Deut. xix.

2. To displace from an office.—3. To take or put away in any manner; to cause to leave a person or thing; to banish or destroy; as, to *remove* a disease or complaint.

*Remove* sorrow from thine heart; Eccles. xi.

4. To carry from one court to another; as, to *remove* a cause or suit by appeal.

—5. To take from the present state of being; as, to *remove* one by death.

REM'OVE, *v. i.* To change place in any manner.—2. To go from one place to another.—3. To change the place of residence; as, to *remove* from Edinburgh to London.

*Note.*—The verb *remove*, in most of its applications, is synonymous with *move*, but not in all. Thus we do not apply *remove* to a mere change of posture, without a change of place or the seat of a thing. A man *moves* his head when he turns it, or his finger when he bends it, but he does not *remove* it. *Remove* usually or always denotes a change of place in a body, but we never apply it to a regular continued course or motion. We never say, the wind or water or a ship *removes* at a certain rate by the hour; but we say, a ship *was removed* from one place in a harbour to another. *Move* is a generic term, including the sense of *remove*, which is more generally applied to a change from one station or permanent position, stand, or seat, to another station.

REM'OVE, *n.* Change of place.—2. Translation of one to the place of another.—3. State of being removed.—4. Act of moving a man in chess or other game.—5. Departure; a going away.—6. The act of changing place; removal.—7. A step in any scale of gradation.

A freeholder is but one *remove* from a legislator. *Addison.*

8. Any indefinite distance; as, a small or great *remove*.—9. The act of putting a horse's shoes on different feet.—10. A dish to be changed while the rest of the course remains.—11. † Susceptibility of being removed.

REMOVED, *pp.* Changed in place; carried to a distance; displaced from office; placed far off.—2. *a.* Remote; separate from others.—*Removed*, in *her.*, implies that the ordinary has fallen, or is put out of its proper place; as, a chief *removed* or lowered.

REMOVEDNESS, † *n.* State of being removed; remoteness.

REMOVER, *n.* One that removes; as, a *remover* of landmarks.—2. In *law*, *remover* is where a suit is removed or taken out of one court into another.

REMOVING, *ppr.* Changing place; carrying or going from one place to another; displacing; banishing.

REMPLI, *pp.* [Fr. filled up.] In *her.*, a term used when a chief is filled with any other metal or colour, leaving only a border round the chief of the first, which is then called a *chief rempli*.



Chief Rempli.

REMUGIANT, *a.* [L. *remugio*.] Rebellowing.

REMUNERABILITY, *n.* The capacity of being rewarded.

REMUNERABLE, *a.* [from *remunerate*.] That may be rewarded; fit or proper to be recompensed.

REMUNERATE, *v. t.* [L. *remunero*; *re* and *munero*, from *munus*, a gift.] To reward; to recompense; to requite; in a good sense; to pay an equivalent to for any service, loss, expense, or other sacrifice; as, to *remunerate* the troops of an army for their services and sufferings; to *remunerate* men for labour. The pious sufferer in this life will be *remunerated* in the life to come.

REMUNERATED, *pp.* Rewarded; compensated.

REMUNERATING, *ppr.* Rewarding; recompensing.

REMUNERATION, *n.* Reward; recompense; the act of paying an equivalent for services, loss, or sacrifices.—2. The equivalent given for services, loss, or sufferings.

REMUNERATIVE, *a.* Exercised in rewarding; that bestows rewards; as, *remunerative* justice.

REMUNERATORY, *a.* Affording recompense; rewarding.

REMURMUR, *v. t.* [L. *remurmuro*; *re* and *murmuro*.] To utter back in murmurs; to return in murmurs; to repeat in low hoarse sounds.

The trembling trees in every plain and wood,  
Her fate *remurmur* to the silver flood

Pope.

REMURMUR, *v. i.* To murmur back; to return or echo in low rumbling sounds.

The realms of Mars *remurmur'd* all around.

Dryden.

REMURMURED, *pp.* Uttered back in murmurs.

REMURMURING, *ppr.* Uttering back in low sounds.

RENAISSANCE, *n.* [Fr. regeneration or new birth.] The revival of any thing which has long been in decay, or extinct. The term is specially applied in France to the time of the revival of letters and arts, and still more parti-

cularly to the style of building and decoration which came into vogue in the early part of the sixteenth century.

RENAL, *a.* [L. *renalis*, from *renes*, the kidneys.] Pertaining to the kidneys or reins; as, the *renal* arteries.—*Renal glands*. There is a glandular body upon each kidney of a somewhat triangular shape, small in the adult, but in the fetus longer than the kidney; it is called the renal, or supra-renal gland or capsule; it has no excretory duct, and its use is unknown.

RENARD, *n.* [Fr.; G. *reinche*.] A fox; a name used in fables, but not in common discourse. It is also written *Reynard*.

RENASCENCY, *n.* The state of springing or being produced again.

RENASCENT, *a.* [L. *renascens*, *renascor*; *re* and *nascor*, to be born.] Springing or rising into being again; reproduced.

RENASCIBLE, *a.* That may be reproduced; that may spring again into being.

RENAVIGATE, *v. t.* [*re* and *navigate*.] To navigate again; as, to *renavigate* the Pacific Ocean.

RENAVIGATED, *pp.* Navigated again; sailed over anew.

RENAVIGATING, *ppr.* Navigating again.

RENCOUNTER, *n.* [Fr. *rencontre*; *re* and *encontre*; *en* and *contre*, against.] Literally, a meeting of two bodies; clash; collision. Hence,—1. A meeting in opposition or contest.

The jostling chiefs in rude *rencounter* join.

Glancville.

2. A casual combat; a sudden contest or fight without premeditation; as between individuals or small parties.—

3. A casual action; an engagement between armies or fleets.

The confederates should outnumber the enemy in all *rencounters* and engagements.

Addison.

4. Any combat, action, or engagement.—5. In *her.*, an epithet for a beast in blazoning, whose face stands right forward, as if it came to meet the spectator.

RENCOUNTER, *v. t.* To meet unexpectedly without enmity or hostility. [This use is found in some recent publications, but is not common.]—2. To attack hand to hand.

RENCOUNTER, *v. i.* To meet an enemy unexpectedly.—2. To clash; to come in collision.—3. To skirmish with another.—4. To fight hand to hand.

RENCOUNTERED, *pp.* Met unexpectedly; clashed. [See the Verbs.]

REND, *v. t. pret.* and *pp. rent*. [Sax. *rendan*, *hrendan*; Ir. *rannam*, *rannaim*; W. *rhanu*; Arm. *ranna*, to divide, and *crenna*, to abridge, whence Eng. *cranny*, L. *crena*. Qu. L. *cerno*, Gr. *κερα*.]

1. To separate any substance into parts with force or sudden violence; to tear asunder; to split; as, powder *rends* a rock in blasting; lightning *rends* an oak.

An empire from its old foundation *rent*.

Dryden.

I *rend* my tresses, and my breast I wound.

Pope.

Neither *rend* your clothes, lest ye die; Lev. x.

2. To separate or part with violence. I will surely *rend* the kingdom from thee; 1 Kings xi.

To *rend the heart*, in *Scripture*, to have bitter sorrow for sin; Joel ii.—To *rend the heavens*, to appear in majesty; Is.

lxiv. *Rend* differs somewhat from *lacerate*. We never say, to *lacerate* a rock or a kingdom, when we mean to express splitting or division. *Lacerate* is properly applicable to the tearing off of small pieces of a thing, as to *lacerate* the body with a whip or scourge; or to the tearing of the flesh or other thing without entire separation.

RENDER, *n.* A surrender; a giving up.—2. A return; a payment of rent.

In those early times, the king's household was supported by specific *renders* of corn and other victuals from the tenants of the demains.

Blackstone.

3. An account given. RENDER, *v. t.* [Fr. *rendre*; *it. rendere*. This is probably the L. *reddo*, with *n* casually inserted.] 1. To return; to pay back.

See that none *render* evil for evil to any man; 1 Thess. v.

2. To inflict, as a retribution. I will *render* vengeance to my enemies; Deut. xxxii.

3. To give on demand; to give; to assign.

The sluggard is wiser in his own conceit, than seven men that can *render* a reason; Prov. xxvi.

4. To make or cause to be, by some influence upon a thing, or by some change; as, to *render* a person more safe or more unsafe; to *render* him solicitous or cautious; to *render* a fortress more secure or impregnable; to *render* a ferocious animal more mild and tractable.—5. To translate, as from one language into another; as, to *render* Latin into English. We say, to *render* a word, a sentence, a book, or an author into a different language.—

6. To surrender; to yield or give up the command or possession of; as, to *render* one's self to his enemies. [Less used than *surrender*.]—7. To afford; to give for use or benefit. Wellington *rendered* great service to his country.—8. To invest with qualities; to represent; to exhibit.

He did *render* him the most unnatural That liv'd amongst men.† Shak.

9. In *law*, a term used in levying a fine. A fine is either *single*, whereby nothing is granted or *rendered* back again by the cognizee to the cognizor; or *double*, which contains a grant or *render* back again of some real common or other thing out of the land itself to the cognizor.—10. In *arch.*, to plaster on walls, slates, or tiles directly, and without the intervention of laths.—11. To boil down and clarify; as, to *render* tallow.

—To *render* back, to return; to restore.

RENDER, *v. i.* In *marine lan.*, to yield or give way to the action of some mechanical power; a term applied to the tackle of a ship in distinction from sticking or jamming.

RENDER, *n.* [from *rend*.] One that tears by violence.

RENDERABLE, *a.* That may be rendered.

RENDERED, *pp.* Returned; paid back; given; assigned; made; translated; surrendered; afforded; boiled down and clarified; as, *rendered* tallow.—

2. In *arch.*, *rendered* and *set* is a term applied to two coats of plaster on walls.—*Rendered*, *floated*, and *set* is applied to three coats of plaster on walls.

RENDERER, *n.* One who renders.

RENDERING, *ppr.* Returning; giving back; assigning; making; translating; surrendering; affording.

REN'DERING, *n.* Version; translation.—2. In *arch.*, the act of laying the first coat of plaster on brickwork.

REN'DEZVÓUS, *n.* (rén'deyvoo.) [Fr. *rendez-vous*, render yourselves, repair to a place. This word is anglicized, and may well be pronounced as an English word.] 1. A place appointed for the assembling of troops, or the place where they assemble; or the port or place where ships are ordered to join company.—2. A place of meeting, or a sign that draws men together. [Rarely used.]—3. An assembly; a meeting. [Rarely used.]

REN'DEZVÓUS, *v. i.* To assemble at a particular place, as troops.

The place where the Gauls and Bruti had rendezvoused. *Alfred's Orosius, Trans.*

*B. Trumbull, Hook, Rom. Hist.*

REN'DEZVÓUS, *v. t.* To assemble or bring together at a certain place.

REN'DEZVÓUSED, *pp.* Assembled or brought together at a particular place.

REN'DEZVÓUSING, *ppr.* Assembling at a particular place.

REN'DIBLE, *a.* That may be yielded or surrendered.—2. That may be translated. [Little used in either sense.]

REN'DITION, *n.* [from *render*.] The act of yielding possession; surrender.—2. Translation.

REN'EGADE, } *n.* [Sp. and Port. *rene-*  
REN'EGADO, } *gado*, from *renegar*, to deny; *L. re* and *nego*, to deny; Fr. *renégat*; primarily an apostate.] 1. An apostate from the faith.—2. One who deserts to an enemy; a deserter.—3. A vagabond.

There lived a French *renegado* in the same place. *Addison.*

REN'EGE, † *v. t.* [*L. renego*.] To deny; to disown.

REN'EGE, † *v. i.* To deny.

REN'ERVE, *v. t.* (*renerv'*.) [*re* and *nerve*.] To nerve again; to give new vigour to.

REN'ERV'ED, *pp.* Nerved anew.

REN'ERV'ING, *ppr.* Giving new vigour to.

REN'EW', *v. t.* [*L. renovo*; *re* and *novo*, or *re* and *nov*.] 1. To renovate; to restore to a former state, or to a good state, after decay or depravation; to rebuild; to repair.

Asa renewed the altar of the Lord; 2 Chron. xv.

2. To re-establish; to confirm.

Let us go to Gilgal and *renew* the kingdom there; 1 Sam. xi.

3. To make again; as, to *renew* a treaty or covenant.—4. To repeat; as, to *renew* expressions of friendship; to *renew* a promise; to *renew* an attempt.—5. To revive; as, to *renew* the glories of an ancestor or of a former age.—6. To begin again.

The last great age *renews* its finish'd course. *Dryden.*

7. To make new; to make fresh or vigorous; as, to *renew* youth; to *renew* strength; to *renew* the face of the earth: Ps. ciii.; Is. xl.; Ps. civ.—8. To grant a new lean on a new note for the amount of a former one.—9. In *theol.*, to make new; to renovate; to transform; to change from natural enmity to the love of God and his law; to implant holy affections in the heart; to regenerate.

Be ye transformed by the *renewing* of your mind; Rom. xii.; Eph. iv.

REN'EW'ABLE, *a.* That may be renewed; as, a lease *renewable* at pleasure.

REN'EW'AL, *n.* The act of renewing;

the act of forming anew; as, the *renewal* of a treaty.—2. Renovation; regeneration.—3. Revival; restoration to a former or to a good state.—4. Reloan on a new note given.

REN'EW'ED, *pp.* Made new again; repaired; re-established; repeated; revived; renovated; regenerated.

REN'EW'EDLY, *adv.* Again; once more. [Not authorised.]

REN'EW'EDNESS, *n.* State of being renewed.

REN'EW'ER, *n.* One who renews.

REN'EW'ING, *ppr.* Making new again; repairing; re-establishing; repeating; reviving; renovating.

REN'EW'ING, *a.* That renews or regenerates; as, *renewing* grace. Tending or adapted to renovate.

REN'EW'ING, *n.* The act of making new; renewal.

REN'IFORM, *a.* [*L. renes*, the kidneys, and *form*.] Having the form or shape of the kidneys; as, a *reniform* leaf. [See KIDNEY-SHAPED.]

REN'TENCE, } *n.* [*L. renitens*, *renitor*,  
REN'TENCY, } to resist; *re* and *nitro*, to struggle or strive.] 1. The resistance of a body to pressure; the effort of matter to resume the place or form from which it has been driven by the impulse of other matter; the effect of elasticity.—2. Moral resistance; reluctance.

We find a *renitency* in ourselves to ascribe life and irritability to the cold and motionless fibres of plants. *Darwin*

REN'TENT, *a.* Resisting pressure or the effect of it; acting against impulse by elastic force.

REN'NET, or RUN'NET, *n.* [*G. rinnen*, to run, to curdle; *D. rinnen*, *ronnen*, to curdle or coagulate; Sax. *gerunnen*, coagulated.] The prepared inner membrane of the calf's stomach, which has the property of coagulating the albumen of milk and converting it into curd and whey.

REN'NET, } *n.* [Fr. *reinette*, little  
REN'NETING, } *queen*.] A kind of apple.

RENOUNCE, *v. t.* (*renouns'*.) [Fr. *renoncer*; *L. renuncio*; *re* and *nuncio*, to declare, from the root of *nomen*, name.]

1. To disown; to disclaim; to abjure; to quit on oath; to reject; as a title or claim; to refuse to own or acknowledge as belonging to; as, to *renounce* a title to land or a claim to reward; to *renounce* all pretensions to applause.—2. To deny; to cast off; to reject; to disclaim; as an obligation or duty; as, to *renounce* allegiance.—3. To cast off or reject, as a connection or possession; to forsake; as, to *renounce* the world and all its cares.

We have *renounced* the hidden things of dishonesty, 2 Cor. iv.

RENOUNCE, † *v. i.* (*renouns'*.) To declare a renunciation.

He of my sons who fails to make it good, By one rebellious act *renounces* to my blood. *Dryden.*

2. In cards, not to follow suit, when the person has a card of the same sort.

RENOUNCE, *n.* (*renouns'*.) The declining to follow suit when it can be done.

RENOUN'CED, *pp.* Disowned; denied; rejected; disclaimed.

RENOUNCEMENT, *n.* (*renouns'ment*.) The act of disclaiming or rejecting; renunciation.

RENOUN'CE, *n.* One who disowns or disclaims.

RENOUN'CE, *ppr.* Disowning; disclaiming; rejecting.

RENOUN'CE, *n.* The act of disowning, disclaiming, denying, or rejecting.

REN'OVATE, *v. t.* [*L. renovo*; *re* and *novo*, to make new; *novus*, new.] To renew; to restore to the first state, or to a good state, after decay, destruction, or depravation. It is synonymous with *renew*, except in its fourth definition.

REN'OVATED, *ppr.* Renewed; made new, fresh, or vigorous.

REN'OVATING, *ppr.* Renewing.

REN'OVATION, *n.* [Fr. from *L. renovatio*.] 1. The act of renewing; a making new after decay, destruction or depravation; renewal; as, the *renovation* of the heart by grace.

There is something inexpressibly pleasing in the annual *renovation* of the world. *Rambler.*

2. A state of being renewed.

REN'OVATOR, *n.* One who, or that which renews.

RENOWN', *n.* [Fr. *renommée*; *re* and *nommer*, to name.] Fame; celebrity; exalted reputation derived from the extensive praise of great achievements or accomplishments.

Giants of old, men of *renown*; Gen. vi.; Num. xvi.

RENOWN', *v. t.* To make famous.

Soft elocution does thy style *renown*.

*Dryden.*

A bard whom pilfer'd pastorals *renown*.

*Pope.*

[This verb is nearly or quite obsolete.]

RENOWN'ED, *a.* Famous; celebrated for great and heroic achievements, for distinguished qualities or for grandeur; eminent; as, *renowned* men; a *renowned* king; a *renowned* city.

RENOWN'EDLY, *adv.* With fame or celebrity.

RENOWN'LESS, *a.* Without renown; inglorious.

RENT, *pp.* of *Rend*. Torn asunder; split or burst by violence; torn.

RENT, *n.* [from *rend*.] A fissure; a break or breach made by force; as, a *rent* made in the earth, in a rock, or in a garment.—2. A schism; a separation; as, a *rent* in the church.

RENT, *v. t.* To tear. [See *REND*.]

RENT, † *v. i.* To rant.

RENT, *n.* [Fr. *rente*, from *rendre*; *D. Dan*, and *G. rente*.] A sum of money, or a certain amount of other valuable thing, issuing yearly from lands or tenements.

Rent in law is defined "a certain profit issuing yearly out of lands and tenements corporeal," not necessarily, although by English usage generally, consisting in money. Rents, at common law, are of three kinds; *rent-service*, *rent-charge*, and *rent-seck*. *Rent-service* is when some corporal service is incident to it, as by fealty and a sum of money; *rent-charge* is when the owner of the rent has no future interest or reversion expectant in the land, but the rent is reserved in the deed by a clause of distress for rent in arrear; *rent-seck*, dry rent, is rent reserved by deed, but without any clause of distress. There are also *rents of assize*, certain established rents of free-holders and copy-holders of manors, which cannot be varied; called also *quit-rents*. These, when payable in silver, are called *white rents*, in contradistinction to rents reserved in work or the baser metals, called *black rents* or *black mail*. *Rack-rent* is a rent of the full value of the tenement, or near it. A *fee farm rent* is a rent-charge issuing out of an estate in fee, of at least one fourth of the value of

the lands at the time of its reservation. The time of paying rents is either by the particular appointment of the parties in the deed, or by appointment of law, but the law does not control the express appointment of the parties, when such appointment will answer their intention. In England, Michaelmas and Lady-day are the usual days appointed for payment of rents; and in Scotland, Martinmas and Whitsunday.

**RENT**, *v. t.* To lease; to grant the possession and enjoyment of lands or tenements for a consideration in the nature of rent. The owner of an estate or house *rents* it to a tenant for a term of years.—2. To take and hold by lease the possession of land or a tenement, for a consideration in the nature of rent. The tenant *rents* his estate for a year.

**RENT**, *v. i.* To be leased, or let for rent; as, an estate or a tenement *rents* for five hundred pounds a year.

**RENT'ABLE**, *a.* That may be rented.

**RENT'AGE**, *† n.* Rent.

**RENT'AL**, *n.* [corrupted from *rent-roll*.] A schedule or account of rents, or a roll wherein the rents of a manor or estate are set down. It contains the lands let to each tenant with their names, and the several rents arising from such lands.—*Rental right*, a species of lease at low rent, usually for life; the holders of such leases were called *rentallers*, or *hindly tenants*.

**RENT'CHARGE**, *n.* Charge upon an estate.

**RENT'ED**, *pp.* Leased on rent.

**RENT'ER**, *n.* One who leases an estate; more generally, the lessee or tenant who takes an estate or tenement on rent.

**RENT'ER**, *v. t.* [Fr. *rentrarie*; L. *retraho*, *retrahere*; *re* and *traho*, to draw.] —1. To fine-draw; to sew together the edges of two pieces of cloth without doubling them, so that the seam is scarcely visible.—2. In *tapestry*, to work new warp into a piece of damaged tapestry, and on this to restore the original pattern or design.—3. To sew up artfully, as a rent.

**RENT'ERED**, *pp.* Fine-drawn; sewed artfully together.

**RENT'ERER**, *n.* A fine-drawer.

**RENT'ERING**, *pp.* Fine-drawing; sewing artfully together.

**RENT'IER**, *n.* [Fr.] One who has a fixed income; as from lands, stocks, &c.

**RENT'ING**, *pp.* Leasing on rent; taking on rent.

**RENT-RÖLL**, *n.* [rent and roll.] A rental; a list or account of rents or income. [See **RENTAL**.]

**RENU'INA**, *n.* A genus of flat furrowed, reniform, many-chambered, microscopic foraminiferous shells, with linear chambers adapted to the curves of the shells, the last being the longest.

**RENU'MERATE**, *v. t.* [L. *renumero*.] To recount.

**RENU'MERATED**, *pp.* Recounted; numbered again.

**RENU'MERATING**, *pp.* Recounting.

**RENU'NCIATION**, *n.* [L. *renunciatio*.] The act of renouncing; a disowning; rejection. [See **RENOUCE**.] 2. In *Scots* law, the act of renouncing a right; as, the *renunciation* by an heir; the *renunciation* of redeemable rights; the *renunciation* of a lease.

**RENVERSE**, *† v. t.* [Fr. *renverser*.] To reverse.

**RENVERSE**, *a.* In *heraldry*, inverted; set with the head downward or contrary to the natural posture; as a *chev-*

*ron reverse*, that is, with the point downwards, or when a beast is laid on its back.

**RENVERSE'MENT**, *† n.* The act of reversing.

**REOBTAIN**, *v. t.* [re and *obtain*.] To obtain again.

**REOBTAINABLE**, *a.* That may be obtained again.

**REOBTAINED**, *pp.* Obtained again.

**REOBTAINING**, *pp.* Obtaining again.

**REO'PEN**, *v. t.* To open again.

**REO'PENED**, *pp.* Opened again.

**REO'PENING**, *pp.* Opening a second time.

**REOPPOSE**, *v. t.* (s as z.) To oppose again.

**REORDAIN**, *v. t.* [re and *ordain*; Fr. *reordonner*.] To ordain again, as when the first ordination is defective.

**REORDAINED**, *pp.* Ordained again.

**REORDAINING**, *pp.* Ordaining again.

**REOR'DER**, *v. t.* To order a second time.

**REORDINA'TION**, *n.* A second ordination.

**REORGANIZA'TION**, *n.* The act of organizing anew; as, repeated *reorganization* of the troops.

**REOR'GANIZE**, *v. t.* [re and *organize*.] To organize anew; to reduce again to a regular body, or to a system; as, to *reorganize* a society or an army.

**REOR'GANIZED**, *pp.* Organized anew.

**REOR'GANIZING**, *pp.* Organizing anew.

**REPAC'IFIED**, *pp.* Pacified, or appeased again.

**REPAC'IFY**, *v. t.* [re and *pacify*.] To pacify again.

**REPAC'IFYING**, *pp.* Pacifying again.

**REPACK**, *v. t.* [re and *pack*.] To pack a second time; as, to *repack* beef or pork.

**REPACK'ED**, *pp.* Packed again.

**REPACK'ER**, *n.* One that repacks.

**REPACK'ING**, *pp.* Packing anew.

**REPAID**, *pp.* of *Repay*. Paid back.

**REPAIR**, *v. t.* [Fr. *reparer*; L. *reparo*; *re* and *paro*, to prepare. See **PARÉ**.] 1. To restore to a sound or good state after decay, injury, dilapidation, or partial destruction; as, to *repair* a house, a wall or a ship; to *repair* roads and bridges. Temperance and diet may *repair* a broken or enfeebled constitution. Food *repairs* the daily waste of the body.—2. To rebuild a part decayed or destroyed; to fill up; as, to *repair* a breach.—3. To make amends, as for an injury, by an equivalent; to indemnify for; as, to *repair* a loss or damage.

**REPAIR**, *n.* Restoration to a sound or good state after decay, waste, injury, or partial destruction; supply of loss; reparation; as, materials are collected for the *repair* of a church or a city.

**REPAIR**, *v. i.* [Fr. *reparer*.] To go to; to betake one's self; to resort; as, to *repair* to a sanatorium for safety. Go, mount the winds, and to the shades *repair*.

**REPAIR**, *n.* The act of betaking one's self to any place; a resorting; abode; haunt; resort.

**REPAIRABLE**, *a.* That may be repaired; repairable.

**REPAIRED**, *pp.* Restored to a good or sound state; rebuilt; made good.

**REPAIRER**, *n.* One who repairs, restores, or makes amends; as, the *repairer* of decay.

**REPAIRING**, *pp.* Restoring to a sound state; rebuilding; making amends for loss or injury.

**REPAIRMENT**, *n.* Act of repairing.



Repand leaf.

**REPAND**, *a.* [L. *repandus*.] In *bot.*, a leaf having a margin undulated and unequally dilated; as in *Inula dysenterica*.

**REPAN'DO-DENTA-TE**, *a.* In *bot.*, repand and toothed.

**REPAN'DOUS**, *a.* [supra.] Bent upward; convexly crooked.

**REPAR'ABLE**, *a.* [Fr. from L. *reparabilis*. See **REPAIR**.] 1. That may be repaired or restored to a sound or good state: as, a house or wall is not *reparable*.—2. That may be retrieved or made good; as, the loss is *reparable*.—3. That may be supplied by an equivalent; as, a *reparable* injury.

**REPAR'ABLY**, *adv.* In a manner admitting of restoration to a good state, or of amends, supply, or indemnification.

**REPARA'TION**, *n.* The act of repairing; restoration to soundness or a good state; as, the *reparation* of a bridge or of a highway.—2. Supply of what is wasted; as, the *reparation* of decaying health or strength after disease or exhaustion.—3. Amends; indemnification for loss or damage. A loss may be too great for *reparation*.—4. Amends; satisfaction for injury.

I am sensible of the scandal I have given by my loose writings, and make what *reparation* I am able. *Dryden*.

**REPAR'ATIVE**, *a.* That repairs; restoring to a sound or good state; that amends defect or makes good.

**REPAR'ATIVE**, *n.* That which restores to a good state; that which makes amends.

**REPARTEE**, *n.* [Fr. *repartie*, from *repartir*, to divide, to share, to reply; *re* and *partir*, to divide.] 1. Originally an answering thrust in fencing. Hence, —2. A smart, ready, and witty reply. Cupid was as bad as he; Hear but the youngest's *repartee*.

*Prior*.

**REPARTEE'**, *v. t.* To make smart and witty replies.

**REPARTIMENT'O**, *n.* [Sp.] A partition or division; also, an assessment of taxes.

**REPASS**, *v. t.* [Fr. *repasser*; It. *ripasare*; *re* and *pass*.] To pass again; to pass or travel back; as, to *repass* a bridge or a river; to *repass* the sea.

**REPASS**, *v. i.* To pass or go back; to move back; as, troops passing and *repassing* before our eyes.

**REPASS'ANT**, *pp.* [Re and Fr. *passant*, passing by.] In *her.*, a term applied when two lions or other animals are borne going contrary ways, one of which is *passant*, by walking towards the dexter side of the shield in the usual way, and the other *repassant* by going towards the sinister.

**REPASSED**, *pp.* Passed or travelled back.

**REPASSING**, *pp.* Passing back.

**REPAST**, *n.* [Fr. *repas*, from *repaitre*; L. *re* and *pasco*, to feed.] 1. The act of taking food; or the food taken; a meal. From dance to sweet *repast* they turn.

A *repast* without luxury. *Milton*.  
2. Food; victuals. *Johnson*.  
Go, and get me some *repast*. *Shak*.

**REPAST**, *v. t.* To feed; to feast.

**REPASTURE**, *† n.* Food; entertainment.



**REPATRIATE**, *v. t.* [L. *re* and *patria*, country.] To restore to one's own country.

**REPATRIATED**, *pp.* Restored to one's own country.

**REPATRIATING**, *ppr.* Restoring to one's own country.

**REPAY**, *v. t.* [Fr. *repayer*; *re* and *pay*.] 1. To pay back; to refund; as, to *repay* money borrowed or advanced.—2. To make return or requital; in a good or bad sense; as, to *repay* kindness; to *repay* an injury.

Vengeance is mine; I will *repay*, saith the Lord, Rom. xii. 19.

Benefits which cannot be *repaid*, are not commonly found to increase affection.

*Rambler.*

3. To recompense, as for a loss.—4. To compensate; as, false honour *repaid* in contempt.

**REPAYABLE**, *a.* That is to be repaid or refunded; as, money lent, *repayable* at the end of sixty days.

**REPAYING**, *ppr.* Paying back; compensating; requiring.

**REPAYMENT**, *n.* The act of paying back; reimbursement.—2. The money or other thing repaid.

**REPEAL**, *v. t.* [Fr. *rappeler*, to recall; *re* and *appeler*, L. *appello*; *ad* and *pello*.] 1. To recall. [*Obsolete as it respects persons.*]—2. To recall, as a deed, will, law or statute; to revoke; to abrogate by an authoritative act, or by the same power that made or enacted; as, the legislature may *repeal* at one session a law enacted at a preceding one.

**REPEAL**, *† n.* Recall from exile.—2. Revocation; abrogation; as, the *repeal* of a statute.

**REPEALABILITY**, } *n.* The quality  
**REPEALABLENESS**, } or state of being  
repealable.

**REPEALABLE**, *a.* Capable of being repealed; revocable by the same power that enacted. It is held as a sound principle, that charters or grants which vest rights in individuals or corporations, are not *repealable* without the consent of the grantees, unless a clause reserving the right is inserted in the act.

**REPEALED**, *pp.* Revoked; abrogated.

**REPEALER**, *n.* One that repeals; one who desires repeal. In *Ireland*, in recent times, the name given to one who agitates for a *repeal* of the Union between that kingdom and Great Britain.

**REPEALING**, *ppr.* Revoking; abrogating.

**REPÊAT**, *v. t.* [Fr. *repeter*; L. *repeto*; *re* and *peto*, to make at or drive toward.] 1. To do, make, attempt, or utter again; to iterate; as, to *repêat* an action; to *repêat* an attempt or exertion; to *repêat* a word or discourse; to *repêat* a song; to *repêat* an argument.—2. To try again.

1 the danger will *repêat*.

*Dryden.*

3. To recite; to rehearse.

He *repêated* some lines of Virgil. *Waller.*

4. To seek redress.—5. *†* To seek again. To *repêat* signals, in the navy, is to make the same signal which the admiral or commander has made, or to make a signal again.

**REPEAT**, *n.* In *music* a character *♩* denoting the repetition of the part which it bounds. It is sometimes expressed by dots against the bar, and sometimes by the words *Da Capo*.—2. Repetition.

**REPEATED**, *pp.* Done, attempted or spoken again; recited.

**REPEATEDLY**, *adv.* More than once;

again and again, indefinitely. He has been *repeatedly* warned of his danger.

**REPEATER**, *n.* One that repeats; one that recites or rehearses.—2. A watch that strikes the hours at will by the compression of a spring.—3. In *arithmetic*, an interminate decimal in which the same figure continually recurs. If this repetition goes on from the beginning, the decimal is called a *pure repeater*; as, .3333, &c.; but if any other figure or figures intervene between the decimal point and the repeating figure, the decimal is called a *mixed repeater*; as, .08333, &c. It is usual to indicate pure and mixed repeaters by placing a dot over the repeating figure; thus the above examples are written, . $\dot{3}$ , and .0 $\dot{8}$ 3. A repeater is also called a *simple repetend*. [See **REPETEND**.]

**REPEATING**, *ppr.* Doing or uttering again.—2. *a.* That strikes the number of hours; as, a *repeating* watch. *Repeating circle*, an astronomical and geodetical circular instrument invented by Borda, for determining with great accuracy the angular distance of two objects, by taking repeated measurements of it on the limb of a graduated circle. This method of observing is now extensively employed, especially in geodetical operations. It consists in moving the telescope successively over portions of a graduated limb corresponding to the angle to be measured, and reading only the multiple arc, and may be advantageously applied to circular instruments destined for very different purposes; as, for example, to an instrument for the measurement of the zenith distances of stars or terrestrial objects, or the distance of two trigonometrical stations, in which case it is simply called a *repeating circle*; to a reflecting circle used for observations at sea, when it becomes a *repeating reflecting circle*; or to a theodolite, when it becomes a *repeating theodolite*.—*Repeating ship*, or *Repeater*, a vessel (usually a frigate) appointed to attend each admiral in a fleet, and to repeat every signal he makes, with which she immediately sails to the ship for which it is intended, or the whole length of the fleet when the signal is general.—*Repeating a summons*, in *Scots law*, an expression applied to the case where it is necessary to support a defence by a counter action, at the instance of the defender against the pursuer. In such cases a signeted counter summons is produced, and an interlocator pronounced holding it as repeated.

**REPEDATION**, *† n.* [Low L. *repedo*; *re* and *pes*, the foot.] A stepping or going back.

**REPÊL**, *v. t.* [L. *repello*; *re* and *pello*, to drive.]—1. To drive back; to force to return; to check advance; as, to *repel* an enemy or an assailant.

Hippomedon *repel*'d the hostile tide. *Pope.*  
And virtue may *repel*, though not invade.

*Dryden.*

2. To resist; to oppose; as, to *repel* an argument.

**REPEL**, *v. i.* To act with force in opposition to force impressed. Electricity sometimes attracts and sometimes *repels*.—2. In *med.*, to check an afflux to a part of the body.

**REPELLED**, *pp.* Driven back; resisted.

**REPELLENCY**, *n.* The principle of repulsion; the quality of a substance

which expands or separates particles and enlarges the volume; as, the *repellency* of heat.—2. The quality that repels, drives back or resists approach; as, the *repellency* of the electric fluid.—3. Repulsive quality.

**REPEL'ENT**, *a.* Driving back; able or tending to repel.

**REPEL'ENT**, *n.* In *med.*, a medicine which drives back morbid humours into the mass of the blood, from which they were unduly secreted; or which prevents such an afflux of fluid to a part, as would raise it to a tumour; a discentient.

**REPEL'ER**, *n.* He or that which repels.

**REPEL'ING**, *ppr.* Driving back; resisting advance or approach effectually.—*Repelling power*, in physics, a power or property residing in, and exerted by, the minute particles of bodies by which they mutually recede from each other. *Heat* or *Caloric* is a *repelling* power. [See **REPULSION**.]

**REPENT**, *a.* [L. *repto*, to creep.] Creeping; as, a *repent* root. In *zool.*, the term is used in the same sense as creeping, and is applied to those animals which move with the body close to the ground, either without the aid of legs, or by means of more than four pairs of short legs.

**REPENT**, *v. i.* [Fr. *repentir*; L. *re* and *peniteo*, from *pæna*, pain, Gr. *πένις*. [See **PAIN**.]—1. To feel pain, sorrow, or regret for something done or spoken; or for something left undone, as, to *repent* that we have lost much time in idleness or sensual pleasure; to *repent* that we have injured or wounded the feelings of a friend. A person *repents* only of what he himself has done or said, or left undone.—2. To express sorrow for something past.

Enobarbus did before thy face *repent*.

*Shak.*

3. To change the mind in consequence of the inconvenience or injury done by past conduct.

Last peradventure the people *repent* when they see war, and they return; *Exod.* xiii. 4. Applied to the *Supreme Being*, it is taken figuratively, and signifies to change the course of providential dealings; *Gen.* vi; *P's.* cvi.—5. In *theol.*, to sorrow or be pained for sin, as a violation of God's holy law, a dishonour to his character and government, and the foulest ingratitude to a Being of infinite benevolence.

Except ye *repent*, ye shall all likewise perish; *Luke* xiii; *Acts* iii.

**REPENT**, *v. t.* To remember with sorrow; as, to *repent* rash words; to *repent* an injury done to a neighbour; to *repent* follies and vices. [See **REPENTANCE**.]—2. With the reciprocal pronoun. [Fr. *se repentir*.]

No man *repented* him of his wickedness; *Jer.* viii.

**REPENT'ANCE**, *n.* [Fr.] Sorrow for any thing done or said; the pain or grief which a person experiences in consequence of the injury or inconvenience produced by his own conduct. "Repentance is the relinquishment of any practice, from the conviction that it has offended God. Sorrow, fear and anxiety are properly not parts, but adjuncts of repentance; yet they are too closely connected with it to be easily separated." *Rambler.*

2. In *theol.*, the pain, regret, or affliction which a person feels on account of his past conduct, because it exposes

him to punishment. This sorrow proceeding merely from the fear of punishment, is called *legal repentance*, as being excited by the terrors of legal penalties, and it may exist without an amendment of life.—3. Real penitence; sorrow or deep contrition for sin, as an offence and dishonour to God, a violation of his holy law, and the basest ingratitude toward a Being of infinite benevolence. This is called *evangelical repentance*, and is accompanied and followed by amendment of life.

*Repentance* is a change of mind, or a conversion from sin to God. *Hammond.*

Godly sorrow worketh *repentance* to salvation; 2 Cor. vii; Matth. iii.

**REPENT'ANT**, *a.* [Fr.] Sorrowful for past conduct or words.—2. Sorrowful for sin.—3. Expressing or showing sorrow for sin; as, *repentant tears*; *repentant ashes*; *repentant sighs*.

**REPENT'ANT**, *n.* One who repents; a penitent.—2. One that expresses sorrow for sin.

**REPENT'ANTLY**, *adv.* In a repentant manner.

**REPENT'ED**, *pp.* Remembered with sorrow.

**REPENT'ER**, *n.* One that repents.

**REPENT'ING**, *ppr.* Grieving for what is past; feeling pain or contrition for sin.

**REPENT'ING**, *n.* Act of repenting; Hos. xi.

**REPENT'INGLY**, *adv.* With repentance.

**REPÉOPLE**, *v. t.* [re and *people*; Fr. *repeupler*.] To people anew; to furnish again with a stock of people. The world after the flood was *repeopled* by the descendants of one family.

**REPÉOPLED**, *pp.* Stocked anew with inhabitants.

**REPÉOPLING**, *ppr.* Furnishing again with a stock of inhabitants.

**REPÉOPLING**, *n.* [supra.] The act of furnishing again with inhabitants.

**REPERCUSS'**, *v. t.* [L. *repercussio*; re and *percussio*; per and *quatio*, to shake, to beat.] To beat back.

**REPERCUSS'ED**, *pp.* Beaten back.

**REPERCUSS'ION**, *n.* [L. *repercussio*.]

1. The act of driving back; reverberation; as, the *repercussion* of sound.  
2. In *music*, frequent repetition of the same sound.

**REPERCUSS'IVE**, *a.* Driving back; having the power of sending back; causing to reverberate; as, *repercussive rocks*.—2. † Repellent; as, a *repercussive medicine*.—3. Driven back; reverberated.

**REPERCUSS'IVE**, † *n.* A repellent.

**REPERTY'VIOUS**, † *a.* [from L. *reperitus*, *reperio*.] Found; gained by finding.

**REP'ERTORY**, *n.* [Fr. *repertoire*; L. *repertorium*, from *reperio*, to find again; re and *aperio*, to uncover.]

1. A place in which things are disposed in an orderly manner, so that they can be easily found, as the index of a book, a common-place book, &c.—2. A treasury; a magazine.

**REPETEND'**, *n.* [L. *repetendus*, *repeto*.]

In *arithmetic*, that part of a repeating decimal which recurs continually, *ad infinitum*. It is called a *simple repetend*, when only one figure recurs, as 3 3 3 3, &c., and a *compound repetend*, when there are more figures than one in the repeating period, as .029029, &c. It is usual to mark the first and last figures of the period by dots placed over them; thus the repetends above mentioned are written .3 and .029. [See **REPEATER**.]

**REPETITION**, *n.* [L. *repetitio*, see **REPEAT**.]—1. The act of doing or uttering a second time; iteration of the same act, or of the same words or sounds.—2. The act of reciting or rehearsing; the act of reading over.—3. Recital.—4. Recital from memory, as distinct from *reading*.—5. In *music*, the art of repeating, singing or playing the same part a second time.—6. In *rhet.*, reiteration, or a repeating the same word, or the same sense in different words, for the purpose of making a deeper impression on the audience.—7. In *Scots law*, repayment of money erroneously paid.

**REPETITION'AL**, } *a.* Contain-  
**REPETITION'ARY**, } ing repeti-  
[Little used.]

**REPETITION'OUS**, *a.* Repeating, containing repetition. [American.]

**REPINE**, *v. i.* [re and *pine*.] To fret one's self; to be discontented; to feel inward discontent which preys on the spirits; with at or against. It is our duty never to *repine* at the allotments of Providence.—2. To complain discontentedly; to murmur.

Multitudes *repine* at the want of that which nothing but idleness hinders them from enjoying. *Rambler*.

3. To envy.

**REPINER**, *n.* One that repines or murmurs.

**REPINING**, *ppr.* Fretting one's self; feeling discontent that preys on the spirits; complaining; murmuring.—2. *a.* Disposed to murmur or complain; as, a *repining temper*.

**REPINING**, *n.* The act of fretting or feeling discontent or of murmuring.

**REPININGLY**, *adv.* With murmuring or complaint.

**REPLACE**, *v. t.* [Fr. *replacer*; re and *place*.]—1. To put again in the former place; as, to *replace* a book.

The earl... was *replaced* in his government. *Bacon*.

2. To put in a new place.—3. To repay; to refund; as, to *replace* a sum of money borrowed.—4. To put a competent substitute in the place of another displaced, or of something lost. The paper is lost, and cannot be *replaced*.

**REPLACED**, *pp.* Put again in a former place; supplied by a substitute. Thus in petrification, the animal or vegetable substance gradually wastes away, and is *replaced* by silex.—2. In *min.*, a term used when a crystal has one or more planes in the place of its edges or angles.

**REPLACEMENT**, *n.* The act of replacing.—2. In *min.*, the removal of an edge or angle by one or more planes.

**REPLACING**, *ppr.* Putting again in a former place; supplying the place of with a substitute.

**REPLACING**, *n.* Act of replacing; act of removing one person or thing, and supplying the place by another.

**REPLAIT**, *v. t.* [re and *plait*.] To plait or fold again; to fold one part over another again and again.

**REPLAITED**, *pp.* Folded again or often.

**REPLAITING**, *ppr.* Folding again or often.

**REPLANT'**, *v. t.* [Fr. *replanter*; re and *plant*.] To plant again.

**REPLANT'ABLE**, *a.* That may be planted again.

**REPLANT'ATION**, *n.* The act of planting again.

**REPLANT'ED**, *pp.* Planted anew.

**REPLANT'ING**, *ppr.* Planting again.

**REPLEAD**, *v. t. or i.* [re and *plead*.]

To plead again.

**REPLEADER**, *n.* In *law*, a second pleading or course of pleadings; or the power of pleading again.

Whenever a *repleader* is granted, the pleadings must begin *de novo*. *Blackstone*.

**REPLEADING**, *ppr.* Pleading again.

**REPLEDGER'ING**, *n.* In *Scots law*, a power formerly competent to certain private jurisdictions, to demand judicially the person of an offender accused before another tribunal, on the ground that the alleged offence had been committed within the repledger's jurisdiction.

**REPLEN'ISH**, *v. t.* [Norm. *replener*, to fill; It. *riempire*; L. *re* and *plenus*, full.]—1. To fill; to stock with numbers or abundance. The magazines are *replenished* with corn. The springs are *replenished* with water.

Multiply and *replenish* the earth; Gen. i. 2. † To finish; to complete.

**REPLEN'ISH**, *v. i.* To recover former fullness.

**REPLEN'ISHED**, *pp.* Filled; abundantly supplied.

**REPLEN'ISHING**, *ppr.* Filling; supplying with abundance.

**REPLETE**, *a.* [L. *repletus*; re and *pleo*, to fill.] Completely filled; full.

His words *replete* with guile. *Milton*.

**REPLETION**, *n.* [Fr. from L. *repletio*.]—1. The state of being completely filled; or superabundant fullness.—2. In *med.*, fullness of blood; plethora.

**REPLETIVE**, *a.* Filling; replenishing.

**REPLETIVELY**, *adv.* So as to be filled.

**REPLEV'ABLE**, *a.* [See **REPLEVY**.] In *law*, that may be replevied.

**REPLEV'ED**, *pp.* Taken by a writ of replevin.

**REPLEV'IN**, *n.* [See **REPLEVY**.] An action or remedy granted on a distress, by which a person whose cattle or goods are distrained, has them returned to his own possession upon giving security, to try the right of taking in a suit at law, and if that should be determined against him, to return the cattle or goods into the possession of the distrainer.—2. The writ by which a distress is replevied.

**REPLEV'IN**, *v. t.* To *replevy*, which see.

**REPLEV'ISABLE**, *a.* That may be replevied; but little used, being superseded by *repleviable*.

**REPLEV'Y**, *v. t.* [re and *pledge*, Norm. *plegg* or *plevy*, whence in *law* L. *replegiabilis*, and *replegiare*.]—1. To take back, by a writ for that purpose, cattle or goods that have been distrained, upon giving security to try the right of distraining in a suit at law, and if that should be determined against the plaintiff, to return the cattle or goods into the hands of the distrainer. In this case, the person whose goods are distrained becomes the plaintiff, and the person distraining, the defendant or avowant.—2. To bail.

**REPLEV'YING**, *ppr.* Retaking a distress. [See **REPLEVY**.]

**REPLIC'ATE**, *a.* In *bot.* folded; plaited, so as to form a groove or channel; as in the legumen of the *astragalus hypoglotis*.

**REPLIC'ATE**, *n.* In *music*, a repetition.

**REPLICATION**, *n.* [L. *replicatio*. See **REPLY**.]—1. An answer; a reply. Particularly.—2. In *law pleadings*, the third stage in the pleadings in an action, being the reply of the plaintiff to the defendant's plea.—3. † Return or reper-

eussion of sound.—4. In *logic*, the assuming or using the same term twice in the same proposition.

**REPLIED**, *pp.* Answered; returned for an answer.

**REPLIER**, *n.* One who answers; he that speaks or writes in return to something spoken or written.

**REPLY**, *v. i.* [Fr. *repliquer*; *L. replico*; *re* and *plico*, to fold, that is, to turn or send to: See **APPLY**, **EMPLOY**, and **PLY**.]—1. To answer; to make a return in words or writing, to something said or written by another.

O man, who art thou that *repliest* against God? Rom. ix.

2. In *law*, to answer a defendant's plea. The defendant pleads in bar to the plaintiff's declaration; the plaintiff *replies* to the defendant's plea in bar.

**REPLY**, *v. t.* To return for an answer. He knows not what to *reply*.

**REPLY**, *n.* [Fr. *replique*; *It. replica*.]—1. An answer; that which is said or written, in answer to what is said or written by another.—2. A book or pamphlet written in answer to another.

**REPLYING**, *ppr.* Answering either in words or writing.

**REPOLISH**, *v. t.* [Fr. *repolir*; *re* and *polish*.] To polish again.

**REPOLISHED**, *pp.* Polished again.

**REPOLISHING**, *ppr.* Polishing anew.

**REPONE**, *v. t.* [*L. repono*, to replace.] In *Scots law*, to replace; to restore to a situation formerly held.—2. To reply.

**REPORT**, *v. t.* [Fr. *rapporter*; *L. reporto*, to carry back; *re* and *porto*, to bear.]—1. To bear or bring back an answer, or to relate what has been discovered by a person sent to examine, explore, or investigate; as, a messenger *reports* to his employer what he has seen or ascertained. The committee *reported* the whole number of votes.  
2. To give an account of; to relate; to tell.

They *reported* his good deeds before me; Neh. vi; Acts iv.

3. To tell or relate from one to another; to circulate publicly, as a story; as in the common phrase, it is *reported*.

It is *reported* among the heathen, and Gashmu saith it, that thou and the Jews think to rebel; Neh. vi.

In this form of expression, *it* refers to the subsequent clause of the sentence; "that thou and the Jews think to rebel, is *reported*."—4. To give an official account or statement; as the chancellor of the Exchequer *reports* annually to Parliament the amount of revenue and expenditure.—5. To give an account or statement of cases and decisions in a court of law or chancery.—6. To give an account or statement of the proceedings, debates, &c., of a legislative body, a meeting, or a court, as the proceedings of the meeting were fully *reported*.—7. To return, as sound; to give back. *To be reported*, or usually, *to be reported of*, to be well or ill spoken of; to be mentioned with respect or reproach; Acts xvi; Rom. iii.

**REPORT**, *v. i.* To make a statement of facts. The committee will *report* at twelve o'clock.—2. To discharge the office of a reporter for the newspaper press.

**REPORT**, *n.* An account returned; a statement or relation of facts given in reply to inquiry, or by a person authorized to examine and make return to his employer.

From Thetis sent as spies to make report. Waller.

2. Rumour; common fame; story circulated. *Report*, though often originating in fact, soon becomes incorrect, and is seldom deserving of credit. When we have no evidence but popular *report*, it is prudent to suspend our opinions in regard to the facts.—3. Repute; public character; as, evil *report* and good *report*; 2 Cor. vi.

Cornelius was of good *report* among the Jews; Acts x.

4. Account; story; relation.

It was a true *report* that I heard in my own land of thy acts and of thy wisdom; 1 Kings x.

5. Sound; noise; as, the *report* of a pistol or cannon.—6. An account or statement of a judicial opinion or decision, or of a case argued and determined in a court of law, chancery, &c. The books containing such statements are also called *reports*. Reports of the proceedings of courts of justice contain a statement of the pleadings, the facts, the arguments of counsel, and the judgment of the court in each case reported. The object of them is to establish the law, and prevent conflicting decisions, by preserving and publishing the judgments of the court, and the grounds upon which it decided the question of law arising in the case. In *Scots law*, in judicial procedure the term is usually applied to the return made by a judge, or a judicial nominee, to whom a remit has been made.—7. An official statement of facts, verbal or written; particularly, a statement in writing of proceedings and facts exhibited by an officer to his superiors; as, the *reports* of a master in chancery to the court, of committees to a legislative body, and the like.—8. In *Commercial navigation*, a paper delivered by the masters of all ships arriving from parts beyond seas to the custom house, and attested upon oath, containing an account of the cargo on board, &c.

**REPORTED**, *pp.* Told, related or stated in answer to inquiry or direction; circulated in popular rumours; reputed; stated officially.

**REPORTER**, *n.* One that gives an account, verbal or written, official or unofficial.—2. One who attends public meetings, courts of law, the house of Parliament, &c., in order to draw up statements of the proceedings, speeches, and debates for the public prints.

**REPORTING**, *ppr.* Giving account; relating; presenting statements of facts or of adjudged cases in law. 2. Giving an account of proceedings, debates, speeches, decisions, &c., in parliament, public meetings, and law courts.

**REPORTING**, *n.* The act of giving account of anything, of relating, or of making statements of facts or of adjudged cases in law. *Newspaper reporting*, the name given to that system by which the parliamentary debates and proceedings, and the proceedings of public meetings, &c., are promulgated throughout the country. [See **NEWSPAPER**.]

**REPORTINGLY**, *adv.* By report or common fame.

**REPÖSAL**, *n.* (s as z.) [from *repose*.]

The act of reposing or resting.

**REPÖSANCE**, *n.* Reliance.

**REPÖSE**, *v. t.* (s as z.) [Fr. *reposer*;

*re* and *poser*, to put; *L. repono, repositi*.]  
1. To lay at rest.

.. After the toil of battle, to *repose*  
Your wearied virtue. Milton.

2. To lay; to rest, as the mind, in confidence or trust; as, to *repose* trust or confidence in a person's veracity.—3. To lay up; to deposit; to lodge; as, pebbles *reposed* in cliffs.—4. To place in confidence.

**REPÖSE**, *v. i.* To lie at rest; to sleep. Within a thicket I *reposed*. Chapman.

2. To rest in confidence; followed by *on*. I *repose* on the faith and honour of a friend.—3. To lie; to rest; as, trap *reposing* on sand.

**REPÖSE**, *n.* [Fr. *repos*.] 1. A lying at rest.—2. Sleep; rest; quiet.—3. Rest of mind; tranquillity; freedom from uneasiness.—4. Cause of rest.

After great lights must be great shadows, which we call *reposes*. Dryden.

5. In *poetry*, a rest; a pause.—6. In *painting*, harmony of colours, as when nothing glaring appears. In the *fine arts* generally, the absence of that agitation which is induced by the scattering and division of a subject into too many unconnected parts, in which case a work is said to want *repose*. The eye in viewing such a work is perplexed, from not knowing where to rest, or where to find the principal action or principal figure.

**REPÖSED**, *pp.* Laid at rest; placed in confidence.

**REPÖSEDNESS**, *n.* State of being at rest.

**REPÖSING**, *ppr.* Laying at rest; placing in confidence; lying at rest; sleeping.

**REPÖSIT**, *v. t.* [*L. repositus, repono*.] To lay up; to lodge, as for safety or preservation.

Others *reposit* their young in holes. Derham.

**REPÖSITED**, *pp.* Laid up; deposited for safety or preservation.

**REPÖSITING**, *ppr.* Laying up or lodging for safety or preservation.

**REPÖSITION**, *n.* 1. Act of laying up in safety.—2. The act of replacing; as, the *reposition* of a bone.

**REPÖSITORY**, *n.* [*L. repositorium, from repono*.] A place where things are or may be deposited for safety or preservation. A granary is a *repository* for corn, an arsenal for arms. The mind or memory is called the *repository* of ideas.

**REPÖSSESS**, *v. t.* [*re* and *possess*.] To possess again.

Nor shall my father *repossess* the land. Pope.

*To repossess one's self*, to obtain possession again.

**REPÖSSESS'ED**, *pp.* Possessed again.

**REPÖSSESS'ING**, *ppr.* Possessing again; obtaining possession again.

**REPÖSSESS'ION**, *n.* The act of possessing again; the state of possessing again; the thing repossessed.

**REPÖUR**, *v. t.* [*re* and *pour*.] To pour again.

**REPÖURED**, *pp.* Poured again.

**REPÖURING**, *ppr.* Pouring again.

**REPÖREHEND**, *v. t.* [*L. reprehendo*; *re* and *prehendo*, to seize; Fr. *reprandre*.] 1. To chide; to reprove. Pardon me for *reprehending* thee. Shak.

2. To blame; to censure. I nor advise nor *reprehend* the choice Phillips.

3. To detect (of fallacy. †)

This colour will be *reprehended* or encountered, by imputing to all excellencies in compositions a kind of poverty. Racine.

4. To accuse; to charge with a fault; with *of*; as, Aristippus being *reprehended* of luxury.

**REPREHEND'ED**, *pp.* Reproved; blamed.

**REPREHEND'ER**, *n.* One that reprehends; one that blames or reproves.

**REPREHEND'ING**, *ppr.* Reproving; blaming.

**REPREHENS'IBLE**, *a.* [Fr. from *L. reprehensus*.] Blamable; culpable; censurable; deserving reproof; *applied to persons or things*; as, a *reprehensible* person; *reprehensible* conduct.

**REPREHENS'IBLENESS**, *n.* Blamableness; culpableness.

**REPREHENS'IBLY**, *adv.* Culpably; in a manner to deserve censure or reproof.

**REPREHENS'ION**, *n.* [Fr. from *L. reprehensio*.] Reproof; censure; open blame. Faults not punishable may deserve *reprehension*.

**REPREHENS'IVE**, *a.* Containing reproof.

**REPREHENS'ORY**, *a.* Containing reproof.

**REPRESENT'**, *v. t.* (*s* as *z.*) [Fr. *repræsenter*; *L. repræsento*; *re* and *Low L. præsento*, from *præsens*, present.] 1. To show or exhibit by resemblance.

Before him burn  
Seven lamps, as in a zodiac, *representing*  
The heavenly fires. *Milton.*

2. To describe; to exhibit to the mind in words.

The managers of the bank at Genoa have been *represented* as a second kind of senate.

*Addion.*

3. To exhibit; to show by action; as, a tragedy well *represented*.—4. To personate; to show dramatically; to act the character or to fill the place of another in a play; as, to *represent* the character of King Richard.—5. To supply the place of; to act as a substitute for another. The parliament of Great Britain *represents* the nation. The congress of the United States *represents* the people or nation.—6. To show by modest arguments, reasoning, or statement of facts. The memorial *represents* the situation of the petitioner. *Represent* to your son the danger of an idle life or profligate company.—7. To stand in the place of, in the right of inheritance.

All the branches inherit the same share that their root, whom they *represent*, would have done.

*Blackstone.*

**REPRESENT'ABLE**, *a.* That may be represented.

**REPRESENT'ANCE**, *† n.* Representation; likeness.

**REPRESENT'ANT**, *† n.* A representative.

**REPRESENTA'TION**, *n.* The act of representing, describing, or showing.—2. That which exhibits by resemblance; image, likeness, picture, or statue; as, *representations* of natural scenery.—3. Any exhibition of the form or operations of a thing by something resembling it. A map is a *representation* of the world or a part of it. The terrestrial globe is a *representation* of the earth. An orrery is a *representation* of the planets and their revolutions.—4. Exhibitions, as of a play on the stage.—5. Exhibition of a character in theatrical performance.—6. Verbal description; statement of arguments or facts in narration, oratory, debate, petition, admonition, &c.; as, the *representation* of an historian, of a witness, or an advocate.—7. In *politics*, the part performed by a deputy chosen by a constituent body

to support its interests, and act in its name on a public occasion. Thus, a plenipotentiary represents the sovereign or the state which delegates him at a foreign court. But the most ordinary use of the word is to express the principal function of the delegate of a constituency in a legislative assembly, as the *representation* of county freeholders by knights, of communities by their chosen burgesses, in parliament. Every such representative is understood to support the interests of his constituents in so far as these are not in opposition to the general interests of the community, or nation.—8. Representatives, as a collective body.—9. Public exhibition.—10. The standing in the place of another, as an heir, or in the right of taking by inheritance. In *Scots law*, the term is usually applied to the obligation incurred by an heir, to pay the debts, and perform the obligations incumbent upon his predecessor.—11. In *painting* and the *other arts*, the transference to a plane of a solid mass, or the appearance of an object to the eye.

**REPRESENT'ATIVE**, *a.* [Fr. *repræsentatif*.] 1. Exhibiting a similitude.

They own the legal sacrifices, though *representative*, to be proper and real.

*Atterbury.*

2. Bearing the character or power of another acting as a substitute for others, performing the functions of others; as, a *representative* body.—3. Conducted by the agency of delegates who are chosen by the people, as a *representative* government.

**REPRESENT'ATIVE**, *n.* One that exhibits the likeness of another.

A statue of Rumour, whispering an idiot in the ear, who was the *representative* of credulity.

*Addion.*

2. In *legislative* or *other business*, an agent, deputy, or substitute, who supplies the place of another or others, being invested with his or their authority. An attorney is the *representative* of his client or employer. A member of the house of commons is the *representative* of his constituents and of the nation. In matters concerning his constituents only, he is supposed to be bound by their instructions, but in the enacting of laws for the nation, he is supposed not to be bound by their instructions, as he acts for the whole nation.—3. In *law*, one that stands in the place of another as heir, or in the right of succeeding to an estate of inheritance, or to a crown.—4. That by which any thing is exhibited or shown.

This doctrine supposes the perfections of God to be the *representatives* to us of whatever we perceive in the creatures.

*Locke.*

**REPRESENT'ATIVELY**, *adv.* In the character of another; by a representative.—2. By substitution; by delegation of power.

**REPRESENT'ATIVENESS**, *n.* The state or quality of being representative.

Dr. Burnet observes that every thought is attended with consciousness and *representativeness*.

*Spectator.*

**REPRESENT'ED**, *pp.* Shown; exhibited; personated; described; stated; having substitutes.

**REPRESENT'ER**, *n.* One who shows, exhibits, or describes.—2. A representative; one that acts by deputation. [*Little used.*]

**REPRESENT'ING**, *ppr.* Showing; ex-

hibiting; describing; acting in another's character; acting in the place of another.

**REPRESENT'MENT**, *n.* Representation; image; an idea proposed as exhibiting the likeness of something.

**REPRESS'**, *v. t.* [*L. repressus, represso*; *re* and *presso*, to press.] 1. To crush; to quell; to put down; to subdue; to suppress; as, to *repress* sedition or rebellion; to *repress* the first risings of discontent.—2. To check; to restrain.

Such kings

Favour the innocent, *repress* the bold.

*Waller.*

**REPRESS', † n.** The act of subduing.

**REPRESS'ED**, *pp.* Crushed; subdued.

**REPRESS'ER**, *n.* One that crushes or subdues.

**REPRESS'ING**, *ppr.* Crushing; subduing; checking.

**REPRESS'ION**, *n.* The act of subduing; as, the *repression* of tumults.—2. Check; restraint.

**REPRESS'IVE**, *a.* Having power to crush; tending to subdue or restrain.

**REPRESS'IVELY**, *adv.* So as to repress.

**REPRIÉVAL**, *† n.* Respite; reprieve.

**REPRIÉVE**, *v. t.* [Probably Fr. *reprandre, repris*. In Norm. *repriont* is rendered *reprieved deductions*, and *reprises*, deductions and duties yearly paid out of lands.] 1. To respite after sentence of death; to suspend or delay the execution of for a time; as, to *reprieve* a criminal for thirty days.

He *reprieves* the sinner from time to time.

*Rogers.*

2. To grant a respite to; to relieve for a time from any suffering.

Company, though it may *reprieve* a man from his melancholy, yet cannot secure a man from his conscience.

*South.*

**REPRIÉVE**, *n.* The temporary suspension of the execution of sentence of death on a criminal.—1. A reprieve may proceed from the mere pleasure of the crown expressed to the court, or from the discretion of the court itself. Every court which has power to award execution, has also power either before or after judgment to grant a reprieve. Reprieve at the will of the judge is arbitrary, and he has power to give it when he is dissatisfied with the verdict, in order to give time to apply to the crown for a pardon. Reprieve is also *ex necessitate legis*; as, a woman capitally convicted has a right to a reprieve during pregnancy.—2. Respite; interval of ease or relief.

All that I ask is but a short *reprieve*,  
Till I forget to love, and learn to grieve.

*Denham.*

**REPRIÉVED**, *pp.* Respited; allowed a longer time to live than the sentence of death permits.

**REPRIÉVING**, *ppr.* Respiting; suspending the execution of for a time.

**REPRIMAND**, *v. t.* [Fr. *reprimander*. If this word is from *L. reprimus*, it must be formed from the participle *reprimendus*.] 1. To reprove severely; to reprehend; to chide for a fault.

Germanicus was severely *reprimanded* by Tiberius, for travelling into Egypt without his permission.

*Arbutnot.*

2. To reprove publicly and officially, in execution of a sentence. The court ordered the officer to be *reprimanded*.

**REPRIMAND**, *n.* Severe reproof for a fault; reprehension, private or public.

**REPRIMAND'ED**, *pp.* Severely reprov-

**REPRIMAND'ING**, *ppr.* Reproving severely.

REPRINT, *v. t.* [*re and print.*] To print again; to re a second or any new edition.—2. To renew the impression of any thing.

The business of redemption is... to re-print God's image on the soul. *South.*

REPRINT, *n.* A second or a new edition of a book.

REPRINTED, *pp.* Printed anew; impressed again.

REPRINTING, *ppr.* Printing again; renewing an impression.

REPRISAL, *n.* (*s as z.*) [*Fr. représailles; It. ripresaglia; Sp. represalia; Fr. reprendre, repris, to retake; re and prendre, L. prendo.*] 1. The seizure or taking of any thing from an enemy by way of retaliation or indemnification for something taken or detained by him.—2. That which is taken from an enemy to indemnify an owner for something of his which the enemy has seized. Reprisals may consist of persons or of goods. Letters of marque and reprisal may be obtained in order to seize the bodies or goods of the subjects of an offending state, until satisfaction shall be made. Where the people of one nation have unlawfully seized and detained property belonging to another state, the subjects of the latter are authorized by the laws of nations to indemnify themselves, by seizing the property of the subjects of the state aggressing. This is termed making reprisals, and commissions to this effect are issued from the admiralty.—3. Recapture; a retaking of a man's own goods, or any of his family, wife, child, or servant, wrongfully taken from him or detained by another. In this case, the owner may retake the goods or persons wherever he finds them.—*Letters of marque and reprisal*, a commission granted by the supreme authority of a state to a subject, empowering him to pass the frontiers [*marque*], that is, enter an enemy's territories and capture the goods and persons of the enemy in return for goods or persons taken by him.—4. The act of retorting on an enemy by inflicting suffering or death on a prisoner taken from him, in retaliation of an act of inhumanity.

REPRISE, *n.* (*s as z.*) [*Fr. r*] A taking by way of retaliation.—2. A term used by masons to denote the return of mouldings in an internal angle.

REPRISE, *v. t.* (*s as z.*) To take again.—2. To recompense; to pay.

REPRISING, *ppr.* Taking again; recompensing.

REPRIZES, *or*, REPRISES, *n. plur.* In *law*, yearly deductions out of a manor, or out of the value of lands; as, rent-charge, rent-seck, &c.

REPROACH, *v. t.* [*Fr. reprocher; It. rimprocciare; from the same root as approach, and Fr. proche, near L. proxi, in proximus.*] 1. To censure in terms of opprobrium or contempt.

Mezentius with his ardour warm'd His fainting friends, reproach'd their shameful flight,

Repell'd the victors. *Dryden.*

2. To charge with a fault in severe language.

That shame There sit not, and reproach us as unclean. *Milton.*

3. To upbraid; to suggest blame for any thing. A man's conscience will reproach him for a criminal, mean, or unworthy action.—4. To treat with scorn or contempt; Luke vi.

REPROACH, *n.* Censure mingled with

contempt or derision; contumelious or opprobrious language toward any person; abusive reflections; as, foul-mouthed reproach.—2. Shame; infamy; disgrace.

Give not thine heritage to reproach, Joel ii.; Is. iv.

3. Object of contempt, scorn, or derision.

Come, and let us build up the wall of Jerusalem, that we may be no more a reproach, Neh. ii.

4. That which is the cause of shame or disgrace, Gen. xxx.

REPROACHABLE, *a.* Deserving reproach.—2. Opprobrious; scurrilous. [*Not proper.*]

REPROACHABLENESS, *n.* The state of being reproachable.

REPROACHABLY, *adv.* In a reproachable manner.

REPROACHED, *pp.* Censured in terms of contempt; upbraided.

REPROACHER, *n.* One who reproaches.

REPROACHFUL, *a.* Expressing censure with contempt; scurrilous; opprobrious; as, reproachful words.—2. Shameful; bringing or casting reproach; infamous; base; vile; as, reproachful conduct; a reproachful life.

REPROACHFULLY, *adv.* In terms of reproach; opprobriously; scurrilously, 1 Tim. v.—2. Shamefully; disgracefully; contemptuously.

REPROACHING, *ppr.* Censuring in terms of contempt; upbraiding.

REPROBATE, *a.* [*L. reprobus, reprobo*, to disallow; *re* and *probo*, to prove.] 1. Not enduring proof or trial; not of standard purity or fineness; disallowed; rejected.

Reprobate silver shall men call them, because the Lord hath rejected them, Jer vi.

2. Abandoned in sin; lost to virtue or grace.

They profess that they know God, but in works deny him, being abominable and disobedient, and to every good work reprobate, Tit. i.

3. Abandoned to error, or in apostasy, 2 Tim. iii.

REPROBATE, *n.* A person abandoned to sin; one lost to virtue and religion.

I acknowledge myself a reprobate, a villain, a traitor to the king. *Raleigh.*

REPROBATE, *v. t.* To disapprove with detestation or marks of extreme dislike; to disallow; to reject. It expresses more than disapprove or disallow. We disapprove of slight faults and improprieties; we reprobate what is mean or criminal.—2. In a milder sense, to disallow.

Such an answer as this, is reprobated and disallowed in *law*. *Ayliffe.*

3. To abandon to wickedness and eternal destruction.—4. To abandon to his sentence, without hope or pardon.

Drive him out To reprobated exile. *Southern.*

REPROBATED, *pp.* Disapproved with abhorrence; rejected; abandoned to wickedness or to destruction.

REPROBATENESS, *n.* The state of being reprobate.

REPROBATER, *n.* One that reprobates.

REPROBATING, *ppr.* Disapproving with extreme dislike; rejecting; abandoning to wickedness or to destruction.

REPROBATION, *n.* [*Fr. from L. reprobatio.*]—1. The act of disallowing with detestation, or of expressing extreme dislike.—2. The act of aban-

doning or state of being abandoned to eternal destruction.

When a sinner is so hardened as to feel no remorse or misgiving of conscience, it is considered as a sign of reprobation. *Encyc.*

3. A condemnatory sentence; rejection.

Set a brand of reprobation on clipt poetry and false coin. *Dryden.*

REPROBATIONER, *n.* One who abandons others to eternal destruction.

REPROBATOR, *n.* In *Scots law*, the challenge of a witness. Where a witness was offered, to whose admissibility there were objections which could not be immediately verified, it was formerly the practice for the party making the objection, to protest for reprobator before the examination of the witness was proceeded with; that is, to protest that it should be afterwards competent for him, in an action of reprobator, to prove that the witness was liable to the objections of agency, enmity, partial counsel, or the like. This practice, however, is now discontinued, and the objections to a witness may be proved by the testimony of other witnesses.

REPRODUCE, *v. t.* [*re and produce.*] To produce again; to renew the production of a thing destroyed. Trees are reproduced by new shoots from the roots or stump; and certain animals, as the polype, are reproduced from cuttings.—2. Sometimes used for generate.

REPRODUCED, *pp.* Produced anew.

REPRODUCER, *n.* One or that which reproduces.

REPRODUCING, *ppr.* Producing anew.

REPRODUCTION, *n.* The act or process of reproducing that which has been destroyed; as, the reproduction of plants or animals from cuttings or slips. The reproduction of several parts of lobsters and crabs is one of the greatest curiosities in natural history. The power of reproduction is greatest in vegetables, and animals possess it in proportion as they resemble vegetables in the simplicity of their organization. The word, in *phys.*, is sometimes used for generation.

REPRODUCTIVE, *a.* Tending to reproduce.

REPRODUCTORY, } reproduce.

REPRODUCING, *v. t.* To promulgate again.

REPRODUCATION, *n.* A second promulgation.

REPROOF, *n.* [*from reprove.*] Blame expressed to the face; censure for a fault; reprehension.

Those best can bear reproof, who merit praise. *Pope.*

He that hateth reproof is brutish; Prov. xii.

2. Blame cast; censure directed to a person.

REPROVABLE, *a.* [*from reprove.*] Worthy of reproof; deserving censure; blamable.

REPROVABLENESS, *n.* State of being reprovable.

REPROVABLY, *adv.* In a reprovable manner.

REPROVE, *v. t.* [*Fr. reprouver; L. reprobo; re* and *probo*, to prove.]—1. To blame; to censure.

I will not reprove thee for thy sacrifices; Ps. i.

2. To charge with a fault to the face; to chide; to reprehend; Luke iii.—3. To blame for; with *of*; as, to reprove one of laziness.—4. To convince of a fault, or to make it manifest; John xvi.

5.† To refute; to disprove.—6. To excite a sense of guilt. The heart or conscience *reproves* us.—7. To manifest silent disapprobation or blame.

The vicious cannot bear the presence of the good, whose very looks *reprove* them, and whose life is a severe, though silent admonition. *Buckminster.*

REPROVED, *pp.* Blamed; reprehended; convicted of a fault.

REPROVER, *n.* One that reproves; he or that which blames. Conscience is a bold *reprover*.

REPROVING, *ppr.* Blaming; censuring. REPROVINGLY, *adv.* In a reproving manner.

REPRUNE, *v. t.* [*re* and *prune*.] To prune a second time.

REPRUNED, *pp.* Pruned a second time. REPRUNING, *ppr.* Pruning a second time.

REPTA'TION, *n.* [from *L. repto* to creep.] A mode of progression by advancing successively parts of the trunk which occupy the place of the anterior parts which are carried forwards, as in serpents; also applied to the slow progression of those animals whose extremities are so short that the body touches the ground.

REPTILE, *a.* [Fr. from *L. reptilis*, from *repto*, to creep, Gr. *ῥεπειν*: see CREEP. The primary sense is probably to rub or scrape, or to seize.] 1. Creeping; moving on the belly, or with small feet.—2. Grovelling; low; vulgar; as, a *reptile* race or crew; *reptile* vices.

REPTILE, *n.* 1. In a general sense, an animal that moves on its belly, or by means of small short legs, as snakes, lizards, tortoises, and the like. But the term *Reptiles* or *Reptilia*, when used zoologically, is confined to the designation of those cold-blooded quadruped, biped, apode, oviparous, and ovoviviparous vertebrated animals that breathe by means of lungs principally, and are without hair, feathers, or mamma. Such animals form the subject of that branch of zoological science termed *Herpetology*. Reptiles form the third class of vertebrated animals according to the arrangement of Cuvier, and it is divided into four orders, namely, chelonina or tortoises, sauria or lizards, ophidia or serpents, and batrachia or frogs. Of these four orders the chelonians and batrachians are partly aquatic, partly terrestrial; the saurians and ophidians are principally tenants of the land. According to Linnæus, reptiles constitute an order of the class Amphibia.—2. A grovelling or very mean person; a term of contempt. REPTILIAN, *a.* Belonging to the *Reptilia*, or reptiles.

REPTILIAN, *n.* An animal of the class *Reptilia*; a reptile.

REPUB'LIC, *n.* [*L. republica*; *res* and *publica*; public affairs.]—1. A commonwealth; a political community in which several persons share the sovereign power, or that form of government in which the supreme power is vested in the people, or in representatives chosen by them. A republic may be either an aristocracy or a democracy; the supreme power in the former being consigned to the nobles, or a few privileged individuals, as was formerly the case in Venice and Genoa; while in the latter the supreme power is placed in the hands of rulers chosen by and from the whole body of the people, or by their representatives

assembled in a congress or national assembly. Hamburg, Frankfort, Lübeck, and Bremen are instances of this latter form of government; but the most perfect example of it is to be found in the United States, and in some of the South American confederations which have shaken off the Spanish yoke. Governments usually styled limited monarchies, are properly aristocracies presided over by a king; and consequently ought to be referred to the class of republics, and not to that of monarchies.—2.† Common interest; the public.—*Republic of letters*, the collective body of learned men.

REPUB'LICAN, *a.* Pertaining to a republic; consisting of a commonwealth; as, a *republican* constitution or government.—2. Consonant to the principles of a republic; as, *republican* sentiments or opinions; *republican* manners.

REPUB'LICAN, *n.* One who favours or prefers a republican form of government.

REPUB'LICANISM, *n.* A republican form or system of government.—2. Attachment to a republican form of government.

REPUB'LICANIZE, *v. t.* To convert to republican principles; as, to *republicanize* the rising generation.

REPUBLICA'TION, *n.* [*re* and *publication*.] 1. A second publication, or a new publication of something before published.—2. A second publication, as of a former will; renewal.

If there be many testaments, the last overthrows all the former; but the *republication* of a former will revokes one of a later date, and establishes the first.

*Blackstone.*

REPUB'LIST, *v. t.* [*re* and *publish*.] To publish a second time, or to publish a new edition of a work before published.—2. To publish anew.

Unless, subsequent to the purchase or contract, the deviser *republishes* his will.

*Blackstone.*

REPUB'LISTED, *pp.* Published anew.

REPUB'LISTHER, *n.* One who republishes.

REPUB'LISTING, *ppr.* Publishing again.

REPUDIABLE, *a.* [from *repudiate*.] That may be rejected; fit or proper to be put away.

REPUDIATE, *v. t.* [Fr. *repudier*; *L. repudio*.] 1. To cast away; to reject; to discard.

Atheists ... *repudiate* all title to the kingdom of heaven. *Bentley.*

2. Appropriately, to put away; to divorce; as a wife.—3. To disown debts, contracted for the convenience or to meet the necessities of the state, and to revile those who lent it their money. [*An American abuse of the word.*]

REPUDIATED, *pp.* Cast off; rejected; discarded; divorced.

REPUDIATING, *ppr.* Casting off; rejecting; divorcing.

REPUDIATION, *n.* [Fr. from *L. repudiatio*.] 1. Rejection.—2. Divorce; as, the *repudiation* of a wife.—3. In the *United States of America*, the refusal on the part of a state or government to pay its just and lawful debts.

REPUDIATOR, *n.* One who repudiates. [*American.*]

REPUGN,† *v. t.* (*repu'ne*.) [*L. repugno*; *re* and *pugno*.] To oppose; to resist.

REPUGNANCE, } *n.* [Fr. *repug-*  
REPUGNANCY, } *nance*; *L. repug-*  
*nantia*, from *repugno*, to resist; *re* and *pugno*, to fight.] 1. Opposition of

mind; reluctance; unwillingness.—2. Opposition or struggle of passions; resistance.—3. Opposition of principles or qualities; inconsistency; contrariety.

But where difference is without *repugnancy*, that which hath been can be no prejudice to that which is. *Hooker.*

REPUGNANT, *a.* [Fr. from *L. repugnans*.] 1. Opposite; contrary; inconsistent; properly followed by *to*, but sometimes by *with*. Every sin is *repugnant* to the will of God. Every thing morally wrong is *repugnant* both to the honour as well as to the interest of the offender.—2.† Disobedient; not obsequious.

REPUGNANTLY, *adv.* With opposition; in contradiction.

REPUGNATE, *v. t.* To oppose: to fight against.

REPUL'LULATE, *v. i.* [*L. re* and *pululo*, to bud.] To bud again.

REPULLULA'TION, *n.* The act of budding again.

REPULSE, *n.* (*repuls'*.) [*L. repulsa*, from *repello*; *re* and *pello*, to drive.] 1. A being checked in advancing, or driven back by force. The enemy met with *repulse* and retreated.—2. Refusal; denial.

REPULSE, *v. t.* (*repuls'*.) [*L. repulsus*, *repello*.] To repel; to beat or drive back; as, to *repulse* an assailant or advancing enemy.

REPULS'ED, *pp.* Repelled; driven back.

REPULS'ER, *n.* One that repulses or drives back.

REPULS'ING, *ppr.* Driving back.

REPULSION, *n.* In *physical science*, that power or principle by which bodies or the particles of bodies under certain circumstances are made to recede from each other. Both attraction and repulsion exist in all the particles of material substances, and seem to be properties by which those particles act upon one another when not in contact. The cause of these actions is utterly unknown to us, and the terms are only applied in conformity to the phenomena exhibited. At all sensible distances bodies small and great, except in certain states, with respect to electricity or magnetism, attract one another. But the phenomena of light and elasticity in general show that at distances which are not appreciable by the eye, both attractions and repulsions take place. The elasticity of bodies is a result either of attractive or repulsive powers, or both. For example, when a steel rod is bent, and allowed to recover itself, a force of attraction will be exerted on one side, and of repulsion on the other. The expansions of solids and fluids by heat, and the elastic powers of gas at different temperatures, are consequences of the repulsions residing in the particles of caloric, or induced by the latter in those of the bodies with which they are combined. The forces both of attraction and repulsion, by which the particles of light are deflected from their course, when they impinge on a refracting or reflecting surface, are enormous, and Sir John Herschel computes that they exceed the force of gravity in the ratio of  $2 \times 10^4$  to 1. There is a repulsion between oil and water, iron and mercury, between similar poles of magnets, and between bodies in the same electrical state. In air and liquids it has been concluded that the particles do not touch, but are kept asunder at determinate distances

from each other by the constant action of the two forces of attraction and *repulsion*, which are supposed to balance and counteract each other.—2. The act of repelling.

**REPULSIVE**, *a.* Repelling; driving off, or keeping from approach. The *repulsive* power of the electric fluid is remarkable.—2. Cold; reserved; forbidding; as, *repulsive* manners.

**REPULSIVELY**, *adv.* By repulsing.

**REPULSIVENESS**, *n.* The quality of being repulsive or forbidding.

**REPULSELESS**, *a.* That cannot be repelled.

**REPULSORY**, *a.* Repulsive; driving back.

**REPURCHASE**, *v. t.* [*re* and *purchase*.] To buy again; to buy back; to regain by purchase or expense.

**REPURCHASE**, *n.* The act of buying again; the purchase again of what has been sold.

**REPURCHASED**, *pp.* Bought back or again; regained by expense; as, a throne *repurchased* with the blood of enemies.

**REPURCHASING**, *ppr.* Buying back or again; regaining by the payment of a price.

**REPUTABLE**, *a.* [from *repute*.] Being in good repute; held in esteem; as, a *reputable* man or character; *reputable* conduct. It expresses less than *respectable* and *honourable*, denoting the good opinion of men, without distinction or great qualities.—2. Consistent with reputation; not mean or disgraceful. It is evidence of extreme depravity that vice is in any case *reputable*.

In the article of danger, it is as *reputable* to elude an enemy as to defeat one. *Broome*.

**REPUTABLENESS**, *n.* The quality of being reputable.

**REPUTABLY**, *adv.* With reputation; without disgrace or discredit; as, to fill an office *reputably*.

**REPUTATION**, *n.* [Fr. from *L. reputatio*.] 1. Good name; the credit, honour or character which is derived from a favourable public opinion or esteem. *Reputation* is a valuable species of property or right, which should never be violated. With the loss of *reputation*, a man, but more especially a woman, loses most of the enjoyments of life.

The best evidence of *reputation* is a man's whole life. *Ames*.

2. Character by report; in a good or bad sense; as, a man has the *reputation* of being rich or poor, or of being a thief.

**REPUTATIVELY**, *adv.* By repute.

**REPÛTE**, *v. t.* [*L. reputo*; *re* and *puto*, to think; Fr. *reputer*.] To think; to account; to hold; to reckon.

The king was *reputed* a prince most prudent. *Shak*.

Wherefore are we counted as beasts, and *reputed* vile in your sight? *Job xviii*.

**REPÛTE**, *n.* Reputation; good character; the credit or honour derived from common or public opinion; as, men of *repute*.—2. Character; in a bad sense; as, a man held in bad *repute*.—3. Established opinion; as, upheld by old *repute*.

**REPÛTE**, *n.* In *Scots law*. [See *HABIT AND REPÛTE*.]

**REPÛTED**, *pp.* Reckoned; accounted. *Reputed ownership*, in *Scots law*, is when a person exercises all the rights of ownership over a subject not his own.

**REPÛTEDLY**, *adv.* In common opinion or estimation.

**REPÛTELESS**, *a.* Disreputable; disgraceful.

**REPÛTING**, *ppr.* Thinking; reckoning; accounting.

**REQUEST**, *n.* [Fr. *requête*; *L. requisitus*, *requiro*; *re* and *quero*, to seek. See *QUEST*, *QUESTION*.] 1. The expression of desire to some person for something to be granted or done; an asking; a petition.

Haman stood up to make *request* for his life to Esther the queen; *Esth. vii*.

2. Prayer; the expression of desire to a superior or to the Almighty; *Phil. iv*.

3. The thing asked for or requested.

I will both hear and grant your *requests*. *Shak*.

He gave them their *request*; but sent leanness into their soul; *Ps. cvi*.

4. A state of being desired or held in such estimation as to be sought after or pursued.

Knowledge and fame were in as great *request* as wealth among us now. *Temple*.

*In request*, in demand; in credit or reputation.

Coriolanus being now in no *request*. *Shak*.

*Request* expresses less earnestness than *entreaty* and *supplication*, and supposes a right in the person requested to deny or refuse to grant. In this it differs from *demand*.

**REQUEST**, *v. t.* [Fr. *requêter*.] 1. To ask; to solicit; to express desire for.

The weight of the golden ear-rings which he *requested*, was a thousand and seven hundred shekels of gold; *Judges viii*.

2. To express desire to; to ask. We *requested* a friend to accompany us.—

*Court of requests*, in England, a court of equity for the relief of such persons as addressed His Majesty by supplication; abolished by Stat. 16 and 17 Car. I.—2. A court of conscience for the recovery of small debts, held by two aldermen and four commoners, who try causes by the oath of parties and of other witnesses. It was erected in the 9th year of Henry VIII., with jurisdiction between citizens and freemen in cases of debt or damage under 40s., extended in the reign of Geo. III. to £5. The local courts instituted in many parts of England for the recovery of small debts by summary process, are also popularly called *Courts of Requests*.—*Letters of requests*, in *ecclesiastical law*, an instrument by which the regular judge of a cause waives or remits his own jurisdiction, under the provisions of the statute of citations, 23 Henry 8. c. 9; in which event, the jurisdiction of the appellate court attaches.

**REQUESTED**, *pp.* Asked; desired; solicited.

**REQUESTER**, *n.* One who requests; a petitioner.

**REQUESTING**, *ppr.* Asking; petitioning.

**REQUICKEN**, *v. t.* [*re* and *quicken*.] To reanimate; to give new life to.

**REQUICKENED**, *pp.* Reanimated.

**REQUICKENING**, *ppr.* Reanimating; invigorating.

**REQUIEM**, *n.* [L.] In the *Romish Church*, a hymn or mass sung for the dead, for the rest of the soul; so called from the first word.—2. A grand musical composition performed in honour of some deceased person.—3. † Rest; quiet; peace.

**REQUIETORY**, † *n.* [Low *L. requietorium*.] A sepulchre.

**REQUIN**, *n.* [Fr.] A fish of the shark kind; the *carcarias vulgaris*, or white shark.

**REQUIRABLE**, *a.* [from *require*.] That may be required; fit or proper to be demanded.

**REQUIRE**, *v. t.* [L. *requiro*; *re* and *quero*, to seek; Fr. and Sp. *requerir*. See *QUERY*.] 1. To demand; to ask, as of right and by authority. We *require* a person to do a thing, and we *require* a thing to be done.

Why then doth my lord *require* this thing? 1 *Chron. xxi*.

2. To claim; to render necessary; as a duty or any thing indispensable; as, the law of God *requires* strict obedience.—3. To ask as a favour; to request.

I was ashamed to *require* of the king a band of soldiers and horsemen to help us against the enemy in the way; *Ezra viii*.

[In this sense, the word is rarely used.]

4. To call to account for.

I will *require* my flock at their hand; *Ezek. xxxiv*.

5. To make necessary; to need; to demand.

The king's business *required* haste; 1 *Sam. xxi*.

6. To avenge; to take satisfaction for; 1 *Sam. xx*.

**REQUIRED**, *pp.* Demanded; needed; necessary.

**REQUIREMENT**, *n.* Demand; requisition.

This ruler was one of those who believe that they can fill up every *requirement* contained in the rule of righteousness.

J. M. Mason.

The Bristol water is of service where the secretions exceed the *requirements* of health. *Encyc.*

**REQUIRER**, *n.* One who requires.

**REQUIRING**, *ppr.* Demanding; needing.

**REQUISITE**, *a.* (as *z*.) [L. *requisitus*, from *requiro*.] Required by the nature of things or by circumstances; necessary; so needful that it cannot be dispensed with. Repentance and faith are *requisite* to salvation. Air is *requisite* to support life. Heat is *requisite* to vegetation.

**REQUISITE**, *n.* That which is necessary; something indispensable. Contentment is a *requisite* to a happy life.

God on his part has declared the *requisites* on ours; what we must do to obtain blessings, is the great business of us all to know. *Wake*.

**REQUISITELY**, *adv.* Necessarily; in a requisite manner.

**REQUISITENESS**, *n.* The state of being requisite or necessary; necessity.

**REQUISITION**, *n.* [Fr.; It. *requisizione*. See *REQUIRE*.] Demand; application made as of a right.—2. In *Scots law*, a demand made by a creditor that a debt be paid or an obligation fulfilled.—3. A written call or invitation, as, a *requisition* for a public meeting.

**REQUISITIVE**, *a.* Expressing or implying demand.

**REQUISITORY**, *a.* Sought for; demanded. [*Little used*.]

**REQUITAL**, *n.* [from *requite*.] Return for any office, good or bad; in a good sense, compensation; recompense; as, the *requit* of services; in a bad sense, retaliation or punishment; as, the *requit* of evil deeds.—2. Return; reciprocal action.

No merit thine aversion can remove, Nor ill *requit*al can efface their love. *Waller*.

**REQUITE**, *v. t.* [from *quit*, *L. cedo*; It. *cutighim*, to *requite*; *cuiteach*, recom-





2. To liken; to compare; to represent as like something else.

The torrid parts of Africa are *resembled* to a libbard's skin, the distance of whose spots represents the dispersed situation of the habitations. *Brevewood.*

**RESEMBLED**, *pp.* Likened; compared.

**RESEMBLING**, *ppr.* Having the likeness of; likening; comparing.

**RESEND**, *† v. t.* (pret. and *pp. resent*.) [*re* and *send*.] To send again; to send back.

**RESENT**, *v. t.* (*s* as *z*.) [*Fr. ressentir*, to perceive again, to have a deep sense of; *re* and *sentir*, to perceive, *L. sentio*; *It. risentire*, to resent, to hear again, to resound; *Sp. resentirse*, to resent, also to begin to give way or to fail; *resentimiento*, resentment; a flaw or crack.] Literally, to have a deep sense or feeling of. Hence, 1. *†* To take well; to receive satisfaction.—2. To take ill; to consider as an injury or affront; to be in some degree angry or provoked at.

Thou with scorn  
And nger wouldst *resent* the offer'd wrong. *Milton.*

**RESENT**, *pp.* Sent again.

**RESENTED**, *pp.* Taken ill; being in some measure angry at.

**RESENTER**, *n.* One who resents; one that feels an injury deeply.—*†* In the sense of one that takes a thing well.

**RESENTFUL**, *a.* Easily provoked to anger; of an irritable temper.

**RESENTFULLY**, *adv.* With resentment.

**RESENTING**, *ppr.* Taking ill; feeling angry at.

**RESENTINGLY**, *adv.* With a sense of wrong or affront; with a degree of anger.—*2. †* With a deep sense or strong perception.

**RESENTIVE**, *z.* Easily provoked or irritated; quick to feel an injury or affront.

**RESENTMENT**, *n.* [*Fr. ressentiment*; *It. risentimento*; *Sp. resentimiento*.] 1. The excitement of passion which proceeds from a sense of wrong offered to ourselves, or to those who are connected with us; anger long continued; sometimes simply anger. This word usually expresses less excitement than *anger*, though it is often synonymous with it. It expresses much less than *wrath*, *exasperation*, and *indignation*. In this use, *resentment* is not the sense or perception of injury, but the excitement which is the effect of it.

Can heavenly minds such high *resentment*  
show? *Dryden.*

*2. †* Strong perception of good.

**RESERVATION**, *n.* (*s* as *z*.) [*Fr. from L. reservo*.] 1. The act of reserving or keeping back or in the mind; reserve; concealment or withholding from disclosure; as, mental *reservation*.—2. Something withheld, either not expressed or disclosed, or not given up or brought forward.

With *reservation* of a hundred knights. *Shak.*

In the United States, a tract of land not sold with the rest, is called a *reservation*.—3. Custody; state of being treasured up or kept in store.—4. In *law*, a clause or part of an instrument by which something is reserved, not conceded or granted; also, a proviso.

*Mental reservation* is the withholding of expression or disclosure of something that affects a proposition or statement, and which, if disclosed, would materially vary its import.

*Mental reservations* are the refuge of hypocrites. *Encyc.*

**RESERVATIVE**, *a.* Keeping; reserving.

**RESERVATORY**, *n.* [*from reserve*.] A place in which things are reserved or kept.

**RESERVE**, *v. t.* (*rezerv'*.) [*Fr. réserver*; *L. reservo*; *re* and *servo*, to keep.] 1. To keep in store for future or other use; to withhold from present use for another purpose. The farmer sells his corn, *reserving* only what is necessary for his family.

Hast thou seen the treasures of hail,  
which I have *reserved* against the day of trouble? *Job xxxviii.*

2. To keep; to hold; to retain.

Will he *reserve* his anger for ever? *Jer. iii.*

3. To lay up and keep for a future time; *2 Pet. ii.*

*Reserve* your kind looks and language for private hours. *Swift.*

**RESERVE**, *n.* (*rezerv'*.) That which is kept for other or future use; that which is retained from present use or disposal.

The virgins, beside the oil in their lamps, carried likewise a *reserve* in some other vessel for a continual supply. *Tillotson.*

2. Something in the mind withheld from disclosure.

However any one may concur in the general scheme, it is still with certain *reserves* and deviations. *Addison.*

3. Exception; something withheld.

Is knowledge so despised,  
Or envy, or what *reserve* forbids to taste? *Milton.*

4. Exception in favour.

Each has some darling lust, which pleads for a *reserve*. *Rogers.*

5. Restraint of freedom in words or actions; backwardness; the habit of keeping back or restraining the mind or affections; modesty; caution in personal behaviour. *Reserve* may proceed from modesty, bashfulness, prudence, prudery, or sullenness.

My soul surprised, and from her sex disjoin'd,  
Left all *reserve*, and all the sex behind. *Prior.*

6. In *law*, reservation.—*In reserve*, in store; in keeping for other or future use. He has large quantities of wheat *in reserve*. He has evidence or arguments *in reserve*.—*Body of reserve*, in military affairs, the third or last line of an army drawn up for battle, reserved to sustain the other lines as occasion may require; a body of troops kept for an exigency.

**RESERVED**, *pp.* Kept for another or future use; retained.—*2. a.* Restrained from freedom in words or actions; backward in conversation; not free or frank; modest; not loosely free.

To all obliging, yet *reserved* to all. *Walsh.*  
Nothing *reserved* or sullen was to see. *Dryden.*

*Reserved power*, in *Scots law*, a reservation made in deeds, settlements, &c. Reserved powers are of different sorts, as, a *reserved power* of burdening a property; a *reserved power* to revoke or recal a settlement or other deed.

**RESERVEDLY**, *adv.* With reserve; with backwardness; not with openness or frankness.—*2.* Scrupulously; cautiously; coldly.

**RESERVEDNESS**, *n.* Closeness; want of frankness, openness, or freedom. A man may guard himself by that silence and *reservedness* which every one may innocently practise.

**RESERVER**, *n.* One that reserves.

**RESERVING**, *ppr.* Keeping back; keeping for other use, or for use at a future time; retaining.

**RESERVOIR**, *n.* [*Fr.*] A place where any thing is kept in store, particularly a place where water is collected and

kept for use when wanted, as, to supply a fountain, a canal, or a city, or to drive a mill-wheel and the like; a cistern; a mill-pond; a basin.—*2.* In *bot.*, the receptacles for the peculiar juices of plants are sometimes called *reservoirs*.

**RESET**, *n.* In *Scots law*, the receiving and harbouring of an outlaw or a criminal.—*Reset of theft*, the offence of receiving and keeping goods knowing them to be stolen, and with an intention to conceal and withhold them from the owner.—Among *printers*, matter set over again.

**RESET**, *v. t.* In *Scots law*, to receive stolen goods.—*2.* Among *printers*, to set over again; as a page of matter.

**RESETTER**, *n.* In *Scots law*, a receiver of stolen goods.

**RESETTLE**, *v. t.* [*re* and *settle*.] To settle again.

**RESETTLED**, *pp.* Settled again.

**RESETTLEMENT**, *n.* The act of settling or composing again.

The *resettlement* of my discomposed soul. *Norris.*

2. The state of settling or subsiding again; as, the *resettlement* of lees.

**RESETTLING**, *ppr.* Settling again.

**RES FURTIVE**, [*L.*] In *Scots law*, things stolen.

**RESHAPE**, *v. t.* To shape again.

**RESHAPED**, *pp.* Shaped again.

**RESHAPING**, *ppr.* Shaping a second time.

**RESHIP**, *v. t.* [*re* and *ship*.] To ship again; to ship what has been conveyed by water or imported; as, coffee and sugar imported into London, and *reshipped* for Hamburg.

**RESHIPMENT**, *n.* The act of shipping or loading on board a ship a second time; the shipping for exportation what has been imported.—*2.* That which is reshipped.

**RESHIPPED**, *pp.* Shipped again.

**RESHIPPING**, *ppr.* Shipping again.

**RESIANCE**, *† n.* [*See RESIANT*.] Residence; abode.

**RESIANT**, *† a.* [*Norm. resiant, resseant*, from the *L. resideo*. See *RESIDE*.] Resident; dwelling; present in a place.

**RESIDE**, *v. i.* (*s* as *z*.) [*Fr. residet*; *L. resideo, residet*; *re* and *sedeo*, to sit, to settle.] 1. To dwell permanently or for a length of time; to have a settled abode for a time. The peculiar uses of this word are to be noticed. When the word is applied to the natives of a state, or others who dwell in it as permanent citizens, we use it only with reference to the *part* of a city or country in which a man dwells. We do not say generally, that Englishmen *reside* in England, but a particular citizen *resides* in London or York, or at such a house in such a street, in the Strand, &c.—When the word is applied to strangers or travellers, we do not say a man *resides* in an inn for a night, but he *resided* in London or Oxford, a month or a year; or, he may *reside* in a foreign country a great part of his life. A man lodges, stays, remains, abides, for a day or very short time, but *reside* implies a longer time, though not definite.—*2. †* To sink to the bottom of liquors; to settle. [*In this sense, subside* is now used.]

**RESIDENCE**, *n.* [*Fr.*] The act of *RESIDENCY*, abiding or dwelling in a place for some continuance of time; as, the *residence* of an Englishman in France or Italy for a year.

The Confessor had often made considerable *residences* in Normandy. *Hale.*

2. The place of abode; a dwelling; a habitation.

Caprea had been . . . the *residence* of Tibertius for several years.

3. † That which falls to the bottom of liquors.—4. In the *canon* and *common law*, the abode of a parson or incumbent on his benefice; opposed to *non-residence*. Under the Act 1 and 2 Vict., c. 106, an incumbent is considered to be non-resident, if he is absent for one or more periods, exceeding in the whole three calendar months in each year; and will be liable to the penalties, unless he has obtained a licence for non-residence from the bishop, or is within any of the statutory exemptions.

RESIDENT, *a.* [L. *residens*; Fr. *resident*.] Dwelling or having an abode in a place for a continuance of time, but not definite; as a minister *resident* at the court of St. James's.

RESIDENT, *n.* One who resides or dwells in a place for some time. A. B. is now a *resident* in London.—2. A public minister who resides at a foreign court. It is usually applied to ministers of a rank inferior to that of ambassadors.

RESIDENTIAL, *n.* A resident.

RESIDENTIAL, *a.* Residing.

RESIDENTIARY, *a.* Having residence.

RESIDENTIARY, *n.* An ecclesiastic who keeps a certain residence, as a canon *residential*.

RESIDER, *n.* One who resides in a particular place.

RESIDING, *ppr.* Dwelling in a place for some continuance of time.

RESIDUAL, *a.* Remaining after a part is taken.—*Residual analysis*, a branch of analysis invented by Landon, and applied by him to the solution of those problems which are more generally solved by the doctrine of fluxions. This method was called the residual analysis, because, in all cases where it is made use of, the conclusions are obtained by means of residual quantities. In this analysis a geometrical or physical problem is reduced to another purely algebraical, and the solution is then obtained without any supposition of motion, and without considering quantities as composed of infinitely small particles. *Residual quantity*, in *alge.*, a binomial connected by the sign—(minus); thus  $a - b$ ,  $a - \sqrt{6 \&c.}$ , are residual quantities.—*Residual figure*, in *geom.*, the figure remaining after subtracting a less from a greater.—*Residual phenomenon*, a term lately brought into partial use to signify that part of a phenomenon which is left when every part which can be explained or accounted for is removed. This residual phenomenon may be all the observer's error, or may be partly the effect of some undiscovered law, and partly the error of the observer.

RESIDUARY, *a.* [L. *residuus*. See *RESIDE*.] Pertaining to the residue or part remaining; as, the *residuary* advantage of an estate.—*Residuary legatee*, in law, the legatee to whom is bequeathed the part of goods and estate which remains after deducting all the debts and specific legacies. In *Scots law*, the person to whom the whole of a movable estate is conveyed, by a settlement or general disposition, is called a *universal legatee* or *legatary* and sometimes a *general disponee*.

RESIDUE, *n.* [Fr. *résidu*.] 1. That

which remains after a part is taken, separated, removed, or designated.

The locusts shall eat the *residue* of that which has escaped; Exod. x.

2. The balance or remainder of a debt or account.—3. In law, the remainder of a testator's estate after payment of debts and legacies.

RESIDUUM, *n.* [L.] In *chem.*, residue; that which is left after any process of separation or purification.—2. In law, the part of an estate or of goods and chattels remaining after the payment of debts and legacies.

RESIEGE, † *v. t.* [Fr. and *siege*.] To seat again; to reinstate.

RESIGN, *v. t.* (*rezi'ne*.) [Fr. *resigner*; L. *resigno*; *re* and *signo*, to sign. The radical sense of *sign* is to send, to drive, hence to set. To *resign* is to send back or send away.] 1. To give up; to give back, as an office or commission, to the person or authority that conferred it; hence, to surrender an office or charge in a formal manner; as, a military officer *resigns* his commission; a prince *resigns* his crown.

*Phœbus resigns* his darts, and Jove His thunder, to the god of love. *Denham*.

2. To withdraw, as a claim. He *resigns* all pretensions to skill.—3. To yield; as, to *resign* the judgment to the direction of others.—4. To yield or give up in confidence.

What more reasonable, than that we should in all things *resign* ourselves to the will of God? *Tillotson*.

5. To submit, particularly to Providence.

A firm, yet cautious mind; Sincere; though prudent; constant, yet *resign'd*. *Pope*.

6. To submit without resistance or murmur.

RESIGN, *v. t.* To sign again.

RESIGN, † *n.* Resignation.

RESIGNATION, *n.* [Fr.] The act of resigning or giving up, as a claim or possession; as, the *resignation* of a crown or commission.—2. Submission; unresisting acquiescence; as, a blind *resignation* to the authority of other men's opinions.—3. Quiet submission to the will of Providence; submission without discontent, and with entire acquiescence in the divine dispensations. This Christian *resignation*.—*Resignation*, in *Scots law*, is the form by which a vassal returns the feu into the hands of a superior. Where it is intended to return the property permanently to the superior, it is termed *resignation ad remanentiam*; and, where the object is to transfer the property to a third party, it is termed *resignation in favorem*.—

4. In the *canon law*, the giving up of a benefice into the hands of the ordinary.

RESIGNED, *pp.* Given up; surrendered; yielded.—2. *a.* Submissive to the will of God.

RESIGNEDLY, *adv.* With submission.

RESIGNER, *n.* One that resigns.

RESIGNING, *ppr.* Giving up; surrendering; submitting.

RESIGNMENT, † *n.* The act of resigning.

RESILAH, *n.* An ancient patriarchal coin.

RESILE, *v. t.* [L. *resilio*.] To start back; to recede from a purpose. [*Little used*.]

RESILIENCE, } *n.* (as *z.*) [L. *resiliens*,  
RESILIENCY, } *resilio*; *re* and *salio*, to spring.] The act of leaping or springing back, or the act of rebounding; as, the *resilience* of a ball or of sound.

RESILIENT, *a.* [L. *resiliens*.] Leaping or starting back; rebounding.

RESILI'TION, *n.* [L. *resilio*.] The act of springing back; resilience.

RESILLE, *n.* (*resil'*.) The strip of lead which serves to unite the small portions of coloured glass forming a mosaic.

RESIN, *n.* (*s* as *z.*) [Fr. *resine*; L. *It.* and Sp. *resina*; Ir. *roisin*; Gr. *ρῆμα*, probably from *ρῆω*, to flow.] Resins are solid inflammable substances, which are insoluble in water, but soluble in alcohol and essential oils. When cold they are more or less brittle and translucent, and of a colour inclining to yellow.

When pure they are nearly insipid and inodorous. They are non-conductors of electricity, and when excited by friction, their electricity is negative. They are heavier than water, and they melt by heat. They combine with the alkalis of the metals, performing the function of weak acids, and forming soaps. They are soluble in many of the acids, and convertible by some into other peculiar acids. They frequently exude from trees in combination with essential oils, and in a liquid or semi-liquid state. They are composed of carbon, hydrogen and oxygen, and are supposed to be formed by the oxygenation of the essential oils. There is a great number and variety of the resins. They are valuable as ingredients in varnishes, and several of them are used in medicine. They are often naturally blended with gum, in which they constitute the series of *gum-resins*. [See *GUM*.] The soft resins which retain a certain portion of volatile oil constitute what are called balsams. *Kauri* or *Cowdee* resin, a new and very peculiar substance, recently imported from New Zealand, and obtained from a tree called *Dammara australis*, or *Pinus Kauri*. Its colour varies from milk-white to amber, or even deep brown.

It affords a fine varnish with alcohol, and also with turpentine. *Resin of aldehyde*, a product of the decomposition of the aqueous solution of aldehyde by caustic potash. When dried and heated to 212° it gives off a very nauseous soapy smell, and it sometimes inflames spontaneously.

RESIN-EXTRACTIVE, *a.* Designating extractive matter in which resin predominates.

RESINIFEROUS, *a.* [L. *resina* and *fero*, to produce.] Yielding resin; as, a *resiniferous* tree or vessel.

RESINIFORM, *a.* Having the form of resin.

RESINO-ELECTRIC, *a.* Containing or exhibiting negative electricity, or that kind which is produced by the friction of resinous substances.

RESINOID, *a.* Resembling resin.

RESINOUS, *a.* Partaking of the qualities of resin; like resin.—*Resinous substances* are combustible.—*Resinous electricity*, is that electricity which is excited by rubbing bodies of the resinous kind, in distinction from that excited by rubbing glass, which is termed *vitreous electricity*.

RESINOUSLY, *adv.* By means of resin; as, *resinously* electrified.

RESINOUSNESS, *n.* The quality of being resinous.

RES INTER ALIOS ACTA, ALIIS NEC NOCET, NEC PRODEST, [L.] A maxim in *Scots law*, signifying that things done between particular individuals neither injure nor benefit others. It is said of a judgment in a cause which affects only the parties in the cause, and not others, though concerned.

RES'INY, *a.* Like resin, or partaking of its qualities.

RESIPIS'CNCE, *n.* [Fr. from *L. resipisco*, from *resipio*; *re* and *sapio*, to taste.] Properly, wisdom derived from severe experience; hence, repentance. [Little used.]

RESIST, *v. t.* (*resist'*) [*L. resisto*; *re* and *sisto*, to stand; Fr. *resister*.] 1. Literally, to stand against; to withstand; hence, to act in opposition, or to oppose. A dam or mound *resists* a current of water *passively*, by standing unmoved and interrupting its progress. An army *resists* the progress of an enemy *actively*, by encountering and defeating it. We *resist* measures by argument or remonstrance.

Why doth he yet find fault? for who hath *resisted* his will? Rom. ix.

2. To strive against; to endeavour to counteract, defeat, or frustrate.

Ye do always *resist* the Holy Spirit; Acts vii.

3. To baffle; to disappoint.

God *resisteth* the proud, but giveth grace to the humble; James iv.

RESIST', *v. i.* To make opposition.

RESIST'ANCE, *n.* The act of resisting; opposition. Resistance is *passive* as that of a fixed body which interrupts the passage of a moving body; or *active*, as in the exertion of force to stop, repel, or defeat, progress or designs.

2. The quality of not yielding to force or external impression; that power of a body which acts in opposition to the impulse or pressure of another, or which prevents the effect of another power; as, the *resistance* of a ball which receives the force of another; the *resistance* of wood to a cutting instrument; the *resistance* of air to the motion of a cannon-ball, or of water to the motion of a ship. The *resistance* produced by the rubbing of the surfaces of two bodies against each other, caused by the asperities or inequalities of the rubbing surfaces, is called *friction*,—*which see*.—*Resistance* or *resisting force*, in *mech.*, denotes, generally, a force acting in opposition to another force so as to destroy it, or diminish its effect. It is a power by which motion, or a tendency to motion in any body, is retarded or prevented. Resistance is sometimes considered as of two kinds, *active* and *passive*, the first being that which corresponds to the useful effect produced by a machine, and the second that which arises from the inertia of the machine. *Solid of least resistance*, in *mech.*, the solid whose figure is such that in its motion through a fluid, it sustains the least resistance of all others having the same length and base; or, on the other hand, being stationary in a current of fluid, offers the least interruption to the progress of that fluid. In the former case it has been considered the best form for the stem of a ship; in the latter the proper form for the pier of a bridge. The problem of finding the solid of least resistance was first proposed and solved by Newton.

RESIST'ANT, *n.* He or that which resists.

RESIST'ED, *pp.* Opposed; counteracted; withstood.

RESISTER, *n.* One that opposes or withstands.

RESISTIBILITY, } *n.* The quality  
RESIST'IBLENESS, } of resisting.

The name body, being the complex idea of extension and *resistibility* together in the same subject. Locke.

2. Quality of being resistible; as, the *resistibility* of grace.

RESIST'IBLE, *a.* That may be resisted; as, a *resistible* force; *resistible* grace.

RESIST'IBLY, *adv.* In a resistible manner.

RESIST'ING, *ppr.* Withstanding; opposing. *Resisting medium*, a substance which opposes the passage of a body through it.

RESIST'IVE, *a.* Having the power to resist.

RESIST'LESS, *a.* That cannot be effectually opposed or withstood; irresistible.

*Resistless* in her love as in her hate. Dryden.

2. That can not resist; helpless.

RESIST'LESSLY, *adv.* So as not to be opposed or denied.

RESIST'LESSNESS, *n.* State of being irresistible.

RES JUDICA'TA, [L.] In *Scots law*, a question settled by a final judgment.

RES MERCATO'RIA, [L.] A mercantile transaction.

RESOLD, *pp.* of *Resell*. Sold a second time, or sold after being bought.

RES'OLUBLE, *a.* (*s* as *z*) [*re* and *L. solubilis*. See *RESOLVE*.] That may be melted or dissolved; as, bodies *resolvable* by fire.

RES'OLUTE, *a.* [Fr. *résolu*; It. *resoluto*. The Latin *resolutus* has a different signification. See *RESOLVE*.] Having a fixed purpose; determined; hence, bold; firm; steady; constant in pursuing a purpose.

Edward is at hand, Ready to fight; therefore be *resolute*. Shak.

RES'OLUTELY, *adv.* With fixed purpose; firmly; steadily; with steady perseverance. Persist *resolutely* in a course of virtue.—2. Boldly; firmly;

Some of these facts he examines, some he *resolutely* denies. Swift.

RES'OLUTENESS, *n.* Fixed purpose; firm determination; unshaken firmness.

RESOLUTION, *n.* [Fr. from *L. resolutio*. See *RESOLVE*.] 1. The act, operation, or process of separating the parts which compose a complex idea or a mixed body; the act of reducing any compound or combination to its component parts; analysis; as the *resolution* of complex ideas; the *resolution* of any material substance by chemical operations.—2. The act or process of unravelling or disentangling perplexities, or of dissipating obscurity in moral subjects; as, the *resolution* of difficult questions in moral subjects.

3. Dissolution; the natural process of separating the component parts of bodies.—4. In *music*, the resolution of a dissonance, is the carrying of it according to rule, into a consonance in the subsequent chord.—5. In *med.*, the disappearing of any tumour without coming to suppuration; the dispersing of inflammation; the breaking up and disappearance of a fever.—6. Fixed purpose or determination of mind, settled thought or purpose, as, a *resolution* to reform our lives; a *resolution* to undertake an expedition.—7. The effect of fixed purpose; firmness, steadiness, or constancy in execution, implying courage.

They who governed the parliament, had the *resolution* to act those monstrous things. Clarendon.

8. Determination of a cause in a court of justice; as, a judicial *resolution*.

[But this word is now seldom used to express the decision of a judicial tribunal. We use *judgment*, *decision*, or *decree*.]—9. The determination or decision of a legislative body, or a formal proposition offered for legislative determination.—10. The formal determination of any corporate body, or of any association of individuals; as, the *resolutions* of a public meeting.—11. In *alge*, the resolution of an equation, is the same as reduction; the bringing of the unknown quantity by itself on one side, and all the known quantities on the other, without destroying the equation, by which is found the value of the unknown quantity.—12. † Relaxation; a weakening.—*Resolution* or *solution*, in *math.*, the orderly enumeration of the things to be done to obtain what is required in a problem. A problem may be divided into three parts—the proposition, the resolution, and the demonstration.—*Resolution of forces* or *of motion*, in *dynamics*, the dividing of any single force or motion into two or more others, which, acting in different directions, shall produce the same effect as the given motion or force. This is the reverse of *composition* of

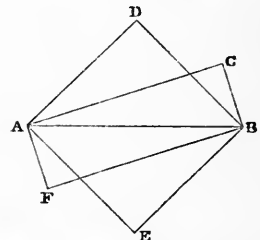

*forces* or *of motion*. Thus let A B represent the quantity and direction of some given force; draw any lines A C, A D; and join C B, D B, and complete the parallelograms A D B E, A C B F. Then by composition of forces the force A B is equivalent to A D and A E, or to A C and A F. Hence it is evident that a given force, as A B, may be resolved into as many pairs of forces as there can be triangles described upon a given straight line A B, or parallelograms about it. And as the forces represented by A D, D B, or A C, C B, may also be resolved into other pairs of forces, it appears that by proceeding in the same manner with the successive pairs of forces, a given force may be resolved into an unlimited number of others, acting in all possible directions. [See *COMPOSITION, FORCE, RESULTANT*.]

RESOLU'TIONER, † *n.* One who joins in the declaration of others.

RESOLU'TIONIST, *n.* One who makes a resolution.

RES'OLUTIVE, *a.* Having the power to dissolve or relax. [Not much used.] *Resolutive condition*, in *Scots law*, a condition in a sale which does not suspend the completion of the contract; but which resolves the sale, if the condition be purified at the time specified.

RESOLV'ABLE, *a.* That may be resolved or reduced to first principles. Capable of solution; admitting separation of parts.

RESOLV'ABLENESS, *n.* State of being resolvable.

**RESOLVE**, *v. t.* (rezolv'.) [*L. resolvo*; *re* and *solveo*; to loose; *Fr. résoudre*; *It. risolvere*; *Sp. resolver.*] 1. To separate the component parts of a compound substance; to reduce to first principles; as, to *resolve* a body into its component or constituent parts; to *resolve* a body into its elements. 2. To separate the parts of a complex idea; to reduce to simple parts; to analyze.—3. To separate the parts of a complicated question; to unravel; to disentangle of perplexities; to remove obscurity by analysis; to clear of difficulties; to explain; as, to *resolve* questions in moral science; to *resolve* doubts; to *resolve* a riddle.—4. To inform; to free from doubt or perplexity; as, to *resolve* the conscience.

*Resolve* me, strangers, whence and what you are? *Dryden.*

2. To settle in an opinion; to make certain.

Long since we were *resolved* of your truth, Your faithful service and your toil in war. *Shak.*

6. To confirm; to fix in constancy.

Quit presently the chapel, or *resolve* you For more amazement. [*Unusual.*] *Shak.*

7. To melt; to dissolve.—8. To form or constitute by resolution, vote, or determination; as, the house *resolved* itself into a committee of the whole.

9. In music, to resolve a discord or dissonance, is to carry it, according to rule, into a consonance in the subsequent chord.—10. In *med.*, to disperse or scatter; to discuss; as an inflammation or a tumour.—11. To relax; to lay at ease.—12. In *math.*, to solve. [*See Resolution.*]

13. In *alge.*, to resolve an equation, is to bring all the known quantities to one side of the equation, and the unknown quantity to the other.

**RESOLVE**, *v. i.* (rezolv'.) To fix in opinion or purpose; to determine in mind. He *resolved* to abandon his vicious course of life.—2. To determine by vote. The legislature *resolved* to receive no petitions after a certain day.—3. To melt; to dissolve; to become fluid.

When the blood stagnates in any part, it first coagulates, then *resolves* and turns alkaline. *Arbutnot.*

4. To separate into its component parts, or into distinct principles; as, water *resolves* into vapour; a substance *resolves* into gas.—5. To be settled in opinion.

Let men *resolve* of that as they please. [*Unusual.*] *Locke.*

**RESOLVE**, *n.* (rezolv'.) Fixed purpose of mind; settled determination; resolution.

He straight revokes his bold *resolve*. *Denham.*

2. In *American legislation*, legal or official determination; legislative act concerning a private person or corporation, or concerning some private business.

**RESOLVED**, *pp.* Separated into its component parts; analysed.—2. Determined in purpose; as, I am *resolved* not to keep company with gamblers. This phrase is properly, "*I have resolved*;" as we say, a person *is deceased*, for *has* deceased; he *is retired*, for *has* retired. In these phrases, the participle is rather an adjective.—3. Determined officially or by vote.

**RESOLVEDLY**, *adv.* With firmness of purpose.

**RESOLVEDNESS**, *n.* Fixedness of purpose; firmness; resolution.

**RESOLV'ENT**, *n.* That which has the power of causing solution. In *med.*, that which has power to disperse inflammation and prevent the suppuration of tumours; a discutient.

**RESOLV'ER**, *n.* One that resolves or forms a firm purpose.

**RESOLV'ING**, *ppr.* Separating into component parts; analysing; removing perplexities or obscurity; discussing, as tumours; determining.

**RESOLV'ING**, *n.* The act of determining or forming a fixed purpose; a resolution.

**RES'ONANCE**, or **RES'ONANCY**, *n.* (*s* as *z.*) [*L. resonans.*] 1. A resounding; a sound returned from the sides of a hollow instrument of music; reverberated sound or sounds.—2. A sound returned.—*Resonancy* is less used.

**RES'ONANT**, *a.* [*L. resonans*; *re* and *sono*, to sound.] Resounding; returning sound; echoing back.

**RESORB**; *v. t.* [*L. resorbeo*; *re* and *sorbeo*, to drink in.] To swallow up.

**RESORB'ENT**, *a.* Swallowing up.

**RESORT**, *v. i.* (*s* as *z.*) [*Fr. ressortir*; *re* and *sortir*, to go or come out.] 1. To have recourse; to apply; to betake. The king thought it time to *resort* to other counsels. *Clarendon.*

2. To go; to repair.

The people *resort* to him again; Mark x. John xviii.

3. To fall back.

The inheritance of the sou never *resorted* to the mother.† *Hale.*

**RESORT**, *n.* The act of going to or making application; a betaking one's self; as, a *resort* to other means of defence; a *resort* to subterfuges for evasion.—2. Act of visiting.

Join with me to forbid him her *resort*. *Shak.*

3. Assembly; meeting.—4. Concourse; frequent assembling; as, a place of *resort*.—5. The place frequented; as, alehouses are the *resorts* of the idle and dissolute.—6.† Spring; active power or movement; a *Gallicism*.—*Last resort*, ultimate means of relief; also, final tribunal; that from which there is no appeal.

**RESORTER**, *n.* One that resorts or frequents.

**RESORT'ING**, *ppr.* Going; having recourse; betaking; frequenting.

**RESOUND**; *v. t.* (*s* as *z.*) [*L. resono*; *re* and *sono*, to sound; *Fr. resonner.*] 1. To send back sound; to echo. And Albion's cliffs *resound* the rural lay. *Pope.*

2. To sound; to praise or celebrate with the voice or the sound of instruments.—3. To praise; to extol with sounds; to spread the fame of. The man for wisdom's various arts renown'd, Long exercis'd in woes, O muse, *resound*. *Pope.*

**RESOUND**, *v. i.* To be echoed; to be sent back, as sound; as, common fame *resounds* back to them.—2. To be much and loudly mentioned.—3. To echo or reverberate; as, the earth *resounded* with his praise.

**RE'SOUND**, *v. t.* [*re* and *sound*; with the accent on the first syllable.] To sound again.

**RESOUND**, *n.* (*s* as *z.*) Return of sound; echo.

**RESOUND'ED**, *pp.* Echoed; returned, as sound; celebrated.

**RESOUND'ING**, *ppr.* Echoing; returning, as sound.

**RESOURCE**, *n.* [*Fr. ressource*; *re* and *source*.] 1. Any source of aid or sup-

port; an expedient to which a person may resort for assistance, safety, or supply; means yet untried; resort. An enterprising man finds *resources* in his own mind.

Pallas view'd

His foes pursuing and his friends pursu'd, Used threat'nings mixed with prayers, his last *resource*. *Dryden.*

2. *Resources*, in the plural, pecuniary means; funds; money or any property that can be converted into supplies; means of raising money or supplies. Our national *resources* for carrying on war are abundant. Commerce and manufactures furnish ample *resources*.

**RESOURCELESS**, *a.* Destitute of resources.

**RESOW**, *v. t.* pret. *resowed*; pp. *resowed* or *resown*. [*re* and *sow*.] To sow again.

**RESOWN**, } pp. Sown anew.

**RESPEAK**, *v. t.* pret. *respoke*; pp. *respoken*, *respoke*. [*re* and *speak*.] To answer; to speak in return; to reply. [*Little used.*] 2. To speak again; to repeat.

**RESPECT**, *v. t.* [*L. respecto*, or *respectus*, from *respicio*; *re* and *specio*, to view; *Fr. respecter.*] 1. To regard; to have regard to in design or purpose.

In orchards and gardens, we do not so much *respect* beauty, as variety of ground for fruits, trees, and herbs. *Bacon*

2. To have regard to, in relation or connection; to relate to. The treaty particularly *respects* our commerce.—3. To view or consider with some degree of reverence; to esteem as possessed of real worth.

I always loved and *respected* Sir William. *Swift.*

4. To look toward.

Palladius adviseth the front of his house should so *respect* the south.† *Brown.*

To *respect* the person, to suffer the opinion or judgment to be influenced or biased by a regard to the outward circumstances of a person, to the prejudice of right and equity.

Thou shalt not *respect* the person of the poor; Lev. xix.

Neither doth God *respect* any person; 2 Sam xiv.

**RESPECT**, *n.* [*L. respectus*; *Fr. respect.*] 1. Regard; attention.—2. That estimation or honour in which men hold the distinguished worth or substantial good qualities of others. It expresses less than *reverence* and *veneration*, which regard elders and superiors; whereas *respect* may regard juniors and inferiors. *Respect* regards the qualities of the mind, or the actions which characterize those qualities. Seen without awe, and served without *respect*. *Prior.*

3. That deportment or course of action which proceeds from esteem; regard; due attention; as, to treat a person with *respect*.

These same men treat the sabbath with little *respect*. *Nelson.*

4. Good will; favour.

The Lord had *respect* to Abel and his offering; Gen. iv.

5. Partial regard; undue bias to the prejudice of justice; as the phrase, *respect of persons*; 1 Pet. i; James ii; Prov. xxiv.—6. Respected character; as, persons of the best *respect* in Rome.—7. Consideration; motive in reference to something.

Whatever secret *respects* were likely to move them... *Hooker.*

8. Relation; regard; reference; followed by *of*, but more properly by *to*.

They believed but one Supreme Deity, which, with *respect* to the benefits men received from him, had several titles.

*Tillotson.*

**RESPECTABILITY**, *n.* State or quality of being respectable; the state or qualities which deserve or command respect.

**RESPECT'ABLE**, *a.* [Fr.; It. *rispettabile*; Sp. *respetable*.] 1. Possessing the worth or qualities which deserve or command respect; worthy of esteem and honour; as, a *respectable* citizen; *respectable* company.

No government, any more than an individual, will long be respected, without being truly *respectable*.

*Federalist, Madison.*

2. In *popular language*, this word is much used to express what is moderate in degree of excellence or in number, but not despicable. We say, a *respectable* discourse or performance, a *respectable* audience, a *respectable* number of citizens convened.

**RESPECT'ABLENESS**, *n.* Respectability.

**RESPECT'ABLY**, *adv.* With respect; more generally, in a manner to merit respect.—2. Moderately, but in a manner not to be despised.

**RESPECT'ED**, *pp.* Held in honourable estimation.

**RESPECT'ER**, *n.* One that respects; chiefly used in the phrase, *respector of persons*, which signifies a person who regards the external circumstances of others in his judgment, and suffers his opinion to be biased by them, to the prejudice of candour, justice, and equity.

- I perceive that God is no *respector of persons*; Acts x.

**RESPECT'FUL**, *a.* Marked or characterized by respect; as, *respectful* deportment.

With humble joy and with *respectful* fear.

*Prior.*

**RESPECT'FULLY**, *adv.* With respect; in a manner comporting with due estimation.

**RESPECT'FULNESS**, *n.* The quality of being respectful.

**RESPECT'ING**, *ppr.* Regarding; having regard to; relating to. This word, like *concerning*, has reference to a single word or to a sentence. In the sentence, "his conduct *respecting* us is commendable," *respecting* has reference to *conduct*. But when we say, "*respecting* a further appropriation of money, it is to be observed, that the resources of the country are inadequate," *respecting* has reference to the whole subsequent clause or sentence.

—*Respecting* or *Respectant*, in *her*, is an epithet applied to animals when placed so as to face each other.



Respecting.

**RESPECTIVE**, *a.* [Fr. *respectif*; It. *rispettivo*.] 1. Relative; having relation to something else; not absolute; as, the *respective* connections of society.

—2. Particular; relating to a particular person or thing; not collective or altogether, but several. Let each man retire to his *respective* place of abode. The officers were found in their *respective*

quarters; they appeared at the head of their *respective* regiments. Let each give according to his *respective* proportion.—3. † Worthy of respect.—4. † Careful; circumspect; cautious; attentive to consequences; as, *respective* and wary men.

**RESPECT'IVELY**, *adv.* As relating to each; particularly, as each belongs to each. Let each man *respectively* perform his duty.

The impressions from the objects of the senses do mingle *respectively* every one with its kind.

*Bacon.*

2. Relatively; not absolutely.—3. † Partially; with respect to private views.—4. † With respect.

**RESPECT'LESS**, *a.* Having no respect; without regard; without reference. [*Little used.*]

**RESPECT'LESSNESS**, *n.* The state of having no respect or regard; regardlessness. [*Little used.*]

**RES PERIT SUO DOMINO**. [L.] A maxim in *Scots law*, implying that the owner of a subject must bear the loss, if it perish, unless its destruction can be ascribed to another's fault.

**RESPERSE**, *v. t.* (respers'.) [L. *respersus*, *respergo*; *re* and *spargo*, to sprinkle.] To sprinkle. [*Rarely used.*]

**RESPER'SION**, *n.* [L. *respersio*.] The act of sprinkling.

**RESPIRABILITY**, } *n.* The quality  
**RESPIRABLENESS**, } of being respirable.

**RESPI'RABLE**, *a.* [from *respire*.] That may be breathed; fit for respiration or for the support of animal life; as, *respirable* air. Azotic gas is not *respirable*.

**RESPIRA'TION**, *n.* [Fr. from L. *respiratio*.] 1. The act of breathing; the act of inhaling air into the lungs and again exhaling or expelling it, by which animal life is supported; the function by which the nutrient circulating fluid of an organized body is submitted to the influence of air for the purpose of changing its properties. The great end which appears to be answered by respiration is the removal of carbon, in the form of *carbonic acid*, from venous blood. This gas is accordingly found in the air which is expired from the lungs; and the blood having lost its carbonic acid, at the same time loses its dingy hue, and acquires, through the inhalation of oxygen from the air, the florid red which characterizes arterial blood. Respiration alternates with *inspiration*, which takes place about twenty-six times in a minute, thirteen cubic inches of air being the average quantity taken in at each inspiration. Respiration goes on in plants as well as in animals. The *respiration* of fishes, [for these cannot live long without air,] appears to be performed by the air contained in the water acting on the gills.—2. Relief from toil.

**RESPIRATOR**, or **RESPIRA'TOR**, *n.* An instrument for breathing through, fitted to cover the mouth, over which it is retained by proper bandages. It is used more especially in cold weather by individuals having delicate lungs; the respirator being intended to modify the temperature of the air inhaled, and thus lessen its noxious influence on the lungs.

**RESPIRATORY**, *a.* Serving for respiration; as, *respiratory* organs.

**RESPIRE**, *v. i.* [Fr. *respirer*; L. *respiro*; *re* and *spiro*, to breathe.] 1.

To breathe; to inhale air into the lungs and exhale it, for the purpose of maintaining animal life.—2. To catch breath.—3. To rest; to take rest from toil.

**RESPIRE**, *v. t.* To exhale; to breathe out; to send out in exhalations.

**RESPIRED**, *pp.* Breathed; inhaled and exhaled.

**RESPIRING**, *ppr.* Breathing; taking breath.

**RES'PITE**, *n.* [Fr. *repit*.] 1. Pause; temporary intermission of labour, or of any process or operation; interval of rest.

Some pause and *respit* only I require.

*Denham.*

2. In *law*, reprieve; temporary suspension of the execution of a capital offender.—3. Delay; forbearance; prolongation of time for the payment of a debt beyond the legal time.—4. The delay of appearance at court granted to a jury, beyond the proper term.

**RES'PITE**, *v. t.* To relieve by a pause or interval of rest.

To *respit* his day-labour with repast.

*Milton.*

2. To suspend the execution of a criminal beyond the time limited by the sentence; to delay for a time.

If the court may *respit* for a day, they may for a year.

*Cinton.*

3. To give delay of appearance at court; as, to *respit* a jury.

**RES'PITED**, *pp.* Relieved from labour; allowed a temporary suspension of execution.

**RES'PITING**, *ppr.* Relieving from labour; suspending the execution of a capital offender.

**RESPLEN'DENCE**, } *n.* [L. *resplendens*, *resplendescere*; *dens*, *resplendeo*; *re* and *splendeo*, to shine.] Brilliant lustre; vivid brightness; splendour.

Son! thou in whom my glory I behold

In full *resplendence*, heir of all my might.

*Milton.*

**RESPLEN'DENT**, *a.* [supra.] Very bright; shining with brilliant lustre.

With royal arras and *resplendent* gold.

*Spenser.*

*Resplendent felspar*, another name for *adularia* or moonstone.

**RESPLEN'DENTLY**, *adv.* With brilliant lustre; with great brightness.

**RESPLIT**, *v. t.* [*re* and *split*.] To split again.

**RESPLIT**, *v. i.* To split or rend a second time.

**RESPOND**, *v. i.* [Fr. *répondre*; L. *respondeo*; *re* and *spondeo*, to promise, that is, to send to. Hence *respondeo* is to send back.] 1. To answer; to reply.

A new affliction strings a new chord in the heart, which *responds* to some new note of complaint within the wide scale of human woe.

*Buckminster.*

2. To correspond; to suit.

To every theme *responds* thy various lay

*Broome.*

3. In the *U. States*, to be answerable; to be liable to make payment; as, the defendant is held to *respond* in damages.

**RESPOND**, *v. t.* In the *U. States*, to answer; to satisfy by payment. The surety was held to *respond* the judgment of court. The goods attached shall be held to *respond* the judgment. **RESPOND**, *n.* A short anthem interrupting the middle of a chapter, which is not to proceed till the anthem is ended.—2. † An answer.—3. In *arch*,

a half pillar, or pilaster responding to another, or to a pillar opposite to it.  
**RESPOND'E BOOK**, *n.* A book kept by the directors of chancery in Scotland, for entering the accounts of all non-entry and relief duties payable by heirs who take precepts from chancery.  
**RESPOND'ED**, *pp.* Answered; satisfied by payment.

**RESPOND'ENCE**, }  
**RESPOND'ENCY**, } *n.* An answering.  
**RESPOND'ENT**, *a.* Answering; that answers to demand or expectation.

Wealth *respondent* to payment and contributions. *Bacon.*

**RESPOND'ENT**, *n.* One that answers in a suit, particularly a chancery suit.—2. In the schools, one who maintains a thesis in reply, and whose province is to refute objections or overthrow arguments.

**RESPONDEN'TIA**, *n.* [L. from *respondeo*, to promise, to reply.] In mercantile law, a species of contract, which differs from bottomry, in that the loan is effected on the security of the freight, and not on that of the ship itself. [See **BOTTOMRY**.]

**RESPOND'ING**, *ppr.* Answering; corresponding.

**RESPONS'AL**, † *a.* Answerable; responsible.

**RESPONS'AL**, *n.* Response; answer.—2. † One who is responsible.

**RESPONSE**, *n.* (responsus.) [L. *responsum*.] 1. An answer or reply; particularly, an oracular answer.—2. The answer of the people or congregation to the priest, in the litany and other parts of divine service.—3. Reply to an objection in formal disputation.—4. In the *Romish church*, a kind of anthem sung after the morning lesson, and some other parts of the office.—5. In a *figue*, a repetition of the given subject by another part.

**RESPONSIBILITY**, *n.* [from *responsibile*.] The state of being accountable or answerable, as for a trust or office, or for a debt. It is used in the plural; as, heavy *responsibilities*.—2. Ability to answer in payment; means of paying contracts.

**RESPONS'IBLE**, *a.* [from L. *responsus*, *respondeo*.] 1. Liable to account; accountable; answerable; as for a trust reposed, or for a debt. We are all *responsible* for the talents intrusted to us by our Creator. A guardian is *responsible* for the faithful discharge of his duty to his ward. The surety is *responsible* for the debt of his principal.—2. Able to discharge an obligation; or having estate adequate to the payment of a debt. In taking bail, the officer will ascertain whether the proposed surety is a *responsible* man.

**RESPONS'IBLENESS**, *n.* State of being liable to answer, repay, or account; responsibility.—2. Ability to make payment of an obligation or demand.

**RESPONS'IBLY**, *adv.* In a responsible manner.

**RESPON'SION**, † *n.* [L. *responsio*.] The act of answering.

**RESPON'SIONS**, *n.* The first examination which the students at Oxford are obliged to pass before they can take any degree, also called the *little-go*.

**RESPONS'IVE**, *a.* Answering; making reply.—2. Correspondent; suited to something else.

The vocal lay *responsive* to the strings. *Pope.*  
**RESPONS'IVELY**, *adv.* In a responsive manner.

**RESPONS'IVENESS**, *n.* State of being responsive.

**RESPONS'ORY**, *a.* Containing answer.  
**RESPONS'ORY**, *n.* A response; the answer of the people to the priest in the alternate speaking, in church service. [Unusual.]

**RESSAULT**, *n.* [Fr.] In *arch.*, the recess or projection of a member from or before another, so as to be out of the line or range with it.

**REST**, *n.* [Sax. *rest*, *raest*, quiet or a lying down; Dan. G. and Sw. *rast*; D. *rust*. The German has also *ruhe*, Sw. *ro*, Dan. *roe*, rest, repose. In W. *araws*, and *arosi*, signify to stay, stop, wait. See the Verb.] 1. Cessation of motion or action of any kind, and applicable to any body or being; as, rest from labour; rest from mental exertion; rest of body or mind. A body is at rest when it ceases to move; the mind is at rest, when it ceases to be disturbed or agitated; the sea is never at rest. Hence.—2. Quiet; repose; a state free from motion or disturbance; a state of reconciliation to God.

Learn of me, for I am meek and lowly in heart; and ye shall find rest to your souls; Matt. xi.

3. Sleep; as, retire to rest.—4. Peace; national quiet.

The land had rest eighty years; Judges iii.; Deut. xii.

5. The final sleep, death; the grave; as, he is gone to his rest.—6. A place of quiet; permanent habitation.

Ye are not as yet come to the rest, and to the inheritance which the Lord your God giveth you; Deut. xii.

7. Any place of repose.  
 In dust, our final rest and native home. *Milton.*

8. That on which any thing leans or lies for support; 1 Kings vi.  
 Their vizors clos'd, their lances in the rest. *Dryden.*

9. In *poetry*, a short pause of the voice in reading; a cesura.—10. In *philosophy*, the continuance of a body in the same place, either absolutely or relatively, namely, its continuance in the same part of absolute space, or in the same part of relative space, the former state being hence denominated *absolute rest*, and the latter *relative rest*. It is however highly probable that there is no such thing as absolute rest in the universe; at least we know of nothing in such a state.—11. Final hope.

Sea fights have been final to the war; but this is, when princes set up their rest upon the battle. † *Bacon.*

12. Cessation from tillage; Lev. xxv.—13. The gospel church or new covenant state in which the people of God enjoy repose, and Christ shall be glorified; Is. xi.—14. In *music*, a pause; an interval during which the voice, or sound, is intermitted; also, the mark of such intermission. The pause or cessation of sound is equal in duration to the note represented by the rest. As there are six musical characters called notes, so there are as many rests.—To set up one's rest, to fix one's great hope.

**REST**, *n.* [Fr. *reste*, from *rester*, to remain, L. *resto*.] 1. That which is left, or which remains after the separation of a part, either in fact or in contemplation; remainder.

Religion gives part of its reward in hand, the present comfort of having done our duty, and for the rest, it offers us the best security that Heaven can give. *Tillotson.*

2. Others; those not included in a proposition or description. [In this

sense, *rest* is a noun, but with a singular termination expressing plurality.]

Plato and the rest of the philosophers. *Stillingfleet.*

Arm'd like the rest, the Trojan prince appears. *Dryden.*

The election hath obtained, it and the rest were blinded; Rom. xi.

In *joint-stock companies*, a reserved or sinking fund, being a portion of the profits accumulated into a fund for meeting extra losses, and thereby enabling the company to pay a full dividend.

**REST**, *v. i.* [Sax. *restan*, *hrestan*, to pause, to cease, to be quiet; D. *rusten*; G. *rasten*; Sw. *rasta*.] 1. To cease from action or motion of any kind; to stop; [a word applicable to any body or being, and to any kind of motion.]—2. To cease from labour, work, or performance.

God rested on the seventh day from all his work which he had made; Gen. ii.

So the people rested on the seventh day; Exod. xvi.

3. To be quiet or still; to be undisturbed. There rest, if any rest can harbour there. *Milton.*

4. To cease from war; to be at peace. And the land rested from war; Josh. xi.

5. To be quiet or tranquil, as the mind; not to be agitated by fear, anxiety, or other passion.—6. To lie; to repose; as, to rest on a bed.—7. To sleep; to slumber. Fancy then retires

Into her private cell, when nature rests. *Milton.*

8. To sleep the final sleep; to die or be dead. Glad I lay me down,

As in my mother's lap; there I should rest, And sleep secure. *Milton.*

9. To lean; to recline for support; as, to rest the arm on a table. The truth of religion rests on divine testimony.—10. To stand on; to be supported by; as, a column rests on its pedestal.—11. To be satisfied; to acquiesce; as, to rest on Heaven's determination.—12. To lean; to trust; to rely; as, to rest on a man's promise.—13. To continue fixed; Isa. li.—14. To terminate; to come to an end; Ezek. xvi.—15. To hang, lie, or be fixed. Over a tent a cloud shall rest by day. *Milton.*

16. To abide; to remain with. They said, the spirit of Elijah doth rest on Elisha; 2 Kings ii.; Eccles. vii.

17. To be calm or composed in mind; to enjoy peace of conscience.—To rest with, to be in the power of, to depend upon; as, it rests with time to decide.

**REST**, † *v. i.* [Fr. *rester*.] To be left; to remain.

**REST**, *v. t.* To lay at rest; to quiet. Your piety has paid

All needful rites, to rest my wandering shade. *Dryden.*

2. To place, as on a support. We rest our cause on the truth of the Scripture. Her weary head upon your bosom rest. *Waller.*

**RESTAG'NANT**, *a.* [L. *restagnans*.] Stagnant; remaining without a flow or current. [Not much used.]

**RESTAG'NATE**, *v. i.* [L. *restagno*; *re* and *stagnato*, to stagnate.] To stand or remain without flowing. [This word is superseded by *Stagnate*.]

**RESTAGNA'TION**, *n.* Stagnation,—which see.

**REST'ANT**, *a.* [L. *restans*, *resto*.] In bot., remaining, as footstalks after the fructification has fallen off.

**RESTAURANT**, *n.* [Fr.] See **RESTAURATEUR**.

**RESTAURATEUR**, *n.* [Fr.] The

keeper of a *restaurant* or eating-house, where provisions may be had ready cooked at all hours.

**RESTAURATION, n.** [L. *restauo.*] Restoration to a former good state. [The present orthography is *Restoration*,—which see.]

**REST'ED, pp.** Laid on for support.

**RESTEM, v. t.** [re and stem.] To force back against the current.

**REST'FUL, a.** [from *rest.*] Quiet; being at rest.

**REST'FULLY, adv.** In a state of rest or quiet.

**REST'HAR'ROW, n.** A British plant of the genus *Ononis*, the *O. arvensis*, also called cammock. [See *ONONIS*.]

**REST'HOUSE, n.** In *India*, an empty house for the accommodation of travellers; a serai.

**RESTIA'CEÆ, n.** A nat. order of plants, principally inhabiting the southern hemisphere, and nearly related to the Cyperaceous order of Europe. They abound at the Cape of Good Hope and in Australia, where they form a hard, wiry, rush-like herbage. The stems of some species are manufactured into baskets and brooms, and *Restio tectorum* is employed for thatching.

**REST'IFF, a.** [Fr. *rétif*; It. *restivo*, *restio*; from L. *resto*.] 1. Unwilling to go, or only running back; obstinate in refusing to move forward; stubborn; as, a *restiff* steed. It seems originally to have been used of horses that would not be driven forward. It is otherwise written *Restive* and *Resty*.

All who before him did ascend the throne,  
Labour'd to draw three *restive* nations on.

*Roscommon.*

2. Unyielding; as, *restiff* stubbornness.

—3. † Being at rest, or less in action.

**REST'IFF, n.** A stubborn horse.

**REST'IFFNESS, n.** Obstinate reluctance or indisposition to move.—2. Obstinate unwillingness.

**REST'ILY, adv.** [See *RESTY*.] Stubbornly; untowardly.

**RESTIN'CTION, n.** [L. *restinctio*, *restinguo*; re and *extinguo*.] The act of quenching or extinguishing.

**REST'ING, ppr.** Ceasing to move or act; ceasing to be moved or agitated; lying; leaning; standing; depending or relying.

**REST'ING-PLACE, n.** A place for rest; in a place to stop at, as on a journey. In *arch.*, a half or quarter pace in a stair-case.

**RESTIN'GUISH, v. t.** [L. *restinguo*; re and *extinguo*.] To quench or extinguish.

**REST'ITUTE, † v. t.** [L. *restituo*; re and *statuo*, to set.] To restore to a former state.

**RESTITU'TION, n.** [L. *restitutio*.] 1. The act of returning or restoring to a person some thing or right of which he has been unjustly deprived; as, the *restitution* of ancient rights to the crown.—*Restitution* is made by restoring a specific thing taken away or lost.

—2. The act of making good, or of giving an equivalent for any loss, damage, or injury; indemnification. He *restituted* to the value makes. *Sandys*.

3. The act of recovering a former state or posture. [Unusual.] *Restitution of all things*, the putting the world in a holy and happy state; Acts iii.—*Writ of restitution*, in *law*, a writ which lies where judgment has been reversed to restore to the defendant what he has lost. It can properly only be granted where the party cannot be restored by the ordinary course of law.—In *Scots law*, *restitution* is an obli-

gation incumbent on the person in possession of a movable where that movable is truly the property of another, even although the possessor should have obtained it by purchase; nor will the owner in that case be bound to pay the price which the holder may have given. An action lies for the restitution of money paid through mistake or ignorance, or of money paid in contemplation of an event, which, through the fault of the receiver, has not happened.

**REST'ITUTOR, n.** One who makes restitution. [Little used.]

**REST'IVE, a.** [See *RESTIFF*.] Unwilling to go, or to move forward; stopping; resisting; obstinate; stubborn; as a *restive* steed.

**REST'IVENESS, n.** Obstinate reluctance, or indisposition to move; obstinate unwillingness.

**REST'LESS, a.** [from *rest*; Sax. *restleas*.] 1. Unquiet; uneasy; continually moving; as, a *restless* child.—2. Being without sleep; uneasy. *Restless* he pass'd the remnant of the night.

*Dryden.*

3. Passed in unquietness; as, the patient has had a *restless* night.—4. Uneasy; unquiet; not satisfied to be at rest or in peace; as, a *restless* prince; *restless* ambition; *restless* passions.—5. Uneasy; turbulent; as, *restless* subjects.—6. Unsettled; disposed to wander or to change place or condition. *Restless* at home, and ever prone to range.

*Dryden.*

**REST'LESSLY, adv.** Without rest; quietly.

When the mind casts and turns itself *restlessly* from one thing to another. *South.*

**REST'LESSNESS, n.** Uneasiness; unquietness; a state of disturbance or agitation, either of body or mind.—2. Want of sleep or rest; uneasiness.—3. Motion; agitation; as, the *restlessness* of the magnetic needle.

**RESTORABLE, a.** [from *restore*.] That may be restored to a former good condition; as, *restorable* land.

**RESTORABLENESS, n.** State of being restorable.

**RESTORAL, n. †** Restitution.

**RESTORA'TION, n.** [Fr. *restauration*; L. *restauratio*.] 1. The act of replacing in a former state.

Behold the different climes agree,  
Rejoicing in thy *restoration*. *Dryden.*

So we speak of the *restoration* of a man to his office, or to a good standing in society.—2. Renewal; revival; re-establishment; as, the *restoration* of friendship between enemies; the *restoration* of peace after war; the *restoration* of a declining commerce.—3. Recovery; renewal of health and soundness; as, *restoration* from sickness or from insanity.—4. Recovery from a lapse or any bad state; as, the *restoration* of man from apostasy.—5. In *theol.*, universal restoration, the final recovery of all men from sin and alienation from God, to a state of happiness; universal salvation.—6. In *England*, the return of King Charles II. in 1660, and the re-establishment of monarchy.—*Restorations in architecture*, a term applied to drawings intended to show ancient buildings according to their original design, as made out from their existing remains, aided by such descriptions or hints as are to be obtained from classic authors, or from the representations of them on coins.—*Restoration* also signifies the re-

pairing of the injury suffered by works of art, buildings, statues, pictures, &c. **RESTORATIVE, a.** That has power to renew strength and vigour.

**RESTORATIVE, n.** A medicine efficacious in restoring strength and vigour, or in recruiting the vital powers.

**RESTORATORY, a.** Restorative. [Bad.]

**RESTORE, v. t.** [Fr. *restaurer*; L. *restauo*.] This is a compound of *re* and the root of *store*, *story*, *history*. The primary sense is to set, to lay or to throw, as in Gr. *στίσις*, solid.] 1. To give back; to return to a person, as a specific thing which he has lost, or which has been taken from him and unjustly detained. We *restore* lost or stolen goods to the owner.

Now therefore *restore* to the man his wife;  
Gen. xx.

2. To replace; to return; as a person or thing to a former place.

Pharaoh shall *restore* thee to thy place;  
Gen. xl.

3. To bring back.  
The father banish'd virtue shall *restore*.

*Dryden.*

4. To bring back or recover from lapse, degeneracy, declension, or ruin to its former state.

...Loss of Eden, till one greater man  
*Restore* it, and regain the blissful seat.

*Milton.*

Our fortune *restored* after the severest afflictions.

5. To heal; to cure; to recover from disease.

His hand was *restored* whole like as the other; Matt. xii.

6. To make restitution or satisfaction for a thing taken, by returning something else, or something of different value.

He shall *restore* five oxen for an ox, and four sheep for a sheep; Exod. xxiii.

7. To give for satisfaction for pretended wrongs something not taken; Ps. lxxix.—8. To repair; to rebuild; as, to *restore* and to build Jerusalem; Dan. ix.—9. To revive; to resuscitate; to bring back to life.

Whose son he had *restored* to life; 2 Kings viii.

10. To return or bring back after absence; Heb. xiii.—11. To bring to a sense of sin and amendment of life; Gal. vi.—12. To renew or re-establish after interruption; as, peace is *restored*. Friendship between the parties is *restored*.—13. To recover or renew, as passages of an author obscured or corrupted; as, to *restore* the true reading.—14. In the *fine arts*, to bring back from a state of injury or decay; as, to *restore* a painting, statue, &c. Also, to represent, by means of drawings, ancient ruinous buildings according to their original state or design.

**RESTORED, pp.** Returned; brought back; retrieved; recovered; cured; renewed; re-established.

**RESTOREMENT, † n.** The act of restoring; restoration.

**RESTORER, n.** One that restores; one that returns what is lost or unjustly detained; one who repairs or re-establishes.

**RESTORING, ppr.** Returning what is lost or taken; bringing back; recovering; curing; renewing; repairing; re-establishing.—*Restoring force in physics*, the force with which an elastic body returns to its former state after the force that compressed it or made it to yield, is removed.

**RESTRAIN, v. t.** [Fr. *restreindre*; L. *restringo*; re and *stringo*, to strain.

The letter *g* appears from the participle to be casual; *stringo*, for *strigo*. Hence *strictus*, *strict*, *stricture*. If the two letters *st* are removed, the word *rigo* coincides exactly, in primary sense, with *L. rego*, *rectus*, *right*, and the root of *reach*, *stretch*, *straight*.] 1. To hold back; to check; to hold from action, proceeding or advancing, either by physical or moral force, or by any interposing obstacle. Thus we *restrain* a horse by a bridle; we *restrain* cattle from wandering by fences; we *restrain* water by dams and dikes; we *restrain* men from crimes and trespasses by laws; we *restrain* young people, when we can, by arguments or counsel; we *restrain* men and their passions; we *restrain* the elements; we attempt to *restrain* vice, but not always with success.—2. To repress; to keep in awe; as, to *restrain* offenders.—3. To suppress; to hinder or repress; as, to *restrain* excess.—4. To abridge; to hinder from unlimited enjoyment; as, to *restrain* one of his pleasure or of his liberty.—5. To limit; to confine.

Not only a metaphysical or natural, but a moral universality is also to be *restrained* by a part of the predicate. *Watts*.  
6. To withhold; to forbear.

Thou *restrainest* prayer before God; Job xv.

**RESTRAINABLE**, *a.* Capable of being restrained.

**RESTRAINED**, *pp.* Held back from advancing or wandering; withheld; repressed; suppressed; abridged; confined.

**RESTRAINEDLY**, *adv.* With restraint; with limitation.

**RESTRAINER**, *n.* He or that which restrains.

**RESTRAINING**, *ppr.* Holding back from proceeding; checking; repressing; hindering from motion or action; suppressing.—2. *a.* Abridging; limiting; as, a *restraining* statute.—3. That checks or hinders from sin; as, *restraining* grace.

**RESTRAINTMENT**, *n.* Act of restraining.

**RESTRAINT**, *n.* [from Fr. *restreint*.] 1. The act or operation of holding back or hindering from motion, in any manner; hinderance of the will, or of any action, physical, moral, or mental.—2. Abridgment of liberty; as, the *restraint* of a man by imprisonment or by dress.—3. Prohibition. The commands of God should be effectual *restraints* upon our evil passions.—4. Limitation; restriction.

If all were granted, yet it must be maintained, within any bold *restraints*, far otherwise than it is received. *Brown*.

5. That which restrains, hinders, or represses. The laws are *restraints* upon injustice.

**RESTRICT**, *v. t.* [L. *restrictus*, from *restringo*. See **RESTRAIN**.] To limit; to confine; to restrain within bounds; as, to *restrict* words to a particular meaning; to *restrict* a patient to a certain diet.

**RESTRICTED**, *pp.* Limited; confined to bounds.

**RESTRICTING**, *ppr.* Confining to limits.

**RESTRICT'ION**, *n.* [Fr. from L. *restrictus*.] 1. Limitation; confinement within bounds.

This is to have the same *restriction* as all other recreations. *Gov. of the Tongue*.

*Restriction of words*, is the limitation of their signification in a particular

manner or degree.—2. Restraint; as, *restrictions* on trade.

**RESTRICT'IVE**, *a.* [Fr. *restrictif*.]

1. Having the quality of limiting or of expressing limitation; as, a *restrictive* participle.—2. Imposing restraint; as, *restrictive* laws of trade.—3.† Styptic.

**RESTRICT'IVELY**, *adv.* With limitation.

**RESTRINGE**, *v. t.* (*restring'*.) [L. *restringo*, supra.] To confine; to contract; to astringe.

**RESTRIN'GENCY**, *n.* The quality or power of contracting.

**RESTRIN'GENT**, *a.* Astringent; styptic.

**RESTRIN'GENT**, *n.* A medicine that operates as an astringent or styptic.

**RESTRIVE**, *v. t.* [*re* and *strive*.] To strive anew.

**REST'Y**, *a.* The same as *restive* or *restif*, of which it is a contraction.

**RESUBJE'C'TION**, *n.* [*re* and *subjection*.] A second subjection.

**RESUBLIMA'TION**, *n.* A second sublimation.

**RESUBLIME**, *v. t.* [*re* and *sublime*.] To sublime again; as, to *resublime* mercurial sublimate.

**RESUBLIMED**, *pp.* Sublimed a second time.

**RESUBLIMING**, *ppr.* Subliming again.

**RESUDA'TION**, *n.* [L. *resudatus*, *resudo*; *re* and *sudo*, to sweat.] The act of sweating again.

**RESULT**, *v. i.* (*s* as *z*.) [Fr. *resulter*; L. *resulto*, *resilio*; *re* and *salio*, to leap.]—1. To leap back; to rebound.

The huge round stone, *resulting* with a bound. *Pope*.

2. To proceed, spring, or rise, as a consequence, from facts, arguments, premises, combination of circumstances, consultation, or meditation. Evidence *results* from testimony, or from a variety of concurring circumstances; pleasure *results* from friendship; harmony *results* from certain accordances of sounds.

Pleasure and peace naturally *result* from a holy and good life. *Tillotson*.

3. To come out, or have an issue; to terminate, followed by *in*; as, this measure will *result in* good or evil.

**RESULT**, *n.* Resilience; act of flying back.

Sound is produced between the string and the air, by the return of the *result* of the string. *Bacon*.

2. Consequence; conclusion; inference; effect; that which proceeds naturally or logically from facts, premises, or the state of things; as, the *result* of reasoning; the *result* of reflection; the *result* of a consultation or council; the *result* of a legislative debate.—3. Consequence or effect.

The misery of sinners will be the natural *result* of their vile affections and criminal indulgences. *J. Lathrop*.

**RESULT'ANCE**, *n.* The act of resulting.

**RESULT'ANT**, *n.* In *dynamics*, the force which *results* from the composition of two or more forces acting upon a body. When the two forces act upon a body in the same line of direction, the resultant is equivalent to the sum of both; when they act in opposite directions, the resultant is equal to their difference, and acts in the direction of the greater. If the lines of direction of the two forces are inclined to each other, then on taking in each direction, from the point where they intersect, a straight line to represent each of the forces respectively, and con-

structing a parallelogram of which these lines are the adjacent sides, the resultant is represented in intensity and direction by the diagonal of the parallelogram passing through the point of intersection. By combining this resultant with a third force a new resultant will be obtained; and in this manner the resultant of any number of forces may be determined.

**RESULT'ING**, *ppr.* Proceeding as a consequence, effect or conclusion of something; coming to a determination. 2. In law, *resulting use*, is a use which returns to him who raised it, after its expiration or during the impossibility of vesting in the person intended.

**RESUMABLE**, *a.* (*s* as *z*.) [from *resume*.] That may be taken back, or that may be taken up again.

**RESUME**, *n.* (*rā-zu-mā'*.) [Fr.] A summing up; a condensed statement.

**RESUME**, *v. t.* (*s* as *z*.) [L. *resumo*; *re* and *sumo*, to take.]—1. To take back what has been given.

The sun, like this from which our sight we have,

Gaz'd on too long, *resumes* the light he gave. *Denham*.

2. To take back what has been taken away.

They *resume* what has been obtained fraudulently. *Dacenant*.

3. To take again after absence; as, to *resume* a seat.

Reason *resum'd* her place, and passion fled. *Dryden*.

4. To take up again after interruption; to begin again; as, to *resume* an argument or discourse. [*This is now its most frequent use.*]

**RESUMED**, *pp.* Taken back; taken again; begun again after interruption.

**RESUMING**, *ppr.* Taking back; taking again; beginning again after interruption.

**RESUMMON**, *v. t.* To summon or call again.—2. To recal; to recover.

**RESUMMONED**, *pp.* Summoned again; recovered.

**RESUMMONING**, *ppr.* Recalling; recovering.

**RESUMPT'ION**, *n.* [Fr. from L. *resumptus*.] The act of resuming, taking back or taking again; as, the *resumption* of a grant.

**RESUMPT'IVE**, *a.* Taking back or again.

**RESUPINATE**, *a.* [L. *resupinatus*, *resupino*; *re* and *supino*, *supinus*, lying on the back.] In *bot.*, reversed; turned upside down. A *resupinate* corol is when the upper lip faces the ground, and the lower lip the sky. A *resupinate* leaf is when the upper surface becomes the lower, and the contrary; or when the lower disk looks upward.

**RESUPINA'TION**, *n.* [supra.] The state of lying on the back; the state of being resupinate or reversed, as a corol.

**RESUPINE**, *a.* Lying on the back.

**RESURREC'TION**, *n.* (*s* as *z*.) [Fr. from L. *resurrectus*, *resurgo*; *re* and *surgo*, to rise.] A rising again; chiefly, the revival of the dead of the human race, or their return from the grave, particularly at the general judgment. By the *resurrection* of Christ we have assurance of the future *resurrection* of men; 1 Pet. i.

In the *resurrection* they neither marry, nor are given in marriage; Matth. xxii.

**RESURREC'TIONIST**, *n.* One whose business is to steal bodies from the grave. [*Trivial.*]



**RESURVEY'**, *v. t.* [re and *survey*.] To survey again or anew; to review.

**RESURVEY**, *n.* A second survey.

**RESURVEYED**, *pp.* Surveyed again.

**RESURVEYING**, *ppr.* Surveying anew; reviewing.

**RESUS'CITATE**, *v. t.* [L. *resuscito*; re and *suscito*, to raise.] 1. To stir up anew; to revivify; to revive; particularly, to recover from apparent death; as, to *resuscitate* a drowned person, to *resuscitate* withered plants.—2. To reproduce, as a mixed body from its ashes.

**RESUS'CITATE**, *v. i.* To revive.

**RESUS'CITATED**, *pp.* Revived; revived; reproduced.

**RESUS'CITATING**, *ppr.* Reviving; revivifying; reproducing.

**RESUSCITATION**, *n.* The act of reviving from a state of apparent death; the state of being revivified; the restoring to animation of persons apparently dead, as in cases of drowning, suspended animation from exposure to cold, or from disease. In cases of drowning, the most essential means of resuscitation, and the first to be employed, are artificial respiration, or inflation of the lungs by fresh air, together with warmth and friction, carefully and moderately applied. The body should be immediately conveyed to a warm and dry place, stripped of the wet clothes, wrapped in warm blankets, and placed on its back, with the head, shoulders, and chest a little raised. [See **DROWNING**.]—2. The reproducing of a mixed body from its ashes.

**RESUS'CITATIVE**, *a.* Reviving; revivifying; raising from apparent death; reproducing.

**RESUS'CITATOR**, *n.* One who resuscitates.

**RETAIL**, *v. t.* [Fr. *retailer*; re and *tailer*, to cut; It. *ritagliare*.] 1. To sell in small quantities or parcels, from the sense of cutting or dividing; opposed to *selling by wholesale*; as, to *retail* cloth or groceries.—2. To sell at second hand.—3. To tell in broken parts; to tell to many; as, to *retail* slander or idle reports.

**RE'TAIL**, or **RE'TAIL'**, *n.* The sale of commodities in small quantities or parcels, or at second hand.

**RE'TAILED**, *pp.* Sold in small quantities.

**RE'TAILER**, *n.* One who sells goods by small quantities or parcels.

**RE'TAILING**, *ppr.* Selling in small quantities.

**RE'TAILMENT**, *n.* Act of retailing.

**RE'TAIN**, *v. t.* [Fr. *retenir*; L. *retineo*; re and *teneo*, to hold.] 1. To hold or keep in possession; not to lose or part with or dismiss. The memory *retains* ideas which facts or arguments have suggested to the mind.  
They did not like to *retain* God in their knowledge; Rom. i.  
2. To keep, as an associate; to keep from departure.  
Whom I would have *retained* with me; Phil. xiii.  
3. To keep back; to hold.  
An executor may *retain* a debt due to him from the testator. *Blackstone*.  
4. To hold from escape. Some substances *retain* heat much longer than others. Metals readily receive and transmit heat, but do not long *retain* it. Seek cloths that *retain* their colour.  
5. To keep in pay; to hire.  
A Benedictine convent has now *retained* the most learned father of their order to write in its defence. *Addison*.

6. To engage; to employ by a fee paid; as, to *retain* a counsellor.

**RE'TAIN**, *† v. i.* To belong to; to depend on; as, coldness mixed with a somewhat languid relish *retaining* to bitterness. [We now use *Pertain*.]—2. *†* To keep; to continue.

**RE'TAINABLE**, *a.* Capable of being retained.

**RE'TAINED**, *pp.* Held; kept in possession; kept as an associate; kept in pay; kept from escape.

**RE'TAINER**, *n.* One who retains; as an executor, who retains a debt due from the testator.—2. One who is kept in service; an attendant; as, the *retainers* of the ancient princes and nobility.

3. An adherent; a dependant; a hanger on.—4. In *old English law*, a servant, not a domestic, but occasionally attending and wearing his master's livery.

5. Among *lawyers*, a fee given to a counsel to secure his services, or rather, as it has been said, to prevent the opposite side from engaging them. A *special retainer*, is for a particular case which is expected to come on. A *general retainer*, is given by a party desirous of securing a priority of claim on the counsel's services for any case which he may have in any court which that counsel attends. The same word, in its strict legal acceptation, signifies the engagement of an attorney by his client, which enhances the mutual duties implied by law between them.—6. *†* The act of keeping dependants, or being in dependence.

**RE'TAINING**, *ppr.* Keeping in possession; keeping as an associate; keeping from escape; hiring; engaging by a fee.—*Retaining walls*, in *arch.*, walls that are built to retain a bank of earth from slipping down.—*Retaining fee*, a *retainer*,—*whic* see.

**RE'TAKE**, *v. t.* pret. *retook*; *pp.* *retaken*. [re and *take*.] To take again.—2. To take from a captor; to recapture; as, to *retake* a ship or prisoners.

**RE'TAKEN**, *pp.* Taken again; recaptured.

**RE'TAKER**, *n.* One who takes again what has been taken; a recaptor.

**RE'TAKING**, *ppr.* Taking again; taking from a captor.

**RE'TAKING**, *n.* A taking again; recapture.

**RE'TALIATE**, *v. t.* [Low L. *retalio*; re and *talio*, from *talis*, like.] To return like for like; to repay or requite by an act of the same kind as has been received. It is now seldom used except in a bad sense, that is, to return evil for evil; as, to *retaliate* injuries. In war, enemies often *retaliate* the death or inhuman treatment of prisoners, the burning of towns, or the plunder of goods.  
It is unlucky to be obliged to *retaliate* the injuries of authors, whose works are so soon forgotten that we are in danger of appearing the first aggressors. *Swift*.

**RE'TALI'ATE**, *v. i.* To return like for like; as, to *retaliate* upon an enemy.

**RE'TALIATED**, *pp.* Returned, as like for like.

**RE'TALIATING**, *ppr.* Returning like for like.

**RE'TALIA'TION**, *n.* The return of like for like; the doing that to another which he has done to us; requital of evil.—2. In a *good sense*, return of good for good.  
God takes what is done to others as done to himself, and by promise obliges himself to full *retaliation*. *Calamy*.  
[This, according to modern usage, is harsh.]

**RE'TALIATIVE**, *a.* Returning like for like.

**RE'TALIATORY**, *a.* Returning like for like; as, *retaliatory* measures; *retaliatory* edicts.

**RE'TARD**, *v. t.* [Fr. *retarder*; L. *retardo*; re and *tardo*, to delay; *tardus*, slow, late. See **TARGET**.] 1. To diminish the velocity of motion; to hinder; to render more slow in progress; as, to *retard* the march of an army; to *retard* the motion of a ship. The resistance of air *retards* the velocity of a cannon-ball. It is opposed to *accelerate*.—2. To delay; to put off; to render more late; as, to *retard* the attacks of old age; to *retard* a rupture between nations. My visit was *retarded* by business.

**RE'TARD**, *† v. i.* To stay back.

**RE'TARDA'TION**, *n.* The act of abating the velocity of motion; hindrance; the act of delaying; as, the *retardation* of the motion of a ship; the *retardation* of hoary hairs.—*Retardation*, in *physics*, may be considered as the act of hindering the free progress of a body, and ultimately therefore stopping it. It is also used to signify any force tending to diminish the velocity of moving bodies. It arises from the opposition of the medium in which the body moves; or from the friction of the surface upon which it moves, [see **FRICTION**, **RESISTANCE**.] or from the action of gravity which is peculiar to bodies projected upwards.

**RE'TARDED**, *pp.* Hindered in motion; delayed.—*Retarded motion*, that which suffers continual diminution of velocity, as the motion of a body projected upwards. If the diminutions of velocity are equal in equal times, the motion is said to be *uniformly retarded*. The laws of retarded motion are the same as those of accelerated motion, only the order is reversed. [See **ACCELERATION**, **ACCELERATED**.]

**RE'TARDER**, *n.* One that retards, hinders, or delays.

**RE'TARDING**, *ppr.* Abating the velocity of motion; hindering; delaying.

**RE'TARDMENT**, *n.* The act of retarding or delaying.

**RE'TCH**, *v. i.* [Sax. *hræcan*; Dan. *rekher*, to reach, to stretch, to retch, to vomit; the same word as *reach*; the present orthography, *retch*, being wholly arbitrary. See **REACH**.] To make an effort to vomit; to heave; as the stomach; to strain, as in vomiting; properly to *retch*.

**RE'TCHLESS**, careless, is not in use. [See **RECKLESS**.]

**RE'TE'CIOUS**, *a.* Resembling net-work.

**RE'TE'CITION**, *n.* [L. *retectus*, from *retego*, to uncover; re and *tego*, to cover.] The act of disclosing or producing to view something concealed; as, the *retlection* of the native colour of the body.

**RE'TELL**, *v. t.* To tell again.

**RE'TE MUCO'SUM**, *n.* [L. *rete*, a net, and *mucosum*, mucous.] A tissue lying between the *epidermis*, or scarf-skin, and the *cutis vera*, or true skin. It is the seat of the colour of the skin, and is black in the negro.

**RE'TENT**, *n.* That which is retained.

**RE'TEN'TA POSSESSIO'NE**, [L.] In *Scots law*, retaining the possession; said of a person who parts with the property of any thing, while he retains the possession.

**RE'TENTION**, *n.* [Fr. from L. *retentio*, *retineo*; re and *teneo*, to hold.] 1. The act of retaining or keeping.—2. Tho

power of retaining; the faculty of the mind by which it retains ideas.—3. In *med.*, the power of retaining; or that state of contraction in the elastic or muscular parts of the body, by which they hold their proper contents and prevent involuntary evacuations; undue retention of some natural discharge. 4. The act of withholding; restraint. 5.† Custody; confinement.—6. In *law*, the right of withholding a debt, or retaining property until a debt due to the person claiming this right be duly paid.

**RETENTIS**, [L. ablat. plur. of *retentus*.] Things retained. *To be kept in retentis*, to be kept among things retained or reserved for some future purpose. *To lie in retentis*, in *Scots law*, signifies to lie in proof, as the examinations of witnesses, which, in certain cases, are taken before the case has come into court.

**RETENTIVE**, *a.* [Fr. *réentif*.] Having the power to retain; as, a *retentive* memory; the *retentive* faculty; the *retentive* force of the stomach; a body *retentive* of heat or moisture.

**RETENTIVELY**, † *n.* Restraint.

**RETENTIVELY**, *adv.* In a retentive manner.

**RETENTIVENESS**, *n.* The quality of retention; as, *retentiveness* of memory.

**RETEXTURE**, *n.* A second or new texture.

**RETIA'RIES** or **RETIA'RIÆ**, *n.* [L. from *rete*, a net.] The name given to those spiders which spin a web to entrap their prey.

**RETICENCE**, } *n.* [Fr. *reticence*, from  
**RETICENCY**, } *L. reticentia, reticeo;*  
*re and taceo*, to be silent.] Concealment by silence. In *rhet.*, apostrophe or suppression; a figure by which a person really speaks of a thing, while he makes a show as if he would say nothing on the subject.

**RETICENT**, *a.* Silent.

**RETICLE**, *n.* [L. *reticulum*, from *rete*, a net.]—1. A small net.—2. A contrivance to measure the quantity of an eclipse; a kind of micrometer. [See **RETICULE**.]

**RETICULAR**, *a.* [supra.] Having the form of a net or of net-work; formed with interstices; as, a *reticular* body or membrane.—In *anat.*, the *reticular* body, or *rete mucosum*, is the layer of the skin, intermediate between the cutis and the cuticle, the principal seat of colour in man; the *reticular membrane* is the same as the cellular membrane.

**RETICULATE**, } *a.* [L. *reticulatus*,  
**RETICULATED**, } from *rete*, a net.]  
Netted; resembling net-work; having distinct veins crossing like net-work; as, a *reticulate* coral or petal.—In *zool.*, a surface is said to be *reticulated* when it has a number of minute impressed lines which intersect each other, in various directions, like the meshes of a net.—*Reticulated work* in *arch.*, that wherein the stones are square

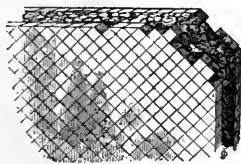

Reticulated Work.

and laid lozenge-wise, resembling the meshes of a net. This species of ma-

sonry was very common among the ancients.—*Reticulated moulding*, in *arch.*, a member composed of a fillet interlaced in various ways like net-work. It is seen chiefly in buildings in the



Reticulated Moulding.

Norman style.—*Reticulated ducts*, in *bot.*, those of which the fibre is branched so as to resemble net-work.

**RETICULATES** or **RETICULATA**, *n.* [L. *reticulum*, a net.] A section of Lithophytes, comprehending those in which the polype cells have a reticulated disposition, on the surface of expanded plates.

**RETICULATION**, *n.* Net-work; organization of substances resembling a net.

**RETICULE**, *n.* [supra.] [L. *reticulum*, from *rete*, a net.] In a *telescope*, a net-work of some fine fibres crossing each other at right-angles, and dividing the field of view into a series of small equal squares. It is used for observations on the quantity of the enlightened parts of a luminary during eclipses.—*Reticule* or *reticulum*, in *zool.*, the name of the honey-comb bag, or second cavity of the complex stomach of the ruminant quadrupeds. The term *reticule* is also applied to a well known article, viz., a kind of bag, formerly of net-work, but now of every description of materials, used by ladies for carrying in the hand.

**RETIFORM**, *a.* [L. *retiformis*; *rete*, a net, and *forma*, form.] Having the form of a net in texture; composed of crossing lines and interstices; as the *retiform* coat of the eye.

**RETINA**, *n.* [L. from *rete*, a net.] In *anat.*, one of the coats of the eye, being an expansion of the optic nerve over the bottom of the eye, where the sense of vision is first received.—It resembles fine net-work.

**RETINASPHALT**, or **RETINASPHALTUM**, *n.* A bituminous or resinous substance of a yellowish or reddish brown colour, found in irregular pieces very light and shining. [See **RETINITE**.]  
**RETINITE**, *n.* [Gr. *ῥηίνω*, resin.] Pitchstone; stone of fusible pitch, of a resinous appearance, compact, brown, reddish gray, yellowish, blackish or bluish, rarely homogeneous, and often containing crystals of feldspar and scales of mica. It is found in Bovey coal and fossil wood. It is soft and brittle, melts when placed on hot-iron, smokes, and afterward burns with a bright flame, emitting a fragrant odour. It appears to be intermediate between resin and bitumen. It is the pechstein porphyry or obsidian of the Germans. It is called also retinasphalt.

**RETINITIS**, *n.* [L. from *retina*.] Inflammation of the retina.

**RETINOID**, *a.* [Gr. *ῥηίνω*, a resin, and *ειδος*, likeness.] Resin-like, or resiniform; resembling a resin without being such.

**RETINUE**, *n.* [Fr. *retinue*, from *retenir* to retain, L. *retineo*; *re* and *teneo*, to hold.] The attendants of a prince or distinguished personage, chiefly on a journey or an excursion; a train of persons.

**RETIRADE**, *n.* [Fr. from *retirer*, to withdraw; Sp. *retirada*, a retreat.] In *fort.*, a kind of retrenchment in the body of a bastion or other work, which is to be disputed inch by inch, after the defences are dismantled. It usually consists of two faces, which make a re-entering angle.

**RETIRE**, *v. i.* [Fr. *retirer*; *re* and *tirer*, to draw.] 1. To withdraw; to retreat; to go from company or from a public place into privacy; as, to *retire* from the world; to *retire* from notice.—2. To retreat from action or danger; as, to *retire* from battle.—3. To withdraw from a public station.—4. To break up, as a company or assembly. The company *retired* at eleven o'clock.—5. To depart or withdraw for safety or for pleasure. Men *retire* from the town in summer for health and pleasure.—6. To recede; to fall back. The shore of the sea *retires* in bays and gulfs.

**RETIRE**, *v. t.* To withdraw; to take away.

He *retired* himself, his wife and children into a forest. *Sidney*.

As when the sun is present all the year,  
And never doth *retire* his golden ray.

*Davies*.

[This transitive use of *retire* is now obsolete.]

**RETIRE**, † *n.* Retreat; recession; a withdrawing.—2.† Retirement; place of privacy.

**RETIRED**, *a.* Secluded from much society or from public notice; private. He lives a *retired* life; he has a *retired* situation.—2. Secret; private; as, *retired* speculations.—3. Withdrawn.—*Retired flank*, in *fort.*, a flank having an arc of a circle with its convexity turned towards the place.—*Retired list*, a list in the ordnance and marine establishment on which superannuated and deserving officers are placed.

**RETIREDLY**, *adv.* In solitude or privacy.

**RETIREDNES**, *n.* A state of retirement; solitude; privacy or secrecy.

**RETIREMENT**, *n.* The act of withdrawing from company or from public notice or station.—2. The state of being withdrawn; as, the *retirement* of the mind from the senses.—3. Private abode; habitation secluded from much society or from public life. Caprea had been the *retirement* of Augustus.

*Addison*.

*Retirement* is as necessary to me as it will be welcome. *Washington*.

4. Private way of life. *Retirement*, rural quiet, friendship, books, Progressive virtue, and approving heaven. *Thomson*.

**RETIRING**, *ppr.* Withdrawing; retreating; going into seclusion or solitude.—2. *a.* Reserved; not forward or obtrusive; as, *retiring* modesty; *retiring* manners.

**RETOLD**, *pret.* and *pp.* of *Retell*; as, a story *retold*.

**RETORT**, *v. t.* [L. *retortus, retorqueo*; *re* and *torqueo*, to throw.] 1. To throw back; to reverbate.

And they *retort* that heat again

To the first giver. *Shak.*

2. To return an argument, accusation, censure, or incivility; as, to *retort* the charge of vanity.

He pass'd through hostile scorn;

And with *retorted* scorn, his back he turn'd.

*Milton*.

3. To bend or curve back; as, a *retorted* line.

**RETORT**, *v. i.* To return an argument

or charge; to make a severe reply. He *retorted* upon his adversary with severity.

**RETORT**, *n.* A censure or incivility returned; the return of an argument, charge, or incivility in reply; as, the *retort* courteous.—2. In *chem.*, a globular vessel with a long neck, employed in a variety of distillations. It is generally made of glass or earthenware, and sometimes is provided with a stopper,



Retort.

so placed above the bulb as to enable substances to be introduced into it without soiling the neck; in this case it is called a *tubulated retort*. A receiver is usually annexed to it, for the purpose of collecting the products of distillation.

**RETORT'ED**, *pp.* Returned; thrown back; bent back. In *her.*, serpents wreathed one in another, or fretted in the form of a true love knot, are said to be *retorted*.

**RETORT'ER**, *n.* One that retorts.  
**RETORT'ING**, *ppr.* Returning; throwing back.

**RETORT'ION**, *n.* The act of retorting.  
**RETORTIVE**, *a.* Containing retort.

**RETOSS'**, *v. t.* [*re* and *toss*.] To toss back.

**RETOSS'ED**, *pp.* Tossed back.  
**RETOSS'ING**, *ppr.* Tossing back.

**RETOUCH**, *v. t.* (*retouch*.) [*re* and *touch*.] To improve by new touches; as, to *retouch* a picture, a statue, or an essay.

**RETOUCH**, *n.* (*retouch*.) In *painting* and *sculpt.*, the reapplication of the master's hand to a work which he had before considered in a finished state.

**RETOUCHED**, *pp.* (*retouch*'ed.) Touched again; improved by new touches.

**RETOUCHING**, *ppr.* (*retouch*'ing.) Improving by new touches.

**RETOUR**, *n.* [*Fr.* a return.] In *Scots law*, an extract from Chancery of the service of an heir to his ancestor.—*Retoured duty*, the valuation, both new and old, of lands expressed in the *retour*, to the Chancery, when any one is returned or served heir.

**RETRACE**, *v. t.* [*Fr.* *retracer*; *re* and *tracer*, to trace.] 1. To trace back; to go back in the same path or course; as, to *retrace* one's steps; to *retrace* one's proceedings.—2. To trace back, as a line.

Then if the line of Turnus you *retrace*,  
He springs from Inachus of Argive race.

*Dryden.*

3. In *painting*, &c., to renew the outline of a drawing; to make a tracing from a tracing.

**RETRACED**, *pp.* Traced back.  
**RETRACING**, *ppr.* Tracing back.

**RETRACT**, *v. t.* [*Fr.* *retracter*; *Lat.* *retractus*, *retraho*; *re* and *traho*, to draw.] 1. To recall, as a declaration, words, or saying; to disavow; to recant; as, to *retract* an accusation, charge, or assertion.

I would as freely have *retracted* the charge of idolatry, as I ever made it.

*Stillingfleet.*

2. To take back; to rescind. [*Little used*.]—3. To draw back, as claws.

**RETRACT'**, *v. i.* To take back; to

unsay; to withdraw concession or declaration.

She will, and she will not; she grants, denies, Consents, *retracts*, advances, and then flies.

*Granville.*

**RETRACT**, *n.* Among *horsemen*, the prick of a horse's foot in nailing a shoe.

**RETRACT'ABLE**, *a.* That may be retracted or recalled.

**RETRACT'ATE**, *v. t.* To retract; to recant.

**RETRACT'ATION**, *n.* [*Fr.* from *L.* *retractatio*.] The recalling of what has been said; recantation; change of opinion declared.

**RETRACT'ED**, *pp.* Recalled; recanted; disavowed; drawn back. In *her.*, an epithet for charges when borne one shorter than another.

**RETRACT'IBLE**, *a.* That may be drawn back; retractile.

**RETRACT'ILE**, *a.* Capable of being drawn back; as the claws of feline animals.

**RETRACT'ING**, *ppr.* Recalling; disavowing; recanting.

**RETRACT'ION**, *n.* [*from retract*.] The act of withdrawing something advanced, or changing something done.—2. Recantation; disavowal of the truth of what has been said; declaration of change of opinion.—3. Act of withdrawing a claim.

Other men's insatiable desire of revenge hath beguiled church and state of the benefit of my *retractions* or concessions.

*K. Charles.*

**RETRACT'IVE**, *a.* Withdrawing; taking from.

**RETRACT'IVE**, *n.* That which withdraws or takes from.

**RETRACT'IVELY**, *adv.* By retraction or withdrawing.

**RETRACT'OR**, *n.* [*L.*] A muscle, the office of which is to retract or draw back the part into which it is inserted.

**RETRACT'†**, *n.* Retreat. [*See* *RETREAT*.]

**RETRAIT**, *† n.* [*It.* *ritratto*, from *ritrarre*, to draw.] A cast of countenance; a drawing; a touch, as of a painter's pencil; a picture.

**RETRAX'IT**, *n.* [*L.* *retraho*, *retraxi*.] In *law*, the withdrawing or open renunciation of a suit in court, by which the plaintiff loses his action.

**RETREAD**, *v. i.* To tread again.

**RETREAT**, *n.* [*Fr.* *retraite*, from *retraire*; *re* and *traire*, to draw; *L.* *retractus*, *retraho*; *re* and *traho*; *It.* *ritratta*.] 1. The act of retiring; a withdrawing of one's self from any place.

But beauty's triumph is well timed *retreat*.

*Pope.*

2. Retirement; state of privacy or seclusion from noise, bustle, or company.

Here in the calm still mirror of *retreat*.

*Pope.*

3. Place of retirement or privacy.

He built his son a house of pleasure... and spared no cost to make it a delicious *retreat*.

*L' Estrange.*

4. Place of safety or security.

That pleasing shade they sought, a soft *retreat*

From sudden April showers, a shelter from the heat.

*Dryden.*

5. In *milit. affairs*, the retiring of an army or body of men from the face of an enemy or from any ground occupied to a greater distance from the enemy, or from an advanced position. A *retreat* is properly an orderly march, in which circumstance it differs from a *flight*.—6. The withdrawing of a ship

or fleet from an enemy; or the order and disposition of ships declining an engagement.—7. A signal given in the army or navy, by the beat of a drum or the sounding of trumpets, at sunset, or for retiring from exercise or from action.—8. In a *garden*, an arbour, a nook, or recess, formed either for pleasure or convenience.—9. In *masonry*, a counterfort or buttress.

**RETREAT**, *v. i.* To retire from any position or place.—2. To withdraw to a private abode or to any secluded situation.—3. To take shelter; to retire to a place of safety or security; as, to *retreat* into a den or into a fort.—4. To move back to a place before occupied; to retire.

The rapid currents drive,  
Toward the *retreating* sea, their furious drive.

*Milton.*

5. To retire from an enemy or from any advanced position.

**RETREATED**, *pp.* Retired; apart. [*Retreated*, as a passive participle, though used by Milton, is not good English.]

**RETRENCH'**, *v. t.* [*Fr.* *retrancher*; *re* and *trancher*, to cut; *It.* *trincea*, a trench; *trincerare*, to intrench; *trinciare*, to carve; *W. trycu*, to cut.] 1. To cut off; to pare away.

And thy exuberant parts *retrench*. *Denham.*

2. To lessen; to abridge; to curtail; as, to *retrench* superfluities or expenses.

—3. To confine; to limit. [*Not proper*.] In *milit. affairs*, to furnish with a retrenchment; as, to *retrench* bastions.

**RETRENCH'**, *v. i.* To live at less expense. It is more reputable to *retrench* than to live embarrassed.

**RETRENCH'ED**, *pp.* Cut off; curtailed; diminished; fortified.

**RETRENCH'ING**, *ppr.* Cutting off; curtailing.

**RETRENCH'ING**, *n.* A curtailing; an omission.

**RETRENCH'MENT**, *n.* [*Fr.* *retranchement*; *Sp.* *atrincheramiento*.] 1. The act of lopping off; the act of removing what is superfluous; as, the *retrenchment* of words or lines in a writing.—2. The act of curtailing, lessening, or abridging; diminution; as, the *retrenchment* of expenses.—3. In *milit. affairs*, any work raised to cover a post and fortify it against an enemy; such as fascines, gabions, sand bags, and the like.

Numerous remains of Roman *retrenchments*, constructed to cover the country.

*D'Anville, Trans.*

**RETRIB'UTE**, *v. t.* [*Fr.* *retribuer*; *L.* *retribuo*; *re* and *tribuo*, to give or bestow.] To pay back; to make payment, compensation, or reward in return; as, to *retribute* one for his kindness; to *retribute* to a criminal what is proportionate to his offence.

**RETRIB'UTED**, *pp.* Paid back; given in return; rewarded.

**RETRIB'UTER**, *n.* One that makes retribution.

**RETRIB'UTING**, *ppr.* Requiring; making repayment; rewarding.

**RETRIBU'TION**, *n.* [*Fr.*] Repayment; return accommodated to the action; reward; compensation.

In good offices and due *retributions*, we may not be pinching and niggardly. *Hall.*

2. A gratuity or present given for services in the place of a salary.—3. The distribution of rewards and punishments at the general judgment.

It is a strong argument for a state of *retribution* hereafter, that in this world virtuous persons are very often unfortunate, and vicious persons prosperous. *Spectator.*

RETROFRUCTIVE, } *a.* Repaying; re-  
RETROFRUCTORY, } warding for good  
deeds, and punishing for offences; as,  
*retrofructive justice.*

RETRIEVABLE, *a.* [from *retrieve*.]  
That may be retrieved or recovered.

RETRIEVABLENESS, *n.* State of  
being retrievable.

RETRIEVABLY, *adv.* In a retrievable  
manner.

RETRIEVAL, } *n.* Act of re-  
RETRIEVEMENT, } trieval.

RETRIEVE, *v. t.* [Fr. *retrouver*, to  
find again; It. *ritrovare*. See *TROVER*.]

1. To recover; to restore from loss or  
injury to a former good state; as, to  
*retrieve* the credit of a nation; to *re-  
trieve* one's character; to *retrieve* a  
decayed fortune.—2. To repair.

Accept my sorrow, and *retrieve* my fall.  
*Prior.*

3. To regain.

With late repentance now they would  
*retrieve*

The bodies they forsook, and wish to live.  
*Dryden.*

4. To recal; to bring back; as, to *retrieve*  
men from their cold trivial conceits,  
RETRIEVE, } *n.* A seeking again; a  
discovery.

RETRIEVED, *pp.* Recovered; repaired;  
regained; recalled.

RETRIEVER, *n.* One who retrieves.—  
2. A kind of pointer dog, useful in  
fetching dead or wounded game.

RETRIEVING, *ppr.* Recovering; re-  
pairing; recalling.

RETRIM, *v. t.* To trim again.

RETRO, *a.* A prefix in words from the  
Latin, signifying backward or back.

RETROACT, *v. i.* To act in opposi-  
tion or in return.

RETROACTION, *n.* [L. *retro*, back-  
ward, and *action*.] 1. Action returned,  
or action backward.—2. Operation on  
something past or preceding.

RETROACTIVE, *a.* [Fr. *retroactif*; L.  
*retro*, backward, and *active*.] Operat-  
ing by returned action; affecting what  
is past; retrospective.—A *retroactive  
law* or *statute* is one which operates to  
affect, make criminal, or punishable,  
acts done prior to the passing of the law.

RETROACTIVELY, *adv.* By returned  
action or operation; by operating on  
something past.

RETROCEDE, *v. i.* [L. *retro*, back,  
and *cedo*, to give; Fr. *retroceder*.] To  
go back; to give place.

RETROCEDED, *pp.* Gone back.

RETROCEDENT, *a.* A term applied  
in medicine to those diseases which  
move about from one part of the body  
to another; as, *retrocedent* cough, when  
it leaves the toe for the stomach.

RETROCEDING, *ppr.* Going back.

RETROCESION, *n.* The act of going  
back. In *Scots law*, a term signifying  
the reconveyance of any right by an  
assignee back into the person of the  
cedent, who thus recovers his former  
right by becoming the assignee of his  
own assignee.—*Retrocission of the  
equinoxes.* [See *PRECSSION*.]

RETRODUCTION, *n.* [L. *retroduco*;  
*retro*, back, and *duco*, to lead.] A  
leading or bringing back.

RETROFLEX, } *a.* [L. *retro*,  
RETROFLECTED, } back, and *flex-*  
*us*, bent.] In *bot.*, bent this way and that,  
or in different directions, usually in a  
distorted manner; as, a *retroflex* branch.

RETROFRACT, } *a.* [L. *retro*,  
RETROFRACTED, } back, and *fract-*  
*us*, broken.] Reduced to hang down  
as it were by force so as to appear as

if broken; as, a *retrofract* peduncle.  
Bent back toward its insertion, as if it  
were broken.

RETROGRADATION, *n.* [Fr. See  
*RETROGRADE*.] 1. The act of moving  
backward; the act of moving from east  
to west, or contrary to the order of  
the signs; applied to the apparent  
motion of the planets.—2. A moving  
backward; decline in excellence.

RETROGRADE, *a.* [Fr. from L. *retro-*  
*gradior*; *retro*, backward, and *gradior*,  
to go.] 1. Going or moving backward.

—2. In *astr.*, apparently moving back-  
ward and contrary to the order of the  
signs. It is opposed to *direct*. In  
*astr.*, all motions from east to west are  
retrograde; thus, the apparent motions  
of the heavenly bodies are *retrograde*,  
and the earth's diurnal motion, which  
causes these apparent motions, is *direct*.  
—3. Declining from a better to a worse  
state.

RETROGRADE, *v. i.* [Fr. *retrograder*;  
L. *retrogradior*; *retro* and *gradior*, to  
go.] To go or move backward.

RETROGRESSION, *n.* The act of  
going backward. In *astr.*, the same as  
*retrogradation*.

RETROGRESSIVE, *a.* Going or mov-  
ing backward; declining from a more  
perfect to a less perfect state.

Geography is at times *retrogressive*.

*Pinkerton.*

RETROGRESSIVELY, *adv.* By going  
or moving backward.

RETROMINGENCY, *n.* [L. *retro*, back-  
ward, and *mingo*, to discharge urine.]  
The act or quality of discharging the  
contents of the bladder backward.

RETROMINGENT, *a.* Discharging  
the urine backward.

RETROMINGENT, *n.* In *zool.*, an  
animal that discharges its urine back-  
ward. The *retromingents* are a division  
of animals whose characteristic is that  
they discharge their urine backward,  
both male and female.

RETROPULSIVE, *a.* [L. *retro*, back,  
and *pulsus*, pello, to drive.] Driving  
back; repelling.

RETRORS'E, *a.* [L. *retrorsus*, from  
*retro*, backwards, and *versus*, a turning  
about.] Turned backwards.

RETRORS'ELY, *adv.* (retrors'ly.) [L.  
*retrorsum*, backward.] In a backward  
direction; as, a stem *retrorsely* aculeate,  
or a leaf *retrorsely* sinuate.

RETROSPECT, } *v. i.* To look back;  
to affect what is past.

RETROSPECT, *n.* [L. *retro*, back, and  
*specio*, to look.] A looking back on  
things past; view or contemplation of  
something past. The *retrospect* of a  
life well spent affords peace of mind in  
old age.

RETROSPECTION, *n.* The act of  
looking back on things past.—2. The  
faculty of looking back on past things.

RETROSPECTIVE, *a.* Looking back  
on past events; as, a *retrospective* view.  
—2. Having reference to what is past;  
affecting things past. A penal statute  
can have no *retrospective* effect or  
operation.

RETROSPECTIVELY, *adv.* By way  
of retrospect.

RETROVERSION, *n.* A turning or  
falling backward; as, the *retroversion*  
of the uterus.

RETROVERT, *v. t.* To turn back.

RETROVERTED, *a.* [L. *retro*, back,  
and *verto*, to turn.] Turned back.

RETRUDE, *v. t.* [L. *trudo*; *re* and  
*trudo*, to thrust.] To thrust back.

RETRUDED, *pp.* Thrust back.

RETRUDING, *ppr.* Thrusting back.

RETTING, *n.* A corruption of the term  
*rotting*; as, the *retting* of flax.

RETUND, } *v. t.* [L. *retundo*; *re* and  
*tundo*, to beat.] To blunt; to turn;  
as, an edge; to dull; as, to *retund* the  
edge of a weapon.

RETUND'ATED, *pp.* Blunted or turned  
at the edges.

RETUND'ED, *pp.* Blunted; turned, as  
an edge.

RETURN, } *v. i.* [Fr. *retourner*; *re* and  
*tourner*, to turn, L. *torno*.] 1. To come  
or go back to the same place. The  
gentleman goes from the country to  
London and *returns*, or the citizen of  
London rides into the country and  
*returns*. The blood, propelled from the  
heart, passes through the arteries to  
the extremities of the body, and *returns*  
through the veins. Some servants are  
good to go on errands, but not good to  
*return*.—2. To come to the same state;  
as, to *return* from bondage to a state  
of freedom.—3. To answer.

He said, and thus the queen of heaven re-  
turn'd. *Pope.*

4. To come again; to revisit.

Thou to mankind

Be good and friendly still, and oft *return*.  
*Milton.*

5. To appear or begin again after a  
periodical revolution.

With the year

Seasons *return*, but not to me *returns*  
Day. *Milton.*

6. To show fresh signs of mercy.

*Return*, O Lord, deliver my soul; Ps. vi.

To *return* to God, to *return* from wicked-  
ness, to repent of sin or wandering from  
duty.

RETURN, } *v. t.* To bring, carry, or send  
back; as, to *return* a borrowed book;  
to *return* a hired horse.—2. To repay;  
as, to *return* borrowed money.—3. To  
give in recompense or requital.

In any wise, *return* him a trespass-offer-  
ing; 1 Sam. vi.

The Lord will *return* thy wickedness  
upon thy own head; 1 Kings ii.

4. To give back in reply; as, to *return*  
an answer.—5. To tell, relate, or com-  
municate.

And Moses *returned* the words of the  
people to the Lord; Exod. xix.

6. To retort; to recriminate.

If you are a malicious reader, you *return*  
upon me, that I affect to be thought more  
impartial than I am. *Dryden.*

7. To render an account, usually an  
official account, to a superior. Officers  
of the army and navy *return* to the  
commander the number of men in com-  
panies, regiments, &c.; they *return*  
the number of men sick or capable of  
duty; they *return* the quantity of  
ammunition, provisions, &c.—8. To  
render back to a tribunal or to an  
office; as, to *return* a writ or an execu-  
tion.—9. To report officially; as, an  
officer *returns* his proceedings on the  
back of a writ or precept.—10. To  
send; to transmit; to convey.

Instead of a ship, he should levy money  
and *return* the same to the treasurer for  
His Majesty's use. *Clarendon.*

RETURN, } *n.* The act of coming or  
going back to the same place.  
Takes little journeys and makes quick re-  
turns. *Dryden.*

2. The act of sending back; as, the  
*return* of a borrowed book or of money  
lent.—3. The act of putting in the  
former place.—4. Retrogression; the  
act of moving back.—5. The act or

process of coming back to a former state; relapse; as, the *return* of health; the *return* of a disease.—6. Revolution; a periodical coming to the same point; as, the *return* of the sun to the tropic of Cancer.—7. Periodical renewal; as, the *return* of the seasons or of the year.—8. Repayment; reimbursement in kind or in something equivalent, for money expended or advanced, or for labour. One occupation gives quick *returns*; in others, the *returns* are slow. The *returns* of the cargo were in gold. The farmer has *returns* in his crops.—9. Profit; advantage.

From these few hours we spend in prayer, the *return* is great. *Taylor.*

10. Remittance; payment from a distant place.—11. Repayment; retribution; requital.

Is no *return* due from a grateful breast? *Dryden.*

12. Act of restoring or giving back; restitution.—13. In *arch.*, either of the adjoining sides of the front of a house or ground plot, is called a *return* side. Also, when two planes meet at an angle, the one is said to *return* in regard to the other, and if mouldings are continued along both, they are in like manner said to be *return* mouldings.

—14. In *law*, the rendering back or delivery of a writ, precept, or execution, to the proper officer or court; or the certificate of the officer executing it, indorsed. We call the transmission of the writ to the proper officer or court, a *return*; and we give the same name to the certificate or official account of the officer's service or proceedings. The sheriff or his subordinate officers make *return* of all writs and precepts. We use the same language for the sending back of a commission with the certificate of the commissioners. The return of members of parliament is, strictly speaking, the return by the sheriff, or other returning officer, of the writ addressed to him, certifying the election in pursuance of it.—15. A day in bank. The day on which the defendant is ordered to appear in court, and the sheriff is to bring in the writ and report his proceedings, is called the *return* of the writ.—16. An official report or account, as the *return* of the population of Great Britain—the *return* of the number of men in the army and navy; the *return* made to Parliament on the state of education.—*Return of cattle*, &c., a term applied to the restoration of cattle, &c., distrained, to the party by whom they were distrained, after it has been ascertained that the distress was rightfully taken. The restoration of the cattle, &c., distrained, to the owner is called a *replevin*.—*Returns of a mine in fort.*, the turnings and windings of a gallery leading to a mine.—*Returns of a trench*, the various turnings and windings which form the lines of a trench.—*Clause of return*, in *Scots law*, [see under *CLAUSE*.]

RETURN'ABLE, *a.* That may be returned or restored.—2. In *law*, that is legally to be returned, delivered, given or rendered; as, a writ or precept *returnable* at a certain day; a verdict *returnable* to the court; an attachment *returnable* to the king's bench.

RETURN'-DAY, *n.* The day when the defendant is to appear in court and the sheriff is to return the writ and his proceedings.

RETURN'ED, *pp.* Restored; given or

sent back; repaid; brought or rendered to the proper court or officer.

RETURN'ER, *n.* One who returns; one that repays or remits money.

RETURN'ING, *ppr.* Giving, carrying or sending back; coming or going back; making report.

RETURN'ING-OFFICER, *n.* The officer whose duty it is to make returns of writs, precepts, juries, &c.

RETURN'LESS, *a.* Admitting no return. [*Little used.*]

RETUSE, *a.* [L. *retusus*, *retundo.*] In *bot.*, a *retuse* leaf is one ending in a blunt sinus, or whose apex is blunt. This term is applied also to the seed. It is applied also in *conchology* to shells ending in an obtuse sinus.

REUNION, *n.* [Fr.] A second union; union formed anew after separation or discord; as, a *reunion* of parts or particles of matter; a *reunion* of parties or sects.—2. In *med.*, union of parts separated by wounds or accidents.—3. A meeting or assembly.

REUNITE, *v. t.* [*re* and *unite.*] To unite again; to join after separation.—2. To reconcile after variance.

REUNITE, *v. i.* To be united again; to join and cohere again.

REUNITED, *pp.* United or joined again; reconciled.

REUNITING, *ppr.* Uniting again; reconciling.

REUNITION, *n.* A second uniting. [*Rarely used.*]

REURGE, *v. t.* To urge again.

REUSSITE, *n.* [from *Reuss*, the place where it is found.] A salt found in the form of a mealy efflorescence, or crystallized in flat six-sided prisms, and in acicular crystals.

REVA'CINATE, *v. t.* To vaccinate a second time.

REVA'CINATED, *pp.* Vaccinated a second time.

REVA'CINATING, *ppr.* Vaccinating a second time.

REVACCINA'TION, *n.* A second vaccination.

REVAL'UATION, *n.* A second valuation.

REVE, *n.* [Sax. *gerefa.*] The bailiff of a franchise or manor. It is usually written *Reeve*.

REVEAL, *v. t.* [Fr. *reveler*; L. *revelo*; *re* and *velo*, to veil.] 1. To disclose; to discover; to show; to make known something before unknown or concealed; as, to *reveal* secrets.—2. To disclose, discover, or make known from heaven. God has been pleased to *reveal* his will to man.

The wrath of God is *revealed* from heaven against all ungodliness and unrighteousness of men; Rom. i.

REVEAL,† *n.* A revealing; disclosure.

REVEALABLE, *a.* That can be revealed.

REVEALABLENESS, *n.* State of being revealable.

REVEALED, *pp.* Disclosed; discovered; made known; laid open.

REVEALER, *n.* One that discloses or makes known.—2. One that brings to view.

REVEALING, *ppr.* Disclosing; making known; discovering.

REVEALMENT, *n.* The act of revealing. [*Little used.*]

REVEALS, *n.* In *arch.*, [see *REVEL.*]

REVEILLE, (ravail'), } *n.* [Fr. *re-*

REVEILLE', (ravaille yai), } *veiller*, to awake; *re* and *veiller*, to watch; contracted from L. *vigilo*. See *WATCH*.]

In *military affairs*, the beat of drum

about break of day, to give notice that it is time for the soldiers to rise and for the sentinels to forbear challenging. *REVEL*, *v. i.* [D. *revelen*, to rave, from the root of L. *rabio*, *rabio*, to rage, whence *rabies*, *rabid*; Dan. *raaben*, to bawl, to clamour; Sw. *ropas*; allied to *rove*, *rapio*; Ir. *rioboid*, a spendthrift; *rioboidim*, to riot or revel.] 1. To feast with loose and clamorous merriment; to carouse; to act the bacchanalian.

Antony, that *revels* long o' nights. *Shak.*  
2. To move playfully or without regularity.

REVEL, *n.* A feast with loose and noisy jollity.

Some men ruin the fabric of their bodies by incessant *revels*. *Rambler.*

*Master of the revels*, or *Lord of misrule*, an officer formerly attached to royal and other distinguished houses, whose duty it was to preside over the Christmas diversions. In the royal household this officer was rendered permanent in the reign of Henry VIII. It continued till about the end of the 17th century.—*Revel* or *Reveal*, (pronounced *revel*), in *arch.*, the side of an opening for a door or window, between the frame work and the face of the wall. In Scotland it is sometimes called *Rybat* head.

REVEL', *v. t.* [L. *revello*; *re* and *vello*, to pull.] To draw back; to retract; to make a revulsion.

REVELA'TION, *n.* [Fr. from L. *revelatus*, *revelo*. See *REVEAL*.] 1. The act of disclosing or discovering to others what was before unknown to them; appropriately, the disclosure or communication of truth to men by God himself, or by his authorized agents, the prophets and apostles.

How that by *revelation* he made known to me the mystery, as I wrote before in few words; Eph. iii; 2 Cor. xii.

2. That which is revealed; appropriately, the sacred truths which God has communicated to man for his instruction and direction. The *revelations* of God are contained in the Old and New Testament.—3. The Apocalypse; the last book of the sacred canon, containing the prophecies of St. John.

REVELLED, *pp.* Feasted with noisy merriment; caroused.

REVEL'ENT, *a.* [L. *revello*, to pull, or tear away, out, or off.] Causing revulsion.

REVELLER, *n.* [See *REVEL*.] One who feasts with noisy merriment.

REVELLING, *ppr.* Feasting with noisy merriment; carousing.

REVELLING, *n.* A feasting with noisy merriment; revelry; Gal. v; 1 Pet. iv.

REVEL'LED, *pp.* Drawn back; retracted.

REVELMENT, *n.* Act of revelling.

REVEL'-ROUT, *n.* [See *ROUT*.] Tumultuous festivity.—2. A mob; a rabble tumultuously assembled; an unlawful assembly.

REVELRY, *n.* Noisy festivity; clamorous jollity.

REVEN'DICATE, *v. t.* [Fr. *revendiquer*; *re* and *vendiquer*, to claim or challenge, L. *vindicco*. See *VINDICATE*.] To reclaim what has been taken away; to claim to have restored what has been seized.

Should some subsequent fortunate revolution deliver it from the conqueror's yoke, it can *revendicate* them. *Vattel*, *Trans.*

REVEN'DICATED, *pp.* Reclaimed; regained; recovered.

**REVEN'DICATING**, *ppr.* Reclaiming; redemanding; recovering.  
**REVEN'DICATION**, *n.* [Fr.] A term of the civil law signifying a claim legally made to recover property, by one claiming as owner.

**REVENGE**, *v. t.* (revenj'.) [Fr. *revenge*, *venger*; *L. vindex, vindico*; *It. vendicare*. See **VINDICATE**.] 1. To inflict pain or injury in return for an injury received.—*Note.* This word and *avenge* were formerly used as synonymous, and it is so used in the common version of the Scripture, and applied to the Supreme Being. "O Lord—*revenge* me of my persecutors;" Jer. xv. In consequence of a distinction between *avenge* and *revenge*, which modern usage has introduced, the application of this word to the Supreme Being appears extremely harsh, irreverent, and offensive. *Revenge* is now used in an ill sense, for the infliction of pain maliciously or illegally; *avenge* for inflicting just punishment.—2. According to *modern usage*, to inflict pain deliberately and maliciously, contrary to the laws of justice and humanity, in return for injury, pain, or evil received; to wreak vengeance spitefully on one who injures or offends. We say, to *revenge* an injury or insult, or with the reciprocal pronoun, to *revenge ourselves* on an enemy or for an injury, that is, to take vengeance or satisfaction.—3. To vindicate by punishment of an enemy.

The gods are just and will *revenge* our cause. *Dryden.*

[According to modern usage, *avenge* should here be substituted for *revenge*.]

**REVENGE**, *n.* (revenj'.) [Fr. *revenge*; *Arm. revanch*.] 1. Return of an injury; the deliberate infliction of pain or injury on a person in return for an injury received from him.—2. According to *modern usage*, a malicious or spiteful infliction of pain or injury, contrary to the laws of justice and Christianity, in return for an injury or offence. *Revenge* is dictated by *passion*; *vengeance* by *justice*.—3. The passion which is excited by an injury done or an affront given; the desire of inflicting pain on one who has done an injury; as, to glut *revenge*. *Revenge*, as the word is now understood, is always contrary to the precepts of Christ.

The indulgence of *revenge* tends to make men more savage and cruel. *Kames.*

**REVENG'ED**, *pp.* Punished in return for an injury; spitefully punished. The injury is *revenged*.

**REVENGE'FUL**, *a.* Full of revenge or a desire to inflict pain or evil for injury received; spiteful; malicious; wreaking revenge.

If thy *revengeful* heart can not forgive. *Shak.*

2. Vindictive; inflicting punishment. May my hands Never brandish more *revengeful* steel. *Shak.*

**REVENGE'FULLY**, *adv.* By way of revenge; vindictively; with the spirit of revenge.

**REVENGE'FULNESS**, *n.* (revenj'fulness.) Vindictiveness.

**REVENGE'LESS**, *a.* Unrevenged.

**REVENGE'MENT**, *n.* Revenge; return of an injury. [*Little used.*]

**REVENG'ER**, *n.* One who revenges; one who inflicts pain on another spitefully in return for an injury.—2. One who inflicts just punishment for injuries. [*Less proper.*]

**REVENG'ING**, *ppr.* Inflicting pain or

evil spitefully for injury or affront received.—2. Vindicating; punishing.

**REVENG'INGLY**, *adv.* With revenge; with the spirit of revenge; vindictively.

**REVENUE**, *n.* [Fr. *revenu*, from *revenir*, to return. *L. revenio*; *re* and *venio*, to come.] 1. In a *general sense*, the annual rents, profits, interest, or issues of any species of property, real or personal, belonging to an individual or to the public. When used of individuals, it is equivalent to *income*. In modern usage, *income* is applied more generally to the rents and profits of individuals, and *revenue* to those of the state. In the latter case *revenue* is—2. The annual income of a state derived from the taxation, customs, excise, and other sources, and appropriated to the payment of the national expenses. *Royal revenue*, that which the British constitution vests in the sovereign, to support the regal dignity and power.—3. Return; reward; as, a rich *revenue* of praise.—4. A fleshy lump on the head of a deer.

**REVERB'**, *v. t.* To reverberate.

**REVERB'ERANT**, *a.* [L. *reverberans*. See **REVERBERATE**.] Returning sound; resounding; driving back.

**REVERB'ERATE**, *v. t.* [L. *reverbero*; *re* and *verbero*, to beat.] 1. To return, as sound; to send back; to echo; as, an arch *reverberates* the voice.—2. To send or beat back; to repel; to reflect; as, to *reverberate* rays of light.—3. To send or drive back; to repel from side to side; as, flame *reverberated* in a furnace.

**REVERB'ERATE**, *v. i.* To be driven back; to be repelled, as rays of light, or sound.

2. To resound.

And even at hand, a drum is ready brac'd, That shall *reverberate* all as well as thine. *Shak.*

**REVERB'ERATE**, *a.* Reverberant.

**REVERB'ERATED**, *pp.* Driven back; sent back; driven from side to side.

**REVERB'ERATING**, *ppr.* Driving or sending back; reflecting, as light; echoing, as sound.

**REVERBERA'TION**, *n.* [Fr.; from *reverberate*.] The act of driving or sending back; particularly, the act of reflecting light and heat, or repelling sound. Thus we speak of the *reverberation* of the rays of light from an object, the *reverberation* of sound in echoes. In *chem.*, reverberation denotes a circulation of flame, or its return from the top to the bottom of the furnace to produce an intense heat when calcination is required.

**REVERB'ERATORY**, *a.* Returning or driving back; as a *reverberatory* furnace or kiln.

**REVERB'ERATORY**, *n.* A species of air furnace or oven in which a crucible

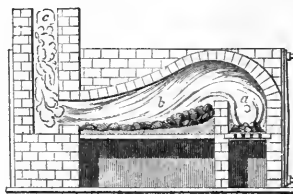

Reverberatory Furnace.

or other object may be exposed to an intense heat without being brought into

actual contact with the fuel. This furnace is divided transversely into two compartments, by a wall of brick-work, extending considerably above the hearth, which is situated in the front or smaller compartment (*a*); the roof is arched so as to reflect or *reverberate* the flame and heated air upon the floor of the other compartment (*b*), on which the object to be heated is placed.

**REVERE**, *v. t.* [Fr. *révérer*; *It. reverire*; *L. revereor*; *re* and *vereor*, to fear.] To regard with fear, mingled with respect and affection; to venerate; to reverence; to honour in estimation.

Marcus Aurelius, whom he rather *revered* as his father than treated as his partner in the empire. *Addition.*

**REVERED**, *pp.* Regarded with fear mingled with respect and affection.

**REVERENCE**, *n.* [Fr. from *L. reverentia*.] 1. Fear mingled with respect and esteem; veneration.

When quarrels and factions are carried openly, it is a sign that the *reverence* of government is lost. *Bacon.*

The fear acceptable to God, is a filial fear, an awful *reverence* of the divine nature, proceeding from a just esteem of his perfections, which produces in us an inclination to his service and an unwillingness to offend him. *Rogers.*

*Reverence* is nearly equivalent to *veneration*, but expresses something less of the same emotion. It differs from *awe*, which is an emotion compounded of fear, dread, or terror, with admiration of something great, but not necessarily implying love or affection. We feel *reverence* for a parent, and for an upright magistrate, but we stand in *awe* of a tyrant. This distinction may not always be observed.—2. An act of respect or obeisance; a bow or courtesy; 2 Sam. ix.—3. A title of the clergy.—4. A poetical title of a father.

**REVERENCE**, *v. t.* To regard with reverence; to regard with fear mingled with respect and affection. We *reverence* superiors for their age, their authority, and their virtues. We ought to *reverence* parents and upright judges and magistrates. We ought to *reverence* the Supreme Being, his word, and his ordinances.

Those that I *reverence*, those I fear, the wise. *Shak.*

They will *reverence* my son; Matt. xxi. Let the wife see that she *reverence* her husband; Eph. v.

**REVERENCED**, *pp.* Regarded with fear, mingled with respect and affection.

**REVERENCER**, *n.* One that regards with reverence.

**REVERENCING**, *ppr.* Regarding with fear mingled with respect and affection.

**REVEREND**, *a.* [Fr. from *L. reverendus*.] 1. Venerable; worthy of reverence; entitled to respect mingled with fear and affection; as, *reverend* and gracious senators.

A *reverend* sire among them came. *Milton.*

2. A title of respect given to the clergy or ecclesiastics. In *England*, deans are *very reverend*; bishops, *right reverend*; and archbishops, *most reverend*. The religious in Catholic countries are styled *reverend fathers*; abbesses, prioresses, &c., *reverend mothers*. In *Scotland*, and also in the *United States*, the clergy are individually styled *reverend*. The principals of the universities, and the moderator of the general assembly

for the time being, are styled *very reverend*; and a synod is styled *very reverend*, and the general assembly, *venerable*.

**REVERENT**, *a.* Expressing reverence, veneration, or submission; as, *reverent words or terms*; a *reverent posture in prayer*; *reverent behaviour*.—2. Submissive; humble; impressed with reverence.

They prostrate fell before him *reverent*.  
*Milton.*

**REVERENTIAL**, *a.* [from *reverence*.] Proceeding from reverence, or expressing it; as, *reverential fear or awe*; *reverential gratitude or esteem*.

Religion...consisting in a *reverential esteem* of things sacred.  
*South.*

**REVERENTIALLY**, *adv.* With reverence, or show of reverence.

**REVERENTLY**, *adv.* With reverence; with respectful regard.

Chide him for faults, and do it *reverently*.  
*Shak.*

2. With veneration; with fear of what is great or terrifying.

So *reverently* men quit the open air,  
When thunder speaks the angry gods abroad.  
*Dryden.*

**REVERER**, *n.* One who reveres or venerates.

**REVERIE**, } (*rev'eree*, or *revere'*).  
**REVERIE'**, } [Fr. *rêverie*, from *rêver*,  
to dream, to rave, to be light-headed.]

1. Properly, a raving or delirium; but its sense, as generally used, is a loose or irregular train of thoughts, occurring in musing or meditation; wild, extravagant conceit of the fancy or imagination.

There are *reveries* and extravagancies which pass through the minds of wise men as well as fools.  
*Addison.*

2. A chimera; a vision.—3. In *med.*, voluntary inactivity of the whole or the greater part of the external senses to the impressions of surrounding objects, during wakefulness.

**REVERING**, *ppr.* Regarding with fear mixed with respect and affection; venerating.

**REVERS'AL**, *a.* [See **REVERSE**.] Intended to reverse; implying reverse.

**REVERS'AL**, *n.* [from *reverse*.] A change or overthrowing; as, the *reversal of a judgment*, which amounts to an official declaration that it is false. So we speak of the *reversal of an attainer* or of an outlawry, by which the sentence is rendered void.

**REVERSE**, *v. t.* (*revers'*). [L. *reversus*, *revertio*; *re* and *vertio*, to turn.] 1. To turn upside down; as, to *reverse a pyramid or cone*.—2. To overturn; to subvert; as, to *reverse the state*.—3. To turn back; as, with swift wheel *reverse*.—4. To turn to the contrary; as, to *reverse the scene*.

Or affections quite *reverse* the soul. *Pope*.  
5. To put each in the place of the other; as, to *reverse the distinctions of good and evil*.—6. In *law*, to overthrow by a contrary decision; to make void; to annul; as, to *reverse a judgment, sentence, or decree*. Judgments are *reversed* by writs of error; and for certain causes, may be *reversed* without such writs.—7. † To recall.

**REVERSE**, † *v. i.* (*revers'*). To return.  
**REVERSE**, *n.* (*revers'*). Change; vicissitude; a turn of affairs; *in a good sense*.

By a strange *reverse* of things, Justinian's law, which for many ages was neglected, now obtains. *Baker*.

2. Change for the worse; misfortune. By an unexpected *reverse* of circum-

stances, an affluent man is reduced to poverty.—3. A contrary; an opposite.

The performances to which God has annexed the promises of eternity, are just the *reverse* of all the pursuits of sense.

*Rogers.*

4. [Fr. *revers*.] The *reverse* of a medal or coin is the second or back surface, opposite to that on which the head or principal figure is impressed, the latter being called the *obverse*.

**REVERSE**, *a.* (*revers'*.) Turned backward; having a contrary or opposite direction; as, the *reverse order or method*.

**REVERS'ED**, *pp.* Turned side for side or end for end; changed to the contrary.—2. In *law*, overthrown or annulled.—3. *In bot.*, respiration; having the upper lip larger and more expanded than the lower; as, a *reversed corol*.—*Reversed leaves*, such as have the lower surface turned upwards.—

*Reversed shell*, in *conchology*, one the volutions of which are the reverse way of the common cork-screw.—4. In *her.*, an epithet for a coat of arms or an escutcheon, turned upside down by way of ignominy, as in the case of a traitor.

**REVERS'EDLY**, *adv.* In a reversed manner.

**REVERSELESS**, *a.* (*revers'less*.) Not to be reversed; irreversible.

**REVERSELY**, *adv.* (*revers'ly*.) On the other hand; on the opposite.

**REVERS'ER**, *n.* In *Scots law*, the proprietor of an estate who has granted a wadset of his lands, and who has a right, on repayment of the money advanced to him, to be replaced in his right.

**REVERS'IBLE**, *a.* That may be reversed; as, a *reversible judgment or sentence*.

**REVERS'ING**, *ppr.* Turning upside down; subverting; turning the contrary way; annulling.

**REVER'SION**, *n.* [Fr. from L. *reversio*.]

1. In a *general sense*, a returning; *appropriately*, in *law*, the returning of an estate to the grantor or his heirs, after a particular estate is ended. Hence,—

2. The residue of an estate left in the grantor, to commence in possession after the determination of the particular estate granted. Thus, when there is a gift in tail, the *reversion of the fee* is, without any special reservation, vested in the donor by act of law. In the *doctrine of annuities*, a *reversion*, or *reversionary annuity*, or *annuity in reversion*, is a payment which is not to be received, or a benefit which does not begin until the happening of some event, as the death of a person now living, or which does not commence till after a certain number of years. Its present value is such a sum as, put out to interest, will provide for the several payments of the annuity or payment, as they become due. It is also called a *deferred annuity*. [See **ANNUITY**.] In the *law of Scotland*, *reversion*, as applied to heritage, is a right of redemption, and is either legal or conventional. The legal reversion is that which is provided by the operation of the law itself. The conventional reversion is that of a wadset or of an heritable bond, where the *reverser*, or the debtor, is entitled to disencumber the estate, or to redeem it.—3. Succession; right to future possession or enjoyment.—

4. In *alge*, reversion of series is a method of expressing the value of an unknown quantity which is involved in an infinite series of terms, by means of another series of terms involving the

powers of the quantity to which the proposed series is equal.

**REVER'SIONARY**, *a.* Pertaining to a reversion, that is, to be enjoyed in succession, or after the determination of a particular estate; as, a *reversionary interest or right*.—*Reversionary annuity*. [See **REVERSION**.]

**REVER'SIONER**, *n.* The person who has a reversion, or who is entitled to lands or tenements, after a particular estate granted is determined.

**REVERT**, *v. t.* [L. *revertio*; *re* and *vertio*, to turn.] 1. To turn back; to turn to the contrary; to reverse.

Till happy chance *revert* the cruel scene.  
*Prior.*

[Instead of *revert*, in this sense, *reverse* is generally used.]—2. To drive or turn back; to reverberate; as, a stream *reverted*.

**REVERT**, *v. i.* To return; to fall back.

—2. In *law*, to return to the proprietor, after the determination of a particular estate. A feud granted to a man for life, or to him and his issue male, on his death or failure of issue male, *reverted* to the lord or proprietor.

**REVERT**, † *n.* In *music*, return; recurrence; antistrophe.

**REVERT'ED**, *pp.* Reversed; turned back. In *her.*, *reverted* or *revertant* signifies flexed and reflexed, or bending in the form of an S. It is sometimes used to express a bending in the manner of the chevron.

**REVERT'ENT**, *n.* A medicine which restores the natural order of the inverted irritative motions in the animal system.

**REVERT'IBLE**, *a.* That may revert or return.

**REVERT'ING**, *ppr.* Turning back; returning.

**REVERT'IVE**, *a.* Changing; reversing.

**REVER'Y**. See **REVERIE**.

**REVEST**, *v. t.* [Fr. *revêtir*; Low L. *revestio*; *re* and *vestio*, to clothe.] 1. To clothe again.—2. To reinvest; to vest again with possession or office; as, to *revest a magistrate with authority*.—3. To lay out in something less fleeting than money; as, to *revest money in stocks*. [But invest is more generally used.]

**REVEST**, *v. i.* To take effect again, as a title; to return to a former owner; as, the title or right *revests* in A. after alienation.

**REVEST'ED**, *pp.* Clothed again; invested anew.

**REVEST'ARY**, or **REVEST'RY**, *n.* [Fr. *revestiaire*, from L. *revestio*.] The place or apartment in a church or temple where the dresses are deposited; now contracted into *vestry*.

**REVEST'ING**, *ppr.* Clothing again; investing anew.

**REVEST'MENT**, *n.* [Fr. *revêtement*, the lining of a ditch, from *revêtir*.] In *fort.*, a strong wall on the outside of a rampart, intended to support the earth.

**REVI'BRATE**, *v. i.* [*re* and *vibrate*.] To vibrate back or in return.

**REVI'BRATION**, *n.* The act of vibrating back.

**REVIC'TION**, † *n.* [L. *re* and *vivo*, *victum*, to live.] Return to life.

**REVIC'TUAL**, *v. t.* (*revit'l*) [*re* and *victual*.] To furnish again with provisions.

**REVIC'TUALLED**, *pp.* (*revit'ld*.) Furnished with victuals again.

**REVIC'TALLING**, *ppr.* (*revit'ling*.) Supplying again with provisions.

**REVIE**, † *v. t.* [*re* and *vie*.] To accede

to the proposal of a stake and to overtop it; *an old phrase at cards.*

REVIE, † *v. t.* To return the challenge of a wager at cards; to make a retort.

REVIEW', *v. t.* [*re and view*; or *Fr. revoir, reu.*] 1. To look back on.—2. To see again.

I shall review Sicilia.

Shak.

3. To view and examine again; to reconsider; to revise; to examine critically; as, to review a manuscript. It is said that Virgil was prevented by death from reviewing the *Æneis*.—4. To retrace.

Shall I the long laborious scene review?  
Pope.

5. To survey; to inspect; to examine the state of any thing, particularly of troops; as, to review a regiment.

REVIEW', *n.* [*Fr. revue, from revoir*; *re and voir, from L. video, to see.*] 1. A second or repeated view; a re-examination; resurvey; as, a review of the works of nature; a review of life.—2. Revision; a second examination with a view to amendment or improvement; as, an author's review of his works.—3. In *milit. affairs*, an examination or inspection of troops under arms, by a general or commander, for the purpose of ascertaining the state of their discipline, equipments, &c.—4. In *literature*, a critical examination of a new publication, with remarks.—5. The name now commonly assumed, by literary usage, for periodical publications, consisting of a collection of critical essays on any subject of public interest, literary, scientific, political, moral, or theological, together with critical examinations of new publications. The management of a *Review* is in the hands of an editor, whose name, however, does not usually appear, the publisher being the party responsible.—*Commission of review*, a commission granted by the king to revise the sentence of the court of delegates.—6. In *Scots law*, the revision of any interlocutor, or decree, or sentence, against which a party has reclaimed or appealed. No judge in the Court of Session is now authorised to review his own decrees or interlocutors.

REVIEWED, *pp.* Resurveyed; re-examined; inspected; critically analyzed.

REVIEWER, *n.* One that reviews or re-examines; an inspector; one that critically examines a new publication, and communicates his opinion upon its merits.

REVIEWING, *ppr.* Looking back on; seeing again; revising; re-examining; inspecting, as an army; critically examining and remarking on.

REVIGORATE, † *v. t.* [*re and vigour.*] To give new vigour to.

REVILE, *v. t.* [*re and vile. Rivilant* is found in the Norman.] To reproach; to treat with opprobrious and contemptuous language.

She revileth him to his face.  
Thou shalt not revile the gods; Exod. xxii.

Blessed are ye when men shall revile you; Matt. v.

REVILE, † *n.* Reproach; contumely; contemptuous language.

REVILED, *pp.* Reproached; treated with opprobrious or contemptuous language.

REVILEMENT, *n.* Reproach; contemptuous language.

REVILER, *n.* One who reviles another; one who treats another with contemptuous language.

REVILING, *ppr.* Reproaching; treating with language of contempt.

REVILING, *n.* The act of reviling or treating with reproachful words; *Is. li.*

REVILINGLY, *adv.* With reproachful or contemptuous language; with opprobrium.

REVINDICATE, *v. t.* To vindicate again; to reclaim; to demand and take back what has been lost.

REVINDICATED, *pp.* Vindicated again; reclaimed.

REVINDICATING, *ppr.* Reclaiming.

REVISAL, *n.* [*from revise.*] Revision; the act of reviewing and re-examining for correction and improvement; as, the *revisal* of a manuscript; the *revisal* of a proof sheet.

REVISE, *v. t.* (*s* as *z.*) [*L. revisus, reviso, to revisit*; *re* and *viso, to see, to visit.*] 1. To review; to re-examine; to look over with care for correction; as, to *revise* a writing; to *revise* a proof sheet.—2. To review, alter, and amend; as, to *revise* statutes.

REVISE, } *n.* [*Fr. réviser.*] Review; re-  
REVISE', } examination.—2. Among  
printers, a second proof sheet; a proof sheet taken after the first correction in order to compare it with the last proof, to see whether all the mistakes marked in it are actually corrected.

REVISED, *pp.* Reviewed; re-examined for correction.

REVISER, } *n.* One that revises or re-  
examines for correction.

REVISING, *ppr.* Reviewing; re-examining for correction.

REVISION, *n.* [*Fr.*] The act of reviewing; review; re-examination for correction; as, the *revision* of a book or writing, or of a proof sheet; a *revision* of statutes.—2. Enumeration of inhabitants.

REVISIONAL, } *a.* Pertaining to  
REVISIONARY, } revision.

REVISIT, *v. t.* (*s* as *z.*) [*Fr. revisiter*; *L. revisito*; *re* and *visito, from viso, to see* or *visit.*] To visit again.

Let the pale sire revisit Thebes. Pope.

2. † To revise; to review.

REVISITATION, *n.* The act of revisiting.

REVISITED, *pp.* Visited again.

REVISITING, *ppr.* Visiting again.

REVISOR, *n.* In *Russia*, one who has taken the number of inhabitants.

REVIVAL, *n.* [*from revive.*] Return, real, or recovery to life from death, or apparent death; as, the *revival* of a drowned person.—2. Return or recall to activity, from a state of languor; as, the *revival* of spirits.—3. Recall, return or recovery from a state of neglect, oblivion, obscurity, or depression; as, the *revival* of letters or learning.—4. Renewed and more active attention to religion; an awakening of men to their spiritual concerns.

REVIVALIST, *n.* A minister of the gospel who is instrumental in producing or who promotes revivals of religion.

REVIVE, *v. t.* [*Fr. revivre*; *L. revivisco*; *re* and *vivo, to live.*] 1. To return to life; to recover life.

The soul of the child came into him again, and he revived; 1 Kings xvii.; Rom. xiv.

2. To recover new life or vigour; to be reanimated after depression.

When he saw the waggons which Joseph had sent to carry him, the spirit of Jacob their father revived; Gen. xlv.

3. To recover from a state of neglect, oblivion, obscurity, or depression. Learning revived in Europe after the middle

ages.—4. In *chem.*, to recover its natural state, as a metal.—*Sin revives*, when the conscience is awakened by a conviction of guilt; Rom. vii.

REVIVE, *v. t.* To bring again to life; to reanimate.—2. To raise from languor, depression, or discouragement; to rouse; as, to *revive* the spirits or courage.—3. To renew; to bring into action after a suspension; as, to *revive* a project or scheme that had been laid aside.—4. To renew in the mind or memory; to recal.

The mind has the power in many cases to *revive* ideas or perceptions, which it has once had.

Locke.

5. To recover from a state of neglect or depression; as, to *revive* letters or learning.—6. To recomfort; to quicken; to refresh with joy or hope.

Wilt thou not revive us again? Ps. lxxxv.

7. To bring again into notice.

Revive the libels born to die. Swift.

8. In *chem.*, to restore or reduce to its natural state or to its metallic state; as, to *revive* a metal after calcination.

REVIVED, *pp.* Brought to life; reanimated; renewed; recovered; quickened; cheered; reduced to a metallic state.

REVIVER, *n.* That which revives; that which invigorates or refreshes; one that redeems from neglect or depression.

REVIVIFICATE, *v. t.* [*Fr. revivifier*; *L. re and vivifico*; *vivus, alive, and facio, to make.*] To revive; to recal or restore to life. [*Little used.*]

REVIVIFICATION, *n.* Renewal of life; restoration of life; or the act of recalling to life. Revivification may take place in many species of animals, and even in some of the more highly developed worms, even after they have been kept in a dry state for an indefinite length of time. When they are again moistened with water they resume their activity, as if restored to life.—2. In *chem.*, the reduction of a metal from a state of combination, to its metallic state.

REVIVIFIED, *pp.* Recalled to life; re-animated.

REVIVIFY, *v. t.* [*Fr. revivifier.*] 1. To recall to life; to reanimate.—2. To give new life or vigour to.

REVIVIFYING, *ppr.* Giving new life or vigour to.

REVIVING, *ppr.* Bringing to life again; reanimating; renewing; recalling to the memory; recovering from neglect or depression; refreshing with joy or hope; reducing to a metallic state.

REVIVING, *n.* Act of re-animating or of renewing.

REVIVINGLY, *adv.* In a reviving manner.

REVIVISCENCE, } *n.* Renewal of life;  
REVIVISCENCY, } return to life.

REVIVISCENT, *a.* Reviving; regaining or restoring life or action.

REVIVOR, *n.* In *law*, the reviving of a suit which is abated by the death of any of the parties. This is done by a bill of *revivor*.

REVOCABLE, *a.* [*Fr. from L. revocabilis. See REVOKE.*] That may be recalled or revoked; that may be repealed or annulled; as, a *revocable* edict or grant.

REVOCABLENESS, *n.* The quality of being revocable.

REVOCABLY, *adv.* In a revocable manner.

REVOcate, † *v. t.* [*L. revoco*; *re* and *voco, to call.*] To recall; to call back. [*See REVOKE.*]



**REVOCA'TION**, *n.* [Fr. from L. *revocatio*.] 1. The act of recalling or calling back; as, the *revocation* of Calvin.—2. State of being recalled.—3. Repeal; reversal; as, the *revocation* of the edict of Nantz. A law may cease to operate without an express *revocation*. So we speak of the *revocation* of a will, of a use, of a devise, &c. *Power of revocation in law*, a power contained in a voluntary deed of conveyance to uses, by which the grantor retains the liberty to revoke the uses granted by the deed. In *Scots law*, *revocation* is used to denote a deed recalling some former deed; or a clause of revocation may form part of another deed; as, where it is introduced into a settlement for the purpose of recalling a former settlement.

**REVO'CATORY**, *a.* Revoking; recalling.

**REVOICE'**, *v. t.* To refurnish with a voice; to refit an organ-pipe, so as to restore its proper quality of tone.

**REVO'KE**, *v. t.* [Fr. *revouer*; L. *revocare*; *re* and *voco*, to call.] 1. To recal; to repeal; to reverse. A law, decree, or sentence is *revoked* by the same authority which enacted or passed it. A charter or grant which vests rights in a corporation, cannot be legally *revoked* without the consent of the corporation. A devise may be *revoked* by the deviser, a use by the grantor, and a will by the testator.—2. † To check; to repress; as, to *revoke* rage.—3. To draw back.

Seas are troubled when they do *revoke*  
Their flowing waves into themselves again.  
[Unusual.] Davies.

**REVO'KE**, *v. i.* To renounce at cards.

**REVO'KE**, *n.* The act of renouncing at cards.

**REVOKED**, *pp.* Repealed; reversed.

**REVOKEMENT**, *n.* Revocation; reversal. [Little used.]

**REVOKING**, *ppr.* Reversing; repealing.

**REVOLT'**, *v. i.* [Fr. *revolter*; from L. *revolvere*; *re* and *volvo*, to turn, Eng. *wallow*.] 1. To fall off or turn from one to another.—2. To renounce allegiance and subjection to one's prince or state; to reject the authority of a sovereign; as a province or a number of people. [It is not applied to individuals.]

The Edomites *revolted* from under the hand of Judah; 2 Chron. xxi.  
3. † To change.—4. In *Scripture*, to disclaim allegiance and subjection to God; to reject the government of the King of kings; Is. xxxi.

**REVOLT'**, *v. t.* To turn; to put to flight; to overturn.—2. To shock; to do violence to; to cause to shrink or turn away with abhorrence; as, to *revolt* the mind or the feelings.

Their honest pride of their purer religion had *revolted* the Babylonians. Milton.  
**REVOLT'**, *n.* Desertion; change of sides; more correctly, a renunciation of allegiance and subjection to one's prince or government; as, the *revolt* of a province of the Roman empire.—2. Gross departure from duty.—3. In *Scripture*, a rejection of divine government; departure from God; disobedience; Is. lix.—4. † A revolt.

**REVOLT'ED**, *pp.* Having swerved from allegiance or duty.—2. Shocked; grossly offended.

**REVOLTER**, *n.* One who changes sides; a deserter.—2. One who renounces allegiance and subjection to his prince or state.—3. In *Scripture*,

one who renounces the authority and laws of God, Jer. vi.; Hos. ix.

**REVOLTING**, *ppr.* Changing sides; deserting.—2. Disclaiming allegiance and subjection to a prince or state.—3. Rejecting the authority of God.—4. *a.* Doing violence, as to the feelings; exciting abhorrence.

**REVOLUBLE**, *a.* That may revolve.

**REVOLUTE**, *a.* [L. *revolutus*, from *revolvere*.] In *bot.*, rolled back or downward; as, *revolute* foliage or leafing, when the sides of the leaves in the bud are rolled spirally back or toward the lower surface; a *revolute* leaf or tendril; a *revolute* corol or valve.—2. In *zool.*, a term applied to a part that is rolled outwards or backwards.



Revolute.

**REVOLUTION**, *n.* [Fr. from L. *revolutus*, *revolvere*.] 1. In *physics*, rotation; the circular motion of a body on its axis; a course or motion which brings every point of the surface or periphery of a body back to the place at which it began to move; as, the *revolution* of a wheel; the diurnal *revolution* of the earth. In *geom.*, the term is employed to express the motion of a point, line, or surface, about a centre or axis.—2. The motion of a body round any fixed point or centre; as, the annual *revolution* of the earth or other planet in its orbit round the centre of the system. Also the period in which a planet, satellite, or comet returns to the place in its orbit from which we estimate its setting out.—3. Motion of any thing which brings it to the same point or state; as, the *revolution* of day and night or of the seasons.—4. Continued course marked by the regular return of years; as, the *revolution* of ages.—5. Space measured by some regular return of a revolving body or of a state of things; as, the *revolution* of a day.—6. In *politics*, a material or entire change in the political constitution of a country, accomplished in a short time, whether by legal or illegal means. The term *revolution*, in English history, is applied by way of eminence to the year 1688, universally regarded as the great era of English liberty. It was produced by the abdication of King James II. The term, the *French revolution*, is usually applied to the changes begun in 1789. The usually French revolutions are subsequently indicated by their respective dates.—7. Motion backward.—This word is used adjectively; as in the phrase, *revolution principles*.

**REVOLU'TIONARY**, *a.* Pertaining to a revolution in government; as, a *revolutionary* war; *revolutionary* crimes or disasters.—2. Tending to produce a revolution; as, *revolutionary* measures.

**REVOLU'TIONER**, *n.* One who is engaged in effecting a revolution; a revolutionist.—2. In England, one who favoured the revolution in 1688.

**REVOLU'TIONISM**, *n.* State of revolutions.

**REVOLU'TIONIST**, *n.* One engaged in effecting a change of government; the favourer of a revolution.

**REVOLU'TIONIZE**, *v. t.* To effect a change in the form of a political constitution; as, to *revolutionize* a government.—2. To effect an entire change of principles in.

The Gospel, if received in truth, has *revolutionized* his soul. J. M. Mason.

**REVOLU'TIONIZED**, *pp.* Changed in constitutional form and principles.

**REVOLU'TIONIZING**, *ppr.* Chang-

ing the form and principles of a constitution.

**REVOLVE**, *v. i.* (*revolv'*) [L. *revolvere*, *re* and *volvo*; Russ. *valyu*, to roll.] 1. To turn or roll round; as, the earth *revolves* on its axis.—2. To move round a centre; as, the planets *revolve* round the sun.—3. To fall back; to return.

**REVOLVE'**, *v. t.* 1. To roll any thing round; to cause to turn round. [Unusual.]—2. To turn again and again; to meditate on; as, to *revolve* thoughts in the mind.

**REVOLV'ED**, *pp.* Turned again and again; seriously considered.

**REVOLV'ENCY**, *n.* State, act, or principle of revolving; revolution. Its own *revolvency* upholds the world. Cowper.

**REVOLV'ING**, *ppr.* Turning; rolling; moving round.

**REVOMIT**, *v. t.* [*re* and *vomit*; Fr. *revomir*.] To vomit or pour forth again; to reject from the stomach.

**REVUL'SION**, *n.* [Fr. from L. *revulsus*, *revello*; *re* and *vello*, to pull.] 1. In *med.*, the act of turning or diverting any disease, from one part of the body to another.—2. The act of holding or drawing back.

**REVULSIVE**, *a.* Having the power of revulsion.

**REVULSIVE**, *n.* That which has the power of diverting disease from one part to another.—2. That which has the power of withdrawing.

**REW'**, *n.* A row.

**REWARD'**, *v. t.* [Norm. *regarder*, to allow; *regardes*, fees, allowances, perquisites, rewards; *regardez*, awarded. In these words there appears to be an alliance with *regard*. But in the Fr. and Norm. *guerdon*, a reward, and *guerdonner*, to reward, this alliance does not appear. So the Italian *guerdonare*, to reward, is evidently a compound of the L. *dono* with another word, and apparently with the Sax. *wither*, G. *wider* and *wieder*, D. *weder*, answering to L. *re*, denoting return. The Spanish and Portuguese have the Latin word with a different prefix; Sp. *galardon*, a reward; *galardonar*, to reward; Port. *galardam*, *galadoar*. *Reward* appears to be from the Norman.] To requite; to give in return, either good or evil; to gratify by a gift in token of desert or approval.

Thou hast *rewarded* me good, whereas I have *rewarded* thee evil; 1 Sam. xxiv.

Hence, when good is returned for good, *reward* signifies to repay, to recompense, to compensate. When evil or suffering is returned for injury or wickedness, *reward* signifies to punish with just retribution, to take vengeance on, according to the nature of the case.

I will render vengeance to my enemies; and will *reward* them that hate me; Deut. xxxii.

The Son of man will come in the glory of his Father, with his angels, and then he will *reward* every man according to his works; Matt. xvi.

In the latter passage, *reward* signifies to render both good and evil.

**REWARD'**, *n.* 1. A gift in token of approved merit. Recompense, or equivalent return for good done, for kindness, for services, and the like. *Rewards* may consist of money, goods, or any return of kindness or happiness. The labourer is worthy of his *reward*; 1 Tim. v.

Great is your *reward* in heaven; Matt. v.

*Rewards* and punishments presuppose moral agency, and something voluntarily done, well or ill; without which respect, though we may receive good, it is only a benefit and not a *reward*.—2. The fruit of men's labour or works.

The dead know not any thing, neither have they any more a *reward*; Eccles. ix. 3. A bribe; a gift to pervert justice; Deut. xxvii.

4. A sum of money offered for taking or detecting a criminal, or for the recovery of any thing lost.—5. Requital; punishment; a just return of evil or suffering for wickedness.

Only with thine eyes shalt thou behold and see the *reward* of the wicked; Ps. xci.

6. Return in human applause; Matt. vi.—7. Return in joy and comfort; Ps. xix.

REWARD'ABLE, *a.* That may be rewarded; worthy of recompense.

REWARD'ABLENESS, *n.* The state of being worthy of reward.

REWARD'ABLY, *adv.* In a rewardable manner.

REWARD'ED, *pp.* Requited; recompensed or punished.

REWARD'ER, *n.* One who rewards; one that requites or recompenses; Heb. xi.

REWARD'ING, *ppr.* Making an equivalent return for good or evil; requiting; recompensing or punishing.

REWARD'LESS, *a.* Having no reward.

REWORD, *† v. t.* [*re* and *word*.] To repeat in the same words.

REWRITE, *v. t.* To write a second time.

REWRITING, *ppr.* Writing again.

REWRIT'TEN, *pp.* Written again.

REX, *n.* [Lat.] A king.

REYNARD. See RENARD.

REYS, *n.* The master of an Egyptian barque or ship.

RHABAR'BARATE, *a.* [See RHUBARB.] Impregnated or tintured with rhubarb.

RHABAR'BARINE, *n.* [L. *rhubarbarum*.] Generally and more correctly called *rheine*—which see.] A proximate principle of rhubarb, which appears to possess the properties of an acid. It has been supposed to be the active principle of rhubarb; but this is not well settled.

RHABAR'BARUM, *n.* [L.] Rhubarb—*which see*.

RHABDOL'OGY, *n.* [Gr. *ῥαβδος*, a staff or wand, and *λογος* discourse.] The art or art of computing or numbering by Napier's rods or Napier's bones.

RHAB'DOMANCY, *n.* [Gr. *ῥαβδος*, a rod, and *μαντιαι*, divination.] Divination by a rod or wand.

RACHIAL'GIA, *n.* [L. from Gr. *ῥαχις*, the spine of the back, and *αλγος*, pain.] A pain in the spine of the back.

RHA'CHIS, *n.* In *bot.* [See RACHIS.]

RHACHITIS, *n.* The rickets. [See RACHITIS.]

RHAMNACEÆ, *n.* A nat. order of exogenous plants, remarkable for having a valvate calyx, hooded petals, opposite to which their stamens are inserted into the tube of the calyx, and a superior or half-inferior fruit which is either dry or fleshy. The species are all shrubs, with small greenish or inconspicuous flowers. They are found over nearly all the world, except in the arctic zone. The berries of several species of *Rhamnus* are violent purgatives, while the fruit of some species, as the jujube, is harmless and eatable. *Zizyphus lotus*, gives its name to the Lo-

tophagi, or lute-eaters of Africa. The berries of *Rhamnus frangula* yield a



*Rhamnus frangula.*

yellow dye, and *R. frangula* yields excellent charcoal for gunpowder.

RHAM'NUS, *n.* Buckthorn, a widely diffused genus of plants; nat. order, Rhamnaceæ. Class Pentandria; order, Monogynia, Linn. They are chiefly found in the temperate parts of the world. The berries of the common buckthorn, *R. catharticus*, a British species, possess purgative properties. The juice of the unripe berry dyes yellow. [See RHAMNACEÆ.] The berries of several species form articles of commerce from the Mediterranean, under the name of French, Turkey, and Persia berries, grains d'Avignon, &c.

RHAMPHASTOS. See RAMPHASTOS.

RHAPONTICINE, *n.* [L. *rhaponticum*.] A proximate principle of Rheum raphaniticum; perhaps the same as *rheine*.

RHAPSOD'IC, } *a.* [from *rhapsody*.

RHAPSOD'ICAL, } *dy.*] Pertaining to or consisting of rhapsody; unconnected.

RHAPSODIST, *n.* [from *rhapsody*.] One that writes or speaks without regular dependence of one part of his discourse on another.—2. One who recites or sings rhapsodies for a livelihood; or one who makes and repeats verses extempore.—3. Anciently, one whose profession was to recite the verses of Homer and other poets.

RHAPSODY, *n.* [Gr. *ῥαψωδία*; *ῥαπτω*, to sew or unite, and *ωδη*, a song.] Originally, a discourse in verse, sung or rehearsed by a rhapsodist; or a collection of verses, particularly those of Homer. In modern usage, a collection of passages, thoughts, or authorities, composing a new piece, but without necessary dependence or natural connection.

RHATANY. See RATANY.

RHE'A, *n.* In *classical mythology*, the daughter of Cælus and Terra, wife and sister of Saturn, and mother of Jupiter, Vesta, Ceres, Juno, Pluto, &c.—2. A genus of birds belonging to the family Struthionidæ, of which the three-toed ostriches of South America are the representatives.

RHEIN-BERRY, *n.* Buckthorn, a plant; belonging to the genus *rhamnus*,—*which see*.

RHE'INE, *n.* [from *Rheum*, rhubarb.] An inodorous bitterish substance of a yellow colour, obtained by gently heating powdered rhubarb with 8 parts of

nitric acid of the sp. gravity 1.37, evaporating to the consistence of syrup, and diluting with cold water. It has been supposed to be the active principle of *rhubarb*, but this is doubtful.

RHENISH, *a.* Pertaining to the river Rhine, or to Rheims in France; as, *Rhenish* wine; as a noun, the wine produced on the hills about Rheims, which is remarkable as a solvent of iron. *Rhenish* wines are the finest of Germany; they improve much with age, and continue improving longer than any other wines.

RHE'SUS MONKEY, *n.* A species of *Simiada*, found in Bengal, placed by Cuvier and others among the macaques.

RHE'TIAN, *a.* Pertaining to the ancient Rhæti, or to Rhætia, their country; as, the *Rhetian* Alps, now the country of Tyrol and the Grisons.

RHE'TOR, *n.* [L. from Gr. *ῥητορ*, an orator or speaker.] A rhetorician. [Little used.]

RHE'TORIC, *n.* [Gr. *ῥητορικη*, from *ῥηω*, to speak, to flow, contracted from *ῥηωω* or *ῥηωωω*, Eng. to read. The primary sense is to drive or send. See READ.]

1. The art of speaking with propriety, elegance, and force.—2. The power of persuasion or attraction; that which allures or charms. We speak of the *rhetoric* of the tongue, and the *rhetoric* of the heart or eyes. In the widest sense in which the word is occasionally used by modern writers, it denotes the art of prose composition generally, whether in the form of historical works, philosophical dissertations, practical precepts, dialogues, or letters, and therefore includes the consideration of all the qualities of prose composition, as purity of style, structure of sentences, figures of speech, &c.; in short, the consideration of whatever relates to clearness, preciseness, elegance, and strength of expression. In the most restricted, and most etymological sense, the art of oratory or of addressing public assemblies. In an intermediate sense, in which, perhaps, it is most commonly employed, the art of argumentative composition. This comes nearest to the signification which Aristotle, the earliest extant writer of a formal treatise on rhetoric, attached to the title of his subject, where he defined it to be the art of discovering and employing topics of persuasion.

Sweet silent *rhetoric* of persuading eyes. Daniel

RHETORICAL, *a.* Pertaining to rhetoric; as, the *rhetorical* art.—2. Containing the rules of rhetoric; as, a *rhetorical* treatise.—3. Oratorical; as, a *rhetorical* flourish.—4. Figurative; persuasive.

RHETORICALLY, *adv.* In the manner of rhetoric; according to the rules of rhetoric; as, to treat a subject *rhetorically*; a discourse *rhetorically* delivered.

RHETORICATE, *† v. i.* To play the orator.

RHETORICA'TION, *† n.* Rhetorical amplification.

RHETORI'CIAN, *n.* [Fr. *rhetoricien*.] 1. One who teaches the art of rhetoric, or the principles and rules of correct and elegant speaking.

The ancient sophists and *rhetoricians*, who had young auditors, lived till they were a hundred years old. Bacon.

2. One well versed in the rules and principles of rhetoric.—3. An orator. [Less proper.]

**RHETORICIAN**, *fr. a.* [See the Noun.] Suiting a master of rhetoric.  
**RHETORIZE**, *fr. i.* To play the orator.  
**RHETORIZE**, *v. t.* To represent by a figure of oratory.  
**RHETORIZED**, *pp.* Represented by a figure of oratory.

**RHEUM**, *n.* [Gr. *ῥεῦμα*, from *ῥέω*, to flow.]  
 1. An increased action of the vessels of any organ; but generally applied to the increased action of mucous glands, attended with increased discharge and unaltered state of their excreted fluids.  
 —2. A thin serous fluid, secreted by the mucous glands, &c.; as in catarrh.  
 —3. A genus of plants of the nat. order polygonaceæ, including the different species of plants which yield the stalks and root so well known by the name of rhubarb,—*which see.*

**RHEUMATIC**, *a.* [L. *rheumaticus*; Gr. *ῥευματικός*, from *ῥεῦμα*, rheum,—*which see.*] Pertaining to rheumatism, or partaking of its nature; as, *rheumatic pains* or affections.

**RHEUMATISM**, *n.* [L. *rheumatismus*; Gr. *ῥευματισμός*, from *ῥεῦμα*, a watery humour, from *ῥέω*, to flow; the ancients supposing the disease to proceed from a defluxion of humours.] A painful disease affecting muscles and joints of the human body, chiefly the larger joints, as the hips, knees, shoulders, &c. attended by swelling and stiffness. It is occasionally accompanied by fever, when it constitutes *acute rheumatism* or *rheumatic fever*.

**RHEUMY**, *a.* [from *rheum*.] Full of rheum or watery matter; consisting of rheum or partaking of its nature.—2. Affected with rheum.—3. Abounding with sharp moisture; causing rheum.

**RHIME**. See **RHYME**.

**RHINAN'THUS**, *n.* A genus of European annual plants; nat. order Scrophulariaceæ. Two of them are British, and are known by the name of yellow-rattle. They are common in every damp meadow.

**RHINO**, *n.* A cant word for gold and silver, or money.

**RHINOCE'RIAL**, *a.* [from *rhinoceros*.] Pertaining to the rhinoceros; resembling the rhinoceros.

**RHINOCEROS**, *n.* [Fr. and L. *rhinoceros*; Gr. *ῥινοκερως*, nose-horn; *ῥίς*, the nose, W. *rhyn*, a point, and *κερας*, a horn.] A genus of pachydermatous mammals, nearly allied to the elephant, the hippopotamus, the tapir, &c. Five species are described by naturalists. Two of these have a single horn on the nose, and three of them have two horns. *Rhinoceros Indicus* inhabits India, es-



Rhinoceros Indicus.

pecially the banks of the Ganges; *R. Africanus* and *R. Simus* inhabit southern Africa; and *R. Sumatrensis* and *R. Sondaicus* inhabit Sumatra.

**RHINOCEROS-BIRD**, *n.* A bird of

the genus *Buceros*, a species of horn-bill. [See **HORNBILL**.]  
**RHINOPLAS'TIC**, *a.* [Gr. *ῥίς*, the nose, and *πλασσω*, to form.] Forming a nose. The *rhinoplastic* operation in surgery is one which renews the nose, or supplies a substitute for a natural nose.

**RHIZ'ANTHS**, *n.* A class of plants occupying a station between sexual and non-sexual species, and which, with many of the peculiarities of Endogens, seems to be an intermediate form of organization between them and the lower Aerogens. In their succulent texture, in their colour, often in their putrid odour when decaying, in the sporuliferous seeds, and in their parasitical habits, these plants resemble Fungaceæ, while in their flowers and their sexes they accord with Araceæ, or similar Endogens. Notwithstanding their parasitical habits, some are of extraordinary size; as *Rafflesia*. [See **RAFFLESIA**.] The class is divided into four orders; viz., Rafflesiaceæ, Cytinaceæ, Balanophoreæ, and Cynomoriaceæ.

**RHIZO'MA**, *n.* [Gr. *ῥίζωμα*, a rooted state.] In *bot.*, a thick stem running along the surface of the ground, or partially subterranean, sending forth



Rhizoma (*Convallaria polygonatum*).

shoots at its upper end, and decaying at the other. It is otherwise called *rootstock*.

**RHIZOMOR'PHA**, *n.* A singular genus of fungi, having the appearance of the root of a tree. The species are found in damp cellars, old walls, mines, and other subterraneous places, and are sometimes phosphorescent. In the coal mines near Dresden, the species are described as giving those places the air of an enchanted castle; the roof, walls, and pillars are entirely covered with them, their beautiful light almost dazzling the eye. The light is found to increase with the temperature of the mines.

**RHIZOPH'AGOUS**, *a.* [Gr. *ῥίζα* and *φαγω*.] Feeding on roots.

**RHIZO'PHORA**, *n.* A genus of plants which gives its name to the nat. order Rhizophoraceæ or the mangrove tribe. The species are known by the name of mangrove [see **MANGROVE**]; they are remarkable for their seeds germinating even while attached to the branches, and also for the numerous adventitious root-like projections which serve as supports for the stem. The wood of several species is hard and durable, and the bark astringent. The bark of *R. gymnorhiza* is used in India for dyeing black. The species are natives of the tropics, where they root in the mud,

and form a dense thicket down to the verge of the water.

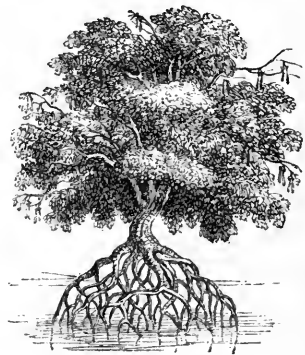

Mangrove *Rhizophora manglier*.

**RHIZOS'TOMES**, } *n.* [Gr. *ῥίζα*, and **RHIZOS'TOMA**, } *σπυμα*, a mouth.] A genus of Medusæ, including those which have the absorbing orifices of their nutrient canals of small size, and situated in great numbers on the branches of arms, or peduncles extending from the centre of the inferior surface of the disc.

**RHO'DIAN**, *a.* Pertaining to Rhodes, an isle of the Mediterranean; as, *Rhodian laws*.

**RHO'DIO-CHLORIDES**, *n.* In *chem.*, the name given to the salts which result from the combinations of the sesquichloride of rhodium with the chlorides of potassium and sodium.

**RHODI'OLA**, *n.* A genus of Alpine plants belonging to the nat. order Crassulaceæ. The *R. rosea*, now frequently called *Sedum Rhodiola* or rose-root, is a British plant found on cliffs along the sea, and on high mountains. It is very common in the north of Scotland and the Hebrides. The root, which is thick and fleshy, smells like a rose. The *R. biternata* is a native of Cochinchina.

**RHO'DIUM**, *n.* [Gr. *ῥόδον*, a rose, on account of the red colour of some of its salts, especially of the chloride, when dissolved in water.] A metal discovered in 1803 by Wollaston, associated with palladium in the ore of platinum. *Rhodium* requires the strongest heat that can be produced in a wind-furnace, for its fusion. When fused, it has a white colour and a metallic lustre. It is extremely hard, brittle, and has a sp. gr. of about 11. It unites with oxygen at a red heat, a mixture of peroxide and protoxide being formed. When pure, it is not acted upon by any acid; but if in the state of an alloy, it is dissolved by *aqua regia*. It has been applied for the points of metallic pens.  
**RHODODEN'DRON**, *n.* [Gr. *ῥόδον*, a rose, and *δένδρον*, a tree.] A genus of highly-prized evergreen shrubs very common in gardens, belonging to the nat. order Ericaceæ. The species have alternate entire, evergreen leaves, and ornamental flowers, disposed in corymbs. They are nearly related to each other, and occur both in the new and old worlds. The varieties cultivated in this country belong chiefly to *R. ponticum*, a native of the coasts of the Black sea, or to *R. catawbiense*, an American species, or to hybrids be-

tween these two. The leaves of *R. Chrysanthum*, a Siberian species, with



Rhododendron chrysanthum.

yellow flowers, possess narcotic properties, and have a great reputation as a remedy for chronic rheumatism. *R. ferrugineum*, found wild in Switzerland, is called the Rose of the Alps.

**RHO'DONITE**, *n.* An impure variety of manganese.

**RHOETIZITE**, } *n.* A variety of the  
**RHET'IZITE**, } mineral kyanite.

**RHOMB**, } *n.* [Fr. *rhombe*; L. *rhombus*]  
**RHOMBUS**, } *bus*; Gr. *ῥομβος*, from *ῥιμβω*, to turn or whirl round, to wander, to roam or rove; literally, a deviating square.] In *geom.*, an oblique angled equilateral parallelogram, or a quadrilateral figure whose sides are equal, and the opposite side parallel, but the angles unequal, two of the angles being obtuse and two acute.



Rhomb.

**RHOMB'IC**, *a.* Having the figure of a rhomb.

**RHOM'BO**, } *n.* A fish of the turbot  
**RHOM'BUS**, } kind.

**RHOMBOHE'DRAL**, *a.* [Gr. *ῥομβος*, rhomb, and *ἑσπερ*, side.] Having forms derived from the rhombohedron.

**RHOMBOHE'DRON**, *n.* A solid bounded by six rhombic planes.

**RHOM'BOID**, *n.* [Gr. *ῥομβος*, rhomb, and *ἰδος*, form.] 1. In *geom.*, a parallelogram having some resemblance to a rhomb; or a quadrilateral figure whose opposite sides are equal, but which is neither equilateral nor equi-



Rhomboid.

angular. In describing crystals, some are termed *rhombs* or *rhomboids*, because they are solids whose faces have these figures. They are rhomboidal solids.—2. *a.* In *anat.*, the *rhomboid muscle* is a thin, broad, and obliquely square fleshy muscle, between the basis of the scapula and the spina dorsi.—3. In *bot.*, *rhomboid leaf*, or *rhomboidal leaf*, one that is diamond-shaped.

**RHOMBOID'AL**, *a.* Having the shape of a rhomboid, or a shape approaching it.

**RHOMB'SPAR**, *n.* A mineral of a greyish white, occurring massive, disseminated and crystallized in rhomboids, imbedded in chlorite slate, limestone, &c. It consists chiefly of carbonates of lime and magnesia.

**RHOM'BUS**. See **RHOMB**.

**RHON'CHUS**, *n.* [L. from Gr. *ῥογχος*.] A rattling or wheezing sound. The

term is applied in *auscultation* to any prerenatural sound accompanying respiration, occasioned either by the passage of the air through fluids obstructing the bronchia or air cells, or by constriction of the bronchial tubes. It is also called *rattle*, and several kinds are distinguished by medical men; as the *crepitous*, *mucous*, *sonorous*, *sibilant*, and *crackling*.

**RHU'BARB**, *n.* [Pers. *rawand*. In Syr. *raiborig*. It seems to be a compound word, Latinized *rhabarbarum*.] The common name of plants of the genus *Rheum* [see **RHEUM**], which yield the leaf-stalks used for making tarts, &c., and root used in medicine, so well known by the same name. All the species are indigenous in cold parts of the world. The particular species which yields the officinal rhubarb, and even the precise place of its growth, are not known. There are, however, six well-marked varieties, viz., Russian



Rhubarb (Rheum palmatum).

or Turkey, Dutch-trimmed, Chinese, Himalayan, English, and French. Rhubarb is a valuable article in the materia medica, being an aperient, and at the same time a tonic and astringent.

**RHUBARBARINE**. See **RHABARBARINE**.

**RHU'BARBY**, *a.* Like rhubarb.

**RHUMB**, *n.* [from *rhomb*.] In *navigation*, a vertical circle of any given place, or the intersection of such a circle with the horizon; in which last sense rhumb is the same as a point of the compass.—2. A circle on the earth's surface making a given angle with the meridian of the place.

**RHUMB'-LINE**, *n.* In *navigation*, a line prolonged from any point of the compass on a nautical chart, except from the four cardinal points; or it is the line described by a ship while her course is constantly directed towards one and the same point of the compass, except the four cardinal points. Such a line cuts all the meridians at the same angle. It continually approaches the pole, but can never arrive at it. It is also called the *Loxodromic line* or *curve*.

**RHUS**, *n.* Sumach, a genus of deciduous trees and evergreen shrubs; nat. order Anacardiaceæ. This genus is found in the south of Europe, in Africa, in Asia, and North and South America. Most of the species are poisonous, but they are much cultivated as ornamental shrubs, on account of the beautiful red colour of their leaves in autumn. Many of them are used also for the purposes of dyeing and tanning; as an astringent principle, to which is frequently added an acid, is common to the whole genus. The juice of *R. toxicodendron*, the

poison-tree or poison-oak, is extremely poisonous. So also is the juice of *R. radicans*, or rooting poison-oak. *R. coriaria*, or elm-leaved Sumach, is extensively used for the purpose of tanning; *R. copallina*, gum-copal or mastic-leaved Rhus, is supposed to yield the gum-copal of commerce, from which copal-varnish is made. *R. vernicifera*, the varnish-bearing Sumach or Japan varnish-tree, yields a varnish used by the Japanese, and applied to furniture, and almost every thing made of wood. *R. venenata*, the poison Sumach or swamp Sumach, a native of North America, is exceedingly poisonous; so virulent that it is said to affect some persons by merely smelling it.

**RHYME**, *n.* [Sax. *rim*, and *gerim*, number; *riman*, to number; *ge-riman*, id.; *riman* and *ryman*, to give place, to open a way, to make room; *G. reim*; *W. rhiv*; *Ir. rimk* or *reomh*. The Welsh word is rendered also, that divides or separates, and the Sax. *rim* seems to be connected with *room*, from opening, spreading. The deduction of this word from the Greek *ῥυθμος*, is a palpable error. The true orthography is *rime* or *ryme*; but as *rime* is hoarfrost, and *rhyme* gives the true pronunciation, it may be convenient to continue the present orthography.] 1. In *poetry*, the correspondence or consonance of sounds in the terminating words or syllables of two verses, one of which succeeds the other immediately, or at no great distance.

For rhyme with reason may dispense,  
And sound has right to govern sense.

Prior.

To constitute this correspondence in single words or in syllables, it is necessary that the *vowel*, and the *final* articulations or consonants, should be the same, or have nearly the same sound. The initial consonants may be different, as in *find* and *mind*, *new* and *drew*, *cause* and *laws*.—2. An harmonical succession of sounds.

The youth with songs and rhymes,  
Some dance, some haul the rope.

Denham.

3. Poetry; a poem.

He knew  
Himself to sing, and build the lofty rhyme  
Milton.

4. A word of sound to answer to another word.—*Rhyme* or *reason*, number or sense.

But from that time unto this season,  
I had neither rhyme nor reason.  
Spenser.

**RHYME**, *v. i.* To accord in sound.

But fagotted his notions as they fell,  
And if they rhymed and rattled, all was well.  
Dryden.

2. To make verses.

There march'd the bard and blockhead side  
by side,  
Who rhymed for hire, and patronized for  
pride.  
Pope.

**RHYME**, *v. t.* To put into rhyme.

**RHYMED**, *pp.* Put into rhyme.

**RHYMELESS**, *a.* Destitute of rhyme; not having consonance of sound.

**RHYMER**, } *n.* One who makes  
**RHYMIST**, } rhymes; a versifier; a  
**RHYMSTER**, } poor poet.

**RHYMIC**, *a.* Pertaining to rhyme.

**RHYN'CHOLITE**, *n.* [Gr. *ῥογχος*, a beak, and *λίθος*, a stone.] The petrified beak of a bird.

**RHYNCHO'PHORES**, } *n.* A family of  
**RHYNCHO'PHORA**, } coleopterous

insects, comprehending those which have the head prolonged in the form of a snout or proboscis.



Rhynchophores (Carcuio imperialis).

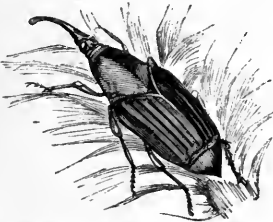

Rhynchophores (Carcuio palmarum).

**RHYNCHOSPORA**, *n.* Beak-rush, a genus of herbaceous plants; nat. order Cyperaceæ. Two species are British plants, separated from the genus *Schœnus*, Linn. by Vahl.

**RHYTHM**, } *n.* [Gr. ῥυθμός.] 1. In **RHYTHMUS**, } *music*, variety in the movement as to quickness or slowness, or length and shortness of the notes; or rather the proportion which the parts of the motion have to each other.—2. *Metre*; *verse*; *number*.—3. *Rhythm* is the consonance of measure and time in poetry, prose composition, and music, and by analogy, dancing. In *poetry*, it is the relative duration of the moments employed in pronouncing the syllables of a verse; and in *music*, the relative duration of the sounds that enter into the composition of an air. *Prose* also has its *rhythm*, and the only difference (so far as sound is concerned) between verse and prose is, that the former consists of a regular succession of similar cadences, or of a limited variety of cadences, divided by grammatical pauses and emphases into proportional clauses, so as to present sensible responses to the ear, at regular proportioned distances; prose, on the other hand, is composed of all sorts of cadences, arranged without attention to obvious rule, and divided into clauses which have no obviously ascertained proportion, and present no responses to the ear at any legitimate or determined intervals. In *dancing*, the rhythm is recognised in the sound of the feet.

**RHYTHMICAL**, *a.* [Gr. ῥυθμικός: *L. rhythmicus*.] Having proportion of sound, or one sound proportioned to another; harmonical. Duly regulated by cadences, accents, and quantities.

**RHYTHMICALLY**, *adv.* With rhythm.

**RYAL**, *n.* A Spanish coin. [See **REAL**.]

**RI'AL**, *n.* [from *royal*.] A royal; a gold coin of varying value, formerly current in Britain.

**RIANT** *a.* (rē-ōng.) [Fr. from *rire*, to laugh.] Laughing; gay; smiling; exciting laughter. [Not anglicized.]

**RIB**, *n.* [Sax. *rib* or *ribb*; Ice. *rif*; G. *rippe*; D. *rib*, a rib or rafter; Sw. *refben*, rib or side bone; Dan. *ribbe* or *ribben*, rib-bone; Russ. *rebro*, a rib or side. This word, like the *L. costa*, signifies side, border, extremity, whence the compound in Sw. and Dan. *rib-bone*, that is, side-bone. It may be allied to the *L. ripa*. The sense of *side* is generally from extending.] 1. A bone of animal bodies which forms a part of the frame of the thorax. The ribs in the human body are twelve on each side, proceeding from the spine to the sternum, or toward it, and serving to inclose and protect the heart and lungs. The seven upper ribs are called *true ribs*, and the five lower ones, *false ribs*.—2. In *ship building*, a piece of timber which forms or strengthens the side of a ship.—*Ribs of a parrel* are short pieces of plank, having holes through which are reeved the two parts of the parrel-rope.—3. In *bot.*, the continuation of the petiole along the middle of a leaf, and from which the veins take their rise.—4. In *cloth*, a prominent line or rising, like a rib.—5. Something long, thin, and narrow; a strip. [W. *rhīb*.]—*Ribs*, in *carpentry* and *joinery*, curved pieces of timber to which the laths are fastened in forming domes, vaults, niches, &c. In *arch.* [Fr. *nerveuse*,] projecting bands or mouldings used in ornamented ceilings, both flat and curved, but more commonly in the latter, especially when groined.—6. A wife, in allusion to Eve, our common mother, formed out of Adam's rib. [Familiär.]

**RIB**, *v. t.* To furnish with ribs. In *manufactures*, to form with rising lines and channels; as, to *rib* cloth; whence we say, *ribbed* cloth.—2. To inclose with ribs.

**RIB'ALD**, *n.* [old Fr. *ribault*, from Low *L. ribaldus*, It. *ribaldo*, a rogue. Lexicographers differ greatly as to the remote etymology of this word.] A low, vulgar, brutal wretch; a lewd fellow.

**RIB'ALD**, *a.* Low; base; mean.

**RIB'ALDISH**, *a.* Disposed to ribaldry.

**RIB'ALDROUS**, *a.* Containing ribaldry.

**RIB'ALDRY**, *n.* [It. *ribalderia*.] Mean, vulgar language; chiefly, obscene language.

**RIB'AND**, *n.* See **RIBBON**.

**RIB'BED**, *pp.* or *a.* Furnished with ribs; as, *ribbed* with steel.—2. Inclosed as with ribs.—3. Marked or formed with rising lines and channels; as, *ribbed* cloth.—*Ribbed leaf*, in *bot.*, a leaf having longitudinal unbranched vessels, which are raised above the surface.

**RIB'BING**, *n.* In *carpentry* and *joinery*, an assemblage of ribs.—2. In *agriculture*, a kind of imperfect ploughing, formerly common on land intended for barley, and executed soon after harvest as a preparation for spring ploughing. By this method only half the land is raised; the furrow being laid over quite flat, and covering an equal space of the level surface. It is called in Scotland *faughing*. A similar operation is still in use in some places, after land has been pulverized by clean ploughings, and is ready for receiving the seed, and the mode of sowing upon land thus prepared is also called *ribbing*.

**RIB'BON**, } *n.* [W. *rhībin*, a row or **RIB'AND**, } streak, a dribble; *rhīb*, id.; Fr. *rubin*; Fr. *ruban*; Arm. *rubanow*. The preferable orthography

of this word is certainly *riband*, as given by Johnson, but modern usage seems in favour of *ribbon*.] 1. A fillet of silk or of satin; a narrow web of silk or satin used for an ornament, as a badge, or for fastening some part of female dress.—2. In *naval architecture*, a long narrow flexible piece of timber, nailed upon the outside of the ribs from the stem to the sternpost, so as to encompass the ship lengthwise; the principal are the floor-ribbon and the breadth-



Ribbon.

ribbon.—3. *Ribbon* or *riband*, in *her.*, one of the ordinaries, containing one-eighth part of the bend of which it is a diminutive; as in the figure, a bend, between a *ribbon* in chief, and a bendlet in base.—*Ribbons*, in the plural, is used by coach-drivers to signify carriage reins.

**RIB'BONED**, *a.* Adorned with ribbons.

**RIB'BON-GRASS**, *n.* Canary-grass; a plant of the genus *Phalaris*.

**RIB'ES**, *n.* A genus of plants forming the nat. order Grossulaceæ,—*which see*. It is well known as producing the currant and gooseberry, and also for affording many of the ornamental shrubs of our gardens. The species are natives of the mountains, hills, woods, and thickets of the temperate parts of Europe, Asia, and America.

**RIB'GRASS**, or **RIB'WORT**, *n.* A British plant of the genus *Plantago*, the *P. lanceolata*. [See **PLANTAGO**.]

**RIB'INE**, *n.* A sort of stringed instrument.

**RIB'LESS**, *a.* Having no ribs.

**RIB'ROAST**, } *v. t.* [*rib* and *roast*.] To beat soundly; *a. burlesque word*.

**RIB'ROASTED**, *pp.* Soundly beaten.

**RIB'ROASTING**, *ppr.* Beating soundly.

**RIBSUPPORTED**, *a.* Supported by ribs.

**RIB'WÖRT**. See **RIBGRASS**.

**RIC**, } as a termination, denotes juris-  
**RICK**, } diction, or a district over  
which government is exercised, as in *bishoprick*; Sax. *cyme-ric*, *king-ric*. It is the G. *reich*, D. *riget*, from Goth. *reih*, dominion, Sax. *rice* or *ric*; from the same root as *L. rego*, to rule, and *region*.

**RIC**, as a termination of names, denotes rich or powerful, as in *Alfric*, *Frederic*, like the Greek *Polycrates* and *Plutarchus*. It is the first syllable of *Richard*; Sax. *ric*, *rice*. [See **RICH**.]

**RICE**, *n.* [Fr. *riz* or *reis*; G. *reiz* or *reis*; L. *oryza*; Gr. ὄρυζα: Eth. *rez*; Ar. *arozon*; from the verb *araza*, to be contracted, or to be firmly fixed. The word is common to most of the Asiatics, Persians, Turks, Armenians, and Tartars.] A plant of the genus *Oryza*, and its seed, the *O. sativa*. [See **ORYZA**.] There is only one species. This plant is cultivated in all warm climates, and the grain forms a large



Rice (*Oryza sativa*).

portion of the food of the inhabitants In America, it grows chiefly on low

moist land, which can be overflowed. It is a light and nutritious food, and very easy of digestion. Indeed, it seems intended by the wise and benevolent Creator to be a common article of food for men in warm climates. There is an immense variety in the qualities of rice, but the rice raised on the low marshy grounds of Carolina is unquestionably very superior to any brought from any other quarter. Of the rice imported from the East, that from Patna is the most esteemed.

**RICE-BIRD,** } *n.* A bird of the  
**RICE-BUNTING,** } United States, the *Emberiza oryzivora*; so named from its feeding on rice in the Southern States. In New England, it is called *bob-o-link* or *bob-lincoln*.—2. One of the names of the paddy bird or Java sparrow, the *Loxia oryzivora*, Linn.



Rice-bird (*Loxia oryzivora*).

In Java and other parts of Asia where it is found, it commits great ravages in the rice fields with its sharp and powerful bill. It is admired for its elegant shape and colouring.

**RICE-GLUE,** *n.* A species of glue made by boiling ground rice in soft water to the consistency of thin jelly.

**RICE-MILK,** *n.* Milk boiled and thickened with rice.

**RICE-PAPER,** *n.* A substance prepared from the central cellular portion of the stem of a species of *Æschynomene*. The stem of the plant is cut transversely so as to form sheets of the so called Rice paper, the cellular structure of which is easily seen under the microscope. It is brought from China, and is used as a material for painting upon, and for the manufacture of several fancy and ornamental articles. It is sometimes erroneously stated to be prepared from rice.

**RICE-PUDDING,** *n.* Pudding made of rice, with eggs and sugar.

**RICE-WEEVIL,** *n.* An insect, the *Calandra oryzae*, resembling the common wheat-weevil, which preys on rice, maize, &c.

**RICH,** *a.* [Fr. *riche*; Sax. *ric*, *rice*, *ricca*; G. *reich*. This word in Saxon signifies great, noble, powerful, as well as rich. It is probable therefore it is connected with *ric*, dominion, L. *regis*, *regnum*, Eng. *reach*, *region*, from *extending*.] 1. Wealthy; opulent; opposed to *poor*; possessing a large portion of land, goods, or money, or a larger portion than is common to other men or to men of like rank. A farmer may be *rich* with property which would not make a nobleman *rich*. An annual income of £500 sterling would make a *rich* vicar, but not a *rich* bishop. Men more willingly acknowledge others to be *richer*, than to be wiser than themselves.

Abram was very *rich* in cattle, in silver, and in gold; Gen. xiii.

2. Splendid; costly; valuable; precious; sumptuous; as, a *rich* dress; a *rich* border; a *rich* silk; *rich* furniture; a *rich* present.—3. Abundant in materials; yielding great quantities of any thing valuable; as, a *rich* mine; *rich* ore.—4. Abounding in valuable ingredients or qualities; as, a *rich* odour or flavour; *rich* spices. So we say, a *rich* description; a discourse *rich* in ideas.—5. Full of valuable achievements or works.

Each minute shall be *rich* in some great action. *Rouce.*

6. Fertile; fruitful; capable of producing large crops or quantities; as, a *rich* soil; *rich* land; *rich* mould.—7. Abundant; large; as, a *rich* crop.—8. Abundant; affording abundance; plentiful.

The gorgeous East with *richest* hand Pours on her sons barbaric pearl and gold. *Milton.*

9. Full of beautiful scenery; as, a *rich* landscape; a *rich* prospect.—10. Abounding with elegant colours; as, a *rich* picture.—11. Plentifully stocked; as, pasture *rich* in flocks.—12. Strong; vivid; perfect; as, a *rich* colour.—13. Having something precious; as, a grove of *rich* trees.—14. Abounding with nutritious qualities; as, a *rich* diet.—15. Highly seasoned; as, *rich* paste; a *rich* dish of food.—16. Abounding with a variety of delicious food; as, a *rich* table or entertainment.—17. Containing abundance beyond wants; as, a *rich* treasury.—18. In *music*, full of sweet or harmonious sounds.—19. In *Scripture*, abounding; highly endowed with spiritual gifts; as, *rich* in faith; James ii.—20. Placing confidence in outward prosperity; Matt. xix.—21. Self-righteous; abounding, in one's own opinion, with spiritual graces; Rev. iii.—*Rich in mercy*, spoken of God, full of mercy, and ready to bestow good things on sinful men; Eph. ii.; Rom. x.—*The rich*, used as a noun, denotes a rich man or person, or more frequently in the plural, rich men or persons.

The *rich* hath many friends; Prov. xiv.

**RICH,** *† v. t.* To enrich. [See **ENRICH**.]

**RICHARDIA,** *n.* A genus of plants; nat. order Araceæ, of which only one species is known (*R. Æthiopia*), a native of the Cape of Good Hope. It is one of the most beautiful of aroidous plants, growing vigorously in the ordinary apartments of a house, and may be made to blossom all the year round. It was introduced into this country under the name of *Calla Æthiopia*.

**RICH'ED,** *† pp.* Enriched.

**RICH'ER,** *a. comp.* More rich.

**RICH'ES,** *n.* [Fr. *richesse*. This is in the singular number in fact, but treated as the plural.] 1. Wealth; opulence; affluence; possessions of land, goods, or money in abundance.

*Riches* do not consist in having more gold and silver, but in having more in proportion than our neighbours. *Locke.*

2. Splendid sumptuous appearance. The *riches* of heaven's pavement, trodden gold. *Milton.*

3. In *Scripture*, an abundance of spiritual blessings; Luke xvi.—*The riches of God*, his fulness of wisdom, power, mercy, grace, and glory, Eph. i. ii.; or the abundance supplied by his works; Ps. civ.—*The riches of Christ*, his abundant fulness of spiritual and eternal blessings for men; Eph. iii.—*The*

*riches of a state or kingdom* consist less in a full treasury, than in the productiveness of its soil and manufactures, and in the industry of its inhabitants. **RICH'EST,** *a. superl.* Most rich.

**RICH'LY,** *adv.* With riches; with opulence; with abundance of goods or estate; with ample funds; as, a hospital *richly* endowed.

In Belmont is a lady *richly* left. *Shak.*

2. Gayly; splendidly; magnificently; as, *richly* dressed; *richly* ornamented.—3. Plenteously; abundantly; amply; as, to be *richly* paid for services. The reading of ancient authors will *richly* reward us for the perusal.—4. Truly; really; abundantly; fully; as, a chastisement *richly* deserved.

**RICH'LY-WOODDED,** *a.* Abounding with wood.

**RICH'NESS,** *n.* Opulence; wealth.—2. Finery; splendour.—3. Fertility; fecundity; fruitfulness; the qualities which render productive; as, the *richness* of a soil.—4. Fulness; abundance; as, the *richness* of a treasury.—5. Quality of abounding with something valuable; as, the *richness* of a mine or an ore; the *richness* of milk or of cane-juice.—6. Abundance of any ingredient or quality; as, the *richness* of spices or of fragrance.—7. Abundance of beautiful scenery; as, the *richness* of a landscape or prospect.—8. Abundance of nutritious qualities; as, the *richness* of diet.—9. Abundance of high seasoning; as, the *richness* of cake.—10. Strength; vividness; or whatever constitutes perfection; as, the *richness* of colour or colouring.—11. Abundance of imagery or of striking ideas; as, *richness* of description.

**RICINIC ACID,** *n.* One of the products obtained by distilling castor oil at a high temperature.

**RICINUS,** *n.* A genus of apetalous plants; nat. order, Euphorbiacæ. The best known species is the *R. communis*, or *palma christi*, which produces the castor oil. It is conjectured to be originally from Barbary; and it grows abundantly in India. In warm countries it is ligneous and perennial; in cold, herbaceous and annual. The varieties are numerous. [See **CASTOR OIL**.]

**RICK,** *n.* [Sax. *hrec* or *hric*; Ir. *cruch*; W. *crug*, a *rich*, an apostem, a heap, a stack, a hillock; *crugaw*, to heap or pile, to swell, to grow into an apostem. It coincides with the G. *richen*, D. *rug*, the back, Eng. *ridge*.] A stack or pile of corn or hay, the lower part being generally of a cylindrical form, and the top part conical, and thatched so as to protect the pile from rain.

**RICK'ETS,** *n.* [In technical language, *rachia*, Gr. *ῥαχίς*, from *ῥαχίς*, back or spine, Eng. *rack*, applied to the neck piece of meat; Sp. *raquitis*, the *rickets*. See **RACK** and **RIDGE**.] A disease which affects children, and which is characterized by a bulky head, a crooked spine, depressed ribs, enlarged and spungy articular epiphyses, tumid abdomen, short stature, flabby and wrinkled flesh, together with clear and often premature mental faculties. This disease is confined in its attack between the two periods of nine months and two years of age, seldom appearing sooner than the former, or showing itself for the first time after the latter period.

**RICK'ETY,** *a.* Affected with rickets.—

2. Weak; feeble in the joints; imperfect.

**RICK'-STAND, n.** In *agric.*, a basement of timber or masonry, on which corn ricks or stalks are built. The object of rick-stands is to keep the lower part of the stack dry, and exclude vermin.

**RIC' OCHET, or RICOCHET, n.** [Fr.] A rebounding from a flat surface, as shells from water; familiarly known as *duck-and-drahe*.—2. In *gunnery*, the firing of guns, mortars, or howitzers in sieges, with small charges, and elevated a few degrees, so as to carry the balls or shells just over the parapet, and cause them to roll and bound along the opposite rampart. This is called *ricochet-firing*, and the batteries are called *ricochet-batteries*. It is very destructive; as the rebound causes the shot or shell to pass along a great space almost upon the ground, destroying all that it meets with in its way. It may also be used against troops in the field.

**RICOCHET, v. t.** To operate upon, by *ricochet* firing.

**RIC' OCHET, a.** As *ricochet-batteries*. [See **RICOCHET, n.**]

**RIC'TURE, n.** A gaping.

**RID, pret. of Ride.**

**RID, v. t. pret. rid; pp. id.** [Sax. *ahredan* or *hreddan*; G. *retten* or *erretten*; allied, probably, to W. *rhidiaw*, to secrete, to drain, that is, to separate or drive off, whence *riddle*.] 1. To free; to deliver; properly, to separate, and thus to deliver or save.

That he might *rid* him out of their hands; Gen. xxxvii.

I will *rid* you out of their bondage; Exod. vi.

2. To separate; to drive away.

I will *rid* evil beasts out of the land; Lev. xxvi.

[This use is not common.]—3. To free; to clear; to disencumber; as, to *rid* one of his care. It is not easy to *rid* the sea of pirates.

Resolved to *rid* himself of pain. *Dryden*.

4. To despatch.

For willingness *rids* away. *Shak.*

5. To drive away; to remove by violence; to destroy.

Ah death's men! you have *rid* this sweet young prince. *Shak.*

**RID, pp. or a.** Free; clear; as, to be *rid* of trouble. To get *rid* of, To free one's self.

**RID'DANCE, n.** Deliverance; a setting free; as, *riddance* from all adversity.—2. Disencumbrance.—3. The act of clearing away.

Thou shalt not make clean *riddance* of the corners of thy field; Lev. xxiii.

**RID'DEN, } pp. of Ride.**

**RID'DING, ppr.** Freeing; clearing; disencumbering.

**RID'DLE, n.** [Sax. *hriddel*; W. *rhidyll*, from *rhidiaw*, to secrete, to separate; Ir. *criathar*, a riddle; *cratham*, to shake; G. *rüttelein*, to shake, to riddle; W. *crydu*, to shake; allied to *rid* and to *cradle*, from driving. See **CRADLE**.] An instrument for cleaning grain, being a large sieve with a perforated bottom, or texture of basket-work, which permits the grain to pass through it, but retains the chaff.

**RID'DLE, v. t.** To separate, as grain from the chaff with a riddle; as, to *riddle* wheat.—2. To perforate with balls; to make little holes in, as a house *riddled* with shot.

**RID'DLE, n.** [Sax. *rædelse*; G. *rätshel*; from Sax. *ræden*, G. *rathen*, to counsel

or advise, also to guess. See **READ**.] 1. An enigma; something proposed for conjecture, or that is to be solved by conjecture; a puzzling question; an ambiguous proposition; Judg. xiv.—2. Any thing ambiguous or puzzling.

**RID'DLE, v. t.** To solve; to explain; but we generally use *unriddle*, which is more proper.

*Riddle* me this, and guess him if you can. *Dryden*.

**RID'DLE, v. i.** To speak ambiguously, obscurely, or enigmatically.

**RID'DLER, n.** One who speaks ambiguously or obscurely.

**RID'DLING, n.** That which is deposited by riddling.

**RID'DLINGLY, adv.** In the manner of a riddle; secretly.

**RIDE, v. i. pret. rode; pp. ridden. Rid,** for the *pret.* and *part.* is not now used, and *rode* for the *part.*, frequently used in colloquial style for *ridden*, is to be carefully avoided as erroneous. [Sax. *ridan*; G. *reiten*; W. *rhedu*, to run; L. *rheda*, a chariot or vehicle; Sax. *rad*, a riding or a road; Ir. *ratha*, *riadh*, a running; *reatham*, to run; *ridre*, a knight; allied to *ready*, G. *bereit*; *bereitem*, to ride, and to get *ready*. See **READY**.] 1. To be carried on horseback, or on any beast, or in any vehicle. We *ride* on a horse, on a camel, in a coach, chariot, waggon, &c. But although this verb in popular usage signifies to be carried in any vehicle as well as to be borne on horseback, yet when an excursion in a carriage or other vehicle is intended, the fashionable expression is to *take a drive*.—2. To be borne on or in a fluid. A ship *rides* at anchor; the ark *rode* on a flood; a balloon *rides* in the air.

He *rode* on a cherub and did fly; yea, he did fly on the wings of the wind; Ps. xviii.

3. To be supported in motion.

Strong as the axle-tree  
On which heaven *rides*. *Shak.*

4. To practise riding. He *rides* often for his health.—5. To manage a horse well.

He *rode*, he fenced, he moved with graceful ease. *Dryden*.

6. To be supported by something subservient; to sit.

On whose foolish honesty  
My practices *rid* easy. *Shak.*

To *ride* easy, in seamen's language, is when a ship does not labour or feel a great strain on her cables. To *ride hard*, is when a ship pitches violently, so as to strain her cables, masts, and hull. To *ride out*, as a gale, signifies that a ship does not drive during a storm. To *ride hard to wind*, is when the wind is so much more powerful than the tide, as to cause the ship to swing till her head is in the direction of the former. To *ride athwart*, or *between wind and tide*, is when the wind and tide are in opposition, but so nearly equal in their force that the ship rides with the tide running against one side, and the wind blowing upon the other. A rope is said to *ride*, when one of the turns by which it is wound lies over another, so as to interrupt the operation or prevent its rendering.

**RIDE, v. t.** To sit on, so as to be carried; as, to *ride* a horse.

They *ride* the air in whirlwind. *Milton*.

2. To manage insolently at will; as in priest-*ridden*.

The nobility could no longer endure to be *ridden* by bakers, cobblers, and brewers. *Swift*.

3. To carry. [Local.]

**RIDE, n.** An excursion on horseback or in a vehicle.—2. A saddle horse. [Local.]—3. A road cut in a wood or through pleasure ground, for the amusement of riding; a riding.

**RIDEAU, n.** (rido') [Fr.] In *fort.*, a small elevation of earth extending itself lengthwise on a plain, serving to cover a camp from the approach of the enemy, or to give other advantage to a post.

**RIDER, n.** One who is borne on a horse or other beast, or in a vehicle.—2. One who breaks or manages a horse.—3. The matrix of an ore.—4. Any addition to a manuscript, or other document, inserted after its first completion, on a separate piece of paper; an additional clause, as to a bill in parliament. It is also called a  *rider-roll*.—5. In *ship building*, a sort of interior rib fixed occasionally in a ship's hold, opposite to some of the timbers to which they are bolted, and reaching from the keelson to the beams of the lower deck, to strengthen her frame.—6. A name given to a second tier of casks in a vessel's hold.—7. In *gun.*, a piece of wood in a gun-carriage upon which the side pieces rest.—8. Formerly, one who travelled for a mercantile house to collect orders, money, &c. now called a *traveller*.

**RIDERLESS, a.** Having no rider.

**RIDGE, n.** [Sax. *rig*, *ricy*, *hric*, *hricg*, the back; G. *rücken*. The Welsh has *rhig*, a notch or groove, and *rhug*, a trench or furrow between ridges. The Dutch has *reeks*, a ridge, chain, or series, and the Dan. *rekke* is a row, rank, range, a file, and a *ridge*, from the root of *rekker*, to reach. If connected with the latter word, the primary sense is to draw or stretch, L. *rugeo*.] 1. The back or top of the back.—2. A long or continued range of hills or mountains; or the upper part of such a range. We say, a long *ridge* of hills; or the highest *ridge*.—3. A steep elevation, eminence, or protuberance. Part rise in crystal wall, or *ridge* direct. *Milton*.

4. A long rising land, or a strip of ground thrown up by a plough or left between furrows; Ps. lxxv. In *agric.*, ridges are beds of ground formed by furrow slices running the whole length of the field, and varying in breadth according to circumstances, and divided from one another by gutters or open furrows, parallel to each other, which last serve as guides to the hand and eye of the sower, to the reapers, and also for the application of manures in a regular manner. In wet soils they also serve as drains for carrying off the surface water. Ridges are raised more or less in the middle on different soils.—5. The highest part of the roof of a building. But in *arch.*, the term is more particularly applied to the meeting of the upper end of the rafters.

When the upper end of the rafters abut against a horizontal piece of timber it is called a *ridge-piece*, or *ridge-plate*. Ridge is also used to signify the internal angle or nook of a vault. *Ridge tile*, a convex tile made for covering the ridge of a roof.—6. Any long elevation of land. Also, a long narrow assemblage of rocks lying near the surface of the sea.—7. *Ridges* of a horse's mouth, are wrinkles or risings of flesh in the roof of the mouth.

**RIDGE, v. t.** To form a ridge; as, bristles that *ridge* the back of a boar.—2. In *tillage*, to form into ridges with

the plough. [See the Noun.]—3. To wrinkle.

RIDGE PIECE, } n. A piece of timber  
RIDGE PLATE, } at the ridge of a  
roof, against which the rafters abut.

RIDGE'ED, *pp.* Formed into ridges; wrinkled.

RID'GEL, or RIDGE'LING, *n.* An animal of the male kind half castrated. Called also *Rigsie* and *Rig*.

RIDG'ING, *ppr.* Forming into a ridge; wrinkling.

RIDG'ING, *n.* In *agric.*, the operation of forming land into ridges by the plough, or by digging or trenching.

RIDG'Y, *a.* Having a ridge or ridges; rising in a ridge.

RID'ICULE, *n.* [Fr. from L. *ridiculum*, from *rideo*, to laugh or laugh at; Fr. *ridier*, to wrinkle, to bend the brow; Arm. *redenna*.] 1. Contemptuous laughter; laughter with some degree of contempt; derision; wit of that species which provokes contemptuous laughter. It expresses less than *scorn*. *Ridicule* is aimed at what is not only laughable, but improper, absurd, or despicable. Sacred subjects should never be treated with *ridicule*. [See LUDICROUS.]

*Ridicule* is too rough an entertainment for the polished and refined. It is banished from France, and is losing ground in England. *Kames*.

2. That species of writing which excites contempt with laughter. It differs from *burlesque*, which may excite laughter without contempt, or it may provoke derision. *Ridicule* and *derision* are not exactly the same, as *derision* is applied to persons only, and *ridicule* to persons or things. We *deride* the man, but *ridicule* the man or his performances. *Ridicule* is a dangerous weapon.

RID'ICULE, *v. t.* To laugh at with expressions of contempt; to deride.—2. To treat with contemptuous merriment; to expose to contempt or derision by writing.

RID'ICULE, *†a.* Ridiculous. [Not in use.]

RID'ICULED, *pp.* Treated with laughter and contempt; derided.

RID'ICULER, *n.* One that ridicules.

RID'ICULING, *ppr.* Laughing at in contempt; exposing to contempt and derision.

RIDIC'ULOUS, *a.* [L. *ridiculus*; It. *ridicoloso*.] That may justly excite laughter with contempt; as, a *ridiculous* dress; *ridiculous* behaviour. A fop and a dandy are *ridiculous* in their dress. RIDIC'ULOUSLY, *adv.* In a manner worthy of contemptuous merriment; as, a man *ridiculously* vain.

RIDIC'ULOUSNESS, *n.* The quality of being ridiculous; as, the *ridiculousness* of worshipping idols.

RIDING, *ppr.* [from *ride*.] Passing or travelling on a beast or in a vehicle; floating.—2. *a.* Employed to travel on any occasion.

No suffragan bishop shall have more than one *riding* apparitor. *Ayliffe*.

RIDING, *n.* 1. A ride; a district visited by an officer.—2. A road cut in a wood, or through pleasure grounds, for the diversion of riding therein, called also a *ride*.—3. [Corrupted from *trithing*, third.] One of the three intermediate jurisdictions between a three and a hundred, into which the county of York, in England, is divided, anciently under the government of a reeve. These are called the *North*, *East*, and *West Ridings*.—*Riding*, in *naval affairs*, is the state of a ship's being detained in a

particular station, by means of one or more cables with their anchors.—*Riding interests*. In *Scots law*, when any of the claimants in an action of multiple-pounding, or in a process of ranking and sale, have creditors, these creditors may claim to be ranked on the fund set aside for their debtor; and such claims are called *riding interests*.

RIDING-CLERK, *n.* A mercantile traveller; also, one of the six clerks formerly in chancery.

RIDING-COAT, *n.* A coat for riding on a journey.

RIDING-HABIT, *n.* A garment worn by females when they ride or travel.

RIDING-HOOD, *n.* A hood formerly used by females when they rode; a kind of cloak with a hood.

RIDING-SCHOOL, *n.* A school or place where the art of riding is taught. It may, in some places, be called a *riding-house*.

RIDOTTO, *n.* [It. from L. *reductus*.] 1. A public assembly.—2. A musical entertainment consisting of singing and dancing, in the latter of which the whole company join. It is a favourite public Italian entertainment, held generally on fast eves.

RIE. See RYE.

RIEF, *n.* In *Scots law*, an obsolete term synonymous with robbery. [See REIF.]

RIFACIMENTO, *n.* [Ital.] A remaking or re-establishment, a term most commonly applied to the process of recasting literary works, so as to adopt them to a changed state of circumstances; as when a work written in one age or country is modified to suit the circumstances of another.

RIFE, *a.* [Sax. *ryfe*. Qu. Heb. ריב, *rabah*, to multiply.] Prevailing; prevalent; abundant.

The plague was then *rife* in Hungary. *Knolles*.

RIFELY, *adv.* Prevalently; frequently. It was *rifely* reported that the Turks were coming in a great fleet. *Knolles*.

RIFENESS, *n.* Frequency; prevalence. RIF'RAFF, *n.* [Fr. *rifler*; G. *raffen*, to sweep; Dan. *rips*, *raps*.] Sweepings; refuse of any thing. [Colloq.]

RIFLE, *v. t.* [Fr. *rifler*, to rifle, to sweep away; allied probably to *friper* and *griveler*; G. *raffen*, to sweep; *riffeln*, to hatchel. This is one of the family of *rip*, *rive*, *reap*, *raffle*, L. *rapio*, W. *rheibiau*, D. *ryven*, to grate, Eng. *rub*, &c.] 1. To seize and bear away by force; to snatch away. Till time shall *rifle* ev'ry youthful grace. *Pope*.

2. To strip; to rob; to pillage; to plunder.

You have *rifled* my master. *L'Estrange*. RIFLE, *n.* [Dan. *rifle*, or *riffle*, the rifle of a gun; *riffelbasse*, a rifle gun; G. *retfeln*, to chamber, to rifle. This word belongs to the family of *rip*, *rive*, L. *rapio*, &c. snpra. The word means primarily a channel or groove.] A gun about the usual length and size of a musket, the inside of whose barrel is *rifled*, that is, grooved, or formed with spiral channels. The object of the rifling is to give the ball a rotatory motion about an axis, in consequence of which it preserves its direction with much greater certainty than when fired from the common *clear* barrel.

RIFLE, *v. t.* To groove; to channel.

RIFLED, *pp.* Seized and carried away by violence; pillaged; furrowed with spiral channels or grooves; as a rifle gun.

RIFLEBIRD, *n.* A bird of the genus *Phloris*, the *P. paradiseus* of Swainson, found in New Holland.

RIFLEMAN, *n.* A man armed with a rifle. *Riflemen*, a body of men armed with rifles; as, the *rifle brigade*. The 60th infantry regiment is a rifle corps. The duties of riflemen correspond nearly to those of light infantry troops.

RIFLER, *n.* A robber; one that seizes and bears away by violence.

RIFLING, *ppr.* Plundering; seizing and carrying away by violence; grooving. RIFT, *n.* [from *rive*.] A cleft; a fissure; an opening made by riving or splitting.

RIFT, *n.* [D. *rif*.] A shallow place in a stream; a fording place. [Local.]

RIFT, *v. t.* To cleave; to rive; to split; as, to *rift* an oak or a rock.

RIFT, *v. i.* To burst open; to split. Timber . . . not apt to *rift* with ordnance.

2. To belch. [Scotch.] [Baem. RIFTED, *pp.* Split; rent; cleft.

RIFTING, *ppr.* Splitting; cleaving; bursting.

RIFTING, *n.* The operation of splitting, riving, or dividing; as stones or rocks by means of gunpowder.

RIG, *n.* [Sax.] A ridge,—*which see*.

RIG, *v. t.* [Sax. *wrigan*, to put on, to cover, whence Sax. *hrægle*, a garment, contracted into *rail*, in *night-rail*.] 1. To dress; to put on; when applied to persons, not elegant, but rather a ludicrous word, to express the putting on of a gay, haunting, or unusual dress.

Jack was *rigged* out in his gold and silver lace, with a feather in his cap. *L'Estrange*.

2. To furnish with apparatus or gear; to fit with tackling; as, to *rig* a purchase.—3. To *rig* a ship, in *seamen's language*, is to fit the shrouds, stays, braces, &c., to their respective masts and yards. To *rig* out a boom, to run out a pole upon the end of a yard or bowsprit, to extend the foot of a sail.

To *rig* in a boom, to draw it in from its situation upon the end of a yard or bowsprit, &c. *Well rigged*, an epithet for a ship when her ropes are of a size proportioned to her burden. When the ropes are too large the ship is said to be *over-rigged*.

RIG, *n.* [See the Verb.] Dress. 2. A romp; a wanton; a strumpet. In *Scotch*, *rig* signifies a frolic.—3. In *marine language*, the peculiar manner of fitting the masts and rigging to the hull of any vessel; thus, schooner-*rig*, ship-*rig*, &c., imply the masts and sails of those vessels without regard to the hull.—4. A *ridgel*,—*which see*. To *run the rig*, to play a wanton trick. To *run the rig* upon, to practise a sportive trick on.

RIG, *v. i.* To play the wanton.

RIGADOON', *n.* [Fr. *rigodon*.] A gay brisk dance performed by one couple, and said to have been borrowed from Provence in France.

RIGATION, *n.* [L. *rigatio*, from *rigo*, Gr. ῥίγνυμι. See RAIN.] The act of watering; but *irrigation* is generally used.

RIG'EL, *n.* A bright fixed star of the first magnitude in the left foot of the constellation Orion.

RIG'GED, *pp.* Dressed; furnished with shrouds, stays, &c. as a ship.

RIG'GER, *n.* One that rigs or dresses; one whose occupation is to fit the rigging of a ship.—2. In *machinery*, a cylindrical pulley, known also by the term *drum*.



**RIG'GING**, *ppr.* Dressing; fitting with shrouds, braces, &c.

**RIG'GING**, *n.* Dress; tackle; particularly, the ropes which support the masts, extend and contract the sails, &c. of a ship. This is of two kinds, *standing rigging*, as the shrouds and stays; and *running rigging*, comprehending all those ropes used in bracing the yards, making and shortening sails, &c. such as braces, sheets, halliards, clewlines, &c. The *lower rigging*, implies that of the lower masts; the *topmast rigging*, that of the topmast, and so on. *Rigging loft*, in dock-yards, the room or rooms in which the rigging is prepared.

**RIG'GISH**, *† a.* Wanton; lewd.

**RIG'GLE**, *v. i.* To move one way and the other. [See **WRIGGLE**.]

**RIGHT**, *a. rite*. [Sax. *riht*, *reht*; G. *recht*; L. *rectus*, from the root of *rego*, properly to strain or stretch, whence *straight*; Sax. *recan*.] Properly, strained; stretched to straightness; hence, 1. Straight, not crooked, direct; passing from point to point the shortest way. A *right line* in geometry is the shortest line that can be drawn or imagined between two points. A *right line* may be horizontal, perpendicular, or inclined to the plane of the horizon. *Right angle*, *cone*, *cylinder*, *sphere*, *ascension*, &c. [See the respective nouns.]

2. In *morals* and *religion*, just; equitable; accordant to the standard of truth and justice or the will of God. That alone is *right* in the sight of God, which is consonant to his will or law; this being the only perfect standard of truth and justice. In social and political affairs, that is *right* which is consonant to the laws and customs of a country, provided these laws and customs are not repugnant to the laws of God. A man's intentions may be *right*, though his actions may be wrong in consequence of a defect in judgment.—3. Fit; suitable; proper; becoming. In things indifferent, or which are regulated by no positive law, that is *right* which is best suited to the character, occasion, or purpose, or which is fitted to produce some good effect. It is *right* for a rich man to dress himself and his family in expensive clothing, which it would not be *right* for a poor man to purchase. It is *right* for every man to choose his own time for eating or exercise. *Right* is a relative term; what may be *right* for one end, may be *wrong* for another.—4. Lawful; as, the *right heir* of an estate.—5. True; not erroneous or wrong; according to fact.

If there be no prospect beyond the grave, the inference is certainly *right*, "Let us eat and drink, for to-morrow we die." *Locke*.

6. Correct; passing a true judgment; not mistaken or wrong. You are *right*, justice, and you weigh this well. *Shak.*

7. Not left, but its opposite; most convenient or dextrous; strong or stronger, with reference to something else; as, the *right hand*, which is generally most strong or most convenient in use. [See **RIGHT HAND**.] 8. Most favourable or convenient.

The lady has been disappointed on the *right side*. *Spectator*.

9. Properly placed, disposed, or adjusted; orderly; well regulated.—10. Well performed, as an art or act.—11. Most direct; as, the *right way* from London to Oxford.—12. Being on the same side as the *right hand*; as, the *right side*.—13. Being on the right

hand of a person whose face is toward the mouth of a river; as, the *right bank* or *Kent side* of the Thames.

**RIGHT**, *adv.* In a right or straight line; directly.

Let thine eyes look *right* on; *Prov. iv.* 2. In a right manner; justly; properly. According to the law or will of God, or to the standard of truth and justice; as, to judge *right*.—3. According to any rule of art.

You with strict discipline instructed *right*. *Roscommon.*

4. According to fact or truth; as, to tell a story *right*.—5. In a great degree; very; as, *right humble*; *right noble*; *right valiant*. [Obsolescent or *inelegant*.] 6. It is prefixed to titles; as, in *right* honourable; *right* reverend.

**RIGHT**, is used elliptically for *it is right*, *what you say is right*, *it is true*, &c. *Right*, cries his lordship. *Pope.*

[In this sense, however, it may be considered as an approbatory interjection.] *On the right*, on the side with the right hand.

**RIGHT**, *n.* Conformity to the will of God, or to his law, the perfect standard of truth and justice. In the literal sense, *right* is a straight line of conduct, and *wrong* a crooked one. *Right* therefore is rectitude or straightness, and perfect rectitude is found only in an infinite Being and his will.—2. Conformity to human laws, or to other human standard of truth, propriety, or justice. When laws are definite, *right* and *wrong* are easily ascertained and understood. In arts, there are some principles and rules which determine what is *right*. In many things indifferent, or left without positive law, we are to judge what is right by fitness or propriety, by custom, civility, or other circumstances.—3. Justice; that which is due or proper; as, to do *right* to every man.

Long love to her has borne the faithful knight,

And well deserved, had fortune done him *right*. *Dryden.*

4. Freedom from error; conformity with truth or fact.

Seldom your opinions err,

Your eyes are always in the *right*. *Prior.* 5. Just claim; legal title; ownership; the legal power of exclusive possession and enjoyment. In hereditary monarchies, a *right* to the throne vests in the heir on the decease of the king. A deed vests the *right* of possession in the purchaser of land. Right and possession are very different things. We often have occasion to demand and sue for *rights* not in *possession*.—6. Just claim by courtesy, customs, or the principles of civility and decorum. Every man has a *right* to civil treatment. The magistrate has a *right* to respect.

—7. Just claim by sovereignty; prerogative. God, as the author of all things, has a *right* to govern and dispose of them at his pleasure.—8. That which justly belongs to one.

Born free he sought his *right*. *Dryden.*

9. Property; interest.

A subject in his prince may claim a *right*. *Dryden.*

10. Just claim; immunity; privilege. All men have a *right* to the secure enjoyment of life, personal safety, liberty, and property. We deem the *right* of trial by jury invaluable, particularly in the case of crimes. *Rights* are natural, civil, political, religious, personal, and public.—11. Authority; legal power.

11. Authority; legal power.

11. Authority; legal power.

11. Authority; legal power.

The police have a *right* to arrest malefactors.—12. In the *United States*, a tract of land; or a share or proportion of property, as in a mine or manufactory.—13. The side opposite to the left; as, on the *right*. Look to the *right*.—*Right side of a roadway or water way*, the proper side on which to pass. A vehicle or vessel overtaking another should pass on the right hand side, when meeting another it should pass on the left hand side.—*Right side of a foot-path*, the side on which the pedestrian ought to walk, being always the one on his right hand.—*Right* in law, includes not only every right for which a writ of right lies, but also any title or claim by virtue of a condition, mortgage, &c. for which no action is given by law, but only an entry. There is a *right of property*, a *right of possession*, a *right both of property and possession*, a *present and a future right*, &c. In *Scots law*, rights are divided into *heritable and moveable*.—*To rights*, in a direct line; straight. [Unusual.] 2. Directly; soon.—*To set to rights*, or, *to put to rights*, to put into good order; to adjust; to regulate what is out of order.—*Bill of rights*, a list of rights; a paper containing a declaration of rights, or the declaration itself. Specially, the declaration delivered by the two houses of parliament to the Prince of Orange, Feb. 13, 1688; in which, after a full specification of various acts of James II., which were alleged to be illegal, the rights and privileges of the people were asserted.—*Right of property*, in *pol. econ.*, the right which states, bodies of individuals, and individuals, have to use and enjoy such lands, natural powers, and products, as have been appropriated and set apart.—*Right of way*, a liberty of passage along roads, streets, footpaths, &c., vested in the public or individuals by statute or common law, prescription, or private agreement.

The proper origin of a private *right of way* is, a grant from the owner of the soil, whose means of enjoying his own property are abridged thereby. *P. Ency.* In *England*, the act 2 and 3 Wm. 4, c. 71, modified the *right of way*. In *Scotland*, it is generally constituted by forty years' prescription; and when the public have been in the uninterrupted use of such road or footpath for such a period, or from time immemorial, the proprietor cannot shut it up or create an obstruction. Such are kirk or market roads, footpaths along the banks of rivers, &c.—*Writ of right*, a writ which lies to recover lands in fee simple, unjustly withheld from the true owner.

**RIGHT**, *v. t.* To do justice to; to relieve from wrong; as, to *right* an injured person.—2. In *seamen's language*, to *right a ship*, is to restore her to an upright position after careening.—*To right the helm*, to place it in the middle of the ship.

**RIGHT**, *v. i.* To rise with the masts erect, or the deck level, as a ship.

**RIGHT AN'GLE**, *n.* In *geom.*, an angle of ninety degrees, or one which is measured by a quadrant. [See **ANGLE**.]

**RIGHT AN'GLED**, *a.* Containing a right angle or right angles; as, a *right angled triangle*; a *right angled parallelogram*, &c.

**RIGHT AN'GLED**, *a.* Containing a right angle or right angles; as, a *right angled triangle*; a *right angled parallelogram*, &c.

**RIGHT AN'GLED**, *a.* Containing a right angle or right angles; as, a *right angled triangle*; a *right angled parallelogram*, &c.

**RIGHT AN'GLED**, *a.* Containing a right angle or right angles; as, a *right angled triangle*; a *right angled parallelogram*, &c.

**RIGHT AN'GLED**, *a.* Containing a right angle or right angles; as, a *right angled triangle*; a *right angled parallelogram*, &c.

**RIGHT AN'GLED**, *a.* Containing a right angle or right angles; as, a *right angled triangle*; a *right angled parallelogram*, &c.

**RIGHT AN'GLED**, *a.* Containing a right angle or right angles; as, a *right angled triangle*; a *right angled parallelogram*, &c.

**RIGHT AN'GLED**, *a.* Containing a right angle or right angles; as, a *right angled triangle*; a *right angled parallelogram*, &c.

**RIGHT AN'GLED**, *a.* Containing a right angle or right angles; as, a *right angled triangle*; a *right angled parallelogram*, &c.

**RIGHT AN'GLED**, *a.* Containing a right angle or right angles; as, a *right angled triangle*; a *right angled parallelogram*, &c.

**RIGHT AN'GLED**, *a.* Containing a right angle or right angles; as, a *right angled triangle*; a *right angled parallelogram*, &c.

**RIGHT AN'GLED**, *a.* Containing a right angle or right angles; as, a *right angled triangle*; a *right angled parallelogram*, &c.

**RIGHT AN'GLED**, *a.* Containing a right angle or right angles; as, a *right angled triangle*; a *right angled parallelogram*, &c.

**RIGHT AN'GLED**, *a.* Containing a right angle or right angles; as, a *right angled triangle*; a *right angled parallelogram*, &c.

**RIGHT AN'GLED**, *a.* Containing a right angle or right angles; as, a *right angled triangle*; a *right angled parallelogram*, &c.

**RIGHT AN'GLED**, *a.* Containing a right angle or right angles; as, a *right angled triangle*; a *right angled parallelogram*, &c.

**RIGHT AN'GLED**, *a.* Containing a right angle or right angles; as, a *right angled triangle*; a *right angled parallelogram*, &c.

**RIGHT AN'GLED**, *a.* Containing a right angle or right angles; as, a *right angled triangle*; a *right angled parallelogram*, &c.



In the above quadrangle all the inner angles are Right angles.

RIGHTED, *pp.* Relieved from injustice; set upright.

RIGHTEN, *v. t.* [Sax. *gerihtan.*] To do justice to.

RIGHTEOUS, *a.* (ri'chus.) [Sax. *riht- wise*; *right* and *wise*, manner, as in *otherwise*, *lengthwise*.] 1. Just; upright; honest; incurrunt; accordant to the divine law. *Applied to persons*, it denotes one who is holy in heart, and observant of the divine commands in practice; as, a *righteous* man. *Applied to things*, it denotes consonant to the divine will or to justice; as, a *righteous* act. It is used chiefly in theology, and applied to God, to his testimonies, and to his saints.—*The righteous*, in scripture, denote the servants of God, the saints.—2. Just; equitable; merited.

And I thy *righteous* doom will bless. *Dryden.*  
RIGHTEOUSLY, *adv.* (ri'chusly.) Justly; in accordance with the laws of justice; equitably; as, a criminal *righteously* condemned.

Thou shalt judge the people *righteously*; Ps. lxxii.

RIGHTEOUSNESS, *n.* (ri'chusness.) Purity of heart and rectitude of life; conformity of heart and life to the divine law. *Righteousness*, as used in scripture and theology, in which it is chiefly employed, is nearly equivalent to holiness, comprehending holy principles and affections of heart, and conformity of life to the divine law. It includes all we call justice, honesty, and virtue, with holy affections; in short, it is true religion.—2. *Applied to God*, the perfection or holiness of his nature; exact rectitude; faithfulness.—3. The active and passive obedience of Christ, by which the law of God is fulfilled; Dan. ix.—4. Justice; equity between man and man; Luke i.—5. The cause of our justification.

The Lord our *righteousness*; Jer. xxiii.  
RIGHTER, *n.* One who sets right; one who does justice or redresses wrong.

RIGHTFUL, *a.* Having the right or just claim according to established laws; as, the *rightful* heir to a throne or an estate.—2. Being by right, or by just claim; as, a *rightful* lord; *rightful* property; *rightful* judge.—3. Just; consonant to justice; as, a *rightful* cause; a *rightful* war.

RIGHTFULLY, *adv.* According to right, law, or justice; as, a title *rightfully* vested.

RIGHTFULNESS, *n.* Justice; accordance with the rules of right; as, the *rightfulness* of a claim to lands or tenements.—2. Moral rectitude.

But still although we fail of perfect *rightfulness*. [Not usual.] *Sidney.*

RIGHT HAND, *n.* The hand opposite to the left, usually the most employed, the strongest, most convenient or dextrous hand, and hence its name in other languages, as well as in ours.—In *scripture*, the *right hand* denotes power or strength, and God's *right hand* is generally used to denote the effects of his omnipotence.—*To seat a person at the right hand*, is in scripture language a token of peculiar honour, and when Christ is said to be seated at God's *right hand*, it imports unequalled dignity and exaltation.

RIGHT-HEARTED, *a.* Having right dispositions.

RIGHTING, *ppr.* Doing justice to; setting upright.

RIGHTLESS, *a.* Destitute of right.

RIGHTLY, *adv.* According to justice;

according to the divine will or moral rectitude; as, duty *rightly* performed.—2. Properly; fitly; suitably; as, a person *rightly* named.—3. According to truth or fact; not erroneously. He has *rightly* conjectured.—4. Honestly; uprightly.—5. Exactly.

Thou didst not *rightly* see. *Dryden.*  
6.† Straightly; directly.

RIGHT-MINDED, *a.* Having a right or honest mind.

RIGHT-MINDEDNESS, *n.* The state of having a right mind.

RIGHTNESS, *n.* Correctness; conformity to truth or to the divine will, which is the standard of moral rectitude. It is important that a man should have such persuasion of the *rightness* of his conscience as to exclude rational doubt.—2. Straightness; as, the *rightness* of a line.

RIGHT-RUNNING, *a.* Straight running.

RIGHT WHALE, *n.* The common whale, from whose mouth whalebone is obtained, as distinguished from the spermaceti whale.

RIG'ID, *a.* [Fr. *rigide*; L. *rigidus*, from *rigeo*; Gr. *βίβω*, to be stiff; *βίβω*, stiff, whence L. *frigeo*, *frigidus*; Eth. *raga*, Heb. *גָּרָה*, *raga*, to be still, to be stiff or rigid. The primary sense is probably to strain or extend.] 1. Stiff; not pliant; not easily bent. It is applied to bodies or substances that are naturally soft or flexible, but not fluid. We never say, a *rigid* stone, or *rigid* iron, nor do we say, *rigid* ice; but we say, an animal body or limb, when cold, is *rigid*. *Rigid* is then opposed to *flexible*, but expresses less than *inflexible*.—A *rigid body*, in *mech.*, is one which resists any change of form when acted on by any force or forces. [See RIGIDITY.]—2. Strict in opinion, practice, or discipline; severe in temper; opposed to *lax* or *indulgent*; as, a *rigid* father or master; a *rigid* officer.—3. Strict; exact; as, a *rigid* law or rule; *rigid* discipline; *rigid* criticism.—4. Severely just; as, a *rigid* sentence or judgment.—5. Exactly according to the sentence or law; as, *rigid* execution.

RIGIDITY, *n.* [Fr. *rigidité*; L. *rigiditas*.] 1. Stiffness; want of pliability; the quality of not being easily bent.—In *mech.*, a resistance to change of form. In all theoretical investigations respecting the application of forces through the intervention of machines, those machines are assumed (except cords) to be perfectly rigid, so far as the forces employed are able to affect their integrity of form and structure. *Rigidity* in the arts is often called *stiffness*, and is opposed to flexibility. The *rigidity of cords*, or the difficulty with which they are bent into any given curve, is the chief cause of the loss of power arising from their employment in machines. The force necessary to bend a rope is directly as its diameter, directly as the tension, and inversely as the diameter of the pulley or axle round which it is wound.—2. A brittle hardness, as opposed to *ductility*, *malleability* and *softness*.—3. Stiffness of appearance or manner; want of ease or airy elegance.—4. Strictness; severity. In this sense *rigidness* is more generally used.

RIG'IDLY, *adv.* Stiffly; unpliantly.—2. Severely; strictly; exactly; without laxity, indulgence, or abatement; as, to judge *rigidly*; to criticise *rigidly*; to execute a law *rigidly*.

RIG'IDNESS, *n.* Stiffness of a body;

the quality of not being easily bent; as, the *rigidness* of a limb or of flesh.—2. Severity of temper; strictness in opinion or practice; but expressing less than *inflexibility*.

RIG'LET, *n.* [Fr. *reglet*, from L. *regula*.] A flat thin piece of wood, used for picture-frames; also used in printing, to regulate the margin, &c. [See REGLET.]

RIG'MAROLE, *n.* A repetition of stories; loose disjointed talk or writing.

RIG'OL, *n.* A circle; a diadem.

RIG'OLL, *n.* A musical instrument consisting of several sticks bound together, but separated by beads.

RIG'OR, *n.* [L. from Gr. *βίβω*, to shiver.] In *med.*, a sudden coldness, attended by a shivering more or less perfect; a symptom which ushers in many diseases, especially fevers and acute inflammation of internal parts. It is also produced by nervous complaints.

RIG'OROUS, *a.* [Fr. *rigoureux*.] 1. Severe; allowing no abatement or mitigation; as, a *rigorous* officer of justice.—2. Severe; exact; strict; without abatement or relaxation; as, a *rigorous* execution of law; an enforcement of *rigorous* discipline.—3. Exact; strict; scrupulously accurate; as, a *rigorous* definition or demonstration.—4. Severe; very cold; as, a *rigorous* winter.

RIG'OROUSLY, *adv.* Severely; without relaxation, abatement, or mitigation; as, a sentence *rigorously* executed.—2. Strictly; exactly; with scrupulous nicety; rigidly.

The people would examine his works more *rigorously* than himself. *Dryden.*

RIG'OROUSNESS, *n.* Severity without relaxation or mitigation; exactness.—2. Severity.

RIG'OUR, *n.* [L. from *rigeo*, to be stiff; Fr. *rigueur*.] 1. Stiffness; rigidity; as, Gorgonian *rigour*.—2. Stiffness of opinion or temper; severity; sternness.

All his *rigour* is turned to grief and pity. *Denham.*

3. Severity of life; austerity; voluntary submission to pain, abstinence, or mortification.—4. Strictness; exactness without allowance, latitude, or indulgence; as, the *rigour* of criticism; to execute a law with *rigour*; to enforce moral duties with *rigour*.—5.† Violence; fury.—6. Hardness; solidity. [Unusual].—7. Severity; asperity; as, the *rigours* of a cold winter.

RIG'OURIST, *n.* One very rigorous.

RILIEVO. [It.] See RELIEF, No. 5.

RILL, *n.* [In G. *rille*, W. *rhill*, is a groove, trench, channel, the root of *drill*. In Sw. *strila* is to run or glide; Dan. *ryller*, to ramble.] A small brook; a rivulet; a streamlet.

RILL, *v. t.* To run in a small stream; or in streamlets.

RILL'ET, *n.* A small stream; a rivulet.

RIM, *n.* [Sax. *rima* and *reoma*, a rim, a ream; W. *rhim* and *rhimp*, a rim, edge, termination; hence *crimp*, a sharp ridge; *crimpjaw*, to form into a ridge, also to pinch. *Rim*, like *ream*, *ramble*, is from extending; the *extremity*. In Russ. *kroma* is a border.] 1. The border, edge, or margin of a thing; as, the *rim* of a kettle or basin; usually applied to things circular or curving.—2. The lower part of the belly or abdomen.

RIM, *v. t.* To put on a rim or hoop at the border.

RIMA, *n.* [L.] A fissure, an opening; a long aperture, as the *rima glottidis*, the

opening in the larynx, through which the air passes in and out of the lungs.

**RIME**, *n.* [Sax. *rim*, number; *W. rhiv*. This is the more correct orthography, but *rhyme* is commonly used, — *which see.*]

**RIME**, *n.* [Sax. *hrim*; *D. rym*. In *G.* it is *reif*.] White or hoar frost; congealed dew or vapour.

**RIME**, *n.* [*L. rima*; *Sw. remna*, whence *remna*, to split; perhaps from the root of *rive*.] A chink; a fissure; a rent or long aperture.

**RIME**, *v. i.* To freeze or congeal into hoar frost.

**RIMMERS**, *n.* In *joinery*, bits or boring tools for making tapering holes; they are of pyramidal form, whose vertical angle is about  $3\frac{1}{2}$  degrees.

**RIMOSE**, } *a.* [*L. rimosus*, from *rima*.]  
**RIMOUS**, } In *bot.*, chinky; abounding with clefts, cracks, or chinks; as, the bark of trees. Applied also in *zool.*, when the surface of an animal or part resembles the bark of a tree.

**RIMOSITY**, *n.* The state of being rimous or chinky.

**RIMPLE**, *n.* [Sax. *hrympelli*.] A fold or wrinkle. [See **RUMPLE**.]

**RIMPLE**, *v. t.* To ruple; to wrinkle.

**RIMPLING**, *n.* Undulation.

**RIMY**, *a.* [from *rima*.] Abounding with rime; frosty.

**RIND**, *n.* [Sax. *rind* or *hrind*; *G. rinde*; *Gr. rhus*; *W. croen*, skin.] The skin or coat of fruit that may be pared or peeled off; also, the bark of trees. [Formerly spelt *rhind*.]

**RIND**, *† v. t.* To bark; to decorticate.

**RINDLE**, *n.* [from the root of *run*; *Dan. rinder*, to flow.] A small water-course or gutter.

**RINFORZANDO**. [It. strengthening.] In *music*, a direction to the performer, denoting that the sound is to be increased. It is marked thus <. When the sound is to be diminished (*diminuendo*), this mark > is used.

**RING**, *n.* [Sax. *ring* or *hring*; *G. D.* and *Sw. ring*, a circle; *Sw. kring*, about, around. This coincides with *ring*, to sound, and with *wring*, to twist; *G. ringen*, to ring or sound, and to wrestle. The sense is to strain or stretch, and *n* is probably not radical.] 1. A circle, or a circular line, or anything in the form of a circular line or hoop; a circle of gold or other substance worn as an ornament, or of strong metal to be held by; a circle of persons formed for a dance or for any other purpose. Thus we say of men, they formed themselves into a *ring*, to see a wrestling match. *Rings* of gold were made for the ark; *Exod. xxv.* *Rings* of gold or other material are worn on the fingers and sometimes in the ears, as ornaments.—2. A circular course.

Place me, O place me in the dusty *ring*,  
Where youthful charioteers contend for glory. *Smith.*

3. In *geom.*, the figure enveloping a sphere, which moves with its centre always in a given curve, most commonly a circle. Sometimes also applied to designate the area of the space between two concentric circles.—4. In *arch.*, the list, cincture, or annulet round a column.—*Fairy rings*. [See **FAIRY**.] *Ring of Saturn*, a broad opaque circular body encompassing the equatorial regions of that planet, at a considerable distance from him. Properly speaking it consists of two concentric rings separated from each other. When viewed under favourable circumstances it presents one of the finest

telescopic objects in the heavens.—*Coloured rings*, in *optical science*, the name given to those coloured circular bands which are familiarly seen in soap-bubbles of sufficient tenuity, in thin plates of mica, and generally in any transparent plate of small width, whether bounded by denser or by rarer media. Newton first supplied a careful examination of these coloured rings, and in explanation of their phenomena, he invented his theory of "Fits of easy transmission and of easy reflection of light." The systems of coloured rings produced by transmitting polarized light through transparent bodies that possess double refraction, are the most brilliant phenomena that can be exhibited. The colours produced by these bodies were first discovered, by independent observation, by M. Arago, and Sir David Brewster, and they have been studied with great success by M. Biot and other authors.—*Ring of an anchor*, that part of an anchor to which the cable is fastened.—*Rings of a gun*, in *gunnery*, circles of metal, of which there are five kinds, viz., the *base-ring*, *reinforce-ring*, *trunnion-ring*, *cornice-ring*, and *muzzle-ring*.

**RING**, *n.* [from the verb.] A sound; particularly, the sound of metals; as, the *ring* of a bell.—2. Any loud sound, or the sounds of numerous voices; or sound continued, repeated, or reverberated; as, the *ring* of acclamations.—3. A chime, or set of bells harmonically tuned.

**RING**, *v. t. pret. and pp. rung*, but *rang* is often used in the *pret.* for *ring*. [Sax. *ringan*, *hringan*; *G.* and *D. ringen*.] To cause to sound, particularly by striking a sonorous metallic body; as, to *ring* a bell. This word expresses appropriately the sounding of metals.

**RING**, *v. t.* [from the noun.] To encircle.—2. To fit with rings, as the fingers, or as a swine's snout. Farmers *ring* swine to prevent their rooting. And *ring* these fingers with thy household worms. *Shak.*

**RING**, *v. i.* To sound, as a bell or other sonorous body, particularly a metallic one.—2. To practise the art of making music with bells.—3. To sound; to resound.

With sweeter notes each rising temple *ring*. *Pope.*

4. To utter, as a bell; to sound. The shardborn beetle with his drowsy hums, Hath *ring* night's yawning peal. *Shak.*

5. To tinkle; to have the sensation of sound continued. My ears shall *ring* with noise. *Dryden.*

6. To be filled with report or talk. The whole town *rings* with his fame.

7. To form a circle.

**RING-BOLT**, *n.* In *ships*, an iron bolt with an eye, to which is fitted a ring of iron.

**RING-BONE**, *n.* A callus growing in the hollow circle of the little pastern of a horse, just above the coronet.

**RING-COURSE**, *n.* In *arch.*, the outer course of stone or brick in an arch.

**RING-DOVE**, *n.* [*G. ringeltaube*.] A species of pigeon, the *Columba palumbus*, the cushat, the largest of the European species. The term *ring-dove* is also applied to the collared turtle (*Columba risoria*, Linn.).

**RINGENT**, *a.* [*L. ringor*, to make wry faces, that is, to wring or twist.] In *bot.*, a ringent corol is one which is irregular and monopetalous, with the border divided into two parts, called

the upper and lower lip, the upper arched, so that there is a space between the two like an open mouth, called the throat. This kind of corolla is seen in rosemary, thyme, the dead-nettle, and other plants of the natural family of Labiate.

**RINGER**, *n.* One who rings. [In the sense of *winger*, not used.]

**RING-FENCE**, *n.* A fence encircling an estate within one entrance.

**RING-FINGER**, *n.* The third finger of the left hand, on which the ring is placed in marriage.

**RING-FORMED**, *a.* Formed like a ring.

**RINGING**, *ppr.* Causing to sound, as a bell; sounding; fitting with rings.

**RINGING**, *n.* The act of sounding or of causing to sound, as sonorous metallic bodies; the art or act of making music with bells.

**RING LEAD**, *v. t.* To conduct. [*Little used.*]

**RING LEADER**, *n.* [*ring* and *leader*.]

The leader of any association of men engaged in violation of law or an illegal enterprise, as rioters, mutineers, and the like. According to some this name is derived from the practice which men associating to oppose law have sometimes adopted, of signing their names to articles of agreement in a *ring*, that no one of their number might be distinguished as the leader. According to others it signified originally, one who took the lead in forming the *ring* of a dance.

**RINGLET**, *n.* [*dim of Ring*.] A small ring.—2. A curl; particularly, a curl of hair.

Her golden tresses lu wanton *ringlets* waved. *Milton.*

3. A circle. To dance our *ringlets* in the whistling wind. *Shak.*

**RING-OUZEL**, *n.* A bird of the thrush kind, (*Turdus torquatus*), inhabiting the hilly and mountainous parts of Great Britain.

**RING-ROPES**, *n.* In *ships*, short pieces of rope tied occasionally to the ring-bolts of the deck, to stopper or fasten the cable more securely when the ship rides with a heavy strain.

**RING-SHAPED**, *a.* Having the shape of a ring.

**RING-STREAKED**, *a.* [*ring* and *streak*.] Having circular streaks or lines on the body; as, *ring-streaked* goats; *Gen. xxx.*

**RING-TAIL**, *n.* [*ring* and *tail*.] The English name of the female of the hen-



a, b, Ring tail or Studding sail set upon the Gali.

harrier (*circus cyaneus*), belonging to the falcon tribe.—2. A small quadrilateral

sail, set on a small mast on a ship's taffarel; also, a studding sail set upon the gaff of a fore and aft sail.

**RING-TAILED EAGLE, n.** A golden eagle in its youthful plumage.

**RING-WORM, n.** [*ring* and *worm*.] A disease which appears in circular patches upon the neck, forehead, or scalp, and which, if not prevented, spreads over the greater part of the head. It is most common in children of a feeble, flabby habit, but it is communicable by contagion.

**RINK, n.** [A. Sax. *hrincg*, a ring.] A course; a race; the course or proper line in the diversion of curling on the ice. [*Scotch*.]

**RINSE, v. t.** (rins.) [Sw. *rensa* or *rena*, to cleanse or purify; Dan. *rensér*, to clean, to purge, to purify, to scour; Sax. *rein*, D. and G. *rein*, clean; Fr. *rinçer*. This word is probably from the same radix as the Gr. *ῥίσις*, and *ῥίσιος*, to sprinkle.] 1. To wash; to cleanse by washing. But in present usage,—2. To cleanse with a second or repeated application of water after washing. We distinguish *washing* from *rinsing*. *Washing* is performed by rubbing, or with the use of soap; *rinsing* is performed with clean water, without much rubbing or the use of soap. Clothes are *rinsed* by dipping and dashing; and vessels are *rinsed* by dashing water on them, or by slight rubbing. A close barrel may be *rinsed*, but cannot well be *washed*.

**RINSED, pp.** Cleansed with a second water; cleaned.

**RINSER, n.** One that rinses.

**RINSING, ppr.** Cleansing with a second water.

**RYOT, n.** [Norm. *riotti*; It. *riotta*; old Fr. *riote*, a brawl or tumult. The W. *broth*, *bruth*, commotion, may be from the same root, with a prefix, which would connect this word with *brydian*, *brydiaw*, to heat, to boil. The Spanish has *alborato*, and Port. *alvorato*, in a like sense. In Danish, *rutter* is to drink hard, to riot. The primary sense is probably noise or agitation.] 1. In a general sense, tumult; uproar; hence technically, in law, a tumultuous disturbance of the peace by three persons or more assembling together of their own authority, in order to assist each other against any one who shall oppose them in the execution of a private purpose; and afterwards executing the same in a violent and turbulent manner. [See *Rout*.] 2. Up-  
 roar; tumult; wild and noisy festivity. —3. Excessive and expensive feasting; 2 Pet. ii.—4. Luxury.

The lamb thy riot dooms to bleed to-day.

Pope.

To run riot, to act or move without control or restraint.

**RYOT, v. i.** [Old Fr. *rioter*; It. *riottare*.] 1. To revel; to run to excess in feasting, drinking, or other sensual indulgences.—2. To luxuriate; to be highly excited.

No pulse that riots, and no blood that glows.

Pope.

3. To banquet; to live in luxury; to enjoy.

How base is the ingratitude which forgets the benefactor, while it is rioting on the benefit.

Dwight.

4. To raise an uproar or sedition.

**RYOT ACT, n.** The act 1 Geo. 1., st. 2, c. 5, by which it is provided that if any persons, to the number of twelve or

more, being unlawfully, riotously, or tumultuously assembled together, to the disturbance of the public peace, shall continue so assembled for the space of an hour after a magistrate has commanded them by proclamation to disperse, they shall be considered felons.

**RYOTER, n.** One who indulges in loose festivity or excessive feasting.—2. In law, one guilty of meeting with others to do an unlawful act, and declining to retire upon proclamation being made.

**RYOTING, ppr.** Revelling; indulging in excessive feasting.

**RYOTING, n.** A revelling.

**RYOTISE, † n.** Dissoluteness; luxury.

**RYOTOUS, a.** [It. *riottoso*.] 1. Luxurious; wanton or licentious in festive indulgences; as, *riotous* eaters of flesh; Prov. xxiii.—2. Consisting of riot; tumultuous; partaking of the nature of an unlawful assembly; seditious.—3. Guilty of riot; applied to persons.

**RYOTOUSLY, adv.** With excessive or licentious luxury.—2. In the manner of an unlawful assembly; tumultuously; seditiously.

**RYOTOUSNESS, n.** The state or quality of being riotous.

**RYOTRY, † n.** Riot; practice of rioting.

**RIP, v. t.** [Sax. *rypan*, *ryppan*, *hrypan*; Sw. *ryfa*; Dan. *river*. This belongs to the great family of Sax. *reafian*, L. *rapio*, Ir. *reabam*, Eng. *reap* and *rive*; allied perhaps to the L. *crepo*, Fr. *crever*.] 1. To separate by cutting or tearing; to tear or cut open or off; to tear off or out by violence; as, to *rip* open a garment by cutting the stitches; to *rip* off the skin of a beast; to *rip* open a sack; to *rip* off the shingles or boarding of a roof; to *rip* up the belly. We never use *lacerate* in these senses, but apply it to a partial tearing of the skin and flesh.—2. To take out or away by cutting or tearing.

He'll rip the fatal secret from her heart.

Grannille.

3. To tear up for search or disclosure or for alteration; to search to the bottom; with up.

You rip up the original of Scotland.

Spenser.

They ripped up all that had been done from the beginning of the rebellion.

Clarendon.

**RIP, n.** A tearing; a place torn; laceration.—2. A wicker basket to carry fish in.—3. In the *Scottish dialect*, any thing base or useless; an old horse; a cheat.

**RIP, or RIPP, n.** [Sax. *ripa*.] A handful of corn not thrashed. [*Scotch*.]

**RIPARIAN, a.** [L. *ripa*.] Pertaining to the bank of a river.

**RIPE, a.** [Sax. *rype*, *gerip*; G. *reif*. The Saxon word signifies harvest, a *reap* or *reaping*; *ripa*, a handful of corn; *ripan*, to reap; *ripiant*, to ripen.] 1. Brought to perfection in growth or to the best state; mature; fit for use; as, *ripe* fruit; *ripe* corn.—2. Advanced to perfection; matured; as, *ripe* judgment, or *ripe* in judgment.—3. Finished; consummate; as, a *ripe* scholar.—4. Brought to the point of taking effect; matured; ready; prepared; as, things just *ripe* for war.—5. Fully qualified by improvement; prepared; as, a student *ripe* for the university; a saint *ripe* for heaven.—6. Resembling the ripeness of fruit; as, a *ripe* lip.—7. Complete; proper for use.

When time is ripe. Shak.

8. Matured; suppurated; as an abscess or tumour.—9. Advanced to that state

in which the thing is fit for use; as, *ripe* cheese.

**RIPE, † v. i.** To ripen; to grow ripe; to be matured. [See *RIPEN*.]

**RIPE, † v. t.** To mature; to ripen.

**RIPELY, adv.** Maturely; at the fit time.

**RIPEN, v. t.** (ri'pn.) [Sax. *ripiant*; D. *rypen*; G. *reifen*] 1. To grow ripe; to be matured; as grain or fruit. Grain ripens best in dry weather.—2. To approach or come to perfection; to be fitted or prepared; as, a project is *ripening* for execution.

**RIPEN, v. t.** (ri'pn.) To mature; to make ripe; as grain or fruit.—2. To mature; to fit or prepare; as, to *ripen* one for heaven.—3. To bring to perfection; as, to *ripen* the judgment.

**RIPENED, pp.** Made ripe; come to maturity.

**RIPENESS, n.** The state of being ripe or brought to that state of perfection which fits for use; maturity; as, the *ripeness* of grain.—2. Full growth. Time which made them their fame outlive, To Cowley scarce did ripeness give.

Denham.

3. Perfection; completeness; as, the *ripeness* of virtue, wisdom, or judgment.

—4. Fitness; qualification.—5. Complete maturation or suppuration, as of an ulcer or abscess.—6. A state of preparation; as, the *ripeness* of a project for execution.

**RIPENING, ppr.** Maturing; growing or making ripe.

**RIPHEAN, a.** An epithet given to certain mountains in the North of Asia, probably signifying snowy mountains.

**RIPIENO.** [It. *full*.] In music, a term signifying full, and used in compositions of many parts, to distinguish those which fill up the harmony and play only occasionally, from those that play throughout the piece.

**RIP'IER, } n.** In old laws, one who RIP'ER, } brings fish to market in the inland country.

**RIP'PED, pp.** Torn or cut off or out; torn open.

**RIP'PER, n.** One who tears or cuts open.

**RIP'PING, ppr.** Cutting or tearing off or open; tearing up.

**RIP'PING, n.** A tearing.—2. † A discovery.

**RIP'PING IRON or CHISEL, n.** An iron instrument used by shipwrights, to rip the sheathing boards and copper from off the bottom of the ships.

**RIP'PING SAW, or RIP'SAW, n.** A saw used for cutting wood in the direction of the fibre.

**RIP'PLE, v. i.** [In Dan. *ripper* is to stir or agitate; in G. *riffe* is a hatchel; and *riffeln*, to hatchel; in Sax. *geriffet* is wrinkled. *Ripple* is probably allied to *rip*.] To fret on the surface; as water when agitated or running over a rough bottom, appears rough and broken, or as if *rippled* or torn.

**RIP'PLE, v. t.** [G. *riffeln*, to hatchel.] 1. To clean; to separate the seed from flax.—2. To agitate the surface of water.

**RIP'PLE, n.** The fretting of the surface of water; little curling waves.—*Ripple marks*, the peculiar undulated marks which the receding waves leave on the sea beach. These are occasionally found in some of the older strata of rocks, as in sand stones or indurated clays of fine grain and frequent lamination. The right understanding of the origin of such marks, is a very necessary element in reason-

ing on the deposition of stratified rocks, and the displacements of the ancient bed of the sea.—2. A large comb or hatchel for separating the seed from flax.

RIPPLE GRASS, *n.* A species of plantain; rib grass, *Plantago lanceolata*.

RIPPLING, *ppr.* Fretting on the surface; cleaning, as flax.

RIPPLING, *n.* The ripple dashing on the shore, or the noise of it.—2. The act or method of separating the seed from flax.

RIPRAP, *n.* In *engineering*, a foundation or parapet of stones thrown together without order, as in deep water or on a soft bottom.

RIPPT, *pp.* For *Ripped*.

RIP TOWELL, *n.* A gratuity given to tenants after they had reaped their lord's corn.

RISE, *v. i.* (*rise*.) *pret. rose*; *pp. risen*; *pron. roze, rizn.* [*Sax. arisan*; *Goth. reisan*, in *ur-reisan*, to rise, and *ur-raisan*, to raise. See *RAISE*.] 1. To move or pass upward in any manner; to ascend; as, a fog rises from a river or from low ground; a fish rises in water; birds rise in the air; clouds rise from the horizon toward the meridian; a balloon rises above the clouds.

—2. To get up; to leave the place of sleep or rest; as, to rise from bed.—3. To get up or move from any recumbent to an erect posture; as, to rise after a fall.—4. To get up from a seat; to leave a sitting posture; as, to rise from a sofa or chair.—5. To spring; to grow; as a plant; hence, to be high or tall. A tree rises to the height of sixty feet.—6. To swell in quantity or extent; to be more elevated; as, a river rises after rain.—7. To break forth; to appear; as, a boil rises on the skin.—8. To appear above the horizon; to shine; as, the sun or a star rises. [See *RISING*, *n.* No. 4.]

He maketh his sun to rise on the evil and on the good; *Matth. v.*

9. To begin to exist; to originate; to come into being or notice. Great evils sometimes rise from small imprudences.—10. To be excited; to begin to move or act; as, the wind rose at 12 o'clock.—11. To increase in violence. The wind continued to rise till 3 o'clock.—12. To appear in view; as, to rise up to the reader's view.—13. To appear in sight; also, to appear more elevated; as, in sailing toward a shore, the land rises.—14. To change a station; to leave a place; as, to rise from a siege.—15. To spring; to be excited or produced. A thought now rises in my mind.—16. To gain elevation in rank, fortune, or public estimation; to be promoted. Men may rise by industry, by merit, by favour, or by intrigue.

Some rise by sin, and some by virtue fall  
*Shak.*

When the wicked rise, men hide themselves; *Prov. xxviii.*

17. To break forth into public commotions; to make open opposition to government; or to assemble and oppose government; or to assemble in arms for attacking another nation. The Greeks rose against their oppressors. No more shall nation against nation rise.

*Pope.*

18. To be excited or roused into action. Rise up to the battle; *Jer. xlix.*

19. To make a hostile attack; as when a man riseth against his neighbour; *Deut. xxii.* Also, to rebel; *2 Sam. xviii.—20.* To increase; to swell; to

grow more or greater. A voice, feeble at first, rises to thunder. The price of goods rises. The heat rises to intensity.—21. To be improved; to recover from depression; as, a family may rise after misfortune to opulence and splendour.—22. To elevate the style or manner; as, to rise in force of expression; to rise in eloquence.—23. To be revived from death.

The dead in Christ shall rise first; *1 Thess. iv.*

24. To come by chance.—25. To ascend; to be elevated above the level or surface; as, the ground rises gradually one hundred yards. Some parts of the Andes rise more than 20,000 feet above the level of the ocean; the Himalayah mountains in Asia are said to rise still higher.—26. To proceed from.

A sceptre shall rise out of Israel; *Nam. xxiv.*

27. To have its sources in. Rivers rise in lakes, ponds, and springs.—28. To be moved, roused, excited, kindled, or inflamed, as passion. His wrath rose to rage.—29. To ascend in the diatonic scale; as, to rise a tone or semitone.—30. To amount. The national debt has risen to more than eight hundred millions.—31. To close a session. We say, the court will rise on a certain day. This verb is written also *arise*,—*which see*. In general, it is indifferent which orthography is used; but custom has, in some cases, established one to the exclusion of the other. Thus we never say, the price of goods *arises*, when we mean *advances*, but we always say, the price rises. We never say, the ground *arises* to a certain altitude, and rarely, a man *arises* into an office or station. It is hardly possible to class or define the cases in which usage has established a difference in the orthography of this verb. A knowledge of these cases must be acquired by observation.

*RISE, n.* The act of rising, either in a literal or figurative sense; ascent; as, the rise of vapour in the air; the rise of mercury in the barometer; the rise of water in a river.—2. The act of springing or mounting from the ground; as, the rise of the feet in leaping.—3. Ascent; elevation, or degree of ascent; as, the rise of a hill or mountain.—4. Spring; source; origin; beginning; as, the rise of a stream in a mountain. All sin has its rise in the heart.—5. Any place elevated above the common level; as, a rise of land.—6. Appearance above the horizon; as, the rise of the sun or a star.—7. Increase; advance; as, a rise in the price of wheat.—8. Advance in rank, honour, property, or fame. Observe a man after his rise to office, or a family after its rise from obscurity.—9. Increase of sound on the same key; a swelling of the voice.—10. Elevation or ascent of the voice in the diatonic scale; as, a rise of a tone or semitone.—11. Increase; augmentation.—12.† [*D. rvs*; from the verb.] A bough or branch.

*RISE, pp.* See *Rise*.

*RISER, n.* One that rises; as, an early riser.—2. In *arch.*, the vertical face of a step of a stair.

*RISIBILITY, } n.* [from *risible*.] The *RISIBLNESS, } quality of laughing, or of being capable of laughter. Risibility is peculiar to the human species.*

—2. Proneness to laugh.

*RYISIBLE, a.* [*Fr. risible*; *L. risibilis*, from *rideo, risi*, to laugh. See *RIDI-*

*CULOUS*.] 1. Having the faculty or power of laughing. Man is a *risible* animal.—2. Laughable; capable of exciting laughter. The description of Falstaff in Shakspeare, exhibits a *risible* scene. *Risible* differs from *ludicrous*, as species from genus; *ludicrous* expressing that which is playful and sportive; *risible*, that which may excite laughter. *Risible* differs from *ridiculous*, as the latter implies something mean or contemptible, and *risible* does not.

*RYISIBLY, adv.* In a risible manner; laughably.

*RYISING, ppr.* Getting up; ascending; mounting; springing; proceeding from; advancing; swelling; increasing; appearing above the horizon; reviving from death, &c.—2. Increasing in wealth, power, or distinction; as, a rising state; a rising man.—3. Growing, advancing to adult years, and to the state of active life; as, the rising generation. In *her.*, a term used for birds when in a position as if preparing to take flight. [See *ROUSANT*.]

—*Rising timbers*, the hooks placed on the keel of a ship.—*Rising line*, an incurved line drawn on the plane of elevations, or sheer draughts of a ship, to determine the height of the ends of all the floor-timbers.

*RISING, n.* The act of getting up from any recumbent, or sitting, or prone posture.

When rising from the bed of death. *Addison*. 2. The act of ascending; as, the rising of vapour.—3. The act of closing a session, as of a public body; as, the rising of the court of session.—4. The appearance of the sun or a star above the horizon. In *astron.*, the sun or a planet is said to rise or set when the centre is in the horizon, allowance being made for refraction, parallax, and the dip of the horizon. There are three kinds of rising and setting applicable to the heavenly bodies, *viz.*, *acronical*, *cosmical*, and *heliacal*,—*see these terms*.—5. The act of reviving from the dead; resurrection; *Mark ix.*—6. A tumour on the body; *Lev. xiii.*—7. An assembling in opposition to government; insurrection; sedition or mutiny.

*RISING HINGE, n.* A hinge so constructed as to raise the door to which it is attached as it opens.

*RISINGS, n.* In *ships*, the thick planks which go fore and aft, on which the timbers of the decks bear.

*RISK, n.* [*Fr. risque*; *It. rischio*, risk, danger, peril; *Fr. risquer*, to risk. The sense is a pushing forward, a rushing, as in *rash*. *Qu. Dan. dristig*, bold, rash; *drister*, to dare; *Sw. drista*, to trust, to be bold, hardy, or rash. In Portuguese, *risco* signifies not only hazard, but a stroke, a dash, and with painters, delineation; *risicar* signifies to dash or strike out with a pen, to erase. The primary sense then is to throw or dash, or to rush, to drive forward. See *PERIL, RASH, and RUSH*.]

—1. Hazard; danger; peril; exposure to harm. He, at the risk of his life, saved a drowning man.—2. In *com.*, the hazard of loss, either of ship, goods, or other property. Hence, *risk* signifies also the degree of hazard or danger; for the premiums of insurance are calculated upon the risk. The underwriters now take risks at a low premium. In the theory of probabilities, the risk of loss or gain signifies such a fraction of the sum to be lost or gained,

as expresses the chance of losing or gaining it; thus, an even chance of losing £40 is considered as a positive loss of one-half of £40, or of £20; and 2 to 1 of gaining £60 is counted as two-thirds of £60 or £40. If both these risks were encountered at the same time, the whole transaction would be considered as a gain of £40—£20, or £20, since this is the sum which would be netted by every such transaction in the long run, and one with another.—*To run a risk*, is to incur hazard; to encounter danger.

**RISK**, *v. t.* To hazard; to endanger; to expose to injury or loss; as, *to risk* goods on board of a ship; *to risk* one's person in battle; *to risk* one's fame by a publication; *to risk* life in defence of rights.—2. *To venture*; *to dare* to undertake; as, *to risk* a battle or combat.

**RISK**, *v. i.* To make a noise like the tearing of roots. [*Scotch.*]

**RISK'ED**, *pp.* Hazardred; exposed to injury or loss.

**RISK'ER**, *n.* One who hazards.

**RISK'ING**, *ppr.* Hazardizing; exposing to injury or loss.

**RISSE**, obsolete *pret. of Rise*.

**RISUS SARDO'NICUS**, *n.* [*L.*] Sardonic laugh, a kind of convulsive grin, observed chiefly in cases of tetanus and inflammation of the diaphragm. It is so named because it was said to have been produced by eating of a species of ranunculus (*Herba Sardonica*), which grew round certain fountains in *Sardinia*.

**RITE**, *n.* [*Fr. riti, rite; L. ritus; Sans. riti, service.*] The manner of performing divine or solemn service as established by law, precept, or custom; formal act of religion, or other solemn duty. The rites of the Israelites were numerous and expensive; the rites of modern churches are more simple. Funeral rites are very different in different countries. The sacrament is a holy rite.

**RIT'ORNEL'LO**, *n.* [*It. from ritorno, return, or ritornare, to return.*] In music, properly a short repetition, such as that of an echo, or of the last words of a song, especially if such repetition be played by one or more instruments, whilst the principal voice pauses. But by custom this word is now used to denote the introduction to an air or any musical piece.

**RIT'UAL**, *a.* [*It. rituale.*] 1. Pertaining to rites; consisting of rites; as, *ritual* service or sacrifices.—2. Prescribing rites; as, the *ritual* law.

**RIT'UAL**, *n.* A book containing the rites to be observed, or the manner of performing divine service in a particular church or communion.

**RIT'UALISM**, *n.* The system of rituals, or prescribed form of religious worship.—2. Observance of prescribed forms in religion.

**RIT'UALIST**, *n.* Oneskilled in the ritual.

**RIT'UALLY**, *adv.* By rites; or by a particular rite.

**RIV'AGE**, *† n.* [*Fr. from rive, bank.*] A bank, shore, or coast.

**RIVAL**, *n.* [*L. rivalis, Fr. and Sp. rival; It. rivale; Ir. rioblach; Heb. riv, rub, to contend, to strive; Dan. rives, to strive; Sp. rifa, strife, raffle; rifar, to dispute, quarrel, or raffle, and to split a sail. Qu. to rive or rip. See RAFFLE.*]

1. One who is in pursuit of the same object as another; one striving to reach or obtain something which another is attempting to obtain, and which one only can possess; a competitor; as, *rivals* in love; *rivals* for a

crowns. Love will not patiently bear a rival.—2. One striving to equal or exceed another in excellence; as, two *rivals* in eloquence.—3. An antagonist; a competitor in any pursuit or strife.

**RIVAL**, *a.* Having the same pretensions or claims; standing in competition for superiority; as, *rival* lovers; *rival* claims or pretensions.

Equal in years and rival in renown.

*Dryden.*

**RIVAL**, *v. t.* To stand in competition with; to strive to gain the object which another is contending for; as, *to rival* one in love.—2. To strive to equal or excel; to emulate.

*To rival* thunder in its rapid course.

*Dryden.*

**RIVAL**, *† v. i.* To be competitors.

**RIVALLED**, *pp.* Having another competing with; emulated.

**RIVALLING**, *ppr.* Striving to equal or excel; emulating.

**RIVAL'ITY**, *† n.* Rivalry.

**RIVALRY**, *n.* [*from rival.*] Competition; a strife or effort to obtain an object which another is pursuing; as *rivalry* in love; or an endeavour to equal or surpass another in some excellence; emulation; as, *rivalry* for superiority at the bar or in the senate.

**RIVALSHIP**, *n.* The state or character of a rival.—2. Strife; contention for superiority; emulation; rivalry.

**RIVE**, *v. t.* *pret. rived; pp. rived or riven.* [*Dan. reuner, to split; river, to pluck off or away, to rake; Sw. rيفا, to pull asunder, to burst or rend, to rake, to tear; Ice. rifa, Sw. refva, a chink or crevice; Fr. crever, whence creasse, crevice; Rus. rvu; allied to L. rumpo, rupi.* It may be allied to the family of *L. rapio, reap, rip.*] To split; to cleave; to rend asunder by force; as, *to rive* timber for rails, &c. with wedges; the *riven* oak; the *riven* clouds.

The scolding winds

Have *rived* the knotty oaks. *Shak.*

**RIVE**, *v. i.* To be split or rent asunder.

Freestone *rives*, splits, and breaks in any direction. *Woodward.*

**RIV'EL**, *v. t.* [*Sax. gerifted, wrinkled; from the root of Dan. river, to draw, to wrest.* This word is obsolete, but *shrivel*, from the same root, is in use. It may be allied to *ruffle.*] To contract into wrinkles; to shrink; as, *rivelled* fruit; *rivelled* flowers.

**RIV'ELLED**, *pp.* Wrinkled.

**RIV'ELLING**, *ppr.* Shrinking; contracting into wrinkles.

**RIV'EN**, *pp. of Rive.* Split; rent or burst asunder.

**RIV'ER**, *n.* One who rives or splits.

**RIV'ER**, *n.* [*Fr. riviere; It. riviera; from L. rivus, rivulus; D. rivier.* The Italian word signifies a river, and a bank or shore, *L. ripa.*] 1. An inland current of water formed within a certain portion of the earth's surface by the confluence of brooks, small streams, or mountain torrents, and discharging itself into the ocean, a lake, marsh, or other river. The country which is drained by a river is called its basin, as the river runs in the lowest part of it. A *brook* is the name given to rivers of the smallest description, and if the waters should be increased by those of another brook, the name of brook is changed into that of *rivulet*. When several rivulets unite and so produce a considerable volume of running water, this water-course takes the name of *river*. But all such rivers do not

reach the sea or even a lake; most of them join other rivers, and thus a large river is produced. This last mentioned river is called the *principal river*, and those which increase its waters are called, with respect to it, *affluents* or *tributaries*, and sometimes *feeders* or *branches*. The first waters of a river are generally derived from a spring which breaks out at the foot of a declivity or on the side of some hill or mountain, and sometimes from a swamp or lake. This is called the *source* of a river. From this source the river descends through the lowest part of its basin until it terminates its course in the sea, a lake, or another river, and this termination is called the *mou*th of the river. The cavity in which the running water flows is called the *bed* of the river, and the solid land which bounds this bed is called its *banks*. Most large rivers have their origin in very elevated mountains, or on high table-lands, in descending from which, a great difference with respect to the rapidity of their course, and the nature of the country through which they flow, is observed accordingly by geographers, who divide the whole of the course of such rivers into three divisions, the *upper, middle, and lower* course. Most rivers overflow the low countries which are adjacent to their banks, either at regular seasons of the year or occasionally. This takes place when the supply of water is greater than the bed of the river can contain. The periodical inundations depend on great falls of rain in mountainous regions, or on the melting of snow and ice in the neighbourhood of their source. The period depends on the return of these seasons in different places. The largest rivers in the world are the Amazon and La Plata, in South America; the Mississippi, Missouri, and St. Lawrence, in North America; the Yang-tze-kiang, the Hoanho, the Lena, the Ganges, the Indus, and the Euphrates, in Asia; the Nile and the Niger, in Africa; and the Volga, the Danube, and the Rhine, in Europe.

In a *legal sense*, rivers are divisible into *fresh* and *salt-water* rivers. Salt-water rivers are those rivers, or parts of rivers, in which the tide ebbs and flows. Rivers are also divisible into *public* or *navigable* rivers, and *private* rivers.—2. A large stream; copious flow; abundance; as, *rivers* of blood; *rivers* of oil.—3. In *hydraulics*, a current of water flowing in an open channel. The velocity of a current of water flowing in an open channel depends on the volume of water, the form of the channel, and its inclination; and the determination of the relations subsisting among these three quantities is a problem of great practical importance, the solution of which must be derived partly from experiment, and partly from the general theory of the motion and resistance of fluids.

**RIV'ER-BED**, *n.* The bed or bottom of a river.

**RIV'ER-CHANNEL**, *n.* The channel of a river.

**RIV'ER-COURSE**, *n.* The course of a river.

**RIV'ER-DELTA**, *n.* A delta formed by the current of a river.

**RIV'ER-DRAGON**, *n.* A crocodile; a name given by Milton to the king of Egypt.

**RIV'ERET**, *† n.* A small river.

**RIV'ER-GOD**, *n.* A deity supposed to

preside over a river, as its tutelary divinity; a naiad.

**RIVER-HORSE**, *n.* The hippopotamus, an animal inhabiting rivers.

**RIVER-MEADOW**, *n.* A meadow on the bank of a river.

**RIVER-PLAIN**, *n.* A plain by a river.

**RIVER-WATER**, *n.* The water of a river, as distinguished from *rain-water*.

**RIVET**, *v. t.* [It. *ribadire*; Port. *rebistar*. These are compounds of a verb with *re* for a prefix. The Spanish has *roblar*. The French *rivier*, and Arm. *riva* or *rinva*, would seem to be the Heb.  $\text{רִבַּי}$ , *rub*, to drive.] 1. To fasten with a rivet or with rivets; as, to *rivet* two pieces of iron.—2. To clinch; as, to *rivet* a pin or bolt.—3. To fasten firmly; to make firm, strong, or immovable; as, to *rivet* friendship or affection. *Rivet* and nail me where I stand, ye pow'rs. *Congree*.

**RIVET**, *n.* A short bolt or pin of wrought iron, copper, or of any other malleable material, inserted into a hole

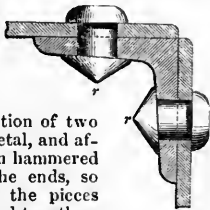

at the junction of two pieces of metal, and after insertion hammered broad at the ends, so as to keep the pieces closely bound together. Rivets are usually closed up when they are in a heated state, so as at once to facilitate the formation of the heads, and to draw the pieces more firmly together by the contraction of the rivet when cool. It is in this manner that boilers and tanks are made.

**RIVETTED**, *pp.* Clinched; made fast. **RIVETTING**, *pp.* Clinching; fastening firmly—*Rivetting plates*, in gun-carriages, small square thin pieces of iron through which the ends of the bolts pass, and upon which they are rivetted.

**RIVING**, *pp.* Splitting; bursting asunder.

**RIVOSE**, *a.* [L. *rivus*, a brook.] In *zool.*, a term applied, when the surface of an animal, or part, is marked with furrows which do not run in a parallel direction, but are rather sinuate.

**RIVULET**, *n.* [L. *rivulus*.] A small stream or brook; a streamlet. [See *RIVER*.]

By fountain or by shady *rivulet*, *Milton*. He sought them.

**RIXATION**, *n.* [L. *rixatio*, from *rixor*, to brawl or quarrel.] A brawl or quarrel.

**RIX-DOLLAR**, *n.* [G. *reichsthaler*; Sw. *riksdaler*; Dan. *riksdaler*; the dollar of the realm.] A silver coin of Germany, Holland, Denmark, Sweden, and the northern Hanse towns. Its value varies, ranging between 2s. 6d. and 4s. 6d., sterling. But the present Prussian *reichsthaler*, worth about 3s., is its most common denomination in Germany.

**RÖACH**, *n.* [Sax. *reache*, *hreece*; G. *roche*; Fr. *rouget* from the root of *rouge*, red.] A fish of the genus *Cyprinus*, the *C. rutilus*, Linn. It inhabits shallow and gentle streams, and the mouth of small streams which run into larger ones. Its flesh is white and good, and very compact, but turns red when boiled. The compactness of the flesh is supposed by some to have given

rise to the phrase, "as sound as a *roach*;" but others suppose that this

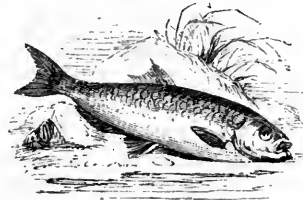

Roach (*Cyprinus rutilus*).

phrase was originally, as sound as a *rock*, [Fr. *roche*.]—2. The curve or arch, which is generally cut in the foot of some square sails from one clew to the other, to keep the foot clear of stays and ropes.

**RÖAD**, *n.* [Sax. *rad*, *rade*, a ride, a passing or travelling on horseback, a way, a road, corresponding with the G. *reise*; but in the sense of a place for anchoring ships, the Fr. has *rade*, G. and D. *reed*. In the sense of way, the Spanish has *ruta*, W. *rhadu*, all connected with *ride*, W. *rhedu*, to run, and L. *gradior*, W. *rhodiaw*, to walk or go. The Slavonic has *brud*, and the Bohemian *brud*, a way. See *GRADE*.] 1. An open way or public passage; ground appropriated for travel, forming a communication between one city, town, or place and another, by which passengers and commodities may travel or be transported with more or less facility and expedition. Roads are of various kinds, according to the state of civilization and wealth of the country through which they are constructed, and according to the nature and extent of the traffic to be carried on upon them. [See *RAILWAY*.] The word is generally applied to highways, and as a generic term it includes highway, street, and lane. The military roads of the Romans were paved with stone, or formed of gravel or pebbles, and some of them remain to this day entire.—2. A place where ships may ride at anchor at some distance from the shore; sometimes called *roadstead*, that is, a place for *riding*, meaning at anchor.—3. A journey. [Not used, but we still use *ride* as a noun; as, a long *ride*; a short *ride*; the same word differently written.]—4. † An inroad; incursion of an enemy.—*On the road*, passing; travelling.—*To take the road*, set out on a journey.—*To take to the road*, to go robbing travellers on the highway.

**ROADER**, } *n.* Among *seamen*, a  
**ROADSTER**, } vessel riding at anchor in a road or bay.—2. A travelling horse.

**RÖAD-HARROW**, *n.* A machine invented by Harriott, for dragging over roads when much out of repair, to replace the stones or gravel disturbed by wheel carriages.

**ROADSTEAD**. See *ROAD*.

**ROADWAY**, *n.* A highway.

**RÖAM**, *v. i.* [If *m* is radical, this word seems to be connected with *ramble*, L. *ramus*. In W. *rhanu* is to rise over, to soar, to vault; whence *rhamant*, a rising boldly, *romance*; *rhem*, *rhum*, something projecting; *rhim*, rim, the exterior part of a thing.] To wander; to ramble; to rove; to walk or move about from place to place without any

certain purpose or direction. The wolf and the savage *roam* in the forest. *Daphne roaming* through a thorny wood.

*Shak*.

**RÖAM**, *v. t.* To range; to wander over; as, to *roam* the woods; but the phrase is elliptical.

**RÖAMED**, *pp.* Ranged; wandered over.

**RÖAMER**, *n.* A wanderer; a rover; a rambler; a vagrant.

**RÖAMING**, *pp.* Wandering; roving.

**RÖAMING**, or **RÖAM**, *n.* The act of wandering.

**RÖAN**, *a.* [F. *rouan*.] A roan horse, according to the definition given in the old Farrier's Dictionary, is one that is of a bay, sorrel, or dark colour, with spots of gray or white thickly interspersed. At present, however, the word seems to be restricted to a mixture having a decided shade of red, a deep or black gray being called an iron-gray.

**RÖAN-TREE**, *n.* A tree of the genus *Pyrus*, the *P. aucuparia*, called also mountain ash, and quicken. [See *MOUNTAIN ASH*.]

**RÖAR**, *v. i.* [Sax. *rarian*, to roar; W. *rhuur*, the roaring of the sea.] 1. To cry with a full, loud, continued sound; to bellow, as a beast; as, a *roaring* bull; a *roaring* lion.—2. To cry aloud, as in distress.

The suffering chief

*Roar'd* out for anguish. *Dryden*.

3. To cry aloud; to bawl; as a child.

—4. To cause a loud continued sound.

We say, the sea or the wind *roars*; a company *roar* in acclamation.—5. To make a loud noise.

The brazen throat of war had ceas'd to *roar*.

*Milton*.

**RÖAR**, *n.* A full loud sound of some continuance; the cry of a beast; as, the *roar* of a lion or bull.—2. The loud cry of a child or person in distress.—3. Clamour; outcry of joy or mirth; as, a *roar* of laughter. He set the company in a *roar*.—4. The loud continued sound of the sea in a storm, or the howling of a tempest.—5. Any loud sound of some continuance; as, the *roar* of cannon.

**RÖARER**, *n.* One that roars, man or beast; a noisy brutal man; a horse quite broken in wind. [See *TRIVID*.]

**RÖARING**, *pp.* Crying like a bull or lion; uttering a deep loud sound.

**RÖARING**, *n.* The cry of a lion or other beast; outcry of distress, Job iii.; loud continued sound of the billows of the sea or of a tempest; Is. v.—2. A disease of the bronchial tubes in horses, which causes them to make a singular noise in breathing.

**RÖARINGLY**, *adv.* In a roaring manner.

**RÖARY**, *a.* Dewy; more properly *Röry*.

**RÖAST**, *v. t.* [W. *rhostiaw*; Ir. *rostam*; Fr. *rôtir*; G. *rösten*; Dan. *rister*, to roast, and *rist*, a gridiron, G. *rost*. If the verb is from the noun, the sense is to dress or cook on a gridiron or grate, and *rist*, *rost*, coincide in elements with L. *rastellum*, a rake. If the verb is the root, the sense probably is to contract or *crisp*, or to throw or agitate, hence to make rough. The Welsh has also *crasu*, to roast, from *cräs*. This coincides with *crisp*.] 1. To cook, dress, or prepare meat for the table by exposing it to heat, as on a spit, in a bake-pan, in an oven, or the like. We now say, to *roast* meat on a spit, in a pan, or in a tin oven, &c.; to *bake* meat in an

oven; to *broil* meat on a gridiron.—2. To prepare for food by exposure to heat; as, to *roast* apples or potatoes; to *roast* eggs.—3. To heat to excess; to heat violently.

*Roasted* in wrath and fire. *Shak.*  
4. To dry and parch by exposure to heat; as, to *roast* coffee.—5. In *metallurgy*, to dissipate the volatile parts of ore by heat.—6. In *common discourse*, to jeer; to banter severely.

**ROAST**, *n.* That which is roasted, as, a piece of beef; that part of a slaughtered animal which is selected for roasting, as a sirloin of beef, a shoulder of mutton.

**ROAST**, *a.* [for *roasted*.] Roasted; as, *roast* beef.

**ROAST**, *n.* In the familiar phrase, to *rule the roast*, i. e. to have the chief direction, the word *roast* is a corrupt pronunciation of the German word *rath*, counsel.

**ROASTED**, *pp.* Dressed by exposure to heat on a spit.

**ROASTER**, *n.* One that roasts meat: also, a contrivance for roasting.—2. A pig for roasting.

**ROASTING**, *pp.* Preparing for the table by exposure to heat on a spit; drying and parching.—2. Bantering with severity.

**ROASTING**, *n.* The act of roasting, as meat.—2. A severe teasing or bantering.—3. In *chemical metallurgy*, the protracted application of heat to metallic ores below their fusing points. It is generally resorted to to expel volatile matters, especially sulphur, arsenic, carbonic acid, water, &c.

**ROB**, *n.* [Sp. *rob*; Ar. *rauba*, to be thick.] A term applied by old pharmaceutical writers to the inspissated juice of ripe fruit, mixed with honey or sugar to the consistence of a conserve.

**ROB**, *v. t.* [G. *rauben*; It. *rubare*; Sp. *robar*; Pers. *robadan*. This word has the elements of W. *rhaib*, a snatching, Sax. *reafian*, L. *rapio*, Fr. *ravir*.] 1. In *law*, to take from the person of another feloniously, forcibly, and by putting him in fear; as, to *rob* a passenger on the road.—2. To seize and carry from any thing by violence and with felonious intent; as, to *rob* a coach; to *rob* the mail.—3. To plunder; to strip unlawfully; as, to *rob* an orchard: to *rob* a man of his just praise.—4. To take away by oppression or by violence.

*Rob* not the poor because he is poor; Prov. xxii.

5. To take from; to deprive. A large tree *robs* smaller plants near it of their nourishment.—6. In a *loose sense*, to steal; to take privately without permission of the owner.—7. To withhold what is due; Mal. iii.

**ROBBED**, *pp.* Deprived feloniously and by violence; plundered; seized and carried away by violence.

**ROBBER**, *n.* In *law*, one that takes goods or money from the person of another by force or menaces, and with a felonious intent.—2. In a *looser sense*, one who takes that to which he has no right; one who steals, plunders, or strips by violence and wrong.

**ROBBERY**, *n.* In *law*, the forcible and felonious taking from the person of another any money or goods, putting him in fear, that is, by violence or by menaces of death or personal injury. *Robbery* differs from *theft*, as it is a violent felonious taking from the person or presence of another; whereas, *theft* is a felonious taking of goods privately from the person, dwelling,

&c. of another. These words should not be confounded.—2. A plundering; a pillaging; a taking away by violence, wrong, or oppression.

**ROBBING**, *pp.* Feloniously taking from the person of another; putting him in fear; stripping; plundering; taking from another unlawfully or by wrong or oppression.

**ROBBINS**, } *n.* [rope and bands.]  
**ROPE-BANDS**, } In ships, short flat  
**ROB'ANDS**, } plaited pieces of  
rope, with an eye in one end, used in pairs to tie the upper edges of square sails to their yards.

**ROBE**, *n.* [Fr. *robe*; Sp. *ropa*; Port. *roupa*; Ir. *roba*; It. *roba*, a robe, and goods or estate; *far roba*, to get money; *robone*, a long gown; *robbiccia*, trifles, idle stuff. The Spanish and Portuguese words signify clothing in general, cloth, stuff, wearing apparel, also a loose garment worn over the rest, a gown; Sp. *ropage* is wearing apparel, *drapery*; *roperia*, the trade of dealers in clothes.]

1. A kind of gown or long loose garment worn over other dress, particularly by persons in elevated stations. The robe is properly a dress of state or dignity, as of princes, judges, priests, &c. See Exod. xxix. 55; 1 Sam. xxiv. 4; Matt. xxvii. 28.—2. A splendid female gown or garment; 2 Sam. xiii.—3. An elegant dress; splendid attire.—4. In *Scripture*, the vesture of purity or righteousness, and of happiness; Job xxix; Luke xv.—*Master of the robes*, an officer in the royal household, whose duty, as the designation implies, consists in ordering the sovereign's robes. Under a queen this office is performed by a lady, who enjoys the highest rank of the ladies in the service of the queen.

**ROBE**, *v. t.* To put on a robe; or to dress with magnificence; to array.—2. To dress; to invest, as with beauty or elegance; as, fields *robed* with green.

Such was his power over the expression of his countenance, that he could in an instant shake off the sternness of winter, and *robe* it in the brightest smiles of spring.

*Wirt.*

**ROBED**, *pp.* Dressed with a robe; arrayed with elegance.

**ROBERDSMAN**, } *n.* In the old statutes  
**ROBERTSMAN**, } of England, a bold stout robber or night thief, said to be so called from *Robin Hood*, a famous robber.

**ROBERT**, } *n.* A plant of the  
**HERB-ROBERT**, } genus *Geranium*, the *G. robertianum*, called also stinking crane's bill. It grows in waste ground, by walls, among stones, and debris of rocks.

**ROBERTINE**, *n.* One of an order of monks, so called from Robert Flower, the founder, A. D. 1187.

**ROBIN**, *n.* [L. *rubicula*, from *rubeo*, to be red.] 1. A well known bird of the genus *Motacilla*, the *M. rubecula*, Linn.; called also *redbreast*.—2. In the *United States*, a bird with a red breast, a species of *Turdus*, the *T. migratorius*.—*Round Robin*. [See among the compounds of *Round*.]

**RÖBING**, *pp.* Dressing with a robe; arraying with elegance.

**ROBIN-GOODFELLOW**, *n.* An old domestic goblin, called in Scotland a *bromie*.

**ROBINIA**, *n.* A genus of North American trees, belonging to the papilionaceous division of the nat. order Leguminosæ, which bear nodding racemes

of white or rose-coloured flowers. This genus formerly comprehended the plants now included under *caragana*, from which it is distinguished by its long gibbous legume, and unequally pinnate leaves. The best known species is the *R. pseudacacia*, the bastard or false acacia, or locust tree. The wood is exceedingly hard and durable, and in America it is used for making posts, but its greatest consumption is for making trenails, by which the timbers of ships are fastened together, and for this purpose large quantities, imported from America, are used in the royal dock yards.

**RÖBING-ROOM**, *n.* A vestiary, where robes of ceremony are put on and off; as, the peers' *robing room* in the house of lords.

**ROB'IN-REDBREAST**, *n.* A robin.

**ROB'ORANT**, *a.* [L. *roborans*, *roboro*.] Strengthening.

**ROB'ORANT**, *n.* A medicine that strengthens; but *tonic* is generally used.

**ROBORATION**, *n.* [from L. *roboro*, from *robur*, strength.] A strengthening. [*Little used*.]

**ROBO'REAN**, } *a.* [L. *roboreus*, from  
**ROBO'REOUS**, } *robur*, strength, and  
an oak.] Made of oak; strong. [*Lit. us.*]

**ROBUST**, *a.* [L. *robustus*, from *robur*, strength.] 1. Strong; lusty; sinewy; muscular; vigorous; forceful; as, a *robust* body; *robust* youth. It implies full flesh and sound health.—2. Sound; vigorous; as, *robust* health.—3. Violent; rough; rude.

Romp-loving miss

Is haul'd about in gallantry *robust*.

*Thomson.*

4. Requiring strength; as, *robust* employment.

**ROBUSTIOUS**, *a.* *Robust*. [Used at present only in a ludicrous sense, or in contempt. So also are its derivatives, *robustiously*, and *robustiousness*.]

**ROBUSTLY**, *adv.* With great strength; muscularly.

**ROBUSTNESS**, *n.* Strength; vigour, or the condition of the body when it has full firm flesh and sound health.

**ROC**, } *n.* The well-known monstros  
**RUKH**, } bird of Arabian mythology,  
of the same fabulous species with the Simurg of the Persians.

**ROC'AMBOLE**, *n.* [from the French.] A sort of wild garlic, the *Allium ophiocorodon*, growing naturally in Crete. *Rocambole*, *wild*, is *Allium scorodoprassum*, which grows in Denmark, &c. It is cultivated for the same purposes as the onion and garlic.

**ROCEL'LA**, *n.* A genus of lichens, one

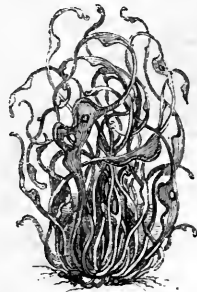

*Rocella tinctoria* (Archil).

species of which (*R. tinctoria*), yields the dye so largely used by manufac-



turners under the name of Orchal or Archil.

**ROCEL'LIC ACID**, *n.* An acid obtained from the *Rocella tinctoria*.

**RÔCHE-ALUM**, *n.* [Fr. *roche*, a rock. It ought to be written and called *roch-alum*.] Rock-alum, a purer kind of alum.

**ROCHE'LE SALT**, *n.* (ro-shel' salt.) The tartrate of soda and potash. It is a double salt, composed of two equivalents of tartaric acid, one of potassa, and one of soda. It has a mild, hardly saline taste, and acts as a laxative.

**ROCH'ET**, *n.* [Fr. *rochet*; Ger. *roch*, a coat; Low Lat. *roculus* or *rochus*.] A sort of surplice, with tight sleeves, worn by bishops and several other ecclesiastics.—2. A mantelet worn during ceremonies by the peers of England. The *rochets* of viscounts have two bordures and a half, those of counts three.

**ROCH'ET**, *n.* A fish, the *roach*.—*which see*.

**ROCK**, *n.* [Fr. *roc* or *roche*; It. *rocca*. a rock, and a distaff. Dropping the first letter of *crag*, rock would seem to be the same word, and so named from breaking and the consequent roughness, corresponding with Gr. *ραγια*, as *crag* does with *crach*; Ar. *garaha*, to burst, crack, tear, *rahe*. So *L. rupes*, from the root of *rumpo*, to break or burst.]

1. A large mass of stony matter, usually compounded of two or more simple minerals, either bedded in the earth or resting on its surface. Sometimes *rocks* compose the principal part of huge mountains; sometimes huge *rocks* lie on the surface of the earth, in detached blocks or masses. Under this term, mineralogists class all mineral substances, coal, gypsum, salt, &c. The rocks of which the mineral crust of the globe is composed, are divided into those of aqueous and igneous origin, from the two agents known to us as being capable of their production. Rocks are also divided into primary, transition, secondary, and tertiary. [See the respective terms.] There are many other divisions, such as crystalline, fossiliferous, granite, limestone, &c. &c.—2. In *Scripture*, figuratively, defence; means of safety; protection; strength; asylum.

The Lord is my *rock*; 2 Sam. xxii.

3. Firmness; a firm or immovable foundation; Ps. xxvii; Matt. vii. and xvi.—4. A species of vulture or condor.—5. A fabulous bird in the Eastern tales. [See *Roc*.]

**ROCK**, *n.* [Dan. *roh*; Sw. *rock*; G. *rochen*. The sense is probably a *rach* or frame.] A distaff used in spinning; the staff or frame about which flax is arranged, from which the thread is drawn in spinning.

**ROCK**, *v. t.* [Dan. *rohker*, to move, stir, wag, rack, advance; G. *rûcken*; Old Fr. *roquer* or *roquer*; Sw. *ragla*, to reel; W. *rhocian*, to rock; *rhoc*, a shooting or moving different ways; Ar. *ragga*, to shake, to tremble, to agitate. This latter verb in Ch. and Syr. signifies to desire, to long for, that is, to *reach* or *stretch*, Gr. *αειρω*; and it may be a different word.] 1. To move backwards and forwards, as a body resting on a foundation; as, to *rock* a cradle; to *rock* a chair; to *rock* a mountain. It differs from *shake*, as denoting a slower and more uniform motion, or larger movements. It differs from

*swing*, which expresses a vibratory motion of something suspended.

A rising earthquake *rock'd* the ground.

*Dryden*.

2. To move backwards and forwards in a cradle, chair, &c.; as, to *rock* a child to sleep.—3. To *rock* to quiet.

Sleep *rock* thy brain. [Unusual.] *Shak*.

**ROCK**, *v. i.* To move backwards and forwards; to be moved backwards and forwards; to reel.

The *rocking* town

Supplants their footsteps.

*Philips*.

**ROCK'-ALUM**, *n.* The purest kind of alum. [See *ROCHE-ALUM*.]

**ROCK'-BASIN**, *n.* A cavity or artificial basin cut in a rock for the purpose, as is supposed, of collecting the dew or rain for ablutions and purifications prescribed by the druidical religion.

**ROCK'-BUTTER**, *n.* A supposed subsulphite of alumina, oozing from aluminous rocks. It is also called native alum; it is of a yellowish white colour, and a little unctuous to the touch.

**ROCK' CORK**, *n.* Mountain cork, a white or grey-coloured variety of asbestos. Its lightness and fibrous structure have obtained for it the name of cork.

**ROCK CRESS**, *n.* The common name of several species of cruciferous plants of the genus *Arabis*, Linn., found in Britain growing in rocky places.

**ROCK'-CROWNED**, *a.* Crowned with rocks.

**ROCK-CRYSTAL**, *n.* Limpid quartz. When purest it is white or colourless, but it is found of a greyish or yellowish white, pale yellow, or citrine. Its most usual form is that of hexagonal prisms, surmounted by hexagonal pyramids.

**ROCK'DÔE**, *n.* A species of deer.

**ROCK'ED**, *pp.* [from *rock*, the verb.] Moved one way and the other.

**ROCK'ER**, *n.* One who rocks the cradle; also, the curving piece of wood on which a cradle or chair rocks.

**ROCK'ET**, *n.* [Dan. *rahét*, *rahette*, a rocket, cracker, or squib; G. *rachete*; probably from the root of *crack* and *rachét*, Fr. *craquer*, *craqueter*.] An artificial fire-work, consisting of a cylindrical case of paper, filled with a composition of combustible ingredients, as nitre, charcoal, and sulphur. This being tied to a stick and fired, ascends into the air and bursts.—2. A formidable missile of war, invented by the late Sir William Congreve, and called after him the *Congreve rocket*. [See *CONGREVE*.]

**ROCK'ET**, *n.* [L. *eruca*.] A plant of the genus *Brassica*. There is also the *bastard rocket*, of the genus *Reseda*; the *corn rocket* and the *sea rocket*, of the genus *Bunias*; the *marsh rocket*, the *water rocket*, and the *winter rocket*, of the genus *Sisymbrium*; and the *dame's violet rocket*, of the genus *Hesperis*.

**ROCK'-FISH**, *n.* The black Goby of the family gobioidæ.

**ROCK'INESS**, *n.* [from *rocky*.] State of abounding with rocks.

**ROCK'ING**, *ppr.* Moving backward and forward.

**ROCK'ING**, *n.* The act of moving backwards and forwards; the state of being shaken.—2. A provincial term for the mass of stone or ballast laid to form the under stratum of a road.—3. In *Scotch*, *rocking*, or *rockin*, is a country evening party, so called from the practice once

prevalent of the females taking their *rock* with them, and spinning.

On Fasten-e'en we had a *rockin'*,

To ca' the crack and weave the stockin'.

*Burns*.

**ROCK'ING-CHAIR**, *n.* An arm-chair mounted on rockers, like a hobby-horse. [An American luxury.]

**ROCK'ING-HORSE**, *n.* A wooden horse for the recreation of children; a hobby-horse.

**ROCK'ING STONES**, or **LOG'GING STONES**, *n.* Large blocks of stone, poised so nicely upon the points of rocks, that a small force applied to them causes them to rock or oscillate. Sometimes also they consist of an immense mass, with a slightly rounded base resting upon a flat surface of rock below, so that an individual can move or rock it. Several of these stones are found in this country, and a celebrated

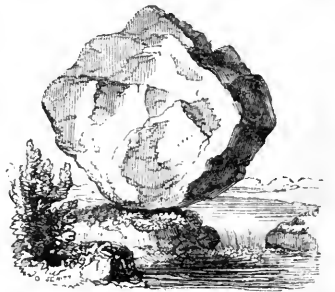

Rocking Stone, Drewsteington, Devonshire.

one at Cornwall has been computed to weigh upwards of ninety tons.

**ROCK'LESS**, *a.* Being without rocks.

**ROCO'A**, *n.* [A corruption of *Uruca*.] A coloured pulpy substance within the legume and surrounding the seeds of the *Bixa orellana*. In its purified state it is called *ANNOTTO*,—*which see*.

**ROCK'-OIL**, *n.* Petrol or petroleum.

**ROCK'-PIGEON**, *n.* A pigeon that builds her nest in rocky hollows, clefts, or caverns; the *Columba livia*.

**ROCK'PLANTS**, *n.* Plants which are distinguished by growing on or among naked rocks, and are confined to no particular region or latitude. A large number of the cryptogamia, especially mosses and lichens, belong to this class.

**ROCK'-ROOFED**, *a.* Having a roof of rock.

**ROCK'-ROSE**, *n.* *Helianthemum*, a genus of plants. [See *HELIANTHEMUM*.]

**ROCK-RU'BY**, *n.* A name sometimes given to the garnet, when it is of a strong, but not a deep red, and has a cast of blue.

**ROCK'-SALT**, *n.* Fossil or mineral salt; common salt found in masses, or beds in the new red sandstone, as in Cheshire and elsewhere. [See *SALT*.] In *America*, this name is sometimes given to salt that comes in large crystals from the West Indies, which salt is formed by evaporation from sea water, in large basins or cavities, on the isles. Hexahedral rock-salt occurs foliated and fibrous.

**ROCK'SHELLS**, *n.* The common name of certain univalves, characterized by the long straight canal which terminates the mouth of their shells.

**ROCK'-WOOD**, *n.* Ligniform asbestos. It is of a brown colour, and in its general appearance greatly resembles fossil wood.

**ROCK'-WORK**, *n.* Stones fixed in mortar in imitation of the asperities of rocks, forming a wall. Also, any sort of work or design which is formed of fragments of rocks or large stones in gardens or pleasure grounds.—2. A natural wall of rock.

**ROCK'Y**, *a.* [from *rock*.] Full of rocks; as, a *rocky* mountain; a *rocky* shore.—2. Resembling a rock; as, the *rocky* orb of a shield.—3. Very hard; stony; obdurate; insusceptible of impression; as, a *rocky* bosom.

**ROD**, *n.* [Sax. *rod*; G. *ruthe* and *reis*. In Danish, *rod* is a *root*.] 1. The shoot or long twig of any woody plant; a branch, or the stem of a shrub; as, a *rod* of hazel, of birch, of oak, &c. Hence.—2. An instrument of punishment or correction; chastisement.

I will chasten him with the *rod* of men; 2 Sam. vii.; Prov. x.

3. Discipline; ecclesiastical censures; 1 Cor. iv.—4. A kind of sceptre. *Shak.*

The *rod* and bird of peace.  
5. A wand or long slender stick, as for fishing.—6. An instrument for measuring; but more generally, a measure of length, containing five and a half yards or sixteen and a half feet, more usually termed a pole or perch. A square rod is the usual measure of brickwork, and is equal to 272½ square feet.—7. In *Scripture*, a staff or wand; 1 Sam. xiv.—8. Support.

Thy *rod* and thy staff, they comfort me; Ps. xxiii.

9. A shepherd's crook; Lev. xxvii.—10. An instrument for threshing; Is. xxviii.—11. Power; authority; Ps. cxxv.—12. A tribe or race; Ps. lxxiv.—13. A badge of office; as, the usher's *rod*, the *rod* of the lord high steward.—*Rod of divination*, or *divining rod*, a rod used by diviners professedly for the purpose of discovering water, minerals, &c., under ground. It consisted usually of a forked hazel branch.—*Rod of necromancers, enchanters, &c.*, the instrument in which their power was supposed to reside, and by which their pretended wonders were said to be accomplished.—*Rod of iron*, the mighty power of Christ; Rev. xix; Ps. ii.

**RODE**, *pret. of Ride*; also, a cross. [See *ROOD*.]

**RO'DENT**, *a.* [L. *rodere*.] Gnawing.

**RO'DENT**, *n.* An animal that gnaws.

**RO'DENTS**, } *n.* [L. *rodo*, to gnaw.]

**RODENT'IA**, } The name given by Cuvier to the Glires of Linnæus, and which constitutes the fifth order of mammalia. The order contains many genera, some of which are familiar to us; as the squirrel, rat, mouse, hare, rabbit, &c. They nibble and gnaw their food, and hence the name. The great majority of this order are gregarious.

**ROD'OMONT**, *n.* [Fr. *id.*; It. *rodomonte*, a bully; from *Rodomont*, a king of Algiers, brave, but proud and insolent. Hence the name of Ariosto's hero.] A vain boaster.

**ROD'OMONT**, *a.* Bragging; vainly boasting.

**RODOMONTADE**, *n.* [Fr. *id.*; It. *rodomontata*. See *RODOMONT*.] Vain boasting; empty bluster or vaunting; rant.

I could show that the *rodomontades* of Almanzor are neither so irrational nor impossible. *Dryden*.

**RODOMONTADE**, *v. i.* To boast; to brag; to bluster; to rant.

**RODOMONT'ADIST**, } *n.* A bluster-  
**RODOMONTA'DOR**, } ing boaster;  
one that brags or vaunts.

**RODOMONTA'DO**, *n.* *Rodomontade*.

**ROE**, } *n.* [Sax. *ra* or *raa*, *ræge*  
**ROEBUCK**, } or *hræge*; G. *reh* and  
*rehbock*.] 1. A species of deer, the *Cervus capreolus*, with erect cylindrical branched horns, forked at the summit.



Roebuck (*Cervus capreolus*).

This is one of the smallest of the cervine genus, but of elegant shape and remarkably nimble. It prefers a mountainous country, and herds in families.—2. *Roe*, the female of the hart.

**RÖE**, *n.* [G. *rogen*; Dan. *rogn*, *ravn*; that which is ejected. So in Dan. *roge*, is spittle.] The seed or spawn of fishes. The roe of the male is called *soft roe*, or *milt*; that of the female, *hard roe*, or *spawn*.

**RÖE-STONE**, *n.* A name given to the oolite, a variety of limestone, from its being composed of small rounded particles resembling the roe or eggs of a fish. [See *OOHITE*.]

**ROGA'TION**, *n.* [Fr. from L. *rogatio*; *rogo*, to ask.] 1. Litany; supplication. He perfecteth the *rogations* or litanies before in use. *Hooker*.

2. In *Roman jurisprudence*, the demand by the consuls or tribunes, of a law to be passed by the people.

**ROGA'TION-WEEK**, *n.* The second week before Whitsunday, thus called from the three fasts observed therein; viz., on Monday, Tuesday, and Wednesday, called *rogation-days*, because of the extraordinary prayers then made for the fruits of the earth, or as a preparation for the devotion of the Holy Thursday. It was a general custom in former times to go round the bounds and limits of parishes on one of the three days preceding Holy Thursday; when the minister, accompanied by his church-wardens and parishioners, used to deprecate the vengeance of God, beg a blessing on the fruits of the earth, and preserve the rights and properties of the parish.

**ROGUE**, *n.* [Horne Tooke considers this word to be from the past tense of the Sax. *wreg* an, meaning covered, cloaked. The earliest acceptance of *rogue* being a sturdy beggar, the word probably comes from L. *rogo*, I beg.] 1. In *law*, a vagrant; a sturdy beggar; a vagabond. Persons of this character were, by the ancient laws of England, to be punished by whipping and having the ear bored with a hot iron. [See *VAGRANT*.] 2. A knave; a dishonest person; applied now, we believe, exclusively to males. This word comprehends thieves and robbers, but is generally applied to such as cheat and defraud in mutual dealings, or to counterfeits.

The *rogue* and fool by fits is fair and wise. *Pope*.

3. A name of slight tenderness and endearment.

Alas, poor *rogue*, I think indeed she loves. *Shak.*

4. A wag; a sly fellow.

**ROGUE**, *v. i.* To wander; to play the vagabond. [Lit. us.] 2. To play knavish tricks. [Little used.]

**ROGUE MONEY**, *n.* In *Scotland*, an assessment laid on each county for defraying the expense of apprehending offenders, subsisting them in jail, and prosecuting them. The freeholders in each county fix the sum necessary to be raised, and it is collected and accounted for by a person appointed by them.

**RÖGUERY**, *n.* The life of a vagrant. [Now lit. us.] 2. Knavish tricks; cheating; fraud; dishonest practices.

'Tis no scandal grown,  
For debt and *roguey* to quit the town. *Dryden*.

3. Waggery; arch tricks; mischievousness.

**RÖGUESHIP**, *n.* The qualities or personage of a rogue; applied in mockery.

**RÖGUE'S YARN**, *n.* In *marine lan*, a rope yarn which is twisted in a contrary manner to the other part of a rope. It is placed in the middle of each strand in all cables or cordage made for the king's service, to distinguish them from the merchants' cordage.—*Rogue's march*, an air played when a soldier is drummed out of a regiment.

**RÖGUISH**, *a.* Vagrant; vagabond. [Nearly obsolete.] 2. Knavish; fraudulent; dishonest. [This is the present sense of the word.] 3. Waggish; wanton; slightly mischievous.

**RÖGUISHLY**, *adv.* Like a rogue; knavishly; wantonly.

**RÖGUISHNESS**, *n.* The qualities of a rogue; knavery; mischievousness.—2. Archness; sly cunning; as, the *roguishness* of a look.

**RÖGUISH PLANTS**, *n.* Spurious varieties of plants.

**RÖGUY**, } *a.* Knavish; wanton.

**ROHU'NA**, *n.* In the *East Indies*, the name given to the *Soyyida febrifuga*, called on the Coromandel coast the red wood tree. The bark of this tree is a useful tonic in India in intermittent fevers.

**ROIL**, *v. t.* [This is the Arm. *brella*, Fr. *brouiller*, *embrouiller*, primarily to turn or stir, to make intricate, to twist, wrap, involve, hence to mix, confound, perplex, whence Eng. *broil*, Fr. *brouillard*, mist, fog. In English, the prefix or first letter is lost.] 1. To render turbid by stirring up the dregs or sediment; as, to *roil* wine, cider, or other liquor in casks and bottles.—2. To excite some degree of anger; to disturb the passion of resentment. [These senses are in common use in *New England*, and locally in *England*.] 3. To perplex. [Local in *England*.]

**ROIL'ED**, *pp.* Rendered turbid or foul by disturbing the lees or sediment; angered slightly; disturbed in mind by an offence.

**ROIL'ING**, *ppr.* Rendering turbid; or exciting the passion of anger.

*Note.* This word is as legitimate as any in the language.

**ROIN**, } *n.* A scab or scurf.

**ROINT**. [See *AROYNT*.]

**ROIST**, } *v. i.* [Arm. *reustila*, to  
**ROIST'ER**, } embroil. This word be-  
longs to the root of *rustle*, *brustle*, Sax. *brysan*, to shake, to rush, W. *rhyssiaw*, to rush, to straiten, to entangle, *rhyssu*,

id.] To bluster; to swagger; to bully; to be bold, noisy, vaunting, or turbulent.

ROISTER, } † *n* A bold, blustering,  
ROISTERER, } turbulent fellow.  
ROISTERLY, *a*. Blustering; violent.  
ROIST'ERLY, *adv*. In a bullying, violent manner. [*Little used.*]

RÖKY, † *a*. [*See BEEK.*] Misty; foggy; cloudy.

ROLL, *v. t.* [*D.* and *G. rollen*; *W. rholian*; *Fr. rouler*; *Ir. rolam*. It is usual to consider this word as formed by contraction from the Latin *rotula*, a little wheel, from *rota*, *W. rhod*, a wheel. But it is against all probability that all the nations of Europe have fallen into such a contraction. *Roll* is undoubtedly a primitive root, on which have been formed *troll* and *stroll*.] 1. To move by turning on the surface, or with a circular motion, in which all parts of the surface are successively applied to a plane; as, to *roll* a barrel or puncheon; to *roll* a stone or ball. Sisyphus was condemned to *roll* a stone to the top of a hill, which, when he had done so, *rolled* down again, and thus his punishment was eternal.—2. To revolve; to turn on its axis; as, to *roll* a wheel or a planet.—3. To move in a circular direction.

To dress, to troll the tongue and *roll* the eye.  
*Milton.*

4. To wrap round on itself; to form into a circular or cylindrical body; as, to *roll* a piece of cloth; to *roll* a sheet of paper; to *roll* parchment; to *roll* tobacco.—5. To inwrap; to bind or involve in a bandage or the like.—6. To form by rolling into round masses.—7. To drive or impel any body with a circular motion, or to drive forward with violence or in a stream. The ocean *rolls* its billows to the shore. A river *rolls* its waters to the ocean.—8. To spread with a roller or rolling-pin; as, to *roll* paste.—9. To produce a periodical revolution.

Heav'n shone and *rolled* her motions.  
*Milton.*

10. To press or level with a roller; as, to *roll* a field.—*To roll one's self*, to wallow; *Mic. i.*

ROLL, *v. i.* To move by turning on the surface, or with the successive application of all parts of the surface to a plane; as, a ball or wheel *rolls* on the earth; a body *rolls* on an inclined plane.

—2. To move, turn, or run on an axis; as a wheel. [*In this sense, revolve* is more generally used.] 3. To run on wheels.

And to the *rolling* chair is bound. *Dryden.*

4. To revolve; to perform a periodical revolution; as, the *rolling* year; ages *roll* away.—5. To turn; to move circularly.

And his red eyeballs *roll* with living fire.  
*Dryden.*

6. To float in rough water; to be tossed about.

Twice ten tempestuous nights I *rolled*.  
*Pope.*

7. To move, as waves or billows, with alternate swells and depressions. Waves *roll* on waves.—8. To fluctuate; to move tumultuously.

What *different* sorrows did within thee *roll*.  
*Prior.*

9. To be moved with violence; to be hurled.

Down they fell

By thousands, angel on archangel *roll'd*.  
*Milton.*

10. To be formed into a cylinder or

ball; as, the cloth *rolls* well.—11. To spread under a roller or rolling-pin. The paste *rolls* well.—12. To wallow; to tumble; as, a horse *rolls*.—13. To rock or move from side to side; as, a ship *rolls* in a calm.—*To roll a drum*, to beat it with strokes so rapid that the sound resembles that of a rolling ball, or of a carriage wheel rolling rapidly over a rough pavement.

ROLL, *n* The act of rolling, or state of being rolled; as, the *roll* of a hall.—

2. The thing rolling.—3. A mass made round; something like a ball or cylinder; as, a *roll* of fat; a *roll* of wool.—

4. A roller; a cylinder of wood, iron, or stone; as, a *roll* to break clods.—

5. A quantity of cloth wound into a cylindrical form; as, a *roll* of woollen or satin; a *roll* of lace.—6. A cylindrical twist of tobacco.—7. An official writing; a list; a register; a catalogue; as, a muster-*roll*; a court-*roll*.—8. The beating of a drum with strokes so rapid as to produce a continued sound like that of a rolling ball on a hard surface.—9. *Rolls* of court, of parliament, or of any public body, are the parchments on which are engrossed, by the proper officer, the acts and proceedings of that body, and which being kept in rolls, constitute the records of such public body. In the court of session the *rolls of court* are rolls or lists of depending causes. They are divided generally into the *inner* and *outer-house rolls*. The outer-house rolls are the regulation roll, the suspension and advocacy roll, the ordinary action roll, and the reduction roll. The ordinary inner-house rolls are the single bill roll, the summary roll, the long roll, and the jury cause roll. Besides these there are the teind rolls.—*Master of the rolls*. [*See MASTER.*] 10. In antiquity, a volume; a book consisting of leaf, bark, paper, skin, or other material on which the ancients wrote, and which being kept *rolled* or folded, was called in Latin *volumen*, from *volvo*, to roll. Hence,—11. A chronicle; history; annals.

Nor names more noble graced the *rolls* of fame.  
*Trumbull.*

12. † Part; office; that is, round of duty, like *turn*.—*Roll moulding*, in *archt.*, a round moulding divided longitudinally along the middle, the upper half of which projects over the lower.



Roll Moulding.

It occurs often in the early Gothic decorated style, where it is profusely used for drip-stones, string-courses, abacuses, &c.—*Roll and fillet moulding*, a round



Roll and Fillet Moulding.

moulding with a square fillet on the face of it. It is most usual in the early decorated style, and appears to have

passed by various gradations into the ogee.—*Roll call*, the calling over the names of the men who compose any military body.

ROLLED, *pp*. Moved by turning; formed into a round or cylindrical body; levelled with a roller, as land.

ROLLER, *n*. That which rolls; that which turns on its own axis; particularly, a cylinder of wood, stone, or metal, used in the construction of various machines, both in husbandry and the arts. *Rollers* are of various kinds and used for various purposes, as for smoothing, compressing, or crushing bodies, engraving, extending metal into thin plates, diminishing friction, &c. As an agricultural machine, the roller is employed in tillage lands to break the lumps of earth, to press in and firm the ground about newly sown seeds; on grass lands, it is used to compress and smooth the surface, and render it better adapted for mowing. In gardening, the roller is used for similar purposes.—2. A bandage; a fillet; properly, a long broad bandage used in surgery.—3. The name of an insessorial or perching bird, the *Coracias garrula*, Linn. The rollers are allied to the crows and jays, but more wild and in-



Roller (*Coracias garrula*).

tractable than either. They are found in Europe, Asia, Africa, and in the hot climates of America. The plumage of almost all the species is very beautiful, being in general an assemblage of blue and green mixed with white, and lightened by the contrast of more sombre colours. Among seamen, *rollers* are unusually heavy waves which set in upon a coast or island without wind.

ROLLICKING, *a*. A sportive Hibernian word, applied to a roistering blade.

ROLLING, *ppr*. Turning over; revolving; forming into a cylinder or round mass; levelling, as land.

ROLLING, *a*. Wavy; rising and falling in gentle slopes, as the *rolling* land of prairies.

ROLLING, *n*. In *mech.*, that motion of a body which is caused by its rectilinear motion being resisted by the friction of some surface or otherwise, by which means all the parts of the surface of the body come into successive contact with those of another, under such conditions as that at every instant the portion of the two surfaces which have been in contact are exactly equal. When this condition is not fulfilled, the one surface is said to slide upon the other. The friction of bodies in rolling is much less than that of bodies in sliding; hence the advantage of wheels to all kinds of carriages. [*See FRICTION.*] 2. In *naval lan.*, the lateral oscillation of a ship, or her motion from side to side. This motion is often very

great when the ship is running before thesea, and endangers the masts, strains the sides, and loosens the decks at the waterways.

**ROLLING-FREIGHT**, *n.* Among *shippers*, &c., that part of a vessel's cargo composed of produce in barrels, or encased goods; as distinguished from *bulk freight*, or that lying at large in a ship's hold. *Rolling freight* is, from its portability, always preferred to bulk freight.

**ROLLING-LANDS**, *n. pl.* Undulated ground; territory nearly level, but varied by small hills and valleys; such as is often seen in the western regions of the United States. [*Peculiar to America.*]

**ROLLING MILL**, or **MAÇHÏNE**, *n.* A combination of machinery used in the manufacture of malleable iron and other metals of the same nature. It consists of one or more sets of rollers, whose surfaces are made to revolve nearly in contact with each other, while the heated metal is passed between them, and thereby subjected to a strong pressure. The object of this operation is twofold: 1st, To expel the scoriæ and other impurities; and 2dly, To determine the form of the mass of metal into a plate, bolt, or bar, according to the form given to the surfaces of the rollers.

**ROLLING PENDULUM**, *n.* A cylinder caused to oscillate in small spaces on a horizontal plane.

**ROLLING-PIN**, *n.* A round piece of wood, tapering at each end, with which paste is moulded and reduced to a proper thickness.

**ROLLING-PRESS**, *n.* A machine consisting of two or more cylinders, used under various modifications by calenderers, copperplate printers, bookbinders, &c.

**ROLLING TACKLE**, *n.* A tackle or pulley hooked to the weather quarter of a yard, and to a lashing round the mast, in order to keep the yard constantly over to leeward, thereby depriving it of play and friction when the ship rolls to windward.

**ROLLS**, *n.* A precinct situated between the cities of London and Westminster, enjoying certain exemptions, and hence called the *liberty of the rolls*; which name is derived from the court *rolls*, or law records, being repositied in its chapel.—*Master of the rolls.* [*See MASTER, &c.*]

**ROLLY-POOLY**, *n.* [said to be *roll* and *pool*, or *roll*, *ball* and *pool.*] A game in which a ball, rolling into a certain place, wins.

**RÔMAGE**, *n.* Bustle; tumultuous search. [*See RUMMAGE.*]

**ROMA'IC**, *n.* The modern language of Greece, which is a corrupted form of the language of ancient Greece, but the character used for it is the same.

**ROMA'L**, (*n.* roma'ul.) A species of silk handkerchief.

**RO'MAN**, *a.* [*L. Romanus*, from *Roma*, the principal city of the Romans in Italy. *Rome* is the oriental name *Ramah*, elevated, that is, a hill; for fortresses and towns were often placed on hills for security; Heb. and Ch.  $\text{רומ}$ , *rum*, to be high, to raise.] 1. Pertaining to Rome, or to the Roman people.—2. Romish; popish; professing the religion of the pope.—*Roman Catholic*, as an adjective, denoting the religion professed by the people of Rome and of Italy, at the head of which is the

pope or bishop of Rome; as a noun, one who adheres to the papal religion.—*Roman order*, in *arch.* [*See ROMAN ARCHITECTURE.*] *Roman alum*, an alum extracted from the volcanic rocks of the Solfaterra, near Naples.—*Roman letter*, the ordinary printing letter now in use, in distinction from the italic.—*Roman vitriol*, sulphate of copper or blue vitriol.

**RO'MAN**, *n.* A native of Rome.—2. A citizen of Rome; one enjoying the privileges of a Roman citizen.—3. One of the Christian church at Rome to which Paul addressed an epistle, consisting of converts from Judaism or paganism.

**ROMAN ARCHITECTURE**, *n.* The style of architecture used by the Romans. Founded on the Grecian architecture, the Roman is, though less chaste and simple, more varied, richer, and in some respects bolder and more imposing. It embraces two additional order of columns, the Tuscan and the composite. All its curved mouldings are more circular, and have greater projection, and its pediments are steeper. Ornaments, too, are more frequently introduced. It is further characterized by the use of the arch, which in its late periods was one of its leading features, and was unknown in the architecture of the Greeks.

**ROMANCE'**, *n.* [*Fr. roman*; *It. romanzo*; *Sp. romance*, the common vulgar language of Spain, and *romance*; *Port. id.* any vulgar tongue, and a species of poetry; *W. rham*, a rising over; *rhamant*, a rising over, a vaulting or springing, an omen, a figurative expression, *romance*, as an adjective, rising boldly, *romantic*; *rhamanta*, to rise over, to soar, to reach to a distance, to divine, to romance, to allegorize; *rhamantu*, to use figurative or high flown language, &c. According to some, the term *romance* is derived from the class of languages in which such fictitious narratives, in modern times, were first widely known and circulated. These were the tongues derived from the Latin, Italian, Spanish, French, which were all Roman dialects, in contradistinction to the European languages of Teutonic origin.] 1. A fabulous relation or story of adventures and incidents designed for the entertainment of readers; a tale of extraordinary adventures, fictitious and often extravagant, usually a tale of love or war, subjects interesting the sensibilities of the heart or the passions of wonder and curiosity. *Romance* differs from the *novel*, as it treats of great actions and extraordinary adventures; that is, according to the Welsh signification, it vaults or soars beyond the limits of fact and real life, and often of probability.

The first *romances* were a monstrous assemblage of histories, in which truth and fiction were blended without probability; a composition of amorous adventures and the extravagant ideas of chivalry. *Encyc.* 2. A fiction; a lie.

**ROMANCE'**, *v. i.* To forge and tell fictitious stories; to deal in extravagant stories.

**ROMANCE'**, or **ROMA'NIC LANGUAGE**, *n.* The name given to a kind of bastard Latin, which came into common use in Western Europe after the fall of the Roman empire, among the populations formerly subject to Rome. This language was soon formed into different dialects, from which sprung

the languages now prevalent in the South of Europe, viz., the Italian, French, Spanish, Portuguese, and the Romanic in the narrower sense.

**RO'MAN CEMENT**, *n.* A water cement professedly imitated from that used in surface-fronting brick buildings in Italy.

**ROMAN'CER**, *n.* One who invents fictitious stories.—2. A writer of romance.

**ROMANCE'RO**, *n.* In *Spanish*, the general name for a collection of the national ballads or *romances*.

**ROMAN'GING**, *ppr.* Inventing and telling fictitious tales; building castles in the air.

**ROMAN'CY**, *a.* Romantic. [*Not proper.*] **ROMANESQUE**, *n.* [*Fr.*] In *painting*, that which is made up of fable or romance. In historical painting it consists in the choice of a fanciful subject rather than one founded on fact.—*Romanesque* in *literature*, is applied to the common dialect of Languedoc and some other districts in the South of France.—*Romanesque* in *arch.*, a general term for all debased styles of architecture which have sprung from the Roman, and which are known, in their various modifications, by the names of Byzantine, Lombard, Saxon, &c.

**RO'MANISM**, *n.* The tenets of the church of Rome.

**RO'MANIST**, *n.* An adherent to the papal religion; a Roman catholic.

**RO'MANIZE**, *v. t.* To latinize; to fill with Latin words or modes of speech.—2. To convert to the Roman catholic religion or opinions.

**RO'MANIZE**, *v. i.* To conform to Roman catholic opinions, customs, or modes of speech.

**RO'MANIZED**, *pp.* Latinized; conformed to the Roman catholic faith.

**RO'MANIZING**, *ppr.* Latinizing; conforming to the Roman catholic faith.

**RO'MAN LAW**, *n.* The name given to the law which was founded originally upon the constitutions of the ancient kings of Rome; next upon the twelve tables of the decemviri; then upon the laws or statutes enacted by the senate or by the people; the edicts of the prætor and the responsa prudentum, or the opinions of learned lawyers; and lastly, upon the imperial decrees or constitutions of the emperors. The principles of the Roman law are incorporated in a remarkable degree with those of the law of Scotland, and they have exerted an extraordinary influence over every system of jurisprudence in Europe.

**RO'MAN SCHOOL**, *n.* In *painting*, that style of art which was eventually formed, or prevailed, at Rome during the golden age of painting, in the beginning of the 16th century, whether it was practised by subjects of the papal government, natives of the city of Rome, or strangers resident there. The works of Raphael exhibit this style in its full development, or most perfect state, and he is accordingly the head or representative of the Roman school.

**ROMANSH'**, *n.* The language of the Grisons in Switzerland, a corruption of the Latin.

**ROMAN'TIC**, *a.* Pertaining to romance or resembling it; wild; fanciful; extravagant; as, a *romantic* taste; *romantic* notions; *romantic* expectations; *romantic* zeal.—2. Improbable or chimerical; fictitious; as, a *romantic* tale.—3. Fanciful; wild; full of wild or fan-

tastic scenery; as, a *romantic* prospect or landscape; a *romantic* situation.

**ROMANTIC, n.** That singular intermixture of the wonderful and mysterious with the sublime and beautiful, which introduces us into an enchanted existence, and raises us above the bare realities of life by its dazzling peculiarities.

**ROMANTICALLY, adv.** Wildly; extravagantly.

**ROMANTICISM, n.** A term of recent invention, applied chiefly to the fantastic and unnatural productions of the modern French school of novelists, at the head of which are Victor Hugo, Dumas, &c.

**ROMANTICNESS, n.** Wildness; extravagance; fancifulness.—2. Wildness of scenery.

**ROMANZOVITE, n.** A recently discovered mineral of the garnet kind, of a brown or brownish yellow colour; named from Count Romanzoff.

**ROMAUNT, n.** [Norm. Fr.] A romantic ballad.

**ROMÉINE, n.** [From the mineralogist Romé de l'Isle.] A mineral consisting of antimonious acid and lime, presenting a hyacinth or honey-yellow colour, and occurring in square octahedrons.

**ROME'PENNY, } n.** [Rome, and Sax. ROME'SCOT, } pennig or sceat.] A tax of a penny on a house, formerly paid by the people of England to the church of Rome; called also Peterpence.

**RÓMISH, a.** [from Rome.] Belonging or relating to Rome, or to the religion professed by the people of Rome and of the western empire, of which Rome was the metropolis; Roman catholic; as, the *Romish* church; the *Romish* religion, ritual, or ceremonies.

**RÓMIST, n.** A Roman catholic.

**ROMP, n.** [a different spelling of *ramp*; W. *rhām*, a rising over; *rhānu*, to reach over, to soar, to vault. See *RAMP* and *ROMANCE*.] 1. A rude girl who indulges in boisterous play.—2. Rude play or frolic.

*Romp* loving miss  
Is hauled about in gallantry robust.

*Thomson.*

**ROMP, v. i.** To play rudely and boisterously; to leap and frisk about in play.

**ROMPING, ppr.** Playing rudely; as a *noun*, rude boisterous play.

**ROMPISH, a.** Given to rude play; inclined to romp.

**ROMPISHLY, adv.** In a rude or boisterous manner.

**ROMPISHNESS, n.** Disposition to rude boisterous play; or the practice of romping.

**ROM'PU, } n.** [L. *rumpto*, to break.]  
**ROMPEE', } In her,** an ordinary, such as a chevron, a bend that is broken or parted asunder, called also *fracted*.

**RONDE, n.** [Fr.] In *typography*, a kind of round cursive character, in imitation of French writing, similar to our old chancery engrossing character, round script type.



Chevron Rompu.

**RONDEAU, } n.** [Fr. *rondeau*, from RON'DO, } *ronde*, round.] 1. A kind of poetry, commonly consisting of thirteen verses, of which eight have one rhyme, and five another. It is divided into three couplets, and at the end of the second and third, the beginning of

the *rondeau* is repeated in an equivocal sense, if possible.—2. In *music*, the *rondo*, vocal or instrumental, generally consists of three strains, the first of which closes in the original key, while each of the others is so constructed in modulation as to reconduct the ear in an easy and natural manner to the first strain.—3. A kind of jig or lively tune that ends with the first strain repeated.

**RONDELE'TIA, n.** A genus of plants, nat. order Cinchonaceæ, characterized by having a calyx with a subglobular tube. It occurs chiefly in America and the West Indies. A kind of fever bark is obtained at Sierra Leone from *Rondeletia febrifuga*.

**RON'DLE, RON'DEL, } n.** [from *round*.] A round mass.—In *fort*, a small round tower erected in some particular cases at the foot of the bastion. [See *ROUNDEL*.]

**RON'DO.** See *RONDEAU*.

**RON'DURE, } n.** [Fr. *rondeur*.] A round; a circle.

**RONG, the old pret. and pp. of Ring,** now *runq*.

**RÓNION, } n.** (run'yon.) [Fr. *rognon*, kidney.] A fat bulky woman.

**RONT, n.** An animal stunted in its growth. [Now written and pronounced *ront*.]

**ROOD, n.** [a different orthography of *Rod*,—which see.] 1. A square measure, the fourth part of a statute acre, and equal to 40 square perches, or square poles. [See *ACRE*.]—2. A measure of length, containing 40 perches.

**ROOD, n.** [Sax. *rode* or *rod*.] A cross, crucifix, or figure of Christ on the cross, placed in a church. The *holy rood* was one, generally, as large as life, elevated at the junction of the nave and choir, and facing the western entrance to the church. Sometimes images of the Virgin Mary and St. John were placed, the one on the one side, and the other on the other side, of the image of Christ. These roods were frequently beautifully sculptured, and often placed in niches, sometimes let into the wall near the entrance door.

**ROOD'LOFT, n.** The gallery in a church where the *rood* and its appendages were placed. This loft or gallery was commonly placed over the chancel screen in parish churches, or between the nave and chancel; but in cathedral churches it was placed in other situations. The *rood-tower*, or *steeple*, was that which stood over the intersection of the nave with the transepts.

**ROOD'Y, a.** Coarse; luxurious.

**ROOF, n.** [Sax. *raf*, *hrof*; Gr. *ροοφον*, *roophon*, from *ροοφω*, to cover. Qu. Russ. *krov*, Slav. *strop*.] 1. In *arch*, the cover of a building, irrespective of the materials of which it is composed. Roofs are distinguished, 1st. By the materials of which they are formed, as stone, brick, wood, slate roofs, &c.—2d. By their form and mode of construction, of which there is great variety, as shed, curb, hip, gable, pavilion, and ogee

angle with the horizon. In *carpentry*, roof signifies the timber frame work by which the roofing or covering materials of the building are supported.

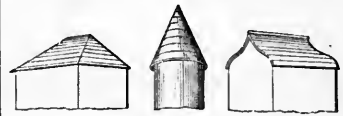

Hip Roof. Conical Roof. Ogee Roof.



Curb Roof. M Roof.

This consists in general of the principal rafters, the purlins, and the common rafters. The principal rafters or principals, as they are more commonly termed, are set across the building at about 10 or 12 feet apart; the purlins lie horizontally upon these, and sustain the common rafters, which carry the covering of the roof. The following figures show the two varieties of principals which are in common use; the first, the king post principal, and the second, the queen post principal, with the purlins and common rafters *in situ*. The mode of framing here exhibited is termed a truss. Sometimes, when the

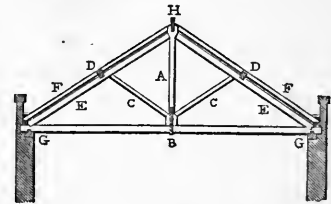

King Post Roof.

A, King-post.  
B, Tie beam.  
C, C, Struts or braces.  
D, D, Purlins.  
E, E, Backs or principal rafters.  
F, F, Common rafters.  
G, G, Wall plates.  
H, Ridge piece.

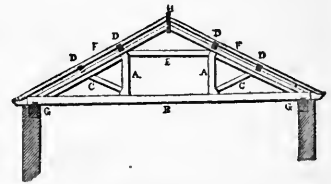

Queen Post Roof.

A, A, Queen-posts.  
B, Tie beam.  
C, C, Struts or braces.  
D, D, Purlins.  
E, E, Straining beam.  
F, F, Common rafters.  
G, G, Wall plates.  
H, Ridge piece.



Shed Roof. Gable Roof.

roofs.—3d. They are further divided into *high pitched* or *low pitched* roofs, as their inclined sides make a greater or lesser

width of the building is not great, common rafters are used alone to support the roof. They are in that case joined together in pairs, nailed where they meet at top, and connected with a *tie* at the bottom. They are then termed *couples* or *couple close*. In Asia, the *roofs* of houses are flat or horizontal. The same name, *roof*, is given to the

sloping covers of huts, cabins and ricks; to the arches of ovens, furnaces, &c.—2. A vault; an arch; or the interior of a vault; as, the *roof* of heaven.—3. The vault of the mouth; the upper part of the mouth; the palate.

If I do not remember thee, let my tongue cleave to the *roof* of my mouth; Ps. cxxxvii. **ROOF**, *v. t.* To cover with a roof.

I have not seen the remains of any Roman buildings, that have not been *roofed* with vaults or arches.  *Addison.*

2. To inclose in a house; to shelter.

Here had we now our country's honour *roof'd.*  *Shak.*

**ROOF'ED**, *pp.* Furnished or covered with a roof or arch.

**ROOF'ING**, *ppr.* Covering with a roof.

**ROOF'ING**, *n.* The materials of which a roof is composed; or materials for a roof.

**ROOF'LESS**, *a.* [Sax. *roffleas.*] 1. Having no roof; as, a *roofless* house.—2.

Having no house or home; unsheltered.

**ROOF'Y**, *a.* Having roofs.

**ROOK**, *n.* [Sax. *hroc*; G. *roche*; Dan. *roge*, *raage*, a *rooth*, and *krage*, a crow.

This word belongs to the root of *crow*, or is rather the same word dialectically varied; Sw. *hraka*; G. *krähe*; L. *graculus*; probably from its voice; Ir. *grag*, *gragam*. See CROW and CROAK.]

1. A bird of the genus *Corvus*, the bird mentioned by Virgil under this name, the *C. frugilegus*, Linn. This bird resembles the crow, but differs from it in not feeding on carrion, but on insects and grain. In crows also the nostrils and root of the bill are clothed with feathers, but in rooks the same parts are naked, or have only a few bristly hairs. The rook is content with feeding on the insect tribe (particularly the larvæ of the cock-chaffer), and on grain; and there can be no doubt that it amply repays the farmer for the seed it takes, by its assiduity in clearing the land of wire-worms and the destructive grub. Rooks are gregarious at all seasons, resorting constantly to the same trees every spring to breed, when the nests may be seen upon the upper branches. They are spread over the greater part of Europe; but no where do they seem to be more abundant than in Great Britain and Ireland.—2. A cheat; a trickish, rapacious fellow.

**ROOK**, *n.* [It. *rocco*, a bishop's staff, a crossier, a rook at chess.] In chess, one of the four pieces placed on the corner squares of the board; also called a *castle*. The rook moves the whole extent of the board, unless impeded by some other piece.

**ROOK**, *v. i.* To cheat; to defraud.

**ROOK**, *v. t.* To cheat; to defraud by cheating.—2. To castle at chess.

**ROOK**, *v. i.* To squat. [See RUCK.]

**ROOK'ED**, *pp.* Cheated; defrauded.

**ROOK'ERY**, *n.* A wood, &c., used for nesting-places by rooks.—2. In *low language*, a brothel.

**ROOK'ING**, *ppr.* Cheating.

**ROOK'Y**, *a.* Inhabited by rooks; as, the *rooky* wood.

**ROOM**, *n.* [Sax. *rum*; Dan. and Sw. *rum*; G. *raum*; Goth. *rumis*, room, place; Ir. *rum*, a floor or room; G. *räumen*, Sax. *rumian*, *ryman*, to give place, to amplify, to enlarge; Sax. *rum-gifa*, liberal. It may be allied to *room*, *ramble*.] 1. Space; compass; extent of place, great or small. Let the words occupy as little *room* as possible.—2. Space or place unoccupied.

Lord, it is done as thou hast commanded and yet there is *room*; Luke xiv.

3. Place for reception or admission of any thing. In this case there is no *room* for doubt or for argument.—4.

Place of another; steady; as in succession or substitution. One magistrate or king comes in the *room* of a former one. We often place one thing in the *room* of another; 1 Kings xx.—5. Unoccupied opportunity. The eager pursuit of wealth leaves little *room* for serious reflection.—6. An apartment in a house; any division separated from the rest by a partition; as a parlour, a drawing-room or bed-room; also, an apartment in a ship, as the cook-room, bread-room, gun-room, &c.—7. A seat; Luke xiv.—To *make room*, to open a way or passage; to free from obstructions.—To *make room*, to open a space or place for any thing.—To *give room*, to withdraw; to leave space unoccupied for others to pass or to be seated.

**ROOM**, *v. i.* To occupy an apartment; to lodge; an *academic use of the word in the United States*. A. B. *rooms* at No. 7.

**ROOM'AGE**, *n.* [from *room*.] Space; place.

**ROOM'FUL**, *a.* Abounding with rooms, or room. As a noun, in *common language*, a room filled with people, furniture, &c.

**ROOM'INESS**, *n.* Space; spaciousness; large extent of space. *Roomth*, space, and *Roomthy*, spacious, are ill formed words, and not now used.

**ROOM'Y**, *a.* Spacious; wide; large; having ample room; as, a *roomy* mansion; a *roomy* deck.

**ROOP**, *n.* Hoarseness. [Little used.]

**ROOSE**, **RUSE**, *v. t.* (Suio-Goth. *roosa*.) To extol, to commend highly. [Scotch.]

**ROOST**, *n.* [Sax. *hroost*; D. *roest*, roost; *roosten*, to roost.] The pole or other support on which fowls rest at night. He clapp'd his wings upon his *roost*.

*Dryden.*

At *roost*, in a state for rest and sleep.

**ROOST**, *v. i.* To sit, rest, or sleep, as fowls on a pole, tree, or other thing at night.—2. To lodge, in burlesque.

**ROOSTER**, *n.* In *America*, the male of the domestic fowl; a cock.

**ROOST'ING**, *ppr.* Sitting for rest and sleep at night.

**ROOT**, *n.* [Dan. *rod*; Sw. *rot*; L. *radix*; Ir. *raidis*; W. *rhaiz*, a ray or spear, whence *geraiz*, a root. A root is a shoot, and only a different application of *rod*, L. *radius*.] 1. That part of a plant which enters and fixes itself in the earth, and serves to support the plant in an erect position, while by means of its radicles, it imbibes nutriment for the stem, branches and fruit. There are six distinct organs which are capable of entering into the composition of a root, viz. the *radicle*, the *fibril*, the *soboles*, the *bulb*, the *tuber*, and the *rhizoma*. Roots receive different names according to their structure, forms, and positions; as branched, bulbiferous, fibrous, horizontal, oblique, simple, tapering, vertical, &c.—2. The part of any thing that resembles the roots of a plant in manner of growth; as, the *roots* of a cancer, of teeth, &c.—3. The bottom or lower part of any thing. Deep to the *roots* of hell.  *Milton.*

He putteth forth his hand upon the rock; he overturneth the mountains by the *roots*; Job xxviii. 9.

[Burnet uses the word in the same sense; but the *roots* of a mountain range now mean its lower slopes, where they subside into plains, &c.]—4. A plant whose root is esculent or the

most useful part; as beets, carrots, &c.—5. The original or cause of any thing.

The love of money is the *root* of all evil; 1 Tim. vi.

6. The first ancestor.

They were the *roots* out of which sprung two distinct people.  *Locke.*

7. In *arith.* and *alge.*, the root of any quantity is such a quantity as, when multiplied into itself a certain number of times, will exactly produce that quantity. Thus 2 is a root of 4, because when multiplied into itself, it exactly produces 4. The power is named from the number of the factors employed in the multiplication, and the root is named from the power. Thus if a quantity be multiplied once by itself, the product is called the second power or square, and the quantity itself the *square root*, or second root of the product; if the quantity be multiplied twice by itself we obtain the third power, or cube, and the quantity is the *cube root* or third root, and so on. The algebraic sign of a root is  $\sqrt{\quad}$ , and the particular root is indicated by placing above the sign the figure which expresses the number of the root, which figure is called the index of the root. Thus  $\sqrt[4]{16}=2$ , indicates the fourth root of 16;  $\sqrt[4]{4}$  or  $\sqrt[4]{4}=2$ , the square root of 4. The same is the case with algebraic quantities, as  $\sqrt[3]{a^3+3a^2b+3ab^2+b^3}=a+b$ . [See POWER, INDEX, INVOLUTION, EVOLUTION.] *Root* of an equation, in *alge.*, the value of the unknown quantity which enters into the equation. [See EQUATION.]—8. Means of growth. "He hath no *root* in himself;" that is, no soil in which grace can grow and flourish; Matth. xiii.—9. In *music*, the fundamental note of any chord.—*Root* of bitterness, in Scripture, any error, sin, or evil that produces discord or immorality.—To *take root*, to become planted or fixed; or to be established; to increase and spread.—To *take deep root*, to be firmly planted or established; to be deeply impressed. *Root* in *husbandry*, the cultivation of such plants as are valuable on account of their tubers, bulbs, or other enlarged parts, produced under or immediately on the ground, as the potato, turnip, carrot, &c., which are called *root crops*.

**ROOT**, *v. i.* To fix the root; to enter the earth, as roots.

In deep grounds, the weeds *root* deeper.  *Mortimer.*

2. To be firmly fixed: to be established. The multiplying brood of the ungodly shall not take deep *rooting*.  *Wisdom.*

3. To sink deep.

If any error chanced to cause misapprehensions, he gave them not leave to *root* and fasten by concealment.  *F.H.*

**ROOT**, *v. t.* To plant and fix deep in the earth; used chiefly in the participle; as, *rooted* trees or forests.—2. To plant deeply; to impress deeply and durably. Let the leading truths of the gospel be *rooted* in the mind; let holy affections be well *rooted* in the heart.—3. In *Script.*, to be *rooted* and grounded in Christ, is to be firmly united to him by faith and love, and well established in the belief of his character and doctrine; Eph. iii.

**ROOT**, *v. i.* or *t.* [Sax. *wrot*, a snout or proboscis; *wrotan*, to dig or root; G. *reuten*, Dan. *roder*, Sw. *rota*, to root. This seems to be of the same family as

the former word and *rod*, from the use of the snout.] To turn up the earth with the snout, as swine. Swine *root* to find worms; they *root* the ground wherever they come.—To *root up or out*, to eradicate; to extirpate; to remove or destroy root and branch; to exterminate; Deut. xxix.; Job xxxi.

**ROOT-BOUND**, *a.* Fixed to the earth by roots.

**ROOT-BREAKER**, or **BRUISER**, *n.* In *agriculture*, a machine for breaking or bruising potatoes, turnips, carrots, or other raw roots, into small or moderately sized pieces, before giving them to cattle or horses.

**ROOT-BUILT**, *a.* Built of roots.

**ROOT-EATER**, *n.* An animal that feeds on roots.

**ROOT'ED**, *pp.* Having its roots planted or fixed in the earth; hence, fixed; deep; radical; as, *rooted sorrow*; *rooted aversion*; *rooted prejudices*.

**ROOT'EDLY**, *adv.* Deeply; from the heart.

**ROOTED'NESS**, *n.* The state or condition of being rooted.

**ROOT'ER**, *n.* One that roots; or one that tears up by the roots.

**ROOT-HOUSE**, *n.* A house made of roots.—2. In *agriculture*, a house for storing up, or depositing potatoes, turnips, carrots, cabbages, or other roots, or tops, for the winter feed of cattle.

**ROOT'ING**, *ppr.* Striking or taking root; turning up with the snout.

**ROOT-LEAF**, *n.* A leaf growing immediately from the root.

**ROOT'LET**, *n.* A radicle; a little root.

**ROOT-STOCK**, *n.* In *bot.*, a prostrate rooting thickened stem, which yearly produces young branches or plants. Ginger and orris roots are common instances of it.

**ROOT'Y**, *a.* Full of roots; as, *rooty ground*.

**ROPAL'IC**, *a.* [Gr. *ῥαπῆ*, a club.] Club-formed; increasing or swelling toward the end.

**ROPE**, *n.* [Sax. *rap*; W. *rhap*; Ir. *ropa*, *roibin*.] 1. A large string or cord composed of several strands twisted together; a halter; a cable; a halser or hawser; or it is a combination of fibres of hemp or other material, so arranged as to form a flexible and tenacious cord or band; the fibres retaining as far as possible their collective strength. *Rope* differs from *cord*, *line*, and *string*, only in its size; being the name given to all sorts of cordage above an inch in circumference. Indeed the smaller *ropes*, when used for certain purposes, are called *lines*.—*Ropes* are, by seamen, ranked under two descriptions, *cabl-laid* and *hawser-laid*; the former composed of nine strands, or three great strands, each consisting of three small ones; the latter made with three strands, each composed of a certain number of rope-yarns.—2. A row or string consisting of a number of things united; as, a *rope of onions*.—3. *Ropes*, [Sax. *roppas*,] the intestines of birds.—*Rope of sand*, proverbially, feeble union or tie; a band easily broken.

**ROPE**, *v. i.* To draw out or extend into a filament or thread, by means of any glutinous or adhesive quality. Any glutinous substance will *rope* considerably before it will part.

**ROPE-BAND**. See **ROBBINS**.

**ROPE-DANCER**, *n.* [*rope* and *dancer*.] One that walks on a rope extended.

**ROPE-LADDER**, *n.* A ladder made of ropes.

**ROPE-MAKER**, *n.* One whose occupation is to make ropes or cordage.

**ROPE-MAKING**, *n.* The art or business of manufacturing ropes or cordage, which is performed by means of machines. The first process in rope-making consists in twisting the hemp into thick threads, called *rope yarns*; the next is *warping* the yarns, or stretching them to a given length, in order that they may, when formed into a strand, bear the strain equally. When the rope is to be tarred, that operation is usually performed upon the yarns immediately after their being warped. A suitable number of yarns are next formed into a strand, and three or more such strands are afterwards combined into a rope. The twist of the strand is in an opposite direction to that of the yarns of which it is composed, in order that the tendency to entwine in one part may counteract the like tendency in another.

**ROPER**, *n.* A packer.

**ROPERY**, *n.* A place where ropes are made.—2. A trick that deserves the halter.

**ROPE-TRICK**, *n.* A trick that deserves the halter.

**ROPE-WALK**, *n.* A long covered walk, or a long building over smooth ground, where ropes are manufactured.

**ROPE-YARN**, *n.* Yarn for ropes, consisting of a single thread. The threads are twisted into strands, and the strands into ropes.

**ROPINESS**, *n.* [from *ropy*.] Stringiness, or aptness to draw out in a string or thread without breaking, as of glutinous substances; viscosity; adhesiveness.—2. A frequent disease of wines, which shews itself by a milky or flaky sediment and an oily appearance of the liquor when poured out.

**ROPOROG'RAPHY**, *n.* A kind of Arabesque style of decoration, found in Pompeii, in which slender columns, formed of parts of plants and animals, are the chief characteristic.

**ROPY**, *a.* [from *rope*.] Stringy; adhesive; that may be drawn into a thread; as, a glutinous substance; viscous; tenacious; glutinous; as, *ropy wine*; *ropy lees*.

**ROQUELAURE**, *n.* (rökélöre.) [From the Duke de Roquelaure.] A short cloak



Gentleman wearing a Roquelaure, time of George II.

buttoning up in front, much used in the beginning of last century.

**RO'RAL**, *a.* [L. *roralis*, from *ros*, dew.] Pertaining to dew or consisting of dew; dewy.

**RORATION**, *n.* [L. *roratio*.] A falling of dew.

**RO'RID**, *a.* [L. *roridus*.] Dewy.

**RORIF'EROUS**, *a.* [L. *ros*, dew, and *fero*, to produce.] Generating or producing dew.

**RORIFLUENT**, *† a.* [L. *ros*, dew, and *fluo*, to flow.] Flowing with dew.

**ROR'QUAL**, *n.* [Norwegian *rorqualus*, a whale with folds.] The name of a genus of cetaceous mammals, or whales,



Great Northern Rorqual (*Rorqualus borealis*).

comprising at least three living species, of different dimensions, and, as is supposed, several fossil species.

**RORY**, *† a.* Dewy.

**RO'SA**, *n.* The name of the most universally admired and cultivated genus of plants, forming the type of the natural order Rosaceæ. [See **ROSE**.]

**ROSA'CEÆ**, *n.* A large and important order of plants, of which the rose is the type, distinguished by having several petals; separate carpels; distinct perigynous, numerous stamens; alternate leaves, and an exogenous mode of growth. The species are, for the most part, inhabitants of the cooler parts of the world. They are in some cases trees, in others shrubs, and in a great number of instances, herbaceous perennial plants; scarcely any are annuals. The apple, pear, plum, cherry, peach, nectarine, apricot, and similar valuable fruits, are the produce of the order. Some of the species are also important as medicinal plants; as the root of *Potentilla reptans*, *geum*, *urbanum*, and others, which contain an astringent principle. The genera of this order have been divided into four principal groups or sub-orders, viz., Rosaceæ proper, including the true roses, *potentillas*, *spiræas*, and *neuradas*; Pomææ, including the apple, pear, medlar, quince, service, and mountain ash; Amygdalææ, or the almond tribe; and Sanguisorbææ or Burnet tribe.

**ROSA'CEOUS**, *a.* (as *s. z.*) [L. *rosaceus*. See **ROSE**.] Rose-like; composed of several petals, arranged in a circular form; as, a *rosaceous corol*.

**RO'SARY**, *n.* (as *s. z.*) [L. *rosarium*. See **ROSE**, **ROSEARY**.] 1. A chaplet.—2. A string of beads used by Roman Catholics, on which they count their prayers. There are always in the rosary five or fifteen divisions, each containing ten small beads, and one large one; for each of the small beads an Ave Maria, and for each of the larger, a paternoster is repeated.

**ROSAS'IC**, *a.* The rosasic acid was obtained from the lateritious sediment of the urine which occurs in certain fevers. It is now supposed to be uric acid, modified by animal matter accidentally present.

**ROS'CID**, *† a.* [L. *roscidus*, from *ros*, dew.] Dewy; containing dew, or consisting of dew.

**ROSE**, *n.* (as *s. z.*) [Fr. *rose*; L. *It.* and Sp. *rosa*; G. and Dan. *rose*; Ir. *ros* or *rosa*; W. *rhd̄s*; Gr. *ῥόδον*; from the

root of *red, ruddy, W. rhuz*. See RED.]  
 1. The English name for the well-known and universally cultivated plant and flower of the genus *Rosa*, class and order *Icosandria polygynia*, Linn.; nat. order *Rosaceae*. The rose has been a favourite flower from the remotest antiquity; and is found in almost every country of the northern hemisphere, both in the Old and New World. All the species are included between 70° and 19° north latitude. The species as well as the varieties are numerous, and the former exceedingly difficult to distinguish. Some of the species possess medicinal properties. The fruit of *R. canina*, and other allied species, is astringent; and the petals of *R. gallica* are also astringent, when dried with rapidity. *R. moschata, centifolia*, and *damascena*, yield the attar, essence, or oil of roses. Many other perfumes are made from roses; as rose-water, vinegar of roses, spirit of roses, honey of roses, &c.  
 —2. A knot of ribbon in the form of a rose, used as an ornamental tie of a shoe.—3. In *politics*, a badge of distinction, formerly assumed by the houses of York and Lancaster, the former of whom took the white rose, and the latter the red. On the union of these two houses, the two roses were united into one, which became the royal badge of England.—*Wars of the Roses*, the civil contest between the houses of York and Lancaster, the badge of the former house being a white, of the latter a red rose.—*Under the rose*, in secret; privately; in a manner that forbids disclosure.—*Rose of Jericho*, a cruciferous plant of the genus *Anastatica*, the *A. hierochuntina*, growing in the arid wastes of Arabia and Palestine. It becomes rolled up like a ball in the dry season, and opens its foliage and seed vessels when it comes in contact with moisture.  
 ROSE, } *n.* In *arch.*, a name given,  
 ROSETTE, } to a flower-ornament of frequent use in architectural decorations and in all styles. In Roman architecture roses are used to decorate coffers in ceilings, and in the soffits of cornices. They are used as the central ornament of the abacus of the Corinthian order. In Medieval architecture the varieties of the rose ornament are abundant.—2. Rosette is the name of a red colour used by painters.  
 ROSE, *pret.* of *Rise*.  
 ROSE ACA' CIA, *n.* A highly ornamental flowering shrub of the genus *Robinia* (*R. hispida*), inhabiting the southern parts of the Alleghany mountains, and now frequently seen in gardens in Europe.  
 RO'SEAL, *a.* [*Fr. roseus*.] Like a rose in smell or colour.  
 ROSE-APPLE, *n.* A tree of the genus *Eugenia*, the *E. jambos*, belonging to the nat. order *Myrtaceae*. It is a branching tree, a native of the East Indies. The fruit is about the size of a hen's egg, it is rose-scented, and has the flavour of an apricot.  
 RO'SEATE, *a.* [*Fr. rosat*.] Rosy; full of roses; as, *roseate bowers*.—2. Blooming; of a rose colour; as *roseate beauty*.  
 ROSEBAY, *n.* A plant, the *Nerium oleander*. The dwarf rosebay is a *Rhododendron*.  
 ROSE-BUD, *n.* The bud of a rose, the flower of the rose just appearing.  
 ROSEBUSH, *n.* The rose tree.  
 ROSE-BUG, } *n.* A winged in-  
 ROSE-CHAFFER, } sect, a species of

diurnal beetle, common in the United States, which feeds on rose-petals, &c., and is a great pest in gardens.  
 ROSE-COLOURED, } *a.* Having the  
 ROSE-HUED, } colour of rose.  
 ROSED, } *a.* Crimsoned; flushed.  
 ROSE-DIAMOND, *n.* A diamond nearly hemispherical, cut into twenty-four triangular planes.  
 ROSE-FACED, *a.* Having a rosy or red face.  
 ROSE-GALL, *n.* An excrescence on the dog-rose.  
 ROSE LEAF, *n.* The leaf of a rose.  
 ROSE ENGINE, *n.* In ornamental turning, an appendage to the turning lathe, by which a surface of wood or metal, such as a watch case, is engraved with a variety of curved lines. This mechanism derives its name from the circumstance of the combination of the lines produced by it, presenting some resemblance to a full blown rose.  
 ROSELITE, *n.* [*From M. Rose*.] A native arseniate of cobalt, occurring in small red crystals.  
 ROSE-MALLOW, *n.* A plant of the genus *Althaea*, the *A. rosea*, larger than the common mallow, and commonly called Holyhoek. [*See HOLYHOEK*.]  
 ROSEMARY, *n.* [*L. rosmarinus*, sea-rose; *rosa* and *marinus*. So in *W. rhos-mari*, and in *Ir. bath-ros*, sea-rose.] *Rosmarinus*, a genus of plants belonging to the nat. order *Labiatae*. The *R. officinalis* is a verticillate plant, growing naturally in the southern parts of France, Spain, and Italy, but commonly cultivated in our gardens. It has a fragrant smell, and a warm, pungent, bitterish taste. It yields by distillation a light, pale, essential oil of great fragrance, which is extensively employed in the manufacture of pomatums, for the growth of hair.—*Wild rosemary* is a British plant, the *Andromeda polifolia*.  
 ROSE-NOBLE, *n.* An ancient English gold coin, stamped with the figure of a rose, first struck in the reign of Edward III. and current at 6s. 8d.  
 ROSE'OLA, *n.* [*From L. rosa*, a rose.] In *med.*, a kind of rash, or rose-coloured efflorescence, mostly symptomatic, and occurring in connection with different febrile complaints.  
 ROSE-QUARTZ, *n.* A subspecies of quartz, which is rose red.  
 ROSE-ROOT, *n.* A plant of the genus *Rhodiola*, the *R. rosea*. [*See RHODIOLA*.]  
 RO'SERY, *n.* A place where many roses grow; a nursery of rose-bushes.  
 RO'SET, } *n.* [*Fr. rosette*, from *rose*.] A red colour used by painters.—[*See ROSETTE*.]  
 ROSET'TA STONE, *n.* The name given to a stone in the British museum, originally found by the French near the Rosetta mouth of the Nile. It is a piece of black basalt, and contains part of three distinct inscriptions, the first or highest in hieroglyphics, the second in enchorial characters, and the third in Greek. According to the Greek inscription the stone was erected in the reign of Ptolemy Epiphanes, about 193 years before Christ. The inscriptions however are much mutilated, and they have led to no important discovery.  
 ROSETTE', *n.* (*rozet'*) [*Fr.*] An ornament in the form of a rose. [*See ROSE*.]  
 2. A red colour used by painters.  
 ROSE-TULIP, *n.* A species of tulip, the *Tulipa rosea*.  
 ROSE-WATER, *n.* Water tinctured with roses by distillation.

ROSE-WINDOW, *n.* In *arch.*, a circular window divided into compartments by mullions or tracery radiating or branching from a centre. It is called



Rose Window, west front, Lincoln Cathedral.

also Catherine Wheel and Mary-gold Window.  
 ROSE-WOOD, *n.* The name of a tree, *Amyris balsamifera*, and its wood, nat. order *Leguminosae*, sub. order *Mimoseae*. It is so named because the wood, when fresh, has a faint but agreeable smell of roses. It grows in Brazil, the Canary Islands, Siam, and in other places. The wood is in the highest esteem for the covering or veneering of tables, and other furniture. It is usually cut into veneers of 12 to 15 to an inch. The tree yields an odoriferous balsam, much esteemed as a medicine in various diseases, and as an external application.  
 ROSICRU'CIAN, *n.* [*L. ros*, dew, and *crux*, cross; *dew*, the most powerful dissolvent of gold, according to these fanatics, and *cross*, the emblem of light.] The Rosicrucians were a sect or cabal of hermetical philosophers, or rather fanatics, who sprung up in Germany about A. D. 1500, and made great pretensions to science; and among other things, pretended to be masters of the secret of the philosopher's stone.  
 ROSICRU'CIAN, *a.* Pertaining to the Rosicrucians, or their arts.  
 ROSIER, } *n.* (*ro'zhur*). [*Fr.*] A rose-bush.  
 ROS'IN, *n.* [*Fr. re'sine*. *See RESIN*.] The name given to resin when it is employed in a solid state for ordinary purposes. It is obtained from turpentine by distillation. In the process the oil of the turpentine comes over and the resin remains behind. When the distillation is continued to dryness, the residuum is known by the name of common rosin, or *colophonium*, but when water is mixed with it while yet fluid, and incorporated by violent agitation, the mass is called *yellow rosin*. The uses of rosin are numerous and well known.  
 ROS'IN, *v. t.* To rub or cover over with rosin.  
 ROS'INED, *pp.* Rubbed with rosin.  
 RO'SINESS, *n.* (*s* as *z*). The quality of being rosy, or of resembling the colour of the rose.  
 ROS'INY, *a.* Resembling rosin; abounding with rosin.  
 ROS'LAND, *n.* [*W. rhos*, peat, or a moor.] Heathy land; land full of ling; moorish or watery land.  
 ROSMARI'NE, } *n.* Rosemary.  
 ROSMARI'NUS, } *n.* Rosemary, a genus of plants. [*See ROSEMARY*.]



**ROS'PO**, *n.* A fish of Mexico, perfectly round, and without scales.

**ROSS'EL**, *n.* Light land.

**ROSS'ELLY**, *n.* Loose; light.

**ROS'SET**, *n.* The large Ternate bat.

**ROS'SIGNOL**, *n.* [*Fr. id.*; *It. rosig-nuolo.*] The nightingale.

**ROS'TEL**, or, **ROS'TEL'LUM**, *n.* [*L. rostellum, dim. of rostrum, a beak.*] In *bot.*, an elevated and rather thickened portion of the stigma of Orchidaceous plants, from which the peculiar gland separates, by which the pollen masses of some species of that order are eventually held together.—2. Any small beak-shaped process, as in the stigma of many violets.—3. In *entom.*, the mouth of the louse and other apterous insects.

**ROSTELLARIA**, *n.* A genus of marine univalves, belonging to the family Strombidae. It is found both recent and fossil. The most remarkable species is *R. fissurella*, found in Hampshire and in France.



**ROS'TELLATE**, *a.* Having a rostell.

**ROS'TEL'LIFORM**, *a.* Having the form of a rostell.

**ROS'TER**, *n.* [*A corruption of register.*] In *military affairs*, a plan or table by which the duty of officers is regulated.

**ROS'TRAL**, *a.* [*from L. rostrum, beak.*] 1. Resembling the beak of a ship.—2. Pertaining to the beak.

**ROS'TRAL COLUMN**, *n.* A column dedicated to naval triumphs; it was ornamented with the *rostra* or prows of ships, whence the name.

**ROS'TRATE**, } *a.* [*L. rostratus.*] 1. **ROS'TRATED**, } In *bot.*, beaked; having a process resembling the beak of a bird.—2. Furnished or adorned with beaks; as, *rostrated* galleys.—3. In *conchol.*, applied to shells having a beak-like extension of the shell in which the canal is situated.

**ROS'TRIFORM**, *a.* Having the form of a beak.

**ROS'TRULUM**, *n.* [*L. dimin. of rostrum.*] In *entom.*, the name of the oral instrument of the flea, and other *aphanipterans*.

**ROS'TRUM**, *n.* [*L.*; *W. rhytgyr*, a snout, or *rhytgyr*, a pike.] 1. The beak or bill of a bird.—2. The beak or head of a ship.—3. In *ancient Rome*, a scaffold or elevated place in the forum,

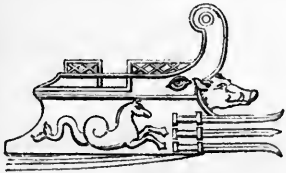

Prow of Ancient Galley armed with the Rostrum.

where orations, pleadings, funeral harangues, &c., were delivered; so called because it was first adorned with the *rostra* of the ships of the first naval victory obtained by the republic.—4. The pipe which conveys the distilling liquor into its receiver, in the common alembic.—5. A crooked pair of scis-

sors, used by surgeons for dilating wounds.—6. A pulpit, in ludicrous language, or any platform or elevated spot from which a speaker addresses his audience.—7. In *bot.*, an elongated receptacle with the styles adhering; also applied generally to any rigid process of remarkable length, or to any additional process at the end of any of the parts of a plant.

**RO'SULATE**, *a.* In *bot.*, having the leaves arranged in little rose-like clusters.

**RO'SY**, *a.* [*from rose.*] Resembling a rose in colour or qualities; blooming; red; blushing; charming.

The *rosy morn* resigns her light. *Waller.*

2. Made in the form of a rose.

**RO'SY-BÜSOMED**, *a.* Embosomed among roses.

**RO'SY-CROSS**, *n.* The red cross; *a cabalistic symbol.*—Knights of the *rosy-cross*, Rosicrucians,—*which see.*

**RO'SY-CROWNED**, *a.* Crowned with roses; roseate hued.

**RO'SY-TINTED**, *a.* Having rose tints.

**ROT**, *v. i.* [*Sax. rotian; D. rotten.*] To lose the natural cohesion and organization of parts, as animal and vegetable substances; to be decomposed and resolved into its original component parts by the natural process, or the gradual operation of heat and air; to putrify.

**ROT**, *v. t.* To make putrid; to cause to be decomposed by the natural operation of air and heat; to bring to corruption.

**ROT**, *n.* A fatal distemper incident to sheep, usually supposed to be owing to wet seasons and moist pastures. According to some, the immediate cause of the mortality of sheep, in this disease, is a great number of small animals, called flukes, (*Fasciola*), found in the liver, and supposed to be produced from eggs swallowed with their food. Others assign as the cause the eating of some particular plants; others the eating of snails and other ingesta; but those most competent to form a correct opinion on the subject, consider that the immediate causes of the disease are a humid state of atmosphere, soil, and product. The disease has different degrees of rapidity, but is always fatal at last; and the treatment of it is seldom successful, unless when early commenced, or when it is of a mild nature.—2. *Putrefaction*; putrid decay.—3. *Dry rot*, in timber, the decay of the wood without the access of water. [*See under Dry.*]

**RO'TA**, *n.* [*L. rota, W. rhod, a wheel; allied to rhedu, to run.*] *See ROTARY.*

1. An ecclesiastical court of Rome, composed of twelve prelates, of whom one must be a German, another a Frenchman, and two Spaniards; the other eight are Italians. This is one of the most august tribunals in Rome, taking cognizance of all suits in the territory of the church by appeal, and of all matters beneficiary and patrimonial.—2. In *English history*, a club of politicians, who, in the time of Charles I., contemplated an equal government by rotation.

**RO'TALITES**, or, **ROTA'LIA**, *n.* A genus of fossil shells, belonging to the order *Foraminifera*.

**RO'TARY**, *a.* [*L. rota, a wheel, W. rhod, Fr. roue, G. and D. rad; Malayan, rata, a chariot; allied to W. rhedu, to run.*] So *car* is allied to *L. curro.*] Turning, as a wheel on its axis; as, *rotary motion.*

**RO'TATE**, *a.* In *bot.*, wheel-shaped, monopetalous, spreading nearly flat, without any tube, or expanding into a nearly flat border, with scarcely any tube; as, a *rotate* corol or calyx.



Rotate corolla.

**RO'TATED**, *a.* [*L. rotatus.*] Turned round, as a wheel.

**RO'TATE-PLANE**, or **ROTA'TO-PLANE**, *a.* In *bot.*, wheel-shaped and flat, without a tube; as, a *rotate-plane* corol.

**RO'TATING**, *ppr.* and *a.* Revolving; moving round a centre.

**ROTA'TION**, *n.* [*L. rotatio, from roto, to turn; rota, a wheel.*] 1. The act of turning; the motion of a solid body, as a wheel or sphere, about an axis, as distinguished from the progressive motion of a body revolving round another body or a distant point. Thus the daily turning of the earth on its axis is a *rotation*; its annual motion round the sun is a *revolution*. The determination of the circumstances of the rotation of a planet about its axis, is an important problem in physical astronomy; and also in relation to practical mechanics, the problem of rotation is of great importance, inasmuch as it comprehends the methods of computing the performance of machines, the forces necessary to overcome their inertia, and the proper relations and most advantageous dispositions of their several parts, in order that the required effect may be produced by the smallest expenditure of power, and the least strain or injury to the machine itself.—*Axes of rotation*, the axis or line about which a revolving body turns.—*Principal axes of rotation*: if a point, which is not the centre of gravity, be taken in a solid body, all the axes which pass through that point (and they may be infinite in number) will have different moments of inertia, and there must exist one in which the moment is a maximum, and another in which it is a minimum. Those axes, in respect of which the moment of inertia is a maximum or minimum, are called the *principal axes of rotation*. In every body, however irregular, there are three principal axes of rotation, at right angles to each other, on any one of which, when the body revolves, the opposite centrifugal forces counterbalance each other, and hence the rotation becomes permanent.—*Centre of rotation*, the point about which a body revolves. It is the same as the centre of motion.—*Centre of spontaneous rotation*, the point about which a body, all whose parts are at liberty to move, and which has been struck in a direction not passing through its centre of gravity, begins to turn. If any force is impressed upon a body or system of bodies, in free space, and not in a direction passing through the centre of gravity of the body or system, a rotatory motion will ensue about an axis passing through the centre of gravity, and the centre about which this motion is performed is called the *centre of spontaneous rotation*.—*Angular velocity of rotation*; when a solid body revolves about an axis, its different particles move with a velocity proportional to their respective distances from the axis; and the velocity of the particle whose distance from the axis is unity, is the *angular*

*velocity of rotation.*—*Rotation in bot.*, is the movement of fluids in the cells of some plants, as *chara* and *vallisneria*. The movements take place in a spiral manner, and are seen under the microscope by means of the small granular bodies which are carried along by the currents.—*Rotation of crops, in agriculture and gardening*, the mode in which different kinds of crops are made to succeed each other in the same field or plot. It is found that the same annual crop cannot be advantageously cultivated on the same soils for more than one or two years, and hence one kind of crop is made to succeed another. But as the number of cultivated crops is limited, when the whole course has been gone through once, it is again repeated; and hence the origin of the word *rotation* as applicable to crops. The same number and kind of crops, however, are not always grown in regular succession, but a change is frequently made according to general principles, and the term used in that case is *succession of crops*. Different soils and climates require different systems of rotation; but it is a recognized rule in all cases, that culmiferous crops ripening their seeds, should not be repeated without the intervention of pulse, roots, herbage, or fallow.—2. Vicissitude of succession; the course by which officers or others leave their places at certain times, and are succeeded by others.

**ROTATIVE**, *a.* Turning, as a wheel; rotary. [*Little used.*]

**ROTATOR**, *n.* [L.] That which gives a circular or rolling motion; a muscle producing a rolling motion, as the muscles of the two apophyses in the upper part of the thigh-bone.

**ROTATORIES**, or **ROTATORIA**, *n.* [L. *rota*, a wheel.] A section of infusorial animals. [*See ROTIFERS.*]

**ROTATORY**, *a.* [from *rotator*.] Turning on an axis, as a wheel; rotary.—2. Going in a circle; following in succession; as, *rotatory assemblies*.—[This word is often used, probably by mistake, for *rotary*. It may be regularly formed from *rotator*, but not with the exact sense in which it is used. With *rotator* for its original, it would signify *causing*, rather than *being* in a circular motion. The true word is *rotary*.]—*Rotatory, or Rotary steam-engine*, an arrangement of mechanism, by which the elastic force of steam is employed to obtain motion round an axis, without the intervention of reciprocating parts. In the majority of cases in which the steam-engine is used as a source of power, it is for the production of motion in the state referred to, and it has been naturally inferred by many, that by simply causing the steam to act directly upon surfaces rigidly connected with the shaft to be set in motion, the most powerful effect would be produced, and in the most economical manner. Numerous plans have been proposed for carrying this into effect, but, however unobjectionable in theory, the practical difficulties to be contended with have hitherto been found to be so great, that no efficient rotatory engine has as yet been invented, which can at all come into competition with the ordinary reciprocating engine.

**ROTE**, *n.* [a contraction of *crowd*, W. *cruth*, Ir. *cruth*.] An old musical instrument, played with a wheel; a sort of hurdy-gurdy.

**ROTE**, *n.* [L. *rota*, a wheel, whence Fr. *routine*.] Properly, a round of words; frequent repetition of words or sounds, without attending to the signification, or to principles and rules; a practice that impresses words in the memory, without an effort of the understanding, and without the aid of rules. Thus children learn to speak by *rote*; they often repeat what they hear, till it becomes familiar to them. So we learn to sing by *rote*, as we hear notes repeated, and soon learn to repeat them ourselves.

**ROTE**, *v. t.* To fix in the memory by means of frequent repetition ourselves, or by hearing the repetition of others, without an effort of the understanding to comprehend what is repeated, and without the aid of rules or principles. [*Little used.*]

**ROTE**, *v. i.* To go out by rotation or succession. [*Little used.*]

**ROTHER**, † *a.* Bovine.

**ROTHER-BEASTS**, † *n.* [Sax. *hryther*, a quadruped.] Cattle of the bovine genus; black cattle.

**ROTHER-NAILS**, *n.* [corrupted from *rudder-nails*.] Among *shipwrights*, nails with very full heads, used for fastening the rudder irons of ships.

**ROTHEROFFITE**, *n.* A variety of garnet, brown, or black, found in Sweden. It has a resemblance to melanite, another variety, but differs from it in having a small portion of alumina.

**ROTIFERS**, or **ROTIFERA**, *n.* [L. *rota*, and *fero*, to carry.] A class of infusorial animals, distinguished by their circles of cilia, sometimes single, sometimes double, which, through the

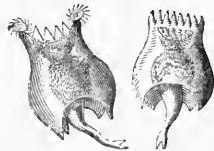

Rotifera.

Wide-mouthed *Brachionus* (*Brachionus patulus*) in two positions.

microscope appear like revolving wheels, whence they have been called *wheel animalcules*.

**ROTTBOEL'LA**, *n.* A genus of grasses, named from Rottböll, a professor in Copenhagen. [*See HARD GRASS.*]

**ROTTED**, *pp.* Made putrid; decomposed wholly or partially.

**ROTTEN**, *a.* (rot'n.) [Sw. *rutten*.] 1. Putrid; carious; decomposed by the natural process of decay; as, a *rotten plank*.

—2. Not firm or trusty; unsound; defective in principle; treacherous; deceitful.—3. Defective in substance; not sound or hard.—4. Fetid; ill smelling.

**ROTTENNESS**, *n.* State of being decayed or putrid; cariousness; putrefaction; unsoundness.

**ROTTEN-STONE**, *n.* A soft stone or mineral, called also Tripoli, or terra Tripolitana, from the country from which it was formerly brought. It is used in all sorts of finer grinding and polishing in the arts, and for cleaning furniture of metallic substances. The rotten-stone of Derbyshire is a Tripoli mixed with calcareous earth.

**ROY'TOLO**, *n.* A weight used in several Moslem countries. It is ordinarily about 5 lbs.

**ROY'TING**, *ppr.* Making putrid; causing to decompose.

**ROTTLE'RA**, *n.* A genus of handsome moderately sized trees, found in the tropical parts of Asia, and throughout India; nat. order Euphorbiaceæ. *R. tetracocca* yields a hard and valuable timber. The capsules of *R. tinctoria* are covered with short stiff hairs, which, when rubbed off, have the appearance of a powder of a fine red colour, which is employed in India in dyeing silk of a scarlet colour.

**ROTUND'**, *a.* [L. *rotundus*, probably formed on *rota*, a wheel, as *jocundus* on *jocus*.] 1. Round; circular; spherical.—2. In *bot.*, circumscribed by one unbroken curve, or without angles; as, a *rotund leaf*.

**ROTUND'A**, *n.* [It. *rotondo*, round.] A round building; any building that is round both on the outside and inside. The most celebrated edifice of this kind is the Pantheon at Rome.

**ROTUNDIFOLI'OUS**, *a.* [L. *rotundus*, round, and *folium*, a leaf.] Having round leaves.

**ROTUNDITY**, *n.* Rotundness; sphericity; circularity; as, the *rotundity* of a globe.

**ROTUNDO OVATE**, *a.* In *bot.*, roundly egg-shaped.

**ROUBLE**. [*See RUBLE.*]

**ROUCOU**, *n.* (roo'coo.) [originally written *Urucu*.] The dried pulp which invests the seeds within the seed vessel of *Bixa orellana*, a shrub eight or ten feet high, growing in South America. A substance used in dyeing; the same as annotta.

**ROUE'**, *n.* (rouè.) Fr. In the *beau monde*, a person devoted to a life of pleasure and sensuality, but not so vitiated in his character and manners as to be excluded from society.

**ROUEN**. [*See ROWEN.*]

**ROUGE**, *a.* (roozh.) Fr. Red.

**ROUGE**, *n.* (roozh.) Red paint; a substance used for painting the cheeks. It is prepared from the dried flowers of the *Carthamus tinctorius*, or safflower. Rouge is the only cosmetic which can be applied without ultimate injury to the complexion.



Carthamus tinctorius.

**ROUGE**, *v. i.* [*supra.*] To paint the face, or rather the cheeks.

**ROUGE**, *v. t.* [*supra.*] To paint, or tinge with red paint. *Rouging* is usually done with a hare's foot. Once common, it is now nearly confined to the stage.

**ROUGED**, *pp.* Tinged with red paint, as the face.

**ROUGE ET NOIR**, *n.* [Fr.] A game at cards, so called from the colours (red and black) marked on the *tapis*, or green cloth on which it is played.

**ROUGH**, *a.* (ruf.) [Sax. *hreoq*, *hreoq*, *hrug*, *reoh*, *rug*, *ruh*, *href*, *hreef*; D. *ruig*, *rough*, *shaggy*, whence our *rug*, *rugged*; G. *rauh*, *rough*, and *rauch*, hoarse, L. *raucus*, It. *rauco*; Sw. *rugg*, entangled hair; *ruggig*, rugged, *shaggy*; Dan. *rog*, *rug*, *rye*; W. *crec* and *crug*, rough, rugged, hoarse, curling, and *crecian*, to creak, to scream, Eng.

*shriek*; *creg*, hoarse, from *cryg*, or the same word varied. *Cryg* is from *rhyg*, Eng. *rye*, that is, rough; [*cruca*, crooked, is probably from the same source;] Sax. *raca*, *hraca*, a cough; L. *ruga*, a wrinkle; W. *rhoçi*, to grunt or growl; *rhuc*, what is rough, irregular, a grunt; *rhugiaw*, to grunt; *rhucw*, a rug, a rough garment, an exterior coat; *rhuc*, a coat, husk, or shell; *rhunc*, a snoring, snorting, or rattling noise. The latter is probably from the same root, from roughness, and this is the Gr. *ῥυχμα*, to snore; Arm. *rochat* or *dirachat*, to snore; *diroch*, snoring. The Welsh unites rough with *creak*, *shriek*; and *shrug* is formed on the root of L. *ruga*, a wrinkle, a ridge. [See RIDGE.] The primary sense is to stretch or strain; but applied to roughness or wrinkling, it is to draw or contract, a straining together.] 1. Rugged; having inequalities, small ridges or points on the surface; not smooth or plane; harsh to the feel; as, a rough board; a rough stone; rough cloth.—2. Stony; abounding with stones and stumps; as, rough land; or simply with stones; as, a rough road.—3. Coarse; unfinished; not wrought or polished; as, rough materials; a rough diamond.—4. Thrown into huge waves; violently agitated; as, a rough sea.—5. Tempestuous; stormy; boisterous; as, rough weather.—6. Austere to the taste; harsh; as, rough wine.—7. Harsh to the ear; grating; jarring; unharmonious; as, rough sounds; rough numbers.—8. Rugged of temper; severe; austere; rude; not mild or courteous.

A fend, a fury, pitiless and rough. *Shak.*

9. Coarse in manners; rude.

A surly boatman, rough as seas and wind.

10. Harsh; violent; not easy; as, a rough remedy.—11. Harsh; severe; uncivil; as rough usage.—12. Hard featured; not delicate; as, a rough visage.—13. Terrible; dreadful.

On the rough edge of battle, ere it join'd,

Satan advanced. *Milton.*

14. Rugged; disordered in appearance; coarse.

Rough from the tossing surge Ulysses moves.

15. Hairy; shaggy; covered with hairs, bristles, and the like.—*Rough arches*, in arch., arches formed of bricks or stones, roughly dressed to the wedge form.

ROUGH, *v. t.* (ruf.) Used in the familiar phrase, to rough it; meaning, to pursue a rough or rugged course; to submit to hardships; to be not over-nice, or too heedful of bodily comforts or conveniences.—*To rough a horse*, to break him in, particularly for military purposes.

ROUGH, *n.* (ruf.) State of being coarse or unfinished; as, materials or work in the rough.—2. Rough weather. [Unusual.]

ROUGH-CAST, *v. t.* (ruf'-cast.) [*rough* and *cast*.] 1. To form in its first rudiments, without revision, correction and polish.—2. To mould without nicety or elegance, or to form with asperities.—3. To cover with a coarse sort of plaster composed of lime and gravel; as, to rough-cast a building.

ROUGH-CAST, *n.* (ruf'-cast.) A rude model; the form of a thing in its first rudiments; unfinished.

ROUGH-CASTING, *n.* (ruf'-casting.)

The act of forming in its first rudiments; the act of covering with a coarse sort of plaster.—*Rough cast*, or rough-casting, a covering for an external wall composed of an almost fluid

mixture of clean gravel and lime, and which is dashed on the wall previously prepared for its reception by a coating of soft plaster, to which the rough-cast adheres.

ROUGH-DRAFT, or ROUGH-DRAUGHT, *n.* (ruf'-draft.) A draught in its rudiments; a draught not perfected; a sketch. *Rough draft* is more generally used.

ROUGH-DRAW, *v. t.* (ruf'-draw.) To draw or delineate coarsely; to trace rudely for first purposes.

ROUGH-DRAWN, *pp.* (ruf'-drawn.) Coarsely drawn.

ROUGHEN, *v. t.* (ruf'-n.) [from *rough*.] To make rough.

ROUGHEN, *v. i.* (ruf'-n.) To grow or become rough.

ROUGH'ENED, *pp.* Made or become rough.

ROUGH'ENING, *ppr.* Making rough.

ROUGH-FOOTED, *a.* (ruf'-footed.) Feather-footed; as, a rough-footed dove.

ROUGH-HEW, *v. t.* (ruf'-hew.) [*rough* and *hew*.] 1. To hew coarsely without smoothing; as, to rough-hew timber.—2. To give the first form or shape to a thing.

There's a divinity that shapes our ends,

Rough-hew them how we will. *Shak.*

ROUGH-HEWN, *pp.* or *a.* (ruf'-hewn.) Hewn coarsely without smoothing.—2. Rugged; unpolished; of coarse manners; rude.

A rough-hewn seaman. *Bacon.*

3. Unpolished; not nicely finished.

ROUGH'ING, *n.* (ruf'-ing.) In arch., a term used to denote plastering of thin coats on naked brick or stone-work.

ROUGHINGS, *n.* (ruf'-ings.) Grass after mowing or reaping. [*Local*.]

ROUGHISH, *a.* (ruf'-ish.) In some degree rough.

ROUGH'-LEAFED, *a.* Having rough leaves.

ROUGHLY, *adv.* (ruf'-ly.) With uneven surface; with asperities on the surface.—2. Harshly; uncivilly; rudely; as, to be treated roughly.—3. Severely; without tenderness; as, to blame too roughly.—4. Austere to the taste.—5. Boisterously; tempestuously.—6. Harshly to the ear.—7. Violently; not gently.

ROUGHNESS, *n.* (ruf'-ness.) Unevenness of surface, occasioned by small prominences; asperity of surface; as, the roughness of a board, of a floor, or of a rock.—2. Austere to the taste; as, the roughness of sloes.—3. Taste of asstringency.—4. Harshness to the ear; as, the roughness of sounds.—5. Ruggedness of temper; harshness; austerity.—6. Coarseness of manners or behaviour; rudeness.

Severity breedeth fear; but roughness breedeth hate. *Bacon.*

7. Want of delicacy or refinement; as, military roughness.—8. Severity; harshness or violence of discipline.—9. Violence of operation in medicines.—10. Unpolished or unfinished state; as, the roughness of a gem or a draught.—11. Inelegance of dress or appearance.—12. Tempestuousness; boisterousness; as of winds or weather.—13. Violent agitation by wind; as, the roughness of the sea in a storm.—14. Coarseness of features.

ROUGH PARSNEP, *n.* (ruf'-parsnep.)

A species of parsnep, the *Pastinaca opopanax*, a native of the South of Europe. [See OPOPANAX.]

ROUGH-RIDER, *n.* (ruf'-rider.) One who breaks horses.

ROUGH-SETTER, *n.* (ruf'-setter.) A mason who builds rough walling, as distinguished from one who hews also. ROUGH-SHOD, *a.* (ruf'-shod.) Shod with shoes armed with points; as, a rough-shod horse.—*To ride rough-shod*, in a figurative sense, is to pursue a course regardless of the pain or distress it may cause others.

ROUGH STRINGS, *n.* (ruf'-strings.) Pieces of undressed timber put under the steps of a wooden stair for their support.

ROUGH STUCCO, *n.* (ruf'-stucco.) In arch., stucco floated and brushed in a small degree with water.

ROUGH,† for *Raught*; pret. of *Reach*.

ROUGH-WORK, *v. t.* (ruf'-work.) [*rough* and *work*.] To work over coarsely, without regard to nicety, smoothness, or finish.

ROUGH-WROUGHT, *a.* (ruf'-raut.) Wrought or done coarsely.

ROULEAU, *n.* (roolo'ú.) [Fr.] A little roll; a roll of guineas in paper.

ROULETTE, *n.* [Fr.] A game of chance, in which a small ball is made to move round rapidly on a circle parted off into red or black spaces, and, as it stops on the one or the other, the player wins or loses.

ROUN,† *v. t.* [G. *raunen*; Sax. *runian*, from *run*, *runa*, mystery; whence *runic*.] To whisper.

ROUN,† *v. t.* To address in a whisper.

ROUNCE, *n.* (rouns') The handle of a printing press.

ROUNCEVAL, *n.* [from Sp. *Roncesvalles*, a town at the foot of the Pyrenees.] A variety of pea, so called.

ROUND, *a.* [Fr. *ron*; It. Sp. and Port. *ron*, a round; G. Dan. and Sw. *rund*; Qu. W. *crwn*, Ir. *crúin*, Arm. *cren*.] 1. Cylindrical; circular; spherical or globular. *Round* is applicable to a cylinder as well as to a globe or sphere. We say, the barrel of a musket is round; a ball is round; a circle is round.—2. Full; large; as, a round sum or price.—3. Full; smooth; flowing; continuous and full in sound; not defective or abrupt.

In his satires, Horace is quick, round, and pleasant. *Peacham.*

His style, though round and comprehensive. *Fell.*

4. Plain; open; candid; fair.

*Round dealing* is the honour of man's nature. *Bacon.*

Let her be round with him. *Shak.*

5. Full; quick; brisk; as, a round trot; a round pace.—6. Full; plump; bold; positive; as, a round assertion.—*To be round in speech*, is to be full or complete in expression, without mincing the meaning.—*Round turn* in marine lan., an epithet applied to the situation of the cables of a ship, which, when moored, has swung the wrong way, so as to cause them to be entangled with one another. The round turn is also the passing of a rope once round a timber-head, &c.—*A round number*, is a number that ends with a cipher, and may be divided by 10 without a remainder; a complete or full number. It is remarkable that the W. *cent*, a hundred, the L. *centum*, and Sax. *hund*, signify properly a circle, and this use of *round* may have originated in a like idea.

ROUND, *n.* A circle; a circular thing, or a circle in motion; a sphere; an orb.

With rounds of waxen tapers on their heads. *Shak.*

Knit your hands, and beat the ground

In a light fantastic round. *Milton.*

4 L

2. Revolution; action or performance in a circle, or passing through a series of hands or things, and coming to the point of beginning; or the time of such action; a carousel; a bumper; a toast. Women to cards may be compared; we play A round or two; when used, we throw away.

Granville.

The feast was served; the bowl was crown'd; To the king's pleasure went the mirthful round.

Prior.

A gentle round fill'd to the brink, To this and t'other friend I drink. *Suckling.* So we say, a round of labours or duties. We run the little round.—3. Rotation in office; succession in vicissitude.—4. A rundle; the little cylindrical step of a ladder.

All the rounds like Jacob's ladder rise.

Dryden.

5. A walk performed by a guard or an officer round the rampart of a garrison, or among sentinels, to see that the sentinels are faithful, and all things safe. Hence the officer and men who perform this duty are called the rounds.—6. A short vocal composition in three or more parts, in performing which the first voice begins alone, singing to the end of the first part, then passes on to the second, third, &c. parts, the other voices following successively the same routine, till all are joined together, the round ending at the mark of a pause; or at a signal agreed on.—7. A general discharge of fire-arms by a body of troops, in which each soldier fires once. In volleys, it is usual for a company or regiment to fire three rounds.—8. That which goes round a whole circle or company; as, a round of applause, or of toasts.

To ladies' eyes a round, boys. Moore.

9. In the manege, a volt or circular tread.—A round of cartridges and balls, one cartridge to each man; as, to supply a regiment with a single round or with twelve rounds of cartridges.—A round of beef, a cut of the thigh through and across the bone.

ROUND, *adv.* On all sides. Thine enemies shall cast a trench about thee, and compass thee round; Luke xix. 2. Circularly; in a circular form; as, a wheel turns round.—3. From one side or party to another; as, to come or turn round. Hence these expressions signify to change sides or opinions.—4. Not in a direct line; by a course longer than the direct course. The shortest course is not the best; let us go round.—All round, in common speech, denotes over the whole place, or in every direction.—Roundabout is tautological.

ROUND, *prep.* On every side of; as, the people stood round him; the sun sheds light round the earth. In this sense, around is much used, and all is often used to modify the word. They stood all round or around him.—2. About; in a circular course, or in all parts; as, to go round the city. He led his guest round his fields and garden. He wanders round the world.—3. Circularly; about; as, to wind a cable round the windlass.—To come or get round one, in popular lan., is to gain advantage over one by flattery or deception; to circumvent.

ROUND, *v. t.* To make circular, spherical, or cylindrical; as, to round a silver coin; to round the edges of any thing. Worms with many feet, that round themselves into balls, are bred chiefly under logs of timber.

Bacon.

2. To surround; to encircle; to encompass.

Th' inclusive verge

Of golden metal that must round my brow.

Shak.

Our little life is rounded with a sleep. *Shak.* 3. To form to the arch or figure of the section of a circle.

The figures on our modern medals are raised and rounded to very great perfection.

Addison.

4. To move about any thing; as, the sun, in polar regions, rounds the horizon.—5. To make full, smooth, and flowing; as, to round periods in writing.

—To round in, among seamen, to pull upon a slack rope, which passes through one or more blocks in a direction nearly horizontal.—To round up, to haul up; usually, to haul up the slack of a rope through its leading block, or to haul up a tackle which hangs loose by its fall.—To round a horse, to make him go upon sorts of rounds; thus "to round a horse upon a trot, gallop," &c. is to make him carry his shoulders and haunches compactly or roundly, upon a greater or smaller circle, without traversing or bearing to a side.

ROUND, *v. i.* To grow or become round. The queen your mother, rounds apace.

Shak.

2. To go round, as a guard. They nightly rounding walk. *Milton.*

To round to, in sailing, is to turn the head of the ship toward the wind.

ROUND, *† v. i.* [Sax. *runian*; G. *raumen*.] To whisper; as, to round in the ear.

ROUND'ABOUT, *a.* [round and about.] Indirect; going round; loose.

Paraphrase is a roundabout way of translating. *Felton.*

2. Ample; extensive; as, roundabout sense.—2. Encircling; encompassing. [In any sense, this word is inelegant.]

ROUND'ABOUT, *n.* A large strait coat; a sort of surtout.—2. A horizontal wheel on which children ride. In the *U. States*, a short close body garment without skirts.

ROUND'BACKED, } *a.* Having  
ROUND'SHOULDERED, } a round  
back or shoulders.

ROUND'EL, } *n.* [Fr. *rondelet*, from  
ROUND'ELAY, } *rondelet*, round.] 1. A

ROUND'O, } sort of ancient  
poem, consisting of thirteen verses, of  
which eight are in one kind of rhyme,  
and five in another. It is divided into  
couplets; at the end of the second and  
third of which, the beginning of the  
poem is repeated, and that, if possible,  
in an equivocal or punning sense.—  
*Roundelay*, also signifies a song or tune  
in which the first strain is repeated, and  
a kind of dance.—2. *†* [Fr. *ronnelle*,  
a little shield.] A round form or figure.

—3. *Roundel*, in *her.*, is an ordinary

in the form of a circle. It is improper to say a roundel orgule, &c. describing it by its tincture; unless, first, in case of counterchanges; secondly, where the roundel is of fur, or of equal tinctures, as a roundel ermine, a roundel chequy, of, or, and azure; otherwise, roundels have distinguishing names, according to their tinctures, as *bezants*, plates, *pomeis*, *hurts*, *torteaux*, *golpes*, *pellets*, *oranges*, and *guzes*.

ROUND'EL, *n.* [Fr. *ronnelle*.] 1. In



Three Roundels counter-changed.

631

ancient armour, a round shield made of osiers, wood, sinews, or ropes covered with leather, plates of metal, or stuck full of nails in concentric circles or other figures; sometimes made wholly of metal, and mostly convex, but some-

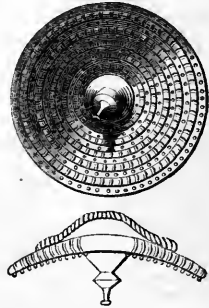

An ancient concave Roundel, front and edge view.

times concave, and both with and without the umbo or boss.—2. A round guard for the armpit.—3. The guard of a lance.

ROUND'ER, *† n.* [See *RONDURE*.] Circumference; inclosure.

ROUND'HAND, *n.* A style of penmanship in which the letters are round and full.

ROUND'HEAD, *n.* [round and head.] A name formerly given to a puritan, from the practice which prevailed among the puritans of cropping the hair close round. Subsequently it came to mean a republican of the Commonwealth. During the time of Charles I. and of the Commonwealth, the name roundhead was extended, as a political name, to all the republicans, by the royalists, or cavaliers; the latter generally wearing their hair long, as a distinction.

ROUND'HEADED, *a.* Having a round head or top.

ROUND'HOUSE, *n.* A constable's prison; the prison to secure persons taken up by the night-watch, till they can be examined by a magistrate, so called from its former usual shape; but now more generally called *watchhouse* in London, and *cage* in country places.

—2. In a *ship of war*, a certain necessary near the head, for the use of particular officers.—3. In *large merchantmen* and *ships of war*, a cabin or apartment in the after part of the quarter-deck, having the poop for its roof; sometimes called the coach. It is the master's lodging room.

ROUND'ING, *ppr.* Making round or circular.—2. Making full, flowing, and smooth.

ROUND'ING, *a.* Round or roundish; nearly round.

ROUND'ING, *n.* Among *seamen*, small rope or spun-yarn wound about a larger rope to prevent its chafing; also called *service*.—*Rounding in*, a pulling upon a slack rope, which passes through one or more blocks in a direction nearly horizontal.—*Rounding up*, is a pulling in like manner, when a tackle hangs in a perpendicular direction.

ROUND'ISH, *a.* Somewhat round; nearly round; as, a roundish seed; a roundish figure.

ROUND'ISHNESS, *n.* The state of being roundish.

**ROUND'LET**, *n.* A little circle.  
**ROUND'LY**, *adv.* In a round form or manner.—2. Openly; boldly; without reserve; peremptorily.

He affirms every thing *roundly*. *Addison*.  
 3. Plainly; fully. He gives them *roundly* to understand that their duty is submission.—4. Briskly; with speed.

When the mind has brought itself to attention, it will be able to cope with difficulties and master them, and then it may go on *roundly*. *Locke*.

5. Completely; to the purpose; vigorously; in earnest.

**ROUND'NESS**, *n.* The quality of being round, circular, spherical, globular, or cylindrical; circularity; sphericity; cylindrical form; rotundity; as, the *roundness* of the globe, of the orb of the sun, of a ball, of a bowl, &c.—2. Fullness; smoothness—3. Openness; the *roundness* of a period.—4. Openness; plainness; boldness; positiveness; as, the *roundness* of an assertion.

**ROUND'RIDGE**, *v. t.* [*roundridge*.] In *tillage*, to form round ridges, by ploughing.

**ROUND'ROBIN**, *n.* [*Fr. rond and ruban*.] A written petition, memorial, or remonstrance signed by names in a ring or circle. The phrase is originally derived from a custom of the French officers, who, in signing a remonstrance to their superiors, wrote their names in a circular form so that it might be impossible to ascertain who had headed the list. It is now used to signify an act by which a certain number of individuals bind themselves to pursue a certain line of conduct.

**ROUNDS**, *n. plur.* [*See ROUND, n., No. 5.*] 2. Round-top. [*See TOF.*]

**ROUND-TABLE**. The knights of the Round Table were a famous order of knights that existed in England under the reign of King Arthur, by whom the order was founded. The members are said to have been forty in number, and to have derived their name from a huge round marble table, round which they were accustomed to sit.

**ROUND-TOWER**, *n.* A cylindrical tower with a conical top, of great antiquity, such as is often met with in Ireland, and occasionally in Scotland and



Round Tower on Downish Island.

elsewhere. The *round-towers* are from thirty to a hundred and thirty feet in height, and from twenty to thirty feet in diameter. There has been much

speculation as to the purpose for which these towers were built; but on this point antiquaries are by no means agreed.

**ROUP**, *n.* [*Tent. roepen*, to cry out.] An outcry; a sale of goods by auction.—*Articles of roup*, the conditions under which property is exposed to sale by auction. [*Scotch.*]

**ROUP**, *n.* [*Iceland. hroop.*] Hoarseness. [*Scotch.*]

**ROUP**, *v. i.* [*Tent. roepen*; *Suio-Goth. ropa*; *Sax. hreopan*.] To cry; to shout. As a verb active, to expose to sale by auction. [*Scotch.*]

**ROUPEY**, or **ROOPTY**, *a.* Hoarse. [*Scotch.*]

**ROUSANT**, *ppr.* In *her.*, a term applied to a bird in the attitude of rising, as if preparing to take flight. When applied to a swan, it is understood that the wings are endorsed.



Swan Rousant.

**ROUSE**, *v. t.* (*rouz*). [*This word, written also arouse*, seems

to belong to the family of *raise* or *rush*. *See RAISE*. In *Sax. hrysan*, to shake and to rush; *Goth. hrysan*, to shake.]

1. To wake from sleep or repose; *Gen. xlix.*—2. To excite to thought or action from a state of idleness, languor, stupidity, or inattention.—3. To put into action; to agitate.

Blustering winds that *roused* the sea.

*Milton.*

4. To drive a beast from his den or place of rest.

**ROUSE**, *v. i.* To awake from sleep or repose.

Morpheus *rouses* from his bed. *Pope.*

2. To be excited to thought or action from a state of indolence, sluggishness, languor, or inattention.

**ROUSE**, *v. i.* In *seamen's lan.*, to pull together upon a cable, &c. without the assistance of tackles or other mechanical power.

**ROUSE**, *† n.* (*rouz*). [*D. roes*, a bumper; *G. rausch*, drunkenness; *rauschen*, to rush, to rustle.] A full glass of liquor; a bumper in honour of a health.

**ROUS'ED**, *pp.* Awakened from sleep; excited to thought or action.

**ROUS'ER**, *n.* One that rouses or excites.

**ROUS'ING**, *ppr.* Awaking from sleep; exciting; calling into action.—2. *a.* Having power to awaken or excite.—3. Great; violent; as, a *rousing* fire.

[*Vulgar.*] In *her.*, *rousing* or *rousing* is the term used for putting up and driving the hart from its resting place.  
**ROUS'INGLY**, *adv.* Violently; excitingly.

**ROUST**, *n.* A torrent occasioned by a tide.

**ROUT**, *n.* [*G. rotte*, *Dan. rode*, a set, gang, rabble; *G. rotten*, to combine together, to plot; *D. rotten*, to assemble, and to rot; *W. rhavter*, a crowd; *Fr. ruta*, a herd. *Qu.* from the root of *crowd*, or from breaking, bursting, noise.] 1. A rabble or multitude; a clamorous multitude; a tumultuous crowd; as, a *route* of people assembled.

The endless *routes* of wretched thralls.

*Spenser.*

2. In *law*, a *route* is where three persons or more meet to do an unlawful act upon a common quarrel, as forcibly to break down fences on a right claimed

of common or of way, and make some advances toward it.—3. A select company; a party for gaming.—4. In *modern acceptation*, a fashionable assembly or large evening party.

**ROUT**, *n.* [*Fr. déroute*; *It. rotta*, a breaking, a defeat, a rout; *rotto*, broken, defeated; *rottura*, a rupture. This is a corruption of the *L. ruptus*, from *rumpo*, to break.] The breaking or defeat of an army or band of troops, or the disorder and confusion of troops thus defeated and put to flight.—*To put to the rout*, to break the ranks of an army and put them into disorder and to flight.

**ROUT**, *v. t.* To break the ranks of troops and put them to flight in disorder; to defeat and throw into confusion.

The king's horse.. *routed* and defeated the whole army. *Clarendon*.

**ROUT**, *† v. i.* To assemble in a clamorous and tumultuous crowd.

**ROUT**, *† v. i.* [*Sax. hrutan*.] To snore.  
**ROUT**, *† v. t.* [*For ROOT.*] To turn up the ground with the snout (as hogs); to search.

**ROUT**, } *v. i.* To roar; to bellow, as  
**ROWTE**, } cattle do. [*Scotch.*]

**ROUTE**, *n.* (*root*). [*Fr. route*; *W. rhawd*, a rout or way; *rhodiaw*, to walk about; *Eng. road*. *See ROAD*. It belongs to the family of *rude* and *L. gradior*; properly a going or passing.] The course or way which is travelled or passed, or to be passed; a passing; a course; a march. Wide through the furzy field their *route* they take. *Gay*.

[*Route* and *road* are not synonymous. We say, to mend or repair a *road*, but not to mend a *route*. We use *route* for a course of passing, and not without reference to the passing of some person or body of men.]—2. In *geography*, a principal or leading road.

**ROUT'ED**, *pp.* or *a.* Put to flight in disorder.

**ROUT'ER GAUGE**, *n.* A gauge used for cutting out the narrow channels intended to receive brass or coloured woods in inlaid work. It is formed like the common marking gauge, but provided with a narrow chisel as a cutter in place of the marking point.

**ROUT'ER PLANE**, *n.* A kind of plane used for working out the bottoms of rectangular cavities. The sole of the plane is broad, and carries a narrow cutter which projects from it as far as the intended depth of the cavity. This plane is vulgarly called the *old woman's tooth*.

**ROUTH**, } *n.* Plenty; abundance.  
**ROWTH**, }

[*Scotch.*]  
**ROUTH'IE**, *a.* Plentiful. [*Scotch.*]

**ROUTINE**, *n.* (*rooten*). [*Fr. from L. rota*, a wheel.] 1. A round of business, amusements, or pleasure, daily or frequently pursued; particularly, a course of business or official duties, regularly or frequently returning.—2. Any regular habit or practice not accommodated to circumstances.

**ROUTING**, *ppr.* Putting to flight; defeating and throwing into confusion.

**ROUT'OUSLY**, *adv.* With that violation of law called a *rout*.

**ROVE**, *v. i.* [*Dan. röver*, to rob; *Sw. råfva*. This corresponds with the *Sax. reufjan* and *L. rapio*, *Fr. ravir*. In *Sw. ströfva*, to rove or wander, appears to be formed on this root. In *D. rooven*, *G. rauben*, signify to rob.] To wander; to ramble; to range; to go, move, or pass without certain direction

in any manner, by walking, riding, flying or otherwise.

**ROVE** v. t. To wander over; as, *roving* a field; *roving* the town. This is an elliptical form of expression, for *roving over, through, or about* the town.

**ROVE**, v. t. [Qu. *reeve*.] To draw a thread, string, or cord through an eye or aperture.

**RÖVE**, n. A roll of wool drawn out and slightly twisted; a slub.

**ROVER**, n. A wanderer; one who rambles about.—2. A fickle or inconstant person.—3. A robber or pirate; a freebooter. [So *corsair* is from *L. cursus, curro*, to run.]—4. † A sort of a race.—At *rovers*, without any particular aim; at random; as, shooting at *rovers*.

**RÖVING**, *ppr*. Rambling; wandering; passing a cord through an eye.

**ROVING**, n. The operation which gives the first twist to cotton thread by drawing it through an eye or aperture.

**ROVINGLY**, *adv*. In a wandering manner.

**ROVINGNESS**, n. State of roving.

**RÖW**, n. [Sax. *rava*; G. *rethe*. The Welsh has *rhes*. It is a contracted word, and probably the elements are *Rg*; the same as of *rank*. The primary sense is probably to stretch, to reach. Sw. *rad*, a row.] A series of persons or things arranged in a continued line; a line; a rank; a file; as, a *row* of trees; a *row* of gems or pearls; a *row* of houses or columns.

Where the bright seraphim in burning row.

Milton.

*Row culture*, in agriculture, that method in which the crops are sown in drills, and afterwards cultivated in accordance with the system.

**RÖW**, v. t. [Sax. *rowan*, *reowan*; D. *roeyen*; the latter signifies to row and to gauge; G. *ruder*, an oar; *rudern*, to row; Sax. *rother*, an oar; Gr. *ῥοῦω*, *ῥοῦω*, to row; *ῥοῦω*, an oar. If the noun is the primary word, *ruder* and *rother*, an oar, may be from the root of *rod*, *L. radius*, or from the root of *rado*, to rub, grate, sweep. If the verb is the primary word, the sense is to sweep, to urge, drive, impel. See **RUDER**.] 1. To impel, as a boat or vessel along the surface of water by oars; as, to *row* a boat.—2. To transport by rowing; as, to *row* the captain ashore in his barge.

**RÖW**, v. i. To labour with the oar; as, to *row* well; to *row* with oars muffled.

**ROW**, n. A riotous noise; a *riot*. [A low word.]

**RÖWABLE**, † a. Capable of being rowed or rowed upon.

**ROWAN-TREE**. See **ROAN TREE**.

**ROWAN'AH**, n. In the *East Indies*, a permit or passport.

**RÖW'DY**, n. A riotous turbulent fellow. [An American trivial word.]

**RÖWED**, *pp*. Driven by oars.

**RÖWEL**, n. Old Fr. *rouelle*; G. *rüdel*; Sp. *rodaja*, a small wheel, a rowel; *rueda*, a wheel, *L. rota*, *W. rhod*. The French *rouelle* is a diminutive of *roue*, contracted from *rota*.] 1. The little wheel of a spur, formed with sharp points.—2. Among *farrriers*, a roll of hair or silk, passed through the flesh on horses, answering to a seton in surgery.—3. A little flat ring or wheel of plate or iron on horses' bits.

**RÖWEL**, v. t. To insert a rowel in; to

pierce the skin and insert a roll of hair or silk.

**RÖWELED**, *pp*. Pierced with a rowel. **RÖWELING**, *ppr*. Inserting a roll of hair or silk; piercing the skin to make a rowel.

**RÖW'EN** or **RÖU'EN**, n. [Said to be a corruption of *roughings*, but Qu. Heb. *רָעַן*, *raan*, to be green, to thrive.] The aftermath; the lattermath, or second crop of hay cut off the same ground in one year.

Turn your cows that give milk into your *rowens* till snow comes. *Mortimer*.

**RÖWER**, n. One that rows or manages an oar in rowing.

**RÖWING**, *ppr*. Impelling, as a boat by oars.

**RÖWLAND**. To give a Rowland (or Roland) for an Oliver, is to give a full retaliator, equivalent, a retort, a blow, &c., of at least equal force. [Trivial.]

**RÖWLEY-RAGG**. See **RAGG**.

**RÖW-LOCK**, n. That part of a boat's gunwale on which the oar rests in rowing.

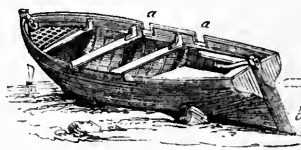

Ship's boat. a a Rowlocks.

**RÖW-PÖRT**, n. A little square hole in the side of small vessels of war, near the surface of the water, for the use of an oar for rowing in a calm.

**RÖYAL**, a. [Fr. *royal*; It. *reale*; Sp. and Port. *real*; contracted from *L. regalis*, from *rex*, king. See **RIK** and **RIGHT**.] 1. Kingly; pertaining to a king; regal; as, *royal* power or prerogative; a *royal* garden; *royal* domains; the *royal* family.—2. Becoming a king; magnificent; as, *royal* state.—3. Noble; illustrious.

How doth that *royal* merchant, good Antonio? *Shak*.

*Royal antler*, the third branch of the horn of a hart or buck, which shoots out from the rear, or main horn above

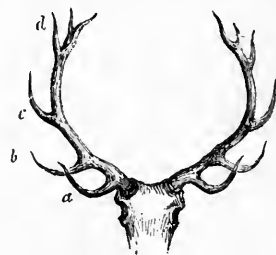

Antlers.

a, Brow antler. c, Royal antler.  
b, Bezantler. d, Surroyal or Crown antler.

the bezantler.—*Royal boroughs*, incorporations created by royal charter, in distinction from those which are held of a subject, and which are called *boroughs of barony*. [See **BOROUGH**, **BURGH**.]—*Royal Society*, London, a society incorporated by Charles II.,

under the name of "The President, Council, and Fellows of the Royal Society, for the improvement of Natural Philosophy."—*Royal Institution*, London; a corporation erected in the year 1800, the great object of which is to render science applicable to the comforts and conveniences of life.—*Royal Academy of London*, a corporation instituted by George III., for the advancement of drawing, painting, engraving, sculpture, modelling, and architecture.—*Royal Society of Edinburgh*, a society incorporated by royal charter in 1783. Its object is to advance the sciences and arts in Scotland.—*Royal oak*, in *astr.*, *Robur Carolinum*, a constellation formed by Halley in the southern hemisphere, containing twelve stars.—*Royal parapet*, a breast-work in a fortification raised on the edge of a rampart towards the country.—*Royal assent*. [See **ASSENT**.]

**RÖY'AL**, n. A large kind of paper. It is used as a noun or an adjective.—2. Among *seamen*, a small sail spread immediately above the top-gallant-sail; sometimes termed the top-gallant-royal.—3. One of the shoots of a stag's head.—4. In *artillery*, a small mortar.—5. One of the soldiers of the first regiment of foot, called the *royals*, and supposed to be the oldest regular corps in Europe.

**RÖYAL BAY**, n. The *Laurus indica*, a tree which grows in the Canary Islands and in Virginia. The wood is of a yellow colour, and is used for buildings and for furniture.

**RÖYALISM**, n. Attachment to the principles or cause of royalty, or to a royal government.

**RÖYALIST**, n. An adherent to a king, or one attached to a kingly government.

Where Candish fought, the *royalists* prevailed. *Waller*.

**RÖYALIZE**, v. t. To make royal.

**RÖYALIZED**, *pp*. Made royal.

**RÖYALLY**, *adv*. In a kingly manner; like a king; as becomes a king.

His body shall be *royally* interr'd. *Dryden*.

**RÖYALTY**, n. [Fr. *royauté*; It. *realtà*.]

1. Kingship; the character, state, or office of a king; the condition or *status* of a person of royal rank, such as a king or queen, or reigning prince or duke, or any of their kindred.

*Royalty* by birth was the sweetest way of majesty *Holyday*.

2. *Royalties*, plur. emblems of royalty; regalia.—3. Rights of a king; prerogative.—4. A manor of which the king is the lord.—5. In *Scotland*, the bounds of a royal burgh.

**RÖYNE**, † v. t. [Fr. *rogner*.] To bite; to gnaw.

**RÖYNISH**, † a. [Fr. *rogneur*, mangy.] Mean; paltry; as, the *roynish* clown.

**RÖYSTON CROW**, n. The common English name for the hooded crow, the *corvus cornix*, Linn.

**RÖYTELET**, † n. [Fr. *routelet*, from *roi*, king.] A little king.

**RÖYTISH**, † a. Wild; irregular.

**RUB**, v. t. [W. *rwubiau*; G. *reiben*, to rub, to grate, also to upbraid; *reibe*, a grater. Qu. *L. probrum, exprobro*; Gr. *ῥεῖβω*, to rub. We have the elements of the word in *scrape*, *scrub*, *L. scribo*, Gr. *ῥεῖβω*.] 1. To move something along the surface of a body with pressure; as, to *rub* the face or arms with the hand; to *rub* the body with flannel. Vessels are scoured or cleaned by *rubbing* them.—2. To wipe; to clean; to scour; but *rub* is a generic term, ap-

pliable to friction for every purpose.—3. To touch so as to leave behind something which touches; to spread over; as, to *rub* any thing with oil.—4. To polish; to retouch; with *over*.

The whole business of our redemption is to *rub over* the defaced copy of the creation.

*South.*

5. To obstruct by collision. [*Unusual.*]

—6. To touch hard. In popular language, *rub* is used for teasing, fretting, upbraiding, reproaching, or vexing; with gibes or sarcasms.—*To rub down*, to clean by rubbing; to comb or curry, as a horse.—*To rub off*, to clean any thing by rubbing; to separate by friction; as, to *rub off* rust.—*To rub out*, to erase; to obliterate; as, to *rub out* marks or letters.—*To remove or separate* by friction; as, to *rub out* a stain.—*To rub upon*, to touch hard.—*To rub up*, to burnish; to polish; to clean.—*To excite*; to awaken; to rouse to action; as, to *rub up* the memory.

RUB, *v. i.* To move along the surface of a body with pressure; as, a wheel *rub*s against the gate-post.—2. To fret; to chafe; to make a friction; as, to *rub* upon a sore.—3. To move or pass with difficulty; as, to *rub* through woods, as huntsmen; to *rub* through the world.

RUB, *n.* The act of rubbing; friction.—2. That which renders motion or progress difficult; collision; hindrance; obstruction.

Now every *rub* is smoothed in our way.

*Shak.*  
Upon this *rub* the English ambassadors thought fit to demur.

*Hayward.*  
All sort of *rub*s will be laid in the way.

*Davenant.*  
3. In breaking inequality of ground that hinders the motion of a bowl.—4. Difficulty; cause of uneasiness; pinch. To sleep, perchance to dream; ay, there's the *rub*.

5. Sarcasm; joke; something grating to the feelings.

RUB, } *n.* [*rub* and *stone.*] A  
RUB'-STONE, } stone, usually some kind of sandstone, used to sharpen instruments; a whetstone.

RUB'AGE, } for *Rubbish*, vulgar,  
RUB'BIDGE, } and not used.  
RUB'BLE, }

RUB'BED, *pp.* Moved along the surface with a pressure; cleaned; polished.—*Rubbed returns*, and *rubbed headers and stretchers*, in *bricklaying*, names given to headers and stretchers, in return, which are not axed.

RUB'BED WORK, *n.* Stones of which the faces have been rubbed with grit, until all traces of the mason's tool are obliterated. In Scotland it is termed polished work.

RUB'BER, *n.* One that rubs.—2. The instrument or thing used in rubbing or cleaning.—3. A coarse file, or the rough part of it.—4. A whetstone; a rubstone.—5. At whist, and some other games, two games out of three; or the game that decides the contest; or a contest consisting of three games.—*India rubber*, caoutchouc, a substance produced from the *Siphonia elastica*; a substance remarkably pliable and elastic.

RUB'BERS, *n.* A disease in sheep, occasioning great heat and itching.

RUB'BING, *ppr.* Moving along the surface with a pressure; chafing; scouring; polishing.—*Rubbing-stone*, in *bricklaying*, a cylindrical stone, on which the bricks for the gauged work,

after they have been rough-shaped by the axe, are rubbed smooth.

RUB'BING-POST. In *husbandry*, a post set up for cattle to rub themselves on.

RUB'BISH, *n.* [from *rub*; properly, that which is rubbed off; but not now used in this limited sense.] 1. Fragments; refuse fragments of building materials; broken or imperfect pieces of any structure; ruins.

He saw the towns one half in *rubbish* lie.

2. Waste or rejected matter; any thing vile or worthless.—3. Mingled mass; confusion.—4. † Offscourings; refuse.

RUB'BLE, *n.* Stones of irregular shapes and dimensions.

RUB'BLE WORK, or RUB'BLE WALLING, *n.* Walls built of rubble stones. Rubble walls are either coursed or uncoursed; in the former, the stones are roughly dressed and laid in courses, but without regard to equality in the height of the courses; in the latter, the stones are used as they occur, the interstices between the larger stones being filled in with smaller pieces.

RUBEFA'CIENT, *n.* [*L. rubeo*, *infra.*] Making red.

RUBEFA'CIENT, *n.* In *med.*, a substance or external application which produces redness of the skin; not followed by blister.

RUB'ELLITE, *n.* [from *L. rubeus*, *red.*] A silicious mineral of a red colour, of various shades; the red shorl; siberite. It occurs in accumulated groups of a middle or large size, with straight tubular-like striae. In a red heat, it becomes snow-white and seems to phosphoresce. Rubellite is red tourmaline.

RUBE'OLA, *n.* In *med.*, the measles,—*which see.*

RUBES'CENT, *a.* [*L. rubescens*, *rubeo*, from *rubeo*, to redder or to be red.] Growing or becoming red; tending to a red colour.

RÜ'BEZÄHL, *n.* [Ger. *rübe*, turnip, and *zahl*, number.] Numbernip, a famous mountain spirit of Germany, sometimes friendly, sometimes mischievous; a familiar imp, corresponding to our Puck.

RUB'IA, *n.* A genus of plants found both in Europe and Asia, belonging to the nat. order *Stellatae*, or *Galiaceae*, so named from the Latin word *ruber*, red, in allusion to the red colour yielded by many of the species. Several species are employed in medicine, and also in the arts, for the sake of the colouring matter which is contained in the roots.—*R. tinctorum* is the well-known madder. [See *Madder*.]—*R. cordifolia* is the munjeet of India. [See *Munjeet*.]

RUB'ICAN, *a.* [Fr. from *L. rubeo*, to be red.] Rubican colour of a horse, is a bay, sorrel, or black, with a light gray or white upon the flanks, but the gray or white not predominant there. According to the French definition, *rubican* signifies red, predominating over gray in the colour of a horse.

RUB'ICEL, or RUB'ICELLE, *n.* [*L. rubeo*, to be red.] A gem or mineral, a variety of ruby of a reddish colour, from Brazil.

RUB'ICON, *n.* A small river which separated Italy from Cisalpine Gaul, the province allotted to Cæsar. When Cæsar crossed that stream, he invaded Italy, with the intention of reducing it to his power. Hence the phrase to *pass the Rubicon*, signifies to take a desperate step in an enterprise, or to adopt a measure from which one can-

not recede, or from which he is determined not to recede.

RUB'ICUND, *a.* [*L. rubicundus.*] Inclining to redness.

RUBICUN'DITY, *n.* The state of being red; redness.

RUB'IED, *a.* Red as a ruby; as, a *rubied* lip; *rubied* nectar.

RUBIF'IC, *a.* [*L. ruber* and *facio.*] Making red; as, *rubific* rays.

RUBIFICA'TION, *n.* The act of making red.

RUBIFORM, *a.* [*L. ruber*, *red*, and *form.*] Having the form of red; as, the *rubiform* rays of the sun are at least refrangible.

RUBIFY, *v. t.* [*L. ruber*, *red*, and *facio*, to make.] To make red. [*Little used.*]

RUBIG'INOUS, *a.* Rusty.

RUB'IGO, *n.* [*L.*] Mildew, a kind of rust on plants, consisting of a parasitic fungus or mushroom.

RUBINIC ACID, *n.* According to Svanberg, when catechine is exposed to the air in contact with carbonated alkalies, it forms red solutions, which contain a new acid termed *rubinic* acid. It has not yet been obtained in a separate form.

RUB'IOUS, † *a.* [*L. rubeus.*] Red; ruddy.

RUB'LE, or ROUBLE, *n.* (roo'bl.) [Russ. from *rublyu*, to cut.] A silver coin of Russia, the value of about three shillings and fourpence sterling. There are also paper *rubles*, of about one-fourth the value of the silver ruble.

RUB'RIC, *n.* [Fr. *rubrique*; *L. It.* and *Sp. rubrica*; from *L. rubeo*, to be red.] 1. A title or article in certain ancient law books; so called because written in red letters.—2. Directions printed in prayer books, formerly done in red.

The *rubric* and the rules relating to the liturgy are established by royal authority, as well as the liturgy itself. *Nelson.*

3. In *Scots law*, the *rubric* of a statute is its title, which is so termed because anciently it was written in red letters. The name has sometimes been given to any writing or printing, in red ink, in old books and manuscripts, especially the date and place on a title-page.

RUB'RIC, *v. t.* To adorn with red.

RUB'RIC, or RUB'RICAL, *a.* Red; marked with red.

RUB'RICAL, *a.* Placed in rubrics.

RUB'RICATE, *v. t.* [*L. rubricatus.*] To mark or distinguish with red.

RUB'RICATE, or RUB'RICATED, *a.* Marked with red.

RUB'BUS, *n.* The bramble, a genus of plants, nat. order *Rosaceæ*, suborder *Rosaceæ* proper. The species, which consist of shrub-like plants, with perennial roots, are universally diffused over the mountainous and temperate regions of the old and new world. Several are cultivated both as ornaments and on account of their agreeable acid and astringent fruit. About 20 species are enumerated by British botanists, among which are the *R. idæus*, or raspberry bush; *R. fruticosus*, or common bramble; *R. suberectus*, or red-fruited bramble; *R. saxatilis*, or stone bramble; and *R. chamæmoris*, mountain bramble or cloud-berry.

RUB'Y, *n.* [Fr. *rubis*; *G. Dan.* and *Sw. rubiu*; *Ir. id.*; from *L. rubeo*, to be red.] 1. A crystallized gem next to the diamond in hardness and value, found chiefly in the sand rivers in Ceylon, Pegu, and Mysore. It is of various shades of red, but the most highly prized varieties are the crimson and

carmine red. Among lapidaries the scarlet-coloured is sometimes called *spinelle ruby*; the pale or rose-red, *balass ruby*; and the yellowish-red, *rubicelle*. The ruby is a modification of the corundum. [See CORUNDUM.] It consists of 83 alumina, 9 magnesia, and 7 or 8 chromic acid; the latter gives it its colour.—2. Redness; red colour.—3. Any thing red.—4. A blain; a blotch; a carbuncle. [The ruby is said to be the stone called by Pliny a *carbuncle*.]—*Ruby of arsenic* or *sulphur*, is the realgar, protosulphuret of arsenic, or red compound of arsenic and sulphur.—*Ruby of zinc*, is the protosulphuret of zinc, or red blend.—*Rock ruby*, the amethystozites of the ancients, is the most valued species of garnet.

RUBY, *v. t.* To make red.

RUBY, *a.* Of the colour of the ruby; red; as, *ruby lips*.

RUBYING, *ppr.* Making red.

RUBY SILVER. See RED SILVER.

RUCK,† *v. t.* [L. *ruco*, to wrinkle, to fold; *ruca*, a fold; or from A. Sax. *urigan*, to cover.] 1. To cover; to bend and set close.—2. To wrinkle, to crease; as, to *ruck up* cloth or a garment.

RUCK,† *v. i.* To lie covered; to lie close; to squat or sit as a hen upon eggs; to take shelter.

RUCK,† *n.* A wrinkle; a fold; a plait; a crease.

RUCKED, *pp.* Wrinkled.

RUCTA'TION, *n.* [L. *ructo*, to belch.] The act of belching wind from the stomach.

RUD,† To make red, used by Spenser, is a different spelling of *red*. [See RUDRY.]

RUD, *n.* Sax. *rude*. [See RED and RUDRY.] 1. Redness; blush; also, red ochre.—2. The fish rudd.

RUD, *a.* Red; ruddy; rosy.

RUD, or RUDD, *n.* [Probably from *red*, *ruddy*.] A fish of the genus *Cyprinus*, with a deep body like the bream, but thicker, a prominent back and small head. The back is of an olive colour; the sides and belly yellow, marked

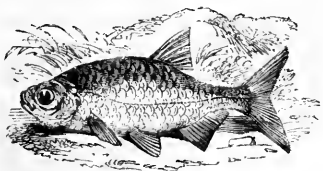

Rudd (*Cyprinus erythrophthalmus*).

with red; the ventral and anal fins and tail of a deep red colour. It is very common on the Continent, and is found in this country in the Thames, the Cam, the Charwell, and in many other streams, as well as in several lakes. Its average length is from nine to fifteen inches.

RUD'DER, *n.* [G. *ruder*, an oar and a rudder; Sax. *rother*, an oar. See ROW. The oar was the first rudder used by man, and is still the instrument of steering certain boats.] 1. In navigation, the instrument by which a ship is steered; that part of the helm which consists of a piece of timber, broad at the bottom, which enters the water and is attached to the stern-post by hinges, on which it turns. This timber is managed by means of the tiller or wheel.—*Rudder*

*coat*, a covering of tarred canvas loosely put round the rudder-head to keep the water from entering by the aperture.—*Rudder pendants*, strong pieces of rope ending in chains, by which the rudder, if unshipped, is held to the ship's quarter.—*Rudder shock*, a piece of wood fitting between the head of the rudder and the rudder hole, to prevent the play of the rudder, in case of the tiller being removed.—2. That which guides or governs the course.

For rhyme the rudder is of verses.

*Hudibras.*

3. A sieve. [Local. See RIDDLE.]—*Rudder perch*, a small fish with the upper part of the body brown, varied with large round spots of yellow, the belly and sides streaked with lines of white and yellow. This fish is said to follow the rudders of ships in the warm parts of the Atlantic.

RUD'DIED, *a.* Made ruddy or red.

RUD'DINESS, *n.* [from *ruddy*.] The state of being ruddy; redness, or rather a lively flesh colour; that degree of redness which characterizes high health, applied chiefly to the complexion or colour of the human skin; as, the *rud'diness* of the cheeks or lips.

RUD'DLE, *n.* [W. *rhuzell*; from the root of *red*, *ruddy*.] The name of a species of red earth, coloured by sesquioxide of iron.

RUD'DLE-MAN, *n.* One who digs ruddle.

RUD'DOC, *n.* [Sax. *rudduc*; from the root of *red*, *ruddy*.] A bird; otherwise called *red-breast*.

RUD'DY, *a.* [Sax. *rude*, *rudu*, *reod*; G. *roth*; W. *rhuz*; Gr. *ερυθρος*; Sans. *rudhira*, blood. This seems to be a dialectical orthography of *red*,—which see.]—1. Of a red colour, or of a colour approaching redness; of a lively flesh colour, or the colour of the human skin in high health. Thus we say, *ruddy* cheeks, *ruddy* lips, a *ruddy* face or skin, a *ruddy* youth; and in poetic language, *ruddy* fruit. But the word is chiefly applied to the human skin.—2. Of a bright yellow colour; as, *ruddy* gold. [Unusual.]

RUDE, *a.* [Fr. *rude*; It. *rude* and *rozzo*; L. *rudis*; G. *roh*, raw, crude. The sense is probably rough, broken, and this word may be allied to *raw* and *crude*.]—1. Rough; uneven; rugged; unformed by art; as, *rude* workmanship, that is, roughly finished; *rude* and unpolished stones.—2. Rough; of coarse manners; unpolished; uncivil; clownish; rustic; as, a *rude* countryman; *rude* behaviour; *rude* treatment; a *rude* attack.

Ruffian, let go that *rude* uncivil touch.

*Shak.*

3. Violent; tumultuous; boisterous; turbulent, as, *rude* winds; the *rude* agitation of the sea.—4. Violent; fierce; impetuous; as, the *rude* shock of armies.—5. Harsh; inclement; as, the *rude* winter.—6. Ignorant; untaught; savage; barbarous; as, the *rude* natives of America or of New Holland; the *rude* ancestors of the Greeks.—7. Raw; untaught; ignorant; not skilled or practised; as, *rude* in speech; *rude* in arms.—8. Artless; inelegant; not polished; as, a *rude* translation of Virgil. RÜDELY, *adv.* With roughness; as, a mountain *rudely* formed.—2. Violently; fiercely; tumultuously. The door was *rudely* assaulted.—3. In a *rude* or uncivil manner; as, to be *rudely* ac-

costed.—4. Without exactness or nicety; coarsely; as, work *rudely* executed. I that am *rudely* stamp'd, and want love's majesty

To strut before a wanton ambling nymph. *Shak.*

5. Unskilfully.

My muse, though *rudely*, has design'd  
Some faint resemblance of his godlike mind. *Dryden.*

6. Without elegance.

RÜDENESS, *n.* A rough broken state; unevenness; wildness; as, the *rudeness* of a mountain, country, or landscape.—2. Coarseness of manners; incivility; rusticity; vulgarity.

And kings the *rudeness* of their joy must bear. *Dryden.*

3. Ignorance; unskilfulness.

What he did amiss was rather through *rudeness* and want of judgment. *Hayward.*

4. Artlessness; coarseness; inelegance; as, the *rudeness* of a painting or piece of sculpture.—5. Violence; impetuosity; as, the *rudeness* of an attack or shock.—6. Violence; storminess; as, the *rudeness* of winds or of the season.

RÜDENTURE, *n.* [Fr. from L. *rudens*, a rope.] In architecture, the figure of a rope or staff, plain or carved, with which the flutings of columns are sometimes filled. [See CABLING.]

RÜDERARY,† *a.* [Low L. *rudera-rius*; from the root of *rudis*, and indicating the primary sense of *rude*, to be broken.] Belonging to rubbish.

RÜDERA'TION,† *n.* [L. *ruderaatio*, from *rudero*, to pave with broken stones.] The act of paving with pebbles or little stones.

RÜDESBY,† *n.* An uncivil turbulent fellow.

RÜDIMENT, *n.* [Fr. from L. *rudimentum*. If connected with *rudis*, it denotes what is taught, and *rudis* may be connected with the Goth. *rodyan*, to speak, Sax. *radan*, to read. But the real origin is not obvious.]—1. A first principle or element; that which is to be first learnt; as, the *rudiments* of learning or science. Articulate sounds are the *rudiments* of language; letters or characters are the *rudiments* of written language; the primary rules of any art or science are its *rudiments*. Hence instruction in the *rudiments* of any art or science, constitutes the beginning of education in that art or science.—2. The original of any thing in its first form. Thus, in botany, the germen, ovary, or seed bud, is the *rudiment* of the fruit yet in embryo; and the seed is the *rudiment* of a new plant. *Rudiment*, in natural history, is also an imperfect organ; one which is never fully formed. Thus, the flowers in the genus *Pentstemon* have four stamens and a *rudiment* of a fifth, (a simple filament without an anther.)

God beholds the first imperfect *rudiments* of virtue in the soul. *Spectator.*

RÜDIMENT, *v. t.* To furnish with first principles or rules; to ground; to settle in first principles.

RÜDIMENT'AL, } *a.* Initial; per-  
RÜDIMENT'ARY, } taining to rudiments, or consisting in first principles; as, *rudimental* essays. *Rudimentary organs* in bot., those developed in the seed when germinating.

RÜDOLPHINE TABLES, *n.* A set of astronomical tables composed by Kepler, and founded on the observations of Tycho Brahé. They were so named in honour of Rudolphus II., emperor of Bohemia.



RUE, *v. t.* (ru.) [Sax. *reowian*, *hreowian*; W. *rhuaw*, *rhuadu*; G. *reuen*, to repent; Dan. and Sw. *ruelse*, contrition. This is the L. *rudo*, to roar, to bray.] To lament; to regret; to grieve for; as, to *rue* the commission of a crime; to *rue* the day.

They will

Chose freely what it now so justly *rues*.

Millon.

RUE, *v. i.* To have compassion.  
RUE, *n.* Sorrow; repentance.  
RUE, *n.* (ru.) [Sax. *rude*; G. *raute*; Gr. *ῥυον*; L. and It. *ruta*; Fr. *rue*; Ir. *ruith*, *raith*. *Rue* is a contracted word. Qu. from its bitter taste, *grating*, roughness.] The English name of a genus of plants (*ruta*); nat. order Rutaceæ. The species are suffruticose herbaceous plants, with alternate exstipulated, pinnated, or decomposed leaves, covered with pellucid dots. Comparatively few of them are known or cultivated. *R. graveolens*, or common rue, sometimes called herb-grace, has been used



Rue (*Ruta graveolens*).

from time immemorial, along with rosemary, as an emblem of remembrance and grace, on account of its evergreen foliage. The stamens are remarkable for their presenting an instance of vegetable irritability. Every part of it is marked by transparent dots filled with volatile oil, which is obtained from it by distillation. The odour of rue is very strong and disagreeable, and the taste acrid and bitter; it possesses powerful stimulant antispasmodic and tonic properties, and when judiciously used, is very serviceable in hysteria and other convulsive disorders.

RUED, *pp.* Lamented; grieved for; regretted.

RŒFUL, *a.* (ru'ful) [*rue* and *full*.] Woful; mournful; sorrowful; to be lamented.

Spur them to *rueful* work. *Shak*  
2. Expressing sorrow.

He sighed and cast a *rueful* eye. *Dryden*.  
RŒFULLY, *adv.* Mournfully; sorrowfully.

RŒFULNESS, *n.* Sorrowfulness; mournfulness.

RŒING, *n.* Lamentation.

RUELLE, *n.* (ruel') [Fr. a narrow street, from *rue*, a street.] A circle; a private circle or assembly at a private house.

RUFESCENT, *a.* [L. *rufesco*, to grow red.] Reddish; tinged with red.

RUFF, *n.* [Arm. *rouffenn*, a wrinkle; W. *rhevu*, to thicken.] 1. A puckered linen ornament formerly worn around the neck.—2. Something puckered or plaited.—3. A small fish, a species of Perca, *P. cernua*, a native of England.—4. A species of the shore birds, the

*Machetes pugnax* of Cuvier, belonging to his Longirostral family. It is alike curious in the disposition of its plumage and for its pugnacious character. It derives its common name from the disposition of the long feathers of the neck in the male, which stand out like the *ruffs* formerly worn. The ruffs



Ruff (*Machetes pugnax*).

are birds of passage, appearing at certain seasons of the year in the north of Europe. When taken and fattened, they are dressed like the woodcock, and their flesh is much esteemed. The female is called *reeve*.—5. *†* A state of roughness. [Sax. *hreoef*.]—6. Pride; elevation; as, princes in the *ruff* of all their glory.—7. A particular species of pigeon.—8. At cards, the act of winning the trick by trumping the cards of another suit. [D. *troef*, *troeven*.]

RUFF, *v. t.* To ruffle; to disorder.—2. To trump any other suit of cards at whist.—3. In *Scotland*, to *ruff* means to applaud by making noise with hands or feet. [D. *troeven*.]

RUFFED, *pp.* Ruffled; disordered.

RUFFIAN, *n.* [Fr. *raffiné*, refined, a name originally given to certain duelling and debauched dandies who infested the court of Henry III. of France. It. *ruffiano*, a pimp. *Ruffian* seems to have been at first a kind of cockcomb, swaggerer, or bully; a *ruffler*.] A boisterous, brutal fellow; a fellow ready for any desperate crime; a robber; a cut-throat; a murderer.

They set them out with sumptuous and gorgeous apparel.—sometyme lyke *ruffians*, but seldome like honest folckes.

Woolton Chr. Manual, 1576.

RUFFIAN, *a.* Brutal; savagely boisterous; as, *ruffian* rage.

RUFFIAN, *v. i.* To play the ruffian; to rage; to raise tumult.

RUFFIANISH, *a.* Having the qualities or manners of a ruffian.

RUFFIANISM, *n.* The character of ruffians.

RUFFIAN-LIKE, } *a.* Like a ruffian;  
RUFFIANLY, } bold in crimes;  
violent; licentious.

RUFFING, *pp.* Applauding, by beating the floor with the feet, or by clapping the hands. [Scotch.]

RUFFLE, *v. t.* [Belgic, *ruyffelen*, to wrinkle. Chaucer has *riweling*, wrinkling, and Spelman cites *riwura* or *rufifura* from Bracton, as signifying in law a breach or laceration of the skin, made by the stroke of a stick.] 1. Properly, to wrinkle; to draw or contract into wrinkles, open plaits or folds.—2. To disorder by disturbing a smooth surface; to make uneven by agitation; as, to *ruffle* the sea or a lake.

She smoothed the *ruff'd* seas. *Dryden*.

3. To decompose by disturbing a calm

state of; to agitate; to disturb; as, to *ruffle* the mind; to *ruffle* the passions or the temper. It expresses less than *fret* and *tear*.—4. To throw into disorder or confusion.

Where best

He might the *ruffed* foe invest. *Hudibras*.

5. To throw together in a disorderly manner.

I *ruffed* up fall'n leaves in heap. [Unusual.] *Chapman*.

6. To furnish with ruffles; as, to *ruffle* a shirt.

RUFFLE, *v. i.* To grow rough or turbulent; as, the winds *ruffle*.—2. To play loosely; to flunter.

On his right shoulder his thick mane reclin'd,  
*Ruffles* at speed and dances in the wind.

*Dryden*.

3. To be rough; to jar; to be in contention.

They would *ruffle* with jurors. *†* *Baron*.  
RUFFLE, *n.* A strip of plaited cambric or other fine cloth attached to some border of a garment, as to the wristband or bosom. That at the bosom is sometimes called a *frill*.—2. Disturbance; agitation; commotion; as, to put the mind or temper in a *ruffle*.

RUFFLE, } *n.* A particular beat or roll  
RUFF, } of the drum, used on certain occasions in military affairs, as a mark of respect. Lieutenant-generals have three *ruffles*, as they pass by the regiment, guard, &c. Major-generals have two, brigadiers one, &c.

RUFFLE, } *v. t.* To beat the ruff or  
RUFF, } roll of the drum.

RUFFLED, *pp.* Disturbed; agitated; furnished with ruffles.

RUFFLE-LESS, *a.* Having no ruffles.

RUFFLEMENT, *n.* Act of ruffling.

RUFFLER, *n.* A bully; a swaggerer.

RUFFLING, *pp.* Disturbing; agitating; furnishing with ruffles.

RUFFLING, *n.* Commotion; disturbance; agitation.

RUFFLING, } *pp.* Beating a roll of  
RUFFING, } the drum.

RUFFLING, } *n.* A particular beat or  
RUFFING, } roll of the drum, used on certain occasions as a mark of respect.

RUFIOUS, *a.* [L. *rufus*; Sp. *rufo*; probably from the root of L. *rubeo*.] Reddish; of a reddish colour, or rather of a yellowish red.

RUFTER-HOOD, *n.* In *falconry*, a hood to be worn by a hawk when she is first drawn.

RUG, *n.* [D. *ruig*, G. *rauch*, rough, hairy, shaggy; Sw. *rugg*, entangled hair; *ruggig*, rugged, shaggy. This coincides with Dan. *rug*, W. *rhyg*, rye, that is, *rough*; W. *rhuig*, something abounding with points. In W. *brycan* is a *rug*, a clog, a brogue for the feet, a covering. This belongs to the great family of *rough*, L. *ruqa*, *raucus*.]—1. A coarse nappy woollen cloth used for a bed cover, and in modern times particularly, for covering the carpet before a fire-place. This name was formerly given to a coarse kind of frieze used for winter garments, and it may be that the poor in some countries still wear it.—2. A rough, woolly or shaggy dog.

RUG, *v. t.* [Teuton. *rucken*.] To pull hastily or roughly; to tear. [Scotch.]

RUG, *n.* A rough or hasty pull. [Scotch.]

RUGATE, *a.* Wrinkled; having alternate ridges and depressions.

RUGGED, *a.* [from the root of *rug*, *rough*,—which see.]—1. Rough; full of asperities on the surface; broken into sharp or irregular points or crags, or

otherwise uneven; as, a *rugged* mountain; a *rugged* road.—2. Uneven; not neat or regular.

His well proportion'd beard made rough and *rugged*. *Shak.*

3. Rough in temper; harsh; hard; crabbed; austere.—4. Stormy; turbulent; tempestuous; as, *rugged* weather; a *rugged* season.—5. Rough to the ear; harsh; grating; as, a *rugged* verse in poetry; *rugged* prose.—6. Sour; surly; frowning; wrinkled; as, *rugged* looks.—7. Violent; rude; boisterous.—8. Rough; shaggy; as, a *rugged* bear.—9. In *botany*, scabrous; rough with tubercles or stiff points; as a leaf or stem.

RUG'GEDLY, *adv.* In a rough or rugged manner.

RUG'GEDNESS, *n.* The quality or state of being rugged; roughness; asperity of surface; as, the *ruggedness* of land or of roads.—2. Roughness of temper; harshness; surliness.—3. Coarseness; rudeness of manners.—4. Storminess; boisterousness; as of a season.

RUG'GOWNED, *a.* Wearing a coarse gown or rug.

RUG'IN, *n.* A nappy cloth.

RU'GINE, *n.* [Fr.] A surgeon's rasp. RU'GOSE, } *a.* [L. *rugosus*, from *ruqa*, RU'GOUS, } a wrinkle.]—1. Wrinkled; full of wrinkles.—2. In *botany*, a rugose leaf is when the veins are more contracted than the disk, so that the latter rises into little inequalities; as in sage, primrose, cowslip, &c. The term is applied also in *conchology* and *entomology*, when a surface or part is rugged or full of wrinkles.

RUGOSITY, *n.* A state of being wrinkled. [*Little used.*]

RUG'ULOSE, *a.* In *bot.*, finely wrinkled; as, a leaf.

RU'IN, *n.* [Fr. *ruine*, from L. and Sp. *ruina*; It. *ruina* and *rovina*; from L. *ruo*, to fall, to rush down; W. *rhevin*, a sudden glide, slip, or fall, ruin; *rheu*, something slippery or smooth, ice, frost; *rheu*, to move or be active; *rhëb*, a running off; *rhëbyz*, a destroyer. Perhaps the latter words are of a different family.]—1. Destruction; fall; overthrow; defeat; that change of anything which destroys it, or entirely defeats its object, or unfits it for use; as, the *ruin* of a house; the *ruin* of a ship or an army; the *ruin* of a constitution of government; the *ruin* of health; the *ruin* of commerce; the *ruin* of public or private happiness; the *ruin* of a project.—2. Mischievousness; that which destroys.

The errors of young men are the *ruin* of business. *Bacon.*

3. *Ruin*, more generally *ruins*, the remains of a decayed or demolished city, house, fortress, or any work of art or other thing; as, the *ruins* of Balbec, Palmyra, or Persepolis; the *ruins* of a wall; a castle in *ruins*.

The labour of a day will not build up a virtuous habit on the *ruins* of an old and vicious character. *Buckminster.*

4. The decayed or enfeebled remains of a natural object; as, the venerable old man presents a great mind in *ruins*.—5. The cause of destruction.

They were the *ruin* of him and of all Israel; 2 Chron. xxviii.

RU'IN, *v. t.* [Fr. *ruiner*.]—1. To demolish; to pull down, burn, or otherwise destroy; as, to *ruin* a city or an edifice.—2. To subvert; to destroy; as, to *ruin* a state or government.—3. To destroy; to bring to an end; as, to *ruin* com-

merce or manufactures.—4. To destroy in any manner; as, to *ruin* health or happiness; to *ruin* reputation.—5. To counteract; to defeat; as, to *ruin* a plan or project.—6. To deprive of felicity or fortune.

By thee raised I *ruin* all my foes. *Milton.*  
Grace with a nod, and *ruin* with a frown. *Dryden.*

7. To impoverish; as, to be *ruined* by speculation.

The eyes of other people are the eyes that *ruin* us. *Franklin.*

8. To bring to everlasting misery; as, to *ruin* the soul.

RU'IN, *v. i.* To fall into ruins.—2. To run to ruin; to fall into decay or be dilapidated.

Though he his house of polish'd marble build, Yet shall it *ruin* like the moth's frail cell. *Sandys.*

3. To be reduced; to be brought to poverty or misery.

If we are idle, and disturb the industrious in their business, we shall *ruin* the faster. *Locke.*

*Note.*—This intransitive use of the verb is now unusual.

RU'INATE, *v. t.* To demolish; to subvert; to destroy; to reduce to poverty.

RUINA'TION, *n.* Subversion; overthrow; demolition. [*Inelegant.*]

RU'INED, *pp.* Demolished; destroyed; subverted; reduced to poverty; undone.

RU'INER, *n.* One that ruins or destroys.

RU'INIFORM, *a.* [L. *ruina* and *form*.] Having the appearance of ruins, or the ruins of houses. Certain minerals are said to be *ruiniform*.

RU'INING, *ppr.* Demolishing; subverting; destroying; reducing to poverty; bringing to endless misery.

RU'INOUS, *a.* [L. *ruinosus*; Fr. *ruineux*.]—1. Fallen to ruin; entirely decayed; demolished; dilapidated; as, an edifice, bridge, or wall in a *ruinous* state.—2. Destructive; baneful; pernicious; bringing or tending to bring certain ruin. Who can describe the *ruinous* practice of intemperance?—3. Composed of ruins; consisting in ruins; as, a *ruinous* heap. Is. xvii.

RU'INOUSLY, *adv.* In a *ruinous* manner; destructively.

RU'INOUSNESS, *n.* A *ruinous* state or quality.

RUL'ABLE, *a.* Subject to rule; according to rule.

RULE, *n.* [W. *rheol*; Sax. *regol*, *reogol*; Sw. Dan. G. and D. *regel*; Fr. *regle*; L. *regula*, from *rego*, to govern, that is, to stretch, strain, or make straight. We suppose the Welsh *rheol* to be a contracted word.] 1. Government; sway; empire; control; supreme command or authority.

A wise servant shall have *rule* over a son that causeth shame; Prov. xvii.

And his stern *rule* the groaning land obey'd. *Pope.*

2. That which is established as a principle, standard, or directory; that by which any thing is to be adjusted or regulated, or to which it is to be conformed; that which is settled by authority or custom for guidance and direction. Thus a statute or law is a *rule* of civil conduct; a canon is a *rule* of ecclesiastical government; the precept or command of a father is a *rule* of action or obedience to children; precedents in law are *rules* of decision to judges; maxims and customs furnish

*rules* for regulating our social opinions and manners. The laws of God are *rules* for directing us in life, paramount to all others.

A *rule* which you do not apply is no *rule* at all. *J. M. Mason.*

3. An instrument by which lines are drawn; also, an instrument for measuring short lengths, and performing various operations in mensuration. There are of course numerous kinds of rules adapted to their peculiar objects. [See *RULER*.]—*Carpenters' rule*, a folding ruler, generally three feet long, and used by carpenters and other artificers for taking measures, having a variety of scales adapted to facilitate the calculations of most frequent occurrence, by inspection.—*Gauging rule*, a rule adapted to discover the contents of casks and other vessels. It is used by the officers of excise.—*Brass rules*, pieces of brass of different thicknesses, made type height, to print with. They are used for column lines, in table work, to separate matter that requires to be distinct, as into columns, &c. Besides these, there are stonecutters' rules, masons' rules, glaziers' rules, sliding and parallel rules, &c. [See *SLIDING RULE*, *PARALLEL RULER*.]—4. Established mode or course of proceeding prescribed in private life.

Every man should have some fixed *rules* for managing his own affairs.—5. A maxim, canon, or precept to be observed in any art or science. In the *fine arts*, *rules* are those laws and maxims founded on the general and fundamental truths of nature, by which artists are guided in their compositions.

—6. In *monasteries*, *corporations*, or *societies*, a law or regulation to be observed by the society and its particular members.—7. In *English law*, an order of one of the three superior courts of common law. Rules are either general or particular. *General rules* are such orders relating to matters of practice as are laid down and promulgated by the court for the general guidance of the suitors. They are a declaration of what the court will do, or require to be done, in all matters falling within the terms of the rule, and they resemble in some respects the Roman edict. *Particular rules* are such as are confined to the particular case in reference to which they have been granted.—8. In *arith.*, and *alge.*, a determinate mode prescribed for performing any operation and producing a certain result, as *rules* for addition, subtraction, &c.; *rules* for practice; *rules* for the extraction of roots, &c. *Algebraic rules* are often expressed in *formulas*; thus, if *a, b, c* represent the three sides of a right-angled triangle, of which *c* is the hypothenuse, the formula for determining *cis*

$c = \sqrt{a^2 + b^2}$ .—9. In *grammar*, an established form of construction in a particular class of words; or the expression of that form in words. Thus it is a *rule* in English, that *s* or *es*, added to a noun in the singular number, forms the plural of that noun; but *man* forms its plural *men*, and is an exception to the *rule*.—*Rule of three*, is that rule of arithmetic which directs, when three terms are given, how to find a fourth, which shall have the same ratio to the third term, as the second has to the first. It is more generally called the Rule of Proportion. [See *PRORON*

TION.—*Rule of the road.* [See RIGHT, a.] —*Rule joint*, a joint formed in the manner of those to be found in the carpenters' foot rule.

**RULE**, *v. t.* To govern; to control the will and actions of others, either by arbitrary power and authority, or by established laws. The emperors of the East *rule* their subjects without the restraints of a constitution. In limited governments, men are *ruled* by known laws.

If a man know not how to *rule* his own house, how shall he take care of the church of God? 1 Tim. iii.

2. To govern the movements of things; to conduct; to manage; to control. That God *rules* the world he has created, is a fundamental article of belief.—3. To manage; to conduct, in almost any manner.—4. To settle as by a rule.

That's a *ruled* case with the schoolmen. *Atterbury.*

5. To mark with lines by a ruler; as, to *rule* a blank book.—6. To establish by decree or decision; to determine; as a court.

**RULE**, *v. i.* To have power or command; to exercise supreme authority. By me princes *rule.* Prov. viii. It is often followed by *over.*

They shall *rule over* their oppressors. Isa. xiv. We subdue and *rule over* all other creatures. *Ray.*

2. In *law*, to decide; to lay down and settle as a *rule* or order of court.—3. Among *merchants*, to stand, or maintain a level; as, prices *rule* lower than formerly.

**RULED**, *pp.* Governed; controlled; conducted; managed; established by judicial decision.

**RULER**, *n.* One that governs, whether emperor, king, pope, or governor; any one that exercises supreme power over others.—2. One that makes or executes laws in a limited or free government. Thus legislators and magistrates are called *rulers*.—3. A rule; in a mechanical sense, the words *rule*, *ruler*, are both used for a piece of wood, brass, or ivory, with straight edges or sides, by which straight lines may be drawn on paper, parchment, or other substance, by guiding a pen or pencil along the edge. [See **RULE**, No. 3.] When a ruler has the lines of chords, tangents, sines, &c., it is called a *plane scale*.

**RÜLING**, *ppr.* Governing; controlling the will and actions of intelligent beings, or the movements of other physical bodies.—*Ruling Elder.* [See **ELDER**.]—2. Marking by a ruler.—3. Deciding; determining.—4. A predominant; chief; controlling; as, a *ruling* passion.

**RÜLY**, † *a.* [from *rule*.] Orderly; easily restrained. [See UNRULY.]

**RUM**, *n.* [Fr. *rum*.] Spirit distilled from cane juice; or the scummings of the juice from the boiling-house, or from the treacle or molasses which drains from sugar, or from dunder, the lees of former distillations. Its flavour is due to the presence of a peculiar volatile oil. In the United States, rum is distilled from molasses only.—2. A low cant word for a country parson.—3. A queer, odd, indescribable person or thing. **RUM**, † *a.* Old fashioned; odd; queer. [A low cant word.]

**RUMBLE**, *n.* A seat for servants behind a carriage.

**RUMBLE**, *v. i.* [D. *rommelen*; G. *rumeln*.] If *Rm* are the radical letters,

II.

this word may be referred to the Ch. Syr. Heb. and Eth. *רמ* *raam*. With a prefix, *grumble*, Gr. *βρυγ*, L. *fremo*, I. *crum*, thunder, G. *brummen*, Sw. *rama*, to bellow.] To make a low, heavy, continued sound; as, thunder *rumbles* at a distance, but when near, its sound is sharp and rattling. A heavy carriage *rumbles* on the pavement.

**RUMBLER**, *n.* The person or thing that rumbles.

**RUMBLING**, *ppr.* Making a low, heavy continued sound; as, *rumbling* thunder. A *rumbling* noise is a low, heavy, continued noise.—*Rumbling drains*, in agriculture, drains formed of a stratum of rubble stones.

**RUMBLING**, *n.* A low, heavy, continued sound; Jer. xvii.

**RUMBLINGLY**, *adv.* In a rumbling manner.

**RUMEN**, *n.* [L.] The cud of a ruminant; also, the upper stomach of animals which chew the cud.

**RUMEX**, *n.* A genus of plants, the species of which are known by the name of *dochs* and *sorrels*. [See **DOCK**.]

**RUMINANT**, *a.* [Fr. from L. *rumino*.] Chewing the cud; having the property of chewing again what has been swallowed; as, *ruminant* animals.

**RUMINANT**, *n.* An animal that chews the cud, as the camel, deer, goat, and bovine kind. *Ruminants* are four-footed, hairy, and viviparous.

**RUMINANTIA**, *n.* An order of herbivorous animals, having four stomachs, the first so situated as to receive a large quantity of vegetable matters coarsely bruised by a first mastication, which passes into the second, where it is moistened and formed into little pellets, which the animal has the power of bringing again to the mouth to be re-chewed, after which it is swallowed into the third stomach, from which it passes to the fourth, where it is finally digested. The camel, the deer, the bovine genus, the goat, and the sheep are examples of this order.

**RUMINANTLY**, *adv.* By chewing.

**RUMINATE**, *v. i.* [Fr. *ruminer*; L. *rumino*, from *rumen*, the cud; W. *rhum*, that swells out.] 1. To chew the cud; to chew again what has been slightly chewed and swallowed. Oxen, sheep, deer, goats, camels, hares, and squirrels *ruminate* in fact; other animals, as moles, bees, crickets, beetles, crabs, &c., only appear to *ruminate*. The only animals endowed with the genuine faculty of rumination, are the *Ruminantia*, or cloven-hoofed quadrupeds, (*Pecora*, Linn.) but the hare, although its stomach is differently organized, is an occasional and partial ruminant.—2. To muse; to meditate; to think again and again; to ponder. It is natural to *ruminate* on misfortunes.

He practises a slow meditation, and *ruminates* on the subject. *Watts.*

**RUMINATE**, † *a.* In *bot.*, pierced by **RUMINATED**, } numerous narrow cavities; full of dry cellular cavities, like the albumen of a nutmeg.

**RUMINATE**, *v. t.* To chew over again. 2. To muse on; to meditate over and over again.

Mad with desire, she *ruminates* her sin. *Dryden.*

**RUMINATED**, *pp.* Chewed again; mused on.

**RUMINATING**, *ppr.* Chewing the cud; musing.

**RUMINATION**, *n.* [L. *ruminatio*.]

1. The act of chewing the cud; the act by which food, once chewed and swallowed, is a second time subjected to mastication.—2. The power or property of chewing the cud.

*Rumination* is given to animals, to enable them at once to lay up a great store of food, and afterward to chew it. *Arbutnot.*

3. A musing or continued thinking on a subject; deliberate meditation or reflection.

Retiring full of *rumination* sad. *Thomson.*

**RUMINATOR**, *n.* One that ruminates or muses on any subject; one that pauses to deliberate and consider.

**RUMMAGE**, *n.* A searching carefully by looking into every corner and by tumbling over things.

**RUMMAGE**, *v. t.* [Fr. *remuer*.] To search narrowly by looking into every corner and turning over or removing goods or other things.

Our greedy seamen *rummage* every hold. *Dryden.*

**RUMMAGE**, *v. i.* To search a place narrowly by looking among things.

I have often *rummaged* for old books in Little-Britain and Duck-lane. *Swift.*

**RUMMAGED**, *pp.* Searched in every corner.

**RUMMAGING**, *ppr.* Searching in every corner.

**RUMMER**†, *n.* [D. *roemer*, a wine glass, from *roemen*, to vaunt, brag or praise.] A glass or drinking cup.

**RUMOUR**, *n.* [L.] Flying or popular report; a current story passing from one person to another, without any known authority for the truth of it.

*Rumour* next, and chance, And tumult, and confusion, all embroil'd. *Milton.*

When ye shall hear of wars and *rumours* of wars, be ye not troubled; Mark xiii.

2. Report of a fact; a story well authorized.

This *rumour* of him went forth throughout all Judea; Luke vii.

3. Fame; reported celebrity.

Great is the *rumour* of this dreadful knight. *Shak.*

**RUMOUR**, *v. t.* To report; to tell or circulate a report.

'Twas *rumour'd*

My father 'scap'd from out the citadel. *Dryden.*

**RUMoured**, *pp.* Told among the people; reported.

**RUMOURER**, *n.* A reporter; a teller of news.

**RUMOURING**, *ppr.* Reporting; telling news.

**RUMP**, *n.* [G. *rumpf*; Sw. *rumpa*; Dan. *rumpe* or *rompe*.] 1. The end of the back bone of an animal with the parts adjacent. Among the Jews, the *rump* was esteemed the most delicate part of the animal. Contemptuously, the end of the back bone of human beings.—2. The buttocks.—3. Figuratively, the fag end of something which lasts longer than the original body.—*Rump Parliament*, in *English history*, the parliament which was assembled in 1659, so called in derision from being as it were the remnant and fag-end of the old Long Parliament. Hence the name *Rumper* was given to one who had favoured or belonged to the *Rump* Parliament.

**RUMPLE**, *v. i.* [D. *rompelen*, to rumple; Sax. *hrympelle*, a fold; probably connected with *crumple*, W. *crum*, *crom*, crooked, *crymu*, to bend.] To wrinkle; to make uneven; to form into irregular

inequalities; as, to *rump* an apron or a cravat.

**RUMPLE**, *n.* A fold or plait.

**RUMPLED**, *pp.* Formed into irregular wrinkles or folds.

**RUMPLESS**, *a.* Destitute of a tail; as, a *rumpless* fowl.

**RUMPLING**, *ppr.* Making uneven.

**RUN**, *v. i.* pret. *ran* or *run*; *pp.* *run*. [*Sax. rennan*; and with a transposition of letters, *cernan*, *arnian*, *yrnan*; Goth. *rinnan*; G. *rennen*, *rinnen*. The Welsh has *rhin*, a running, a channel, hence the *Rhine*.] 1. To move or pass in almost any manner, as on the feet or on wheels. Men and other animals *run* on their feet; carriages *run* on wheels, and wheels *run* on their axletrees.—2. To move or pass on the feet with celerity or rapidly, by leaps or long quick steps, as, men and quadrupeds *run* when in haste.—3. To use the legs in moving; to step; as, children *run* alone or *run* about.—4. To move in a hurry.

The priest and people *run* about.

*B. Jonson.*

5. To proceed along the surface; to extend; to spread; as, the fire *runs* over a field or forest.

The fire *ran* along upon the ground; *Exod. ix.*

6. To rush with violence; as, a ship *runs* against a rock; or one ship *runs* against another.—7. To perform a passage by land or water; to pass or go, as ships, railroad cars, stage-coaches, &c., *run* regularly between different places. The ship has *run* ten knots an hour.—8. To contend in a race; as, men or horses *run* for a prize.—9. To flee for escape; as, soldiers after a defeat.—10. To depart privately; to steal away.

My conscience will serve me to *run* from this Jew, my master. *Shak.*

11. To flow in any manner, slowly or rapidly; to move or pass; as a fluid. Rivers *run* to the ocean or to lakes. The tide *runs* two or three miles an hour. Tears *run* down the cheeks.—12. To emit; to let flow.

I command that the conduit *run* nothing but claret. *Shak.*

Rivers *run* potable gold. *Milton.*

13. To be liquid or fluid.

As wax dissolves, as ice begins to *run*. *Addison.*

14. To be fusible; to melt.

Sussex iron ores *run* freely in the fire. *Woodward.*

15. To fuse; to melt.

Your iron must not burn in the fire, that is, *run* or melt, for then it will be brittle. *Mozon.*

16. To turn; as, a wheel *runs* on an axis or on a pivot.—17. To pass; to proceed; as, to *run* through a course of business; to *run* through life; to *run* in a circle or a line; to *run* through all degrees of promotion.—18. To flow, as words, language, or periods. The lines *run* smoothly.—19. To pass, as time.

As fast as our time *runs*, we should be glad in most part of our lives that it *ran* much faster. *Addison.*

20. To have a legal course; to be attached to; to have legal effect.

Customs *run* only upon our goods imported or exported, and that but once for all; whereas interest *runs* as well upon our ships as goods, and must be yearly paid. *Childs.*

21. To have a course or direction.

Where the generally allowed practice *runs* counter to it. *Locke.*

Little is the wisdom, where the flight *So runs* against all reason. *Shak.*

22. To pass in thought, speech, or practice; as, to *run* through a series of arguments; to *run* from one topic to another.

Virgil, in his first *Georgic*, has *run* into a set of precepts foreign to his subject. *Addison.*

23. To be mentioned cursorily or in few words.

The whole *runs* on short, like articles in an account. *Arbuthnot.*

24. To have a continued tenor or course. The conversation *ran* on the affairs of the Greeks.

The king's ordinary style *runneth*, "our sovereign lord the king." *Sanderson.*

25. To be in motion; to speak incessantly. Her tongue *runs* continually.—26. To be busied.

When we desire any thing, our minds *run* wholly on the good circumstances of it; when it is obtained, our minds *run* wholly on the bad ones. *Swift.*

27. To be popularly known.

Men gave them their own names, by which they *run* a great while in Rome. *Temple.*

28. To be received; to have reception, success, or continuance. The pamphlet *runs* well among a certain class of people.—29. To proceed in succession. She saw with joy the line immortal *run*, Each sire impress'd and glaring in his son. *Pope.*

30. To pass from one state or condition to another; as, to *run* into confusion or error; to *run* distracted.—31. To proceed in a train of conduct.

You should *run* a certain course. *Shak.*

32. To be in force.

The owner hath incurred the forfeiture of eight years' profits of his lands, before he cometh to the knowledge of the process that *runneth* against him. *Bacon.*

33. To be generally received.

He was not ignorant what report *run* of himself. *Knolles.*

34. To be carried; to extend; to rise; as, debates *run* high.

In popish countries, the power of the clergy *runs* higher. *Ayliffe.*

35. To have a track or course.

Searching the ulcer with my probe, the sinus *run* up above the orifice. *Wiseman.*

36. To extend; to lie in continued length. Veins of silver *run* in different directions.—37. To have a certain direction. The line *runs* east and west.—38. To pass in an orbit of any figure. The planets *run* their periodical courses. The comets do not *run* lawless through the regions of space.—39. To tend in growth or progress. Pride is apt to *run* into a contempt of others.—40. To grow exuberantly. Young persons of 10 or 12 years old, soon *run* up to men and women.

If the richness of the ground cause turnips to *run* to leaves, treading down the leaves will help their rooting. *Mortimer.*

41. To discharge pus or other matter; as, an ulcer *runs*.—42. To reach; to extend to the remembrance of; as, time out of mind, the memory of which *runneth* not to the contrary.—43. To continue in time, before it becomes due and payable; as, a note *runs* thirty days; a note of six months has ninety days to *run*.—44. To continue in effect, force, or operation.

The statute may be prevented from *running*... by the act of the creditor. *Hopkinson.*

45. To press with numerous demands of payment; as, to *run* upon a bank.—46. To pass or fall into fault, vice, or

misfortune; as, to *run* into vice; to *run* into evil practices; to *run* into debt; to *run* into mistakes.—47. To fall or pass by gradual changes; to make a transition; as, colours *run* one into another.—48. To have a general tendency.

Temperate climates *run* into moderate governments. *Swift.*

49. To proceed as on a ground or principle. Thus Atterbury; "Upon that the apostle's argument *runs*."—50. To pass or proceed in conduct or management.

Tarquin *running* into all the methods of tyranny, after a cruel reign was expelled. *Swift.*

51. To creep; to move by creeping or crawling; as, serpents *run* on the ground. [*Scarcely correct.*]—52. To slide; as, a sledge *runs* on the snow.—53. To dart; to shoot; as, a meteor in the sky.—54. To fly; to move in the air; as, the clouds *run* from N. E. to S. W.—55. In *Scripture*, to pursue or practise the duties of religion.

Ye did *run* well; who did hinder you? *Gal. v.*

56. To come to an end; to become empty, or, as a sand glass; as my glass is *run* (out).—To *run* after, to pursue or follow.—2. To search for; to endeavour to find or obtain; as, to *run* after similes.—To *run* at, to attack with the horns, as a bull.—To *run* away, to flee; to escape.—To *run* away with, to hurry without deliberation.—2. To convey away; or to assist in escape or elopement.—To *run* in, to enter; to step in.—To *run* into, to enter; as, to *run* into danger.—To *run* in debt; to get credit.—To *run* in with, to close; to comply; to agree with. [*Unusual.*]—2. To make toward; to near; to sail close to; as, to *run* in with or to the land; a seaman's phrase.—To *run* down a coast, to sail along it.—To *run* on, to be continued. Their accounts had *run* on for a year or two without a settlement.—2. To talk incessantly.—3. To continue a course.—To *run* over, to overflow; as, a cup *runs* over; or the liquor *runs* over.—To *run* out, to come to an end; to expire; as, a lease *runs* out at Michaelmas.—2. To spread exuberantly; as, insectile animals *run* out into legs.—3. To expatiate; as, to *run* out into beautiful digressions. He *runs* out in praise of Milton.—4. To be wasted or exhausted; as, an estate managed without economy, will soon *run* out.—5. To become poor by extravagance.

And had her stock been less, no doubt She must have long ago *run* out. *Dryden.*

To *run* up, to rise; to swell; to amount. Accounts of goods credited *run* up very fast.

**RUN**, *v. t.* To drive or push; in a general sense. Hence to *run* a sword through the body, is to stab or pierce it.—2. To drive; to force.

A talkative person *runs* himself upon great inconveniences, by blabbing out his own or others' secrets. *Ray.*

Others accustomed to retired speculations, *run* natural philosophy into metaphysical notions. *Locke.*

3. To cause to be driven.

They *ran* the ship aground; Acts xxvii.

4. To melt; to fuse.

The purest gold must be *run* and washed. *Felton.*

5. To incur; to encounter; to run the risk or hazard of losing one's property.

To *run the danger*, is a phrase not now in use.—6. To venture; to hazard.

He would himself be in the Highlands to receive them, and *run* his fortune with them.

*Clarendon.*

7. To smuggle; to import or export without paying the duties required by law; as, to *run* goods.—8. To pursue in thought; to carry in contemplation; as, to *run* the world back to its first original.

I would gladly understand the formation of a soul, and *run* it up to its *punctum saliens*.

*Collier.*

9. To push; to thrust; as, to *run* the hand into the pocket or the bosom; to *run* a nail into the foot.—10. To ascertain and mark by metes and bounds; as, to *run* a line between towns or states.—11. To cause to ply; to maintain in running or passing; as, to *run* a stage coach from London to Bristol; to *run* a train from Manchester.—12. To cause to pass; as, to *run* a rope through a block.—13. To found; to shape, form, or make in a mould; to cast; as, to *run* buttons or balls.—To *run down*, in hunting, to chase to weariness; as, to *run down* a stag.—2. In navigation, to *run down* a vessel, is to run against her, end on, and sink her.—3. To crush; to overthrow; to overhear.

Religion is *run down* by the license of these times.

*Berkeley.*

4. To pursue with scandal or opposition.—To *run hard*, to press with jokes, sarcasm, or ridicule.—2. To urge or press importunately.—To *run over*, or to recount in a cursory manner; to narrate hastily; as, to *run over* the particulars of a story.—2. To consider cursorily.—3. To pass the eye over hastily.—To *run out*, to thrust or push out; to extend.—2. To waste; to exhaust; as, to *run out* an estate.—To *run through*, to expend; to waste; as, to *run through* an estate.—2. To stab through with a sword or spear.—To *run up*, to increase; to enlarge by additions. A man who takes goods on credit, is apt to *run up* his account to a large sum before he is aware of it.—2. To thrust up, as any thing long and slender.—To *run at*, or *take a run at*, to go against; as, Fortune has taken a *run at* him.

RUN, *n.* The act of running.—2. Course; motion; as, the *run* of humour.—3. Flow; as, a *run* of verses to please the ear.—4. Course; process; continued series; as, the *run* of events.—5. Way; will; uncontrolled course.

Our family must have their *run*.

*Arbutnot.*

6. General reception; continued success.

It is impossible for detached papers to have a general *run* or long continuance, if not diversified with humour.

*Addison.*

7. Modish or popular clamour, current opinion; censure, followed by *against*, as, a violent *run* against university education.—8. A general or uncommon pressure on a bank or treasury for payment of its notes.—9. The aftmost part of a ship's bottom.—10. The distance sailed by a ship; as, we had a good *run*.—11. A voyage; also, an agreement among sailors to work a passage from one place to another.—12. A pair of mill-stones. A mill has two, four or six *runs* of stones.—13. Prevalence; as, a disease, opinion, or fashion has its *run*.—14. In the middle and southern states of America, a small stream; a brook.—In the long *run*, [at the long *run*, not so generally used,] signifies the whole pro-

cess or course of things taken together; in the final result; in the conclusion or end.—The *run of mankind*, the generality of people.

RUN'AGATE, *n.* [Fr. *renégat*.] A fugitive; an apostate; a rebel; a vagabond.

RUN'AWAY, *n.* [*run* and *away*.] One that flies from danger or restraint; one that deserts lawful service; a fugitive.

RUNCA'TION, *n.* [L. *runcatio*.] A weeding.

RUNCINATE, *a.* [L. *runcina*, a saw.] In bot., a *runcinate* leaf is a sort of pinnatifid leaf, with the lobes convex before and straight behind, pointing backwards, like the teeth of a double saw, as in the dandelion.

RUNCINA'TO DEN-TATE, *a.* In bot., hooked back and toothed.

RUNDLE, *n.* [from *round*, G. *rund*.] 1. A round; a step of a ladder.

—2. Something put round an axis; a petriochium; as, a cylinder with a *rundle* about it.

RUNDLET, *n.* [from *round*.] A small *runlet*, } barrel of no certain dimensions. It may contain from 3 to 20 gallons.

RUNE, *n.* [See RUNIC.] The runic letter or character.

RUNER, *n.* A bard or learned man among the ancient Goths. [See RUNIC.]

RUNES, *n. plur.* Gothic poetry or rhymes. Also the signs or letters of the ancient alphabet peculiar to the Teutonic nations, especially the Germans and Scandinavians.

RUNG, *pp.* of Ring.

RUNG, *n.* A floor timber in a ship, whence the end is called a *rung-head*; more properly a *floor-head*.—In *Scotch*, any long piece of wood, but most commonly a coarse heavy staff.

RUN'IC, *a.* [W. *rhin*, Ir. *run*, Goth. *runa*, Sax. *run*, a secret or mystery, a letter.] An epithet applied to the language and letters of the Teutonic nations, especially the Scandinavians and Germans. The runic alphabet consisted of sixteen letters, most of which bear a great similarity to the Greek and Roman characters. The earliest runic characters are found cut on stones, which were either sepulchral monuments or landmarks. Such stones are found in Norway, Sweden, Denmark, Northern Germany, Scotland, and in some parts of France and Spain. The characters consist almost invariably of straight lines, in the shape of little sticks either singly or put together.—*Runic wands*, willow wands inscribed with mysterious characters, and used by the heathen tribes of the north of Europe, in the performance of magic ceremonies. [In Russ. *chronoyu* is to conceal.]

RUNKLED, *a.* [Ang. Sax. *wrinclian*.] Wrinkled. [*Scotch*.]

RUN'LET, *n.* A little run or stream; a brook.

RUN'NEL, *n.* [from *run*.] A rivulet or small brook.

RUN'NER, *n.* [from *run*.] One that runs; that which runs.—2. A racer.—3. A messenger.—4. A shooting sprig; a very slender prostrate stem, having a bud at the end which sends out leaves and roots; as in the strawberry.

In every root there will be one *runner*, with little buds on it.

*Mortimer.*

5. The moving stone of a mill.—6. A

bird.—7. In *ships*, a rope belonging to the garnet, and to the two bolt-tackles. It is received in a single block joined to the end of a pennant, and is used to increase the mechanical power of the tackle.

RUN'NET, *n.* [D. *runzel*, from *runnen*, *ronnen*, to curdle; G. *rinnen*, to curdle, and to *run* or flow; Sax. *gerunnen*, coagulated. It is sometimes written *Rennet*.] The dried stomach, or the coagulated milk found in the stomachs of calves or other sucking quadrupeds. The same name is given to a liquor prepared by steeping the inner membrane of a calf's stomach in water, and to the membrane itself. This is used for coagulating milk, or converting it into curd in the making of cheese.

RUN'NING, *ppr.* Moving or going with rapidity; flowing.—2. *A. kept* for the race; as, a *running horse*.—3. In succession; without any intervening day, year, &c.; as, to visit two days *running*; to sow land two years *running*.—4. Discharging pus or other matter; as, a *running sore*.—*Running days*, in *Scots law*, a term in the contract of charter-party used in contradistinction to *working days*, and referring to the ship's *lay days*, or days of demurrage.—*Running ship*, a vessel which in time of war does not sail with convoy.—*Running part of a tackle*, the same as the *fall*, or that part on which the power is applied to produce the intended effect.

RUN'NING, *n.* The act of running, or passing with speed.—2. That which runs or flows; as, the first *running* of a still or of cider at the mill.—3. The discharge of an ulcer or other sore.

RUN'NING-FIGHT, *n.* A battle in which one party flees and the other pursues, but the party fleeing keeps up the contest.

RUN'NING-FIRE, *n.* A term used when troops fire rapidly in succession; also a brisk irregular cannonade by ships of war.

RUN'NING KNOT, *n.* A kind of knot made on a snare for catching hares and rabbits.

RUNNING-RIG'GING, *n.* That part of a ship's rigging or ropes which passes through blocks, &c.; in distinction from *standing-rigging*.

RUNNING-TITLE, *n.* In *printing*, the title of a book that is continued from page to page on the upper margin, called, among printers, the *heads*.

RUN'NION, *n.* [Fr. *rogner*, to cut, pare or shred.] A paltry scurvy wretch.

RUN'RIG LANDS, *n.* In *Scots law*, lands the alternate ridges of which belong to different proprietors.

RUNT, *n.* [In D. *rund* is a bull or cow; in Scot. *runt* is the trunk of a tree, a hardened stem or stalk of a plant, an old withered woman, an old cow. It may be from D. *runnen*, to contract.—See RUNNET.] Any animal small below the natural or usual size of the species.

Of tame pigeons, are *croppers*, *carriers* and *runts*.

*Walton.*

RUPEE', *n.* [Pers. *ropah*, silver, and *ropiah*, is a thick round piece of money in the Mogul's dominions, value 24 stivers. *Castle*.] A silver and also a gold coin current in various parts of Asia and in the islands of the Eastern archipelago. Its value varies in different localities, as also with the course of exchange. For ordinary calculations the silver rupee current in the East Indies may be taken as equivalent to



Runcinate Leaf.

two shillings.—*Lac of rupees*, is 100,000 rupees.

**RUPERT'S DROPS**, *n.* Pieces of glass, which, being let fall into water when in a state of fusion, acquire a long oval form, tapering to a point; which point being afterwards broken off with the fingers, the whole of the drop is thereby made to burst into minute parts with a loud explosion. This singular phenomenon has been accounted for thus. The outside of the drop is suddenly contracted, hardened, and rendered brittle, whilst the interior, cooling slowly, retains its elasticity, so that when the point is broken off, the interior portion by its elastic force bursts the exterior covering; but no satisfactory explanation of this phenomenon has yet been given. These drops are said to have been first invented by Prince Rupert; hence the name.

**RUPICOLA**, *n.* A genus of insectorial birds termed rock manakins or cocks of



Orange Rock Cock (*Rupicola aurantia*).

the rock. Two species, *R. aurantia* and *R. peruviana*, inhabit South America. The adult males are of a most splendid orange colour.

**RUPPIA**, *n.* A genus of plants, nat. order Naiadaceae. There is only a single species and that is a native of Britain, viz., *R. maritima*, or sea-tassel grass, found in salt-water pools and ditches. It has a slender filiform leafy stem, with linear leaves, which are furnished with sheaths. Its flowers, which are two in number, and green, are seated one above another on opposite sides of a short spadix.

**RUPTION**, *n.* [*L. ruptio, rumpo*, to break.] Breach; a break or bursting open. [*Little used.*]

**RUPTURE**, *n.* [*Fr. from L. ruptus, rumpo*, to break.] 1. The act of breaking or bursting; the state of being broken or violently parted; as, the *rupture* of the skin; the *rupture* of a vessel or fibre.—2. Hernia; a preternatural protrusion of the contents of the abdomen.—[See HERNIA].—3. Breach of peace or concord; either between individuals or nations; between nations, open hostility or war. We say, the parties or nations have come to an open *rupture*.

He knew that policy would disinceline Napoleon from a *rupture* with his family.

*E. Everett.*

**RUPTURE**, *v. t.* To break; to burst: to part by violence; as, to *rupture* a blood-vessel.

**RUPTURE**, *v. i.* To suffer a breach or disruption.

**RUPTURED**, *pp.* Broken: burst.

**RUPTURE-WORT**, *n.* A genus of plants, *Herniaria*, [*which see.*]

**RUP'TURING**, *ppr.* Breaking; bursting.

**RURAL**, *a.* [*Fr. from L. ruralis*, from *rus*, the country.] Pertaining to the country, as distinguished from a city or town; suiting the country, or resembling it; as, *rural* scenes; a *rural* prospect; a *rural* situation; *rural* music. *Rural economy*, the general management of territorial property either by the proprietor or his agent. It comprehends whatever tends to the improvement of land for the purposes of grazing or agriculture, either by renovating the soil by manure, the arrangement of crops, or the management of the produce.

**RURAL ARCHITECTURE**, *n.* That branch of architecture which relates to the construction of buildings in the country, such as noblemen's and gentlemen's seats, farm houses, cottages, &c.

**RURAL DEAN**, *n.* One who formerly, under the bishop and the archdeacon, had the peculiar care and inspection of the clergy and laity of a district, now called a *deanery*.

**RURALIST**, *n.* One that leads a rural life.

**RURALITY**, *n.* Ruralness. [*Unusual.*]

**RURALLY**, *adv.* As in the country.

**RURALNESS**, *n.* The quality of being rural.

**RURICOLIST**, *† n.* [*L. ruricola; rus*, the country, and *colo*, to inhabit.] An inhabitant of the country.

**RURIGENOUS**, *† a.* [*L. rus*, the country, and *gignor*, to be born.] Born in the country

**RUS'CUS**, *n.* A genus of plants, nat. order Liliaceae, section Asparageae, and known by the common name of butcher's broom. The species of this genus are evergreen, and on this account are frequently introduced for under growth in shrubberies. *R. aculeatus*, common butcher's broom, is found wild in Britain.

**RUSE**, *n.* [*Fr.*] Artifice; trick; stratagem; wile; fraud; deceit.—*Ruse de guerre*, *ruze de gâr* [*Fr.*] A stratagem of war.

**RUSH**, *n.* [*Sax. rics* or *risc*; probably *L. ruscus*. The Swedish corresponding word is *saf*, the Hebrew *רִשָּׁה*, *sâph*, usually rendered sea-weed, and applied to the Arabic gulf; Dent. i. 1; Numb. xxi. 14. This correspondence deserves notice, as illustrating certain passages in the Scriptures.] 1. The common name of the species of *Juncus*, a genus of plants, nat. order Juncaceae. The genus is distinguished by its inferior perianth, composed of six glumaceous leaves; its three-celled, three-valved capsules; the seed-bearing dissepiments of the valves being in their middle. The species are numerous, and found chiefly in moist boggy situations in the colder parts of the world. *J. effusus*, the soft rush, and *J. conglomeratus*, the common rush, are used in many parts of the country for plaiting into mats, chair bottoms, and for constructing small toy baskets. The wicks also of the candles, called rush-candles, are made from the pith, as also the wicks of common lamps. Twenty species of rush are enumerated by British botanists, including the two above mentioned. Various species are frequently very troublesome weeds in agriculture. The term *rush* is however applied to plants of various other genera beside *Juncus*, and by no means to all of the genus

*Juncus*.—2. Any thing proverbially worthless or of trivial value.

John Bull's friendship is not worth a *rush*. [*Arbutnot.*]

**RUSH**, *v. i.* [*Sax. reosan, hreosan, or rasan; G. rauschen; Gr. ῥέω*. The *G.* has also *brausen*, the Dutch *bruischen*, to rush or roar; Dan. *brusen*, to rush. The Welsh has *brysiaw* and *crysiaw*, to hurry, to hasten; both from *rhus*, a rushing; *rhyisiaw*, to rush. We have *rustle* and *brustle* probably from the same source. The Welsh *brysiaw*, seems to be the English *press*.] 1. To move or drive forward with impetuosity, violence, and tumultuous rapidity; as, armies *rush* to battle; waters *rush* down a precipice; winds *rush* through the forest. We ought never to *rush* into company, much less into a religious assembly.—2. To enter with undue eagerness, or without due deliberation and preparation; as, to *rush* into business or speculation; to *rush* into the ministry.

**RUSH**, *† v. t.* To push forward with violence.

**RUSH**, *n.* A driving forward with eagerness and haste; a violent motion or course; as, a *rush* of troops; a *rush* of winds.

**RUSH-BEARING**, *a.* Bearing or producing rushes.

**RUSH-BEARING**, *n.* Another name in some parts of England for the country wake or Feast of Dedication, when the parishioners strewed the church with rushes and sweet-smelling flowers.—[See WAKE.]

**RUSH-BOTTOMED**, *a.* Having a bottom made with rushes.

**RUSH-CANDLE**, *n.* A small blinking taper made by stripping a rush, except one small strip of the bark which holds the pith together, and dipping it in tallow.

**RUSH'ED**, *a.* Abounding with rushes.

**RUSH'ER**, *n.* One who rushes forward.—2. One who formerly strewed rushes on the floor at dances.

**RUSH'INESS**, *n.* [from *rushy*.] The state of abounding with rushes.

**RUSH'ING**, *ppr.* Moving forward with impetuosity.

**RUSH'ING**, *n.* A violent driving of any thing; rapid or tumultuous course; *Is. xvii.*

**RUSH-LIGHT**, *n.* The light of a rush-candle; a small feeble light.—2. A rush candle, [*which see.*]

**RUSH-LIKE**, *a.* Resembling a rush; weak.

**RUSH'WHEAT**, *n.* A species of *Triticum*, the *T. junceum*, called also sea-wheat-grass. It is a British plant, which grows on sand on the sea-coast along with *arundo arenaria*.

**RUSH'Y**, *a.* Abounding with rushes.—2. Made of rushes.

My *rushy* couch and frugal fare.

*Goldsmith.*

**RUSK**, *n.* A kind of light cake.—2. Hard bread for stores.

**RUS'MA**, *n.* A brown and light iron substance, with half as much quicklime steeped in water, of which the Turkish women make their psilothron to take off their hair.

**RUSS**, *a.* (roos.) [*Sw. ryss.*] Pertaining to the Russ or Russians. [The native word is *Russ*. We have *Russia* from the south of Europe.]

**RUSS**, *n.* (roos.) The language of the Russ or Russians.

**RUS'SET**, *a.* [*Fr. roux, rousse*, red; *L. rusus*.—See RED and RUDDY.] 1. Of

a reddish brown colour; as, a *russet* mantle.

Our summer such a *russet* livery wears.  
*Dryden.*

2. Coarse; homespun; rustic.

RUS'SET, *n.* A country dress.

RUS'SET, } *n.* A kind of apple of  
RUS'SETING, } a russet colour and  
rough skin.

RUS'SETY, *a.* Of a russet colour.

RUS'SIA or RUS'SIAN LEATHER, *n.*  
[*Fr. roussi; cuir rouge de Russie; Ger. juften.*] An esteemed leather of a tawny colour and emitting a peculiar odour, extensively used in binding books or for covers of pocket-books, portfolios, &c. The inferior kinds of it are black and much used in Russia for the uppers of boots and shoes. It is said to be made from the hides of cattle under three years old, tanned with birch sprigs and not oak bark; but the process of its preparation is little known and not successfully practised out of Russia itself.

RUS'SIAN, *a.* Pertaining to Russia.

RUS'SIAN, *n.* A native of Russia.

RUS'SUD, *n.* In the *East Indies*, a progressively increasing land-tax, or *Jumma*.

RUST, *n.* [*Sax. rust; D. roest; G. and Sw. rost; Dan. rust; W. rhud; Gr. ῥυτίσις;* probably from its colour, and allied to *ruddy, red*, as *L. rubigo* is from *rubeo*.—*See Ruddy.*] 1. The red pulverulent substance which is formed on the surface of iron, when exposed to air and moisture. It is an oxide of iron, and in point of fact other metallic oxides may be considered as *rusts* of the peculiar metals on which they are formed, but the term *rust* in the common acceptation is limited to the red oxide or peroxide of iron. Oil-paint, varnish, plumbago, a film of caoutchouc, or a coating of tin may be employed, according to circumstances, to prevent the rusting of iron utensils. All metals except rhodium, gold, and platinum are liable to *rust*.—2. Loss of power by inactivity, as metals lose their brightness and smoothness when not used.—3. Any foul matter contracted; as *rust* on corn or salted meat.—4. Foul extraneous matter; as, sacred truths cleared from the *rust* of human mixtures.—5. A disease in grain, a kind of dust which gathers on the stalks and leaves; in reality, a parasitic fungus or mushroom.

RUST, *v. i.* [*Sax. rustian; W. rhydu.*] 1. To contract rust; to be oxidized and contract a roughness on the surface.

Our armours now may *rust*. *Dryden.*

2. To degenerate in idleness; to become dull by inaction.

Must I *rust* in Egypt. *Dryden.*

3. To gather dust or extraneous matter.

RUSTIC, *v. t.* To cause to contract rust.

Keep up your bright swords, for the dev. will *rust* them. *Shak.*

2. To impair by time and inactivity.

RUSTY-COLOURED, *a.* Having the colour of rust.

RUSTED, *pp.* Affected with rust.

RUSTIC, } *a.* [*L. rusticus, from rus,*

RUSTICAL, } the country.] 1. Pertaining to the country; rural; as, the *rustic* gods of antiquity.—2. Rude; unpolished; rough; awkward; as, *rustic* manners or behaviour.—3. Coarse; plain; simple; as *rustic* entertainment; *rustic* dress.—4. Simple; honest; artless; unadorned.—*Rustical* is little used.—*Rustic work*, in a building, is when the stones, &c., in the face of it are hacked or picked in holes, so as to

give them a natural rough appearance. This sort of work is however now

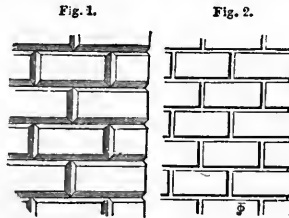

Rustic Work

1. With chamfered joints. 2. With rectangular joints.

usually called *rock*, and the term *rustic* is applied to masonry worked with grooves between the courses, to look like open joints, of which there are several varieties. The same term is applied to walls built of stones of different sizes and shapes.

RUSTIC, *n.* An inhabitant of the country; a clown; a swain.—2. *Rustic work*, [*See the adjective.*]

RUSTICALLY, *adv.* Rudely; coarsely, without refinement or elegance.

RUSTICALNESS, *n.* The quality of being rustic; rudeness; coarseness; want of refinement.

RUSTICATE, *v. i.* [*L. rusticor, from rus.*] To dwell or reside in the country.

RUSTICATE, *v. t.* To compel to reside in the country; to banish from a town or college for a time.

RUSTICATED, *pp.* Compelled to reside in the country.—*Rusticated work*, in *arch.* [*See Rustic.*]

RUSTICATING, *ppr.* Compelling to reside in the country.

RUSTICATION, *n.* Residence in the country.—2. In *universities and colleges*, the punishment of a student for some offence, by compelling him to leave the institution and reside for a time in the country.—3. In *arch.*, that species of building called *rustic work*,—*which see.*

RUSTICITY, *n.* [*L. rusticitas; Fr. rusticité.*] The qualities of a countryman; rustic manners; rudeness; coarseness; simplicity; artlessness.

RUSTIC-LOOKING, *a.* Appearing to be rustic.

RUSTIC ORDER, *n.* In *arch.*, a species of building in which the faces of the stones are hatched or picked with the point of a hammer. [*See Rustic.*]

RUSTIC QUOINS, or COINS, *n.* In *arch.*, the stones which form the external angles of a building when they project beyond the naked of the walls.

RUSTILY, *adv.* In a rusty state.

RUSTINESS, *n.* [*from rusty.*] The state of being rusty.

RUSTING, *ppr.* Contracting rust; causing to rust.

RUSTLE, *v. i.* (*rus' l.*) [*Sax. hrustlan; G. rasseln; Sw. rossla, to rattle.*] To make a quick succession of small sounds, like the rubbing of silk cloth or dry leaves; as, a *rustling* silk; *rustling* leaves or trees; *rustling* wings.

He is coming, I hear the straw *rustle*.

*Shak.*

RUSTLER, *n.* One who rustles.

RUSTLING, *ppr.* Making the sound of silk cloth when rubbed.

RUSTLING, *n.* A quick succession of small sounds, as a brushing among dry leaves or straw.

RUSTRE, *n.* In *her.*, a lozenge, pierced, of a circular form in the middle, the field appearing through it.



Lozenge Rustre.

RUSTY, *a.* Covered or affected with rust; as, a *rusty* knife or sword.—2. Dull; impaired by inaction or neglect of use.—3. Surly;

morose.—4. Covered with foul or extraneous matter.

RUT, *n.* [*Fr. rut; Arm. rut, the verb, rudal, ruten;* probably allied to *G. retzen, to excite, or Sw. ryta, to bel-low.*] The copulation of deer and some other animals.

RUT, *v. i.* To desire to come together for copulation.

RUT, *n.* [*It. rotaia, from L. rota, a wheel, or from Eng. rout.*] The track of a wheel.—2. A line cut on the soil with a spade.

RUT, *v. t.* In *husbandry*, to cut a line on the soil with a spade.

RUTEA, *n.* A genus of plants. [*See Rue.*]

RUTABAGA, *n.* The Swedish turnip, or *Brassica campestris*.

RUTA'CEÆ, *n.* A nat. order of poly-petalous exogens, consisting of trees, small shrubs, or herbaceous plants.

There are two principal divisions of this order, *Ruteæ* proper and *Diosmeæ*. The *Ruteæ* are characterized by their powerful odour and their bitterness, as for example *Ruta graveolens*, or common rue. [*See Rue.*] The *Diosmas* or *Bucka* plants of the Cape are well known for their powerful and usually offensive odour; they are recommended as antispasmodics. A South American species (*Galipea officinalis*), produces the Angostura bark. The bark of one of the *Quinas* of Brazil, the *Ticorea febrifuga*, is a powerful medicine in intermittent fevers. *Dictamnus* abounds in volatile oil to such a degree, that the atmosphere surrounding it actually becomes inflammable in hot weather.

RUTH, *n.* In the *East Indies*, a carriage on two low wheels drawn by bullocks.

RUTH,† *n.* [*from rue.*] Mercy; pity; tenderness; sorrow for the misery of another.—2.† Misery; sorrow.

RUTHENUS, *n.* The specific name of a fish of the genus *Acipenser*, the sterlet.

RUTHFUL,† *a.* Rueful; woful; sorrowful.—2.† Merciful.

RUTHFULLY,† *adv.* Wofully; sadly;—2.† Sorrowfully; mournfully.

RUTHLESS, *a.* Cruel; pitiless; barbarous; insensible to the miseries of others.

Their rage the hostile bands restrain,  
All but the *ruthless* monarch of the main.

*Pope.*

RUTHLESSLY, *adv.* Without pity; cruelly; barbarously.

RUTHLESSNESS, *n.* Want of compassion; insensibility to the distresses of others.

RUTIL, } *n.* Titanic acid, of a dark  
RUTILE, } red colour, or of a light  
or brownish red. It occurs massive, disseminated, membranous, and in crystals.

RUTILANT, *a.* [*L. rutilans, rutilo, to shine; perhaps from the root of red, ruddy.*] Shining.

RUTILATE,† *v. i.* [*L. rutilo.*] To shine; to emit rays of light.

**RUTILINE**, *n.* The name given by Braconnot to the product of the decomposition of salicine by strong sulphuric acid. When pure it is brownish-red, with a tinge of yellow when moist; dark-brown when dry; brittle, tasteless, insoluble in water and alcohol.

**RUTILITE**, *n.* [*L. rutilus*, red.] Native oxide of titanium.

**RUTTER**, *n.* [*G. reiter*, *D. ruter*, a rider. See RIDER.] A horseman or trooper.

**RUTTERKIN**, *n.* A word of contempt; an old crafty fox or beguiler.

**RUTIER**, *n.* [*Fr. routier*, from *route*.] A direction for the route, or road, whether by land or sea; an old traveller acquainted with roads; an old soldier.

**RUTTING**, *ppr.* Copulating as deer.

**RUTTISH**, *a.* [from *rut*.] Lustful; libidinous.

**RUTTLE**, for *Rattle*, not much used.

**RYACOLITE**, *n.* [*ῥυαζ*, a stream, and *λίθος*, a stone.] A name given to glossy felspar.

**RYAL**, *n.* A coin. [See RIAL.]

**RYDER**, *n.* A clause added to a bill in parliament. [See RIDER and RIDER.]

**RYE**, *n.* [*Sax. ryge*; *G. rochen*; *W. rhyg*.] This word is the English rough. 1. A plant of the genus

*Secale*, the *S. cereale*, nat. order Gramineæ. It is an esculent grain which bears naked seeds on a flat ear, furnished with awns like barley. It has been cultivated from time immemorial, and is considered as coming nearer in its properties to wheat than any other grain. It is more common than wheat in many parts of the continent, being a more certain crop, and requiring less culture and manure. It is the bread corn of Germany and Russia. It was formerly raised in considerable quantities as a bread corn in England, but now it is mostly sown as a green crop for food to sheep and cattle in spring. In the Netherlands, it is the chief grain from which the spirit called Hollands is distilled, and when malted it makes excellent beer. Two parts of wheat and one of rye ground together make an excellent bread. Rye straw is use-



Rye (*Secale cereale*).

less as fodder, but forms an excellent material for thatching. It is also used for stuffing horse-collars, for mattresses, and for making straw-hats and bonnets. The meal of rye differs from that of wheat in containing a much smaller proportion of gluten. *Spurred rye*. [See ERGOT.]—2. A disease in a hawk.

**RYE-GRASS**, *n.* One of the most common of the artificial grasses. It is of the genus *Lolium* (*L. perenne*). There are several varieties, some annual, others perennial; some producing a strong juicy grass, and others a small diminutive plant. In the present system of husbandry, rye grass performs a very essential part, especially the perennial sort, which, mixed with different varieties of clover and other grass seeds, produces a rich and close herbage, which may be either mown for hay or depastured.

**RYOT**, *n.* In Hindostan, a renter of land by a lease which is considered as perpetual, and at a rate fixed by ancient surveys and valuations. The ryots or peasants may be considered as the cultivators of the soil in India, having a perpetual hereditary and transferable right of occupancy, so long as they continue to pay the share of the produce of the land demanded by the government.

## S

**S** THE nineteenth letter of the English Alphabet, is a sibilant articulation, and numbered among the semi-vowels. It represents the hissing made by driving the breath between the end of the tongue and the roof of the mouth, just above the upper teeth. It has two uses; one to express a mere hissing, as in *sabbath*, *sach*, *sin*, *this*, *thus*; the other a vocal hissing, precisely like that of *z*, as in *muse*, *wise*, pronounced *muze*, *wize*. It generally has its hissing sound at the beginning of all proper English words, but in the middle and end of words, its sound is to be known only by usage. In a few words it is silent, as in *isle* and *viscount*. In abbreviations, S. stands for *societas*, society, or *socius*, fellow; as, F. R. S. fellow of the Royal Society. S. or St. for *saint*; S. or Sec. for *seconds*; Sec. for *secretary*; S. or Sh. for *shillings*. S. T. P. for *sanctæ theologiæ professor*, professor of sacred theology. In medical prescriptions, S. A. signifies *secundum artem*, according to the rules of art. In the notes of the ancients, S. stands for *sextus*; Sp. for *spurius*; S. C. for *senatus consultum*; S. P. Q. R. for *senatus populusque Romanus*; the Roman senate and people. S. S. S. for *stratum super stratum*, one layer above another alternately; [S. V. B. E. E. Q. V. for *si vales, bene est, ego quoque valeo*.] As a numeral, S. denoted seven. In the Italian music, S. signifies *solo*. In books of navigation and in common usage, S. stands for south; S. E. for south-east; S. W. for south-west; S. S. E. for south-south-east; S. S. W. for south-south-west, &c.

**SABADILLA**. See CEVADILLA.

**SABADILLIC ACID**. See CEVADIC ACID.

**SABADIL'LINE**, *n.* A vegetable base discovered by Couerbe in *Veratrum Sabadilla*.

**SABA'IAN**, or **SABÆ'AN**, *a.* See SABIAN.

**SABAISM**. See SABIANISM.

**SABAL**, *n.* A genus of palms, natives of the tropics. Some of them are lofty trees, and one, the *S. palmetto*, is perhaps the smallest of all the palm tribe.

**SAB'AOTH**, *n.* [*Heb. צבאות*, *tzabaoth*, armies, from *צבא*, *tzaba*, to assemble, to fight. The primary sense is to drive, to urge, or crowd.] Armies, hosts; a word used, Rom. ix. 29, James v. 4, "the Lord of *Sabaoth*."

**SABBATA'RIAN**, *n.* [from *sabbath*.] One who observes the seventh day of the week as the sabbath, instead of the first. A sect of baptists are called *sabbatarians*. They maintain that the Jewish sabbath has not been abrogated.—2. One who observes the sabbath with unreasonable rigour.

**SABBATA'RIAN**, *a.* Pertaining to those who keep Saturday, or the seventh day of the week as the sabbath.

**SABBATA'RIANISM**, *n.* The tenets of sabbatarians.

**SAB'BATH**, *n.* [*Heb. שבת*, *shabath*, to cease, to rest; as a noun, cessation, rest, *L. sabbatum*; *Ar. sabata*.] 1. The day which God appointed to be observed as a day of rest from all secular labour or employments, and to be kept holy and consecrated to his service and worship. This was originally the

seventh day of the week, the day on which God rested from the work of creation; and this day is still observed by the Jews and some Christians, as the sabbath. But the Christian church very early began and still continue to observe the first day of the week, in commemoration of the resurrection of Christ on that day, by which the work of redemption was completed. Hence it is often called the *Lord's day*. The heathen nations in the north of Europe dedicated this day to the *sun*, and hence their Christian descendants continue to call the day *Sunday*. *Sabbath* is not strictly synonymous with *sunday*. *Sunday* is the mere name of the day; *sabbath* is the name of the institution. *Sunday* is the *sabbath* of Christians; *Saturday* is the *sabbath* of the Jews.—2. Intermission of pain or sorrow; time of rest.

Peaceful sleep out the *sabbath* of the tomb. Pope.

3. The sabbatical year among the Israelites; Lev. xxv.

**SAB'BATH-BREAKER**, *n.* [*sabbath* and *break*.] One who profanes the sabbath by violating the laws of God or man which enjoin the religious observance of that day.

**SAB'BATH-BREAKING**, *n.* A profanation of the sabbath by violating the injunction of the fourth commandment, or the municipal laws of a state which require the observance of that day as a holy time. All unnecessary secular labour, visiting, travelling, sports, amusements, and the like, are considered as *sabbath-breaking*.

**SAB'BATHLESS**, *a.* Having no sabbath; without intermission of labour.



**SABBA'TIA**, *n.* A genus of North American plants, nat. order Gentiana-ceæ. There are several species, all characterized by the possession of a pure bitter principle, on which account they are extensively used in North America in intermittent and remittent fevers, and as tonics. The species most used is *S. angularis*, which grows in damp wet soils in the United States, and is common in moist meadows among high grass.

**SABBAT'IC**, } *a.* [Fr. *sabbatique* ;  
**SABBAT'ICAL**, } *L. sabbaticus.*] 1. Pertaining to the sabbath.—2. Resembling the sabbath; enjoying or bringing an intermission of labour.—*Sabbatical year*, in the Jewish economy, was every seventh year, in which the Israelites were commanded to suffer their fields and vineyards to rest, or lie without tillage, and the year next following every seventh sabbatical year in succession, that is, every fiftieth year, was the jubilee, which was also a year of rest to the lands, and a year of redemption or release; Lev. xxv.

**SAB'BATISM**, *n.* Rest; intermission of labour.

**SABE'AN**. See **SABIAN**.

**SA'BEISM**, } *n.* The same as *Sabian*-  
**SA'BAISM**, } *ism.*

**SABEL'LA**, *n.* A genus of marine articulated animals belonging to the order Tubicola of Cuvier. The species are large, and their fan-like branchiæ remarkable for their delicacy and brilliancy. *S. protula* is a large and splendid species inhabiting the Mediterranean. Its tube is calcareous.

**SABELLI'AN**, *a.* Pertaining to the heresy of Sabellius.

**SABELLI'AN**, *n.* A follower of Sabellius, a philosopher of Egypt in the third century, who openly taught that there is one person only in the Godhead, and that the Word and Holy Spirit are only virtues, emanations, or functions of the Deity.

**SABELLI'ANISM**, *n.* The doctrines or tenets of Sabellius.

**SA'BIA**, *n.* A genus of plants named by Colebrook from the Indian name *sabja* of one of the species. The species form ornamental climbing shrubs, with smooth lanceolate alternate leaves, well suited to the shrubberies of this country.

**SA'BIAN**, } *a.* Pertaining to Saba, in  
**SABE'AN**, } Arabia, celebrated for producing aromatic plants.

**SA'BIAN**, **SABE'AN**, or **SABA'IAN**, *a.* [Heb. סבא, *izaba*, an army or host.] The Sabian worship or religion consisted in the worship of the sun and other heavenly bodies.

**SA'BIAN**, *n.* A worshipper of the sun.  
**SA'BIANISM**, or **SA'BAISM**, *n.* That species of idolatry which consisted in worshipping the sun, moon, and stars. This idolatry existed in Chaldea or Persia at an early period of the world, and was propagated by the inhabitants who migrated westward into Europe, and continued among our ancestors till they embraced the Christian religion.

**SA'BIAN**, *n.* A Christian sect also called Christians of St. John, on account of their attachment to the baptism of that forerunner of Christ. This sect, according to tradition, has existed from the time of John the Baptist.

**SAB'INE**, *n.* A plant; usually written *Savin*,—*which see*.—2. A small fish,

which is sometimes preserved in oil for food.

**SA'BLE**, *n.* [Russ. *sobol*; G. *zobel*; Sw. Dan. and D. *sabel*; Fr. *zibeline*; L. *zobota* or *zobola*, an ermine. This word and the animal were probably not known to the Greeks and Romans till a late period. Jornandes mentions the sending to Rome, in the 6th century, *saphyllinas pelles*, sable skins; and Marco Polo calls them *zebelines* and *zombolines*.] 1. A digitigrade carnivorous mammal; a small animal of the weasel kind, the *Mustela zibellina*, found chiefly in the northern regions of Asia, and hunted for its fur. It resembles the marten, but has a longer head and ears. Its hair is



Sable (*Mustela zibellina*).

cinereous, but black at the tips. This animal burrows in the earth or under trees; in winter and summer subsisting on small animals, and in autumn on berries. The fur is very valuable, and a single skin of the darker colour, though not above four inches broad, has been valued as high as £15. The sable is hunted and killed for the Russian market, by exiles or soldiers sent for that purpose, in the deserts of Siberia. Another species of *mustela*, the *M. canadensis*, or fisher, inhabits North America, and is similarly sought after and destroyed for its fur.—2. The fur of the sable.

**SA'BLE**, *a.* [Fr. Qu. Gr. ζαβίς, darkness. See the noun.] Black; dark; used chiefly in poetry or in heraldry; as,

night with her sable mantle; the sable throne of night. In her, sable is one of the colours or tinctures employed in blazonry. It is equivalent to diamond among precious stones, Saturn among planets. In engravings it is expressed by perpendicular and horizontal lines.

**SA'BLE-STOLED**, *a.* Wearing a sable stole or vestment.

**SAB'LIÈRE**, *n.* [Fr. from *sable*, sand, L. *sabulum*.] 1. A sand-pit. [*Not much used*.] 2. In *carpentry*, a piece of timber as long, but not so thick as a beam.

**SABOT**, *n.* [Fr. *sabot*; Sp. *zapato*.] A kind



Sabot.

of wooden shoe worn by the peasantry in France, Belgium, &c. [*Not English*.]

**SA'BRE**, *n.* [Fr. *sabre*; Arm. *sabrenn*, *scibla*; Sp. *sable*; D. *sabel*; G. *säbel*. Qu. Ar. *sabba*, to cut.] A sword or scimitar with a broad and heavy blade, thick at the back, and a little falceated or hooked at the point; a falchion.

**SA'BRE**, *v. t.* To strike, cut, or kill with a sabre. A small party was surprised at night and almost every man *sabred*.  
**SA'BRED**, *pp.* Struck or killed with a sabre.

**SABRETA'CHE**, *n.* (tash.) [G. *tasche*, a pocket.] A leathern case or outside pocket worn by cavalry at the left side, suspended from the sword-belt.

**SA'BRING**, *ppr.* Striking or killing with a sabre.

**SABULOS'ITY**, *n.* [from *sabulous*.] Sandiness; grittiness.

**SAB'ULOUS**, *a.* [L. *sabulosus*, from *sabulum*, sand.] Sandy; gritty. A term often applied to the calcareous matter deposited by urine.

**SAC**, *n.* [Sax. *sac*, *saca*, *suce* or *sacu*, contention. This is the English *sake*—*which see*.] In *English law*, the privilege enjoyed by the lord of a manor, of holding courts, trying causes and imposing fines.

**SAC**, *n.* [L. *saccus*.] A bag or cyst.

**SAC'BUT**. See **SACKBUT**.

**SACC'ADE**, *n.* [Fr. *a jerk*.] A sudden violent check of a horse by drawing or twitching the reins on a sudden and with one pull; a correction used when the horse bears heavy on the hand. It should be used discreetly.

**SAC'EATE**, *a.* [L. *saccus*, a bag.] Bagged; having a bag or pouch, as a *saccate* petal.

**SAC'CHARIC ACID**, *n.* An uncrystallizable acid product, formed along with oxalic acid during the action of nitric acid on sugar.

**SACCHARIF'EROUS**, *a.* [L. *saccharum*, sugar, and *fero*, to produce.] Producing sugar; as *sacchariferous* canes. The maple is a *sacchariferous* tree.

**SACCHA'RIFY**, *v. t.* To convert into sugar.

**SAC'CHARINE**, *a.* [from Ar. Pers. *sahar*; Gr. σακχαρ: L. *saccharum*, sugar.] Pertaining to sugar; having the qualities of sugar; as, a *saccharine* taste; the *saccharine* matter of the cane juice.—*Saccharine fermentation*. [See **FERMENTATION**.]

**SAC'CHAROID**, } *a.* [L. *saccha*-  
**SACCHAROID'AL**, } *rum*, and *ειδος*, form.] Having a texture resembling that of loaf sugar; as *saccharoid* carbonate of lime, &c.

**SACCHARO'METER**, *n.* [L. *saccharum*, and *μετρον*, a measure.] An instrument for determining the specific gravity of brewers' and distillers' worts. It is formed on the same principle as the Hydrometer.

**SAC'CHARO-SULPHURIC ACID**, *n.* A compound of sugar with sulphuric acid.

**SAC'CHARUM**, *n.* [L. sugar.] A genus of plants, nat. order Gramineæ. The species are widely distributed through the tropical parts of the world, and are distinguished by their highly ornamental nature and by the light and feathery or rather silk-like inflorescence. *S. officinarum*, or sugar-cane, the best known species or that yielding sugar in India, is cultivated in all parts of that country, and several varieties are known. It was intro-

duced into the south of Europe and the Canaries, and thence into the West Indies. [See SUGAR.]

**SACCHARUM SATURNI.** Acetate of lead or sugar of lead.

**SACCHOLACTATE, n.** In *chem.*, a salt formed by the union of the saccholatoic acid with a base.

**SACCHOLACTIC, a.** [L. *saccharum*, sugar, and *lac*, milk.] A term in chemistry, denoting an acid obtained from the sugar of milk; now called *muete acid*.

**SACCHULMIC ACID, n.** An acid obtained by boiling sugar with dilute sulphuric acid. When dry it is a light brown powder, soluble in ammonia and the fixed alkalis, giving them a brown colour.

**SACCHULMINE, n.** A substance obtained by boiling for a very long time cane sugar in very diluted sulphuric, hydrochloric, or nitric acids. It is deposited in brown scales, crystalline and brilliant, which are always contaminated with Sacchulmic acid. The latter is easily removed by ammonia.

**SACCOLABIUM, n.** An Asiatic genus of plants, nat. order Orchidaceæ, now extensively cultivated in hot-houses. It consists of caulescent epiphytes, with two-rowed coriaceous leaves and axillary flowers.

**SACELLUM, n.** [L.] In *ancient Roman arch.*, a small enclosed space without a roof, consecrated to some deity. In *medieval arch.*, the term signifies a monumental chapel within a church; also a small chapel in a village.

**SACERDOTAL, a.** [L. *sacerdotalis*, from *sacerdos*, a priest. See SACRED.] Pertaining to priests or the priesthood; priestly; as *sacerdotal dignity*; *sacerdotal functions* or garments; *sacerdotal character*.

**SACERDOTALLY, adv.** In a sacerdotal manner.

**SACER MORBUS, n.** [L.] One of the names applied by the older writers to epilepsy.

**SACHEL, n.** See SATCHEL.

**SACHEM, n.** In America, a chief among some of the native Indian tribes. [See SAGAMORE.]

**SACHEMDOM, n.** The government or jurisdiction of a sachem.

**SACK, n.** [Sax. *sac*, *sacc*; G. *sack*; W. *sag*; Ir. *sac*; Fr. *sac*; L. *saccus*; Gr. *saxos*; Heb. *שק* *sak*. See the verb to *sack*.] 1. A bag, usually a large cloth bag, used for holding and conveying corn, small wares, wool, cotton, hops, and the like; Gen. xlii.—*Sack of wool*, in England, is 22 stone of 14 lbs. each, or 308 lbs. In Scotland, it is 24 stone of 16 lbs. each, or 384 lbs.—*A sack of cotton* contains usually about 300 lbs., but it may be from 150 to 400 lbs.—*A sack of flour* contains 280 lbs.—*Sack of earth*, in *fort.*, is a canvas bag filled with earth, used in making retrenchments in haste.—2. The measure of three bushels.

**SACK, n.** [Fr. *sec*, *seche*, dry.] A general name for the different sorts of dry wines, more especially the Spanish, which were first extensively used in England in the 16th century.—*Sherry sack*, the same as sherry; *Canary sack*, a dry wine from the Canaries.

**SACK, n.** [L. *sagum*, whence Gr. *σαγος*. But the word is Celtic or Teutonic; W. *segan*, a covering, a cloak.] Among our rude ancestors, a kind of cloak of a square form, worn over the shoulders and body, and fastened in front by a

clasp or thorn. It was originally made of skin, afterward of wool. In modern times, this name has been given to a woman's garment, a gown with loose plaits on the back; and also to a loose garment worn by men.

**SACK, v. t.** To put in a sack or in bags.

**SACK, v. t.** [Arm. *sacca*; Ir. *sacham*, to attack; Sp. and Port. *saquear*, to plunder or pillage; Sp. to ransack; Sp. and Port. *sacar*, to pull out, extort, dispossess; It. *saccheggiare*, to sack; Fr. *saccager*, to pillage; *saccade*, a jerk, a sudden pull.] To plunder or pillage, as a town or city. Rome was twice taken and sacked in the reign of one pope. This word is seldom or never applied to the robbing of persons, or pillaging of single houses, but to the pillaging of towns and cities; and as towns are usually or often sacked, when taken by assault, the word may sometimes include the sense of taking by storm.

The Romans lay under the apprehension of seeing their city *sacked* by a barbarous enemy. Addison.

**SACK, n.** The pillage or plunder of a town or city; or the storm and plunder of a town; as, the *sack of Troy*.

**SACK'AGE, n.** The act of taking by storm and pillaging.

**SACKBARROW, n.** A kind of barrow much used for moving sacks in gra-

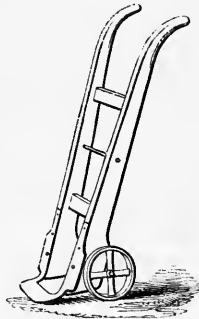

Sack Barrow.

naries or barn floors from one point to another, and for shipping goods.

**SACK'BUT, n.** [Sp. *sacabuche*; the tube or pipe of a pump, and a sackbut; Port. *sacabuxa* or *saquebuxo*; Fr. *saquebute*. The last syllable is the L. *buxus*.] A wind instrument of music; a kind of trumpet, so contrived that it can be lengthened or shortened according to the tone required. It is in fact the *Trombone* of the Italians.—In *scrip.*, a kind of harp or lyre. *Kitto*, *Cyc. of Bib. Lit.*

**SACK'CLOTH, n.** [sack and cloth.] Cloth of which sacks are made; coarse cloth. This word is chiefly used in Scripture to denote a cloth or garment worn in mourning, distress or mortification.

Gird you with *sackcloth* and mourn before Abner. 2 Sam. iii. Esth. iv. Job xvi.

**SACK'CLOTHED, a.** Clothed in sackcloth.

**SACK'ED, pp.** Pillaged; stormed and plundered.

**SACK'ER, n.** One that takes a town or plunders it.

**SACK'FUL, n.** A full sack or bag.

**SACK'ING, ppr.** Taking by assault and plundering or pillaging.

**SACK'ING, n.** The act of taking by storm and pillaging.

**SACK'ING, n.** [Sax. *sæcing*, from *sac*, *sacc*.] 1. Cloth of which sacks or bags are made.—2. The coarse cloth or canvas fastened to a bedstead for supporting the bed.

**SACK'LESS, a.** [Sax. *sacless*, from *sac*, contention, and *less*, less.] Quiet; peaceable; not quarrelsome; harmless; innocent. [Local.]

**SACK-POS'SET, n.** [sack and *posset*.] A posset made of sack, milk, and some other ingredients.

**SACOME, n.** [Ital.] In *arch.*, the exact profile of a member or moulding. Applied by the French to the mouldings themselves.

**SACRAL, a.** Of or belonging to the *sacrum*; as *sacral arteries*, veins, nerves, &c.

**SACRAMENT, n.** [Fr. *sacrement*; It. and Sp. *sacramento*; from L. *sacramentum*, an oath, from *sacer*, sacred.]

1. † Among *ancient Christian writers*, a mystery.—2. The military oath taken by every Roman soldier, by which he swore to obey his commander, and not desert his standard; a ceremony producing an obligation; but not used in this general sense.—3. In *present usage*, an outward and visible sign of inward and spiritual grace; or more particularly, a solemn religious ceremony enjoined by Christ, the head of the Christian church, to be observed by his followers, by which their special relation to him is created, or their obligations to him renewed and ratified. Thus baptism is called a *sacrament*, for by it persons are separated from the world, brought into Christ's visible church, and laid under particular obligations to obey his precepts. The eucharist or communion of the Lord's supper, is also a *sacrament*, for by commemorating the death and dying love of Christ, Christians avow their special relation to him, and renew their obligations to be faithful to their divine Master. When we use *sacrament* without any qualifying word, we mean by it,—4. The eucharist or Lord's supper.

**SACRAMENT, v. t.** To bind by an oath.

**SACRAMENTAL, a.** Constituting a sacrament or pertaining to it; as, *sacramental rites* or elements.

**SACRAMENTAL, n.** That which relates to a sacrament. *Sacramentals*, things relating to sacraments.

**SACRAMENTALLY, adv.** After the manner of a sacrament.

**SACRAMENTARIAN, n.** One that differs from the Romish church and the Lutherans in regard to the sacraments, or to the Lord's supper; a word applied by *Romanists* to *Protestants*; and by the followers of Luther in the sixteenth century to the followers of Zwingle.

**SACRAMENTARY, n.** An ancient book of the Romish church, written by Pope Gelasius, and revised, corrected, and abridged by St. Gregory, in which were contained all the prayers and ceremonies practised in the celebration of the sacraments.—2. A sacramentarian; a term of reproach applied by Papists to Protestants.

**SACRAMENTARY, a.** Pertaining to sacramentarians and to their controversy respecting the eucharist.

**SACRARIUM, n.** A sort of family chapel in the houses of the Romans, devoted to some particular divinity.

SA'CRATE, † *v. a.* [Lat. *sacro.*] To consecrate.

SA'CRE. See *SAKER.*

SA'CRE'D, *a.* [Fr. *sacré;* from *L. sacer*, sacred, holy, cursed, damnable; *W. segyr*, that keeps apart, from *seg*, that is without access; *segru*, to secrete, to separate. We here see the connection between *sacredness* and *secrecy.*] 1. Holy; pertaining to God or to his worship; separated from common secular uses and consecrated to God and his service; as, a *sacred* place; a *sacred* day; a *sacred* feast; *sacred* service; *sacred* orders.—2. Proceeding from God and containing religious precepts; as, the *sacred* books of the Old and New Testament.—3. Narrating or writing facts respecting God and holy things; as, a *sacred* historian.—4. Relating to religion or the worship of God; used for religious purposes; as, *sacred* songs; *sacred* music; *sacred* history.—5. Consecrated; dedicated; devoted; with *to*. A temple *sacred* to the queen of love.

*Dryden.*

6. Entitled to reverence; venerable. Poet and saint, to thee alone were given, The two most *sacred* names of earth and heaven. *Cowley.*

7. Inviolable, as if appropriated to a superior being; as, *sacred* honour or promise. Secrets of marriage still are *sacred* held.

*Dryden.*

Sacred majesty. † A title once in use, indicating the inviolability or sacredness of the persons of the kings of Britain. It occurs often in the *Ikon Bosilike*, meaning Charles the First.—*Sacred* place, in the civil law, is that where a deceased person is buried.

SA'CRE'D BEAN, *n.* A plant esteemed sacred in China and Japan. It is supposed to be the *Nelumbium speciosum*, a large petalled and splendid aquatic plant. [See *NELUMBIVM.*]

SA'CRE'DLY, *adv.* Religiously; with due reverence as of something holy or consecrated to God; as, to observe the Sabbath *sacredly*; the day is *sacredly* kept.—2. Inviolably; strictly; as, to observe one's word *sacredly*; a secret to be *sacredly* kept.

SA'CRE'DNESS, *n.* The state of being sacred, or consecrated to God, to his worship or to religious uses; holiness; sanctity; as, the *sacredness* of the sanctuary or his worship; the *sacredness* of the sabbath; the *sacredness* of the clerical office.—2. Inviolableness; as, the *sacredness* of marriage vows or of a trust.

SACRIFIC, } *a.* [L. *sacrificus.* See SACRIFICIAL.] SACRIFIC.] Employed in sacrifice.

SACRIFICABLE, *a.* Capable of being offered in sacrifice. [All formed, harsh and not used.]

SACRIFICANT, *n.* [L. *sacrificans.*] One that offers a sacrifice.

SACRIFICATOR, † *n.* [Fr. *sacrificateur.*] A sacrificer; one that offers a sacrifice.

SACRIFICATORY, *a.* Offering sacrifice.

SA'CRIFICE, *v. i.* (sac'rifize.) *L. sacrifico;* Fr. *sacrifier;* *L. sacer*, sacred, and *facio*, to make.] 1. To offer to God in homage or worship, by killing and consuming, as victims on an altar; to immolate, either as an atonement for sin, or to procure favour, or to express thankfulness; followed by *to*; as, to *sacrifice* to the Lord all that openeth the matrix; Exod. xiii.—2. To destroy, surrender, or suffer to be lost for the

sake of obtaining something; as, to *sacrifice* the peace of the church to a little vain curiosity. We should never *sacrifice* health to pleasure, nor integrity to fame.—3. To devote with loss. Condemn'd to *sacrifice* his childish years To babbling ignorance and to empty fears. *Prior.*

4. To destroy; to kill.

SA'CRIFICE, *v. i.* To make offerings to God by the slaughter and burning of victims, or of some part of them; Exod. iii. SA'CRIFICE, *n.* [Fr. from *L. sacrificium.*] 1. An offering made to God by killing and burning some animal upon an altar, as an acknowledgment of his power and providence, or to make atonement for sin, appease his wrath or conciliate his favour, or to express thankfulness for his benefits. *Sacrifices* have been common to most nations, and have been offered to false gods, as well as by the Israelites to Jehovah. A *sacrifice* differs from an *oblation*; the latter being an offering of a thing entire or without change, as tithes or first fruits; whereas *sacrifice* implies a destruction or killing, as of a beast. *Sacrifices* are *expiatory*, *impeetratory*, and *eucharistical*; that is, atoning for sin, seeking favour, or expressing thanks.—*Human sacrifices*, the killing and offering of human beings to deities, have been practised by some barbarous nations.—2. The thing offered to God, or immolated by an act of religion.

My life if thou preserv'st, my life

Thy *sacrifice* shall be. *Addison.*

3. Destruction, surrender, or loss made or incurred for gaining some object, or for obliging another; that which is given up for something else, deemed of more value; as, the *sacrifice* of interest to pleasure, or of pleasure to interest.—4. Any thing destroyed.

SA'CRIFICED, *pp.* Offered to God upon an altar; destroyed, surrendered, or suffered to be lost.

SA'CRIFICER, *n.* One that sacrifices or immolates.

SACRIFI'CIAL, *a.* Performing sacrifices; included in sacrifice; consisting in sacrifice.

SACRIFICING, *pp.* Offering to God upon an altar; surrendering, or suffering to be lost; destroying.

SA'CRILEGE, *n.* [Fr. from *L. sacrilegium;* *sacer*, sacred, and *lego*, to take or steal.] The crime of violating or profaning sacred things; or the alienating to laymen or to common purposes what has been appropriated or consecrated to religious persons or uses.

And the hid treasures in her sacred tomb

With *sacrilege* to dig. *Spenser.*

2. Church robbery, or the felonious taking of any goods out of any parish-church or any other church or chapel is sacrilege, and by common law was formerly a capital offence, but it is now put by statute on a footing with other felonies.

SACRILE'GIOUS, *a.* [L. *sacrilegus.*] 1. Violating sacred things; polluted with the crime of sacrilege.

Above the reach of *sacrilegious* hands. *Pope.*

2. Containing sacrilege; as, a *sacrilegious* attempt or act.

SA'CRILE'GIOUSLY, *adv.* With sacrilege; in violation of sacred things; as, *sacrilegiously* invading the property of a church.

SACRILE'GIOUSNESS, *n.* The quality of being sacrilegious.—2. Disposition to sacrilege.

SA'CRILEGIST, *n.* One who is guilty of sacrilege.

SA'CRING, † *pp.* [from Fr. *sacrer.*] Consecrating.

SA'CRING, *a.* Used in sacred offices.

SA'CRING-BELL, } *n.* In Roman ca-  
SA'CRING-BELL, } tholic times, the  
SA'CRINGE, } small bell that  
was rung on the elevation of the host during the service of high mass. It was usually placed on the gable at the east end of the nave, in a small sort of turret, or in a lantern or tower. A small silver bell carried in the hand is now used.

SA'CRIST, *n.* A sacristan or sexton.—2. A person retained in a cathedral to copy out music for the choir, and take care of the books.

SA'CRISTAN, *n.* [Fr. *sacristain;* It. *sacristano;* Sp. *sacristan;* from *L. sacer*, sacred.] An officer of the church who has the care of the utensils or moveables of the church. It is now corrupted into *sexton*.

SA'CRISTY, or SA'CRISTRY, *n.* [Fr. *sacristie;* Sp. and It. *sacristia;* from *L. sacer*, sacred.] An apartment in a church where the sacred utensils are kept, and the vestments in which the clergyman officiates are deposited; now called the *vestry*.

SA'CRISANCT, † *a.* [L. *sacrosanctus;* *sacer* and *sanctus*, holy.] Sacred; inviolable.

SA'CRUM, or OS SA'CRUM, *n.* [L.] In *anat.*, the bone which forms the basis of the vertebral column. Its shape has sometimes been compared to an irregular triangle.

SAD, *a.* [In *W. sad* signifies wise, prudent, sober, permanent. It is probable this word is from the root of *set*. We have not found the word, in the English sense, in any other language.] 1. Sorrowful; affected with grief; cast down with affliction.

Th' angelic guards ascended, mute and *sad*.

*Milton.*

*Sad* for their loss, but joyful of our life.

*Pope.*

2. Habitually melancholy; gloomy; not gay or cheerful.

See in her cell *sad* Eloisa spread. *Pope.*

3. Downcast; gloomy; having the external appearance of sorrow; as, a *sad* countenance. Matth. vi.—4. Serious; grave; not gay, light, or volatile.

Lady Catherine, a *sad* and religious woman.

*Bacon.*

5. Afflictive; calamitous; causing sorrow; as, a *sad* accident; a *sad* misfortune.—6. Dark coloured.

Woad or wade is used by the dyers to lay the foundation of all *sad* colours. *Mortimer.* [This sense seems to be entirely obsolete.]

7. In style, half burlesque; bad; vexatious; as, a *sad* husband; a *sad* fellow. [Col.]—8. Heavy; weighty; ponderous.

With that his hand more *sad* than lump of lead. †

*Spenser.*

9. Close; firm; cohesive; opposed to light or friable.

Chalky lands are naturally cold and *sad*. †

*Mortimer.*

[The two latter senses indicate that the primary sense is *set*, fixed; *W. sadiaw*, to make firm.]

SADDEN, *v. i.* (sad'n.) To make sad or sorrowful; also, to make melancholy or gloomy.—2. † To make dark coloured.—3. To make heavy, firm, or cohesive.

Marl is binding, and *saddening* of land is the great prejudice it doth to clay lands. †

*Mortimer.*

**SADDEN**, *v. i.* (sad'n.) To become sad or sorrowful; as, he *saddened* at the sight.

**SAD'DENED**, *pp.* Made sad or gloomy.

**SAD'DENING**, *ppr.* Making sad or gloomy.

**SAD'DER**, *n.* An abridgment of the Zendavesta in modern Persian.

**SAD'DER**, *a. comp.* of *Sad*.

**SADDLE**, *n.* (sad'l.) [Sax. *sadel*, *sadl*; *G. sattel*; *W. sadell*; *Ir. sadhall*; from the root of *sit*, *set*, *L. sedeo*, *sedile*.] 1. A seat to be placed on the horse's back for the rider to sit on. Saddles are variously made, as the common saddle and the hunting saddle, and for females the side-saddle.—2. Something like a saddle in shape or use.—3. Among *seamen* a cleat or block of wood nailed on the lower yard-arms to retain the studding sail-booms in their place. The name is given also to other circular pieces of wood; as, the *saddle* of the bowsprit.—*Saddle of mutton*, *ventson*, &c., two loins of mutton, &c., cut together.—To *put the saddle on the right horse*, means, in familiar parlance, to remove blame where it is not deserved, and charge those who have really incurred it.

**SAD'DLE**, *v. t.* To put a saddle on.

Abraham rose early in the morning and *saddled* his ass. Gen. xxii.

2. To load; to fix a burden on; as, to be *saddled* with the expense of bridges and highways.

**SAD'DLE-BACKED**, *a.* Having a low back and an elevated neck and head, as a horse.—*Saddle-backed coping*, in *arch.*, a coping thicker in the middle than at the edges, so that it delivers each way the water that falls upon it.

**SAD'DLE-BAGS**, *n.* Bags, usually of leather, united by straps for carriage on horseback, one bag on each side.

**SAD'DLE-BOW**, *n.* [Sax. *sadd-boga*.] The bows of a saddle, or the pieces which form the front.

**SAD'DLE-CLOTH**, *n.* A part of the furniture belonging to a riding horse.

**SAD'DLED**, *pp.* Furnished with a saddle; loaded.

**SAD'DLE-GALL**, *n.* A hurt from the saddle.

**SAD'DLE-GIRTH**, *n.* The band or strap which passes under the horse's belly, and serves to fasten the saddle.

**SAD'DLE-GRÄFTING**, *n.* a mode of grafting the reverse of cleft-grafting. The stock, instead of the scion, is formed like a wedge, and the end of the scion made to fit over it, like a saddle. It is preferable to cleft-grafting, particularly where the stocks are small, or nearly the same size as the scion.

**SAD'DLE-MAKER**, *n.* One whose occupation is to make saddles.

**SAD'DLERY**, *n.* Saddles in general; the manufactures of a saddler.—2. The articles usually on sale in a saddler's shop.—3. Trade or employment of a saddler.

**SAD'DLE-SHAPED**, *a.* Having the shape of a saddle. In *geol.*, when strata are bent on each side of a mountain without being broken at the top, they are called *saddle-shaped*.

**SAD'DLE-TREE**, *n.* The frame of a saddle.

**SAD'DLING**, *ppr.* Putting a saddle on; fixing a burden on; fixing on a saddle; putting on a burden.

**SADDUCEAN**, *a.* Pertaining to the Sadducees, a sect among the ancient Jews, who denied the resurrection, a

future state, and the existence of angels. Acts xxiii.

**SAD'DUCEES**, *n.* A sect among the Jews, the founder of which is said to have been Sadoc, a Jewish rabbi, who lived about 250 years before Christ. His followers, in the time of our Saviour, denied the existence of any spiritual beings, except God, and believed that the soul died with the body, and, therefore, that there was no resurrection. They also rejected the doctrines of predestination and providence, the traditions of the Pharisees, and adhered to the text of the mosaic law. In the 8th century they were called Caraites.

**SAD'DUCISM**, *n.* The tenets of the Sadducees.

**SAD'IRON**, *n.* An instrument for ironing or smoothing clothes; a flat iron.

**SAD'LY**, *adv.* Sorrowfully; mournfully.

He *sadly* suffers in their grief. *Dryden*.

2. In a calamitous or miserable manner. The misfortunes which others experience we may one day *sadly* feel.—3.† In a dark colour.

**SAD'NESS**, *n.* Sorrowfulness; mournfulness; dejection of mind; as, grief and *sadness* at the memory of sin.—2. A melancholy look; gloom of countenance.

Dim *sadness* did not spare  
Celestial visages. *Milton*.

3. Seriousness; sedate gravity. Let every thing in a mournful subject have an air of *sadness*.

**SAFE**, *a.* [Fr. *sauf*, *saufe*, contracted from *L. salvus*, from *salus*, safety, health.] 1. Free from danger of any kind; as, *safe* from enemies; *safe* from disease; *safe* from storms; *safe* from the malice of foes.—2. Free from hurt, injury, or damage; as, to walk *safe* over red hot ploughshares. We brought the goods *safe* to land.—3. Conferring safety; securing from harm; as, a *safe* guide; a *safe* harbour; a *safe* bridge.—4. Not exposing to danger. Phil. iii.—5. No longer dangerous; placed beyond the power of doing harm; a *ludicrous meaning*.

Banquo's *safe*.  
—Aye, my good lord, *safe* in a ditch. *Shak.*

**SAFE**, *n.* A place of safety; a place for securing provisions from noxious animals. A *safe* for meat commonly consists of an upright rectangular box, or case of wood or metal, with panels of wire-gauze, in the front and sides, for the purpose of admitting air, and at the same time of preventing the ingress of flies and other insects. The interior is fitted up with shelves, and with hooks for hanging meat.

**SAFE**, † *v. t.* To render safe.

**SAFE-CONDUCT**, *n.* [*safe* and *conduct*; Fr. *sauf-conduit*.] That which gives a safe passage, either a convoy or guard to protect a person in an enemy's country or in a foreign country, or a writing, a pass or warrant of security given to a person by the sovereign of a country to enable him to travel with safety.

**SAFEGUARD**, *n.* [*safe* and *guard*.] He or that which defends or protects; defence; protection.

The sword, the *safeguard* of thy brother's throne. *Granville*.

2. A convoy or guard to protect a traveller.—3. A passport; a warrant of security given by a sovereign to protect a stranger within his territories; for-

merly, a protection granted to a stranger in prosecuting his rights in due course of law.—4. An outer petticoat to save women's clothes on horseback.

**SAFEGUARD**, *v. t.* To guard; to protect. [*Little used*.]

**SAFE-KEEPING**, *n.* [*safe* and *keep*.] The act of keeping or preserving in safety from injury or from escape.

**SAFE-LODGED**, *a.* Lodged in safety.

**SAFELIER**, *a. comp.* More safely.

**SAFELIEST**, *a. super.* Most safely.

**SAFELY**, *adv.* In a safe manner; without incurring danger or hazard of evil consequences. We may *safely* proceed, or *safely* conclude.—2. Without injury. We passed the river *safely*.—3. Without escape; in close custody; as, to keep a prisoner *safely*.

**SAFENESS**, *n.* Freedom from danger; as, the *safeness* of an experiment.—2. The state of being safe, or of conferring safety; as, the *safeness* of a bridge or of a boat.

**SAFETY**, *n.* Freedom from danger or hazard; as, the *safety* of an electrical experiment; the *safety* of a voyage.

I was not in *safety*, nor had I rest; Job iii.

2. Exemption from hurt, injury or loss. We crossed the Atlantic in *safety*.—3. Preservation from escape; close custody; as, to keep a prisoner in *safety*.—4. Preservation from hurt.

**SAFETY-ARCH**, *n.* An arch formed in the substance of a wall, to relieve the part below it from the superincumbent weight. A discharging arch,—*which see*.

**SAFETY-LAMP**, *n.* A lamp covered with wire gauze, to give light in mines, without the danger of setting fire to inflammable gases. Invented by Sir Humphry Davy. [*See LAMP*.]

**SAFETY-LINTLE**, *n.* A name given to the wooden lintel which is placed behind a stone lintel, in the aperture of a door or window.

**SAFETY-VALVE**, *n.* A contrivance for obviating or diminishing the risk of explosions in steam-boilers. The form and construction of safety-valves are exceedingly various, but the principle of all is the same: that of opposing the pressure within the boiler, by such a force as will yield before it reaches the point of danger and permit the steam to escape. The most simple and obvious kind of safety-valve is that in which a weight is placed directly over a steam-tight plate, fitted to an aperture in the boiler. When, however, the pressure is high, this form becomes inconvenient, and the lever safety valve is adopted. This form is represented in fig. 1,

Fig. 1.

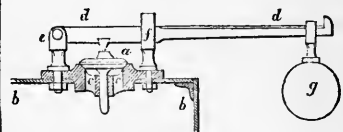

Lever Safety-valve.

where *a* is the valve, fitted to move vertically, and guided by a stem passing through the seat; *b*, the boiler; *c*, the valve-seat, usually, as well as the valve itself, formed of gun-metal; *d*, the lever working upon a fixed centre at *e*, and pressing upon the valve by a steel point; *f*, is a guide for the lever, and *g* a weight which may be adjusted to

any distance from the centre, according to the pressure required. In locomotive engines, where a weight cannot with propriety be employed, it is usual to adopt the spring safety-valve, one form of which is shown at fig. 2. A series

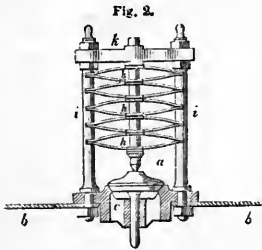

Spring Safety-valve.

of bent springs, *h h*, are placed alternately in opposite directions, their extremities sliding upon the rods, *i i*, and are forced down upon the valve, *a*, by means of a cross bar, *h*, which may be adjusted by means of the nut, so as to give the right pressure upon the valve. **SAFFLOWER**, *n*. Bastard saffron, a plant of the genus *Carthamus*, the *C. tinctorius*. It is cultivated in China, India, Egypt, and also in the South of Europe, on account of its flowers, which in their dried state form the safflower of commerce. An oil is expressed from the seeds, which is used by the Asiatics as a laxative medicine. It is also most extensively used as a lamp oil. The dried flowers afford a red colour, exceeding in delicacy and beauty, as it does in costliness. It is principally employed for imitating upon silk the fine scarlet, (*ponceau*) of the French, and rose colours dyed with cochineal upon woollen cloth. Safflower also produces the beautiful *rouge* known by the name of *rouge végétale*. Safflower from China is the most valued.

**SAFFLOWER**, *n*. A deep red fecula separated from orange-coloured flowers particularly those of the *Carthamus tinctorius*; called also *Spanish red* and *China lake*. The dried flowers of the *Carthamus tinctorius*.

**SAFFRON**, *n*. [*W. safran*, *safran*; *Fr. safran*; *G. Sw. and Dan. safran*; *Ar. safra*, to be yellow, to be empty; the root of *cipher*. The radical sense then is to fail, or to be hollow, or to be exhausted.] 1. A plant of the genus *Crocus*, the *C. sativus*. It is a low



Saffron (*Crocus sativus*.)

ornamental plant, with grass-like leaves and large lily-shaped flowers, of a pur-

ple colour. It is a native of Greece and Asia Minor, but extensively cultivated in Austria, France, Spain, and also formerly in England. The dried stigmata form the saffron of the shops, which, when good, has a sweetish, penetrating, diffusive odour; a warm, pungent, bitterish taste; and a rich, deep orange colour. Saffron is used in medicine and the arts, but in this country the consumption seems to be diminishing. It is also employed in cookery and confectionary, to colour butter and cheese, and by painters and dyers. It is chiefly imported from the south of Europe, especially Spain, but the English saffron, as being of a superior quality, is always preferred. It is often adulterated with the petals of other plants, especially with those of the marigold. The *bastard saffron* is of the genus *Carthamus*, and the *meadow saffron* of the genus *Colchicum*.

**SAFFRON**, *a*. Having the colour of saffron flowers; yellow; as, a *saffron* face; a *saffron* streamer.

**SAFFRON**, *v. t*. To tinge with saffron; to make yellow; to gild.

**SAFFRONED**, *pp*. Tinged with saffron; made yellow.

**SAFFRONY**, *a*. Having the colour of saffron.

**SAG**, *v. i*. [a different spelling of *sag*,—*which see*.] 1. To yield; to give way; to lean or incline from an upright position, or to bend from a horizontal position.—2. In *sailing*, to incline to the leeward; to make lee way.

**SAG**, *v. t*. To cause to bend or give way; to load or burden.

**SÄGA**, *n*. A heroic tale, as the *saga* of Ragner Lodbrog, the *Knytlinga saga*, &c. The word is frequently to be met with in connection with Scandinavian literature, and refers exclusively to works in the languages of northern Europe.

**SAGA'CIOUS**, *a*. [*L. sagax*, from *sagus*, wise, foreseeing; *saga*, a wise woman; *sagio*, to perceive readily; *Fr. sage, sagesse*; *It. saggio*. The latter signifies wise, prudent, *sage*, and an *essay*, which unites this word with *seek*, and *L. sequor*.] 1. Quick of scent; as a *sagacious* hound; strictly perhaps, following by the scent, which sense is connected with *L. sequor*; with *off*; as, *sagacious* of his quarry.—2. Quick of thought; acute in discernment or penetration; as a *sagacious* head; a *sagacious* mind.

I would give more for the criticisms of one *sagacious* enemy, than for those of a score of admirers. *H. Humphrey*.

**SAGA'CIOUSLY**, *adv*. With quick scent.—2. With quick discernment or penetration.

**SAGA'CIOUSNESS**, *n*. The quality of being sagacious; quickness of scent.—2. Quickness or acuteness of discernment.

**SAGAC'ITY**, *n*. [*Fr. sagacité*; *L. sagacitas*.] 1. Quickness or acuteness of scent; applied to animals.—2. Quickness or acuteness of discernment or penetration; readiness of apprehension; the faculty of readily discerning and distinguishing ideas, and of separating truth from falsehood.

*Sagacity* finds out the intermediate ideas, to discover what connection there is in each link of the chain. *Locke*.

**SAG'AMORE**, *n*. Among some tribes of American Indians, a king or chief. [*In Sax. sigora* is a conqueror.]

**SAGAPE'NUM**, *n*. [*Gr. σαγαπηνον*.] A

fetid gum-resin, brought from Persia and Alexandria, generally believed to be furnished by some species of *ferula*. It is prepared in the same way as *assafoetida*. It occurs either in tears or irregular masses, of a dirty brownish colour, containing in the interior white or yellowish grains. It has an odour of garlic, and a hot, acrid, bitterish taste. It is occasionally used in medicine as a nerve and stimulating expectorant. **SAG'ATHY**, *n*. A kind of serge; a slight woollen stuff.

**SAGE**, *n*. [*Fr. sauge*; *Ar. saoch*.] *Salvia*, a genus of monopetalous exogenous plants, nat. order Labiatae. The species are well known, both as ornamental shrubs, and for their uses in domestic economy. The best known and most frequently used in this country is the *S. officinalis*, or garden sage, a native of various parts of the south of Europe. This plant is much used in cookery, and is supposed to assist the stomach in digesting fat and luscious foods. It was formerly in great repute as a sudorific aromatic, astringent, and antiseptic. It possesses stimulant properties in a high degree, and sage tea is commended as a stomachic and slight stimulant. *S. pratensis*, meadow sage or clary, and *S. verbenacea*, wild sage or clary, are natives of Great Britain.

**SAGE**, *a*. [*Fr. sage*; *L. sagea, sagus, sagio*. See **SAGACIOUS**.] 1. Wise; having nice discernment and powers of judging; prudent; grave; as, a *sage* counsellor.—2. Wise; judicious; proceeding from within; well judged; well adapted to the purpose; as, *sage* counsels.

**SAGE**, *n*. A wise man; a man of gravity and wisdom; particularly, a man venerable for years, and known as a man of sound judgment and prudence; a grave philosopher.

At his birth a star proclaims him come,  
And guides the eastern *sages*. *Milton*.  
Groves where immortal *sages* taught.

*Pope*.

**SÄGELY**, *adv*. Wisely; with just discernment and prudence.

**SÄGENE**, *n*. A Russian measure of about seven English feet. [See **SAJENE**.]

**SÄGENESS**, *n*. Wisdom; sagacity; prudence; gravity.

**SÄ'ENITE**, *n*. Acicular rutile, or red oxide of titanium.

**SAG'GED**, *pp*. Caused to bend or give way; loaded; burdened.

**SAG'GER**, *n*. A clay used in making the pots in which earthen ware is baked, and which are called *saggers* or *seggers*. **SAG'GING**, *ppr*. Causing to bend; burdening.

**SAG'GING**, *n*. A bending or sinking, under superimposed weight.—*Sagging to leeward*. [See **SAG**.] A nautical term denoting the movement by which a ship makes considerable lee-way.

**SAG'INA**, *n*. Pearl-wort, a genus of plants. [See **PEARL-WORT**.]

**SAGIT'TA**, *n*. [*L. an arrow or dart*.] One of the old constellations situated over the back of *Aquila*.

**SAG'ITTAL**, or **SAGIT'TAL**, *a*. [*L. sagittalis*, from *sagitta*, an arrow; that which is thrown or driven, probably from the root of *say* and *sing*.] Pertaining to an arrow; resembling an arrow; as, *sagittal* bars of yellow. In *anat.*, the *sagittal suture* is the suture which unites the parietal bones of the skull.

**SAGIT'TARIA**, *n*. A genus of plants, nat. order Alismaceæ. The species

are water-plants, and are found in the hotter and temperate parts of the globe, and are frequently remarkable for the beauty of their flowers. *S. sagittifolia*, or common arrow-head, is indigenous in this country. The rhizomata of many of the species contain amylaceous matter, and form a nutritious food.

**SAGITTA'RIOUS**, *n.* [L. an archer.]

One of the twelve signs of the zodiac, which the sun enters Nov. 22. It is represented on celestial globes and charts by the figure of a centaur in the act of shooting an arrow from his bow.

**SAG'ITARY**, *n.* [supra.] A centaur, an animal half man, half horse, armed with a bow and quiver.

**SAG'ITARY**, *a.* Pertaining to an arrow.

**SAG'ITATE**, *a.* In *bot.*, shaped like the head of an arrow; triangular, hollowed at the base, with angles at the hinder part; or with the hinder angles acute, divided by a sinus; applied to the leaf, stipula or anther.



Sagittate leaf.

**SA'GO**, *n.* A kind of starch, produced from the stem or cellular substance of several palms and palm-like vegetables, the chief of which are, the *Sagus laevis*, *Sagus rumphii* of Willdenow (*Metroxylon sagus*), the *Saguerus rumphii*, the *Phenix farinifera*, *Corypha umbraculifera*, some *Cycases*, and even a *Zamia*, but these last yield a very inferior sort. The *Sagus laevis* or *genuina*, from which the finest sago is prepared,

forms immense forests, on nearly all the Moluccas, each tree yielding from



Sago Palm (*Sagus genuina*.)

100 to 800 lbs. of sago. The tree when at maturity is about 30 feet high, and from 18 to 22 inches in diameter. The sago or medullary matter, which is prepared by the plant for the use of the flowers and fruit, is most abundant just before the evolution or appearance of the spadix or flower-bud. At this period the tree is cut down and the medullary part extracted from the trunk, and reduced to powder like sawdust. The filaments are next separated by washing, and the meal laid to dry. For exportation, the finest sago meal is mixed with water, and then rubbed into small grains of the size and form of coriander seeds. This is the kind

principally brought to England. Of late years the Chinese have invented a process for refining sago, and giving it a fine pearly lustre; the sago so cured is in the highest estimation in all the European markets. It forms a light, wholesome, nutritious food. It may be used as a pudding, or prepared in other ways as an article of diet for children and invalids, if a farinaceous diet is required.

**SAGOIN**, or **SAGOU'IN**, *n.* The *Sagoin*s form a division of the genus *Simia*, including such of the monkeys of America as have hairy tails, not prehensile.

**SA'GUM**, *n.* [L.] The military cloak of the Roman magistrates and dignitaries.

**SA'GY**, *a.* [from *sage*.] Full of sage; seasoned with sage.

**SAHLITE**, *n.* A mineral named from the mountain *Sahla*, in Westermania, where it was discovered. It is of a light greenish gray colour, occurs massive, and composed of coarse granular concretions. It is called also malacolite; a sub-species or variety of augite.

**SA'IC**, *n.* A Turkish or Grecian vessel, very common in the Levant, a kind of ketch which has no top-gallant-sail, nor mizzen-top-sail.

**SAID**, *pret.* and *pp.* of *Say*; so written for *sayed*. Declared; uttered; reported.—2. Aforesaid; before mentioned.

**SAIL**, *n.* [Sax. *segel*; G. and Sw. *segel*; W. *hwyl*, a sail, a course, order, state, journey; *hwylaw*, to set in a course, train or order, to direct, to proceed, to sail, to attack, to butt. The Welsh appears to be the same word. *So hâl* is the L. *sal*, salt.] 1. In navigation, a spread of canvas, or an assemblage of

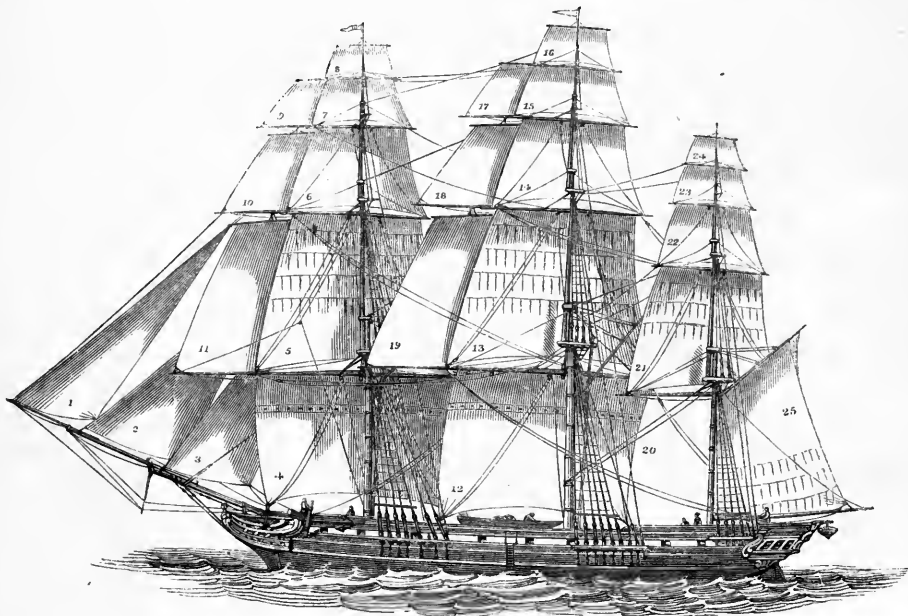

Merchantman under full Sail.

1. Flying jib.
2. Jib.
3. Fore-top-mast stay sail.
4. Fore course.
5. Fore-top sail.
6. Fore-top-gallant sail.
7. Fore-royal.

8. Fore-sky sail.
9. Fore-royal studding sail.
10. Fore-top-gallant studding sail.
11. Fore-top-mast studding sail.
12. Main course.
13. Main-top sail.

14. Main top-gallant sail.
15. Main-royal.
16. Main-sky sail.
17. Main royal studding sail.
18. Main top-gallant studding sail.
19. Main top-mast studding sail.

20. Mizzen course.
21. Mizzen top sail.
22. Mizzen top-gallant sail.
23. Mizzen royal.
24. Mizzen sky sail.
25. Mizzen spanker.

several breadths of canvas, [or some substitute for it,] sewed together with a double seam at the borders, and edged with a cord called the bolt-rope, to be extended on the masts or yards for receiving the impulse of wind by which a ship is driven. A sail extended by a yard hung (*stung*) by the middle and balanced, is called a *square sail*; a sail set upon a gaff or a stay, is called a *fore and aft sail*; which terms refer to the position of the yard, gaff, or stay, when the sail is not set. The upper part of every sail is the *head*, the lower part the *foot*, the sides in general are called *leeches*; but the weather or side edge of any but a square sail is called the *luff*, and the other edge the *after leech*. The upper two corners are *earings*, but that of a jib is the *head*; the lower two corners are in general *clues*; the weather clue of a fore and aft sail, or of a course while set, is the *tack*. The edges of a sail are strengthened by a rope called the *bolt rope*. Sails take their names from the mast, yard, or stay upon which they are stretched. Thus the sails connected with the main mast are the *main-sail*, *main-top-mast sail*, *main-top-gallant sail*, and the *main-royal*. In like manner there are the *fore sail*, the *fore-top sail*, the *fore-top-gallant sail*, and the *fore-royal*; and similar appellations are given to the sails supported by the *mizzen* or *after-mast*. The *main-stay sail*, *main-top-mast-stay sail*, &c., are between the main and fore masts, and the *mizzen-stay sail*, *mizzen-top-mast-stay sail*, &c., are between the main and mizzen-masts. Between the fore mast and bow-sprit, are the *fore-stay sail*, the *fore-top-mast stay sail*, the *jib*, and sometimes a *flyjib* and *middle jib*. The principal sails are the courses or lower sails, the top-sails and top-gallant sails.—2. In poetry, wings.—3. A ship or other vessel; used in the singular for a single ship, or as a collective name for many. We saw a *sail* at the leeward. We saw three *sail* on our starboard quarter. The fleet consists of twenty *sail*.—*To loose sails*, to unfurl them.—*To make sail*, to extend an additional quantity of sail.—*To set sail*, to expand or spread the sails; and hence, to begin a voyage.—*To shorten sail*, to reduce the extent of sail, or take in a part.—*To strike sail*, to lower the sails suddenly, as in saluting or in sudden gusts of wind.—2. To abate show or pomp. [Colloquial.]

SAIL, v. i. To be impelled or driven forward by the action of wind upon sails, as a ship on water. A *ship sails* from Liverpool for New York. She *sails* ten knots an hour. She *sails* well close-hauled.—2. To be conveyed in a vessel on water; to pass by water. We *sailed* from London to Canton.—3. To swim.

Little dolphins, when they sail  
In the vast shadow of the British whale.  
Dryden.

4. To set sail; to begin a voyage. We *sailed* from Greenock for Demerara March 10, 1848.—5. To be carried in the air, as a balloon.—6. To pass smoothly along.

As is a winged messenger from heaven,  
When he bestrides the lazy pacing clouds,  
And *sails* upon the bosom of the air. *Shak.*

7. To fly without striking with the wings.

SAIL, v. t. To pass or move upon in a ship, by means of sails.

A thousand ships were man'd to sail  
the sea.  
Dryden.

[This use is elliptical, *on* or *over* being omitted.]—2. To fly through.

Sublime she sails,

Th' aerial space, and mounts the winged  
gales.  
Pope.

SAILABLE, a. Navigable; that may be passed by ships.

SAILBÖRNE, a. Borne or conveyed by sails.

SAIL-BROAD, a. [See BROAD.] Spreading like a sail.

SAILCLOTH, n. Canvas or duck used in making sails for ships, &c.

SAILED, pp. Passed in ships or other water craft.

SAILER, n. One that sails; a seaman; usually *Sailor*.—2. A ship or other vessel, with reference to her manner of sailing. Thus we say, a *heavy sailer*; a *fast sailer*; a *prime sailer*.

SAILING, ppr. Moving on water or in air; passing in a ship or other vessel.

SAILING, n. The act of moving on water; or the movement of a ship or vessel impelled or wafted along the surface of water by the action of wind on her sails. Also the act of directing a ship on a given line laid down in a chart. The term is also applied to the rules by which, in particular circumstances, a ship's place and its motion are computed. Sailing is distinguished into different cases according to the principles upon which the computations are founded, as *Plane sailing*, *Parallel sailing*, *Middle latitude sailing*, *Mercator's sailing*, *Globular sailing*, &c. [See NAVIGATION.]—2. Movement through the air, as in a balloon.—3. The act of setting sail or beginning a voyage.—*Sailing order*, or *order of sailing*, any determinate order preserved by a squadron of ships. It usually implies 1, 2, or 3 parallel columns, but is at the disposition of the admiral.

SAILING-MASTER, n. An officer in a ship of war, who superintends all the details of navigating the ship.

SAILING OVER, n. In *arch.* the name given by workmen to any thing projecting beyond the naked of a wall, of a column, &c.

SAILLESS, a. Destitute of sails.

SAIL-LOFT, n. A loft or apartment where sails are cut out and made.

SAIL-MAKER, n. One whose occupation is to make sails.—2. An officer on board ships of war, whose business is to repair or alter sails.

SAIL-MAKING, n. The art or business of making sails.

SAILOR, n. [a more common spelling than *Sailer*.] A mariner; a seaman; one who follows the business of navigating ships or other vessels, or one who understands the management of ships in navigation. This word, however, does not by itself express any particular skill in navigation. It denotes any person who follows the seas, and is chiefly or wholly applied to the common hands. [See SEAMAN.]

SAILOR-LIKE, a. Like sailors.

SAIL-ROOM, n. An apartment in a vessel, where spare sails are stowed away.

SAILY, a. Like a sail.

SAIL-YARD, n. [Sax. *segl-gyrd*.] The yard or spar on which sails are extended.

SAIM, n. [Sax. *seim*; W. *saim*; Fr.

*saindouz*. Qu. L. *sebum*, contracted.] Lard. [Scotch.]

SAIN, † for *Sayen*, pp. of *Say*.

SAIN or SANE, v. t. [Ger. *segen*, a sign; *segmen*, to bless.] To make the sign of the cross as a token of blessing one; to bless. [Scotch.]

SAINFOIN, } n. [Fr. *sainfoin*; *saint*,  
SAINFOIN, } sacred, and *foin*, hay.]

A plant of the genus *Hedysarum*, the *H. onobrychis*, or *Onobrychis sativa*; nat. order Leguminosæ. It grows luxuriantly and spontaneously on the calcareous mountains of the middle and south of Europe. It has been in regular cultivation for upwards of two centuries for the purpose of supplying fodder for cattle either in the green state or when converted into hay. In England it is extensively cultivated on the Cotswold hills, and on the chalk soils of Dorset, Hants, Wilts, &c. It does not thrive well except when the soil or subsoil is calcareous.

SAINTE, n. [Fr. from L. *sanctus*; It. and Sp. *santo*.] 1. A person sanctified; a holy or godly person; one eminent for piety and virtue. It is particularly applied to the apostles and other holy persons mentioned in Scripture. A hypocrite may imitate a *sainte*; Ps. xvi. 2. One of the blessed in heaven; Rev. xviii.—3. The holy angels are called *saints*, Deut. xxxiii; Jude xiv.—4. One canonized by the Church of Rome.

SAINTE, v. t. To number or enroll among saints by an official act of the pope; to canonize.

Over against the church stands a large hospital, erected by a shoemaker, who has been beatified though never *sainted*.

Admion.

SAINTE, v. i. To act with a show of piety.

SAINTE ANTHONY'S FIRE. See ANTHONY'S FIRE.

SAINTE BARNABY'S THISTLE, n. A plant, a species of centaurea, the *C. solstitialis*, which grows in corn fields and hedges in the south of England.

SAINTEDE, pp. Canonized; enrolled among the saints.—2. a. Holy; pious; as, thy father was a most *sainted* king.—3. Sacred; as the gods on *sainted* hills.

SAINTESS, n. A female saint.

SAINTE IGNATIUS'S BEAN. See IGNATIUS'S BEAN.

SAINTING, ppr. Canonizing; enrolling among the saints.

SAINTE JOHN'S BREAD, n. A plant of the genus *Ceratonia*, the *C. siliqua*, or Carob-Tree. [See CAROB, CERATONIA.]

SAINTE JOHN'S WÖRT, n. The common name of several species of plants of the genus *Hypericum*. [See HYPERICUM.]

SAINTELIKE, a. [*saint* and *like*.] Resembling a saint; as, a *saintlike* prince.—2. Suiting a saint; becoming a saint.

Gloss'd over only with a *saintlike* show.  
Dryden.

SAINTELY, a. Like a saint; becoming a holy person; as, wrongs with *saintly* patience borne.

SAINTE PETER'S WÖRT, n. A plant of the genus *Ascyrum*, and another of the genus *Hypericum*.

SAINTE'S BELL, n. A small bell rung in churches when the priest repeats the words *sancte, sancte, sancte, Deus sabaoth*, that persons absent might fall on their knees in reverence of the holy office. [See SACRING BELL.]

SAINTE-SEEMING, a. Having the appearance of a saint.

**SAIN'TSHIP**, *n.* The character or qualities of a saint.

**SAIN'T SIMO'NIAN**, *n.* A partisan of the Count de St. Simon (died 1825), who maintained that the principle of joint stock property, and just division of the fruits of common labour among all members of society, is the true remedy for the evils of society.

**SAIN'T-SIMO'NIANISM**, *n.* The doctrines of the St. Simonians.

**SAIN'T VITUS'S DANCE**. See **CHOREA**.

**SAJÈNE**, *n.* [written also *Sagene*.] A Russian measure of length, equal to seven feet English measure.

**SAKE**, *n.* [Sax. *sac*, *saca*, *sace*, *sacu*, contention, discord, a suit or action at law, cause in court, hence the privilege which a lord had of taking cognizance of suits in his own manor; *sacan*, to contend, to strive; Goth. *sahan*, to rebuke, chide, upbraid; D. *zaak*, cause, case, thing, business, affair; G. *sache*, matter, thing; *eines sache führen*, to plead one's cause; *ursache*, cause, reason, motive; Dan. *sag*, cause, thing, affair, matter, case, suit, action; Heb. *שָׂחָה*, *ashah*, to press or oppress; Ch. to accuse, to criminate. The primary sense is to strain, urge, press, or drive forward, and this is from the same root as *seeh*, *essay*, and L. *sequor*, whence we have *pursue* and *prosecute*. We have analogous words in *cause*, *thing*, and the L. *res*. Its Saxon sense is no longer in use, that is, cause, action, suit, a *seeking* or demand in court; but we use it in a sense nearly similar, though differently applied.] 1. Final cause; end; purpose; or rather the purpose of obtaining. I open a window for the *sake* of air, that is, to obtain it, for the purpose of obtaining air. I read for the *sake* of instruction, that is, to obtain it. *Sake* then signifies, primarily, *effort* to obtain, and secondarily, *purpose* of obtaining. The hero fights for the *sake* of glory; men labour for the *sake* of subsistence or wealth.—2. Account; regard to any person or thing.

I will not again cure the ground any more for man's *sake*; Gen. viii.

Save me for thy mercies' *sake*; Ps. vi.

**SA'KER**, *n.* [Fr. *sacre*.] 1. A hawk; a species of falcon.—2. A piece of artillery.

**SAK'ERET**, *n.* The male of the saker-hawk.

**SA'KIS**, *n.* The American name of those monkeys which constitute the genus *Pithecia* of Desmarest and Illiger.



Saki Cuzio (*Pithecia satanas*).

They have for the most part long and bushy tails, and thus have obtained the name of Fox-tailed monkeys.

**SAL**, *n.* [See **SALT**.] Salt; a word much

used by the older chemists and in pharmacy.

**SALABLE**, *a.* See **SALEABLE**.

**SALA'CIOUS**, *a.* [L. *salax*, from the root of *sal*, salt; the primary sense of which is shooting, penetrating, pungent, coinciding probably with L. *salio*, to leap. *Salacious*, then, is highly excited, or prompt to leap.] Lustful; lecherous.

**SALA'CIOUSLY**, *adv.* Lustfully; with eager animal appetite.

**SALA'CIOUSNESS**, } *n.* Lust; le-  
**SALACTY**, } cherousness;

strong propensity to venery.  
**SAL'AD**, *n.* [Fr. *salade*; Sp. *ensalada*, that is, literally, *salted*; G. and Sw. *salat*.] A general name for certain vegetables, prepared and served so as to be eaten raw. Salads are composed chiefly of lettuce, endive, radishes, green mustard, land and water cresses, celery and young onions. They are usually dressed with eggs, salt, mustard, oil, vinegar, or spices.

**SAL'AD-BURNET**, *n.* A British plant of the genus *Poterium*, the *P. sanguisorba*. It is a perennial with purple flowers, and grows in dry pastures. [See **POTERIUM**.]

**SAL'ADING**, *n.* Vegetables for salads.  
**SAL'AD OIL**, *n.* Olive oil, used in dressing salads, and for other culinary purposes.

**SAL'AL-BERRY**, *n.* A fruit from Oregon, about the size of a common grape, of a dark colour and sweet flavour.

**SAL-AL'EM'BROTH**, *n.* A compound of corrosive sublimate of mercury, and sal ammoniac, in the proportions of two equivalents of the former to one of the latter.

**SALAM**, *n.* [Oriental, peace or safety.] A salutation or compliment of ceremony or respect.

**SAL'AMANDER**, *n.* [L. and Gr. *salamandra*.] The popular name of a genus of batrachian reptiles, having some affinities with lizards, but more with frogs. *Salamanders* have an elongated body, four feet, and a long tail, which gives them the general form of lizards;



Alleghany Salamander (*Mespomna Alleghaniensis*).

but then they have all the characters of batrachians. The vulgar story that the *salamander* is able to endure fire, is a mistake.—2. A large iron poker, which being made red hot, is used for lighting fires.—*Salamander's hair* or *wool*, a name once given to a species of asbestos or mineral flax.

**SALAMAN'DRINE**, *a.* Pertaining to or resembling a salamander; enduring fire.  
**SAL-AMMO'NIAC**, chloride of ammonium. The native sal ammoniac is of two kinds, volcanic and conchoidal. Its name is derived from the Temple of Ammon in Egypt, where it was originally made by burning camel's dung. It is now largely manufactured in this country. [See **AMMONIA**.]

**SALAM'STONE**, *n.* A variety of sapphire, which consists of small transparent crystals, generally six-sided prisms of pale-reddish, and blueish colours. It is brought from Ceylon.

**SAL'ARIED**, *a.* Enjoying a salary.

**SAL'ARY**, *n.* [Fr. *saiaire*; L. *salarium*; said to be from *sal*, salt, which was

part of the pay of Roman soldiers.] The recompense or consideration stipulated to be paid to a person periodically for services, usually a fixed sum to be paid by the year, and sometimes by the half-year or quarter; as to governors, judges, sheriffs, ministers of the crown, and other government officials, clergymen, teachers, &c. The income of a clergyman is more usually called a stipend. When wages are stated or stipulated by the month, week, or day, we do not call the compensation *salary*, but *pay* or *wages*; as in the case of military men and labourers.

**SALE**, *n.* [W. *sal*, a pass, a cast, or throw, a *sale*; Sax. *sal*, sale; *sellan*, *syllan*, *gesyllan*, to give, yield, grant, impart, deliver, also to *sell*. The primary sense of *sell*, is simply to deliver or cause to pass from one person to another; Sw. *sälja*, Dan. *selger*, to sell.] 1. The act of selling; the exchange of a commodity for money of equivalent value. The exchange of one commodity for another is *barter* or *permutation*, and *sale* differs from *barter* only in the nature of the equivalent given. In the law of England *sale* is a contract by which the seller at once transfers the property of a subject, in consideration of a price paid or to be paid. In the law of Scotland, *sale* is a consensual contract, by which one party, called the *seller* or *vender*, agrees to transfer the property of a subject, in consideration of a price to be paid by the other party, called the *purchaser* or *vendee*. According to the English law, a thing, when sold, immediately becomes the property of the purchaser; whereas, by the Scots law, a thing, when sold, is not alienated by the contract, the alienation being completed only by delivery. *Sale and return*, in Scots law, a contract by which goods are delivered by a wholesale dealer to a retailer, to be paid for at a certain rate if sold again by the retailer, and if not sold to return to the vendor.—2. Vent; power of selling; market. He went to market, but found no *sale* for his goods.—3. Auction; public sale to the highest bidder, or exposure of goods in a market or shop.—4. State of being venal, or of being offered to bribery; as, to set the liberty of a state to *sale*.—5. A wicker basket. [Qu. Sax. *salan*, to bind.]

**SALE**, *a.* Sold; bought; as opposed to *homemade*. [Colloquial.]

**SALEABLE**, *a.* [From *sale*.] That may be sold; vendible; that finds a ready market; being in good demand.

**SALEABLENESS**, *n.* The state of being saleable.

**SALEABLY**, *adv.* In a saleable manner.  
**SALEBROS'ITY**, *n.* [See **SALEBROUS**.] Roughness or ruggedness of a place or road.

**SAL'EBROUS**, *a.* [L. *salebrosus*, from *salebra*, a rough place; probably allied to *salio*, to shoot out.] Rough; rugged; uneven. [Little used.]

**SAL'EP**, or **SAL'OP**, *n.* [Said to be a Turkish word; written also *saloop*, and *saleb*.] In the *materia medica*, the dried tuberous roots of different species of orchis, especially *O. mascula*, imported from Persia and Asia Minor. Salep occurs in commerce in small oval grains of a whitish-yellow colour, at times semi-transparent, of a honey aspect, very hard, with a faint peculiar smell, and a taste like that of gum-



tragacanth, but slightly saline. It is a nutritious article of diet, much valued in the East for its supposed general stimulant properties; but which is justly esteemed as bland and nutritious, and well suited to children and convalescents. A decoction of the root is used at meals, or as a beverage, in some parts of England, by individuals of the poorer classes.

**SALERATUS, n.** [Lat.] A carbonate of potash, containing a greater quantity of carbonic acid than pearl ash, used in cookery.

**SALESMAN, n.** [sale and man.] One that sells clothes ready made.—2. One who finds a market for the goods of another person, or who is employed in a shop to sell the goods.—3. One who sells beasts at market.

**SALEWORK, n.** Work or things made for sale; hence, work carelessly done. *This last sense is a satire on man.*

**SAL GEM, n.** Common salt.

**SALIENT.** In *her.*—see SALIENT.

**SAL'IC, or SAL'IQUE, a.** [Fr. *salique.*] The etymology is uncertain. The most reasonable French philologists derive it from the Salieni, a surname of the Franks, who lived about the river Saale in ancient Germany. Echard deduces this word from *sala*, a house, and the law, from the circumstance that a male only could inherit his father's mansion and the court or land inclosed. *Montesq. b. 18.*] The Salic law of France was a fundamental pact, by virtue of which males only could inherit the throne.

**SALICACEÆ, n.** A nat. order of apetalous exogens, distinguished by a two-valved capsule, and numerous seeds tufted with long hairs. The species are trees or shrubs, inhabiting woods in the northern districts of Europe, Asia, and America. Only two genera are included in the order, *Salix* or willow, and *Populus* or poplar.

**SALICIN, SALICINE, n.** [*Salix*, a willow.] A bitter crystallizable substance extracted from willow barks, and from that of the poplar. Its ultimate elements are carbon, hydrogen, and oxygen, so that it differs from the vegeto-alkalis in containing no nitrogen. It possesses tonic properties analogous to those of disulphate of quina, and is a valuable stomachic bitter.

**SALICORNIA, n.** A genus of plants, nat. order Chenopodiaceæ, the species of which are known by the common name of glasswort or saltwort. They are mostly weeds inhabiting moist salt districts on the coasts of the north of Europe, Africa, and America. *S. herbacea*, (jointed glasswort) and *S. radicans*, (creeping jointed glasswort) are natives of Great Britain. *S. herbacea*, and many other species, yield a great quantity of soda.

**SALICULAMIDE, or SALICYLAMIDE, n.** A new compound obtained from oil of gaultheria when dissolved in strong aqua ammonia, and the solution distilled. It appears in the form of colourless prismatic crystals.

**SAL'ICULE, or SAL'ICYLE, n.** In *chem.*, the hypothetical radical of a remarkable series of compounds, the most interesting of which is hyduret of salicyle, or salicylous acid.

**SAL'ICULIC ACID, or SAL'ICYLIC ACID, n.** An acid obtained from hyduret of salicyle. It crystallizes in tufts of slender prisms. Its decompositions are very interesting, connecting it with several other series of organic com-

pounds. It unites with bases forming salts, called *salicylates*.

**SALICUL'IMIDE, or SALICYLAMIDE, n.** A substance formed from three equivalents of hyduret of salicyle and two of ammonia, by the separation of six equivalents of water. It appears in the form of golden yellow brilliant prisms.

**SALICYLOUS ACID, or SALICYLOUS ACID, n.** An acid also called hyduret of salicyle. It is the chief ingredient in the essence of meadow sweet. It is an oily colourless liquid, having a fragrant aromatic odour, and a burning taste. With chlorine and bromine it forms new compounds, and with bases it forms salicylurets, water being separated. It consists of fourteen atoms of carbon, five of hydrogen, and four of oxygen.

**SALICYLU'RET, n.** A substance formed by the union of salicylous acid with a base.

**SAL'IENT, a.** [*L. saliens, salio, to leap.*] 1. Leaping; an epithet in heraldry applied to a lion or other beast, represented in a leaping posture, with his right foot in the dexter point, and his hinder left foot in the sinister base of the escutcheon, by which it is distinguished from *rampant*. It is also written *saliant*.—2. In *fortification*, projecting; as, a *salient* angle. A *salient* angle points outward, and is opposed to a *re-entering* angle, which points inward. All the angles of any regular figure, as the triangle, square, hexagon, &c., are *salient*.—3. In *arch.*, a term used in respect of any projecting part or member. Also written *saliant*.



Salient.

**SAL'IENT, a.** [*L. saliens, from salio, to leap or shoot out.*] 1. Leaping; moving by leaps; as frogs.—2. Beating; throbbing; as the heart.—3. Shooting out or up; springing; darting; as, a *salient* sprout.

**SAL'IENTLY, adv.** In a salient or projected manner.

**SALIFEROUS, a.** [*L. sal, salt, and fero, to produce.*] Producing or bearing salt; as, *saliferous* rock. *Saliferous system*, the new red sandstone system of some geologists, so named from salt being the characteristic portion of the component masses of this system.

**SALIFIABLE, a.** [from *salify.*] Capable of combining with an acid to form a salt.—*Salifiable bases, in chem.*, a term chiefly applied to those metallic oxides which combine in definite proportions with the acids, so as to form distinct salts. Ammonia and the vegeto-alkalies are also, upon the same principle, salifiable bases.

**SALIFICATION, n.** The act of salifying.

**SALIFIED, pp.** Formed into a salt by combination with an acid.

**SALIFY, v. t.** [*L. sal, salt, and facio, to make.*] To form into a salt, by combining an acid with a base.

**SALIFYING, ppr.** Forming into a salt by combination with a base.

**SALIGOT, n.** [Fr.] A plant, the water thistle.

**SALINA'TION, n.** [*L. sal, salt; salinator, a salt maker; Fr. salin, salt, brinish.*] The act of washing with salt water.

**SALINE, } a.** [Fr. *salin*, from *L. SALINOUS, } sal, salt.*] 1. Consisting of salt, or constituting salt; as, *saline* particles; *saline* substances.—2. Partaking of the qualities of salt; as, a *saline* taste. *Salinous* is less used.

**SALINE, n.** [Sp. and It. *salina*; Fr. *saline.*] A salt spring, or a place where salt water is collected in the earth; a name given to the salt springs in the United States.—2. A name given to potash before it is calcined.

**SALINE'NESS, n.** State of being saline.

**SALINIFEROUS, a.** [*L. sal, salinum, and fero, to produce.*] Producing salt.

**SALINIFORM, a.** [*L. sal, salinum, and form.*] Having the form of salt.

**SALINO-TERRENE, a.** [*L. sal, salinum, and terrenus, from terra, earth.*] Denoting a compound of salt and earth.

**SAL'IQUE, a.** See SALIC.

**SALIKRETINE, n.** A resinous substance formed by boiling salicine with diluted sulphuric or hydrochloric acid. It is a yellowish-white powder, soluble in alcohol. Its formation is accompanied by the production or separation of grape sugar.

**SALISBUR'IA, n.** A genus of plants, nat. order Taxaceæ, the yew tribe. *S. adiantifolia*, a Japanese species, is commonly cultivated, and is remarkable on account of its peculiar leaves resembling those of the fern, called maiden hair. The fruit is as large as a damson, and is resinous and astringent. The kernels are used in Japan to promote digestion.

**SAL'ITE, v. t.** [*L. salio, from sal, salt.*] To salt; to impregnate or season with salt. [*Little used.*]

**SAL'IVA, n.** [*L. saliva*; Ir. *seile*; W. *halio*, as if connected with *hâl, salt*. The Irish has *silim*, to drop or distil, and *sileadh, saliva*.] The fluid which is secreted by the salivary glands, and which serves to moisten the mouth and tongue. It moistens our food also, and by being mixed with it in mastication, favours deglutition. When discharged from the mouth, it is called *spittle*. Its principal saline constituent appears to be muriate of potash.

**SAL'IVAL, } a.** [from *saliva.*] Per-

**SAL'IVARY, } taining to saliva; se-**

**SAL'IVARY, } creting or conveying saliva; as, sali-**

**SAL'IVARY, } vary glands; salivary ducts or canals.**

**SAL'IVANT, a.** Exciting salivation.

**SAL'IVANT, n.** That which produces salivation.

**SAL'IVATE, v. t.** [From *saliva*; Fr. *saliver.*] To purge by the *salival* glands.

To produce an unusual secretion and discharge of saliva in a person, usually by mercury; to produce ptyalism in a person.

**SAL'IVATED, pp.** Having an increased secretion of saliva from medicine.

**SAL'IVATING, ppr.** Producing increased secretion of saliva.

**SALIVA'TION, n.** The act or process of ptyalism, or of producing an excessive secretion of saliva; generally by means of mercury.

**SAL'IVOUS, a.** Pertaining to saliva; partaking of the nature of saliva.

**SAL'IX, n.** [*L. a willow.*] A genus of plants of the class and order Diœcia diandra, Linn.; nat. order Salicaceæ. It consists of numerous species, all either trees or bushes, occurring abundantly in all the cooler parts of the northern hemisphere. It comprehends the plants called osiers, willows, and is of great economical value, not only for the purposes of the

basketmaker, but because several species have a bark which contains a great quantity of tannin. Upwards of sixty species are enumerated by British botanists. [See SALICINE, WILLOW.]

SALLE, *n.* [Fr.] A hall.

SALLET, or SALADE, *n.* [Ger. *schale*, a shell, bowl, or cover.] A kind of light helmet of German origin, first used in the 15th century. Its characteristic mark is the projection behind.

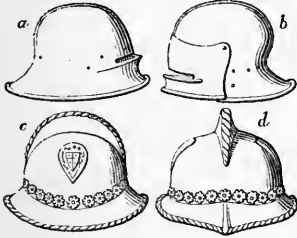

Sallets.

a, German Sallet, with fixed visor, of fifteenth century.  
b, English Sallet, with movable visor, of the reign of Henry VI.  
c, d, Sallet of the archers of sixteenth century; profile and front views.

Sallets were made of various forms, and with and without the visor.

SALLET, } *n.* † [Corrupted from SALLETING, } *salad.*]

SALLIANCE, † *n.* [from *sally.*] An issuing forth.

SALLIED, *pp.* Rushed out; issued suddenly.

SALLOW, *n.* [Sax. *salh*, *salig*; Fr. *saule*; L. *salix*; W. *helig*. Qu. from its colour resembling brine.] The common name of various species of the genus *Salix*, or willow kind. The salwos consist of shrubs or trees, with downy branches, and mostly obovate, grey, hoary toothed, more or less wrinkled, and stipuled leaves. The great round leaved sallow (*salix caprea*) puts forth its handsome yellow blossoms very early in the spring. Its bark is much used for tanning, and its wood for making implements of husbandry. It is also grown for hoop-making.

SALLOW, *a.* [Sax. *salowig*, *sealve*, from *salh*, L. *salix*, the tree, supra.] Having a yellowish colour; of a pale, sickly colour, tinged with a dark yellow; as, a *sallow* skin.

SALLOWNESS, *n.* A yellowish colour; paleness, tinged with a dark yellow; as, *sallowness* of complexion.

SALLOW THORN. See HIPPOPHAE.

SALLY, *n.* [Fr. *saillie*. See the Verb.] In a general sense, a spring; a darting or shooting. Hence, 1. An issue or rushing of troops from a besieged place to attack the besiegers.—2. A spring or darting of intellect, fancy, or imagination; flight; sprightly exertion. We say, *sallies* of wit, *sallies* of imagination.—3. Excursion from the usual track; range.

He who often makes *sallies* into a country, and traverses it up and down, will know it better than one that goes always round in the same track. Locke.

4. Act of levity or extravagance; wild gaiety; frolic; a bounding or darting beyond ordinary rules; as, a *sally* of youth; a *sally* of levity.—5. In *arch.*, a projection; the end of a piece of timber cut with an interior angle formed by two planes across the fibres, as the feet of common rafters.

SALLY, *v. i.* [Fr. *saillir*; It. *salire*; L. *salio*, Qu. Gr. *ἐλασαι*, which is allied to the Ar. *alla*, or *halla*, both of which signify to impel, or to shoot. See SOLAR, from L. *sol*, W. *haul*, Gr. *ἥλιος*.] 1. To issue or rush out, as a body of troops from a fortified place, to attack besiegers.

They break the truce, and *sally* out by night. Dryden.

2. To issue suddenly; to make a sudden irruption.

SALLYING, *pp.* Issuing or rushing out.

SALLY-PÖRT, *n.* In *fortification*, a postern gate, or a passage under ground from the inner to the outer works, such as from the higher flank to the lower, or to the tenailles, or to the communication from the middle of the curtain to the ravelin.—2. A large port on each quarter of a fireship, for the escape of the men into boats when the train is fired.

SALMAGUNDI, *n.* [Fr. *salmigondis*; from the Lat. *salgama*, powdered or pickled meats, fruits, &c.] A mixture of chopped meat and pickled herring with oil, vinegar, pepper, and onions.

SALMIAC, a contraction of *sal ammoniac*.

SALMON, *n.* (sam'mon.) [L. *salmo*; Fr. *saumon*.] A fish of the genus *Salmo*, the *S. salar*, Linn., found in all the northern climates of Europe, America, and Asia, ascending the rivers for spawning in spring, and penetrating to their head streams. It is a remarkably strong fish, and will even leap over considerable falls which lie in the way of its progress. It has been known to grow to the weight of 75 pounds; more generally it is from 15 to 25 pounds. It furnishes a delicious dish for the table, and is an article of commerce. The rivers of Scotland furnish immense quantities of salmon, especially the Tweed, the Tay, and the Spey. The total value of the salmon caught in the Scotch rivers has been estimated at £150,000 a year.

SALMONET, *n.* (sam'monet.) A little salmon; a samlet.

SALMONIDÆ, *n.* The salmon tribe, a family of fishes belonging to the Malacopterygii abdominales, of which the salmon is the type. Numerous species are found in the northern hemisphere, one of the largest of which is the common salmon, (*S. salar*). Osmerus, Mallotus, Thymallus, Coregonus, Argentina, Anastomus, and Gasteroplectus, are among the genera.

SALMONOID, *a.* or *n.* A term applied to fishes belonging to a tribe of which the salmon is the type.

SALMON-TROUT, *n.* (sam'mon-trout.) The *salmo trutta*, a species which in value ranks next to the salmon itself. It resembles the salmon in form and colour, and is, like it, migratory, ascending rivers, to deposit its spawn.

SALOON, *n.* [It. *salone*, from *sala*, hall; Sp. and Fr. *salon*. See HALL.]

In *arch.*, a lofty, spacious hall, frequently vaulted at the top, and usually comprehending two stories, with two ranges of windows. It is a magnificent room in the middle of a building, or at the head of a gallery, &c. It is a state room much used in palaces in Italy, for the reception of ambassadors and other visitors. The term *salon* is applied to the reunions of Paris, which have always exercised consider-

able influence in all that relates to fashion, literature, and even politics.

SALOOP', } See SALEP.  
SALOP, }

SALPA, or SALP, *n.* A genus of soft-shelled or tunicated acephalous molluscs which float in the sea, protected by a transparent gelatinous coat, perforated for the passage of water at both extremities. These animals are very abundant in the Mediterranean, and the warmer parts of the ocean, and are frequently phosphorescent.

SALPICON, † *n.* [Sp. from *salpicar*, to besprinkle; Port. to corn, to powder, to spot; from *sal*, salt.] Stuffing; farce; chopped meat or bread, &c., used to stuff legs of veal; called also *salmagundi*.

SALPINX, *n.* [L.] In *anat.*, the eustachian tube.

SALPRUNEL/A, *n.* Fused nitre cast into cakes or balls.

SALSAFY, or SALSIFY, *n.* [Fr. *salsifs*.] A plant of the genus *Tragopogon*, the *T. porrifolius*, called also purple goat's beard. [See GOAT'S BEARD.]

SALSAMENTARIOUS, † *a.* [L. *salsamentarius*.] Pertaining to salt things. SAL SEIGNETTE', *n.* Rochelle salts; tartrate of potash and soda.

SALSILLA, *n.* A plant of the genus *Alstrœmena*, with edible tubers. It is a native of Peru.

SALSO-ACID, *a.* [L. *salsus*, salt, and *acidus*, acid.] Having a taste compounded of saltness and acidity. [Little used.]

SAL'SOLA, *n.* Saltwort, a genus of plants, nat. order Chenopodiaceæ, so named from



Salso-hell.

Lat. *salsus*, salt, in consequence of many of the species yielding kelp and barilla. The species are found chiefly on the sea-shore in temperate parts of the world, and also in hot parts where the soil is saline, or there is salt water in the vicinity. *S. kali*, found on the coasts of Europe and many parts of the

world, is one of the species which is burnt for the purpose of yielding kelp and barilla. *S. sativa*, found on the coasts of Spain, is employed for the same purpose. Other species, on the coasts of the Red Sea, yield soda. *S. kali* and *S. frutescens* are British plants.

SALSUGINOUS, *a.* [from L. *salsugo*, from *sal*, salt.] Salty; somewhat salt.

SALT, *n.* [Sax. *salt*, *sealt*; G. *salz*; Fr. *sel*; L. Sp. and Port. *sal*; Gr. *ἅλς*: W. *halen*; Corn. and Arm. *halinn*, from *whâl*, salt, a pervading substance. The radical sense is, probably, pungent, and if *s* is radical, the word belongs to the root of L. *salio*; but this is uncertain.] 1. Common salt is the chloride of sodium, formerly termed muriate of soda, a substance which has been known, and in common use, as a seasoner and preserver of food from the earliest ages. It is formed when chlorine and sodium or hydro-

chloric acid and soda come together. It possesses a crystalline structure, derived from the cube which is its primitive form. When in a state of purity it consists of 60 of chlorine, and 40 of sodium, in 100 parts. It is found in immense quantity dissolved in sea water, and in the water of salt springs, and in smaller quantity in all natural waters, by which, indeed, it is carried to the sea, where it accumulates. Salt is also found abundantly, as rock salt, in various countries, from fossil beds, or, as they are termed, salt mines, which are situated between the coal formation and the lias. It is obtained from sea water by simple evaporation, either spontaneous, or with the aid of heat; but immense quantities are obtained from the salt mines in the neighbourhood of Northwich, in Cheshire, and the salt springs in Cheshire and Worcestershire furnish a large proportion of the salt made use of in Great Britain. One chief use of salt is as an antiseptic in curing meat, but its most important use is as a condiment to food, or rather as a substance indispensable to digestion. It is also employed to yield hydrochloric acid, and chlorine for the making of bleaching powder, as well as the best carbonate of soda. It forms a glaze for coarse pottery; it improves the whiteness and clearness of glass; it gives hardness to soap; it is used as a mordant, and for improving certain colours; and enters more or less into many other processes of the arts.—2. In *chem.*, a term applied to all combinations of acids with alkaline or salifiable bases. The term has also been extended to certain binary combinations of chlorine, iodine, bromine, and fluorine, with the metals, and these have been termed *haloid salts*. [See HALOID.] Certain definite combinations of the sulphurets with each other, have of late been called *sulphur salts*. Turner, in his Chemistry, groups together all saline compounds which have a certain similarity of composition into one great class of *salts*, which he divides into the four following orders:—1. The oxy-salts. This order includes no salt the acid or base of which is not an oxidized body; as for example, when sulphuric acid unites with soda, the result being sulphate of soda. 2. The hydro-salts. This order includes no salts, the acid or base of which does not contain hydrogen. 3. The sulphur-salts. This order includes no salt, the electro-positive or negative ingredient of which is not a sulphuret. Such salts are, in this country, generally classed together as double sulphurets: thus, copper pyrites; or double sulphuret of iron and copper, is a sulphur-salt. 4. The haloid salts. This order includes no salt the electro-positive or negative ingredient of which is not haloid: thus, the whole series of the metallic chlorides, iodides, bromides, and fluorides, are *haloid salts*. Salts have been conveniently, though not quite correctly, divided into alkaline, earthy, and metallic salts; for, strictly speaking, most of the two former belong to the latter, and to these classes must be added ammoniacal salts, and the salts of the vegetable alkalies. The nomenclature of salts has reference to the acids which they contain. For example, *sulphates, nitrates, carbonates*, &c., imply salts of the sulphuric, nitric, and carbonic acids. The termination

*ate* implies the maximum of oxygen in the acids, and *ite* the minimum. If neither the acid nor base of a salt be in excess, it is termed a *neutral salt*; if the acid predominate, it is called an *acid salt*, a *bi salt*, or a *super salt*, and if the base prevail, it is called a *basic salt*, or a *sub-salt*. Many salts are *hydrous*, that is, they contain a definite proportion of water of crystallization; others are dry or *anhydrous salts*. Some salts attract moisture when exposed to air, and are called *deliquescent*; others suffer their water to escape, and become opaque or pulverulent: these are called *efflorescent salts*. The combination of salts with each other gives rise to compounds called *double salts*; as the sulphate of lime and soda, the boro-fluoride of potassium, &c. Most of the double salts hitherto examined consist of the same acid and two different bases. The neutral state of salts is commonly indicated by their solutions not changing the colours of litmus, violets, or red cabbage; the sub-state of salts, by their turning the colours of violets and cabbage into green; and the super-state of salts, by their changing the purple of litmus, violets, and cabbage into red; but to the generality of this criterion there are some exceptions. According to the views of modern chemists, all true acids are hydrogen compounds, and all their salts compounds of metals with radicals, simple or compound. Hence they define an acid to be "the hydrogen compound of a simple or compound radical, possessing the power of neutralizing bases;" and a salt, "the compound formed by replacing the hydrogen of an acid by a metal."—3. Taste; sapor; smack.

We have some *salt* of our youth in us. *Shak.* 4. Wit; poignancy; as, *Attic salt*.—5. That which seasons or gives flavour; that which preserves from corruption.—6. The part of a river near the sea, where the water is salt.—7. A vessel for holding salt. [Used most commonly in the plural; as, a pair of salts.] 8. A cant name for a sailor; as, he is an old salt.

SALT, *a.* Having the taste of salt; impregnated with salt; as, *salt beef*; *salt water*.—2. Abounding with salt; as, a *salt land*; Jer. xvii.—3. Overflowed with salt water, or impregnated with it; as, a *salt marsh*.—4. Growing on salt marsh or meadows and having the taste of salt; as, *salt grass* or hay.—5. Producing salt water; as, a *salt spring*.—6. Lecherous; salacious.—7. Pungent, or bitter; as, *salt scorn*.—8. Costly. [Colloq.]

SALT, *v. t.* To sprinkle, impregnate, or season with salt; as, to *salt* fish, beef, or pork.—2. To fill with salt between the timbers and planks, as a ship, for the preservation of the timber.

SALT, *v. i.* To deposit salt from a saline substance; as, the brine begins to *salt*. [Used by manufacturers.]

SALT, *† n.* [Fr. *saut*, from *saillir*, to leap.] A leap; the act of jumping.

SALTANT, *a.* [L. *sallans*, from *salto*, to leap.] Leaping; jumping; dancing. In *her.*, a term applied to the squirrel, weasel, rat, and all vermin, and also to the cat, greyhound, ape, and monkey, when in a position springing forward.

SALTATION, *n.* [L. *sallatio*, from *salto*, to leap.] 1. A leaping or jumping.—2. Beating or palpitation; as, the *sallation* of the great artery.

SALTATORIA, *n.* The name given by Cuvier to his second family of orthopterous insects, which have their hind legs adapted for leaping; as grasshoppers, crickets, locusts, &c.

SALTATORY, } *a.* Leaping or } dancing; or having } the power of leaping or } dancing; adapted for leaping. The hind legs of the kangaroo, cricket, &c., are *saltatory*.

SALT-BOX, *n.* A wooden box, rather deep, with a sloped lid, used for holding salt in kitchens, &c. In *burlesque music*, the salt-box is made to yield a modulated clatter in a mock serenade or charivari; and used to be common in stage buffoonery.

SALT-CAT, *n.* A lump or heap of salt, made at the salt-works, which attracts pigeons; also a mixture of gravel, loam, rubbish of old walls, cummin seed, salt, and stale urine, for food to pigeons; called also a *pigeon-cat*.

SALT-CELLAR, *n.* [salt and cellar.] A small vessel used for holding salt on the table.

SALT'ED, *pp.* Sprinkled, seasoned, or impregnated with salt.

SALT'ER, *n.* One who salts; one who gives or applies salt.—2. One that sells salt.—3. A drysalter. The incorporated *salters*, or drysalters, of London, form one of the ninety-eight city companies.

SALT'ERN, *n.* A salt-work; a building in which salt is made by boiling or evaporation.

SALT FISH, *n.* Fish in brine; or fish salted and dried.—2. † A fish from salt water.

SALT GREEN, † *a.* Green like the sea. SALTICUS, *n.* A genus of wandering spiders, which do not spin webs, and are to be observed on walls, palings, &c., in hot and fine weather. The *S. formicarius* is a common British species.

SALTIER, } *n.* [Fr. *sautoir*, from *sauter*, } to leap.] L. *salto*, to leap.] In *her.*, an ordinary in the form of a St. Andrew's cross; formed by two bends, dexter and sinister, crossing each other. Long-shaped charges (swords, batons, &c.), placed in the direction of the



Saltier.

saltier, are said to be borne *saltier-wise*. SALTIGRADES, *n.* [L. *saltus*, a leap, and *gradior*, to walk.] A tribe of spiders which seize their prey by leaping upon it from a distance.

SALTINBANCO, † *n.* [Fr. *saltimbanque*; It. *saltare in banco*, to leap on the bench, to mount on the bench.] A mountebank; a quack.

SALT'ING, *pp.* Sprinkling, seasoning, or impregnating with salt.

SALT'ING, *n.* The act of sprinkling or impregnating with salt.—2. A salt water marsh.

SALT'ISH, *a.* Somewhat salt; tinctured or impregnated moderately with salt.

SALT'ISHLY, *adv.* With a moderate degree of saltiness.

SALT'ISHNESS, *n.* A moderate degree of saltiness.

SALT'LESS, *a.* Destitute of salt; insipid.

SALT'LY, *adv.* With taste of salt; in a salt manner.

SALT-MARSH, *n.* Land under pasturo grasses or herbage plants, subject to

be overflowed by the sea, or by the waters of estuaries, or the outlets of rivers which, in consequence of proximity to the sea, are more or less impregnated with salt.

**SALT-MINE**, *n.* A mine where fossil salt is obtained. The principal salt mines are at Wielitka, in Poland; Catalonia, in Spain; Altemonte, in Calabria; Loo-wur, in Hungary; in many places in Asia and Africa, and in Cheshire, in England.

**SALT'NESS**, *n.* The quality of being impregnated with salt; as, the *saltiness* of sea-water or of provisions.—2. Taste of salt.

**SALT OF AMBER**. Succinic acid.

**SALT OF LEMONS**. Binoxalate of potassa. It is used for the removal of iron moulds, and other stains from linen.

**SALT OF SATURN**. Acetate of lead.

**SALT OF SODA**. Carbonate of soda.

**SALT OF SORREL**. Oxalate of potash.

**SALT OF TARTAR**. Carbonate of potassa.

**SALT OF VITRIOL**. Sulphate of zinc.

**SALT'-PAN**, } *n.* a pan, basin, or pit  
**SALT'-PIT**, } where salt is obtained or made.

**SALT PERLATE**. Phosphate of soda.

**SALTPETRE**, *n.* [*salt* and Gr. *πετρε*, a stone.] A neutral salt formed by the nitric acid in combination with potassa, and hence denominated nitrate of potassa. It is found native in the East Indies, in Spain, in Naples, and other places. It is also found on walls sheltered from rain, and is extracted by lixiviation from the earths under cellars, stables, barns, &c. [See NITRE.]

**SALTPETROUS**, *a.* Pertaining to saltpetre, or partaking of its qualities; impregnated with saltpetre.

**SALT-RHEUM**, *n.* A vague and indefinite popular name, applied to almost all the non-febrile cutaneous eruptions, which are common among adults, except ring-worm and itch.

**SALTS**, *n.* In *America*, the salt water of rivers entering from the ocean.—2. Cathartic medicines.—3. In *chem.*,—see **SALT**, No. 2.

**SALT-SPRINGS**, *n.* Springs containing salt, as those of Droitwich, in Worcestershire.

**SALT-WATER**, *n.* Water impregnated with salt; sea-water.

**SALT-WORK**, *n.* A house or place where salt is made.

**SALT-WÖRT**, *n.* A vague and indefinite popular name applied to most of the numerous species of *salsola*, and also to some species of *salicornia* and *glauz*. [See **SALSOLA**.]

**SALTY**, *a.* Somewhat salt.

**SALUBRIOUS**, *a.* [*L. saluber, salubris*, from *salus*. See **SAFE**.] Favourable to health; healthful; promoting health; as, *salubrious* air or water; a *salubrious* climate.

**SALUBRIOUSLY**, *adv.* So as to promote health.

**SALUBRIOUSNESS**, } *n.* [*L. salubri-*  
**SALUBRITY**, } *tas*.] Wholesomeness; healthfulness; favourableness to the preservation of health; as, the *salubrity* of air, of a country or climate.

**SALUTARINESS**, *n.* [See **SALUTARY**.] Wholesomeness; the quality of contributing to health or safety.—2. The quality of promoting good or prosperity.

**SALUTARY**, *a.* [*Fr. salutaire*; *L.*

*salutaris*, from *salus*, health.] 1. Wholesome; healthful; promoting health. Diet and exercise are *salutary* to men of sedentary habits.—2. Promotive of public safety; contributing to some beneficial purpose. The strict discipline of youth has a *salutary* effect on society.

**SALUTA'TION**, *n.* [*Fr.* from *L. salutatio*. See **SALUTE**.] The act of saluting; a greeting; the act of paying respect or reverence by the customary words or actions, by gestures or by mutual contact; as in inquiring of persons their welfare, expressing to them kind wishes; bowing; pressing of hands, embracing, kissing, &c.; Luke i; Mark xii.

In all public meetings and private addresses, use the forms of *salutation*, reverence, and decency, usual among the most sober people. *Taylor*.

**SALUTATORY**, *a.* Greeting. In the *U. States*, an epithet applied to the oration which introduces the exercises of the commencements in colleges.

**SALUTATO'RIAN**, *n.* in the *U. States*, the student of a college who pronounces the salutatory oration at the annual commencement.

**SALUTATORILY**, *adv.* By way of salutation.

**SALUTARILY**, *adv.* Favourably to health.

**SALÜTE**, *v. t.* [*L. saluto*; *Fr. saluer*; from *L. salus* or *salvus*.] 1. To greet; to hail; to address with expressions of kind wishes.

If ye *salute* your brethren only, what do ye more than others? *Matt. v.*

2. To please; to gratify. [*Unusual*.]

—3. To kiss.—4. In *military* and *naval affairs*, to honour some person or nation by a discharge of cannon or small arms, by striking colours, by shouts, &c.

**SALÜTE**, *n.* The act of expressing kind wishes or respect; salutation; greeting.—2. A kiss.—3. In *milit. affairs*, a discharge of cannon or small arms in honour of some distinguished personage. A salute is sometimes performed by lowering the colours or beating the drums. The officers also salute each other by lowering their swords.—4. In the *navy*, a testimony of respect or deference rendered by the ships of one nation to the ships of another, or by ships of the same nation to a superior or equal. This is performed by a discharge of cannon, volleys of small arms, striking the colours or top-sails, or by shouts of the seamen mounted on the masts or rigging. When two squadrons meet, the two chiefs are only to exchange salutes.

**SALÜTED**, *pp.* Hailed; greeted.

**SALÜTER**, *n.* One who salutes.

**SALUTIF'EROUS**, *a.* [*L. salutifer*; *salus*, health, and *fero*, to bring.] Bringing health; healthy; as, *salutiferous* air.

**SALVABILITY**, *n.* [from *salvable*.] The possibility of being saved or admitted to everlasting life.

**SALVABLE**, *a.* [*L. salvus*, safe; *salvo*, to save.] That may be saved or received to everlasting happiness.

**SALVABLENESS**, *n.* State of being salvable.

**SALVABLY**, *adv.* In a salvable manner.

**SALVADORA**, *n.* A genus of plants, nat. order, Chenopodiaceæ. *S. Persica* is supposed to be the mustard plant of scripture, which has very small seeds, and grows into a tree. Its fruit is suc-

culent and tastes like garden cress. The bark of the root is acrid.

**SALV'AGE**, *n.* [*Fr. salvage, sauvage*, from *L. salvus*; *salvo*.] In *com.*, an allowance or compensation made to those by whose exertions ships or goods have been saved from the dangers of the seas, fire, pirates, or enemies. The crew of a ship are not entitled to salvage for any extraordinary efforts they may have made in saving her, but passengers are entitled to recompense for extraordinary services performed in the hour of danger. If the salvage be performed at sea, or within high or low water mark, the court of Admiralty has jurisdiction over the subject, and will fix the sum to be paid, and adjust the proportions, which vary according to circumstances. In cases where the parties cannot agree, the salvors may retain the property until compensation is made; or they may bring an action or commence a suit in the Admiralty court, against the proprietors, for the amount claimed.

**SALV'AGE**, † *n.* A savage, or wild aborigine.

**SALVATEL'LA**, *n.* [*L. salus*, health.] In *anat.*, a vein which runs along the little finger, unites upon the back of the hand with the cephalic of the thumb, and empties its blood into the external and internal cubital veins. It was formerly regarded as having peculiar influence on the health, when opened.

**SALVA'TION**, *n.* [*It. salvazione*; from *L. salvo*, to save.] 1. The act of saving; preservation from destruction, danger or great calamity.—2. Appropriately in *theology*, the redemption of man from the bondage of sin and liability to eternal death, and the conferring on him everlasting happiness. This is the *great salvation*.

Godly sorrow worketh repentance to salvation; 2 Cor. vii.

3. Deliverance from enemies; victory; Exod. xiv.—4. Remission of sins, or saving graces; Luke xix.—5. The author of man's salvation; Ps. xxvii.—6. A term of praise or benediction; Rev. xix.

**SALVATORY**, *n.* [*Fr. salvatoire*.] A place where things are preserved; a repository.

**SÄLV**, *n. l. mute.* [*Sax. sealfe*; from *L. salvus*.] 1. An adhesive composition or substance to be applied to wounds or sores; when spread on leather or cloth, it is called a *plaster*.—2. Help; remedy.

**SÄLV**, *v. t. l. mute.* To heal by applications or medicaments. [*Little used*.]

—2. To help; to remedy. [*Little used*.]

—3. To help or remedy by a *salvo*, excuse, or reservation. [*Lit. us.*].—4. † To salute.

**SÄLV'ER**, *n.* A piece of plate with a foot; or a plate on which any thing is presented.—2. † One who salves or cures, or rather one who pretends to cure; as, a quack-*salver*.

**SÄLV'ER-SHAPED**, *a.* In *bot.*, a term applied to a mon-



Salver-shaped.

petalous corolla, having the tube short, and the limb spreading out flat, as in the primrose.

**SÄLVIA**, *n.* Sage, a genus of plants. [See **SAGE**.]

**SALVIF'IC**, *a.* [*L. salvus* and *facio*.] Tending to save or secure safety. [*A bad word and not used*.]

**SALVINIA'CEÆ**, *n.* A small nat.

order of acrogenous or flowerless plants, comprising only two genera, *salvinia*, and *azolla*, the first common in the south of Europe, the other a New Holland plant.

**SAL'VO, n.** [from the *L. salvo jure*, an expression used in reserving rights.] An exception; reservation; an excuse.

They admit many *salvos*, cautions, and reservations. *K. Charles.*

2. A military or naval salute; as, a *salvo* of artillery.

**SAL-VOL'ATILE, n.** Carbonate of ammonia; also, a spirituous solution of carbonate of ammonia flavoured with aromatics.

**SAL'VO PUDO'RE, [L.]** Without offending modesty.

**SAL'VO SENSU, [L.]** Preserving the sense.

**SALV'OR, n.** One who saves a ship or goods at sea.

**SAMA'RA, n. [L.]** An indehiscent superior fruit, being a few-seeded indehiscent dry nut, elongated into wing-like expansions, as in the fruit or *key*



Samara.

of the ash tree, elm, sycamore, &c. From this root is formed the word *Samaroid*, expressing a resemblance to a samara.

**SAMAR'TAN, a.** Pertaining to Samaria, the principal city of the ten tribes of Israel, belonging to the tribe of Ephraim, and, after the captivity of those tribes, reoccupied by Cushites from Assyria or Chaldea.—2. Denoting the ancient characters and alphabet used by the Hebrews.

**SAMAR'TAN, n.** An inhabitant of Samaria, or one that belonged to the sect which derived their appellation from that city. The Jews had no dealings with the *Samaritans*.—2. The language of Samaria, a dialect of the Chaldean.

**SAM'BO, n.** The offspring of a black person and a mulatto.

**SAMBU'CUS, n.** A genus of plants, natives of Europe and North America. Two British species, *S. ebulus* and *S. nigra*, are known by the common name of elder. [See ELDER.]

**SAME, a.** [Sax. *same*; Dan. *somme*, *same*, and *sammen*, together; Sw. *samme*, *same*; Dan. *samlar*, *forsamlar*; to collect, to assemble; D. *zaam*, *zamen*, together; *zamelen*, to assemble; G. *sammeln*, id.; Sax. *samod*, *L. simul*, together; Sax. *samian*, *semian*, to assemble, to sum; W. *sum*, *sum*, amplitude; *sum*, the state of being together; *samer*, that supports or keeps together, a beam, Eng. *summer*, in building. We observe that the Greek *zuz* agrees in signification with the *L. simul*, and Sax. *samod*, Sans. *sam*, together. Shall we suppose then that *s* has passed into an aspirate in this word, as in *sali*, Gr. *zuz*, or has the Gr. word lost *s*? The word *same* may be the *L. idem*, or *dem*, dialectically varied. The primary sense is to set, to place, to put together. See Ar.

*dhamma*, to draw together, to set together, to join, to collect.] 1. Identical; not different or other.

Thou art the *same*, and thy years shall have no end; Ps. cii.

The Lord Jesus, the *same* night in which he was betrayed, took bread; 1 Cor. xi.

2. Of the identical kind or species, though not the specific thing. We say, the horse of one country is the *same* animal as the horse of another country. The *same* plants and fruits are produced in the *same* latitudes. We see in men in all countries, the *same* passions and the *same* vices.

Th' eternal vigour is in all the *same*. *Dryden.*

3. That was mentioned before.

Do but think how well the *same* he spends, Who spends his blood his country to relieve. *Daniel.*

4. Equal; exactly similar. One ship will not run the *same* distance as another in the *same* time, and with the *same* wind. Two balls of the *same* size have not always the *same* weight. Two instruments will not always make the *same* sound.

**SAME, † adv.** [Sax. *sam*.] Together.

**SAMENESS, n.** Identity; the state of being not different or other; as, the *sameness* of an unchangeable being.—2. Near resemblance; correspondence; similarity; as, a *sameness* of manner; a *sameness* of sound; the *sameness* of objects in a landscape.

**SAM'IAN EARTH, [Gr. Samos, the isle.]** The name of a marl of two species, used in medicine as an astringent.

**SAM'IAN STONE, [L. samens lapis.]** A stone brought from the island of Samos, and used by goldsmiths in brightening and polishing gold.

**SAMIEL, SIMOOM', n.** [Ar. *samom*. The Ar. *sahama*, signifies to be thin, or to become thin or pale, and to suffer the heat of the simoom, and *samma* signifies to poison. This word signifies probably that which is deleterious or destructive.] A hot and destructive wind that sometimes blows in Arabia. [See SIMOOM.]

**SAM'TE†, n.** [Old Fr.] A species of silk stuff.

**SAM'LET, n.** Another name for the Parr,—*which see*.

**SAM'OLUS, n.** A genus of small herbs of the class Pentandria, and order monogynia, Linn.; nat. order Primulaceæ. *S. valerandi*, brook-weed or water-pimpernel, is a British perennial growing in watery places on gravelly soil.

**SAMP, n.** In *America*, a species of food composed of maize, broken or bruised, boiled and mixed with milk; a dish borrowed from the natives of *America*, but not much used.

**SAMP'AN, n.** A small canoe or boat attached to a prahu.

**SAM'PHIRE, n.** [Said to be a corruption of *Saint Pierre*.] Crithmum, a genus of plants. [See CRITHMUM.]—*Prickly samphire* is of the genus *Echinophora*, the *E. spinosa*.—*Golden samphire* is the *Anula crithmoides*. In the *U. States*, this name is applied to *Salicornia herbacea*, which is called glass-wort in England.

**SAMPLE, n.** [L. *exemplum*; Fr. *exemple*; Ir. *somplar*, *samlachas*, from *samhail*, similar.] 1. A specimen; a part of any thing presented for inspec-

tion or intended to be shown, as evidence of the quality of the whole; as, a *sample* of cloth or of wheat. Sugars, wool, spirits, wine, coffee, grain, cloth, and indeed most species of merchandise, are sold by sample. If an article be not at an average equal to the sample by which it is sold, the buyer may cancel the contract and return the article to the seller.

I design this as a *sample* of what I hope more fully to discuss. *Woodward.*

2. Example; instance.

**SAM'PLE, v. t.** To show something similar; to exemplify. [Unusual.]

**SAM'PLER, n.** [L. *exemplar*, supra.] A pattern of work; a specimen; particularly, a piece of needle-work by young girls for improvement.

**SAM'SON'S-POST, n.** In *ships*, a strong pillar resting on the keelson, and supporting a beam of the deck over the

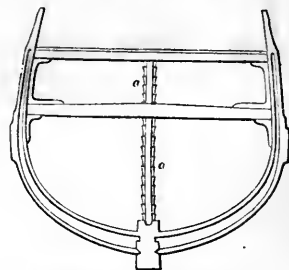

Section of Ship showing the Samson's post, a. a.

hold, and thus acting to keep the cargo in its place. It is furnished with several notches that serve as steps to ascend or descend.

**SAM'UEL, n.** The books of Samuel are two canonical books of the Old Testament. It is traditionally said that the prophet Samuel composed the first 24 chapters of the first book, and the prophets Gad and Nathan the remainder.

**SAMY'DA, n.** A genus of plants, nat. order Samydaceæ, of which it is the type. The species consist of small trees or shrubs, found in the hot parts of *America*.

**SAMYDA'CEÆ, n.** A nat. order of apetalous plants, placed by De Candolle amongst polypetalous exogens. The leaves have a mixture of round and pellucid dots, which distinguishes them from all the other families with which they are likely to be confounded. It is an entirely tropical order, composed of small trees and shrubs. The bark and leaves are said to be slightly astringent. One species, *Casearia ulmyfolia*, is used in Brazil as a remedy against the bite of snakes, the leaves being applied to the wound, and an infusion of them taken internally.

**SANABIL'ITY, } n. State of being**

**SAN'ABLENESS, } curable.**

**SAN'ABLE, a.** [L. *sanabilis*, from *sano*, to heal; *sanus*, sound. See SOUND.]

That may be healed or cured; susceptible of remedy.

**SANA'TION†, n.** [L. *sanatio*, from *sano*, to heal.] The act of healing or curing.

**SAN'ATIVE, a.** [L. *sano*, to heal.] Having the power to cure or heal; healing; tending to heal.

**SAN'ATIVENESS, n.** The power of healing.

**SAN'ATORY**, *a.* [L. *sano*, to heal.] Healing, curing. [Often erroneously used for **SANITARY**,—*which see.*]  
**SAN BENTO**, *n.* A kind of linen garment painted with hideous figures, and worn by persons condemned by the Inquisition. Also a coat of sackcloth



Victim of the Inquisition, attired in the San Benito,

worn by penitents on their reconciliation to the church.

**SANCE BELL**, *n.* A corruption of saint's bell,—*which see.*

**SANCTE BELL**. See **SACRING BELL**.

**SANCTIFICATE**, *v. t.* To sanctify.

**SANCTIFICATION**, *n.* [Fr. from Low L. *sanctificatio*, from *sanctifico*. See **SANCTIFY**.] 1. The act of making holy. In an *evangelical sense*, the act of God's grace by which the affections of men are purified or alienated from sin and the world, and exalted to a supreme love to God.

God hath from the beginning chosen you to salvation, through *sanctification* of the Spirit and belief of the truth; 2 Thess. ii.; 1 Pet. i.

2. The act of consecrating or of setting apart for a sacred purpose; consecration.

**SANCTIFIED**, *pp.* Made holy; consecrated; set apart for sacred services.—2. Affectedly holy.

**SANCTIFIER**, *n.* He that sanctifies or makes holy. In *theol.*, the Holy Spirit is, by way of eminence, denominated the *Sanctifier*.

**SANCTIFY**, *v. t.* [Fr. *sanctifier*; Low L. *sanctifico*; from *sanctus*, holy, and *facio*, to make.] 1. In a *general sense*, to cleanse, purify, or make holy.—2. To separate, set apart, or appoint to a holy, sacred, or religious use.

God blessed the seventh day and *sanctified* it; Gen. ii.

So under the Jewish dispensation, to *sanctify* the altar, the temple, the priests, &c.—3. To purify, to prepare for divine service, and for partaking of holy things; Exod. xix.—4. To separate, ordain, and appoint to the work of redemption and the government of the church; John x.—5. To cleanse from corruption; to purify from sin; to make holy by detaching the affections from the world and its defilements, and exalting them to a supreme love to God.

*Sanctify* them through thy truth; thy word is truth; John xvii.; Eph. v.

6. To make the means of holiness; to render productive of holiness or piety.

Those judgments of God are the more welcome, as a means which his mercy hath

*sanctified* so to me, as to make me repent of that unjust act. *K. Charles.*

7. To make free from guilt.

That holy man, amaz'd at what he saw,

Made haste to *sanctify* the bliss by law.

*Dryden.*

8. To secure free from violation.

Truth guards the poet, *sanctifies* the line.

*Pope.*

To *sanctify* God, to praise and celebrate him as a holy being; to acknowledge and honour his holy majesty, and to reverence his character and laws; Isa. viii.—*God sanctifies himself or his name*, by vindicating his honour from the reproaches of the wicked, and manifesting his glory; Ezek. xxxvi.

**SANCTIFYING**, *ppr.* Making holy; purifying from the defilements of sin; separating to a holy use.—2. *a.* Tending to sanctify; adapted to increase holiness.

**SANCTIFYINGLY**, *adv.* In a manner or degree tending to sanctify, or make holy.

**SANCTILOQUENT**, *a.* Discoursing on heavenly things.

**SANCTIMONIOUS**, *a.* [L. *sanctimonia*, from *sanctus*, holy.] Sainly; having the appearance of sanctity; as, a *sanctimonious* pretence.

**SANCTIMONIOUSLY**, *adv.* With sanctimony.

**SANCTIMONIOUSNESS**, *n.* State of being sanctimonious; sanctity, or rather the appearance of it; devoutness.

**SANCTIMONY**, *n.* [L. *sanctimonia*.] Holiness; devoutness; scrupulous austerity; sanctity, or the appearance of it. [*Little used.*]

**SANCTION**, *n.* [Fr. from L. *sanctio*, from *sanctus*, holy, solemn, established.]

1. Ratification, that which confirms or renders obligatory; an official act of a superior by which he ratifies and gives validity to the act of some other person or body. No bill or legislative measure introduced into parliament, although it should pass both houses, can have the force of law until it has received the royal *sanction*.—2. Authority; confirmation derived from testimony, character, influence, or custom.

The strictest professors of reason have added the *sanction* of their testimony. *Watts.*

3. A law or decree. [*Improper.*]

**SANCTION**, *v. t.* To ratify; to confirm; to give validity or authority to.

**SANCTIONED**, *ppr.* Ratified; confirmed; authorized.

**SANCTIONING**, *ppr.* Ratifying; authorizing.

**SANCTITUDE**, *n.* [L. *sanctus*, *sanctitudo*.] Holiness; sacredness.

**SANCTITY**, [L. *sanctitas*.] 1. Holiness; state of being sacred or holy. God attributes no *sanctity* to place.—

2. Goodness; purity; godliness; as, the *sanctity* of love; *sanctity* of manners.—3. Sacredness; solemnity; as, the *sanctity* of an oath.—4. A saint or holy being.

About him all the *sanctities* of heav'n.

[*Unusual.*] *Milton.*

**SANCTUARIZE**, *v. t.* [from *sanctuary*.] To shelter by means of a sanctuary or sacred privileges. [*A bad word and not used.*]

**SANCTUARY**, *n.* [Fr. *sanctuaire*; L. *sanctuarium*, from *sanctus*, sacred.] 1.

A sacred place; particularly among the Israelites, the most retired part of the temple at Jerusalem, called the *Holy of Holies*, in which was kept the ark of the covenant, and into which no person was permitted to enter except

the high priest, and that only once a year to intercede for the people. The same name was given to the most sacred part of the tabernacle; Lev. i; Heb. ix.—2. The temple at Jerusalem; 2 Chron. xx.—3. A house consecrated to the worship of God; a place where divine service is performed; Ps. lxxiii. Hence *sanctuary* is used for a church.

—4. In *Roman catholic churches*, that part of a church where the altar is placed.—5. A place of protection; a sacred asylum. Hence a *sanctuary-man* is one that resorts to a sanctuary for protection. From the time of Constantine downwards, certain churches have been set apart in many catholic countries, to be an asylum for fugitives from the hands of justice. In England, particularly down to the Reformation, any person who had taken refuge in a sanctuary was secured against punishment, if within the space of forty days he gave signs of repentance, and subjected himself to banishment. In Scotland, the Abbey of Holyroodhouse and its precincts, as having been a royal residence, have the privilege of giving sanctuary to debtors in civil debts. When a person retires to the sanctuary he is protected against personal diligence, which protection continues for twenty-four hours; but to enjoy it longer the person must enter his name in the books kept by the baillie of the Abbey. This sanctuary does not protect a crown debtor, nor a fraudulent bankrupt.—6. Shelter; protection.

Some relies of painting took *sanctuary* under ground. *Dryden.*

**SANCTUM SANCTORUM**, [L.] Most holy place.

**SAND**, *n.* [Sax. *sand*; G. Sw. and Dan. *sand*; D. *zand*.] 1. Any mass or collection of fine particles of stone, particularly of fine particles of silicious stone, but not strictly reduced to powder or dust. A mass of any comminuted minerals is, in popular language, called sand, but the most abundant ingredient in the extensive sands of the deserts is granular quartz, or flint. Most of the sands which we observe, whether on the surface of the ground, or in strata at a certain depth, whether forming the beds of rivers or the shores of the sea, are the ruins of disintegrated rocks, and are red, white, grey or black, according to the rocks from which they were derived, such as granitic, porphyritic, and other pyrogenous rocks. Soil often contains sand, though the subjacent strata be wholly calcareous or finely argillaceous. Valuable metallic ores, as those of gold, platinum, tin, copper, iron, titanium, often occur in the form of sand or mixed with that substance. Pure silicious sands are very valuable for the manufacture of glass, for making mortars, filters, ameliorating dense clay soils, for making moulds in founding, and many other purposes.—2. *Sands*, in the plural, tracts of land consisting of sand, like the deserts of Arabia and Africa, as the *Libyan sands*.

**SAND**, *v. t.* To sprinkle with sand. It is customary among the common people to *sand* their floors.—2. † To drive upon the sand.

**SAN'DAL**, *n.* [Fr. *sandale*; L. *sandalium*; Gr. *sandalion*. Qu. Syr. *san*, to shoe.] 1. A kind of shoe, consisting of a sole fastened to the foot, with a hollow part at one extreme to embrace the ankle and leave the upper part of

the foot bare. Originally sandals were made of leather, but they afterwards became articles of great luxury; being made of gold, silver, and other precious materials, and beautifully ornamented. The Greek and Roman ladies

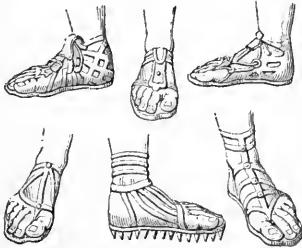

Grecian and Roman sandals.

wore sandals of a rich stuff ornamented with gold or silver.—2. A shoe or slipper worn by the Pope and other Romish prelates when they officiate. A like sandal is worn by several congregations of monks.

**SAN'DALIFORM, a.** Shaped like a sandal or slipper.

**SAN'DAL-WOOD, or SAND'ERS-WOOD, n.** [Ar. *sonadilin*; Pers. *joudal*.] The wood of a tree of the genus *santalum*, the *S. album*, which is a low tree, having a general resemblance to the Privet or Prim. When the sandal tree becomes old, the harder central wood acquires a yellow colour and great fragrance, while the softer exterior wood remains white and destitute of fragrance. The former is what is called yellow sandal wood, and the latter white sandal wood. Some botanists, however, are of opinion that the yellow sandal wood is the produce of a



Sandal wood (*Santalum album*).

different tree. It is the yellow wood only, which is highly esteemed for its perfume, and which is considered so valuable for musical instruments, boxes, cabinets, &c. This article grows chiefly on the coast of Malabar and in the Indian Archipelago. [See **SANTALUM**.] *Red sandal wood, or Red sanders Wood* is the produce of a tree of the genus *Pterocarpus*, the *P. santalinus*, a native of India. It is used as a dye-wood, and as a slight astringent in medicine. In India, it is employed, along with one-tenth of Sapan wood, principally for dyeing silk and cotton. The colouring principle is called *Santaline*. [See **PTEROCARPUS**.]

**SAN'DALLED, pp.** Wearing sandals

**SAN'DARAC, SAN'DARACH, n.** [L. *sandaraca*; Ar. *sandros*.] 1. A resin in white tears, more transparent than those of mastice. There is reason to think that the produce of different plants takes this name when it has the same external characters; but what may more properly be called *sandarach* is believed to be the produce of *Callitris quadrivalvis* of Roxburgh, and *Thyia articulata* of Vahl. It is used in powder, and mingled with a little chalk, to prevent ink from sinking or spreading on paper. This is the substance denoted by the Arabic word, and it is also called *varnish*, as it enters into the preparations of varnish. [See **POUNCE**.]—2. A native fossil; also, the combination of arsenic and sulphur, called realgar, which is the protosulphuret of arsenic.

**SAND'-BAGS, n.** Bags for holding sand or earth, and used in a fortification for repairing breaches, &c.

**SAND'-BATH, n.** A bath made by warm or hot sand, with which something is enveloped.

**SAND'-BLIND, a.** Having a defect of sight, by means of which small particles appear to fly before the eyes.

**SAND'-BOX, n.** A box with a perforated top or cover, for sprinkling paper with sand.—2. A tree or plant of the genus *Hura*, the *H. crepitans*. It is

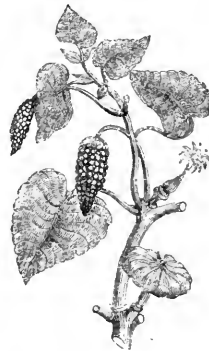

Sand-box Tree (*Hura crepitans*).

said that the pericarp of the fruit will burst in the heat of the day with a loud report, and throw the seeds to a distance.

**SAND'-CRACKS, n.** Fissures in the hoofs of a horse, commonly of those before; the effect of which is to lame the horse.

**SAND'-DRIFT, n.** Drifting sand; drifted sand.

**SAND'ED, pp.** Sprinkled with sand; as a *sanded floor*.—2. *a.* Covered with sand; barren.—3. Marked with small spots; variegated with spots; speckled; of a sandy colour, as a hound.—4. Short sighted.

**SAND'-EEL, n.** The ammodyte, a fish that resembles an eel. It seldom exceeds a foot in length; its head is compressed, the upper jaw larger than the under one, the body cylindrical, with scales hardly perceptible. There is one species only, a native of Europe. It coils with its head in the centre, and penetrates into the sand; whence its name in Greek and English. It is delicate food.

**SANDEMAN'IAN, n.** A follower of Robert Sandeman, a Scotch Antino-

mian theologian; one of the sect called Glassites.

**SAN'DERLING, n.** A small wading bird of the genus *Tringa*, the *T. arenaria* of Illiger, which frequents many of our shores. The sanderlings differ from the sand-pipers only in having no thumb.

**SAND'ERS.** See **SANDAL WOOD**.

**SAND'ERS WOOD.** See **SANDAL WOOD**.

**SAN'DEVER, } n.** [Fr. *sain de verre*,  
**SAN'DIVER, }** or *saint de verre*,  
dross or recerement of glass.] Glass-gall; a whitish salt which is cast up from the materials of glass in fusion, and floating on the top, is skimmed off. A similar substance is thrown out in eruptions of volcanoes. It is used by gilders of iron, and in the fusion of certain ores. It is said to be good for cleansing the skin, and taken internally, is detergent.

**SAND'-FLOOD, n.** A vast body of sand moving or borne along the deserts of Arabia.

**SAND'-GROUSE, n.** A bird of the genus *Pterocles*, the *P. arenarius*. It belongs to the grouse family and inhabits Enrope. The *pin-tailed sand-grouse* is the *Pterocles setarius*, found abundantly on the arid plains of Persia.

**SAND'-HEAT, n.** The heat of warm sand in chemical operations.

**SAND'INESS, n.** [from *sandy*.] The state of being sandy; as, the *sandiness* of a road.—2. The state of being of a sandy colour.

**SAND'ING, n.** Sprinkling or covering with sand.—2. Among *house painters*, a process performed by throwing fine sand on the last coat of paint, while wet. It is frequently adopted in outside work and stairs.

**SAND'ISH, a.** [from *sand*.] Approaching the nature of sand; loose; not compact.

**SAND'IX, n.** A kind of minium or red lead, made of ceruse, but inferior to the true minium.

**SAND'-MARTIN, n.** A species of swallow, the *Hirundo riparia* of Wilson; also called the bank-swallow.

**SAND'ORICUM, n.** A genus of plants, nat. order Meliaceae. *S. indicum*, the only species, is an elegant tree of considerable size, found in the Molucca and Philippine Islands, as well as in the southern parts of India. The fruit is acid, and may be mixed with syrups to make cooling drinks. The root is bitter, and is used in medicine in bowel complaints. It is sometimes called false mangosteen, from some resemblance to its fruit, and also Indian sandal wood.

**SAND'PIPER, n.** A name applied to different species of birds, of the genus *Tringa*, as the Dunlin, Knot, Stint, &c.; but it is properly restricted to the *T. hypoleucos*, Linn. The sandpipers are shore birds, allied to the snipe, plover, curlew, and godwit. They are included by Cuvier in his Longirostral family of Gallatoriæ. [See **DUNLIN**.]

**SAND'STONE, n.** [*sand* and *stone*.] Stone composed of agglutinated grains of sand, which may be calcareous, silicious, or of any other mineral nature. Sandstone is in most cases chiefly composed of particles of quartz, united by a cement. The cement is in variable quantity, and may be calcareous or marly, argillaceous, or argillo-ferruginous or even silicious. The grains of quartz are sometimes scarcely distinguishable by the naked eye, and some-

times are equal in size to a nut or an egg; as in those sandstones called *conglomerates*, and sometimes pudding stone or breccia. The texture of some sandstones is very close, while in others it is very loose and porous. Some sandstones have a slaty structure, and have been called sandstone slate. In colour sandstone varies from gray to reddish brown, in some cases uniform, in others variegated. In addition to quartz, some sandstones contain grains of feldspar, flint, and silicious slate, or plates of mica. Some sandstones are ferruginous, containing an oxide or the carbonate of iron. Sandstone, though a secondary rock, has been formed at different periods and under different circumstances, and is hence associated with different rocks or formations. It is in general distinctly stratified, and the beds horizontally arranged, but sometimes they are much inclined, or even vertical. The strata of the new red sandstone are found lying immediately above the coal measures. It is a conglomerate. The old red sandstone forms the lowest member of the carboniferous group, and lies above the silurian rocks. It consists of many varieties and alternations of silicious sandstones and conglomerates of various colours, red predominating. It sometimes contains metallic substances, disseminated through the mass, or in beds or veins. Among these are sulphurets of iron, mercury, lead, and copper, and arsenical cobalt. Various organic remains occur in sandstone, among which are reeds, impressions of leaves, trunks of trees, and shells, both fluvial and marine. Sandstone in some of its varieties is very useful in the arts, and is often known by the name of *freestone*. When sufficiently solid it is employed as a building stone. Some varieties are used as mill-stones for grinding meal, or for wearing down other materials preparatory to a polish, and some are used for whetstones.

**SANDWICH**, *n.* Two thin slices of bread with meat between; probably so named from the person who first brought them into fashion.

**SAND-WÖRT**, *n.* The common name of several British species of plants of the genus *Arenaria*, class and order Decandria trigynia, Linn.; nat. order Alsinaceæ. They are found growing in sandy situations, but are of no value.

**SANDY**, *a.* [Sax. *sandig*.] 1. Abounding with sand; full of sand; covered or sprinkled with sand; as, a *sandy* desert or plain; a *sandy* road or soil.—2. Consisting of sand; not firm or solid; as, a *sandy* foundation.—3. Of the colour of sand; of a yellowish red colour; as *sandy* hair.

**SANE**, *a.* [L. *sanus*, Eng. *sound*; G. *gesund*. This is the Eng. *sound*, Sax. *sund*. See **SOUND**.] 1. Sound; not disordered, or shattered; healthy; as, a *sane* body.—2. Sound; not disordered; having the regular exercise of reason and other faculties of the mind; as, a *sane* person; a person of a *sane* mind.

**SANENESS**, *n.* State of being sane, or of sound mind.

**SANG**, *pret.* of *Sing*.

**SANGAREE**, *n.* In the *W. Indies*, and *U. States*, wine and water, sweetened and spiced, and sometimes iced.

**SANGARE'D**, *pp.* Reduced in strength and sweetened. [Applied to fermented liquors; as, wine, ale, &c.]

**SANG FROID**, *n.* (song froaw') [Fr. cold blood.] Coolness; freedom from agitation or excitement of mind.—2. Indifference.

**SAN'GIAC**, or **SAN'JAK**, *n.* A Turkish governor of a province.

**SAN'GIACATE**, *n.* (sänjäkâte.) A division of a pashalic, in Turkey.

**SANGUIFEROUS**, *a.* [L. *sanguifer*; *sanguis*, blood, and *fero*, to carry.] Conveying blood. The *sanguiferous* vessels are the arteries and veins.

**SANGUIFICATION**, *n.* [Fr. from L. *sanguis*, blood, and *facio*, to make.] In the *animal economy*, the production of blood; the conversion of chyle into blood.

**SANGUIFIER**, *n.* A producer of blood.

**SANGUIFLOUOUS**, *a.* [L. *sanguis*, blood, and *fluo*, to flow.] Floating or running with blood.

**SANGUIFY**, *v. i.* To produce blood.

**SANGUIFYING**, *ppr.* Producing blood.

**SANGUINARIA**, *n.* A genus of plants, nat. order Papaveraceæ. The *S. canadensis*, is the puccoon or bloodwort of North America; a polyandrous, flowering, tuberous rooted perennial. It is emetic and purgative in large doses, and in smaller quantities is stimulant, diaphoretic, and expectorant.

**SANGUINARILY**, *adv.* Bloodthirstily.

**SANGUINARINE**, *n.* A vegetable principle found in *Sanguinaria canadensis*. It forms a gray powder which is alkaline, and yields red salts. It excites sneezing, and is possibly identical with chelerythrine. [See **CHELIDONINE**.]

**SANGUINARY**, *a.* [Fr. *sanguinaire*; L. *sanguinarius*, from *sanguis*, blood.] 1. Bloody; attended with much bloodshed; murderous; as, a *sanguinary* war, contest, or battle.—2. Bloodthirsty; cruel; eager to shed blood.

Faasion...makes us brutal and *sanguinary*. *Broomie.*

**SANGUINARY**, *n.* A plant.

**SANGUINE**, *a.* [Fr. *sanguin*; L. *sanguineus*, from *sanguis*, blood.] 1. Red; having the colour of blood; as, a *sanguine* colour or countenance.—2. Abounding with blood; plethoric; as, a *sanguine* habit of body. [Technical.]

—3. Cheerful; warm; ardent; as, a *sanguine* temper, supposed to proceed from predominance of blood.—4. Confident. He is *sanguine* in his expectations of success. *Sanguine* is the term used by heralds to express murrey colour. It is expressed in engraving by diagonal lines crossing each other.

**SANGUINE**, *† n.* Blood colour.

**SANGUINE**, *v. i.* To stain with blood. [But *ensanguine* is generally used.]

—2. To stain or varnish with a blood colour.

**SANGUINELESS**, *a.* Destitute of blood; pale. [A bad word, and little used.]

**SANGUINELY**, *adv.* Ardently; with confidence of success.

**SANGUINENESS**, *n.* Redness; colour of blood in the skin; as, *sanguineness* of countenance.—2. Fulness of blood; plethora; as, *sanguineness* of habit.—3. Ardour; heat of temper; confidence.

**SANGUINEOUS**, *a.* [L. *sanguineus*.] 1. Bloody; appertaining to the blood.

2. Abounding with blood; plethoric; warm; ardent.—3. Constituting blood.

—4. Of a red or blood colour.

**SANGUINITY**, for *Sanguineness*, is not in use.

**SANGUINIVOROUS**, *a.* [L. *sanguis*,

blood, and *voro*, to eat.] Eating or subsisting on blood.

**SANGUIN'OLENT**, *a.* Bloody.

**SANGUISOR'BA**, *n.* A genus of plants, the type of the sub order Sanguisorbæ, in the nat. order Rosacæ. Of this genus, called burnet, there are several species, most of which possess astringent properties. The common burnet (*S. officinalis*) is a native of Britain, and was at one time cultivated in chalky districts to a very considerable extent as a fodder plant, but it has lately been superseded by sainfoin and other artificial grasses.

**SANGUISOR'BEÆ**, *n.* One of the sub. orders of the nat. order Rosacæ, consisting of herbaceous or under shrubby exogens. It is distinguished from Rosacæ proper by the constantly apetalous flowers, indurated calyx and solitary or almost solitary carpels. The general character is that of astringency.

**SANGUISUGA**, or **SANGUISUGES**, *n.* [L. *sanguis* blood, and *sugo*, to suck.]

A family of hemipterous insects, including those which suck the blood of animals; also applied to a family of Abbranchiate annelids, of which the leech (*Hirudo medicinalis*), is the type. [See **LEECH**.]

**SANGUISUGÉ**, *n.* [L. *sanguisuga*; *sanguis*, blood, and *sugo*, to suck.] The blood-sucker; a leech, or horse-leech.

**SAN'HEDRIM**, or **SAN'HEDRIN**, *n.* [Low L. *synedrion*; Gr. *συνεδριον*; *syn*, with, together, and *δρα*, seat.]

The great council among the Jews, whose jurisdiction extended to all important affairs. They received appeals from inferior tribunals, and had power of life and death. The Sanhedrim had a president, generally the high priest, and a vice president. The other members consisted of chief priests, elders, and scribes, in all amounting to seventy-one or seventy two, including the high priest.

**SAN'ICLE**, *n.* [from L. *sano*, to heal.] Sanicula, a genus of plants belonging to the nat. order Umbellifereæ, and so named from its supposed healing virtues. *S. Europæa*, wood sanicle or self-heal, is found in Britain growing in woods. It is now totally neglected as an official plant. The *American bastard sanicle* is of the genus *Mitella*, and the *bear's ear sanicle* of the genus *Cortusa*.

**SANID'IUM**, *n.* A genus of fossils of the class of selenites, composed of plain flat plates.

**SANIES**, *n.* [L.] A thin reddish discharge from wounds or sores; a serous matter, less thick and white than pus, and having a slight tinge of red.

**SANIOUS**, *a.* [from *sanies*.] Pertaining to sanies, or partaking of its nature and appearance; thin and serous, with a slight bloody tinge; as, the *sanious* matter of an ulcer.—2. Excreting or effusing a thin serous reddish matter; as, a *sanious* ulcer.

**SANITARY**, *a.* [Fr. *sanitaire*, L. *sanitas*.] Preservative of health; as, *sanitary laws*. [See **SANATORY**, with which this word is often confounded.]

**SAN'ITY**, *n.* [L. *sanitas*. See **SANE**.] Soundness; particularly, a sound state of mind; the state of a mind in the perfect exercise of reason.

**SAN'JAK**. See **SANGIAC**.

**SANK**, *pret.* of *Sink*, [often, but improperly, dropped, and sunk, the *pp.* substituted.]



**SAN'NAH**, *n.* The name of certain kinds of India muslin.

**SANS**, *prep.* [Fr.] Without; a term very generally used in blazonry, to express the omission or deprivation of some member of an animal, as a dragon or griffin *sans* wings.

**SAN'SCRIT**, *n.* [According to H. T. Colbrooke, *Sanscrit* signifies the polished dialect. It is sometimes written *Shanscrit*, and in other ways. *Asiat. Res.* 7, 200.] The ancient language of Hindoostan, from which are formed all the modern languages or dialects of the great peninsula of India. It is the language of the Bramins, and in this are written the ancient books of the country; but it is now obsolete. It is from the same stock as the ancient Persic, Greek and Latin, and all the present languages of Europe.

**SANS CEREMONIE**, [Fr.] Unceremoniously.

**SANS EULOTTES**, [Fr. without breeches.] Ragged fellows. The name given in derision to the popular party by the aristocratical in the beginning of the French revolution of 1789, and which was afterwards assumed by the patriots as a title of honour.

**SANS EULOTIDES**, *n. pl.* [Fr.] Five successive festival days, held annually, in republican France.

**SANSU'LOTTISM**, *n.* A ragged state of men.

**SANSEVIERA**, *n.* A genus of liliaceous plants, found on the coasts of Western Africa, of Ceylon, and other Eastern Islands, as well as of India. The species are remarkable for the strength and fineness of the fibres of their leaves, which are made into bow-strings by the natives, and might be manufactured into cordage, especially the fibres of the leaves of *S. Roxburghiana*, abundant in the southern parts of India.

**SANS SOULI**, [Fr.] Without care; free and easy.

**SANTALA'CEÆ**, *n.* A nat. order of exogenous plants. In the form of weeds the genera are found in Europe and North America; in New Holland, the East Indies, and the South Sea Islands, they exist as large shrubs or small trees. The most valuable genus is the *santalum*,—*which see*.

**SANTALINE**, *n.* The colouring matter of red sandal or sanders wood, which may be obtained by evaporating the alcoholic infusion to dryness. It is a red resin, fusible at 212°, and is very soluble in acetic acid, as well as in alcohol, essential oils, and alkaline leys.

**SANTALUM**, *n.* A genus of plants, nat. order Santalaceæ, and the type of that order. One or more species yield the sandal wood of commerce.—[*See SANDAL WOOD.*]

**SANTER**. *See SAUNTER.*

**SANTON**, *n.* A Turkish priest, a kind of dervish, regarded by the vulgar as a saint.

**SANTONINE**, *n.* A proximate vegetable principle, possessing acid properties, obtained from the seeds of the *artemisia santonica* or southernwood. It is colourless, crystallizable, and soluble in alcohol, and in the fixed and volatile oils.

**SAP**, *n.* [Sax. *sæp*; G. *stift*; Fr. *seve*; Arm. *sabr*; probably from softness or flowing. *Qui. Pers. zabah*, a flowing.]

1. The juice of plants of any kind. The fluid which plants imbibe from the soil in which they are placed, and the great source from which they are nourished, and their various peculiar secretions

produced. The constituents of sap may be divided into those which are necessary for the growth of all plants, which are carbon, oxygen, hydrogen, and nitrogen; and those which are necessary only for the growth of particular plants or families of plants, such as the oxides of potassium, sodium, calcium, and magnesium. The sap is absorbed by the roots from the soil and then sent upwards into the stem towards the leaves. It is afterwards conveyed back from the leaves, when it is assimilated and altered, to the bark. In its crude state it consists of little except water holding earthy and gaseous matter in solution; especially carbonic acid; but as it rises through the tissue of the stem, it dissolves the secretions it meets with in its course, and thus acquires new properties, so that by the time it reaches the leaves it is entirely different from its state when it first enters the root. It is not certainly known through what kind of tissue the upward motion of the sap takes place, but it is most probable that all the tissues of a plant are engaged in conveying sap, with the exception of the spiral vessels, which seem appropriated to the conveyance of air. The sap, on arriving in the leaves, undergoes a diminution of its mass by the exhalation of a great part of the water which served as the vehicle of the nutritious substances contained in it. The remaining portion undergoes a further change by respiration. The sap, thus altered by respiration in the leaves and other green parts, descends into the stem and root, and is rendered subservient to the development of all the organs. *See RESPIRATION, TRANSPIRATION, FOOD, NUTRITION.*—2. The albumen of a tree; the exterior part of the wood, next to the bark.—[*A sense in general use.*]

**SAP**, *v. t.* [Fr. *saper*; It. *zappa*, a spade; *zappone*, a mattock. The primary sense is probably to dig or to thrust.] 1. To undermine; to subvert by digging or wearing away; to mine.

Their dwellings were *sapp'd* by floods.

*Dryden.*

2. To undermine; to subvert by removing the foundation of. Discontent *saps* the foundation of happiness. Intrigue and corruption *sap* the constitution of a free government.

**SAP**, *v. i.* To proceed by mining, or by secretly undermining.

Both assaults are carried on by *sapping*.

*Tatler*

**SAP**, *n.* In *sieges*, a trench for undermining; or an approach made to a fortified place by digging or under cover. The single *sap* has only a single parapet; the double has one on each side, and the flying is made with gabions, &c. In all *saps* traverses are left to cover the men.

**SAPAJOUS** or **SA'JOUS**, *n.* The name generally given to a group of South American monkeys including fifteen or sixteen species, whose characteristics it is exceedingly difficult properly to define. Among the species may be named the *Cebus fatuellus*, or horned Sapajou, the *C. monachus*, and *C. Capucinus*. One of the most common species is the Weeper (*Cebus apella*). The fur is rather rich, inclining to olive, and the face is bordered with a paler circle, varying considerably in shading and breadth. This species has been known to breed in confinement. The sapajous

are very active, and climb well. They are small in size, playful in disposition,

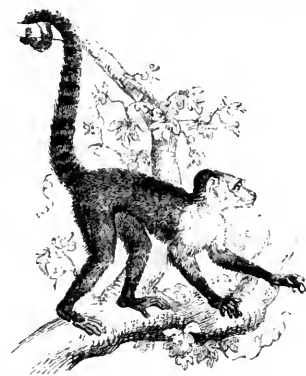

Sapajou. *Cebus capucinus.*

leading a gregarious life, and feeding chiefly on fruits and insects.

**SAP'COLOUR**, *n.* An expressed vegetable juice inspissated by slow evaporation, for the use of painters, as sap-green, &c.

**SAP'GREEN**, *n.* A pigment prepared by evaporating the juice of the berries of the *Rhamnus catharticus*, or buckthorn, to dryness, mixed with lime. It is soluble in water; acids redden it, but the alkalis and alkaline earths restore the green colour. It is used by water-colour painters as a green pigment.

**SAPHE'NA**, *n.* [Gr. *σαφης*, visible.] In *anat.*, the large vein of the leg which ascends over the external ankle.

**SAPH'ETA**, or **SAPH'ITA**, *n.* The same as *soffit*.

**SAP'ID**, *a.* [L. *sapidus*, from *sapio*, to taste.] Tasteful; tastable; having the power of affecting the organs of taste; as *sapid* water.

**SAPIDITY**, } *n.* Taste; tastefulness;  
**SAP'IDNESS**, } savour; the quality of affecting the organs of taste; as, the *sapidness* of water or fruit.

**SAP'IENCE**, *n.* [Fr. from L. *sapientia*, from *sapio*, to taste, to know.] Wisdom; sageness; knowledge.

Still has gratitude and *sapience*

To spare the folks that give him hap'ence

*Swift.*

**SAP'IENT**, *a.* Wise; sage; discerning. There the *sapient* king held dalliance.

*Milton.*

[This epithet is now seldom or never used but in an ironical sense.]

**SAPIENTIAL**, *a.* Affording wisdom or instructions for wisdom. [Not much used.]

**SAP'IENTLY**, *adv.* Wisely, sagaciously.—2. In an ironical sense, mistakenly; stupidly; sillily.

**SAPIND'ACEÆ**, *n.* A natural order of plants of the calycose group of poly-petalous exogens. It consists of trees or shrubs with erect or climbing stems, inhabitants of most parts of the tropics, more especially of South America and India. In this order, although the leaves, branches and other organs, are poisonous in various degrees, yet the fruit and seeds are eatable and wholesome. The Litchi and Longan, favourite fruits in China, are produced by the genus *Euphoria*. Several other genera bear fruits that are eaten in Japan and Brazil. The most remarkable genus is *Sapindus*,—*which see*.

**SAPINDA'CEOUS**, *a.* Pertaining to plants of the order Sapindaceæ.

**SAPINDUS**, *n.* [Contracted from *sapo Indicus*, or Indian soap.] A genus of plants, nat. order Sapindaceæ, containing between twenty and thirty species found in the tropical parts of the Old and New World.

The species consist of trees having exstipulate leaves, with the inflorescence in racemes or terminal panicles. The berries are red and saponaceous, on which account they have been employed for washing cloths of various kinds in the West Indies, the continent of America, Java, and India.

The fleshy part of these berries is viscid and in drying assumes a shining transparent appearance, and when rubbed with water it forms a lather like soap. This is owing to the presence of a principle called *Saponine*,—which see. The bark and root have similar properties, and have been employed for the same purpose, as well as medicinally in the countries where the plant is indigenous.

**SAPLESS**, *a.* [from *sap*.] Destitute of sap; as, a *sapless* tree or branch.—2. Dry; old; husky; as, a *sapless* usurer.

**SAPLING**, *n.* [from *sap*.] A young tree full of sap. Nurse the *saplings* tall. *Milton.* **SAPODILLA**, *n.* The sapodilla plum is the name given to a tree and its fruit of the genus *Achras*, the *A. sapota*, nat. order Sapotaceæ, and found in the West Indies. The tree is large and straight, and runs to a considerable height without any branches, with a dark grey bark, very much chapped.



*Sapindus saponaria.*



*Sapodilla (Achras sapota).*

The fruit resembles a bergamot pear in shape and size. It is also called naseberry, and is much prized as an article of diet.

**SAPONACEOUS**, *a.* [from *L. sapo, soap*.] Soapy; resembling soap; having the qualities of soap. *Saponaceous* bodies are compounds of an acid and a base, and are in reality a kind of salt. **SAPONARIA**, *n.* Soap-wort, a genus of annual and perennial herbs, chiefly natives of Europe. Class and order Decandria digynia, Linn.; nat. order

Silenaceæ. *S. officinalis*, common soap-wort, is a native of Britain, growing in meadows and shady places. The whole plant is bitter, and when bruised and agitated in water it raises a lather like soap, which washes greasy spots out of clothes. It has also been used in syphilis.

**SAPONARY**, *a.* Saponaceous. **SAPONIC ACID**, *n.* An acid produced by the action of acids and alkalies upon saponine. It appears as a white powder, soluble in alcohol, but very sparingly soluble in water.

**SAPONIFICATION**, *n.* Conversion into soap.

**SAPONIFIED**, *pp.* Converted into soap.

**SAPONIFY**, *v. t.* [*L. sapo, soap, and facio, to make*.] To convert into soap by combination with an alkali.

**SAPONINE**, *n.* A non-azotized vegetable principle found in the root of *Saponaria officinalis*. It is white, amorphous, and has a taste first sweet, then styptic, and finally acrid. It is a powerful sternutatory. It is soluble in water, and its solution, even when much diluted, froths on being agitated like a solution of soap. The root of the plant is used as a detergent.

**SAPONULE**, *n.* An imperfect soap formed by the action of an alkali upon an essential oil.

**SAPOR**, *n.* [*L.*] Taste; savour; relish; the power of affecting the organs of taste.

There is some *sapor* in all aliments. *Brown.* **SAPORIFIC**, *a.* [*Fr. saporifique*; from *L. sapor and facio, to make*.] Having the power to produce taste; producing taste.

**SAPOROSITY**, *n.* The quality of a body by which it excites the sensation of taste.

**SAPOROUS**, *a.* Having taste; yielding some kind of taste.

**SAPOTA**, *n.* In *bot.*, the specific name of a tree or plant of the genus *Achras*, the *A. sapota*. [See **SAPODILLA**.]

**SAPOTACEÆ**, *n.* A nat. order of plants, belonging to the polycarpous group of monopetalous exogens. It consists of trees and shrubs which abound in a milky juice, which may be used for alimentary purposes. They are chiefly natives of India, Africa, and America. Some of the species produce eatable fruits, as the sapodilla plum, marmalade apple, star apple, medlar of Surinam, &c. The fruit and seeds of some species abound in oil, which is solid like butter, and has a mild pleasant flavour. The bark of four species of *Achras* is astringent and tonic, and has been recommended as a substitute for quinine. [See **SAPODILLA**.]

**SAPPADILLO-TREE**, } See **SAPODILLA**.  
**SAPPADILLO-TREE**, } **DILLA**.

**SAPPAN WOOD**, *n.* A dye-wood produced by certain species of *Cesalpinia*, (*C. sappan*.) It has long been used in India, and resembles Brazil wood in its colour and properties.

**SAPPARE**, *n.* A mineral or species of earth, the cyanite; called by Häüy, disthene.

**SAPPED**, *pp.* Undermined; subverted.

**SAPPER**, *n.* One who saps.—*Royal sappers and miners*, the name given to the non-commissioned officers and privates of the corps of royal engineers. Their duties consist in building fortifications, in executing field works, and in performing similar operations under the direction of their superior officers.

**SAPPHIC**, *a.* (saff ic.) Pertaining to Sappho, a Grecian poetess; as, *Sapphic odes*; *Sapphic* verse. The *Sapphic* verse consists of eleven syllables in five feet, of which the first, fourth, and fifth are trochees, the second a spondee, and the third a dactyl. The *Sapphic* strophe consists of three *Sapphic* verses followed by an *Adonic*.

**SAPPHIRE**, *n.* [*L. sapphirus*; *Gr. σαφειρος*: from the *Ar. safara*, to scrape, to shine, to be fair, open, beautiful; *Ch. Syr. and Sam. to scrape, to shave*.] A precious stone, next in hardness to the diamond, consisting essentially of crystallized alumina. Its colours are blue, red, yellow, green, white, or limpid. Sapphires are found in various places, as at Pegu, Calicut, Cananor, and Ceylon, in Asia; and Bohemia and Silesia, in Europe. The most highly prized varieties are the crimson and carmine red; these are the oriental rubies of the jewellers; the next is sapphire proper, and the last the oriental topaz. The asterias or star stone is a very beautiful variety, generally violet-red. The sapphire is considered next in value to the diamond.

**SAPPHIRINE**, *a.* Resembling sapphire; made of sapphire; having the qualities of sapphire.

**SAPPINESS**, *n.* [from *sappy*.] The state or quality of being full of sap; succulence; juiciness.

**SAPPING**, *ppr.* Undermining; subverting.

**SAPPY**, *a.* [*Sax. sæpig*.] 1. Abounding with sap; juicy; succulent.—2. Young; not firm; weak.

When he had passed this weak and *sappy* age. *Hayward.*

3. Weak in intellect.

**SAPPY**, *† a.* [*Qu. Gr. σαπρω, to putrefy*.] Musty; tainted.

**SAPROPHAGANS**, *n.* [*Gr. σαπρο, decomposing matter, and φαγω, to eat*.] A tribe of coleopterous insects, comprising such as feed on animal and vegetable substances in a state of decomposition.

**SAPSAGO**, *n.* [*G. Schabziger*.] In the *U. States*, a kind of hard cheese made in Switzerland, having a greenish colour, and an agreeable flavour. In America, it is rasped into a kind of meal, and eaten with bread and butter.

**SAP-TUBE**, *n.* A vessel that conveys sap.

**SAP-WOOD**, *n.* The external part of the wood of Exogens, which from being the latest formed, is not filled up with solid matter. It is that through which the ascending fluids of plants move most freely. For all building purposes the Sap-wood is or ought to be removed from timber, as it soon decays.

**SAPYGIDÆ**, *n.* A family of hymenopterous insects of the section Fossores, the species of which are chiefly distinguished by the feet, in both sexes, being slender, and little or not at all spinose. The genus *Sapyga* is the type of the order, the species of which are supposed to be parasitic upon some of the wild bees.—*S. punctata* and *S. clavicornis* are British species.

**SARABAND**, *n.* [*Sp. zarabanda*; *Fr. sarabande*.] A dance used in Spain, said to be derived from the Saracens.—2. In *music*, a composition adapted to the dance. It is in triple time, and very similar to a minuet.

**SARACEN**, *n.* An Arabian; so called from *sara*, a desert.

**SARACENIC**, *a.* Pertaining to the Saracens, inhabitants of Arabia.

**SARACENIC ARCHITECTURE**. See MOORISH ARCHITECTURE.

**SAR'ASIN**, } *n.* A plant, a kind of SAR'ASINE, } birth-wort.—2. A portcullis or herse.

**SAR'CARA**, *n.* In *India*, the Sanscrit name for manufactured sugar.

**SAR'CAASM**, *n.* [*L. sarcasmus*; *Gr. σαρκασμος*, from *σαρκα*, to deride or sneer at, primarily to flay or pluck off the skin.] A keen reproachful cutting expression; a satirical remark or expression, uttered with some degree of scorn or contempt; a taunt; a gibe. Of this we have an example in the remark of the Jews respecting Christ, on the cross, "He saved others, himself he cannot save."

**SARCASTIC**, } *a.* Bitterly satirical. **SARCASTICAL**, } *cal*; scornfully severe; keen cutting; taunting.

What a fierce and *sarcastic* reprehension would this have drawn from the friendship of the world. *South.*

**SARCASTICALLY**, *adv.* In a sarcastic manner; with scornful satire.

**SARCELLED**, *a.* In *her.*, cut through the middle.

**SAR'CLE**, † *v. t.* [*Fr. sarcler*; *L. sarculum*, a weeding tool.] To weed corn.

**SAR'CLING**, † *ppr.* Weeding corn.—*Sarcling-time*, the time of weeding corn.

**SAR'COEARP**, *n.* [*σαρξ*, flesh, and *καρπος*, fruit.] The fleshy part of certain fruits, placed between the epicarp, and the endocarp. It is that part of fleshy fruits which is usually eaten, as in the peach, plum, &c.

**SAR'COELE**, *n.* [*Gr. σαξ*, flesh, and *κελη*, tumour.] A fleshy and firm tumour of a testicle, with a simple vascular texture, not inflammatory.

It is the *Sarcoma vasculosum* of Good.

**SAR'COCOL**, } *n.* [*Gr.* compounded **SARCOCOLLA**, } of *σαξ*, flesh, and *κολλη*, glue.] A semi-transparent solid substance, imported from Arabia and Persia, in grains of a light yellow or red colour. It is an inspissated sap, supposed to be produced by *Penæa mucronata* and other plants. It contains a peculiar principle named *Sarcocolline*, which has the property of forming oxalic acid when treated with nitric acid. It has its name from its supposed use in healing wounds and ulcers.

**SAR'CODERM**, *n.* [*Gr. σαξ*, flesh, and *δερμα*, skin.] In *bot.*, a name applied to the middle covering of the seed when it becomes succulent, as in the iris. It is placed between the epispERM and the endosperm.

**SARCOIDEA**, *n.* A group of Polyptaria, of which the type is the old Linnæan genus *Alcyonium*.

**SAR'COLINE**, *a.* [*Gr. σαξ*, flesh.] In *min.*, flesh-coloured.

**SAR'COLITE**, *n.* [*flesh-stone.*] A substance of a vitreous nature, and of rose flesh colour, found near Vesuvius. The French call it *hydropolite*, water-stone. Sarcolite is a variety of analcime.

**SARCOLOGICAL**, *a.* Pertaining to sarcology.

**SARCOLOGY**, *n.* [*Gr. σαξ*, flesh, and *λογος*, discourse.] That part of anatomy which treats of the soft parts of the body, as the muscles, fat, intestines, vessels, &c.

**SARCO'MA**, *n.* [*Gr.* from *σαξ*, flesh.] Any fleshy and firm tumour not inflammatory, attended with dull sensations and sluggish growth. There are numerous varieties of sarcoma.

**SARCOM'ATOUS**, *a.* An epithet applied to a fleshy tumour.

**SARCOPHAGOUS**, *a.* [*See SARCOPHAGUS.*] Feeding on flesh; flesh-eating.

**SARCOPH'AGUS**, *n.* [*L.* from *Gr. σαρκοφagos*: *σαξ*, flesh, and *φαγω*, to eat.] 1. A species of stone used among the Greeks for making coffins, which was so called because it consumed the flesh of bodies deposited in it within a few weeks. It is otherwise called *lapis Assius*, and said to be found at

Assos, a city of Lycia. Hence,—2. A stone coffin or grave in which the ancients deposited bodies which they chose not to burn. One of the most celebrated coffins of this kind is the great Sarcophagus taken by the British in Egypt in 1801, commonly called that of Alexander. It is deposited in the British Museum.

**SARCOPH'AGY**, *n.* [*supra.*] The practice of eating flesh.

**SARCO'PHILUS**, *n.* Cuvier's name for a genus of Marsupials, founded on *Dasypus ursinus*.

**SARCO'SIS**, *n.* [*Gr. σαρκωσις.*] In *sur.*, the generation of flesh. Also a fleshy tumour.

**SARCO'TIC**, *a.* [*Gr. σαξ*, flesh.] In *sur.*, producing or generating flesh.

**SARCO'TIC**, *n.* A medicine or application which promotes the growth of flesh; an incarnative.

**SARCULA'TION**, *n.* [*L. sarculatio*, a raking.] A raking or weeding with a rake.

**SAR'DACHATE**, *n.* The clouded and spotted agate, of a pale flesh colour.

**SAR'DAN**. See **SARDINE**.

**SARD**, } *n.* A mineral, a variety **SAR'DOIN**, } of carnelian, which displays on its surface a rich reddish brown, but when held between the eye and the light, appears of a deep blood red carnelian.

**SAR'DEL**, } *n.* [*L. sardius*; *Gr. σαρδινε*, } *διο*: from *Sardis*, in **SAR'DIUS**, } Asia Minor, now *Sart.*] A precious stone. One of this kind was set in Aaron's breastplate; *Exod. xxviii.*

**SAR'DINE** or **SARDYNIAS**, *n.* A species of fish of the herring tribe but smaller. They are taken in considerable quantities on our coasts, and are exceedingly plentiful on the coasts of Algarve in Portugal, Andalusia, and

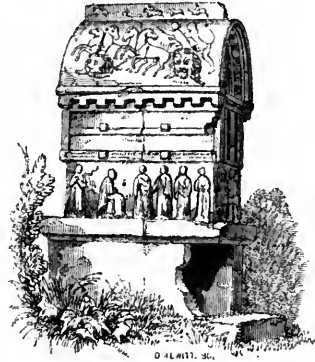

Sarcophagus, Xanthus.

Granada in Spain, and along the shores of Italy. When perfectly fresh, sardines are accounted excellent fish.

**SARDINIAN**, *n.* Pertaining to the island, kingdom, or people of Sardinia, or Piedmont.—2. Belonging to Sardinia, in Natolia.

Byges, great *Sardinian* king...

*Trans. of Anacreon.*

**SARDONIAN**, } *a.* *Sardonian* or **SARDONIC**, } *donic* laughter, a convulsive involuntary laughter, so called from the *herba sardonica*, said to be a species of ranunculus, which is said to produce such convulsive motions in the cheeks and lips as are observed during a fit of laughter. Homer, and others after him, apply this epithet to laughter which conceals some noxious design. [*Qu.* A contemptuous laugh.]

**SARDONIC**, *a.* Denoting a kind of linen made at Colchis.

**SARDONYX**, *n.* [*L. sardoniches*, from *Gr. σαρωνις*, from *Sardis*, a city of Asia Minor, and *ονυξ*, a nail; so named, according to Pliny, from the resemblance of its colour to the flesh under the nail; *Plin. Lib. 37, 6.*] A precious stone, a variety of chalcedony, differing from carnelian only in its colour, which is reddish yellow, or nearly orange with an occasional tinge of brown. It was formerly much employed for the sculpture of cameos. [*See CHALCEDONY.*]

**SARGAS'SUM**, *n.* A genus of seaweeds to which the various species of gulf-weed belong. *S. bacciferum* is the common gulf-weed.

**SAR'GUS**, *n.* A genus of fish belonging to Cuvier's family of Sparoidei, found in the Mediterranean. The body is variegated with brown transverse rings, resembling the variegations of the perch. This is also a name of the garden.—2. A genus of dipterous insects belonging to the family Stratiomidae. There are several British species.

**SAR'IGUE**, *n.* The popular name of *Didelphis opossum*, a marsupial mammal of Cayenne, nearly allied to the *Virginian opossum*. [*See MARSUPIALS.*]

**SARK**, *n.* [*Sax. syrc.*] 1. In Scotland, a shirt.

Her cutty *sark* o' Paisley harn. *Burns.*

2. † A shark.

**SARK'ING**, *n.* A term used in Scotland to denote the boarding on which slates are laid. It is called sound boarding in England.

**SAR'LAC**, *n.* The Bos Pœphagus, or grunniens, the grunting ox of Tartary.

**SARMA'TIAN**, } *a.* Pertaining to **SAR-** **SARMATIC**, } matia and its inhabitants, the ancestors of the Russians and Poles.

**SARMENTA'CEOUS**, *a.* In *bot.*, the same as *Sarmentous*.

**SARMENTO'SE**, *n.* In *bot.*, one of Linnæus's natural orders, consisting of plants which have climbing stems and branches, as the vine.

**SARMENT'OUS**, or **SARMENT'OSE**, *a.* [*L. sarmentosus*, from *sarmentum*, a twig.] A sarmentous stem, in *bot.*, is one that is long and filiform and almost naked, or having only leaves in bunches at the joints or knots, where it strikes root.

**SARMENT'UM**, *n.* [*L.*] In *bot.*, a runner, a name given to a running stem giving off leaves or roots at intervals, as the strawberry.

**SARONIC**, *a.* Denoting a gulf of Greece between Attica and Sparta.

**SÄR'PLAR**, *n.* A sarplar of wool is a sack containing 80 tods; a tod contains two stone of 14 pounds each.

**SÄR'PLIER**, *n.* [Fr. *serpillière*.] Canvas, or a packing cloth.

**SARRACENIA'CEÆ**, *n.* A nat. order of albuminous polypetalous exogens which consists of herbaceous perennial plants, inhabiting bogs and swamps in North America. They have radical leaves with a hollow urn-shaped or pitcher-shaped leaf, the point of which is prolonged like a lid. There is only one genus (*Sarracenia*), belonging to the order, of which there are several species all inhabitants of North America. The pitcher-like leaves are capable of holding water, and are thus said to furnish drink to wild animals in their native forests, during seasons of drought. The species are also known by the name of side-saddle flower.

**SARSAPARIL'LA**, or **SAR'ZA**, *n.* The root of several plants of the genus *Smilax*.—*S. medica* supplies the Sarza of Vera Cruz.—*S. siphilitica*, or *S. papyracea*, yields the Lisbon or Brazilian sort.—*S. officinalis*, the Sarza



Sarsaparilla *Smilax china*.

of Jamaica, and *Hemidesmus Indicus* the East Indian sort. Sarsaparilla is valued in medicine on account of its mucilaginous and farinaceous or demulcent qualities. The kind now generally preferred is the reddish fibrous root, known in the market under the name of Jamaica, or red sarsaparilla. This root is used as a powerful and valuable alterative medicine in many disorders of debility.

**SÄRSE**, *n.* [Qu. *saracen*, or Fr. *sas*.] A fine sieve; usually written *searse* or *searse*. [Little used.]

**SÄRSE**, *v. t.* [from the noun.] To sift through a sarse. [Little used.]

**SÄRSENET**, *n.* [Qu. *saracenicum* or *saracen*, silk.] A species of fine thin woven silk.

**SÄRT**, *n.* A piece of woodland turned into arable.

**SARTORIUS MUSCLE**, *n.* [L. *sartor*, a tailor.] In *anat.*, a muscle of the thigh concerned in bending the leg obliquely inwards, and in crossing the legs. Hence it has been named *sartorius* or the tailor's muscle.

**SÄR'ZA**, *n.* See **SARSAPARILLA**.

**SASH**, *n.* [An Arabic word signifying a band. But this word when it signifies a frame, is referred by Ash and Bailey to the French *chassis*, a frame for a window, which is the *chaise* of a printing press also. Johnson and his

followers mistake the meaning of the word.] A band; a belt worn for ornament. Sashes are worn by military officers as badges of distinction, round the waist or over the shoulders. They are also worn by clergymen over their cassocks; and as a part of female dress. They are usually of silk, variously made and ornamented.

**SASH**, *n.* [Fr. *chassis*.] The framed part of a window in which the glass is fixed.

She ventures now to lift the sash. *Swift*.

**SASH**, *v. t.* To dress with a sash.—2.

To furnish with sash-windows.

**SASH-FASTENER**, *n.* A latch or screw for fastening the sash of a window.

**SASH-FRAME**, *n.* The frame in which the sash is suspended, or to which it is hinged. When the sash is suspended the frame is made hollow to contain the balancing weights, and is said to be *cased*.

**SASH-LINE**, *n.* The rope by which a sash is suspended in its frame.

**SASH-SAW**, *n.* A small saw used in cutting the tenons of sashes. Its plate is about 11 inches long and has about 13 teeth to the inch.

**SASH'OO**, *n.* A kind of leather stuffing put into a boot for the wearer's ease.

**SA'SINE**, *n.* [Fr. *saisine*. See **SEIZIN**.] In *Scots law*, a term used to signify either the act of giving legal possession of feudal property (in which case it is synonymous with *infestment*), or colloquially, the instrument by which that fact is proved. Formerly the instrument of *sasine* required to be recorded within sixty days after its date, either in the general register of *sasines* at Edinburgh, or in the particular register of that district within which the property was situated; but by 8 and 9 Vict. cap. 35, the instrument may be recorded at any time during the life of the person in whose favour it stands, the entry of the date of presentation being the date of the instrument. According to the same act, it is no longer necessary to proceed to the lands, and deliver earth and stone &c., in the presence of two male witnesses, it being held sufficient to produce to a notary the precept of *sasine* (See **PRECEPT OF SASINE**), and relative writs, and record an instrument signed by the notary and witnesses, which instrument is to be recorded as the instrument of *sasine*. The act, however, does not alter *sasine*, or cognition and *sasine* in burgh property subjects, but they are to be effectual if attested by the town clerk as notary without his docket, and by the witnesses; and delivery of symbols may either be on the ground or within the council chamber by the delivery of a pen. The precept of *sasine* is to be null, unless recorded at the first Whitsunday or Martinmas after its date, but without prejudice to a new precept being issued.—*Sasine ox*, a perquisite formerly due to the sheriff when he gave *infestment* to an heir holding crown lands. It is now converted into a payment in money proportioned to the value of the estate.

**SAS'SAFRAS**, *n.* [L. *saxifraga*; *saxum*, a stone, and *frango*, to break.] A genus of plants, nat. order Lauracæ. The species most known is the *S. officinale*, the sassafras laurel, on account

of the medicinal virtues of its root. It is mostly a small tree or bush inhabiting the woods of North America from Canada to Florida. The taste of sassafras is sharp, acrid, aromatic, and as well as the odour, resembles fennel. The chief constituents are volatile oil, resin, and extractive. The oil is the most active. Sassafras acts as a stimulant to the circulation, especially of the capillaries. The *sassafras nuts* of the London shops are the fruit of the *Laurus pucheri*.

**SASSE**, *n.* [D. *sas*.] A sluice, canal, or lock on a navigable river; a word found in old British statutes.

**SAS'SOLIN**, *n.* Native boracic acid, **SAS'SOLINE**, found in saline incrustations on the borders of hot springs near Sasso, in the territory of Florence.

**SAS'SOROL**, } *n.* A species of **SASSOROL'LA**, } pigeon, called rock pigeon.

**SAS'TRA**, **SHAS'TRA**, or **SHAS'TER**, *n.* Among the Hindoos, a sacred book; a book containing sacred ordinances. The six great *Sastras*, in the opinion of the Hindoos, contain all knowledge, human and divine. These are the *Veda*, *Upaveda*, *Vedanga*, *Purana*, *Dherma*, and *Dersana*.

**SAT**, *pret. of Sit*.

**SAT'TAN**, *n.* [Heb. an adversary.] The grand adversary of man; the devil or prince of darkness; the chief of the fallen angels.

**SATAN'IC**, } *a.* Having the quali-  
**SATAN'ICAL**, } ties of Satan; re-  
sembling Satan; extremely malicious  
or wicked; devilish; infernal.

Detest the slander which, with a *satanic* smile, exults over the character it has ruined. *Dwight*.

**SATAN'ICALLY**, *adv.* With the wicked and malicious spirit of Satan; diabolically.

**SATANISM**, *n.* The evil and malicious disposition of Satan; a diabolical spirit.

**SAT'ANIST**, *n.* A very wicked person.

[Little used.]

**SATCH'EL**, *n.* [L. *saccus*, dim. of *saccus*; W. *sagell*; Fr. *sachet*.] A little sack or bag; a bag in which lawyers and school-boys carry papers and books.

**SATE**, (*sat*), *old pret. of sit for sat*.

**SÄTE**, *v. t.* [L. *satio*; Fr. *rasasier*; allied to *set*.] The primary sense is to stuff, to fill, from crowding, driving.] To satiate; to satisfy appetite; to glut; to feed beyond natural desire.

While the vultures *sate*

Their maws with full repast. *Phil'ps*.

**SÄTED**, *pp.* Filled; glutted; satiated.

**SÄTELESS**, *a.* Insatiable; not capable of being satisfied.

**SÄTELLITE**, *n.* [Fr. and It. *satellite*; L. *satelles*.] 1. A secondary planet or moon; a small planet revolving round another called the *primary*. In the solar system, eighteen *satellites* have been discovered. The earth has one, called the moon, Jupiter four, Saturn seven, and Herschel six. The motions of the satellites of Herschel are *retrograde*, while those of all the others are *direct*.—2. A follower; an obscure attendant or dependant.

**SÄTELLI'TIOUS**, *a.* Consisting of satellites.

**SÄTIATE**, *v. t.* (*sa'shate*.) [L. *satiatus*, from *satio*. See **SÄTE**.] 1. To fill; to satisfy appetite or desire; to feed to the full, or to furnish enjoyment to

the extent of desire; as, to *satiare* appetite or sense.—2. To fill to the extent of want; as, to *satiare* the earth or plants with water.—3. To glut; to fill beyond natural desire.

He may be *satiated*, but not satisfied. *Norris*.

4. To gratify desire to the utmost.

I may yet survive the malice of my enemies, although they should be *satiated* with my blood. *K. Charles*.

5. To saturate. [*Now unusual*. See SATURATE.]

SATIATE, *a.* Filled to satiety; glutted; followed by *with* or *of*. The former is most common; as, *satiare of* applause. [*Unusual*.]

SATIATION, *n.* The state of being filled.

SATIETY, *n.* [Fr. *satiété*; L. *satietas*. See SATÉ.] Properly, fullness of gratification, either of the appetite or any sensual desire; but it usually implies fullness beyond desire; an excess of gratification which excites wearisomeness or loathing; state of being glutted.

In all pleasures there is *satiety*. *Hakevill*.

But thy words, with grace divine  
Imbued, bring to their sweetness no *satiety*.  
*Milton*.

SATIN, *n.* [Fr. *satins*; W. *sdan*, satin or silk; Gr. and L. *sidon*; Ch. and Heb. *סדין*, *sedin*; Ar. *sidanah*.] A species of glossy silk cloth, of a thick, close texture, generally dressed with gum, especially when intended for ribbons, dresses, &c.

SATINET, *n.* A thin species of satin.—2. A particular kind of woollen cloth.

SATIN-FLOWER, *n.* A plant of the genus *Lunaria*.

SATIN-SPAR, *n.* A fibrous variety of carbonate of lime, assuming a silky appearance when polished.

SATIN-WOOD, *n.* The wood of a tree of the genus *Chloroxylon*, the *C. swietenia* (formerly *swietenia chloroxylon*), nat. order *Cedrelaceæ*. It is a native of the mountainous parts of the Circars in the East Indies. The wood is of a deep yellow colour, close grained, heavy and durable.

SATING, *ppr.* Filling; glutting; satiating.

SATIRE, *n.* [Fr. *satire*; Sp. and L. *satira*; so named from sharpness, pungency. See SATIRIASIS.] 1. A discourse or poem in which wickedness or folly is exposed with severity, and held up to ridicule or contempt. It differs from *lampoon* and *pasquinade*, in being general rather than personal.

—2. Keeness and severity of remark. It differs from *sarcasm*, in not expressing contempt or scorn.

SATIRIC, } *a.* [L. *satiricus*; Fr. SATIRICAL, } *satirique*.] 1. Belonging to satire; conveying satire; as, a *satiric* style.—2. Censorious; severe in language.

SATIRICALLY, *adv.* With severity of remark; with invective; with intention to censure.

SATIRIST, *n.* One who writes satire.

Wycherley, in his writings, is the sharpest *satirist* of his time. *Granville*.

SATIRIZE, *v. t.* [Fr. *satiriser*.] To censure with keeness or severity.

It is as hard to *satirize* well a man of distinguished vices, as to praise well a man of distinguished virtues. *Swift*.

SATIRIZED, *pp.* Severely censured.

SATIRIZING, *ppr.* Censuring with severity.

SATISFACTION, *n.* [Fr. from L. *satisfactio*. See SATISFY.] 1. That state

of the mind which results from the full gratification of desire; repose of mind or contentment with present possession and enjoyment. Sensual pleasure affords no permanent *satisfaction*.—2. The act of pleasing or gratifying.

The mind having a power to suspend the execution and *satisfaction* of its desires. *Locke*.

3. Repose of the mind on the certainty of any thing; that state which results from relief from suspense, doubt, or uncertainty; conviction.

What *satisfaction* can you have? *Shak.*

4. Gratification; that which pleases. Exchanging solid quiet to obtain

The windy *satisfaction* of the brain. *Dryden*.

5. That which satisfies; amends; recompense; compensation; indemnification; atonement. *Satisfaction* for damages, must be an equivalent; but *satisfaction* in many cases, may consist in concession or apology.—6. Payment; discharge; as, to receive a sum in full *satisfaction* of a debt; to enter *satisfaction* on record.—7. In the language of duellists, *satisfaction* means, shooting or stabbing, or letting be shot or stabbed, or the incurring of that risk, on the demand of an aggrieved or offended person.

SATISFACTIVE, *a.* Giving satisfaction. [*Little used or not at all*.]

SATISFACTORY, *adv.* In a manner to give satisfaction or content.—2. In a manner to impress conviction or belief. The crime was *satisfactorily* proved.

SATISFACTORYNESS, *n.* The power of satisfying or giving content; as, the *satisfactoriness* of pleasure or enjoyment.

SATISFACTORY, *a.* [Fr. *satisfactoire*.] 1. Giving or producing satisfaction; yielding content; particularly, relieving the mind from doubt or uncertainty, and enabling it to rest with confidence; as, to give a *satisfactory* account of any remarkable transaction. A judge seeks for *satisfactory* evidence of guilt before he condemns.

—2. Making amends, indemnification or recompense; causing to cease from claims and to rest content; atoning; as, to make *satisfactory* compensation, or a *satisfactory* apology for an offence.

A most wise and sufficient means of salvation by the *satisfactory* and meritorious death and obedience of the incarnate Son of God, Jesus Christ. *Sanderson*.

SATISFIABLE, *a.* That may be satisfied.

SATISFIED, *pp.* Having the desires fully gratified; made content.

SATISFLER, *n.* One that gives satisfaction.

SATISFY, *v. t.* [L. *satisfacio*; *satis*, enough, and *facio*, to make; Fr. *satisfaire*; G. *satt*, filled, satisfied.] 1. To gratify wants, wishes, or desires to the full extent; to supply possession or enjoyment till no more is desired. The demands of hunger may be easily *satisfied*; but who can *satisfy* the passion for money or honour?—2. To supply fully what is necessary and demanded by natural laws; as, to *satisfy* with rain the desolate and waste ground; Job xxxviii.—3. To pay to content; to recompense or indemnify to the full extent of claims; as, to *satisfy* demands. He is well paid, that is, well *satisfied*. *Shak.*

4. To appease by punishment; as, to *satisfy* rigour.—5. To free from doubt, suspense, or uncertainty; to cause the mind to rest in confidence by ascertain-

ing the truth; as, to *satisfy* one's self by inquiry.—6. To convince. A jury must be *satisfied* of the guilt of a man, before they can justly condemn him.

The standing evidences of the truth of the gospel are in themselves most firm, solid, and *satisfying*. *Atterbury*.

SATISFY, *v. i.* To give content. Earthly good never *satisfies*.—2. To feed or supply to the full.—3. To make payment. [But the intransitive use of this verb is generally elliptical.]

SATISFYING, *ppr.* Giving content; feeding or supplying to the full extent of desire; convincing; paying.

SATISFYINGLY, *adv.* In a manner tending to satisfy.

SAT'IVE, *a.* [L. *sativus*, from *sevo*, *satum*, to sow.] Sown in gardens.

Preferring the domestic or *sativa* for the fuller growth.  *Evelyn*.

SATRAP, *n.* [Gr. *σατραπ*.] A name which was given by the Greeks to a governor of a province of the Persian empire, before the conquests of Alexander.

SATRAPAL, *a.* Pertaining to a satrap, or a satrapy.

SATRAPESS, *n.* A female satrap.

SATRAPHY, *n.* The government or jurisdiction of a satrap.

SATURABLE, *a.* [See SATURATE.] That may be saturated; capable of saturation.

SATURANT, *a.* [L. *saturans*.] Saturating; impregnating to the full.

SATURANT, *n.* In *med.*, a substance which neutralizes the acid in the stomach.

SATURATE, *v. t.* [L. *saturō*, from *satur*, filled; *satio*, to feed to the full. See SATÉ.] 1. To impregnate or unite with till no more can be received. Thus an acid *saturates* an alkali, and an alkali *saturates* an acid, when the solvent can contain no more of the dissolving body.—2. To supply or fill to fullness.

SATURATED, *ppr.* Supplied to fullness.

SATURATING, *ppr.* Supplying to fullness.

SATURA'TION, *n.* In a general sense, a filling or supply to fullness. In *chem.*, the union, combination, or impregnation of one body with another by natural attraction or affinity, till the receiving body can contain no more; or solution continued till the solvent can contain no more. The *saturation* of an alkali by an acid, is by one sort of affinity; the *saturation* of water by salt, is by another sort of affinity, called solution. A fluid which holds in solution as much of any substance as it can dissolve, is said to be *saturated* with it, but saturation with one substance does not deprive the fluid of its power of acting on, and dissolving some other bodies; and in many cases it increases this power. For example, water saturated with salt will dissolve sugar. The word saturation is likewise used in another sense by chemists. The union of two principles produces a body, the properties of which differ from those of its component parts. When the principles are in such proportion that neither predominates, they are said to be *saturated* with each other; but, if otherwise, the most predominant principle is said to be *sub-saturated*, and the other *super-saturated*.

SATURDAY, *n.* [Sax. *Sæter-day*; D. *Saturdag*; Saturn's day.] The seventh or last day of the week; the day of the Jewish Sabbath.

**SATUREIA**, *n.* A genus of herbs and undershrubs commonly called savory, and used in cookery as a seasoning, particularly the summer savory (*S. hortensis*), an annual plant cultivated in kitchen gardens. The species are mostly natives of Europe, and belong to the nat. order Lamiaceae.

**SATURITY**, *n.* [*L. saturitas*. See **SATURATE**.] Fulness of supply; the state of being saturated. [*Little used*.]

**SATURN**, *n.* [*L. Saturnus*.] 1. In *myth.*, one of the oldest and principal deities, king of Crete, and son of Uranus or of Cœlus and Terra, (heaven and earth,) and the father of Jupiter. He answers to the Greek *Xœvros*, Chronos or Time. Armed with a sickle, he mutilated his father, and freed his brothers whom Cœlus had imprisoned. Cœlus being deprived of his sovereignty, Chronos or Saturn mounted the throne. He then married Rhea, by whom he had several sons and



Saturn.

daughters; but knowing he would be dethroned by one of his sons, he devoured the children as they were born to him. Rhea, however, saved Jupiter, Neptune, and Pluto, the first of whom dispossessed Saturn of his throne; on which he fled to Italy and took refuge in Latium, whose inhabitants he civilized.—2. In *astron.*, one of the planets of the solar system, less in magnitude than Jupiter, but more remote from the sun. Its diameter is seventy-nine thousand miles, its mean distance from the sun somewhat more than nine hundred millions of miles, and its year or periodical revolution round the sun, nearly twenty-nine years and a half. Saturn is attended by seven satellites.—*Ring of Saturn*. [*See under RING*.]—3. In the *old chem.*, an appellation given to lead.—4. In *her.*, the black colour in blazoning the arms of sovereign princes.

**SATURNALIA**, *n. plur.* [*Lat.*] Among the *ancient Romans*, the festival of Saturn, celebrated in December as a period of unrestrained licence and merriment for all classes, extending even to the slaves.

**SATURNALIAN**, *a.* [*from L. saturnalia*, feasts of Saturn.] 1. Pertaining to the festivals celebrated in honour of Saturn, Dec. 16, 17, or 18, in which men indulged in riot without restraint. Hence,—2. Loose; dissolute; sportive.

**SATURNIAN**, *a.* In *fabulous history*, pertaining to Saturn, whose age or reign, from the mildness and wisdom

of his government, is called the golden age; hence, golden; happy; distinguished for purity, integrity, and simplicity.

Th' Augustus, born to bring Saturnian times. *Pope*.

**SATURNINE**, *a.* [*Fr. saturnien*, from *L. Saturnus*.] 1. Supposed to be under the influence of Saturn. Hence,—2. Dull; heavy; grave; not readily susceptible of excitement; phlegmatic; as, a *saturnine* person or temper.

**SATURNIST**, *n.* A person of a dull, grave, gloomy temperament.

**SATURNITE**, *† n.* A metallic substance separated from lead in torrefaction, resembling lead in its colour, weight, solubility in acids, &c., but more fusible and brittle; easily scorified and volatilized.

**SATYR**, *n.* [*L. satyrus*; *Gr. σατυρος*, a monkey, a faun.] In *myth.*, a sylvan deity or demi-god, represented as a monster, half man and half goat, having horns on his head, a hairy body, with the feet and tail of a goat. Satyrs are



Satyr.

usually found in the train of Bacchus, and have been distinguished for lasciviousness and riot. They have been represented as remarkable for their piercing eyes and keen raillery.

**SATYRIASIS**, *n.* [*Gr. σατυριασις*. In this word there is a connection with *satire*, in the sense of excitement.] Immoderate venereal appetite in males.

**SATYRIC**, *a.* Pertaining to satyrs; as, *satyric* tragedy.

**SATYRIUM**, *n.* A genus of orchidaceous plants.

**SAUCE**, *n.* (*saus*.) [*Fr. sauce* or *sausse*, from *L. salsus*, salt, from *sal*.] 1. A mixture or composition to be eaten with food for improving its relish. Sauces are liquid preparations, such as melted butter with an infusion of some other ingredients; gravies drawn from fresh juicy meat; a mixture consisting partly of water, and of some preserves, condiments, or spices.

High sauces and rich spices are brought from the Indies. *Baker*.

2. In *America*, culinary vegetables and roots eaten with flesh. This application of the word falls in nearly with the definition.

Roots, herbs, vine-fruits, and salad-flowers...they dish up various ways, and find them very delicious *sauce* to their meats, both roasted and boiled, fresh and salt. *Beverly, Hist. Virginia*.

3. Pertness; petulance; insolence; impudence. [*A low word*.]—*To serce one the same sauce*, is to retaliate one injury with another. [*Vulgar*.]

**SAUCE**, *v. t.* To season; to accompany meat with something to give it a higher

relish.—2. To gratify with rich tastes; as, to *sauce* the palate.—3. To intermix or accompany with any thing good, or ironically, with any thing bad.

Then fell she to *sauce* her desires with threatenings. *Sidney*.

Thou say'st his meat was *sau'd* with thy upbraids. *Shak*.

4. To treat with bitter, pert, or tart language. [*Vulgar*.]

**SAUCE-ALONE**, *n.* A British plant of the genus *Erysimum*, the *E. alliaria*, called also garlic hedge-mustard, and Jack-by-the-hedge. [*See ERYSIMUM*.]

**SAUCE-BOX**, *n.* (*saus'-box*.) [*from saucy*.] A saucy impudent fellow.

**SAUCE-PAN**, *n.* (*saus'-pan*.) Originally, a pan for cooking sauces.—2. A metallic vessel for boiling or stewing, generally; called in Scotland a goblet.

**SAUCER**, *n.* [*Fr. sauciere* or *saussiere*.]

1. Formerly, a small pan in which sauce was set on a table.—2. A piece of china or other ware, in which a tea cup or coffee cup is set.—*Saucer of a capstan*, a socket of iron let into a wooden stock or standard, called the stop, resting upon, and bolted to the beams. Its use is to receive the spindle or foot, upon which the capstan rests and turns round.

**SAUCILY**, *adv.* [*from saucy*.] Impudently; with impertinent boldness; petulantly

**SAUCINESS**, *n.* Impudence; impertinent boldness; petulance; contempt of superiors.

**SAUCING**, *ppr.* Accompanying meats with something to give them a higher relish.—2. Gratifying with rich tastes.

**SAUCISSE**, } *n.* [*Fr. saucisse*, a sausage.] } *n.* [*Fr. saucisse*, a sausage, from *sauce*.] In

*mining* or *gunnery*, a long pipe or bag, made of cloth well pitched, or of leather, filled with powder, and extending from the chamber of the mine to the entrance of the gallery. To preserve the powder from dampness, it is generally placed in a wooden pipe. It serves to communicate fire to mines, caissons, bomb-chests, &c. Saucisson is also a long bundle of faggots or fascines, for raising batteries and other purposes.

**SAUCY**, *a.* [*from sauce*; *L. salsus*, salt or salted. The use of this word leads to the primary sense of salt, which must be shooting forward, penetrating, pungent, for *boldness* is a shooting forward.] 1. Impudent; bold to excess; rude; transgressing the rules of decorum; treating superiors with contempt. It expresses more than *pert*; as, a *saucy* boy; a *saucy* fellow.—2. Expressive of impudence; as, a *saucy* eye; *saucy* looks.

**SAUER KRAUT**, *n.* [*Ger. sauer cabbage*.] A dish of which the Germans are very fond, consisting of cabbage cut fine, pressed into a cask, with alternate layers of salt, and suffered to ferment till it becomes sour.

**SAUGH**, *n.* Willow. [*Scotch*.]

**SAUL**, an old spelling of *Soul*.

**SAUL TREE**, or **SAL TREE**, *n.* The name given in India to a tree of the genus *Shorea*, the *S. robusta*, which yields a balsamic resin, used in the temples under the name of *ral* or *dhona*. The timber called *sal*, the best and most extensively used in India, is produced by this tree.

**SAUNDERS WOOD**, or **SANDERS WOOD**. See **SANDAL WOOD**.

**SAUNTER**, *v. i.* (*sãnter*.) To wander about idly; as, *sauntering* from place to place.—2. To loiter; to linger.

SAUNTER, *f. n.* Idle occupation.—2. A sauntering, or place for sauntering.  
 SAUNTERER, *n.* One that wanders about idly.  
 SAUNTERING, *n.* The act of wandering lazily about, or loitering.

This must not run into a lazy sauntering about ordinary things. *Locke.*

SAUNTERING, *ppr.* Wandering about lazily or idly; loitering.

SAUR, *n.* Soil; dirt.

SAURIA, or SAURIANS, *n.* [*See SAURIAN.*] The term by which the great family of lizards is generally designated. The animal forms more strictly included under it, are those comprised under the genus *Lacerta* of Linnæus; but in the large acceptation of the term *Saurians*, the Pterodactyles, Eualosaurians, and Crocodiles are included. The saurians are covered with scales, and have four legs. The mouth is always armed with teeth, and the toes are generally furnished with claws. They have all a tail more or less long, and generally very thick at the base. The most gigantic and singular species of the saurian order are now extinct, and their remains are most abundant in the oolitic strata. Some of them were exclusively marine, others amphibious, others terrestrial, and others were adapted for flying, as the Pterodactyles.  
 SAURIAN, *a.* [*Gr. σαυρα*, a lizard.] Pertaining to lizards; designating an order of reptiles.

SAUROCEPHALUS, *n.* [*Gr. σαυρα*, and κεφαλη, a head.] A genus of fossil fishes of the cycloid order, found in the chalk formation. The form was adapted for swimming.

SAUROÏD, *a.* Resembling lizards; as, *sauroid* fish.

SAUROÏDS, *n.* [*Gr. σαυρα*, and ιδος, form.] A group of large fossil fishes found in great abundance in the carboniferous and secondary formations. They combined in their structure certain characters of reptiles, and had teeth resembling those of crocodiles.

SAURURA/CEÆ, *n.* A nat. order of plants belonging to the achemlydeous group of incomplete exogens. It consists of a few genera which are aquatic or marshy herbs or herbaceous plants, found in North America, China, the North of India, and the Cape of Good Hope. They seem to be the representatives of the Peppers in colder countries.

SAURUS, *n.* In *India*, the name of a very tall bird, the largest of the crane kind.

SAUSAGE, *n.* [*Fr. saucisse*; from *sauce*, *L. salsus*.] The intestine of an animal stuffed with minced meat seasoned.

SAUSURITE, *n.* A mineral so named from Saussure, the discoverer, of a white grey or green colour, found at the foot of mount Rosa. It is a variety of nephrite.

SAUVÉGARDE, *n.* [*Fr.*] The name by which the montory lizards or safe-guards of the new world are known.

SAVABLE, *a.* [*from save.*] Capable of being saved.

SAVABLENESS, *n.* Capability of being saved.

SAVAGE, *a.* [*Fr. sauvagerie*; *It. selvaggio*; *Sp. salvaje*; from *L. silva*, a wood, or *silvicola*, an inhabitant of a wood, or *silvaticus*.] 1. Pertaining to the forest; wild; remote from human residence and improvements; uncultivated; as, a *savage* wilderness.

Cornels and *savage* berries of the wood.

*Dryden.*

2. Wild; untamed; as, *savage* beasts of prey.—3. Uncivilized; untaught; unpolished; rude; as, *savage* life; *savage* manners.

What nation since the commencement of the Christian era, ever rose from *savage* to civilized without Christianity? *E. D. Griffin.*

4. Cruel; barbarous; fierce; ferocious; inhuman; brutal; as, a *savage* spirit.—5. Enraged, on account of provocation received. [*Vulgar.*]

SAVAGE, *n.* A human being in his native state of rudeness; one who is untaught, uncivilized, or without cultivation of mind or manners. The *savages* of America, when uncorrupted by the vices of civilized men, are remarkable for their hospitality to strangers, and for their truth, fidelity, and gratitude to their friends, but implacably cruel and revengeful toward their enemies. From this last trait of the *savage* character, the word came to signify,—2. A man of extreme, unfeeling, brutal cruelty; a barbarian.—3. The name of a genus of fierce voracious fishes.

SAVAGE, *v. t.* To make wild, barbarous, or cruel. [*Not well authorized, and little used.*]

SAVAGELY, *adv.* In the manner of a *savage*; cruelly; inhumanly.

SAVAGENESS, *n.* Wildness; an untamed, uncultivated, or uncivilized state; barbarism. Hence,—2. Cruelty; barbarousness.

Wolves and bears, they say, casting their *savageness* aside, have done like offices of pity. *Shak.*

SAVAGERY, *n.* Wild growth, as of plants.—2. Cruelty; barbarity.

SAVAGISM, *n.* The state of rude uncivilized men; the state of men in their native wildness and rudeness. [*American.*]

The greater part of modern philosophers have declared for the original *savagism* of men. *Encycr.*

SAVAN'NA, } *n.* [*In Spanish, sabana*  
 SAVAN'NAH, } is a sheet for a bed, or a large plain covered with snow.] An extensive open plain or meadow, or a plain destitute of trees. The vast systems of plains watered by the Missouri and Mississippi are termed *Savannahs*.

SA'VANT, *n. plur.* (Savans.) [*Fr. savan.*] A man of learning; in the plural, literary or scientific men.

SAVE, *v. t.* [*Fr. sauver*, from *L. salvo*.] As *salve* is used in Latin for salutation, or wishing health, as *hail* is in English, this word may possibly be from the root of *heal* or *hail*, the first letter being changed as in *Gr. ελε, W. halen*, salt. *See SALT.* 1. To preserve from injury, destruction, or evil of any kind; to rescue from danger; as, to *save* a house from the flames; to *save* a man from drowning; to *save* a family from ruin; to *save* a state from war.

He cried, saying, Lord, *save* me; *Matth. xiv*; *Gen. xlv.*

2. To preserve from final and everlasting destruction; to rescue from eternal death.

Christ Jesus came into the world to *save* sinners; *1 Tim. i.*

3. To deliver; to rescue from the power and pollution of sin.

He shall *save* his people from their sins; *Matth. i.*

4. To hinder from being spent or lost;

as, to *save* the expense of a new garment. Order in all affairs *saves* time.—5. To prevent. Method in affairs *saves* much perplexity.—6. To reserve or lay by for preservation.

Now *save* a nation, and now *save* a groat.

*Pope.*

7. To spare; to prevent; to hinder from occurrence.

Will you not speak to *save* a lady's blush.

*Dryden.*

Silent and unobserv'd, to *save* his tears.

*Dryden.*

8. To salve; as, to *save* appearances.—9. To take or use opportunely, so as not to lose. The ship sailed in time to *save* the tide.—10. To except; to reserve from a general admission or account.

Israel burned none of them, *save* Hazor only; *Josh. xi.*

Of the Jews five times received I forty stripes *save* one; *2 Cor. xi.*

[*Save* is here a verb followed by an object. It is the imperative used without a specific nominative; but it is now less frequently used than *except*.] *SAVE, v. t.* To hinder expense.

Brass ordnance *saveth* in the quantity of the material. *Bacon.*

SAVEALL, *n.* [*save* and *all*.] A small pan inserted in a candlestick to save the ends of candles.

SAVED, *pp.* Preserved from evil, injury, or destruction; kept frugally; prevented; spared; taken in time.

SAVELIN, *n.* A fish of the trout kind, having very small scales and a black back.

SAVER, *n.* One that saves, preserves, or rescues from evil or destruction; as, the *saver* of the country.—2. One that escapes loss, but without gain.—3. One that is frugal in expenses; an economist.

SAVIN, *n.* [*Fr. savinier*; *L.* and *Sp. sabina*.] A tree or shrub of the genus *Juniperus*, the *J. sabina*. [*See JUNIPER.*] The *savin* of Europe resembles the red cedar of America, and the latter is sometimes called *savin*.

SAVING, *ppr.* Preserving from evil or destruction; hindering from waste or loss; sparing; taking or using in time.—2. Excepting. *In this sense*, generally classed by grammarians among prepositions.—3. *a.* Frugal; not lavish; avoiding unnecessary expenses; economical; parsimonious. But it implies less rigorous economy than *parsimonious*; as, a *saving* husbandman or housekeeper.—4. That saves in returns or receipts the principal or sum employed or expended; that incurs no loss, though not gainful; as, a *saving* bargain. The ship has made a *saving* voyage.—5. That secures everlasting salvation; as, *saving* grace.

SAVING, *n.* Something kept from being expended or lost.

By reducing the interest of the debt, the nation makes a *saving*. *Anon.*

2. Exception; reservation.

Content not with those that are too strong for us, but still with a *saving* to honesty. *L'Estrange.*

SAVINGLY, *adv.* With frugality or parsimony.—2. So as to be finally saved from eternal death; as, *savingly* converted.

SAVINGNESS, *n.* Frugality; parsimony; caution not to expend money without necessity or use.—2. Tendency to promote eternal salvation.

SAVINGS-BANK, *n.* A bank established for the receipt of small sums (sav-

ings or earnings) deposited by the poorer classes of persons, and for the accumulation of such sums at compound interest. No depositor can contribute more than £30, exclusive of compound interest, to a savings bank, in any one year; and the total deposits to be received from any one individual are not to exceed £120, and whenever the deposits and compound interest accruing upon them, standing in the name of any one individual, shall amount to £200, no further interest shall be paid upon such deposit. The interest allowed upon deposits is about £3 per cent. per annum.

**SAVIOUR**, *n.* [Fr. *sauveur*.] 1. One who saves, preserves, or delivers from destruction or danger; 2 Kings xiii. 5; Is. xix. 20.—2. Properly and appropriately, Jesus Christ, the Redeemer, who has opened the way to everlasting salvation by his obedience and death, and who is therefore called *the Saviour*, by way of distinction, the *Saviour* of men, *the Saviour* of the world. **SAVORY**, *n.* [Fr. *savorée*.] A plant of the genus *Satureia*,—*which see*.

**SAVOUR**, *n.* [Fr. *sauveur*; *L. sapor*; *W. sawyr*; from *L. sapio*, to taste.] 1. Taste or odour; something that perceptibly affects the organs of taste and smell; as, the *savour* of an orange or rose; an ill *savour*; a sweet *savour*.

1 smell sweet *savours*. *Shak.*  
In *scripture*, it usually denotes smell, scent, odour; Lev. xxvi.; Eccles. x.—2. The quality which renders a thing valuable; the quality which renders other bodies agreeable to the taste.

If the salt hath lost its *savour*...; Matt. v. 3. In *Scripture*, character; reputation; Exod. v.—4. Cause; occasion; 2 Cor. ii.—Sweet *savour*, in *Scripture*, denotes that which renders a thing acceptable to God, or his acceptance. Hence, to *smell a sweet savour*, is to accept the offering or service; Gen. viii.

**SAVOUR**, *v. i.* To have a particular smell or taste.—2. To partake of the quality of nature of; or to have the appearance of. The answers *savour* of a humble spirit; or they *savour* of pride.

I have rejected every thing that *savours* of party. *Addison.*

**SAVOUR**, *v. t.* To like; to taste or smell with pleasure.—2. To like; to delight in; to favour; Matt. xvi.

**SAVOURED**, *pp.* Tasted or smelt with pleasure.

**SAVOURILY**, *adv.* [from *savoury*.] With gust or appetite.—2. With a pleasing relish.

**SAVOURINESS**, *n.* Pleasing taste or smell; as, the *savouriness* of a pineapple or a peach.

**SAVOURLESS**, *a.* Destitute of smell or taste; insipid.

**SAVOURLY**, *a.* Well seasoned; of good taste.

**SAVOURLY**, *adv.* With a pleasing relish.

**SAVOURY**, *a.* [from *savour*.] Pleasing to the organs of smell or taste; as, a *savoury* odour.

Make me *savoury* meat; Gen. xxvii.

**SAVOY**, *n.* A variety of the common cabbage (*Brassica oleracea*), much cultivated for winter use.

**SAW**, *pret.* of *See*.

**SAW**, *n.* [Sax. *saga*; *G. säge*; *Fr. scie*. See the Verb.] 1. A cutting instrument consisting of a blade or thin plate of iron or steel, with one edge dentated or toothed. The saw is employed to cut wood, stone, ivory, and other solid

substances. The best saws are of tempered steel, ground bright, and smooth. They are of various forms and sizes, according to the purposes to which they are to be applied. Those used by carpenters and other artificers in wood are the most numerous. Among these are the following:—The *cross-cut saw*, for cutting logs transversely, and wrought by two persons, one at each end. The *pit saw*, a long blade of steel with large teeth and a transverse handle at each end; it is used in sawpits for sawing logs into planks or scantlings, and is wrought by two persons. The *frame saw*, consisting of a blade from 5 to 7 feet long, stretched tightly in a frame of wood. It is used in a similar manner to the pit saw. The *ripping saw*, *half-ripper*, *hand-saw*, and *panel saw* are saws for the use of one person, the blades tapering in length from the handle. *Tenor saws*, *sash-saws*, *dove-tail-saws*, &c., are saws made of very thin blades of steel, stiffened with stout pieces of brass, iron, or steel fixed on their back edges. They are used for forming the shoulders of tenons, dove-tail joints, &c., and for many other purposes for which a neat clean cut is required. *Compass* and *key-hole saws* are long narrow saws, tapering from about an inch to an eighth of an inch in width, and used for making curved cuts. The key-hole saw is inserted in a long hollow handle, and by a screw it is fixed in any required place, from which it may be made to project more or less, as required. Small *frame-saws* and *bow-saws*, in which very thin narrow blades are tightly stretched, are occasionally used for cutting both wood and metal. Saws for cutting stone are without teeth.—2. † A saying; proverb; maxim; decree. [See *SAY*.]

**SAW**, *v. t. pret. sawed*; *pp. sawed* or *sawn*. [G. *sägen*; It. *segare*, to saw, cut, reap; *L. seco*; *Fr. scier*; allied to *stichle*.] 1. To cut with a saw; to separate with a saw; as, to *saw* timber or marble.—2. To form by cutting with a saw; as, to *saw* boards or planks; that is, to *saw* timber into boards or planks.

**SAW**, *v. i.* To use a saw; to practise sawing; as, a man *saws* well.—2. To cut with a saw; as, the mill *saws* fast or well.—3. To be cut with a saw; as, the timber *saws* smooth.

**SAW-DUST**, *n.* Dust or small fragments of wood or stone made by the attrition of a saw.

**SAWED**, *pp.* Cut, divided, or formed with a saw. In *bot.*, resembling the teeth of a saw.

**SAWYER**, *n.* One that saws; corrupted into *Sawyer*.

**SAW-FISH**, *n.* A fish of the genus

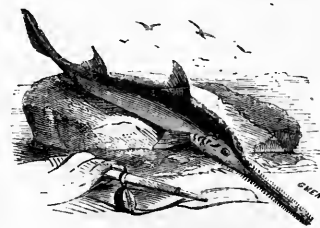

Saw Fish (*Pristis cirratus*).

*Pristis*, belonging to the fixed-gilled

chondropterygians, nearly related, on the one hand, to the sharks, and on the other, to the rays. It has a long beak or snout, with spines growing like teeth on both edges, and four or five spiracles or breathing holes in the sides of the neck.

**SAW-FLY**, *n.* A genus of flies, (*Tenthredo* of Linn.) belonging to the modern family Tenthredinidae, distinguished by their large wings with many cells, the abdomen united to the body by its whole breadth, and terminated on the under side by a pair of organs (ovipositors) which are employed in the act of depositing the eggs in the bark of trees, the twigs of various plants, or within the epidermis of the leaves, something in the same manner as the common hand-saw of mechanics. Thirty British species have been described, some of which, in their larva state, do great mischief to plants.

**SAW-GIN**, *n.* A machine used to divest cotton of its husk and other superfluous parts.

**SAW-MILL**, *n.* A mill for sawing timber, and driven by water or steam. There are two distinct kinds of saw-mills, the *circular* and the *reciprocating*. In the first kind the cutting instrument is a circular plate revolving upon its axis, and having teeth upon its circumference, so that it cuts by a continuous rotatory motion. In the reciprocating saw-mills the cutting instrument operates in the same manner as the common pit or frame-saw, but several saws may be connected together and moved by the same machinery. The circular saw-mills are for the most part used for cutting up timber of small dimensions, or for cutting veneers or very thin boards. Reciprocating saw-mills are used for large timber, in forming beams, rafters, planks, &c., out of large timber.

**SAW-PIT**, *n.* A pit over which timber is sawed by two men, one standing below the timber and the other above.

**SAW-SET**, } *n.* An instrument  
**SAW-WREST**, } used to wrest or turn the teeth of saws a little outward, that they may make a kerf somewhat wider than the thickness of the blade.

**SAW-WORT**, *n.* *Serratula*, a genus of plants, of the class Syngenesia, and order polygamia aequalis, Linn.; nat. order Compositæ. It is so named from its serrated leaves. Common saw-wort, *S. tinctoria*, is a perennial plant indigenous to England, growing in woods and in pasture grounds. It is used for dyeing cloth yellow, and is considered useful against piles.

**SAWYER**, *n.* One whose occupation is to saw timber into planks or boards, or to saw wood for fuel.—2. In *America*, a tree which, being undermined by a current of water, and falling into the stream, which are continually raised and depressed by the force of the current, from which circumstance the name is derived. The *sawyers* in the Mississippi render the navigation dangerous, and frequently sink boats which run against them.

**SAXATILE**, *a.* [*L. saxatilis*, from *saxum*, a rock.] Pertaining to rocks; living among rocks.

**SAXICAVA**, *n.* A genus of bivalves, belonging to the family Lithophagidae, or stone-borers.

**SAXICAVOUS**, *a.* [*L. saxum*, a rock, and *cavo*, to hollow out.] In *zool.*, a



term applied to animals which make holes in the rocks, either by boring them, or by dissolving the rock by means of some acid which they secrete.

**SAXI'COLA**, *n.* In *ornithol.*, the scientific generic name for the stone-chats. **SAXI'FRAGA**, *n.* A genus of plants, the type of the nat. order Saxifragacæ. [See SAXIFRAGE.]

**SAXIFRAGA'CEÆ**, *n.* A nat. order of plants, belonging to the apocarpous group of polypetalous exogens. It consists of shrubs and herbaceous plants, with single alternate leaves, without stipules. The flowers are usually white, delicate, and beautiful. The species inhabit the mountainous districts of Europe and the northern parts of the world. According to De Candolle the whole order is more or less astringent. The root of *Heuchera Americana* is a powerful astringent, and called in North America *alum root*.

**SAXIFRAGE**, *n.* [*L. saxifraga*; composed of *saxum*, a stone, and *frango*, to break.] A medicine that has the property of breaking or dissolving the stone in the bladder. But in *bot.*, the anglicization of Saxifraga, a genus of plants, of the class Decandria, and order dignia, Linn.; nat. order Saxifragacæ. The species are mostly inhabitants of alpine and subalpine regions, of the colder and temperate parts of the northern zone. Most of them are true rock plants, and many are well known as ornamental plants in our gardens, as *S. umbrosa*, London pride, or none-so-pretty; *S. granulata*, white or granulated meadow saxifrage; *S. cotyledon*, or pyramidal saxifrage; *S. hypnoides*, mossy saxifrage or ladies' cushion; *S. crassifolia*, or thick-leaved saxifrage; *S. sarmentosa*, or Chinese saxifrage. Twenty-five species of saxifrage have been enumerated by British botanists. These plants were formerly supposed to be good against the stone in the bladder; hence the name. The *burnet saxifrage* is of the genus *Pimpinella*; the *golden saxifrage* is of the genus *Chrysosplenium*; the *meadow saxifrage* is of the genus *Peucedanum*. **SAXIFRAGOUS**, *a.* Dissolving the stone.

**SAX'ON**, *n.* [*Sax. sear*, a knife, sword, or dagger, a Saxon.] 1. One of the nation or people who formerly dwelt in the northern part of Germany, and who invaded and conquered England in the fifth and sixth centuries. The Welsh still call the English *Saxons*.—2. The language of the Saxons. The terms Saxon and Anglo-Saxon are popularly used to designate that dialect of the English language, which prevailed to the close of the twelfth century.

**SAX'ON**, *a.* Pertaining to the Saxons, to their country, or to their language. **SAX'ON ARCHITECTURE**, *n.* The architecture of England before the Norman Conquest. There are some supposed remains of this style in existence, but the characteristics are not satisfactorily determined.

**SAX'ON BLUE**, *n.* A solution of indigo in concentrated sulphuric acid. It is much used as a dye stuff.

**SAX'ONISM**, *n.* An odium of the Saxon language.

**SAX'ONIST**, *n.* One versed in the Saxon language.

**SÄY**, *v. t. pret.* and *pp. said*, contracted from *sayed*. [*Sax. sagan, saegan*; *G. sagan*; *Ch. סאג*, *sufaha*, to speak or say.

The same verb in Arabic, *sauga*, signifies to *sink*, Goth. *sigcan*. The sense of the root is to throw or thrust.] 1. To speak; to utter in words; as, he *said* nothing; he *said* many things; he *says* not a word. *Say* a good word for me. It is observable that although this word is radically synonymous with *speach* and *tell*, yet the uses or applications of these words are different. Thus, we say, to *speach* an oration, to *tell* a story; but in these phrases, *say* can not be used. Yet to *say* a lesson is good English, though not very elegant. We never use the phrases, to *say* a sermon or discourse, to *say* an argument, to *say* a speech, to *say* testimony. A very general use of *say* is to introduce a relation, narration, or recital, either of the speaker himself or of something said or done, or to be done by another. Thus, Adam *said*, This is bone of my bone; Noah *said*, Blessed be the Lord God of Shem. If we *say* we have no sin, we deceive ourselves. *Say* to the cities of Judah, Behold your God. I can not *say* what I should do in a similar case. *Say* thus precedes a sentence. But it is perhaps impracticable to reduce the peculiar and appropriate uses of *say*, *speach*, and *tell* to general rules. They can be learnt only by observation.—2. To declare; Gen. xxxvii.—3. To utter; to pronounce.

*Say* now Shiloboth; Judg. xii.

4. To utter, as a command.

God *said*, Let there be light; Gen. i.

5. To utter, as a promise; Luke xxiii.

—6. To utter, as a question or answer; Mark xi.—7. To affirm; to teach; Matth. xvii.—8. To confess; Luke xvii.

—9. To testify; Acts xxiv.—10. To argue; to allege by way of argument.

After all that can be *said* against a thing. *Tillotson*.

11. To repeat; to rehearse; to recite; as, to *say* a lesson.—12. To pronounce; to recite without singing. Then shall be *said* or sung as follows.—13. To report; as, in the phrases, it is *said*, they *say*.—14. To answer; to utter by way of reply; to tell.

*Say*, Stella, feel you no content, Reflecting on a life well spent? *Swift*.

**Note**.—This verb is not properly intransitive. In the phrase, "as when we *say*, Plato is no fool," the last clause is the object after the verb; that is, "we *say* what follows." If this verb is properly intransitive in any case, it is in the phrase, "that is to *say*," but in such cases, the subsequent clause is the object of the verb, being that which is said, uttered, or related.

**SÄY**, *n.* [*Sax. saga, sagu*.] A speech; something said. [*In popular use, but not elegant*.]

**SÄY**, *† n.* [*for assay*.] A sample.—*†* Trial by sample.

**SÄY**, *† n.* [*Fr. soie*.] A thin silk.

**SÄY**, *† n.* In *com.*, a kind of serge used

**SÄYE**, *†* for linings, shirts, aprons, &c.

**SÄYING**, *ppr.* Uttering in articulate sounds or words; speaking; telling; relating; reciting.

**SÄYING**, *n.* An expression; a sentence uttered; a declaration.

Moses fled at this *saying*; Acts vii.

Cicero treasured up the *sayings* of Seneca. *Middleton*.

2. A proverbial expression. Many are the *sayings* of the wise.

**SCAB**, *n.* [*Sax. scab, scob*; *G. schabe*; *L. scabies*.] It seems to be connected with *L. scabo*, to rub or scratch, *G. schaben*, to shave, *W. ysghbare*, to

sweep, *L. scaber*, rough, *D. schob*, a scale.] 1. An incrustated substance, dry, and rough, formed over a sore in healing.—2. The mange in horses; a disease of sheep.—3. A mean, dirty, paltry fellow. [*Low*.]

**SCAB'BAID**, *n.* The sheath of a sword.

**SCAB'BAIRD**, *v. t.* To put in a sheath.

**SCAB'BARDED**, *pp.* Put into a sheath.

**SCAB'BARING**, *ppr.* Sheathing.

**SCAB'BED**, *a.* [*from scab*.] Abounding with scabs; diseased with scabs.—

2. Mean; paltry; vile; worthless.

**SCAB'BEDNESS**, *n.* The state of being scabbed.

**SCAB'BINESS**, *n.* [*from scabby*.] The quality of being scabby.

**SCAB'BLE**, *v. t.* To dress a stone with a broad chisel, called, in England, a *boaster*, and in Scotland a *drove*, after it has been pointed or broached, and preparatory to finer dressing.

**SCAB'BY**, *a.* [*from scab*.] Affected with scabs; full of scabs.—2. Diseased with the scab or mange; mangy.

**SCAB'BLIES**, *n.* [*L.*] The itch, of which four varieties have been distinguished, viz., the *rank, watery, pocky*, and *scorbittic* itch. [*See ITCU*.]

**SCA'BIOUS**, *a.* [*L. scabiosus*, from *scabies*, scab.] Consisting of scabs; rough; itchy; leprous; as, *scabious* eruptions.

**SCA'BIOUS**, *n.* Scabiosa, an extensive genus of annual and perennial herbs, found in all parts of the world. Class and order Tetrandria monogynia, Linn.; nat. order Dipsacæ. The Indian species are admitted into our gardens. A few are British weeds, of which the most remarkable is *S. succisa*, or devils'-bit scabious. [*See DEVILS'-BIT*.]

**SCABRED'ITY**, *† n.* [*L. scabredo, scabrities*.] Roughness; ruggedness.

**SCA'BROUS**, *a.* [*L. scabrosus, scaber*, from *scabies*, scab.] 1. Rough; rugged; having sharp points, or little asperities. Applied in *bot.*, *conchol.*, and *entomol.* to surfaces that are rough, or have small elevations.—2. Harsh; unmusical.

**SCA'BROUSNESS**, *n.* Roughness; ruggedness.

**SCAB'WORT**, *n.* A plant, a species of Helonium.

**SCAD**, *n.* A fish, the *shad*,—*which see*.—2. A fish of the genus Caranx, (*Scomber trachurus*, Linn.)

**SCAF'OLD**, *n.* [*Fr. echafaud*; *Ir. scafal*; *G. schafot*; perhaps from the root of *shape*, as *form* is used for *bench*. The last syllable is the *L. fala*. In Cornish, *shaval* is a bench or stool, and this word, *schavot*, in Dutch, signifies a tailor's bench, as well as a scaffold.]

1. Among *builders*, an assemblage or structure of timbers, boards, or planks, erected by the wall of a building to support the workmen.—2. A temporary gallery or stage raised either for shows or spectators.—3. A stage or elevated platform for the execution of a criminal.

**SCAF'FOLD**, *v. t.* To furnish with a scaffold; to sustain; to uphold.

**SCAF'FOLDAGE**, *n.* A gallery; a hollow floor.

**SCAF'FOLDED**, *pp.* Furnished with a scaffold.

**SCAF'FOLDING**, *ppr.* Furnishing with a scaffold.

**SCAF'FOLDING**, *n.* A frame or structure for support in an elevated place. In *arch.*, the temporary combination of timber-work by the means of upright poles, and horizontal pieces, on which later are laid the boards for

supporting the builders in carrying up the different stages or floors of a building, or plasterers in executing their work in the interior of houses, and which are struck or removed as soon as they have answered their purpose.

—2. That which sustains; a frame; as, the *scaffolding* of the body.—3. Temporary structure for support.—4. Materials for scaffolds.

SCA'GLIA, *n.* (skal'ye-a.) [It.] A reddish variety of chalk.

SCAGLIO'LA, *n.* (scályeo'la.) [It.] In *arch.*, a composition, sometimes also called *Mischia*, from the mixture of colours in it being made to imitate marble. It is composed of gypsum, or sulphate of lime calcined and reduced to a fine powder, with the addition of water, to which a fine paste is made, in which the requisite colours are diffused. It is laid on brickwork like stucco, and worked off with fine iron tools. It bears a fine polish. Columns are formed of it, as those of the Pantheon in London.

SCAITH. See SKAITH.

SCALABLE, *a.* That may be scaled.

SCALADE, } *n.* [Fr. *scalade*; Sp. SCALA'DO, } *scaldado*; from *L. scala*, a ladder. See SCALE.] A storm or assault on a fortified place, in which the soldiers enter the place by means of ladders. It is written also *Escalade*.

SCALA'RIA, *n.* A genus of marine turreted univalves, with anti-longitudinal raised ribs. They are found in sandy mud, at depths varying from seven to thirteen fathoms. This mollusc has been commonly called the

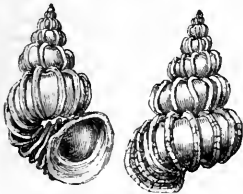

Scalaria pretiosa.

Wentletrap, a corruption of the German word *Wendel-treppe*, a winding stair-case. The typical and most celebrated species of Wentletrap is *S. pretiosa*, which was formerly rare, and brought a large price in the market.

SCALA'RIFORM, *a.* [L. *scalaris*, a ladder, and *forma*, form.] Shaped like a ladder; resembling a ladder.—*Scalarijorm vessels*, in *bot.*, tubes met with in plants, especially in tree ferns, distinguished by having bars at regular intervals so as to resemble a ladder.

SCALARY, *a.* Resembling a ladder; formed with steps. [Little used.]

SCALD, *v. t.* [It. *scaldare*; Fr. *echauder*, for *eschalder*; Ir. *sgallaim*; from the root of *L. caleo*, *calda*, *calidus*. Probably the primary sense of *caleo* is to contract, to draw, to make hard.] 1. To burn or painfully affect and injure by immersion in or contact with a liquor of a boiling heat, or a heat approaching it; as, to scald the hand or foot. We scald the part when the heat of the liquor applied is so violent as to injure the skin and flesh. Scald is sometimes used to express the effect of the heat of other substances than liquids.

Here the blue flames of scalding brimstone fall.

Cowley.

2. To expose to a boiling or violent heat over a fire, or in water or other liquor; as, to scald meat or milk.

SCALD, *n.* [supra.] A burn, or injury to the skin and flesh by hot liquor.

SCALD, *n.* [Qn. Sax. *scyll*, a shell.] Scab; scurf on the head.

SCALD, *a.* Scurvy; paltry; poor; as, scald rhymers.

SCALD, *n.* [Dan. *skialdrer*, to make verses, also a poet. The primary sense is probably to make or to sing. If the latter, we find its affinities in G. *schallen*, D. *schellen*, Sw. *shalla*.] Among the ancient Scandinavians, a poet; one whose occupation was to compose poems in honour of distinguished men and their achievements, and to recite and sing them on public occasions. The scalds of Denmark and Sweden answered to the bards of the Britons or Celts.

SCALD'ED, *pp.* Injured by a hot liquor; exposed to boiling heat.

SCALD'ER, *n.* A scald; a Scandinavian poet.

SCALD'-HEAD, *n.* [See SCALD.] A pustular eruption mostly of the hairy scalp, in which the pustules are indistinct, often distant patches, gradually spreading till the whole head is covered as with a helmet; skin below the scabs red, shining, dotted with papillous apertures, excreting fresh matter; roots of the hair often destroyed. It is the Porrigo galeata of Good.

SCALD'IE, *a.* Pertaining to the scalds or poets of antiquity; composed by scalds.

SCALD'ING, *ppr.* Burning or injuring by hot liquor.—2. Exposing to a boiling heat in liquor.

SCALD'ING-HOT, *a.* So hot as to scald the skin.

SCALE, *n.* [Sax. *scale*, *sceale*; D. *schaal*, a scale, a bowl, saucer, or dish, and a shell, uniting the Sax. *scale* and *scell*; G. *schale*, a scale or balance, a dish, bowl, shell, peel, or paring; Dan. *skal*, a shell; *skaler*, to shell, peel, or pare; *skiel*, a fish scale; Sw. *skal*, a shell; Fr. *ecaille*; *ecaille*, to scale or peel; *ecale*, a shell; *ecaler*, to shell; *echelle*, a scale or ladder; It. *scaglia*, the scale of a fish; *scala*, a ladder; L. *id.*, Sp. *escala*. Scale, a shell and a dish, is probably from peeling or paring, that is, separating; but whether a simple or compound word, [*es-cal*, *ex-cal*], we do not know. If the sense is to strip, it coincides with the Gr. *σχυλαω*, to spoil.] 1. The dish of a balance; and hence, the balance itself, or whole instrument; as, to turn the scale.

Long time in even scale

The battle hung. Milton.  
But in general, we use the plural, *scales*, for the whole instrument.

The scales are turn'd; her kindness weighs no more

Now than my vows. Waller.

2. The sign of the Balance, or Libra, in the zodiac.—3. The small shell or crust which composes a part of the covering of a fish; and hence, any thin layer or leaf exfoliated or separated; a thin lamina; as, *scales* of iron or of bone. The scales of fish consist of alternate layers of membrane and phosphate of lime. The scales of serpents are composed of a horny membrane, without the calcareous phosphate. The scales of plants are thin, flat, membranous, scurf-like processes, formed of cellular tissue.—4. A ladder; series of steps; means of ascending. [L. *scala*.]—5. The act of storming a place by mounting the

walls on ladders; an escalade, or scalade.—6. In *math.*, a scale is any line drawn upon wood, ivory, or other solid substance, and divided into parts equal or unequal, the lengths of which may be taken off by the compasses, and transferred to paper, in aid of any geometrical construction. The manner in which the scale is divided depends of course upon the nature of the algebraical or trigonometrical expression, the values of which are to be represented. The most simple of all scales is that in which the divisions are equal, or, as it is called, a scale of equal parts. The term *scale*, however, is generally applied to a thin flat rule of wood, ivory, or metal, and of a rectangular form, having an assemblage of lines and figures engraved on it, for the purpose of measuring distances, extent, proportions, &c.; the lines being variously divided according to the purpose which the instrument is intended to serve.—*Plain scale*, a flat rule, one or two feet in length, and about two inches broad. It has, drawn upon it lines of equal parts; lines of chords, sines, tangents, secants, &c.—*Gunter's scale*, a large plain scale usually two feet long and an inch and a half broad. On one side of it are placed the natural lines; as the line of chords, the line of sines, tangents, rhombs, &c.; and on the other the corresponding logarithmic lines. By means of these lines the various problems in trigonometry may be solved, with the aid of a pair of compasses. Gunter's scale is used especially for solving questions in navigation.—*Diagonal scale*. [See under DIAGONAL.] The word scale is used in mensuration to signify a line or rule of a definite length divided into a given number of equal parts, and used for the purpose of measuring other linear magnitudes. It becomes a *standard scale*, when all its divisions have been examined and compared with some standard measure. The scales of thermometers are graduated from some arbitrary point, or zero (as that which indicates the temperature of freezing water), from which the temperature is counted upwards or downwards in degrees, which are also arbitrary. Scales of equal parts, marked upon plans, drawings, are lines explanatory of the real dimensions of the objects delineated, instead of their actual dimensions on the paper.—7. Regular gradation; a series rising by steps or degrees like those of a ladder. Thus, we speak of the *scale* of being, in which man occupies a higher rank than brutes, and angels a higher rank than man.—8. Any instrument, figure, or scheme graduated for the purpose of measuring extent or proportions; as a map drawn by a scale of half an inch to a league.—9. In *music*, a gamut; a diagram; or a series of lines and spaces rising one above another, on which notes are placed; or a scale consists of the regular gradations of sounds. A scale may be limited to an octave, called by the Greeks a tetrachord, or it may extend to the compass of any voice or instrument. [See DIATONIC, CHROMATIC.]—10. Any thing graduated or marked with degrees at equal distances.—*Scale of equivalents*, in *chem.*, an instrument devised by Wollaston, consisting of a flat scale with a slide, having engraved on it a table of equivalents, comprehending all those substances

which are most frequently employed by chemists in the laboratory. From the mathematical construction of the scale, it not only serves the same purpose as other tables of equivalents, but in many instances it supersedes the necessity of calculation. Thus, if it is required to determine how many parts of sulphuric acid, and how many of potassa are contained in 100 parts of sulphate of potassa, it is only necessary to move the slide until 100 marked upon it is in a line with the name sulphate of potassa, on the fixed part of the scale, and the numbers on the slide opposite to the terms sulphuric acid and potassa, will give the precise quantity of each contained in 100 parts of the compound. In the original scale of Wollaston, oxygen is taken as the standard of comparison; but hydrogen may be selected with equal propriety, and scales of this kind have been prepared by Reid of Edinburgh. [See EQUIVALENT.]—11. In *arith.*, the order of progression on which any system of notation is founded; as, the *binary scale*, *denary scale*, &c.

**SCALE**, *v. t.* [It. *scalare*, from *scala*, a ladder.] 1. To climb, as by a ladder; to ascend by steps; and applied to the walls of a fortified place, to mount in assault or storm.

Off have I *scal'd* the craggy oak. *Spenser*.  
2. [from *scale*, a balance.] To measure; to compare; to weigh.

*Scaling* his present bearing with his past.

*Shak.*

3. [from *scale*, the covering of a fish.] To strip or clear of scales; as, to *scale* a fish.—4. To take off in thin laminae or scales.—5. To pare off a surface.

If all the mountains were *scal'd*, and the earth made even. *Burnet*.

6. In *Scotland* and the north of *England*, to spread, as manure or loose substances; also, to disperse; to waste, usually written *shail*.—7. In *gunnery*, to clean the inside of a cannon by the explosion of a small quantity of powder.

**SCALE**, *v. i.* To separate and come off in thin layers or laminae.

The old shells of the lobster *scale* off.

*Bacon*.

**SCALED**, *pp.* Ascended by ladders or steps; cleared of scales; pared; scattered.—2. *a.* Having scales like a fish; squamous; as, a *scaled* snake.

**SCALELESS**, *a.* Destitute of scales.

**SCALE MOSSES**, *n.* A name applied to the species of *Jungermannia*, moss-like plants, which occur in shady woods and moist places.

**SCALENE**, } *a.* [Gr. *σκαληνός*, ob-  
**SCALENOUS**, } lique, unequal, allied probably to *σκαλιος*: *G. schel*, *schiel*, *D. scheel*, squinting; *Dan. skielter*, to squint.] A *scalene triangle*, is one of which the three sides are unequal. A cone or cylinder is also said to be *scalene*, when its axis is inclined to its base; but in this case the term *oblique* is more frequently used.

**SCALENE**, *n.* A scalene triangle.

**SCALENUS**, *n.* [Gr. *σκαληνός*, irregular, unequal.] In *anat.*, a muscle of the neck situated between the transverse processes of the cervical vertebrae, and the upper part of the thorax. Its use is to move the neck to one side when it acts singly, or to bend it forward when both muscles act; and when the neck is fixed, it serves to elevate the ribs and dilate the chest.

**SCALER**, *n.* One who scales.

**SCALINESS**, *n.* [from *scaly*.] The state of being scaly; roughness.

**SCALING**, *ppr.* Ascending by ladders or steps; storming.—2. Stripping of scales.—3. Peeling; paring.

**SCALING-LADDER**, *n.* A ladder made for enabling troops to scale a wall.

**SCALIO'LA**. See *SCAGLIOLA*.

**SCALL**, *n.* [See *SCALD* and *SCALD-HEAD*.] Scab; scabbiness; leprosy.

It is a dry *scall*, even a leprosy on the head; *Lev. xiii.*

**SCALLED** *a.* Scurfy; scabby.

**SCAL'LION**, *n.* [It. *scalogno*; *L. ascalonia*; *Fr. echalote*, whence our *shatot*; so named probably from its coats, *shell, scale*.] A plant, the *Allium Ascalonicum*, a kind of onion. [See *SHALLOT*.]

**SCAL'LOP**, *n.* This is from the root of *shell, scale*; coinciding with *scalp*, *D. schulp*, a shell.] 1. A testaceous mollusc called pecten. The shell is bivalvular, the hinge toothless, having a small ovated hollow, from which alternate ribs and furrows usually run diverging to the margin of the shell. There are numerous species used for food, some of which are found in the seas of most climates. The shell occurs in abundance on the coast of Palestine, and was formerly worn by pilgrims as a mark that they had been to the Holy Land.—2. A recess or curving of the edge of any thing, like the segment of a circle; written also *scallopp*.—*Scallopp budding*, a method of grafting by gems. It is performed by paring a thin tongue-shaped portion of bark from the stock, and applying the bud without divesting it of its portion of wood, so that the barks of both may exactly fit, and then tying it in the usual way.

**SCAL'LOP**, *v. t.* To mark or cut the edge or border of any thing into segments of circles.—2. To cook in the shell, as oysters. [See *SCALLOPED*.]

**SCAL'LOPED**, *pp.* Cut at the edge or border into segments of circles.—*Scalloped*, or *scolloped* oysters, are oysters baked with bread-crumbs in their own shells, or in small tin pans of shell-like form.

**SCAL'LOPING**, *ppr.* Cutting the edge into segments of circles.

**SCALP**, *n.* [D. *schelp* or *schulp*, a shell. The German has *hirschschele*, brain-shell. See *SCALE*. But qu. the Ch. Syr. and Ar. *קקל*, *kaleph*, to peel, to bark, and *L. scalpo*.] 1. The skin of the top of the head; as, a hairless *scalp*; sometimes the skull itself, or the fore part of it.—2. The skin of the top of the head cut or torn off. A *scalp* among the Indians of America is a trophy of victory.

**SCALP**, *v. t.* To deprive of the scalp or integuments of the head.

**SCALP'ED**, *pp.* Deprived of the skin of the head.

**SCALP'EL**, *n.* [L. *scalpellum*, from *scalpo*, to scrape.] In *sur.*, a knife used in anatomical dissections and surgical operations.

**SCALP'ER**, } *n.* An instru-  
**SCALP'ING-IRON**, } ment of surgery, used in scraping foul and carious bones; a raspatory.

**SCALP'ING**, *ppr.* Depriving of the skin of the top of the head.

**SCALP'ING-KNIFE**, *n.* A knife used by savages in scalping their prisoners.

**SCALP'RUM**, *n.* [L. a knife.] In *mammalogy*, the cutting edge of the incisor teeth.

**SCALY**, *a.* [from *scale*.] Covered or

abounding with scales; rough; as, a *scaly* fish; the *scaly* crocodile.—2. Resembling scales, lamina, or layers.—3. In *bot.*, composed of scales lying over each other, as a *scaly* bulb; having scales scattered over it, as a *scaly* stem.—4. In *low lan.*, shabby, mean, stingy.

**SCALY-WINGED**, *a.* Having wings with scales.

**SCAM'BLE**, *v. i.* [D. *schommelen*, to stir, to shake.] 1. To stir quick; to be busy; to scramble; to be bold or turbulent.—2. To shift awkwardly.

**SCAM'BLE**, *v. t.* To mangle; to maul.

**SCAM'BLER**, *n.* A bold intruder upon the generosity or hospitality of others.

**SCAM'BLING**, *ppr.* Stirring; scambling; intruding.

**SCAM'BLINGLY**, *adv.* With turbulence and noise; with bold intrusiveness.

**SCAMIL'LI**, *n.* [L.] In *ancient arch.*, a sort of second plinths or blocks under

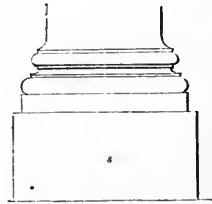

\*, Scamilli.

statues, columns, &c., to raise them, but not, like pedestals, ornamented with any kind of moulding.

**SCAMMO'NIATE**, *a.* [from *scammony*.] Made with scammony.

**SCAM'MONY**, *n.* [L. *scammonia*, from the Persian.] 1. A plant of the genus *Convolvulus*, the *C. scammonia*, which



Scammony 'Convolvulus scammonia'.

grows abundantly in Syria.—2. An inspissated sap obtained from the plant *Convolvulus Scammonia*, of a blackish grey colour, a nauseous smell, and a bitter and acrid taste. The best scammony comes from Aleppo, in light spongy masses, easily friable. That of Smyrna is black, ponderous, and mixed with extraneous matter. It is used in medicine as a drastic purge, and usually administered in combination with other purgatives in doses of three or four grains.

**SCAMP**, *n.* [See *SCAMPER*.] A worthless fellow. [*Collaq.*]

**SCAMPER**, *v. i.* [D. *schampen*, to slip aside; *Fr. escamper*; *It. scampare*, to escape, to save one's self; *scampo*, safety; *campare*, to preserve, to fly, to

escape; Sp. *escampar*, to clear out a place.] To run with speed; to hasten escape.

SCAMP'ERING, *ppr.* Running with speed; hastening in flight.

SCAN, *v. t.* [Fr. *scander*; It. *scandire*, *scandere*, to climb, to scan. The Italian is the L. *ascendo*. See ASCEND.] 1. To examine with critical care; to scrutinize.

The actions of men in high stations are all conspicuous, and liable to be scanned and sifted. *Atterbury.*

2. To examine a verse by counting the feet; or according to modern usage, to recite or measure verse by distinguishing the feet in pronunciation. Thus in Latin and Greek, a hexameter verse is resolved into six feet by *scanning*, and the true quantities are determined.

SCAND'AL, *n.* [Fr. *scandale*; L. *scandalum*; Gr. *σκάνδαλον*: Ir. *scannail*, slander. In Greek, this word signifies a stumbling-block, something against which a person impinges, or which causes him to fall. In Sax. *scande*, *sconde*, signifies shame, confusion, dishonour, infamy; D. *schande*, id.; *schandul*, reproach, scandal; G. *schande*, shame; *schänden*, to mar, disfigure, spoil, violate; Dan. *skjænder*, to abuse, defame, &c.; Sans. *schiamde* or *ishanda*, scandal. In Arm. *scandal* is a quarrel. The primary sense of the root must be to drive, to thrust, or to strike or cast down.] 1. Offence given by the faults of another.

His lustful orgies he enlarged  
Even to the hill of *scandal*. *Milton.*

[In this sense we now generally use *offence*.]—2. Reproachful aspersion; opprobrious censure; defamatory speech or report; something uttered which is false and injurious to reputation. My known virtue is from *scandal* free. *Dryden.*

3. Shame; reproach; disgrace. Such is the perverted state of the human mind that some of the most heinous crimes bring little *scandal* upon the offender.

SCAN'DAL, *v. t.* To treat opprobriously; to defame; to asperse; to traduce; to blacken character.

I do fawn on men, and hug them hard,  
And after *scandal* them. [Little used.] *Shak.*

2. † To scandalize; to offend.

SCAN'DALIZE, *v. t.* [Gr. *σκανδαλιζω*: L. *scandalizo*; Sp. *escandalizar*; It. *scandalizzare*; Fr. *scandaliser*.] 1. To offend by some action supposed criminal.

I demand who they are whom we *scandalize* by using harmless things? *Hooker.*

2. To reproach; to disgrace, to defame; as, a *scandalizing* libeller.

SCAN'DALIZED, *pp.* Offended; defamed; disgraced.

SCAN'DALIZING, *ppr.* Giving offence to; disgracing.

SCAN'DALOUS, *a.* [It. *scandaloso*; Fr. *scandaleux*.] 1. Giving offence.

Nothing *scandalous* or offensive to any.

2. Opprobrious; disgraceful to reputation; that brings shame or infamy; as, a *scandalous* crime or vice. How perverted must be the mind that considers seduction or duelling less *scandalous* than larceny.—3. Defamatory.

SCAN'DALOUSLY, *adv.* Shamefully; in a manner to give offence

His discourse at table was *scandalously* unbecoming the dignity of his station. *Swift.*

2. † Censoriously; with a disposition to find fault; as, a critic *scandalously* nice.

SCAN'DALOUSNESS, *n.* The quality of being scandalous; the quality of giving offence, or of being disgraceful.

SCAN'DALUM MAGNATUM. In law an action which lies against those who speak scandalous or derogatory words of peers, judges, (*magnates*, "great men of the realm,") and some high officers. It has, however, for a long period never been resorted to. It is often abbreviated into *scan. mag.*

SCAN'DENT, *a.* [L. *scandens*, *scando*, to climb.] Climbing, either with spiral tendrils for its support, or by adhesive fibres, as a stalk; climbing; performing the office of a tendril, as a petiole.

SCAN'DIX, *n.* A genus of plants, nat. order Umbelliferae. It is composed of annual herbs with square, rather striated stems, bipinnate leaves, the leaflets divided into linear lobes. *S. pecten veneris*, needle-chervil, or Venus's comb, is found in Britain. [See NEEDLE-CHEVIL.] *S. cerefolium*, the garden chervil, is used in France as a salad, and in Holland as a pot-herb.

SCAN'NED, *pp.* Critically sifted or examined; resolved into feet in recital.

SCAN'NING, *ppr.* Critically examining; resolving into feet, as verse.

SCAN'NING, *n.* In *poetry*, the measuring of a verse by feet, in order to see whether the quantities be duly observed. The term is chiefly used in regard to Greek and Latin verses.

SCAN'SION, *n.* The act of scanning.

SEANSO'RES, } *n.* [L. *scando*, to climb.] Climbing birds.

The name of an order of birds including those which have the toes arranged in pairs, two before, and two behind; a conformation of the foot which is admirably adapted for climbing.

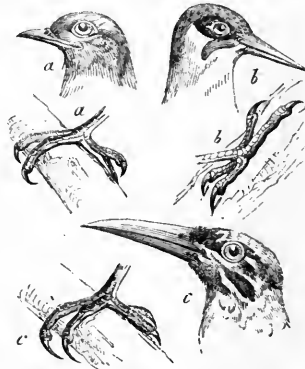

Seansores.  
a, Head and foot of Cuckoo; b, Do. of Green Woodpecker; c, Do. of Great Jacamar.

The jacamars, woodpeckers, cuckoos, barbets, toucans, parrots, &c., belong to this order. There are climbing birds, however, which do not belong to this order, as for example, the creepers and nuthatches.

SEANSO'RIAL, *a.* Climbing, or adapted to climbing; an epithet applied to the order of birds called *seansores*.

SCAN'T, *v. t.* [Dan. *skaanet*, from *skaaner*, to spare.] To limit; to straiten; as, to *scan* one in provisions; to *scan* ourselves in the use of necessities; to *scan* a garment in cloth.

I am *scanted* in the pleasure of dwelling on your actions. *Dryden.*

SCAN'T, *v. i.* To fail or become less; as, the wind *scants*.

SCAN'T, *a.* Not full, large, or plentiful; scarcely sufficient; rather less than is wanted for the purpose; as, a *scan*t allowance of provisions or water; a *scan*t pattern of cloth for a garment.—2. Sparing; parsimonious; cautiously affording.

Be somewhat *scanter* of your maiden presence. † *Shak.*

3. Not entirely favourable for a ship's course; as, a *scan*t wind; also, a light wind.

SCAN'T, *adv.* Scarcely; hardly; not quite.

The people received of the bankers *scan*tly twenty shillings for thirty. [Obsolete or vulgar.] *Camden.*

SCAN'T'ED, *pp.* Limited; straitened.

SCAN'T'ILY, *adv.* [from *scanty*.] Not fully; not plentifully. The troops were *scanty* supplied with flour.—2. Sparingly; niggardly; as, to speak *scanty* of one. [Unusual.]

SCAN'T'INESS, *n.* Narrowness; want of space or compass; as, the *scantiness* of our heroic verse.—2. Want of amplitude, greatness, or abundance; limited extent.

Alexander was much troubled at the *scantiness* of nature itself. *South.*

3. Want of fullness; want of sufficiency; as, the *scantiness* of supplies.

SCAN'T'LE, *v. t.* To be deficient; to fail.

SCAN'T'LE, *v. i.* To divide into thin or small pieces; to shiver.

SCAN'T'LE, *n.* Among *slaters*, a gauge by which slates are regulated to their proper length.

SCAN'T'LET, † *n.* [See SCANTLING.] A small pattern; a small quantity.

SCAN'T'LING, *n.* [Fr. *echantillon*, a pattern.] 1. A pattern; a quantity cut for a particular purpose.—2. A small quantity; as, a *scantling* of wit.—3. A certain proportion or quantity.—4. In *carpentry*, the dimensions of a piece of timber in breadth and thickness; also, a general name for small timbers, such as the quartering for a partition, rafters, purlins, or pole-plates in a roof, &c.—

In *masonry*, the same word is used to express the size of stones in length, breadth, and thickness.—5. In *seamen's* lan., the dimensions of a piece of timber with regard to its breadth and thickness. Thus, two ships of different sizes may have the same *scantling*.

SCAN'T'LING, † *a.* Not plentiful; small.

SCAN'T'LY, † *adv.* Scarcely; hardly.—2. Not fully or sufficiently; narrowly; penuriously; without amplitude.

SCAN'T'NESS, *n.* [from *scant*.] Narrowness; smallness; as, the *scantness* of our capacities.

SCAN'T'Y, *a.* [from *scant*, and having the same signification.] 1. Narrow; small; wanting amplitude or extent.

His dominions were very narrow and *scanty*. *Locke.*

Now *scantier* limits the proud arch confine. *Pope.*

2. Poor; not copious or full; not ample; hardly sufficient; as, a *scanty* language; a *scanty* supply of words; a *scanty* supply of bread.—3. Sparing; niggardly; parsimonious.

In illustrating a point of difficulty; be not too *scanty* of words. *Watts.*

SCAPE, † *n.* An escape. [See ESCAPE.]—2. † Means of escape; evasion.—3. † Freak; aberration; deviation.—4. † Loose act of vice or lewdness.

**SCAPE**, *n.* [*L. scapus*; probably allied to *scipio*, and the Gr. *σκαπτος*, sceptre.] In *bot.* a radical stem bearing the fructification without leaves, as in the narcissus and hyacinth.—In *arch.*, the apophyge, or spring of a column; the part where a column springs out of its base, usually moulded into a concave sweep, or cavetto.

**SCAPE**, † *v. t.* or *i.* The contracted form of *escape*, once allowed to be used in verse; we find it even in Pope's poems. [See **ESCAPE**.]

**SCAPE-GOAT**, *n.* [*escape* and *goat*.] In the Jewish ritual, a goat which was brought to the door of the tabernacle, where the high-priest laid his hands upon him, confessing the sins of the people, and putting them on the head of the goat; after which the goat was sent into the wilderness, bearing the iniquities of the people; Lev. xvi.

**SCAPE-GRACE**, *n.* An idle worthless fellow.

**SCAPELESS**, *a.* [*from scape*.] In *bot.*, destitute of a scape.

**SCAPEMENT**, *n.* The method of communicating the impulse of the wheels to the pendulum of a clock. [See **ESCAPEMENT**.]

**SCAPHA**, *n.* [*L.* a skiff or cock-boat.] In *anat.*, the cavity of the external ear between the helix and the antihelix. Also, the name of a double-headed roller.

**SCAPHISM**, *n.* [*Gr. σκαπτο*, to dig, or make hollow.] Among the Persians, a barbarous punishment inflicted on criminals, by confining them in a hollow tree till they died.

**SCAPHITE**, *n.* [*L. scapha*.] Fossil remains of the scapha, or an extinct genus of Cephalopods, of a boat shaped form. The *scaphites* belong to the family of Ammonites. They have an elliptical-chambered shell, the inner extremity being coiled up in whorls embracing one another, and the outer extremity continued nearly in a horizontal plane, and then folded back. These beautiful shells are almost peculiar to the chalk formation.

**SCAPHOID**, *a.* [*Gr. σκαφη*, a skiff, and *ιδος*, resemblance.] Boat-shaped; resembling a boat.—*Scaphoid bone*, a bone of the tarsus of the paddle of an ichthyosaurus, so named from its peculiar shape.

**SCAPLING**, or **SCABBLING**, *n.* In *masonry*, a method of tooling the face of a stone, in order to reduce it to nearly the intended form, previous to the operation of hewing.—*Scapling* or *scabbling hammer*, a hammer used in rough-dressing stones; one end of the hammer is square, and the other has a point, or is axe-shaped. [See **SCABBLE**.]

**SCAPOLITE**, *n.* [*Gr. σκαπτος*, a rod, and *λιθος*, a stone.] A mineral which occurs massive, or more commonly in four or eight sided prisms, terminated by four-sided pyramids. It takes its name from its long crystals, often marked with deep longitudinal channels, and collected in groups or masses of parallel, diverging, or intermingled prisms. It is the radiated, foliated, and compact scapolite of Jameson, and the paranthine and Wernerite of Haüy and Bronnart.

**SCAPPLE**, *v. t.* To rough-dress stone preparatory to hewing. [See **SCABBLE**.]

**SCAPULA**, *n.* [*L.*] The shoulder-blade.

**SCAPULAR**, *a.* [*L. scapularis*.] Pertaining to the shoulder, or to the scapula; as, the *scapular* arteries.

**SCAPULAR**, *n.* [*supra*.] In *anat.*, the name of two pairs of arteries and as many veins.—2. In *ornithology*, a feather which springs from the shoulder of the wing, and lies along the side of the back.

**SCAPULAR**, } *n.* A part of the vest-  
**SCAPULARY**, } ment of a *religieux*, which was put above his frock, over his shoulders, and which was meant to protect his garments while working with the hands; serving the same purpose as an apron to a female or to an operative.—2. A piece of cloth depending from the shoulders, and hanging low (say to near the feet), both before and behind; forming a portion of the dress of certain kinds of *religieux*, as "a blue *scapulary*," "a black *scapulary*," "To wear a *scapulary*."—3. Two small bits of cloth joined by ribbons, so as to be worn together on the person; as, "*scapularies* of the Holy Sacrament." "To sell *scapularies*."—4. In *sur.*, *scapulary* is the name given to a bandage for the shoulder blade.

**SCAPUS**, *n.* [*L.* *astak*.] In *ornithology*, the stem or trunk of a feather, including the hollow base or quill, and the solid part supporting the barbs.—2. In *bot.* [See **SCAPE**.]—3. In *arch.*, the shaft of a column.

**SCAR**, *n.* [*Fr. escurre*; *Gr. σκαρα*; probably from the root of *shear*, *share*, to cut, Sax. *sciran*, *scearan*, whence Dan. *shaar*, a notch.] 1. A mark in the skin or flesh of an animal, made by a wound or an ulcer, and remaining after the wound or ulcer is healed. The soldier is proud of his *scars*.—2. Any mark or injury; a blemish.

The earth had the beauty of youth, and not a wrinkle, *scar*, or fracture on its body.

*Burnet.*

3. [*L. scarus*; *Gr. σκαρος*.] A fish of the Labrus kind. [See **SCARUS**.]—4 † A cliff; a naked detached rock; also written or pronounced *scaur*, in Scotland.

**SCAR**, *v. t.* To mark with a scar.

**SCARABÆIDÆ**, or **SCARABÆIDANS**, *n.* A very extensive group of beetles, forming the chief part of the section Lamellicornes, and having the genus *Scarabæus* of Linn. as its type. Latreille divides the *Scarabæida* into six sections; viz., Coprophagi, Arenicoli, Xilophili, Phyllophagi, Anthobii, and Melitophili. To the first section belong the dung-feeding *Scarabæi*, and the sacred beetle of the Egyptians.

**SCARABÆUS**, *n.* [*L. scarabæus*, from *Gr. σκαρος*, Sax. *scearn*, *finus*.] An extensive genus of coleopterous insects, placed by Linn. at the head of the insect tribes, and answering to the section Lamellicornes of Latreille. By the French entomologists of the present

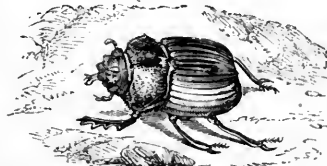

*Scarabæus sacer.*

day, as well as by some English writers, the name *Scarabæus* is still retained generically for the gigantic insects placed by Linn. at the head of the genus; such as the elephant and hercules beetles. [See **BETLE**.]

**SCARAMOUCHE**, *n.* [*Fr. escarmouche*; *Sp. escaramuza*, a skirmish.] A buffoon in motley dress. A personage, in Italian comedy, imported originally from Spain; whose character (or his part) was compounded of traits of vaunting and poltroonery. His costume was black, from top to toe; he wore a black *tuque* (kind of square-topped cap), a black mantle, and had on his face a mask, barred (*i. e.*, with openings) on the brow, the cheeks and the chin. The most celebrated *scaramouch* was one Tiberio Finelli, a Neapolitan, born in the year 1608.

**SCAR BROITE**, *n.* A mineral, a hydrated silicate of alumina, which occurs massive. Fracture conchoidal, easily scratched by the knife, and polished by the nail; adheres to the tongue, and has a strong earthy smell when breathed upon. Colour white, opaque, dull; streak shining. Sp. gr. 1.48. It occurs as veins in the beds of sandstone covering the calcareous rock near Scarborough.

**SCARCE**, *a.* [*It. scarso*; *D. schaarsch*. In *Arm.* *scarz* is short, and perhaps the word is from the root of *shear*, to cut. The Spanish equivalent word is *escaso*, and it is observable that some of our common people pronounce this word *scase*.] 1. Not plentiful or abundant; being in small quantity in proportion to the demand. We say, water is *scarce*, wheat, rye, barley is *scarce*, money is *scarce*, when the quantity is not fully adequate to the demand.—2. Being few in number and scattered; rare; uncommon. Good horses are *scarce*.

The *scarcest* of all is a Pescennius Niger on a medallion well preserved. *Addison.*

**SCARCE**, } *adv.* Hardly; scantily.  
**SCARCELY**, }

We *scarcely* think our miseries our foes. *Shak.*

2. Hardly; with difficulty.

Slowly he sails, and *scarcely* stems the tides. *Dryden.*

**SCARCEMENT**, *n.* A set-back in the building of walls, or in raising banks of earth; a footing.

**SCARCENESS**, } *n.* Smallness of quan-  
**SCARCITY**, } tity, or smallness in proportion to the wants or demands; deficiency; defect of plenty; penury; as, a *scarcity* of grain; a great *scarcity* of beauties; a *scarcity* of lovely women.

Praise, like gold and diamonds, owes its value to its *scarcity*. *Rambler.*

A *scarcity* of snow would raise a mutiny at Naples. *Addison.*

2. Rareness; infrequency.

The value of an advantage is enhanced by its *scarce*ness. *Collier.*

*Root of scarcity*, the mangel-wurzel, a variety of the Beta *Cyca* or white beet; *G. mangold-wurzel*, beet-root, corrupted into *mangel-wurzel*; *Fr. racine de disette*, root of want or scarcity.

**SCARE**, *v. t.* [*In W. esgar* is to separate; in *It. scorare* is to disliscarten, from *L. ex* and *cor*, heart; but *qu.*] To fright; to terrify suddenly; to strike with sudden terror.

The noise of thy cross-bow  
Will *scare* the herd, and so my shot is lost. *Shak.*

To *scare away*, to drive away by frightening.

**SCARE-CROW**, *n.* [*scare* and *crow*.]

Any frightful thing set up to frighten crows or other fowls from corn-fields; hence, any thing terrifying without danger; a vain terror.

A *scarecrow* set to frighten fools away.

*Dryden.*

2. A fowl of the sea gull kind; the black gull.

SCA'RED, *pp.* Frightened; suddenly terrified.

SCA'RE-FIRE, *† n.* A fire breaking out so as to frighten people.

SCA'RF, *n.* plur. *scarfs.* [Fr. *écharpe*; Sax. *scarf*, a fragment or piece; G. *scharpe*; from the root of *shear*.] 1. A sort of shawl; something that hangs loose upon the shoulders; as a piece of cloth.

Put on your hood and *scarf.* *Swift.*

2. A water-fowl.—3. In *her.*, a small ecclesiastical banner hanging down from the top of a crosier.

SCA'RF, *v. t.* To throw loosely on.—2. To dress in a loose vesture.

SCA'RF, *v. t.* [Sw. *skarfa*; Sp. *escarp.*] To join; to piece; to unite two pieces of timber at the ends, by letting the end of one into the end of the other and bolting them together, or



Scarf.

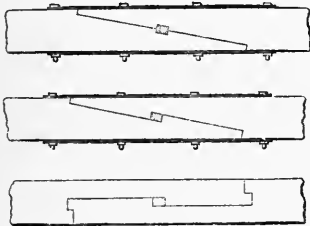

Various modes of Scarfing.

by laying the two ends together and fastening a third piece to both; but this latter method is usually termed *fitting*.

SCA'RFED, *pp.* Dressed in a loose vesture.—2. Joined; pieced.

SCA'RFING, *n.* In *joiner work*, a mode of joining two pieces of timber together end long, or of lengthening timber as it is called. It is performed by cutting away a part of the thickness of each piece of the length of the joint, but from opposite sides, so that when united they form a continuous piece of equal width and depth. The joint is secured by bolts and straps.

SCA'RF-SKIN, *n.* [*scarf* and *skin*.] The cuticle; the epidermis; the outer thin integument of the body.

SCARIFI'CA'TION, *n.* [L. *scarificatio*. See SCARIFY.] In *sur.*, the operation of making several incisions in the skin with a lancet or other cutting instrument, for the purpose of taking away blood, letting out fluids, &c.

SCARIFI'CA'TOR, *n.* An instrument used in scarification or cupping. It consists of ten or twelve lancets which are discharged through apertures in its plane surface by pulling a kind of trigger, so that in passing they make a number of incisions in the part to which the instrument is applied.

SCAR'IFIER, *n.* [from *scarify*.] The person who scarifies.—2. The instrument used for scarifying.—3. In *agriculture*, an implement with prongs employed for stirring the soil without reversing its surface or altering its form. Such implements are also called *scufflers*, *cultivators*, and *grubbers*.

SCAR'IFY, *v. t.* [Fr. *scarifier*; L. *scarifico*. Qu. *scar*, Gr. *σκαρ* and L. *facio*, to make. But the Greek is *σκαρίζουμαι*, from *σκαρίζω*, a pointed instrument, or a sharp pointed piece of wood.] To scratch or cut the skin of an animal, or to make small incisions by means of a lancet or cupping instrument, so as to draw blood from the smaller vessels without opening a large vein, or to let out fluids.

SCAR'IFYING, *ppr.* Making small incisions in the skin with an instrument.

SCARING, *ppr.* Frightening; suddenly terrifying.

SCA'RIOUS, SCA'RIOSE, *a.* [Low L. *scarrosus*, rough.] In *bot.*, tough, thin and semi-transparent, dry and sonorous to the touch; as a perianth.

SCARI'TIDÆ, *n.* A family of coleopterous insects belonging to the section Geodephaga, which section corresponds to the carabus and cicindela of Linn. They burrow into sand in the neighbourhood of the sea, or in the banks of streams. They are chiefly found in hot climes.

SCARLATI'NA, *n.* [It. *scarlattino* and *scarlato*, scarlet.] An exceedingly barbarous Italian term with a Latin termination, employed by many to designate that febrile exanthem, commonly called in English *scarlet fever*, and in nosology *rosalia*. It is characterized by fever, attended about the third day with an eruption of level or nearly level crimson red patches, first appearing in the fauces, and on the face, neck, and breasts, and progressively on the whole surface, often confluent and terminating about the seventh day, in cuticular exfoliations.

SCARLATINOUS, *a.* Of a scarlet colour; pertaining to the scarlet fever.

SCARLET, *n.* [Fr. *écarlate*; It. *scarlato*; Ir. *scarloid*; W. *ysgarlad*, the effusion of a wound, scarlet, from *ysgar*, to separate, [See SHEAR;] G. *scharlach*; Qu. Ch. *סקה*, *sakar*, to colour, as a derivative, minium; Ar. *shakara*, to be red.] 1. A beautiful bright red colour, brighter than crimson. The finest scarlet dye is obtained from cochineal. According to Berthollet the dyeing of scarlet is performed at two operations, the first is called the *boiling* (*bouillon*), and the second the reddening.—2. Cloth of a scarlet colour.

All her household are clothed with *scarlet*; Prov. xxxi.

SCARLET, *a.* Of the colour called scarlet; of a bright red colour; as, a *scarlet* cloth or thread; a *scarlet* lip.

SCARLET-BEAN, *n.* The *Phaseolus multiflorus*, a species of kidney-bean cultivated chiefly for the beauty of its scarlet flowers.

SCARLET-FE'VE'R, *n.* Rosalia. It seizes persons of all ages; but children and young persons are most subject to it, and it appears at all seasons of the year, but is most frequently met with towards the end of autumn or beginning of winter, at which time it often becomes a prevalent epidemic. It is highly contagious. [See SCARLATINA, above.]

SCARLET-OAK, *n.* A species of oak, the *Quercus coccifera*, or chermes oak, producing small insects, the *Coccus ilicis*, called *chermes* or *scarlet grain*. More properly, the *Quercus coccinea* of the United States.

SCARMOGE, *†* } peculiar modes of SCARMOGE, } spelling *Shirmish*.

SCARN, *n.* [Sax. *searn*.] Dung. [Not in use or local.]

SCARN-BEE, *n.* A beetle. [Not in use or local.]

SCARP, *n.* [Fr. *escarpe*; It. *scarpa*, a scarp, a shoe, a slope; Sp. *escarpa*.] In *fort.*, the interior talus or slope of the ditch next the place, at the foot of the rampart.

SCARP, or SCA'RPE, *n.* In *her.*, the scarf which military commanders wear for ornament; borne somewhat like a baton sinister, but broader, and continued to the edges of the field.



Scarpe and baton.

SCARPED, *a.* Cut down like the scarp

of a fortification.

SCAR RED, *pp.* Marked with a scar.

SCAR RING, *ppr.* Marking with a scar.

SCA'RUS, *n.* A genus of fishes of the family Labridæ. The species are remarkable for the structure of their jaws, which project, are convex in front and concave within, and present a sharp cutting edge. The body is of the same oblong oval form as in the wrasses, and the scales are very large.

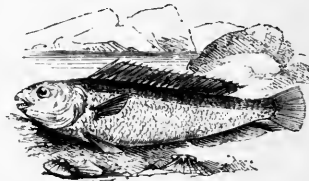

Scaurus creticus.

The Scari are inhabitants of the tropical seas, and from the brilliance of their colouring, combined with the peculiar form of their jaws, they have received the name of *parrot-fishes*. [See SCAR.]

SCAT, or SCAD, *n.* A brisk shower of rain, driven by the wind; and hence *scatty* or *scaddy*, showery. [Local.]

SCATCH, *n.* [Fr. *escache*.] A kind of horsebit for bridles.

SCATCH'ES, *n.* plur. [Fr. *échasses*.] Stilts to put the feet in for walking in dirty places.

SCATE, *n.* A kind of shoe furnished with a smooth iron for sliding on the ice. [See SKATE.]

SCATE, *n.* [Sax. *sceadda*; L. *squatina*, *squatul*.] A fish, a species of ray. [See SKATE.]

SCA'TEBROUS, *a.* [L. *scatebra*, a spring; *scateo*, to overflow.] Abounding with springs.

SCATH, *v. t.* [Sax. *scathian*, *scæthian*, to injure, to damage, to steal; G. *schaden*.] To damage; to waste; to destroy.

SCATH, *n.* Damage; injury; waste; harm. [In *Scotch*, spelt and pronounced *skath*.]

SCATH'ED, *pp.* Damaged; wasted; destroyed.

SCATH'FUL, *a.* Injurious; harmful; destructive.

SCATH'FULNESS, *n.* Injuriousness; destructiveness.

SCATH'ING, *ppr.* Injuring; destroying.

SCATH'LESS, *a.* Without waste or damage.

SCATTER, *v. t.* [Sax. *scateran*, to pour out, to disperse; *L. scateo*; *Gr. σκαταω*, to scatter, to discuss, *L. discutio*. This word may be formed on the root of *discutio*. The primary sense is to drive or throw.] 1. To disperse; to dissipate; to separate or remove things to a distance from each other.

From thence did the Lord scatter them abroad upon the face of all the earth; *Gen. xi.*

I will scatter you among the heathen; *Lev. xxvi.*

2. To throw loosely about; to sprinkle; as, to scatter seed in sowing.

Teach the glad hours to scatter, as they fly, Soft quiet, gentle love and endless joy. *Prior.*

3. To spread or set thinly.

Why should my muse enlarge on Libyan swains,

Their scatter'd cottages, and ample plains. *Dryden.*

SCATTER, *v. i.* To be dispersed or dissipated. The clouds scatter after a storm.—2. To be liberal to the poor; to be charitable; *Prov. xi.*

SCATTER-BRAIN, *n.* A giddy youth. [*Vulgar.*]

SCATTER-BRAINED, *a.* Giddy; heedless. [*Vulgar.*]

SCATTERED, *pp.* Dispersed; dissipated; thinly spread; sprinkled or thinly spread over.—2. In *bot.*, irregular in position; without any apparent regular order; as, scattered branches; scattered leaves.

SCATTEREDLY, *adv.* In a dispersed manner; separately. [*Not much used.*]

SCATTERING, *ppr.* Dispersing; spreading thinly; sprinkling.—2. *a.* Not united; divided among many; as, scattering votes.

SCATTERING, *n.* The act of dispersing; that which is dispersed.

SCATTERINGLY, *adv.* Loosely; in a dispersed manner; thinly; as, habitations scatteringly placed over the country.

SCATTERINGS, *n. plur.* Things scattered.

SCATTERLING, *n.* A vagabond; one that has no fixed habitation or residence. [*Little used.*]

SCATUR'ENT, † *a.* [*L. scaturiens.*]

Springing, as the water of a fountain.

SCATURIG'INOUS, † *a.* [*L. scaturigo.*]

Abounding with springs.

SCAUP, *n.* A species of duck, *Fuligula marila*, Selby. It is common in North America and the north of Europe; and is found in considerable numbers on our own coasts during the winter months. It feeds on small fish, molluscs, and hence its flesh is coarse. According to Willoughby, the name Scaup is derived from the bird feeding among broken shells, which are called scaup in the north of England.

SCAUV'AGE, *n.* [Sax. *scaevian*, to show.] In ancient customs, a toll or duty exacted of merchant-strangers by mayors, sheriffs, &c. for goods shown or offered for sale within their precincts.

SCAUV'ENGER, *n.* [Sax. *scafan*, to scrape, to shave, *G. schaben*, *L. scabio*.] 1. Originally a petty officer whose duty was to see that the streets were clean.—2. A person whose employment is to clean the streets of a city, by scraping or sweeping and carrying off the filth.

SCELERAT, † *n.* [Fr. from *L. sceleratus*.] A villain; a criminal.

SCENA, *n.* [*L.*] The permanent architectural front which faced the audience in the ancient theatre.

SCENE, *n.* [Fr. *id*; *L. scena*; *Gr. σκηνη*; *Heb. שכן, shakan*, to dwell; *Ch.* to subside, to settle; *Syr.* to come or fall on; *Ar. sakana*, to be firm, stable, quiet, to set or establish, to quiet or cause to rest. The *Gr.* word signifies a tent, hut or cottage. In *L.* it is an arbor or stage. The primary sense is to set or throw down.] 1. A stage; the theatre or place where dramatic pieces and other shows are exhibited. It does not appear that the ancients changed the scenes in different parts of the play. Indeed the original scene for acting was an open plat of ground, shaded or slightly covered.—2. The whole series of actions and events connected and exhibited; or the whole assemblage of objects displayed at one view. Thus we say, the execution of a malefactor is a melancholy scene. The crucifixion of our Saviour was the most solemn scene ever presented to the view of man. We say also, a scene of sorrow or of rejoicing, a noble scene, a sylvan scene. A charming scene of nature is displayed. *Dryden.*

3. A part of a play; a division of an act. A play is divided into acts, and acts are divided into scenes. In the English stage, the subdivision called a scene is extremely arbitrary; the scenes in most plays being far more numerous than the actual changes of scene. In the French stage every entry of an actor constitutes a new scene.—4. So much of an act of a play as represents what passes between the same persons in the same place.—5. The imaginary place in which the action of the play is supposed to pass. The scene was laid in the king's palace.—6. The curtain or hanging of a theatre adapted to the play.—7. The place where anything is exhibited.

The world is a vast scene of strife.

*J. M. Mason.*

8. An exhibition of strong feeling between two or more persons, usually of a pathetic or passionate kind, such as is represented in a drama or depicted in a romance. In real life, the term is used contemptuously or ironically; as, in the injunction, do not get up a scene.—9. Any remarkable exhibition.

The shepherds, while watching their flocks upon the plains of Bethlehem, were suddenly interrupted by one of the most sublime and surprising scenes which have ever been exhibited on earth.

*W. B. Sprague.*  
10. A large painted view generally.—*Scene painting*, a department of the art of painting governed by the laws of perspective, applied to the peculiar exigencies of a theatre. It is conducted chiefly in water-colours, and admits of the most striking effects.

SCENE, † *v. t.* To exhibit.

SCENERY, *n.* The appearance of a place, or of the various objects presented to view; or the various objects themselves as seen together. Thus we may say, the scenery on the banks of the Thames at Richmond is diversified and pleasing; or the landscape scenery presented to the view from the Malvern hills is picturesque and varied. [*See LANDSCAPE.*] 2. The representation of the place in which an action is performed.—3. The dispo-

sition and consecution of the scenes of a play.—4. The paintings representing the scenery of a play.

SCEN'IC, } *a.* [*L. scenicus.*] PERS-  
SCEN'ICAL, } taining to scenery; dramatic; theatrical.

SCENOGRAPH'IC, } *a.* [*See SCEN-*  
SCENOGRAPH'ICAL, } *OGRAPHY.*] Pertaining to scenography; drawn in perspective.

SCENOGRAPH'ICALLY, *adv.* In perspective.

SCENOGR'APHY, *n.* [*Gr. σκηνη*, scene, and *γραφω*, to describe.] The representation of a body on a perspective plane; or a description of it in all its dimensions as it appears to the eye. It stands opposed to *ichnography* and *orthography*.

SCENT, *n.* [*Fr. senteur*, from *sentir*, *L. sentio*, to perceive.] 1. Odour; smell; that substance which, issuing from a body, affects the olfactory organs of animals; as, the scent of an orange or an apple; the scent of musk. The word is applicable to any odour, agreeable or offensive.—2. The power of smelling; the smell; as, a hound of nice scent.—3. Chase followed by the scent; course of pursuit; track.

He travelled upon the same scent into Ethiopia. *Temple.*

SCENT, *v. t.* To smell; to perceive by the olfactory organs; as, to scent game, as a hound.—2. To perfume; to imbue or fill with odour, good or bad. Aromatic plants scent the room. Some persons scent garments with musk; others scent their snuff.

SCENT'ED, *pp.* Smelt; perceived by the olfactory organs.—2. Perfumed; imbued with odour.

SCENT'FUL, *a.* Odorous; yielding much smell.—2. Of quick smell.

SCENT'ING, *ppr.* Smelling; perceiving by the olfactory organs.—2. Perfuming; filling with odour.

SCENT'LESS, *a.* Inodorous; destitute of smell.

SCEPTRE, *n.* [*Fr. sceptre*; *L. sceptrum*; *Gr. σκεπτεριον*, from *σκηπτω*, to send or thrust; coinciding with *L. scipio*, that is, a shoot or rod.] 1. A staff or baton borne by kings on solemn occasions, as a badge of authority. Hence.—2. The appropriate ensign of royalty; an ensign of higher antiquity than the crown. Hence.—3. Royal power or authority; as, to assume the sceptre.

The sceptre shall not depart from Judah, nor a lawgiver from between his feet, till Shiloh come; *Gen. xlix.*

4. A constellation.

SCEPTRE, *v. t.* To invest with royal authority, or with the ensign of authority.

SCEPTRED, *a.* Bearing a sceptre; as, a sceptred prince.

To Britain's queen the sceptred suppliant bends. *Tickle.*

Gold-sceptred Juno. *Parnell.*

SCEPTRELESS, *a.* Having no sceptre.

SCEPT'IC, *n.* [*Gr. σκεπτικος*, from *σκηπτωμαι*, to look about, to consider, to speculate; *Sax. sceawian*, to look about, to see, also to show. *See SNOW.*] 1. One who doubts the truth and reality of any principle or system of principles or doctrines. In *philosophy*, a Pyrrhonist or follower of Pyrrho, the founder of a sect of sceptical philosophers, who maintained that no certain inferences can be drawn from the reports of the senses, and who therefore doubted of every thing.—2. In *theol.*,

a person who doubts the existence and perfections of God, or the truth of revelation; one who disbelieves the divine original of the Christian religion.

Suffer not your faith to be shaken by the sophistries of sceptics. *Clarke.*

**SCEPTIC**, } *a.* Doubting; hesitat-  
**SCEPTICAL**, } ing to admit the certainty of doctrines or principles; doubting of every thing.—2. Doubting or denying the truth of revelation.

The sceptical system subverts the whole foundation of morals. *Rob. Hall.*

**SCEPTICALLY**, *adv.* With doubt; in a doubting manner.

**SCEPTICALNESS**, *n.* Doubt; profession of doubt.

**SCEPTICISM**, *n.* [Fr. *scepticisme.*] The doctrines and opinions of the Pyrrhonists or sceptical philosophers; universal doubt; the scheme of philosophy which denies the certainty of any knowledge respecting the phenomena of nature. Or *scepticism* is that tendency of thought, or system of doctrine, the object of which is, by denying the existence of all grounds of knowledge, to introduce universal doubt and suspension of assent. The most celebrated sceptics of modern times, are Montaigne, Glanville, Boyle, and Hume.—2. In *theol.*, a doubting of the truth of revelation, or a denial of the divine origin of the Christian religion, or of the being, perfections, or truth of God.

Irreligious scepticism or atheistic profaneness. *Milner.*

Let no despondency or timidity or secret scepticism lead any one to doubt whether this blessed prospect will be realized.

*S. Miller.*

**SCEPTICIZE**, *v. i.* To doubt; to pretend to doubt of every thing. [*Lit. us.*]

**SCHA'ALSTEIN**, } *n.* A rare mineral,  
**SCALE-STONE**, } called also tafel-spath and tabular spar, occurring in masses composed of thin laminae collected into large prismatic concretions or hexahedral prisms. Its colour is grayish or pearly white, tinged with green, yellow, or red. It has been found chiefly at Rodnatska in the Banat.

**SCHÉDIASM**, *n.* [Gr. *σχιδιασμα.*]

Cursory writing on a loose sheet.

**SCHED'ULE**, *n.* (shed'ule.) [L. *schedula*, from *scheda*, a sheet or leaf of paper; Gr. *σχίζω*, from *σχίζω*, to cut or divide; L. *scindo*, for *scido*. The pronunciation ought to follow the analogy of *scheme*, &c.] 1. A small scroll or piece of paper or parchment, containing some writing.—2. A piece of paper or parchment annexed to a larger writing, as to a will, a deed, a lease, &c.—3. A piece of paper or parchment containing an inventory of goods.

**SCHÉE'LE'S GREEN**, *n.* A green pigment. It is an arsenite of copper, and was first prepared by Scheele.

**SCHÉE'LIN**, or **SCHÉE'TIUM**, *n.* [So called from Scheele, a distinguished chemist.] A different name of tungsten, a hard brittle metal of a grayish white colour, and brilliant.

**SCHÉE'R'ERITE**, or **SHE'R'ERITE**, *n.* A newly discovered mineral species of a combustible nature, found in a bed of brown coal near St. Gall in Switzerland. It seems to be a mineral naphthaline.

**SCHEIK**, *n.* Among Arabians, an old man; hence, a chief. [See **SHIEK**.]

**SCHEL'TOPUSIK**, or **SHEL'TOPUSIK**, *n.* A genus of reptiles placed among the Saurians. The only species known is *Le Bipède Shellopusih* of Lacepede and others, found in Siberia, Greece, the whole of the continent of Europe to the south, and the Mediterranean coasts of Africa. It haunts thick herbage and grassy places.

**SCHE'MATISM**, *n.* [Gr. *σχηματισμος*, from *σχημα*. See **SCHEME**.] 1. Combination of the aspects of heavenly bodies.—2. Particular form or disposition of a thing. [*A word not much used.*]

**SCHE'MATIST**, *n.* A projector; one given to forming schemes. [*Schemer* is more generally used.]

**SCHE'MATIZE**, *v. t.* To form a scheme or schemes.

**SCHEME**, *n.* [L. *schemata*; Gr. *σχημα*, from *σχίζω*, a contracted word, probably from *σχίζω*, to have or hold.] 1. A plan; a combination of things connected and adjusted by design; a system.

We shall never be able to give ourselves a satisfactory account of the divine conduct, without forming such a *scheme* of things as shall take in time and eternity. *Atterbury.* 2. A project; a contrivance; a plan of something to be done; a design. Thus we say, to form a *scheme*, to lay a *scheme*, to contrive a *scheme*.

The stoical *scheme* of supplying our wants by lopping off our desires, is like cutting off our feet when we want shoes. *Swift.* 3. In *astrol.*, a representation of the aspects of the celestial bodies; an astrological figure of the heavens.—*Scheme of division*, in *Scots judicial procedure*, the state or cast according to which it is proposed to divide a common fund amongst the several claimants thereon, or to allocate any fund or burden on the different parties liable.—4. The representation of any design or geometrical figure by lines so as to make it comprehensible; a diagram.

**SCHEME**, *v. t.* To plan; to contrive.

**SCHEME**, *v. i.* To form a plan; to contrive.

**SCHE'ME ARCH**, or **SKÈNE ARCH**, *n.* An arch which is a segment of a circle.

**SCHÉMER**, *n.* One that contrives; a projector; a contriver.

**SCHÉMING**, *ppr.* Planning; contriving. 2. *a.* Given to forming schemes; artful; intriguing.

**SCHÉMING**, *n.* The act of forming a plan.

**SCHÉMINGLY**, *adv.* By scheming or contriving.

**SCHÉMIST**, *n.* A schemer; a projector.

**SCHÈNE**, *n.* [L. *schanos*; Gr. *σχωνος*.] An Egyptian measure of length, equal to sixty stadia, or about 7½ miles.

**SCHÉ'RIF**, *n.* [Arab. lord or master.] A title given in the East to those who descend from Mahomet, through his son-in-law Ali, and daughter Fatima.

The chiefs of Mecca and of Medina are styled the sherifs of those cities.

**SCHER'ZO**, [It.] In *music*, a term generally applied to a passage of a sportive character in musical pieces of some length; as in symphonies, quartettos, &c.

**SCHÉ'SIS**, *n.* [Gr. *σχίσσις*, from *σχίζω*, *σχίζω*, to have or hold.] Habitude; general state or disposition of the body or mind, or of one thing with regard to other things.—2. In *rhetoric*, a statement of what is considered to be the adversary's habitude of mind, by way of argument against him.

**SCHEUCHZERIA**, *n.* A genus of plants, belonging to the nat. order Juncaginaceae. *S. palustris* is a British perennial, growing in wet spongy mountain bogs.

**SCHIEF'ER SPAR**. Foliated carbonate of lime, a mineral which occurs massive. The structure is laminar, generally curved, wavy, or undulating. Colour white, reddish, yellowish, or greenish. It is almost entirely soluble in acids with effervescence. It occurs in Cornwall, Scotland, and Ireland.

**SCHIL'LER SPAR**, *n.* A genus of spars comprising four varieties, namely, common schiller spar, bronzite, hypserthene, and apophyllite. It is of a pearly lustre, and changeable hues.

**SCHI'NUS**, *n.* A genus of plants belonging to the nat. order Anacardiaceae. The species inhabit tropical America. The leaves of some species are so filled with a resinous fluid, that the least degree of unusual reption of the tissue causes it to be discharged; thus, some of them fill the air with fragrance after rain.

**SCHIRRUS**. See **SCIRRHUS**.

**SCHISM**, *n.* (sizm.) [L. *schisma*; Gr. *σχίσμα*, from *σχίζω*, to divide, L. *scindo*, Sax. *scædan*, G. *scheiden*, to separate, to part.] 1. In a *general sense*, division or separation; but appropriately, a division or separation in a church or denomination of Christians, occasioned by diversity of opinions; breach of unity among people of the same religious faith.

Set bounds to our passions by reason, to our errors by truth, and to our schisms by charity. *K. Charles.*

In *Scripture*, the word seems to denote a breach of charity, rather than a difference of doctrine.—2. Separation; division among tribes or classes of people.

**SCHIS'MA**, *n.* [Gr. *σχίσμα*.] In *music*, an interval equal to half a comma; therefore eighteen of them are required to make a complete tone.

**SCHISMAT'IC**, } *a.* (sizam'tic, siz-  
**SCHISMAT'ICAL**, } mat'ical.) Pertaining to schism; implying schism; partaking of the nature of schism; tending to schism; as, *schismatical* opinions or proposals.

**SCHISMAT'IC**, *n.* One who separates from an established church or religious faith, on account of a diversity of opinions.

**SCHISMAT'ICALLY**, *adv.* In a schismatical manner; by separation from a church on account of a diversity of opinions.

**SCHISMAT'ICALNESS**, *n.* The state of being schismatical.

**SCHIS'MATIZE**, *v. i.* To commit or practice schism; to make a breach of communion in the church.

**SCHISM'LESS**, *a.* Free from schism; not affected by schism. [*Little used.*]

**SCHIST**, } *n.* [Gr. *σχίστος*, from *σχίζω*,  
**SCHIST'US**, } to split, to cleave.]

A geological term adopted from the German, and applied to the varieties of slate, or those rocks which are of a fissile character, or which may easily be split.

**SCHIST'IC**, } *a.* Slaty; fissile.—  
**SCHIST'OSE**, } *Schistose rocks*, those  
**SCHIST'OUS**, } which have a slaty texture.—*Schistose mica*, mica slate.

**SCHIZAN'DRA**, *n.* A genus of plants belonging to the nat. order Anonaceae. *S. coccinea*, the scarlet schizandra, is one of our most beautiful green-house



climbers. It is a North American plant, and is found in woods in Georgia, Florida, and Carolina.

**SCHIZANTHUS**, *n.* A genus of plants, nat. order Scrophulariaceæ. The species are fine flowering annuals, bearing diandrous flowers. They are natives of Peru.

**SCHIZOP'ODA**. Latreille's name for a division of macrurus crustaceans, or cleft-footed malacostraca. The opossum shrimps are examples.

**SCHÆ'NUS**, *n.* A genus of bog plants, nat. order Cyperaceæ, or the sedge tribe. The species are natives of Europe and Australia. They are useful for making bands for tying up goods. *S. nigricans*, black bog-rust, is a British plant, growing in bogs and wet moors.

**SCHNEIDER'IAN MEMBRANE**, *n.* In anat., the living membrane of the nostrils; so named from Schneider, who first described it.

**SCHOLA**, *n.* [L.] In ancient arch., the margin or platform which surrounded the bath. Also a portico corresponding to the exedra of the Greek palaestra, intended for the accommodation of the learned, who assembled there to converse.

**SCHOL'AR**, *n.* [Low L. *scholaris*, from *schola*, a school; Gr. *σχολη*, leisure, a school; Fr. *ecolier*; G. *schüler*; Dan. *skolelærd*. The Danish word signifies *school-learned*. See **SCHOOL**.] 1. One who learns of a teacher; one who is under the tuition of a preceptor; a pupil; a disciple; hence, any member of a college, academy, or school; applicable to the learner of any art, science, or branch of literature.—2. A man of letters.—3. *Emphatically used*, a man eminent for erudition; a person of high attainments in science or literature.—4. One that learns any thing; as, an apt *scholar* in the school of vice.—5. A pedant; a man of books. [But the word *scholar* seldom conveys the idea of a pedant.]—6. A person, in English universities, who belongs to the foundation of a college, and receives a portion of its revenues to furnish him with the means of prosecuting his studies during the academic curriculum.

**SCHOLAR'ITY**, *† n.* Scholarship.  
**SCHOL'AR-LIKE**, } *a.* Like a scholar;  
**SCHOL'ARLY**, } becoming a scholar.

**SCHOL'ARSHIP**, *n.* Learning; attainments in science or literature; as, a man of great *scholarship*.—2. Literary education. [*Unusual*.]

This place should be school and university, not needing a remove to any other house of *scholarship*. Milton.

3. Exhibition or maintenance for a scholar; foundation for the support of a student.

A *scholarship* not half maintains, And college rules are heavy chains. Warton.

[See **BURSARY**.]  
**SCHOLAS'TIC**, } *a.* [L. *scholasticus*,  
**SCHOLAS'TICAL**, } *cus*.] 1. Pertaining to a scholar, to a school, or to schools, particularly to the schools of the middle ages; as, *scholastic* manners or pride; *scholastic* learning.—2. Scholar-like; becoming a scholar; suitable to schools; as, *scholastic* precision.—3. Pedantic; formal; needlessly subtle.—*Scholastic philosophy*, the method of philosophizing which arose in the schools and universities of what are commonly termed the dark ages. The father of this system was

John Scotus Erigena, a native of Ireland, who lived in the ninth century. He combined the philosophy of Aristotle with the doctrines of the new Platonists. This system, which consisted in logical rules and metaphysical notions, formed what was termed the *dialectics* of the scholastics. These were combined with theology, and prevailed till about the conclusion of the 14th century.—*Scholastic divinity*, that species of divinity taught in some schools or colleges, which consists in discussing and settling points by reason and argument. It has now fallen into contempt, except in some universities, where the charters require it to be taught. [See **SCHOOL**.]

**SCHOLAS'TIC**, *n.* One who adheres to the method or subtleties of the schools.  
**SCHOLAS'TICALLY**, *adv.* In the manner of schools; according to the niceties or method of the schools.

**SCHOLAS'TICISM**, *n.* The method or subtleties of the schools.

The spirit of the old *scholasticism*, which spurned laborious investigation and slow induction. J. P. Smith.

**SCHO'LIAS'T**, *n.* [Gr. *σχολιαστικος*. See **SCHOLIUM**.] A commentator or annotator; one who writes notes upon the works of another for illustrating his writings.

**SCHOLIAS'TIC**, *a.* That pertains to a scholiast or his pursuits.

**SCHO'LIAZE**, *† v. i.* To write notes on an author's works.

**SCHO'LIICAL**, *† a.* Scholastic.

**SCHO'LIIUM**, *n. plur.* (scholia, or scholiums.) [L. *scholion*; Gr. *σχολιον*, from *σχολη*, leisure, lucubration.] A note, annotation, or remark, occasionally made on some passage, proposition, or the like.—2. In *geom.* and *phys.*, an explanatory or exursive remark on the nature and application of a train of reasoning. After demonstrating a proposition, a scholium is sometimes added, pointing out how it might be done some other way, or giving some advice or precaution in order to prevent mistakes, or adding some particular use or application of the proposition. The plural *scholia*, is used to signify explanations annexed to Greek and Latin authors, by the early grammarians, who taught the practical part of philology.

**SCHO'LY**, *† n.* A scholium.

**SCHO'LY**, *† v. i.* To write comments.

**SCHOOL**, *n.* [L. *schola*; Gr. *σχολη*, leisure, vacation from business, lucubration at leisure, a place where leisure is enjoyed, a school. The adverb signifies at ease, leisurely, slowly, hardly, with labour or difficulty. In Sax. *secol* is a crowd, a multitude, a school, [shoal,] as of fishes, and a school for instruction. So also *scol*, *scolu*, a school; but the latter sense, we think, must have been derived from the Latin. D. *school*, an academy and a crowd; *schoolen*, to flock together; G. *schule*, a school for instruction; W. *ysgol*; Fr. *ecole*. This word seems originally to have denoted leisure, freedom from business, a time given to sports, games, or exercises, and afterward time given to literary studies. The sense of a crowd, collection, or shoal, seems to be derivative.] 1. A place or house in which persons are instructed in arts, science, languages, or any species of learning; or the pupils assembled for instruction. In common usage, *school* frequently denotes the collective body

of pupils in any place of instruction, and under the direction and discipline of one or more teachers. Thus we say, a *school* consists of fifty pupils. The preceptor has a large *school*, or a small *school*. His discipline keeps the *school* well regulated and quiet.—2. The instruction or exercises of a collection of pupils or students, or the collective body of pupils while engaged in their studies. Thus we say, the *school* begins or opens at eight o'clock, that is, the pupils at that hour begin their studies. So we say, the teacher is now in *school*, the *school* hours are from nine to twelve, and from two to five.—3. The state of instruction.

Set him betimes to *school*. Dryden.  
4. A place of education, or collection of pupils, of any kind; as, the *schools* of the prophets. In modern usage, the word *school* comprehends every place of education, as university, college, academy, common or primary schools, dancing-schools, riding-schools, &c.; but ordinarily the word is applied to seminaries inferior to universities and colleges.

What is the great community of Christians, but one of the innumerable *schools* in the vast plan, which God has instituted for the education of various intelligences?

Buckminster.  
5. Separate denomination or sect; or a system of doctrine taught by particular teachers, or peculiar to any denomination of Christians or philosophers.

Let no man be less confident in his faith .. by reason of any difference in the several *schools* of Christians. Taylor.

Thus we say, the Socratic *school*, the Platonic *school*, the Peripatetic or Ionic *school*; by which we understand all those who adopted and adhered to a particular system of opinions.—6. The seminaries for teaching logic, metaphysics, and theology, which were formed in the middle ages, and which were characterized by academical disputations and subtleties of reasoning; or the learned men who were engaged in discussing nice points in metaphysics or theology.

The supreme authority of Aristotle in the *schools* of theology as well as of philosophy.

Henry.  
Hence, *school divinity* is the divinity which discusses nice points, and proves every thing by argument.—7. Any place of improvement or learning. The world is an excellent *school* to wise men, but a *school* of vice to fools.—*Primary school*, a school for instructing children in the first rudiments of language and literature.—*Normal schools*,—see **NORMAL**.—*Public schools*, a name of not very definite application, by which a certain number of schools in England are designated, such as Eton, Winchester, and Westminster, Harrow, Rugby, Shrewsbury, &c. They are such as confer a classical education, have, on the average, a larger number of boys, and are frequented by the children of persons of rank and wealth.—*Free schools*, such as afford a gratuitous, or nearly gratuitous education to the children of the place, from whatever source the funds may be derived.—*Endowed schools*, those of which the funds arise out of royal, public, or private endowment.—*Parochial schools*, in Scotland, those schools which are established in the different parishes for the purpose of furnishing a cheap elementary education for the mass of the

people.—*Common school*, the name in the *U. States* for a primary or elementary school, supported by a general rate.—8. Formerly, a shoal or compact body; as, a *school of fishes*: spelt, also, *scull*. [*In this sense, still used in America.*]

**SCHOOL**, *v. t.* To instruct; to train; to educate.

He's gentle, never *school'd*, yet learn'd.

*Shak.*

2. To teach with superiority; to tutor; to chide and admonish; to reprove.

*School your child,*

And ask why God's anointed he leaved.

*Dryden.*

**SCHOOL'-BOY**, *n.* [*See BOY.*] A boy belonging to a school, or one who is learning rudiments.

**SCHOOL'-DAME**, *n.* [*See DAME.*] The female teacher of a school.

**SCHOOL'-DAY**, *n.* [*See DAY.*] The age in which youth are sent to school.

**SCHOOL'-DISTRICT**, *n.* In the *U. States*, a division of a town or city for establishing and conducting schools.

**SCHOOL'ED**, *pp.* Instructed; trained; tutored; reprov'd.

**SCHOOL'ERY**, *n.* Something taught; precepts.

**SCHOOL'-FELLOW**, *n.* [*See FELLOW.*] One bred at the same school; an associate in school.

**SCHOOL'-GIRL**, *n.* Feminine of school-boy.

**SCHOOL'-HOUSE**, *n.* [*See HOUSE.*] A house appropriated for the use of schools, or for instruction; but applied only to buildings for subordinate schools, not to colleges.

**SCHOOL'ING**, *ppr.* Instructing; teaching; reprov'g.

**SCHOOL'ING**, *n.* Instruction in school; tuition.—2. Compensation for instruction; price or reward paid to an instructor for teaching pupils.—3. Re-proof; reprimand. He gave his son a good *schooling*.

**SCHOOL'MAID**, *n.* [*See MAID.*] A girl at school.

**SCHOOL'MAN**, *n.* [*See MAN.*] A man versed in the niceties of academical disputation, or of school divinity. The *schoolmen* were philosophers and divines of the middle ages who adopted the principles of Aristotle, and spent much time on points of nice and abstract speculation. They were so called because they taught in the *schools* of divinity established by Charlemagne. Unlearn'd, he knew no *schoolman's* subtle art. *Pope.*

2. A writer of scholastic divinity or philosophy.

Let subtle *schoolmen* teach these friends to fight. *Pope.*

**SCHOOL'MASTER**, *n.* [*See MASTER.*] The man who presides over and teaches a school; a teacher, instructor, or preceptor of a school. [*Applied now only or chiefly to the teachers of primary or elementary schools.*]

Adrian VI. was sometime *schoolmaster* to Charles V. *Knolles.*

2. He or that which disciplines, instructs, and leads.

The law was our *schoolmaster* to bring us to Christ; Gal. iii.

**SCHOOL'MATE**, *n.* One of either sex who attends the same school.

**SCHOOL'MISTRESS**, *n.* [*See MISTRESS.*] A woman who governs and teaches a school.

**SCHOOL'TEACHER**, *n.* One who gives regular instruction in a school.

**SCHOOL'TEACHING**, *n.* The business of instruction in a school.

**SCHOON'ER**, *n.* [*G. schooner.*] A vessel with two masts, whose main-sail and fore-sail are suspended by gaffs, like a sloop's main-sail, and stretched below



Schooner.

by booms. The schooner differs from the brig, chiefly in the rig of the main-mast; that of the schooner having only fore and aft sails, while that of the brig has square topsails.

**SCHORL**, or **SHORL**, *n.* [*Swed. scorl, brittle.*] A mineral usually occurring in black prismatic crystals. It is brittle, and has much lustre, and becomes electric by heat and friction. It is a variety of tourmaline.

**SCHOR'LITE**, or **SHOR'LITE**, *n.* The pyenite of Haiy and Brongniart.

**SCHOR'LOUS**, } *a.* Pertaining to  
**SCHORLA'CEOUS**, } schorl; possess-

ing the properties of schorl.  
**SCHUIT**, or **SCHUYT**, *n.* [*Dutch.*] The Dutch name for a boat; hence, also, *trehschuit*, a track-boat.

**SCIÆNOIDES**, *n.* The third of the families into which Cuvier divides the spinous finned fishes, the type of which is the genus *Sciæna*. It is closely related to the Percoides, but both the vomer and palatines are without teeth, the bones of the cranium and face are generally cavernous, and form a muzzle more or less gibbous.



Sciæna aquila.

These fishes are abundant in the Mediterranean and in the warmer parts of the Atlantic, where they are amongst the most valuable fishes for the table.

**SCIAGRAPHICAL**, *a.* Pertaining to sciagraphy.

**SCIAG'RAPHY**, *n.* [*Gr. σκιαγραφία: σκιά, a shadow, and γραφω, to describe.*] 1. The art of sketching or delineating.—2. In *arch.*, the profile or section of a building to exhibit its interior structure.—3. In *astron.*, the art of finding the hour of the day or night by the shadows of objects, caused by the sun, moon, or stars; the art of dialling.

**SCIATHER'IC**, } *a.* [*Gr. σκιά, a shadow, and θρα, a catching.*] Belonging to a sun-dial.  
**SCIATHER'ICAL**, }

[*Little used.*]  
**SCIATHER'ICALLY**, *adv.* After the manner of a sun-dial.

**SCIAT'IC**, } *n.* [*L. sciatica, from Gr. σκιά, a pain in the hips, from σκίζω, the hip,*

from *σχις*, the loin.] A peculiar and specific painful affection, principally seated in the sciatic nerve, which, if protracted, produces emaciation of the limb affected, with weakness, and a more or less permanent flexion. If it is not a true neuralgia, it is nearly allied to it.

**SCIATIC**, } *a.* Pertaining to the  
**SCIAT'ICAL**, } hip; as, the *sciatic* artery or nerve.—2. Affecting the hip; as, *sciatic* pains.—*Sciatic stay*, in merchant ships, a strong rope fixed from the main to the fore-mast head. When loading or unloading, it serves to sustain a tackle.

**SCIENCE**, *n.* [*Fr. from L. scientia, from scio, to know. Scio is probably a contracted word.*] 1. In a general sense, knowledge, or certain knowledge; the knowledge of many methodically digested and arranged so as to become attainable by one; the comprehension or understanding of truth or facts by the mind. The *science* of God must be perfect.—2. In *philosophy*, a collection of the general principles or leading truths relating to any subject. *Pure science*, as the mathematics, is built on self-evident truths; but the term *science* is also applied to other subjects founded on generally acknowledged truths, as *metaphysics*; or on experiment and observation, as *chemistry* and *natural philosophy*; or even to an assemblage of the general principles of an art, as the science of *agriculture*; the science of *navigation*. The knowledge of reasons and their conclusions, constitute *abstract science*; that of causes and effects, and of the laws of nature, *natural* or *physical science*. The term *science* is often used to signify that which we know inductively, or by the experience of particulars, from which we ascend to general conclusions not necessarily constituted by those particulars, yet warranted by previous experience and by analogies widely observed. This signification of the term is applicable to *physical, moral, and practical science*.—*Physical* or *natural science* is that which is susceptible of experiment, and is therefore said to be founded on experimental evidence.—*Moral science*, is that which, lying in great part beyond the reach of experiment, rests for its certainty on aggregated facts, supported by concurrent testimony, by experience, and by analogy, so as to leave no room for doubt, though not demonstrable.—*Practical science*, is that which consists of general observations arising out of experience, and is otherwise called *theory* in correlation to an art or practice belonging to it. The term *science*, however, is more particularly used in contradistinction to *art* and *literature*. As distinguished from the former, a *science* is a body of truths, the common principles of which are supposed to be known and separated, so that the individual truths, even though some or all may be clear in themselves, have a guarantee that they could have been discovered and known either with certainty, or with such probability as the subject admits of, by other means than their own evidence. [*See ART.*] As distinguished from *literature*, *science* is applied to any branch of knowledge which is made the subject of investigation with a view to discover and apply first principles. [*See LITERATURE.*]

A principle in *science* is a rule in art. *Playfair.*

3. Art derived from precepts or built on principles.

*Science* perfects genius. *Dryden.*

4. Any art or species of knowledge. No *science* doth make known the first principles on which it buildeth. *Hooker.*

5. One of the seven liberal branches of knowledge, viz., grammar, logic, rhetoric, arithmetic, geometry, astronomy, and music.

*Note.*—Authors have not always been careful to use the terms *art* and *science* with due discrimination and precision. Music is an *art* as well as a *science*. In general, an *art* is that which depends on practice or performance, and *science* that which depends on abstract or speculative principles. The *theory* of music is a *science*; the *practice* of it an *art*.

SCIENT, † *a.* [*L. sciens*.] Skilful.

SCIENTIAL, *a.* Producing science.

SCIENTIFIC, } *a.* [*Fr. scientifique*;  
SCIENTIFICAL, } *L. scientia* and  
*facio*, to make.] 1. Producing certain knowledge or demonstration; as, *scientific* evidence.—2. According to the rules or principles of science; as, a *scientific* arrangement of fossils.—3. Well versed in science; as, a *scientific* physician.

SCIENTIFICALLY, *adv.* In such a manner as to produce knowledge.

It is easier to believe, than to be *scientifically* instructed. *Locke.*

2. According to the rules or principles of science.

SCILICET. [*Latin* particule.] To wit; viz.; namely.

SCILLA, *n.* A genus of bulbous stemmed plants mostly natives of Europe, belonging to the nat. order Liliaceæ. The *S. maritima*, sea onion or squill, is a plant common on the sandy shores of the Mediterranean, Portugal, and the Levant. The official part is the bulb, of which there are two varieties; the one large and whitish externally; and the other smaller, and of a brownish-red colour. It abounds in an acrid mucilaginous juice, with an alliaceous odour, and a bitter acrid nauseous taste. It is a valuable medicine, and acts either as an emetic, purgative, or expectorant and diuretic, in proportion to the dose in which it is given. It is a popular or domestic medicine in colds and coughs. *Scilla verna, bifolia*, and *autumnalis* are British species.

SCILLITINE, *n.* The bitter principle of the squill, or the bulb of the *Scilla maritima*, to which its medical properties, if an expectorant and diuretic, are referrible. It is a brittle mass of a nauseous bitter taste, and said to be poisonous.

SCIMITAR, *n.* [*Fr. cimette*.] A short sword with a convex edge or recurved point, used by the Persians and Turks. [This word is variously written. See CIMETER.]

SINCOIDES, SCINCOIDIAN, or SCINCOIDÆ, *n.* A family of saurian reptiles, of which the genus *scincus*, or skink, is the type. They have short feet, a non-extensible tongue, the body and tail are covered with equal scales, like tiles; they have no impressed lateral line, and the toes are margined. [See SKINK.]

SCINK, *n.* (skink.) A cast calf. [*Vulgar.*]  
SCINTILLANT, *a.* [See SCINTILLATE.] Emitting sparks or fine igneous particles; sparkling.

SCINTILLATE, *v. i.* [*L. scintillo*.] This word seems to be a diminutive formed

on the Teutonic *scinan*, Eng. to *shine*.]

1. To emit sparks or fine igneous particles.

Marbles do not *scintillate* with steel.

*Fourcroy.*

2. To sparkle, as the fixed stars. SCINTILLATING, *ppr.* Emitting sparks; sparkling.

SCINTILLATION, *n.* The act of emitting sparks or igneous particles; the act of sparkling.—2. In *astron.*, the term applied to the twinkling or tremulous motion of the light of the larger fixed stars.

SCIOGRAPHY, *n.* [*Gr. σκία*, a shadow, and γράφω, to describe.] In *painting*, &c., the art of casting and delineating shadows with truth and upon mathematical principles.

SCIOLOGISM, *n.* [See SCIOLOGIST.] Superficial knowledge.

SCIOLOGIST, *n.* [*L. sciolus*, a diminutive formed on *scio*, to know.] One who knows little, or who knows many things superficially; a smatterer.

These passages in that book, were enough to humble the presumption of our modern *sciolists*, if their pride were not as great as their ignorance. *Temple.*

SCIOLOUS, *a.* Superficially or imperfectly knowing.

SCIOLOTO, [*It.*] In *music*, a term which, applied to counterpoint, signifies that it is free from syncoated or tied notes, or that it is not constrained by general rules. When applied to notes it signifies that they are not tied together, and is opposed to *legato*.

SCIOMACHY, *n.* [*Gr. σκία*, a shadow, and μάχη, a battle.] A battle with a shadow. [*Little used.*]

SCIOMANCY, *n.* [*Gr. σκία* and μαντία.] Divination by shadows.

SCION, *n.* [*L. scindo*, to cut off.] The first young shoot produced during the year by a tree; or more commonly a part of a branch prepared for the purpose of being grafted upon some other tree.

SCIOPTIC, *a.* [*Gr. σκία*, shadow, and σκοπεῖν, to see.] Pertaining to the camera obscura, or to the art of exhibiting images through a hole in a darkened room.

SCIOPTIC, } *n.* A sphere or globe  
SCIOPTIC, } with a lens made to  
turn like the eye; used in experiments  
with the camera obscura.

SCIOPTICS, *n.* The science of exhibiting images of external objects, received through a double convex glass into a darkened room.

SCIRE FACIAS, *n.* [*L.*] In *law*, a judicial writ summoning a person to show cause to the court why something should not be done, as to require sureties to show cause why the plaintiff should not have execution against them for debt and damages, or to require a third person to show cause why goods in his hands by replevin, should not be delivered to satisfy the execution, &c. It is not granted till a year and a day after judgment given.

SCIROC, } *n.* [*It. scirocco*.] In  
SCIROC'EO, } Italy, a south-east  
SIROC'EO, } wind; a hot, suffocating  
wind, blowing from the burning  
deserts of Africa. This name is given  
also in the north-east of Italy to a cold,  
bleak wind from the Alps.

SCIRPUS, *n.* A genus of hardy bog plants, known in Britain by the name of club-rush. Class and order Triandria monogynia, Linn.; nat. order Cyperaceæ. *S. tuberosus*, is the water

chestnut of the Chinese. Several species, especially the *S. lacustris*, lake club-rush or bull-rush, are used for mats, chair bottoms, &c.

SCIRRHOUSITY, *n.* [See SCIRRHIUS.] An induration of the glands.

SCIRRHOUS, *a.* Indurated; hard; knotty; as a gland.—2. Proceeding from scirrhus; as, *scirrhus* affections; *scirrhus* disease.

SCIRRHUS, *n.* [*It. scirro*; *Sp. escirro*; *L. scirrus*; *Gr. σκίρρος*.] In *sur.* and *med.*, a hard tumour on any part of the body, usually proceeding from the induration of a gland, and often terminating in a cancer.

SCIRROSITY. See SCIRRHOUSITY.

SCISCITATION, *n.* [*L. sciscitor*, to inquire or demand.] The act of inquiring; inquiry; demand. [*Little used.*]

SCISSEL, *n.* [from *L. scindo*, to cut.] The clippings of various metals, produced in several mechanical operations concerned in their manufacture. The slips or plates of metal, out of which circular blanks have been cut for the purpose of coinage, are called *scissel* at the mint.

SCISSIBLE, *a.* [*L. scissus*, *scindo*, to cut.] Capable of being cut or divided by a sharp instrument; as, *scissible* matter or bodies.

SCISSILE, *a.* [*L. scissilis*, from *scindo*, to cut.] That may be cut or divided by a sharp instrument.

SCISSION, *n.* (siz'ou.) [*Fr.* from *L. scissio*, *scindo*, to cut.] The act of cutting or dividing by an edged instrument.

SCISSORS, *n. plur.* (siz'zors.) [*L. scissor*, from *scindo*, to cut, *Gr. σκίζω*, *Sax. sceadan*.] A cutting instrument resembling shears, but smaller, consisting of two cutting blades movable on a pin in the centre, by which they are fastened. Hence we usually say, a *pair* of scissors.

SCISSURE, *n.* [*L. scissura*, from *scindo*, to cut.] A longitudinal opening in a body, made by cutting.

SCITAMINACEÆ, *n.* A nat. order of plants. [See ZINGIBERACEÆ.]

SCITAMINEOUS, *a.* [*L. scitamentum*, a delicacy.] Belonging to the Scitamineæ, one of Linnæus's natural orders of plants.

SCIURIDÆ, *n.* The squirrel tribe, of which the genus *Squirrel* is the type. [See SQUIRREL.]

SCIURINES, *n. plur.* [*Lat. sciurus*, a squirrel.] Rodent animals, of the squirrel tribe.

SELAVONIAN, } *a.* [from *Sclavi*, a  
SLAVONIC, } people of the north  
of Europe.] Pertaining to the Slavi, a people that inhabited the country between the rivers Save and Drave, or to their language. Hence the word came to denote the language which is now spoken in Poland, Russia, Hungary, Bohemia, &c.

SCLERANTHACEÆ, *n.* A small nat. order of plants placed by Lindley in the curvemyrose group of incomplete exogens. They are small herbs with opposite leaves without stipules, having axillary sessile flowers which are hermaphrodite. They are mostly natives of barren fields in Europe, Asia, and North America, and are nearly related to Chenopodiaceæ, or the goose-foot tribe.

SCLERANTHUS, *n.* Knawel, a genus of plants belonging to the nat. order Scleranthaceæ. [See KNAWEL.]

**SCLER'ODERMS**, or **SCLERODERMI**, *n.* [Gr. *σκληρος*, hard, and *δερμα*, skin.] The name given by Cuvier to a family of plectognathic fishes, comprehending those which have the skin covered with hard scales; as the Mediterranean file fish, the ostracions.

**SCLEROTIC**, *a.* [Gr. *σκληρος*, hard; *σκληροτης*, hardness.] Hard; firm; as the *sclerotic* coat or tunic of the eye.

**SCLEROTIC**, *n.* The firm white outer coat of the eye. It does not extend over more than about four-fifths of the eye, its place in front being supplied by a transparent membrane called the *Cornea*, which affords a passage to the light.—2. A medicine which hardens and consolidates the parts to which it is applied.

**SCOAT**, *v. t.* [Arm. *scoaz*, the shoulder; whence *scoazya*, to shoulder up; to prop, to support; W. *ysgwyz*, a shoulder; *ysgwyzane*, to shoulder; which is said to be from *cwyz*, a fall.] To support, as a wheel, by placing some obstacle, as a stone, to prevent its rolling.

**SCOBIFORM**, *a.* [L. *scobs*, saw-dust, and *form*.] Having the form of saw-dust or raspings.

**SCOBS**, *n.* [L. from *scabo*, to scrape.] Raspings of ivory, hartshorn, metals or other hard substances; dross of metals, &c.

**SCOFF**, *v. i.* [Gr. *σκαωτω*. The primary sense is probably to throw, in which sense it coincides with the D. *schoppen*, G. *schuppen*, to push, to shove. But I do not find the word, in the English and Greek sense, in any modern language except the English.] To treat with insolent ridicule, mockery, or contumelious language; to manifest contempt by derision; with *at*. To *scoff* at religion and sacred things is evidence of extreme weakness and folly, as well as of wickedness.

They shall *scoff* at the kings; Hab. i.

**SCOFF**, *v. t.* To treat with derision or scorn.

**SCOFF**, *n.* Derision, ridicule, mockery, or reproach, expressed in language of contempt; expression of scorn or contempt.

With *scoffs* and scorns and contumelious taunts. *Shak.*

**SCOFF'ED**, *pp.* Treated with derision or scorn.

**SCOFF'ER**, *n.* One who scoffs; one that mocks, derides, or reproaches in the language of contempt; a scorner.

There shall come in the last days *scuffers*, walking after their own lusts, and saying, "Where is the promise of his coming?" 2 Pet. iii.

**SCOFF'ING**, *ppr.* Deriding or mocking; treating with reproachful language.

**SCOFF'ING**, *n.* The act of treating with scorn.

**SCOFF'INGLY**, *adv.* In mockery or contempt; by way of derision.

Aristotle applied this hemistich *scoffingly* to the sycophants at Athens. *Broomie.*

**SCÖLD**, *v. i.* [D. *schelden*; G. *schelten*; Dan. *skielder*, to rail, to scold; Sw. *skalla*, to sound or ring; *skallra*, to snap or crack; *skalla*, to bark, to scold. It seems to be formed on the root of G. *schelle*, a bell, a jingle, a box on the ear; *schellen*, *schallen*, to ring. If *s* is a prefix, this word coincides with *call*, and Sax. *gallan*, to sing, *gyllan*, *giellan*, to yell.] To find fault or rail with rude clamour; to brawl; to utter railing or harsh, rude,

boisterous rebuke; with *at*; as, to *scold* at a servant. A *scolding* tongue, a *scolding* wife, a *scolding* husband, a *scolding* master, who can endure? Pardon me, 'tis the first time that ever

I'm forc'd to *scold*. *Shak.*

**SCÖLD**, *v. t.* To chide with rudeness and boisterous clamour; to rate.

**SCÖLD**, *n.* A rude, clamorous, foul-mouthed woman.

*Scolds* answer foul-mouthed *scolds*. *Swift.*

2. A scolding; a brawl.

**SCÖLDER**, *n.* One that scolds or rails.

**SCÖLDING**, *ppr.* Railing with clamour; uttering rebuke in rude and boisterous language.—2. *a.* Given to scolding.

**SCÖLDING**, *n.* The uttering of rude, clamorous language by way of rebuke or railing; railing language; a rating.

**SCÖLDINGLY**, *adv.* With rude clamour or railing.

**SCÖL'ECITE**, *n.* [Gr. *σκαλεξ*, a worm.] One division of the old species Mesotype, occurring in radiated crystallizations of a white colour, or transparent; and consisting of silica, alumina, and lime, with thirteen and a half per cent. of water.

**SCÖL'OP**, *n.* A pectinated shell. [See **SCALLOP**.] 2. An indentation or cut like those of a shell.

**SCÖL'OP**, *v. t.* To form or cut with scollaps. [See **SCALLOP**.]

**SCÖL'ADÆ**, *n.* A family of fossorial hymenopterous insects, for the most part inhabitants of tropical countries, where they are generally found in sandy districts.

**SCÖL'OP'CIDÆ**, *n.* A family of wading birds, of which the genus *Scelopax* is the type.

**SCÖL'OPAX**, *n.* A genus of birds, of the order Grallæ, including woodcock and snipe.

**SCÖL'OP'EN'DRA**, *n.* [Gr. *σκολοπιδρα*.] A genus of insects, of the order Myriapoda, destitute of wings. These insects have as many feet on each side as there are segments in the body. There are several species. They inhabit the southern parts of Europe, and all the tropical portions of the globe, and their bite is venomous. [See **CHILOPODA**, **CENTIPED**.]

**SCÖL'OP'EN'DRIUM**, *n.* A genus of ferns. [See **HART'S TONGUE**.]

**SCÖLYMUS**, *n.* A genus of annual and perennial herbs belonging to the nat. order compositæ. They are known in English lists by the name of golden thistle. [See **GOLDEN THISTLE**.]

**SCÖLYTUS**, *n.* A genus of small but very destructive coleopterous insects, belonging to the family Xylophagidæ, or wood-eaters. They destroy immense numbers of trees, especially firs, pines, and elms, by piercing them for the sake of eating the inner bark.

**SCÖM'BEROIDS**, or **SCÖM'BRIDÆ**, *n.* A family of fishes of the section Acanthopterygii, of which the common mackerel (*Scomber scomber*, Linn.) may be regarded as a type. The tunny, sword-fish, dory and boar-fish, also belong to this group which contains a multitude of species and many genera.

**SCÖMM**, *n.* [L. *scommia*; Gr. *σκιωμα*, from *σκαωτω*. See **SCOFF**.] 1. † A buffet.—2. † A flout; a jeer.

**SCÖNCE**, *n.* [D. *schanz*; G. *schanze*; Sw. *shans*, a fort or castle, a fortification.] 1. † A fort or bulwark; a work

for defence.—2. In *arch*, a branch to set a light upon, or to support a candlestick; a screen or partition to

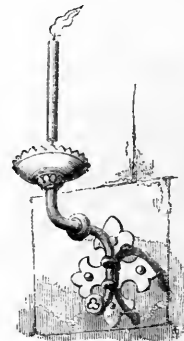

Scence.

cover or protect any thing; the head or top of any thing.

Golden *scences* hang upon the walls.

*Dryden.*

3. The circular tube with a brim in a candlestick, into which the candle is inserted, that is, the support, the holder of the candle; and from this sense the candlestick, in the preceding definition, has its name.—4. A fixed seat or shelf. [Local.]

**SCÖNCE**, *n.* [D. *skönnere*, to judge, to discern; *skönsom*, judicious.] 1. † Sense; judgment; discretion or understanding.—2. The head; a low word.—3. A mulct or fine. [Qu. *poll-tax*.]

**SCÖNCE**, *v. t.* To mulct; to fine. [A low word and not in use.]

**SCÖNCH'ION**, *n.* [Fr. *écoinçon*.] In *arch*, a term probably originally applied to the angle formed by the meeting of the planes of the window, jamb, and wall of a room; but now used to denote the whole side of any aperture, formed of roughly dressed stones.

**SCÖNE**, *n.* A thin cake of wheat or barley meal. [Scotch.]

**SCÖNE**, *v. t.* To beat with the open hand applied to the buttocks, to correct. [Scotch.]

**SCÖOP**, *n.* [D. *schop*, a scoop, and a shovel; G. *schüppe*; *schupp*, a shove; *schuppen*, to push or shove; Sw. *shuff*, a shove; Dan. *shuffe*, a scoop, a shovel, a box or drawer; D. *schuif*, *schuiven*, to shove; Fr. *ecope*.] 1. A large ladle; a vessel with a long handle fastened to a dish, used for dipping in liquors; also, a little hollow piece of wood for baling boats.—2. A kind of box shovel suspended by cords from a triangular frame, and worked by a long handle used in raising water.—3. An instrument of surgery.—4. A sort of pan for holding coals; a coal scuttle. [Provincial.] 5. A sweep; a stroke; a swoop.—*Scoop-wheel*, a large wheel with numerous scoops fastened in its periphery, used for raising water in draining.

**SCÖOP**, *v. t.* To lade out; properly, to take out with a scoop or with a sweeping motion.

He *scoop'd* the water from the crystal flood.

*Dryden.*

2. To empty by lading; as, he *scooped* it dry.—3. To make hollow, as a scoop or dish; to excavate; as, the Indians

*scoop* the trunk of a tree into a canoe.

Those carbuncles the Indians will *scoop*, so as to hold above a pint. *Arbutnot.*

4. To remove, so as to leave a place hollow.

A spectator would think this circular mound had been actually *scooped out* of that hollow space. *Spectator.*

**SCOOP'ED**, *pp.* Taken out as with a scoop or ladle; hollowed; excavated; removed so as to leave a hollow.

**SCOOP'ER**, *n.* One that scoops; also, a water-fowl.

**SCOOP'ING**, *ppr.* Lading out; making hollow; excavating; removing so as to leave a hollow.

**SCOOP'-NET**, *n.* A net so formed as to sweep the bottom of a river.

**SCOPE**, *n.* [*L. scopus*; Gr. σκοπεω, from σκοπειν, to see or view; Heb. שִׁחַף, *shehaph*, to see, to behold; Ch. to drive or strike. The primary sense is to stretch or extend, to reach; properly, the whole extent, space, or reach, hence the whole space viewed, and hence the limit or ultimate end.] 1. Space; room; amplitude of intellectual view; as, a free *scope* for inquiry; full *scope* for the fancy or imagination; ample *scope* for genius.—2. The limit of intellectual view; the end or thing to which the mind directs its view; that which is purposed to be reached or accomplished; hence, ultimate design, aim, or purpose; intention; drift. It expresses both the purpose and thing purposed.

Your *scope* is as mine own,  
So to enforce and qualify the laws,  
As to your soul seems good. *Shak.*

The *scope* of all their pleading against man's authority, is to overthrow such laws and constitutions of the church... *Hooker.*

3. Liberty; freedom from restraint; room to move in.—4. Liberty beyond just limits; licence.

Give him line and *scope*. *Shak.*  
5. † Act of riot; sally; excess.—6. † Extended quantity; as, a *scope* of land.—7. Length; extent; sweep; as, *scope* of cable.

**SCOPIFORM**, *a.* [*L. scopia*, a broom, and *form*.] Having the form of a broom or besom.

Zeolite, stelliform or *scopiform*. *Kirwan.*

**SCOPIPED**, *n.* [*L. scopia*, a broom, and *pes*, a foot.] One of a tribe of melliferous insects, having a brush of hairs on the posterior foot.

**SCOPIPET**, † *v. t.* To lade out.

**SCOPIEAL**, † *a.* [*Gr. σκοπιτικός*.]

Scoffing.

**SCOPIULOUS**, † *a.* [*L. scopulosus*.]

Full of rocks; rocky.

**SCORBUTE**, † *n.* [*L. scorbutus*.]

Scurvy.

**SCORBU'TIC**, } *a.* [*Fr. scorbutique*,

**SCORBU'TICAL**, } from *L. scorbutus*, the scurvy. See **SCURF**, **SCURVY**.]

1. Affected or diseased with scurvy; as, a *scorbutic* person.—2. Pertaining to scurvy, or partaking of its nature; as, *scorbutic* complaints or symptoms.—3. Subject to scurvy; as, a *scorbutic* habit.

**SCORBU'TICALLY**, *adv.* With the scurvy, or with a tendency to it; as, a woman *scorbutically* affected.

**SCORBU'TUS**, *n.* The scurvy,—*which see*.

**SCORCE**. See **SCORSE**.

**SCORCH**, *v. t.* [*D. schroeijen*, *schrooken*, to scorch. If this is the same

word, there has been a transposition of the vowel. The Saxon has *scorched*, the participle. But it is probable the Dutch is the true orthography, and the word is to be referred to the Ch. שָׂרַח, *charah*, Ar. *haraha* or *charaha*, to burn, singe, or roast.] 1. To burn superficially; to subject to a degree of heat that changes the colour of a thing, or both the colour and texture of the surface. Fire will *scorch* linen or cotton very speedily in extremely cold weather.—2. To burn; to affect painfully with heat. *Scorched* with the burning sun or burning sands of Africa.

**SCORCH**, *v. i.* To be burnt on the surface; to be parched; to be dried up.

Scatter a little mungy straw and fern among your seedlings, to prevent the roots from *scorching*. *Mortimer.*

**SCORCH'ED**, *pp.* Burnt on the surface; pained by heat.

**SCORCH'ING**, *ppr.* Burning on the surface; paining by heat.

**SCORCH'INGLY**, *adv.* So as to parch or burn the surface.

**SCORCH'ING-FENNEL**, *n.* A plant of the genus *Thapsia*; deadly carrot.

**SCORCH'INGNESS**, *n.* The quality of scorching.

**SCORDIUM**, *n.* [*L.*] A plant, the water-germander, a species of *Tenacium*.

**SCORE**, *n.* [*Ir. scor*, a notch; *sgoram*, to cut in pieces; Sax. *scor*, a score, twenty; Ice. *shora*, from the root of *shear*, *share*, *shire*.] 1. A notch or long incision, used in former times to mark a number; hence, the number twenty. Our ancestors, before the knowledge of writing, numbered and kept accounts of numbers by cutting notches on a stick or tally, and in order to avoid the embarrassment of large numbers, it is supposed that when they had made twice ten notches, they cut off the piece or tally containing them, and afterwards counted the *scores* or pieces cut off, and reckoned by the number of separate pieces, or by *scores*.—2. A line drawn.—3. An account or reckoning; as, kept by divisions, marks, or notches cut in pieces of wood; hence the phrase, "he paid his *score*."—4. An account generally.

—5. An account kept of something past; an epoch; an era.—6. Debt, or account of debt.—7. Account; reason; motive.

But left the trade, as many more  
Have lately done on the same *score*.

*Hudibras.*

8. Account; sake.

You act your kindness on Cydaria's *score*. *Dryden.*

9. In *music*, a collection of all the vocal and instrumental parts of a composition, arranged on staves one above the other, and bar for bar, presenting at once, to the eye of a skilful musician, the effect of the whole band as the composition proceeds. A composition so arranged is also said to be *in score*.—*To quit scores*, to pay fully; to make even by giving an equivalent.—*A song in score*, the words with the musical notes of a song annexed and properly arranged.—*Score of a dead eye*, among *seamen*, the hole through which the rope passes.

**SCORE**, *v. t.* To notch; to mark by an incision.—2. To cut; to engrave.—3.

To mark by a line.—4. To set down as a debt.

Madam, I know when,  
Instead of five, you *scored* me ten. *Swift.*

5. To set down or take as an account; to charge; as, to *score* follies.—6. To form a score in music.

**SCORED**, *pp.* Notched; set down; marked; prepared for hewing. In *bot.*, a *scored stem* is marked with parallel lines or grooves.

**SCOR'ER**, *n.* A well known instrument used by woodmen in marking numbers on timber trees.

**SCOR'IA**, *n.* [*L.* from the Gr. σκωρία, *skōgia*, rejected matter, that which is thrown off.] Dross; the recrement of metals in fusion, or the mass produced by melting metals and ores.—*Scoriae, plur.*, the cinders of volcanic eruptions.

**SCORIA'CEOUS**, *a.* Pertaining to dross; like dross or the recrement of metals; partaking of the nature of scoria.

**SCORIFICATION**, *n.* In *metallurgy*, the act or operation of reducing a body, either wholly or in part, into scoria.

**SCORIFIED**, *pp.* Reduced to scoria.

**SCORIFORM**, *a.* [*L. scoria* and *form*.] Like scoria; in the form of dross.

**SCORIFY**, *v. t.* To reduce to scoria or drossy matter.

**SCORIFYING**, *ppr.* Reducing to scoria.

**SCORING**, *ppr.* Notching; marking; setting down as an account or debt; forming a score.

**SCOR'IOUS**, *a.* Drossy; recrementitious.

**SCORN**, *n.* [*Sp. escarnio*, scorn; *escarneer*, to mock; It. *scherno*, *schernire*; W. *ysgorn*, *ysgorniaw*.] 1. Extreme contempt; that disdain which springs from a person's opinion of the meanness of an object, and a consciousness or belief of his own superiority or worth.

He thought *scorn* to lay hands on Mordecai alone; *Esth. iii.*

Every sullen frown and bitter *scorn*  
But fann'd the fuel that too fast did burn. *Dryden.*

2. A subject of extreme contempt, disdain, or derision; that which is treated with contempt.

Thou makest us a reproach to our neighbours, a *scorn* and a derision to them that are around us; *Ps. xlv.*

*To think scorn*, † to disdain; to despise. —*To laugh to scorn*, to deride; to make a mock of; to ridicule as contemptible.

They *laughed us to scorn*; *Neh. ii.*

**SCORN**, *v. t.* To hold in extreme contempt; to despise; to contemn; to disdain; *Job xvi.*

Surely he *scorneth* the scorner; but he giveth grace to the lowly; *Prov. iii.*

2. To think unworthy; to disdain. Fame, that delights around the world to stray,

*Scorns not to take our Argos in her way.*

3. To slight; to disregard; to neglect. This my long suffrance and my day of grace, Those who neglect and *scorn*, shall never taste. *Milton.*

**SCORN**, † *v. i.* To *scorn at*, to scoff at; to treat with contumely, derision, or reproach.

**SCORN'ED**, *pp.* Extremely contemned or despised; disdained.

**SCORN'ER**, *n.* One that scorns; a contemner; a despiser.

They are great *scorners* of death. *Spenser.*

2. A scoffer; a derider; in Scripture, one who scoffs at religion, its ordinances and teachers, and who makes a mock of sin and the judgments and threatenings of God against sinners; Prov. i.; xix.

**SCORNFUL**, *a.* Contemptions; disdainful; entertaining scorn insolent.

Th' enamour'd deity

The scornful damsel shuns. *Dryden.*

2. Acting in defiance or disregard. *Scornful* of winter's frost and summer's sun. *Prior.*

3. In *scrip.*, holding religion in contempt; treating with disdain religion and the dispensations of God.

**SCORNFULLY**, *adv.* With extreme contempt; contemptuously; insolently. The sacred rights of the Christian church are *scornfully* trampled on in print. *Atterbury.*

**SCORNFULNESS**, *n.* The quality of being scornful.

**SCORNING**, *ppr.* Holding in great contempt; despising; disdainful.

**SCORNING**, *n.* The act of contemning; a treating with contempt, slight, or disdain.

How long will the scorners delight in their *scorning*? Prov. i.; Ps. cxxiii.

**SCORODITE**, *n.* [Gr. *σκοροδον*, garlic; from its smell under the blowpipe.] A native compound of arsenic acid and oxide of iron, having a leek-green or brownish colour.

**SCORPIO**, *n.* [L.] A genus of Arachnida. [See SCORPION.]

**SCORPIO**, } *n.* [L.] A constellation  
**SCORPIUS**, } of the zodiac. [See SCORPION.]

**SCORPION**, *n.* [Fr. from *L. scorpio*; Gr. *σκορπιος*: probably altered from the Oriental *akhorab*. The Arabic verb to which this word belongs, signifies to wound, to strike, &c.] 1. The popular English name of any species of *scorpio*, which is a genus of pedipalpus pulmonary arachnids. *Scorpions* have an elongated body, suddenly terminated by a long slender tail formed of six joints, the last of which terminates in an arcuated and very acute sting, which effuses a venomous liquid. This sting



Scorpion (*Scorpio afer*).

gives rise to excruciating pain, but is unattended either with redness or swelling, except in the axillary or inguinal glands, when an extremity is affected. It is very seldom, if ever, destructive of life. *Scorpions* are found in the south of Europe, in Africa, in the East Indies, and in South America. The number of species is not accurately determined.—2. In *Scripture*, a painful scourge; a kind of whip armed with points like a scorpion's tail; 1 Kings xii. Malicious and crafty men, who delight in injuring others, are compared to *scorpions*; Ezek. ii.—3. In *astron.*, the eighth sign of the zodiac, which the sun enters Oct. 23.—4. A sea fish. [L. *scorpius*.]—5. An ancient military engine used chiefly in the defence of the walls of a town. It resembled the ballista in form, consisting of two beams bound together by ropes, from the middle of which rose a third

beam, called the *stylus*, so disposed as to be pulled up and let down at pleasure; on the top of this were fastened iron hooks whereon a sling was hung of iron or hemp for throwing stones.—*Water scorpion*, an aquatic insect.

**SCORPION-FLY**, *n.* An insect of the genus *Panorpa*, having a tail which resembles that of a scorpion.

**SCORPION-GRASS**, *n.* *Myosotis*, a genus of plants. [See *MYOSOTIS*.]

**SCORPION-SENNA**, *n.* A plant of the genus *Coronilla*, the *C. emirus*, Linn.

**SCORPIONS-THORN**, *n.* A plant of the genus *Ulex*, the *U. scorpius*, Linn.

**SCORPION-WÖRT**, *n.* A plant, the *Ornithopus scorpioides*.

**SCORPIURUS**, *n.* A genus of plants belonging to the papilionaceous division of the nat. order Leguminosæ. They are cultivated for the grotesque shape of their pods, which bear a strong resemblance to caterpillars.

**SCORSE**, *† n.* [It. *scorsa*, a course; L. *ex* and *cursum*.] A course or dealing; barter.

**SCORSE**, *† v. t.* To chase.—2. *†* To barter or exchange.

**SCORSE**, *† v. i.* To deal for the purchase of a horse.

**SCORTATORY**, *a.* [L. *scortator*, from *scortor*.] Pertaining to or consisting in lewdness.

**SCORZA**, *n.* [Qu. It. *scorza*, bark; L. *ex* and *cortex*.] In *min.*, a variety of epidote.

**SCORZONERA**, *n.* A genus of perennial herbs belonging to the nat. order Compositæ, sub-order Cichoraceæ. They are known in English lists by the name of viper's grass, and one of the species, *S. hispanica*, is cultivated for its roots, which are sold as an edible, and commonly known as *skirret*.

**SCOT**, *n.* [Sax. *scæt*, a part, portion, angle, or bay, a garment or vest, a towel, cloth, or sheet; *scæt*, *scæta*, *scætt*, money, tax, tribute, toll, price, gift; *scæta*, *scyta*, a sheet. This is the English *shot*, in the phrase, he paid his *shot*; and *scot*, in *scot and lot*. Ice. *shot*, D. *schot*, a wainscot, shot, scot; *shoot*, a sheet, a shoot, a shot, a sprig, a bolt, the lap, the womb; G. *schoss*, scot, a shoot, and *schooss*, lap, womb; Sw. *shatt*, tax, tribute, rent, Eng. *scot*; Dan. *shot*, *shat*, id.; *shüd*, the lap, the bosom, the waist of a coat; Fr. *écot*, shot, reckoning, It. *scotto*; Sp. *escote*, shot, reckoning, a tucker, or small piece of linen that shades a woman's breast, also the sloping of a garment; *escota*, a sheet, in seamen's language; Port. *escota*; *escote*, shot, club. This word coincides in elements with *shade*, *scud*, *shoot*, *shed*, and *sheet*, all of which convey the sense of driving, or of separating, cutting off.] In *law* and *English history*, a portion of money, assessed or paid; a customary tax or contribution laid on subjects according to their ability; also, a tax or custom paid for the use of a sheriff or balliff. Hence our modern *shot*; as, to pay one's *shot*.—*Scot and lot*, parish payments. When persons were taxed not to the same amount, but according to their ability, they were said to pay *scot and lot*.

**SCOT**, *n.* [Sax. *scotta*, *scotte*; W. *ysgotiad*, a woodsman, a *Scot*, from *ysgavd*, a shade; *ysgodi*, to shade, to shelter, Eng. *shade*—*which see*. This word signifies, according to the Welsh,

an inhabitant of the woods, and from the same root probably as *Scythian*, *Scythia*.] A native of Scotland or North Britain.

**SCOT**, **SCOTCH**, *v. t.* To stop the wheel of a coach or waggon with a stone, &c. [Local.]

**SCOTAL**, } *n.* [*scot* and *ale*.] In  
**SCOTAL**, } *law*, the keeping of an alehouse by the officer of a forest, and drawing people to spend their money for liquor, for fear of his displeasure.

**SCOTCH**, *a.* Pertaining to Scotland or its inhabitants.

**SCOTCH**, *† v. t.* [Qu. Arm. *squeigea*, or Sax. *scædan*.] This cannot be from Fr. *ecorcher*, to flay or peel; *ecorce*, bark.] To cut with shallow incisions; a line drawn on the ground, as in hop-scotch.

**SCOTCH**, *n.* A slight cut or shallow incision.

**SCOTCH-COLLOPS**, } *n.* In  
**SCOTCH-ED-COLLOPS**, } *cooking*, a dish consisting of thin slices of beef, beaten, and done in a stew-pan with butter and flour, some salt, pepper, and a finely minced onion.

**SCOTCH-ED**, *ppr.* Cut with shallow incisions.—2. Supported, as a wheel. [Local.]

**SCOTCH-FIDDLE**, *n.* A cant name for the itch.

**SCOTCH-FIR**, *n.* The *Pinus sylvestris*, also called the Scotch pine and wild pine. [See *PINE*.]

**SCOTCH HOPPER**, **SCOTCH-HOP**, *n.* A play in which boys hop over scotches or lines in the ground; hop-scotch.

**SCOTCHING**, *ppr.* Cutting with shallow incisions.—2. Supporting, as a wheel. [Local.] [See the verb.]

**SCOTCHING**, **SCUTCHING**, *n.* In *masonry*, a method of dressing stone either by a pick, or pick-shaped chisels inserted into a socket formed in the head of a hammer.

**SCOTER**, *n.* A name given to ducks of the genus *Oidemia*. They are occasional, and winter visitants to our coasts. Some of the species are plentiful in N. America. *O. nigra* is found on our coasts all the year. Its flesh is oily, and has a fishy taste.

**SCOT FREE**, *a.* Free from payment or scot; untaxed.—2. Unhurt; clear; safe.

**SCOTIA**, *n.* [Gr. *σκοτία*, darkness.] The hollow moulding in the base of a column between the filets of the tori. It takes its name from the shadow formed by it, which seems to envelop it in darkness. It is sometimes called



Scotia or Trochilus moulding.

a casement, and often, from its resemblance to a common pulley, *Trachilus*. It is frequently formed by the junction of circular areas of different radii. **SCOTISH**, or **SCOT'TISH**. See *SCOTCH*, the established word. **SCOTIST**, *n.* [from *Duns Scotus*, a Scotch cordelier.] One of the followers of Scotus, a sect of school divines who maintained the immaculate conception of the Virgin, or that she was born without original sin; in opposition to the Thomists, or followers of Thomas Aquinas.

SCOTODIN'IA, *n.* [Gr. from *σκοτος*, darkness, and *δινος*, giddiness.] In *med.*, giddiness, with imperfect vision.

SCOTOGRAPH, *n.* [*σκοτος*, darkness, and *γραφω*, to write.] An instrument by which one may write in the dark.

SCOTOMY, *n.* [Gr. *σκοτωμα*, vertigo, from *σκοτος*, to darken.] Dizziness or swimming of the head, with dimness of sight.

SCOTS, *n.* The Scotch dialect.

SCOTS, *a.* Scotch; as, the *Scots Magazine*; *Scots* oatmeal.

SCOTTERING, *n.* A provincial word in Herefordshire, denoting the burning of a wad of pease straw at the end of harvest.

SCOTTICISM, *n.* An idiom or peculiar expression of the natives of Scotland.

SCOTTISH. See SCOTISH.

SCOUNDREL, *n.* [said to be from *It. scandarouole*, a lurker, one that skulks from the roll or muster, from *L. abscondo*. The Italian signifies properly the play hoodman-blind, or fox in the hole.] A mean, worthless fellow; a rascal; a low petty villain; a man without honour or virtue. A person of no titular rank; one of the general mass of mankind.

Go, if your ancient but ignoble blood  
Has crept through scoundrels ever since  
the Flood. *Pope.*

SCOUNDREL, *a.* Low; base; mean; unprincipled

SCOUNDRELISM, *n.* Baseness; turpitude; rascality.

SCOUR, *v. t.* [Goth. *skauron*, to scour; Sax. *scur*, a scouring; G. *scheuern*; Fr. *ecurer*, to scour.] 1. To rub hard with something rough, for the purpose of cleaning; as, to scour a kettle; to scour a musket; to scour armour.—2. To clean by friction; to make clean or bright.—3. To cleanse from grease, dirt, &c., as articles of dress; to renovate.—4. To purge violently.—5. To remove by scouring.

Never came reformation in a flood  
With such a heady current, scouring faults.  
*Shak.*

6. To range about for taking all that can be found; as, to scour the sea of pirates.—7. To pass swiftly over; to brush along; as, to scour the coast.—Not so when swift Camilla scours the plain.  
*Pope.*

*Scour*, in its familiar sense, is often spelt *scower*.

SCOUR, *v. i.* To perform the business of cleaning vessels by rubbing.—2. To clean.

Warm water is softer than cold, for it scoureth better.  
*Bacon.*

3. To be purged to excess.—4. To rove or range for sweeping or taking something.

Barbarossa, thus scouring along the coast of Italy.  
*Knoller.*

5. To run with celerity; to scamper.

So four fierce coursers, starting to the race,  
Scour through the plain, and lengthen every pace.  
*Dryden.*

SCOUR'ED, *pp.* Rubbed with something rough, or made clean by rubbing; severely purged; brushed along.

SCOUR'ER, *n.* One that scours or cleans by rubbing.—2. A drastic cathartic.—3. One that runs with speed.

SCOURGE, *n.* (*skurj*). [Fr. *escourgee*; *It. scoreggia*, a leather thong; from *L. corrigia*, from *corrigo*, to straighten.]

1. A whip; a lash consisting of a strap or cord; an instrument of punishment or discipline.

A scourge of small cords; John ii.

2. A punishment; vindictive affliction.

Famine and plague are sent as scourges for amendment; 2 Esdras.

3. He or that which greatly afflicts, harasses, or destroys; particularly, any continued evil or calamity. Attila was called the scourge of God, for the miseries he inflicted in his conquests. Slavery is a terrible scourge.—4. A whip for a top.

SCOURGE, *v. t.* (*skurj*). [It. *scoraggiare*.] 1. To whip severely; to lash.

Is it lawful for you to scourge a man that is a Roman? Acts xxii.

2. To punish with severity; to chastise; to afflict for sins or faults, and with the purpose of correction.

He will scourge us for our iniquities, and will have mercy again. *Tobit.*

Whom the Lord loveth he chasteneth, and scourgeth every son whom he receiveth; Heb. xii.

3. To afflict greatly; to harass, torment, or injure.

SCOURG'ED, *pp.* Whipped; lashed; punished severely; harassed.

SCOURG'ER, *n.* One that scourges or punishes; one that afflicts severely.

SCOURG'ING, *ppr.* Whipping; lashing with severity; punishing or afflicting severely.

SCOURG'ING, *n.* Punishment by the scourge.

SCOURING, *ppr.* Rubbing hard with something rough; cleaning by rubbing; cleaning from grease, dirt, &c.; cleansing with a drastic cathartic; ranging over for clearing.

SCOURING, *n.* A rubbing hard for cleaning; a cleansing from grease, dirt, &c.; a cleansing by a drastic purge; looseness; flux.

SCOURING-BARREL. A machine in which scrap iron is freed from dirt and rust by friction.

SCOURSE. See SCORSE.

SCOUT, *n.* [Fr. *escout*; *écouter*, to hear, to listen; Norm. *escout*, a hearing; *It. scolta*, a watch; *scoltare*, to listen; *L. ausculto*; Gr. *σκις*, the ear, and *L. culto*.] 1. In *milit. affairs*, a person sent before an army, or to a distance, for the purpose of observing the motions of an enemy or discovering any danger, and giving notice to the general. Horsemen are generally employed as scouts.—2. A cant term at Oxford for a college servant or waiter.—3. A high rock.

SCOUT, *v. i.* To go on the business of watching the motions of an enemy; to act as a scout.

With obscure wing  
Scout far and wide into the realm of night.  
*Milton.*

SCOUT, *v. t.* [perhaps Sw. *skjuta*, to shoot, to thrust, that is, to reject.] To sneer at; to treat with disdain and contempt; to reject.

SCOUTED, *pp.* Sneered at; treated with contempt; rejected with disdain.

SCOUTH, or SCOWTH, *n.* Room; liberty to range. [*Scotch.*]

SCOUT'ING, *ppr.* Treating with contempt; rejecting with disdain.

SCOV'EL, *n.* [W. *ysgubell*, from *ysgub*, a broom, *L. scopula*.] A mop for sweeping ovens; a maulkin.

SCOW, *n.* [*D. schouw*.] A kind of large flat-bottomed boat used chiefly as a lighter, a pram.

SCOWER, *v. t.* See SCOUR.

685

SCOWL, *v. i.* [Sax. *scul*, in *scul-eaged*, scowl-eyed; probably from the root of G. *schel*, *schiel*, *D. scheel*, distorted; *schielen*, Dan. *skieler*, to squint; Gr. *σκολιου*, to twist.] 1. To wrinkle the brows, as in frowning or displeasure; to put on a frowning look; to look sour, sullen, severe, or angry.

She scowl'd and frown'd with froward countenance. *Spenser.*

2. To look gloomy, frowning, dark, or tempestuous; as, the scowling heavens.

SCOWL, *v. t.* To drive with a scowl or frowns.

SCOWL, *n.* The wrinkling of the brows in frowning; the expression of displeasure, sullenness, or discontent in the countenance.—2. Gloom; dark or rude aspect; as of the heavens.

SCOWL'ED, *pp.* Frowned at.

SCOWL'ING, *ppr.* Contracting the brows into wrinkles; frowning; expressing displeasure or sullenness.

SCOWL'INGLY, *adv.* With a wrinkled, frowning aspect; with a sullen look.

SCRAB'BLE, *v. i.* [*D. krabbelen*, to scrape, to scribble; *krabben*, to scrape; G. *krabbeln*, *graben*. This word belongs to the root of *scrape*, *L. scribo*, Eng. *grave*, *engrave*, &c. See SCRAPE.]

1. To make irregular or crooked marks; as, children *scramble* when they begin to write; hence, to make irregular and unmeaning marks; to scribble.

David scabbled on the doors of the gate; 1 Sam. xxi.

2. In *America*, to scrape, paw, or scratch with the hands; to move along on the hands and knees by clawing with the hands; to scramble; as, to *scramble* up a cliff or a tree.

SCRAB'BLE, *v. t.* To mark with irregular lines or letters; as, to *scramble* paper.

SCRAB'BLING, *ppr.* Making irregular marks.—2. In *America*, scraping; scratching; scrambling.

SCRAFFLE, *v. i.* To scramble; to be industrious.—2. To shuffle; to use evasion.

SCRAG, *n.* [This word is formed from the root of *rag*, *crag*, Gr. *ραγια*, *ραχι*, rack.] Something thin or lean with roughness.—*Scrag of mutton*, is that part of a sheep's carcase immediately under the head. A raw-boned person is called a *scrag*, but the word thus applied is vulgar.

SCRAG'GED, } *a.* [supra.] Rough

SCRAG'GY, } with irregular points or a broken surface; as, a *scraggy* hill; a *scragged* back bone.—2. Lean with roughness.

SCRAG'GEDNESS, } *n.* Leanness, or

SCRAG'GINESS, } leanness with roughness; ruggedness; roughness occasioned by broken irregular points.

SCRAG'GILY, *adv.* With leanness and roughness.

SCRAM'BLE, *v. i.* [*D. schrammen*, to scratch. It is not improbable that this word is corrupted from the root of *scrape*, *scramble*.] 1. To move or climb by seizing objects with the hand, and drawing the body forward; as, to *scramble* up a cliff.—2. To seize or catch eagerly at any thing that is desired; to catch with haste preventive of another; to catch at without ceremony. Man originally was obliged to *scramble* with wild beasts for nuts and acorns.

Of other care they little reck'ning make,  
Than how to *scramble* at the shearer's  
feast. *Milton.*

SCRAM'BLE, *n.* An eager contest for

something, in which one endeavours to get the thing before another.

The scarcity of money enhances the price and increases the *scramble*. *Locke*.

2. The act of climbing by the help of the hands.

**SCRAMBLER**, *n.* One who scrambles; one who climbs by the help of the hands.

**SCRAMBLING**, *ppr.* Climbing by the help of the hands.—2. Catching at eagerly and without ceremony.

**SCRAMBLING**, *n.* The act of climbing by the help of the hands.—2. The act of seizing or catching at with eager haste and without ceremony.

**SCRANCH**, *v. t.* [*D. schrassen*]; from *cranch*, *crunch*, by prefixing *s.*] To grind with the teeth, and with a crackling sound; to crunch.

**SCRANNEL**, *a.* [*Qu. broken, split*; from the root of *crawny*.] Slight; poor.

Grate on their *scannel* pipes of wretched straw.  
*Milton*.

**SCRAP**, *n.* [*from scrape.*] A small piece; properly something scraped off, but used for any thing cut off; a fragment; a crumb; as, *scrap*s of meat.—2. A part; a detached piece; as, *scrap*s of history or poetry; *scrap*s of antiquity; *scrap*s of authors.—3. A small piece of paper.

**SCRAP-BOOK**, *n.* A blank book for the preservation of short pieces of poetry or other extracts from books and papers.

**SCRAPE**, *v. t.* [*Sax. screopan*; *G. schrapen*; *Ir. scriobam, sgrabam*; *L. scribo, Gr. γραφω*, to write; *W. ysgrawu*, to scrape, from *cravu*, to scrape, from *crav*, claws. *Owen*. But probably from the general root of *grave*. In *Ch.* and *Syr.* *𐤒𐤏𐤃*, *herab*, signifies to plough; in *Ar.* to strain, distress, *gripe*. See *GRAVE*.] 1. To rub the surface of any thing with a sharp or rough instrument, or with something hard; as, to *scrape* the floor; to *scrape* a vessel for cleaning it; to *scrape* the earth; to *scrape* the body; *Job* ii.—2. To clean by scraping; *Lev.* xiv.—3. To remove or take off by rubbing.

I will also *scrape* her dust from her, and make her like the top of a rock; *Ezek.* xxvi.

4. To act upon the surface with a grating noise.

The chiming clocks to dinner call;  
A hundred footsteps *scrape* the marble hall.  
*Pope*.

In *public meetings*, &c., to insult by drawing the feet over the floor.—*To scrape off*, to remove by scraping; to clear away by rubbing.—*To scrape together*, to gather by close industry or small gains or savings; as, to *scrape together* a good estate.

**SCRAPE**, *v. i.* To make a harsh noise.—2. To play awkwardly on a violin.—3. To make an awkward bow.—*To scrape acquaintance*, to make one's self acquainted; to curry favour. [A low phrase introduced from the practice of *scraping* in bowling.]

**SCRAPE**, *n.* [*Dan. scrab*; *Sw. shrap*.] 1. A rubbing.—2. The sound of the foot drawn over the floor.—3. A bow.—4. Difficulty; perplexity; distress; that which harasses. [A familiar word.]

**SCRAPED**, *pp.* Rubbed on the surface with a sharp or rough instrument; cleaned by rubbing; cleared away by scraping.

**SCRAPER**, *n.* An instrument with which any thing is scraped; as, a *scrapper*

for shoes.—2. An instrument drawn by oxen or horses, and used for scraping earth in making or repairing roads, digging cellars, canals, &c.—3. An agricultural implement which may be described as a broad hoe, of treble the size and strength of a common hoe, used in cleaning roads, court-yards, cow-houses, &c.—4. An instrument having two or three sides or edges, for

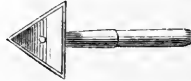

Scraper for ships.

cleaning the planks, masts, or decks of ships, &c.—5. A miser; one who gathers property by penurious diligence and small savings; a scrape-penny.—6. *Mezzotinto scraper*, a blade of steel, one end of which is brought to a tapering edge and point.—7. An awkward fiddler.

**SCRAPING**, *ppr.* Rubbing the surface with something sharp or hard; cleaning by a scraper; removing by rubbing; playing awkwardly on a violin.

**SCRAPING**, *n.* That which is separated from a substance, or is collected by scraping, raking, or rubbing; as, the *scrapings* of the street.

**SCRAP IRON**, *n.* Various pieces of old iron to be re-manufactured.

**SCRAT**, *v. t.* [*formed on the root of L. rado.*] To scratch.

**SCRAT**, *v. i.* To rake; to search.

**SCRAT**, *n.* An hermaphrodite.

**SCRATCH**, *v. t.* [*G. kratzen, ritzen, kritzeln*; probably from the root of *grate*, and *L. rado*.] 1. To rub, tear, or mark. To rub and tear the surface of any thing with something sharp or ragged; as, to *scratch* the cheeks with the nails; to *scratch* the earth with a rake; to *scratch* the hands or face by riding or running among briars.

A sort of small sand-coloured stones, so hard as to *scratch* glass. *Greuv.*

2. To wound slightly.—3. To rub with the nails.

Be mindful, when invention fails,  
*To scratch* your head and bite your nails.

4. To write or draw awkwardly; as, to *scratch* out a pamphlet.—5. To dig or excavate with the claws. Some animals *scratch* holes in which they burrow.—*To scratch out*, to erase; to rub out; to obliterate.

**SCRATCH**, *v. i.* To use the claws in tearing the surface. The gallinaceous hen *scratches* for her chickens.

Dull tame things that will neither bite nor *scratch*. *More.*

**SCRATCH**, *n.* A rent; a break in the surface of a thing made by scratching, or by rubbing with any thing pointed or ragged; as, a *scratch* on timber or glass.

The coarse file...makes deep *scratches* in the work. *Mozon.*

These nails with *scratches* shall deform my breast. *Prior.*

2. A slight wound.

Heav'n forbid a shallow *scratch* should drive The prince of Wales from such a field as this. *Shak.*

3. A kind of wig worn for covering baldness or gray hairs, or for other purpose.—4. Among *pugilists*, a line drawn across the prize ring, up to

which boxers are brought, when they join fight; hence the vulgar phrase, come up to the *scratch*, meaning, stand to the consequences, or appear when expected.—5. *Scratches*, a disease in horses, consisting of dry chaps, rifts, or scabs, between the heel and pastern-joint.

**SCRATCH'ED**, *pp.* Torn by the rubbing of something rough or pointed.

**SCRATCH'ER**, *n.* He or that which scratches.—2. Fowls which scratch for food, as the common hen and cock.

**SCRATCH'ES**, *n. plur.* Cracked ulcers on a horse's foot, just above the hoof.

**SCRATCH'ING**, *ppr.* Rubbing with something pointed or rough; rubbing and tearing the surface.

**SCRATCH'INGLY**, *adv.* With the action of scratching.

**SCRATCH WORK**, *n.* A species of fresco with a black ground, on which a white plaster is laid, which being scratched off with an iron bodkin, the black appears through the scratches, and serves for shadows.

**SCRAW**, *n.* [*Irish and Erse.*] Surface; cut turf.

**SCRAWL**, *v. t.* [*Qu. from crawl*, or its root, or from the *D. schravelen*, to scratch or scrape. Both may be from one root.] 1. To draw or mark awkwardly and irregularly.—2. To write awkwardly.

**SCRAWL**, *v. i.* To write unskilfully and inelegantly.

Though with a golden pen you *scrawl*. *Swift.*

2. To creep; to crawl.

**SCRAWL**, *n.* Unskilful or inelegant writing; or a piece of hasty bad writing.

**SCRAWL'ED**, *pp.* Written unskilfully.

**SCRAWL'ER**, *n.* One who scrawls; a hasty or awkward writer.

**SCRAWL'ING**, *ppr.* Writing hastily or inelegantly.

**SCRAWNY**, or **SCRAN'NY**, *a.* Meagre; wasted. [*Local.*]

**SERAY**, *n.* A fowl called the sea swallow, [*hirundo marina*], of the genus *Terna*.

**SCRE'ABLE**, *v. a.* [*L. screabilis*, from *screeo*, to spit out.] That may be spit out.

**SCREAK**, *v. i.* [*Sw. shrika*; *W. ysgragian*, from *cregian*, to *creak*, to *shriek*, from *creg*, *cryg*, rough, roughness, or its root. This word is only a different orthography of *screech* and *shriek*, but is not elegant.] To utter suddenly a sharp shrill sound or outcry; to scream; as in a sudden fright; also, to creak, as a door or wheel. [*See SCREECH.*]

[When applied to things, we use *creak*, and when to persons, *shriek*, both of which are in good use.]

**SCREAK**, *n.* A creaking; a screech.

**SCREAM**, *v. i.* [*Sax. reomian, hræman* or *hreman*; *W. ysgramu*, to set up a scream or shout. It appears from the Welsh that this is also the English *shrimish*, *Sp. escaramuzar*, which in *D.* is *schermutselen*, from *scherm*, a fence or screen; *schermen*, to fence. The primary sense is to thrust, drive, or force out or away, to separate.] 1. To cry out with a shrill voice; to utter a sudden, sharp outcry, as in a fright or in extreme pain; to shriek.

The fearful matrons raise a *screaming* cry. *Dryden.*

2. To utter a shrill harsh cry; as, the *screaming* owl

**SCREAM**, *n.* A shriek or sharp shrill cry uttered suddenly, as in terror or in pain; as, *screams* of horror, *screams* of owlets, or the shrill cry of a fowl.



**SCREAMER, n.** One that screams.—2. A name given to two species of South American birds, of the genus *Palamedea*. Linn., usually ranked with the grallatorial or wading birds; so called from their loud shrill cry. [See *PALAMEDEA*.]

**SCREAMING, ppr.** Uttering suddenly a sharp shrill cry; crying with a shrill voice.

**SCREAMING, n.** The act of crying out with a shriek of terror or agony.

**SCREECH, v. i.** [Sw. *skriha*; G. *schreien*; W. *ysgrechian*, from *erecian*, to creak; Ir. *screachaim*. See *SCREAM* and *SURIEK*.] 1. To cry out with a sharp shrill voice; to utter a sudden shrill cry, as in terror or acute pain; to scream; to shriek.—2. To utter a sharp cry, as an owl; thence called *screech-owl*.

**SCREECH, n.** A sharp shrill cry uttered in acute pain, or in a sudden fright.—2. A harsh shrill cry, as of a fowl.

**SCREECHING, ppr.** Uttering a shrill or harsh cry.

**SCREECH-OWL, n.** An owl that utters a harsh disagreeable cry at night, often considered ill-boding, but really no more ominous of evil than the notes of the nightingale.—2. *a.* Like a screech-owl.

**SCREED, n.** In *plastering*, ledges of lime and hair about 6 or 8 inches wide, by which any surface about to be plastered is divided into bays or compartments. The screeds are 4, 5, or 6 feet apart, according to circumstances, and are accurately formed in the same plane by the plumb rule and straight edge. They thus form gauges for the rest of the work, and when they are ready, the panels or compartments between them are filled in flush with plaster, and a long float being made to traverse them, all the plaster which projects beyond them is struck off, and the whole surface reduced to the same plane.

**SCREED, n.** The act of rending or tearing; a rent; the sound made in rending; thing that is rent or torn off, as a *screed* of cloth. [Scotch.]

**SCREED, v. t.** [Anglo-Sax. *screadan*, to tear or rend asunder.] To rend; to tear. [Scotch.]

**SCREEN, n.** [Fr. *ecran*. This word is evidently from the root of *L. cerno, ex-cerno*, Gr. *σινω*, to separate, to sift, to judge, to fight, contend, skirmish; Sp. *harnero*, a sieve. The primary sense of the root is to separate, to drive or force asunder, hence to sift, to discern, to judge, to separate, or cut off danger.] 1. Any thing that separates or cuts off inconvenience, injury, or danger; and hence, that which shelters or protects from danger, which hides, conceals, or prevents inconvenience. In particular, a *screen* is a kind of partition, often movable, and used for concealment, for excluding cold, or light, or intercepting the heat of a fire.

Some ambitious men seem as *screens* to princes in matters of danger and envy.

Bacon.

2. A riddle or sieve, used by farmers for sifting earth or seeds. Among *builders*, a kind of wire sieve for sifting sand, lime, gravel, &c. It consists of a rectangular wooden frame with metal wires traversing it longitudinally at regular intervals. It is propped up in nearly a vertical position, and the materials to be sifted or screened are thrown against it, when the finer par-

ticles pass through and the coarser remain. A similar apparatus is used for



Builder's Screen.

separating lump coal from the small coal and dross.—3. In *arch.*, the partition that divides one part of a church from the other, as the *altar-screen*, the *organ-screen*, *monumental-screen*, &c. Screens are usually of wood, but sometimes of stone delicately carved.—4. In *ships*, the name given to pieces of canvas, or hammocks, hung round a berth for warmth and privacy.

**SCREEN, v. t.** To separate or cut off from inconvenience, injury, or danger; to shelter; to protect; to protect by hiding; to conceal; as, fruits *screened* from cold winds by a forest or hill. Our houses and garments *screen* us from cold; an *umbrella screen* us from rain and the sun's rays. Neither rank nor money should *screen* from punishment the man who violates the laws.—2. To sift or riddle; to separate the coarse part of any thing from the fine, or the worthless from the valuable.

**SCREENED, pp.** Protected or sheltered from injury or danger; sifted, as *screened* coals.

**SCREENING, n.** The act of sifting earth, seeds, sand, or lime through a large oblong sieve or screen.

**SCREENING, ppr.** Protecting from injury or danger.

**SCREW, n.** [D. *schroef*; G. *schraube*. The primary sense is probably to turn, or rather to strain.] 1. A cylinder of wood or metal, consisting of a helical ridge or groove winding round a cylinder, so as to cut every line on the surface parallel to the axis, at the same angle. The screw forms one of the six mechanical powers, and is simply a modification of the inclined plane, as may be shewn by cutting a piece of paper in the form of a right angled triangle, so as to represent an inclined plane, and applying it to a cylinder with the perpendicular side of the triangle, or altitude of the plane, parallel to the axis of the cylinder. If the triangle be then rolled about the cylinder, the hypotenuse which represents the length of the plane will trace upon the surface of the cylinder a helical line, which, if we suppose it to have thickness, and to protrude from the surface of the cylinder, will form the thread of the screw. The energy of the power applied to the screw thus formed, is transmitted by means of a hollow cylinder of equal diameter with the solid or convex one, and having a helical channel cut on its inner surface so as to correspond exactly to the thread raised upon the solid cylinder. Hence the one will

work within the other, and by turning the convex cylinder, while the other remains fixed, the former will pass through the latter, and will advance every revolution through a space equal to the distance between two contiguous threads. The convex screw is called the *male*, and the concave or hollow screw the *female screw*, or they are more frequently termed simply the screw and nut respectively. As the screw is a modification of the inclined plane, it is not difficult to estimate the mechanical advantage obtained by it. If we suppose the power to be applied to the circumference of the screw, and to act in a direction at right angles to the radius of the cylinder, and parallel to the base of the inclined plane by which the screw is supposed to be formed; then the power will be to the resistance as the distance between two contiguous threads, to the circumference of the cylinder. But as in practice, the screw is combined with the lever, and the power applied to the extremity of the lever, the law becomes: The power is to the resistance, as the distance between two contiguous threads, to the circumference described by the power. Hence the mechanical effect of the screw is increased by lessening the distance between the threads, or making them finer, or by lengthening the lever to which the power is applied. The law, however, is greatly modified by the friction, which is very great.—*Hunter's double screw*, a contrivance for increasing the power of the screw. It consists of a combination of two screws of unequal fineness, one of which works within the other, the external one being also made to play in a nut. In this case the power does not depend upon the interval between the threads of either screw, but on the difference between the intervals in the two screws. Thus, if the external screw have 20 threads in an inch, and the internal 21, then in one revolution the external screw will descend through  $\frac{1}{20}$  of an inch, and the internal will move in an opposite direction through  $\frac{1}{21}$  of an inch, so that on the whole the internal screw will be depressed  $\frac{1}{20}$  of an inch, and raised through  $\frac{1}{21}$  of an inch by the external screw, and its actual depression will consequently be the excess of  $\frac{1}{20}$  of an inch above  $\frac{1}{21}$  of an inch, that is,  $\frac{1}{420}$  of an inch. Hence it is easy to see that the power of this screw may be increased to almost any extent.—*Endless screw*, a screw combined with a wheel and axle in such a manner that the threads of the screw work into the teeth fixed on the periphery of the wheel. Such a combination may be employed for raising weights, or producing rotatory motion.—*Screw of Archimedes*. [See *ARCHIMEDES' SCREW*.]—*Micrometer screw*, a fine screw adapted to astronomical and optical instruments, for the purpose of measuring angles with great exactness; it is also used for sub-dividing a space into very minute equal parts, or for measuring minute spaces or distances.—*Screw-propeller*, an ingenious contrivance which has been recently applied with considerable success to supersede the use of paddles in the propulsion of vessels moved by steam power. A shaft furnished with broad helical arms is fitted to revolve in bearings in the dead-wood at the stern of the vessel, and is set in rapid motion

by the steam engines. This rotatory motion in the surrounding fluid, which may be considered to lie in a partially inert condition, produces, according to the well known principle of the screw an onward motion of the vessel more or less rapid, according to the velocity of the shaft, the obliquity of the arms, and the weight of the vessel. The annexed figure shows the ordinary form and position of the screw-propeller.

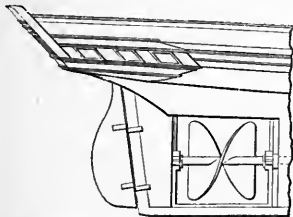

Stern of Steam Vessel with Screw Propeller.

As a mechanical power, the screw has innumerable applications; but it is employed with most effect in all cases in which a very great pressure is required to be exerted within a small space, and without intermission. Hence it is the power generally used for expressing juices from solid substances, for compressing cotton and other goods into hard dense masses for the convenience of carriage, for coining, stamping, printing, &c. Machines of this kind are called *screw presses*.—*Screw nails and wood screws*, a kind of screws very much used by carpenters and other mechanics for fastening two or more pieces of any material together. When they are small they are turned by means of an instrument called a *screw driver*.—*Screw wrench or key*, a mechanical instrument employed to turn large screws or their nuts.

**SCREW**, *v. t.* To turn or apply a screw to; to move by a screw; to press, fasten, or make firm by a screw; as, to *screw* a lock on a door; to *screw* a press.—2. To force; to squeeze; to press; to twist.—3. To oppress by exactions. Landlords sometimes *screw* and rack their tenants without mercy.—4. To deform by contortions; to distort. He *screw'd* his face into a harden'd smile.

*Dryden.*

To *screw out*, to press out; to extort.—To *screw up*, to force; to bring by violent pressure; as, to *screw up* the pins of power too high.—To *screw in*, to force in by turning or twisting.—To *screw down*, to fasten down by means of screws.

**SCREW-BOLT**, *n.* In *carpentry*, a square or cylindrical piece of iron, with a knob or flat head at the one end, and a screw at the other. It is made to pass through holes made for its reception in two or more pieces of timber, to fasten them together, by means of a nut screwed on the end that is opposite to the knob.

**SCREW'ED**, *pp.* Fastened with screws; pressed with screws; forced.

**SCREW'ER**, *n.* He or that which screws.

**SCREWING**, *ppr.* Turning a screw; fastening or pressing with a screw.

**SCREW-JACK**, *n.* A portable machine for raising great weights, as heavy carriages, &c., by the agency of a screw. [See **JACK**.]

**SCREWING-MACHINE**. A highly important implement in engineering esta-

blishments for forming the screws of bolts and nuts by means of the machinery of the factory. For this purpose tools are employed termed *taps* and *dies*, being simply counterparts in hard tempered steel of the screws to be produced, and formed with appropriate cutting edges. The motion of the machine forces the tap to penetrate the nut, and so form the screw in it, while the bolt is screwed by simply inverting this process, using the dies instead of the tap.

**SCREW-PINE**, *n.* [Malay, *Pandang*, *i. e.* something to be regarded.] Pandanus, a genus of plants which forms the type of the nat. order Pandanaceæ. [See **PANDANUS**.] The screw-pines are trees which grow in the East Indies,



Screw-pine (Pandanus odoratissimus).

the Isle of Bourbon, Mauritius, New South Wales, and Guinea. The trees have great beauty, and some of them an exquisite odour; and their roots, leaves, and fruit are all found useful for various purposes. Screw-pines are remarkable for the peculiar roots they send out from various parts of the stem. These roots are called *aërial* or *adventitious*, and serve to support the plant.

**SCREW-PLATE**, *n.* A thin plate of steel having a series of holes with internal screws, used in forming small external screws.

**SCREW-TAP**, *n.* The cutter by which an internal screw is produced.

**SCREW-TREE**, *n.* Helicteres, a genus of plants, of several species, natives of warm climates. They are shrubby plants, with yellow flowers, and capsules intorted or twisted inward. [See **HELICTERES**.]

**SCRIBATIOUS**, *a.* Prone to write. [Collog.]

**SCRIB'BLE**, *v. t.* [*L. scribillo*, dim. of *scribo*, to write, *W. ysgrivaw*. See **SCRIBE**.] 1. To write with haste, or without care or regard to correctness or elegance; as, to *scribble* a letter or pamphlet.—2. To fill with careless or worthless writing.

**SCRIB'BLE**, *v. i.* To write without care or beauty.

If *Mævius scribble* in Apollo's spite. *Pope*.  
**SCRIB'BLE**, *n.* Hasty or careless writing: a writing of little value; as, a hasty *scribble*.

**SCRIB'LED**, *pp.* Written hastily and without care.

**SCRIB'BLER**, *n.* A petty author; a writer of no reputation.

The *scribbler* pinch'd with hunger, writes to dine. *Granville*.

**SCRIB'BLING**, *ppr.* or *a.* Writing hastily and without care.

**SCRIB'BLINGLY**, *adv.* In a scribbling way.

**SCRIBE**, *n.* [Fr. from *L. scriba*, from *scribo*, to write; formed probably on the root of *grave*, *scrape*, *scrub*; *D. schryven*; *G. schreiben*; *W. ysgrivaw*, *ysgrivenu*, whence *scrivener*; *Fr. ecrire*, *ecrivant*; *Gr. γραφω*: *Ir. grafadh*, to write, and *sgriobam*, *sgrabam*, to scrape, engrave, or write. The first writing was probably engraving on wood or stone.] 1. In a general sense, a writer. Hence,—2. A notary; a public writer.

—3. In ecclesiastical meetings and associations in America, a secretary or clerk; one who records the transactions of an ecclesiastical body.—4. In *Scripture* and the *Jewish history*, a clerk or secretary to the king. *Seraiah* was *scribe* to King David; 2 Sam. viii.

—5. An officer who enrolled or kept the rolls of the army, and called over the names and reviewed them; 2 Ch. xxvi; 2 Kings xxv.—6. A writer and a doctor of the law; a man of learning; one skilled in the law; one who read and explained the law to the people; *Ezra* vii.—7. Among *bricklayers*, a spike or large nail ground to a sharp point, to mark the bricks on the face and back by the tapering edges of a mould, for the purpose of cutting them and reducing them to the proper taper for gauged arches.

**SCRIBE**, *v. t.* To mark by a rule or compasses; to mark so as to fit one piece to another; a term used by *carpenters and joiners*.

**SCRIBED**, *pp.* Marked or fitted to another surface.

**SCRIBING**, *n.* In *joinery*, the fitting of the edge of a board to another board in the same plane as the edge. Also, in joiner's work, the fitting one piece of wood to another so that their fibres may be respectively at right angles.

**SCRIBER**, *v. i.* To move or glide swiftly along. [*Scotch*.]

**SCRIMMER**, *n.* [Fr. *escrimeur*. See **SKIRMISH**.] A fencing-master.

**SCRIMP**, *v. t.* [*Sw. skrumpen*, shriveled; *Teut. krimpfen*, to contract; *Ger. schrumpfen*, to pinch.] To straiten; to deal sparingly with one in regard to food, clothes, or money; to limit, to straiten in a general sense. [*Scotch*.]

**SCRIMP**, *a.* Scanty; narrow; deficient; contracted. [*Scotch*.]

**SCRIMP'PIT**, *a.* The same as *scrimp*,—*which see*. [*Scotch*.]

**SCRINE**, *n.* [*L. scrinium*; *Norm. escrin*; probably from *L. cerno*, *secerno*.] A shrine; a chest, book-case, or other place where writings or curiosities are deposited. [See **SHRINE**, which is generally used.]

**SCRINGE**, *v. i.* To cringe, of which this word is a corruption.

**SCRIP**, *n.* [*W. ysgrap*, *ysgrepan*, something puckered or drawn together, a wallet, a scrip; *Sw. skräppa*. This belongs to the root of *gripe*, our vulgar *grab*, that is, to seize or press.] A small bag; a wallet; a satchel. David put five smooth stones in a *scrip*; 1 Sam. xvii; *Matth.* x.

**SCRIP**, *n.* [*L. scriptum*, *scriptio*, from *scribo*, to write.] A small writing, certificate, or schedule; a piece of paper containing a writing.

Bills of exchange cannot pay our debts abroad, till *scrips* of paper can be made current coin. *Locke*.

2. An interim writing entitling a party to a share or shares in any company, or to an allocation of stock in general, which interim writing, or *scrip*, is exchanged after registration for a formal certificate.

SCRIP PAGE, † *n.* That which is contained in a scrip.

SCRIPT, *n.* 1. † A scrip or small writing. —2. In printing, type resembling manuscript.

SCRIP TORY, *a.* [*L. scriptorius*. See SCRIBE.] Written; expressed in writing; not verbal. [*Little used.*]

SCRIPTURAL, *a.* [from *Scripture*.] Contained in the Scriptures, so called by way of eminence, that is, in the Bible; as, a *scriptural* word, expression, or phrase. —2. According to the Scriptures; as a *scriptural* doctrine.

SCRIPTURALIST, *n.* One who adheres literally to the Scriptures and makes them the foundation of all philosophy.

SCRIPTURE, *n.* [*L. scriptura*, from *scribo*, to write.] 1. In its primary sense, a writing; any thing written. —2. Appropriately, and by way of distinction, the books of the Old and New Testament; the Bible. The word is used either in the singular or plural number, to denote the sacred writings or divine oracles, called *sacred* or *holy*, as proceeding from God and containing sacred doctrines and precepts.

There is not any action that a man ought to do or forbear, but the *Scriptures* will give him a clear precept or prohibition for it.

*South.*

Compared with the knowledge which the *Scriptures* contain, every other subject of human inquiry is vanity and emptiness.

*Buckminster.*

SCRIP TURIST, *n.* One well versed in the Scriptures.

SCRIVENER, *n.* [*W. ysgrivener*, from *ysgrivenu*, to write; *Fr. scrivain*. See SCRIBE.] 1. Formerly, a writer; one whose occupation was to draw contracts or other writings. —2. One whose business is to place money at interest.

SCROBICULATE, or SCROBICULATED, *a.* [*L. scrobiculus*, from *scrobs*, a furrow.] In *nat. hist.*, furrowed; having small ridges and furrows.

SCROFULA, *n.* [*L.* In *G. kropf* is *crop*, *craw*, and *scrofula*. In *D.* it is *kropzeer*, neck-sore.] A disease, consisting in hard indolent tumours of the conglobate glands in various parts of the body, but particularly in the neck, behind the ears and under the chin, which after a time suppurate and degenerate into ulcers, from which, instead of pus, a white curdled matter is discharged. Scrofula is not contagious, but it is often a hereditary disease; its first appearance is most usually between the third and seventh year of the child's age, but it may arise between this and the age of puberty; after which it seldom makes its first attack. It is promoted by every thing that debilitates, but it may remain dormant through life and not shew itself till the next generation. In mild cases the glands, after having suppurated, slowly heal; in others, the eyes and eyelids become inflamed, the joints become affected, the disease gradually extending to the ligaments and bones, and producing a hectic and debilitated state under which the patient sinks; or it ends in tuberculated lungs and pulmonary

consumption. It is more properly called *struma*. The popular name *king's-evil* is applied to this disease only when it is seated in glands.

SCROFULOUS, *a.* Pertaining to scrofula, or partaking of its nature; as, *scrofulous* tumours; a *scrofulous* habit of body. —2. Diseased or affected with scrofula.

*Scrofulous* persons can never be duly nourished. *Arbutnoli.*

SCROFULOUSLY, *adv.* In a scrofulous manner.

SCROG, *n.* [*Sax. scrobb*, a shrub.] A stunted bush or shrub. In the plural, small branches of trees broken off. [*Scotch.*]

SCROGGY, or SCROGGIE, *a.* Stunted; abounding with stunted bushes or brushwood. [*Scotch.*]

SCROLL, *n.* [probably formed from *roll*, or its root; *Fr. ecroue*, a contracted word, whence *escrow*.] A roll of paper or parchment; or a writing formed into a roll.

Here is the *scroll* of every man's name.

*Shak.*

The heavens shall be rolled together as a *scroll*; *Is. xxxiv.*

2. In *arch.*, a name given to a large class of ornaments characterized generally by their resembling a narrow band arranged in convolutions or undulations. —3. In *her.*, part of the outward ornaments of the shield, achievement, or escutcheon of arms in which the motto is inscribed. —4. A rounded mark, added to a person's name, in signing a paper. On some estates it has the effect of a seal, though not generally. [*American.*]

SCROPHULARIA, *a.* A genus of plants, the species of which are known by the common name of figwort. [*See FIGWORT.*]

SCROPHULARIACEÆ, *n.* [*Scrophularia*, one of the genera.] A nat. order of herbaceous, or shrubby monopetalous exogens, inhabiting all parts of the world except the coldest. They are generally acrid bitterish plants. The leaves and roots of *scrophularia aquatica*, and perhaps *nodosa*, of *gratiola officinalis*, and *peruviana*, and of *calceolaria*, act as purgatives, and even emetics. In digitalis, this quality is so much increased that its effects become dangerous. Many of the genera, such as digitalis, calceolaria, &c., are valued by gardeners for their beautiful flowers.

SCROTAL, *a.* Pertaining to the scrotum; as, *scrotal* hernia, which is a protrusion of any of the contents of the abdomen into the scrotum.

SCROTIFORM, *a.* [*L. scrotum*.] In *bot.*, formed like a double bag; as the nectary in plants of the genus *Satyrinum*.

SCROTOCELE, *n.* [*L. scrotum*, and *Gr. κελη*, a tumour.] A scrotal hernia.

SCROTUM, *n.* The bag which contains the testicles.

SCROYLE, † *n.* [In *Fr. érouelles*, the king's evil; or *D. schraal*, thin, lean, meagre.] A mean fellow; a wretch.

SCRUB, *v. t.* [*Sw. skrubba*, to scrub, to rebuke; *G. schrubben*.] This word is probably formed on *rub*, or its root, and perhaps *scrape*, *L. scribo*, may be from the same radix; *Ir. scriobam*.] To rub hard, either with the hand or with a cloth or an instrument; usually, to rub hard with a brush, or with something coarse or rough, for the purpose of cleaning, scouring, or mak-

ing bright; as, to *scrub* a floor; to *scrub* a deck; to *scrub* vessels of brass or other metal.

SCRUB, *v. i.* To be diligent and penurious; as, to *scrub* hard for a living.

SCRUB, *n.* A mean fellow; one that labours hard and lives meanly. —2. Something small and mean.

No little *scrub* joint shall come on my board. *Swift.*

3. A worn out brush; or stunted broom.

SCRUBBED, *pp.* Rubbed hard.

SCRUBBED, } *a.* Small and mean;  
SCRUBBY, } vile; worthless; insignificant; stunted in growth; as, a *scrubbed* boy; a *scrubby* cur; a *scrubby* tree.

SCRUBBING, *ppr.* Rubbing hard.

SCRUBSTONE, *n.* A provincial term for a species of calciferous sandstone.

SCRUB, for *Scurf*, not in use.

SCRUPLE, *n.* [*Fr. scrupule*, from *L. scrupulus*, a doubt; *scrupulum*, the third part of a dram, from *scrupus*, a chessman; probably a piece, a small thing, from *scraping*, like *scrap*.] *Scrupulus* was primarily a little stone or piece of gravel; and as one of such in a shoe hurts the foot, it is supposed that this, like a short stop or finching, gave rise to the sense of *doubting*, which gives pain.] 1. Doubt; hesitation from the difficulty of determining what is right or expedient; backwardness; reluctance to decide or to act. A man of fashionable honour makes no *scruple* to take another's life, or expose his own. He has no *scruples* of conscience, or he despises them. —2. A weight of twenty grains, or the twenty-fourth part of an ounce, in the apothecaries' division of the Troy pound. —3. Proverbially, a very small quantity. —4. In *Chaldean chronology*, the  $\frac{1}{30}$  part of an hour; a division of time used by the Jews, Arabs, &c. —5. Among the *older astronomers*, a digit. —*Scruple of half duration*, an arch of the moon's orbit, which the moon's centre describes from the beginning of an eclipse to the middle. —*Scruples of immersion or incidence*, an arch of the moon's orbit, which her centre describes from the beginning of the eclipse to the time when its centre falls into the shadow. —*Scruples of emersion*, an arch of the moon's orbit, which her centre describes in the time from the first emersion of the moon's limb to the end of the eclipse.

SCRUPLE, *v. i.* To doubt; to hesitate.

He *scrupled* not to eat,

Against his better knowledge. *Milton.*

SCRUPLE, *v. t.* To doubt; to hesitate to believe; to question; as, to *scruple* the truth or accuracy of an account or calculation. [*Little authorized.*]

SCRUPLED, *pp.* Doubted; questioned.

SCRUPLER, *n.* A doubter; one who hesitates.

SCRUPLING, *ppr.* Doubting; hesitating; questioning.

SCRUPULIZE, *v. t.* To perplex with scruples of conscience.

SCRUPULOSITY, *n.* [*L. scrupulositas*.] 1. The quality or state of being scrupulous; doubt; doubtfulness respecting some difficult point, or proceeding from the difficulty or delicacy of determining how to act; hence, the

caution or tenderness arising from the fear of doing wrong or offending.

The first sacrilege is looked upon with some horror; but when they have once made the breach, their *scrupulosity* soon retires. *Decay of Piety.*

2. Nicety of doubt; or nice regard to exactness and propriety.

So careful, even to *scrupulosity*, were they to keep their sabbath. *South.*

3. Niceness; preciseness.  
**SCRUPULOUS**, *a.* [L. *scrupulosus*; Fr. *scrupuleux*.] 1. Nicely doubtful; hesitating to determine or to act; cautious in decision from a fear of offending or doing wrong. Be careful in moral conduct, not to offend *scrupulous* brethren.—2. Given to making objections; captious.

Equality of two domestic powers Breeds *scrupulous* faction. *Shak.*

3. Nice; doubtful.  
 The justice of that cause ought to be evident; not obscure, not *scrupulous*.  
*Bacon.*

4. Careful; cautious; exact in regarding facts.—5. Nice; exact; as, a *scrupulous* abstinence from labour.

**SCRUPULOUSLY**, *adv.* With a nice regard to minute particulars or to exact propriety.

The duty consists not *scrupulously* in minutes and half hours. *Taylor.*

Henry was *scrupulously* careful not to ascribe the success to himself. *Addison.*

**SCRUPULOUSNESS**, *n.* The state or quality of being *scrupulous*; niceness, exactness, or caution in determining or in acting, from a regard to truth, propriety, or expediency.

**SCRUTABLE**, *a.* [See **SCRUTINY**.] Discoverable by inquiry or critical examination.

**SCRUTATION**, *n.* Search; scrutiny.

**SCRUTATOR**, *n.* [L. from *scrutor*.] One that scrutinizes; a close examiner or inquirer. [*Little used.*]

**SCRUTINEER**, *n.* One who scrutinizes; one who examines votes.

**SCRUTINIZE**, *v. t.* [from *scrutiny*.] To search closely; to examine or inquire into critically; as, to *scrutinize* the measures of administration; to *scrutinize* the private conduct or motives of individuals.

**SCRUTINIZED**, *pp.* Examined closely.

**SCRUTINIZER**, *n.* One who examines with critical care.

**SCRUTINIZING**, *ppr.* Inquiring into with critical minuteness or exactness; searching closely.

**SCRUTINOUS**, *a.* Closely inquiring or examining; captious.

**SCRUTINY**, *n.* [Fr. *scrutin*; Low L. *scrutinium*, from *scrutor*, to search closely, to pry into; Sax. *scrudnian*; Ir. *scrudam*.] 1. Close search; minute inquiry; critical examination; as, a *scrutiny* of votes; narrower *scrutiny*. In the heat of debate, observations may escape a prudent man which will not bear the test of *scrutiny*.—2. In the primitive church, an examination of catechumens in the last week of Lent, who were to receive baptism on Easter-day. This was performed with prayers, exorcisms and many other ceremonies.—3. In the canon law, a ticket or little paper billet on which a vote is written.—4. In *parliamentary language*, an examination of the votes given at an election by an election committee, at which the bad votes given on both sides are rejected, and the poll corrected accordingly, is called a *scrutiny*.

**SCRUTINY**, *v. t.* To scrutinize.  
**SCRUTOIRE**, *n.* (scroo-twz'r.) [Fr. *escritoire*, from *ecrire*, to write. See **SCRIBE**.] A kind of desk, case of drawers or cabinet, with a lid opening downward for the convenience of writing on it.

**SCRÜZE**, *v. t.* To crowd; to squeeze. [*A low word of local use.*]

**SCUD**, *v. i.* [This is *shoot*, or from the same root; Dan. *skyder*, to shoot; *skul*, a shot; Sw. *shudda*, to throw or pour out; Sax. *scootan*, to shoot, to flee or haste away; W. *usgwdu*, to push or thrust; *ysgudaw*, *ysguthaw*, to whisk, to scud, to whirl about. See **SHOOT**.] 1. In a general sense, to be driven or to flee or fly with haste.

In seamen's language, to be driven with precipitation before a tempest. This is done with a sail extended on the foremast of the ship, or when the wind is too violent, without any sail set, which is called *scudding under bare poles*.—2. To run with precipitation; to fly.

**SCUD**, *n.* Among *seamen*, a low thin cloud, or thin clouds, driven swiftly by the wind.—2. A driving along; a rushing with precipitation.

**SCUDDING**, *ppr.* Driving or being driven before a tempest; running with fleetness.

**SCUDLE**, *v. i.* To run with a kind of affected haste; commonly pronounced *scuttle*. [*A low word.*]

**SCUDO**, *n.* A money of account, and also a gold and silver coin in different parts of Italy, and of different values. At Rome the silver scudo is 4s. 3.87d. and the gold scudo, 64s. 11.43d.

**SCUFFLE**, *n.* [This is a different orthography of *shuffle*; from *shove*, or its root; Sw. *shuff*, a push; *shuffa*, to push, thrust, shove; Dan. *shuffe*, a drawer, a scoop, a shovel; *shuffer*, to shuffle, to cheat; D. *schuiven*, to shove, push or draw; G. *schieben*.] A confused quarrel or contest in which the parties struggle blindly, or without direction; a tumultuous struggle for victory or superiority; a fight.

The dog leaps upon the serpent and tears it to pieces; but in the *scuffle*, the cradle happened to be overturned.

*L'Estrange.*

**SCUFFLE**, *v. i.* To strive or contend tumultuously, as small parties; to fight confusedly.

A gallant man prefers to fight to great disadvantages in the field, in an orderly way, rather than to *scuffle* with an undisciplined rabble. *K. Charles.*

**SCUFFLER**, *n.* One who scuffles.—2. In *agriculture*, a kind of horse-hoe.

**SCUFFLING**, *ppr.* Struggling or contending without order.

**SCUG**, *v. t.* [Dan. *skygger*, to shade; Sw. *shugga*, a shade.] To hide; to shelter. [*Scotch.*]

**SCULK**, *v. i.* [Dan. *shiuler*; D. *schuilen*, to hide, shelter, sculk; the Eng. *shelter*. It is also written *skulk*.] To retire into a close or covered place for concealment; to lurk; to lie close from shame, fear of injury or detection.

**SCULK'ER**, *n.* A lurker; one that lies close for hiding.

**SCULK'ING**, *ppr.* Withdrawing into a close or covered place for concealment; lying close.

**SCULL**, *n.* The brain-pan. [See **SKULL**.] 2. A boat; a cock boat. [See **SCULLER**.] 3. One who sculls a boat. But properly,—4. A short oar,

whose loom is only equal in length to half the breadth of the boat to be rowed, so that one man can manage two, one on each side. More generally an oar placed over the stern of a boat, and worked from side to side; the blade, which is turned diagonally, being always in the water. In China, boats are impelled by a single scull with considerable velocity.—5. † A shoal or multitude of fish. [Sax. *scole*.]

**SCULL**, *v. t.* To impel a boat by moving and turning an oar over the stern.

**SCULL'-CAP**. See **SKULL-CAP**.

**SCULL'ED**, *pp.* Impelled by turning an oar over the stern.

**SCULL'ER**, *n.* A boat rowed by one man with two sculls or short oars.—2. One that sculls, or rows with sculls; one that impels a boat by an oar over the stern.

**SCULL'ERY**, *n.* [probably from the root of *shell*, *scale*, Fr. *écuelle*; Scot. *skul*, *skoll*, a bowl; Dan. *shaal*, a drinking cup; *shal*, a *shell*, *skull*; G. *schale*, *scale*, a *shell*, a dish or cup. *Shulls* and *shells* were the cups, bowls, and dishes of rude men.] A place where dishes, kettles, and other culinary utensils are cleaned and kept.

**SCULL'ING**, *ppr.* Impelling a boat by an oar.

**SCULL'ION**, *n.* [Ir. *squille*, from the root of the preceding.] A servant that cleans pots and kettles, and does other menial services in the kitchen or scullery.

**SCULL'IONLY**, *† a.* Like a scullion; base; low; mean.

**SCULP**, *v. t.* [L. *sculpo*, *scalpo*. Qu. Gr.  $\sigma\kappa\upsilon\lambda\omicron$ ; root  $\sigma\kappa\lambda$  *galaf* or *gall*, L. *calvus*.] To carve; to engrave.

**SCULP'TILE**, *a.* [L. *sculptilis*.] Formed by carving; as, *sculptile* images.

**SCULP'TOR**, *n.* [L. See **SCULP**.] One whose occupation is to carve wood, stone, or other materials into images; a carver.

**SCULP'TURAL**, *a.* Pertaining to sculpture or engraving.

**SCULP'TURE**, *n.* [Fr.; L. *sculptura*.] 1. The art of carving, cutting, or hewing wood, stone, or other materials into images of men, beasts, or other things. The origin of sculpture is so remote that all attempts to trace it have been fruitless. It was brought to great perfection among the ancient Greeks by Phidias, Praxiteles, and Lysippus. During the dark ages it fell into decline, but revived again in Italy in the 14th century, and advanced to the highest degree of excellence.—*Sculpture* is a generic term, including carving or statuary and engraving; although engraving is generally considered a distinct art. Sculpture also includes the moulding of casts in clay, and the founding of brazen or bronze statues.—2. Carved work; any work of sculpture.

There too, in living *sculpture*, might be seen

The mad affection of the Cretan queen. *Dryden.*

3. The art of engraving on copper.

**SCULP'TURE**, *v. t.* To carve; to engrave; to form images or figures with the chisel on wood, stone, or metal.

**SCULP'TURED**, *pp.* Carved; engraved; as, a *sculptured* vase; *sculptured* marble.

**SCULP'TURES**, *n.* Figures cut in stone, metal, or other solid substance, representing or describing some real

or imaginary object. [See SCULPTURE.]

SCULPTURING, *ppr.* Carving; engraving.

SCUM, *n.* [Fr. *ecume*; Sw. and Dan. *skum*; G. *schaum*.] 1. The extraneous matter or impurities which rise to the surface of liquors in boiling or fermentation, or which form on the surface by other means. The word is also applied to the scoria of metals.—2. The refuse; the recement; that which is vile or worthless.

The great and the innocent are insulted by the *scum* and refuse of the people.

*Addison.*

SCUM, *v. t.* To take the scum from; to clear off the impure matter from the surface; to skim.

You that *scum* the molten lead. *Dryden.*

SCUMBER, *n.* The dung of the fox.

SCUMBLE, *v. t.* In oil painting, thinly to spread or rub opaque or semi-opaque colours over other colours, to modify the effect.

SCUMBLING, *n.* Colours spread over others to modify the effect; or, the act of spreading such colours.

SCUMMED, *pp.* Cleared of scum; skimmed.

SCUMMER, *n.* [Fr. *ecumoire*.] An instrument used for taking off the scum of liquors; a skimmer.

SCUMMING, *ppr.* Clearing of scum; skimming.

SCUMMINGS, *n. plur.* The matter skimmed from boiling liquors; as, the *scummings* of the boiling-house.

SCUNNER, *v. i.* [Anglo-Sax. *onscunian*, to loathe.] To loathe; to nauseate; to startle at any thing from doubtfulness of mind; to shrink back from fear. [*Scotch.*]

SCUNNER, *n.* Loathing; abhorrence. [*Scotch.*]

SCUPPER, *n.* [Sp. *escupir*, to spit, to eject, to discharge.] The scuppers or scupper-holes of a ship, are channels cut through the water ways and sides at proper distances, and lined with lead for carrying off the water from the deck.

SCUPPER-HOSE, *n.* A leathern pipe attached to the mouth of the scuppers of the lower deck of a ship, to prevent the water from entering.

SCUPPER-NAIL, *n.* A nail with a very broad head for covering a large surface of the hose.

SCUPPER-PLUG, *n.* A plug to stop a scupper.

SCURF, *n.* [Sax. *scurf*; G. *schorf*; L. *scorbutus*. In D. *scheuren* is to rend or crack, and *scheurbuik* is scurvy, Dan. *skjörbug*, from *skjör*, brittle. In Ir. *gearbh* is rough. It is named from breaking or roughness.] 1. A material composed of minute portions of the dry external scales of the cuticle. These are, in moderate quantity, continually separated by the friction to which the surface of the body is subject, and are in due proportion replaced by others deposited on the inner surface of the cuticle. Small exfoliations of the cuticle, or scales like bran, occur naturally on the scalp, and take place after some eruptions on the skin, a new cuticle being formed underneath during the exfoliation. When scurf separates from the skin or scalp in unnatural quantities, it constitutes the disease called *Pityriasis*, which, when it affects children, is known by the name of dandruff.—2. The soil or foul remains of any thing

adherent; as, the *scurf* of crimes. [Not common or elegant.]—3. Any thing adhering to the surface.

There stood a hill, whose grisly top  
Shone with a glossy scurf. *Milton.*

SCURFF, *n.* Another name for the bull-troat.

SCURFINESS, *n.* The state of being scurfy.

SCURFY, *a.* Having scurf; covered with scurf.—2. Covered with scales resembling scurf.

SCURRILE, *a.* [L. *scurrilis*, from *scurra*, a buffoon; G. *scheren*, D. *scheeren*, to jeer.] Such as befits a buffoon or vulgar jester; low; mean; grossly opprobrious in language; scurrilous; as, *scurrile* jests; *scurrile* scoffing; *scurrile* taunts.

SCURRILITY, *n.* [L. *scurrilitas*; Fr. *scurrité*.] Such low, vulgar, indecent or abusive language as is used by mean fellows, buffoons, jesters, and the like; grossness of reproach or invective; obscene jests, &c.

Banish *scurrility* and profaneness.

*Dryden.*

SCURRILOUS, *a.* Using the low and indecent language of the meaner sort of people, or such as only the license of buffoons can warrant; as, a *scurriulous* fellow.—2. Containing low indecency or abuse; mean; foul; vile; obscenely jocular; as, *scurriulous* language.

SCURRILOUSLY, *adv.* With gross reproach; with low indecent language.

It is barbarous incivility, *scurriously* to sport with what others count religion.

*Tillotson.*

SCURRILOUSNESS, *n.* Indecency of language; vulgarity; baseness of manners.

SCURVILY, *adv.* [from *scurvy*.] Basely; meanly; with coarse and vulgar incivility.

The clergy were never more learned, or so *scurvily* treated. *Swift.*

SCURVINESS, *n.* [from *scurvy*.] The state of being scurfy.

SCURVY, *n.* [from *scurf*; *scurvy* for *scurfy*; Low L. *scorbutus*.] A disease characterized by livid spots of various sizes, sometimes minute and sometimes large, and occasioned by extravasation of blood under the cuticle, paleness, languor, lassitude, and depression of spirits, general exhaustion, pains in the limbs, occasionally with fetid breath, spongy and bleeding gums, and bleeding from almost all the mucous membranes. It is much more prevalent in cold climates than in warm, and chiefly affects sailors during long voyages, and such as are shut up in besieged places, being occasioned by confinement, in-nutritious food, and hard labour in conjunction; but more especially by confinement for a long period of time, to a limited range of food, which is incapable of supplying the elements necessary to repair the waste of the system. Fresh vegetables, farinaceous substances, and brisk fermented liquors, good air, attention to cleanliness, and due exercise, are among the principal remedies. This disease has been called *purpura* by some nosologists, but by Good it is more appropriately styled *porphyra*.

SCURVY, *a.* Scurfy; covered or affected by scurf or scabs; scabby; diseased with scurvy.—2. Vile; mean;

low; vulgar; worthless; contemptible; as, a *scurvy* fellow.

He spoke *scurvy* and provoking terms.

*Shak.*

That *scurvy* custom of taking tobacco.

*Swift.*

SCURVY-GRASS, *n.* The common name of several British species of plants of the genus *Cochlearia*; class and order *Tetradynamia siliculosa*, Linn.; nat. order *Cruciferae*. They are herbaceous plants, having alternate leaves, the flowers disposed in terminal racemes, and usually white. The common scurvy grass, *C. officinalis*, grows abundantly on the sea coast, and along rivers near the sea. The leaves have an acrid and slightly bitter taste; they are eaten as a salad, and are antiscorbatic and stimulating to the digestive organs.

SCUSES, for *Excuses*.

SCUT, *n.* [Ice. *skott*; W. *cwt*, a tail or rump; *cwta*, short.] The tail of a hare or other animal whose tail is short.

SCUTAGE, *n.* [Law L. *scutagium*, from *scutum*, a shield.] In *English history*, a tax or contribution levied upon those who held lands by knight service; originally, a composition for personal service which the tenant owed to his lord, but afterward levied as an assessment.

SCUTATE, *a.* [L. *scutum*, a shield.] 1. In *bot.*, formed like an ancient round buckler.—2. In *zool.*, applied to a surface protected by large scales.

SCUTCH, *v. t.* [Eng. *scotch*, to cut, to strike.] To beat off the woody parts of the stalks of flax which adhere to the fibres, by means of an instrument called a scutcher. Previous to the operation of scutching, the stalks are broken by an instrument termed a brake, while the scutching prepares it for heckling. The operations of breaking and scutching, where large quantities of flax are required, are performed by means of a mill. In the *Scottish dialect*, to *scutch*, signifies to beat; to drub.

SCUTCHEON, *n.* [A contraction of *Escutcheon*,—which see.] A shield for armorial bearings.—2. In *ancient arch.*, the shield or plate on a door, from the centre of which hung the door handle.—3. The ornamental bit of brass plate perforated with a key-hole, and placed over the key-hole of a piece of furniture.

SCUTCHER, *n.* An implement for separating hemp or flax from the stalk.

SCUTCHING, *n.* The process of separating hemp or flax from the woody stalk of the plant into distinct fibres, by means of a scutcher.

SCUTCHING MACHINE, *n.* A machine for beating off the woody parts of flax preparatory to its being heckled. The same machine also breaks the stalks.

SCUTE, *n.* [L. *scutum*, a buckler.] A French gold coin of 3s. 4d. sterling.

SCUTELLARIA, *n.* A genus of herbaceous perennials, natives of many different parts of the world. Class and order *Didynamia gymnospermia*, Linn.; nat. order *Labiatae*. There are two British species, *S. galericulata*, and *S. minor*, known by the common name of skull-cap. They grow on the banks of rivers and lakes, and in watery places.

SCUTELLATED, *a.* [L. *scutella*, a dish. See *SCUTLE*.] Formed like a pan; divided into small surfaces; as, the *scutellated* bone of a sturgeon.

SCUTELLUM, *n.* [L. *scutum*.] In *bot.*,

a term used to denote the small cotyledon on the outside of the embryo of wheat, inserted a little lower down than the other more perfect cotyledon, which is pressed close to the albumen. **SCUTIBRANCHIATA**, *n.* [*L. scutum*, and *branchia*, gills.] The name given by Cuvier to an order of hermaphrodite Gastropodous molluscs, including those which have the gills covered with a shell in the form of a shield; as the *Haliotis* of Linn.

**SCUTIBRANCHIATE**, *a.* Pertaining to the order *scutibranchiata*.

**SCUTIFORM**, *a.* [*L. scutum*, a buckler, and *form*.] Having the form of a buckler or shield.

**SCUTIPED**, *n.* [*L. scutum*, a buckler, *pes*, foot.] One of a family of birds which have the anterior part of the legs covered with segments of horny rings, terminating on each side in a groove.

**SCUTTLE**, *n.* [*L. scutella*, a pan or saucer; *W. ysgudell*; *Sax. scutel*, *scuttel*, a dish.] A broad shallow basket; so called from its resemblance to a dish. —2. A metal pan or pail for holding coals.

**SCUTTLE**, *n.* [*Fr. écoutille*; *Arm. scouth*; *Sp. escotilla*; *Sax. scyttel*, a bolt or bar; *scyttan*, to bolt, to shut. See *SHUT*.] 1. In ships, a small hatchway or opening in the deck, large enough to admit a man, and with a lid for covering it; also, a like hole in the side of a ship, and through the coverings of her hatchways, &c. —2. A square hole in the roof of a house, with a lid.

3. [from *scud*, and properly *scuddle*.] A quick pace; a short run. [*Vulgar.*]

**SCUTTLE**, *v. i.* To run with affected precipitation. [*Vulgar.*]

**SCUTTLE**, *v. t.* [from the noun.] To cut large holes through the bottom or sides of a ship for any purpose.—*To scuttle the decks*, to cut holes to let the water down from thence into the hold, as in the case of shipping a heavy sea, or of fire. —2. To sink by making holes through the bottom; as, to *scuttle* a ship.

**SCUTTLE-BUTT**, *n.* A butt or cask

**SCUTTLE-CASK**, *n.* with a large hole in it, used to contain the fresh water for daily use in a ship or other vessel.

**SCUTTLED**, *pp.* Having holes made in the bottom or sides; sunk by means of cutting holes in the bottom or sides.

**SCUTTLE-FISH**, *n.* The cuttle-fish so called. [See *CUTTLE-FISH*.]

**SCUTTLING**, *ppr.* Cutting holes in the bottom or sides; sinking by such holes.

**SCUTUM**, *n.* [*L.*] The shield of the

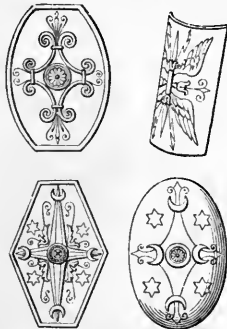

Various forms of the Roman Scutum.

heavy armed Roman legionaries. It was made of wood, covered with leather, and

defended with plates of iron. It was either oval or of a semi-cylindrical shape, and had an iron boss jutting out in the middle.—2. A species of Echinite.

**SCYLLE'RIANS**, *n.* A tribe of macrurous decapod crustaceans, distinguished by the singular conformation of the external antennæ, which are converted into a large flattened and horizontal crest, with the sides deeply notched.

**SCYMITAR**, *n.* A short sword with a convex blade. [See *SCIMITAR*.]

**SCYPHIFORM**, *a.* [*Gr. σκυφος*, and *form*.] Goblet-shaped; as the fructification of some of the lichens.

**SCYPHUS**, *n.* [*Gr. σκυφος*, a cup or goblet.] The cup of a narcissus. Also, in lichens, a cup-like dilatation of the podetium or stalk-like elongation of the thallus, bearing shields upon its margin.

**SCYTHE**, *n.* [*Sax. sithe*; *D. seissen*; *Ar. hatzada*, to reap; deriv. *Ar.* a sickle; *Eth. atzad*, to reap, and deriv. a sickle; *Heb. and Ch. מַטְזָד*, *matzad*, from the same root, an axe. These verbs seem to be the same, with different prefixes, and from this evidently is derived *scythe*.] 1. An instrument for mowing grass, or cutting grain or other vegetables. It consists of a long curving blade with a sharp edge, made fast to a handle, and which is bent into a convenient form for swinging the blade to advantage. The blade is fixed to the handle, at an angle both to the plane of the blade and to the tangent to the curve of the blade. It is on the adjustment of these angles that the perfection of the instrument depends. Most scythes have two projecting handles fixed to the principal handle, by which they are held. The real line of the handle is that which passes through both the hands, and ends at the head of the blade. This may be a straight line or a crooked one, generally the latter, and by moving these handles up or down the main handle, each mower can place them so as best suits the natural size

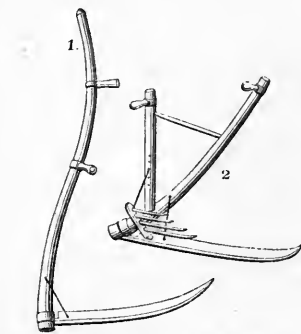

Fig. 1. Common Scythe. Fig. 2. Cradle Scythe.

and position of his body. For laying the cut corn evenly, a scythe with the addition of a cradle, as it is called, is used. The cradle is a species of comb, with three or four long teeth parallel to the back of the blade, and fixed in the handle. The Hainault scythe is a scythe used with only one hand, and is employed when the corn is much laid and entangled. The person has a hook in one hand with which he collects a small bundle of the straggling corn, and with the scythe in the other hand

cuts it. Another species of scythe, much used in Aberdeenshire, has a short branching handle somewhat in the shape of the letter Y, having two small handles fixed at the extremities of the two branches at right angles to the plane in which they lie. In *mythol.*, Saturn or Time is represented with a scythe, the emblem of destruction.—2. The curved sharp blade used anciently in war chariots.

**SCYTHE**, *† v. t.* To mow.

**SCYTHED**, *a.* Armed with scythes, as a chariot.

**SCYTHEMAN**, *n.* One who uses a scythe; a mower.

**SCYTHIAN**, *a.* Pertaining to Scythia, a name given to the northern part of Asia, and Europe adjoining to Asia.

**SCYTHIAN**, *n.* [See *SCOT*.] A native of Scythia.

**SDAIN**, *†* for *Disdain*. [It. *sdegnare*.]

**SDEINFUL**, *†* for *Disdainful*.

**SEA**, *n.* (see.) [*Sax. sae*, *sege*; *G. see*; *D. zee*; *Sw. sjö*, the sea, a lake, or pool; *Basque, sah*; contracted from *sæg*, *seeg*. Hence *Sax. garsege*, *garsege*, *garsegg*, the ocean. This word, like *lake*, signifies primarily a seat, set, or lay, a repository, a basin.] 1. A large basin, cistern, or laver which Solomon made in the temple, so large as to contain more than six thousand gallons. This was called the *brazen sea*, and used to hold water for the priests to wash themselves; 1 Kings vii; 2 Chron. iv.—2. A large body of water, nearly inclosed by land, as the Baltic or the Mediterranean; as, the *sea* of Azof. *Seas* are properly branches of the ocean, and upon the same level. Large bodies of water inland, and situated above the level of the ocean, are lakes.

The appellation of *sea*, given to the Caspian lake, is an exception, and not very correct. So the lake of Galilee is called a *sea*, from the Greek. [See *OCEAN*.]

—3. The ocean; as, to go to *sea*. The fleet is at *sea*, or on the high *seas*.—

4. A wave; a billow; a surge. The vessel shipped a *sea*.—5. The swell of the ocean in a tempest, or the direction of the waves; as, we head the *sea*.—6. Proverbially, any large quantity; a large quantity of liquor; as, a *sea* of blood; as, a *sea* of difficulties.—7. A rough or agitated place or element.

In a troubled *sea* of passion tost. *Milton.* *Half seas over, half drunk.* [A low phrase.]—*On the high seas*, in the open sea, the common highway of nations.—*A long sea*, an uniform and steady motion of long and extensive waves.—*A short sea*, when the waves are irregular, broken, and interrupted, so as frequently to break over a vessel's bow, side, or quarter.—*A cross sea*, one composed of waves moving in different directions.—*A heavy sea*, one in which the waves run high.

**SEA-AIR**, *n.* That part of the atmosphere which is above the sea.

**SEA-ANEMONE**, *n.* The animal flower, a name given to the marine Zoophyte of the genus *Actinia*. They are distinguished by the cylindrical form of the body, which is soft, fleshy, and capable of dilatation and contraction. The same aperture serves for mouth and vent, and is furnished with one or more rows of tentacula, by means of which the animal seizes and secures its food. These tentacula, when expanded, give the animal somewhat the appearance of a flower. The power of reproduction of these animals is scarcely in-

ferior to that of the Hydræ; parts that have been amputated shoot out again,

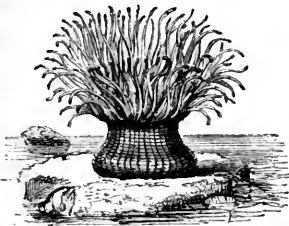

Sea Anemone (*Actinia viridis*).

and the animal may be multiplied by division. Many of the species are used as food in tropical countries.

- SEA-APE, *n.* [*sea* and *ape*.] The name given, by some, to the sea-otter, from its gambols.
- SEA-BANK, *n.* [*sea* and *bank*.] The sea-shore.—2. A bank or mole to defend against the sea.
- SEA-BAR, *n.* [*sea* and *bar*.] The sea-swallow.
- SEA-BAT, *n.* [*sea* and *bat*.] A sort of flying fish.
- SEA-BATHED, *a.* [*sea* and *bathe*.] Bathed, dipped, or washed in the sea.
- SEA-BATHING, *n.* Bathing in the sea, in contradistinction to bathing in rivers, lakes, &c.
- SEA-BEAR, *n.* [*sea* and *bear*.] An animal of the bear kind that frequents the sea; the white or polar bear; *Arctocephalus ursinus*.
- SEA-BEARD, *n.* [*sea* and *beard*.] A marine plant, *Conferva rupestris*.
- SEA-BEAST, *n.* [*sea* and *beast*.] A beast or monstrous animal of the sea.
- SEA-BEAT, } *a.* [*sea* and *beat*.]  
SEA-BEATEN, } Beaten by the sea; lashed by the waves.
- Along the *sea-beat* shore. *Pope.*
- SEA-BIRD, *n.* A general name for sea-fowl, or birds that frequent the sea.
- SEA-BOARD, } *n.* [*sea* and *Fr. bord*.]  
SEA-BORD, } side.] The sea-shore.  
SEA-BOARD, *adv.* Toward the sea.
- SEA-BOAT, *n.* [*sea* and *boat*.] A vessel that bears the sea firmly, without labouring or straining her masts and rigging.
- SEA-BORD, } *a.* [*sea* and *Fr.*  
SEA-BORD'ERING, } *bord*, border.]  
Bordering on the sea or ocean.
- SEA-BORN, *a.* [*sea* and *born*.] Born of the sea; produced by the sea; as, Neptune and his *sea-born* niece.—2. Born at sea. It was long erroneously believed, that all children born at sea, in English ships, belonged to Stepney parish, Middlesex.
- SEA-BOUND, } *a.* [*sea* and *bound*.]  
SEA-BOUND'ED, } Bounded by the sea.
- SEA-BREACH, *n.* [*sea* and *breach*.] Irruption of the sea by breaking the banks.
- SEA-BREAM, *n.* [*sea* and *bream*.] An edible sea-fish, of the genus *Pagellus* (*Sparus*, Linn.), growing to the length of 16 or 20 inches.
- SEA-BREEZE, *n.* [*sea* and *breeze*.] A wind or current of air blowing from the sea upon land; for the most part blowing during the day only, and subsiding at night. In tropical islands, a sea breeze sets in during the day, and a land breeze blows during the night. [See *BREEZE*.]
- SEA-BUCK'THORN, *n.* A plant of the

genus *Hippophæ*, the *H. rhamnoides*, called also sallow-thorn. [See *HIPP-POPHEÆ*.]

- SEA-BU'GLOSS, *n.* A plant of the genus *Lithospermum*, the *L. maritimum*; called also sea gromwell. [See *LITHOSPERMUM*.]
- SEA-BUILT, *a.* [*sea* and *built*.] Built for the sea; as, *sea-built* forts [ships].
- SEA-CAB'PAGE, } *n.* [*sea* and *cab-*  
SEA-KALE, } *bage*.] Sea-colewort, a plant of the genus *Crambe*, the *C. maritima*,—*which see*.
- SEA-CALF, *n.* [*sea* and *calf*.] The common seal, a species of *Phoca*; the *Phoca vitulina* of Linn., and the *Calocephalus vitulinus* of Cuvier.
- SEA-CAP'TAIN, *n.* The commander of a ship or other sea-going vessel.
- SEA-CARD, *n.* [*sea* and *card*.] The mariner's card or compass.
- SEA-CARP, *n.* [*sea* and *carp*.] A spotted fish living among rocks and stones.
- SEA-CATGUT, *n.* The name given in Orkney to a common sea-weed, *Chorda filum*, called in England sea-lace.
- SEA-CHAMOMILE, *n.* A plant of the genus *Anthemis*, the *A. maritima*. [See *ANTHEMIS*.]
- SEA-CHANGE, *n.* [*sea* and *change*.] A change wrought by the sea.
- SEA-CHART, *n.* [*sea* and *chart*.] A chart or map on which the lines of the shore, isles, shoals, harbours, &c. are delineated.
- Note.*—This word has become useless, as we now use *chart* for a representation of the sea coast, and *map* for a representation of the land.
- SEA-CIRCLED, *a.* [*sea* and *circle*.] Surrounded by the sea.
- SEA-COAL, *n.* [*sea* and *coal*.] Coal brought by sea; a vulgar name for fossil coal, in distinction from *charcoal*.
- SEA-COAST, *n.* [*sea* and *coast*.] The shore or border of the land adjacent to the sea or ocean.
- SEA-COB, *n.* [*sea* and *cob*.] A fowl, called also sea-gull.
- SEA-COLEWORT, *n.* Sea-kale,—*which see*.
- SEA-COMPASS, *n.* [*sea* and *compass*.] The mariner's card and needle; the compass constructed for use at sea.
- SEA-COOT, *n.* [*sea* and *cool*.] A sea fowl, *Fulica marina*.
- SEA-COR'MORANT, *n.* [*sea* and *cormorant*.] The sea-crow or sea-drake, *Corvus marinus*.
- SEA-COW, *n.* [*sea* and *cow*.] The walrus, *Trichechus rosmarus*; also called sea-horse.
- SEA-CROW, *n.* [*sea* and *crow*.] A fowl of the gull kind; the mire-crow or pewee.
- SEA-DEVIL, *n.* [*sea* and *devil*.] The fishing frog or toad-fish, of the genus *Lophius*; a fish resembling a tadpole, growing to a large size, with a head larger than the whole body.
- SEA-DOG, *n.* [*sea* and *dog*.] The dog-fish, genus *Scyllium*, of various species, allied to the sharks.—2. The sea-calf or common seal.
- SEA-DRAGON, *n.* [*sea* and *dragon*.] A fabulous marine monster, said to have been caught in England in 1749, resembling in some degree an alligator, but having two large fins which served for swimming or flying. It had two legs terminating in hoofs, like those of an ass. Its body was covered with impenetrable scales, and it had five rows of teeth.
- SEA-DUCKS, *n.* Fuliginæ, a group of sea fowls which form a sub-family

of the Anatidæ, or duck family. The eider duck, surf-duck, and buffed duck, are placed among the Fuliginæ.

SEA-EAGLE, *n.* A marine bird of prey; the *Falco* or *Aquila albicilla*; also called the *white tailed* or *cinereous eagle*.

SEA-EAR, *n.* [*sea* and *ear*.] A scuti-branchiate gastropodous mollusc with a univalve shell, belonging to the genus *Haliotis*. [See *HALIOTIS*.]

SEA-EGGS, *n.* The popular name of the Echinidæ, a family of radiated animals, also called sea urchins.

SEA-EL'EPHANT, *n.* A species of seal, the *Macrorhinus proboscideus* of Cuvier, called also elephant seal. It is taken extensively on Crozet's islands, and is found in many other southern localities. This animal attains the great size of upwards of 25 feet in length; and becomes so fat, that when crawling, the whole body trembles as if it were a

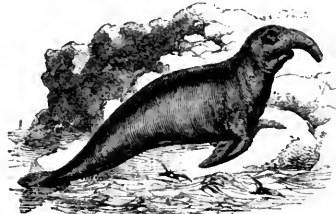

Sea Elephant (*Macrorhinus proboscideus*).

- bag of jelly. The tongue is reckoned savoury food; the skin is used extensively for carriage and horse harness. The oil yielded by this animal is clear, inodorous, and not liable to become rancid; one individual produces so much as from 1400 to 1500 lbs. In this country it is employed chiefly in the manufacture of cloth.
- SEA-ENCIR'LED, *a.* [*sea* and *encircled*.] Encompassed by the sea.
- SEA-FARER, *n.* [*sea* and *fare*.] One that follows the seas; a mariner.
- SEA-FARING, *a.* [*supra*.] Following the business of a seaman; customarily employed in navigation.
- SEA-FENNEL, *n.* [*sea* and *fennel*.] Another name for samphire.
- SEA-FIGHT, *n.* [*sea* and *fight*.] An engagement between ships at sea; a naval action.
- SEA-FOWL, *n.* [*sea* and *fowl*.] A marine fowl; any fowl that lives by the sea, and procures its food from salt water.
- SEA-FOX, *n.* A fish of the shark family, *Squalus vulpes*; called also *fox-shark*, or thresher. It frequently measures



Fox Shark (*Squalus vulpes*).

thirteen feet in length, of which six feet belong to the tail. It is from the form of the lobes of the tail that the animal obtains the name of sea-fox.

SEA-GAGE, *n.* [*sea* and *gage*.] The depth that a vessel sinks in the water;

also, an instrument for ascertaining the depth of the sea.

**SEA-GIL'LIFLOWER, n.** A British plant of the genus *Statice*, the *S. armeria*, called also common thrift. [See *STATICE*.]

**SEA-GIRT, a.** [*sea* and *girt*.] Surrounded by the water of the sea or ocean; as, a *sea-girt* isle.

**SEA-GOD, n.** [*sea* and *god*.] A marine deity; a fabulous being supposed to preside over the ocean or sea; as Neptune.

**SEA-GOWN, n.** [*sea* and *gown*.] A gown or garment with short sleeves, worn by mariners.

**SEA-GRASS, n.** [*sea* and *grass*.] A British plant of the genus *Zostera*, the *Z. marina*, called also grasswrack and sea-wrack. [See *GRASSWRACK*.]

**SEA-GREEN, a.** [*sea* and *green*.] Having the colour of sea-water; being of a faint green colour.

**SEA-GREEN, n.** The colour of sea-water.—2. A plant, the saxifrage.

**SEA-GREENS, n.** Grounds overflowed by the sea in spring tides.

**SEA-GULL, n.** [*sea* and *gull*.] A fowl of the genus *Larus*; a species of gull; called also sea-crow. [See *GULL*.]

**SEA-HARE, n.** [*sea* and *hare*.] A molluscous animal of the genus *Lapidea*, Linn., whose body is covered with membranes reflected; it has a lateral pore on the right side, and four feelers resembling ears. The body is nearly oval, soft, gelatinous, and punctated. Its juice is poisonous, and it is so fetid as to cause nausea.

**SEA-HEATH, n.** The common name of two species of British plants, of the genus *Frankenia*, the *F. levis*, and *F. pulverulenta*. [See *FRANKENIA*.]

**SEA-HEDGEHOG, n.** A species of *Echinus*, so called from its prickles, which resemble in some measure those of the hedgehog or urchin.

**SEA-HEN, n.** [*sea* and *hen*.] Another name for the guillemot.

**SEA-HOG, n.** [*sea* and *hog*.] The porpoise,—which see.

**SEA-HOLLY, n.** [*sea* and *holly*.] A plant of the genus *Eryngium*, the *E. maritimum*. [See *ERYNGIUM*.]

**SEA-HOLM, n.** [*sea* and *Dan. holm*, an isle.] 1. A small uninhabited isle.—2. Sea-holly.

**SEA-HORSE, n.** [*sea* and *horse*.] In *zool.*, the morse, a species of *Trichechus* or walrus, the *T. rosmarus*.—2. The hippopotamus, or river-horse.—3. A fish of the genus *Syngnathus*, *S. hippocampus*, Linn. [See *HIPPOCAMPUS*.]—4. In *myth.*, a fabulous animal depicted with fore parts like those of a horse, and with hinder parts like those



Sea Horse.

of a fish. The Nereids used sea-horses as riding steeds, and Neptune employed them for drawing his chariot.

**SEA-KALE, n.** A species of colewort, the *Crambe maritima*,—which see.

**SEA-KINGS, n. plur.** A name given to

the Northmen pirate kings, who infested the European coasts in the eighth and ninth centuries. They possessed neither territory nor subjects, and their whole possessions consisted in their vessels and crews, with which they plundered all countries within their reach.

**SEA-LARK, n.** A bird of the sandpiper kind; the parr.—2. A bird of the dotterel kind; the ringed dotterel, or plover.

**SEA-LEGS, n.** [*sea* and *legs*.] The ability to walk on a ship's deck when pitching or rolling.

**SEA-LEMON, n.** [*sea* and *lemon*.] A nudibranchiate gastropodous mollusc, of the genus *Doris*, having an oval body, convex, marked with numerous punctures, and of a lemon colour.

**SEA-LEOP'ARD, n.** A species of seal, the *Phoca leopardina* of Jamieson; so named from the whitish spots on the upper part of the body.

**SEA-LIGHT, n.** A light so modified and directed, as to present to the mariner an appearance which shall at once enable him to judge of his position during the night, in the same manner as the sight of a land-mark would do during the day. [See *LIGHTHOUSE*.]

**SEA-LIKE, a.** [*sea* and *like*.] Resembling the sea.

**SEA-LION, n.** [*sea* and *lion*.] An animal of the genus *Phoca* or seal, the *Phoca jubata*, or *Leo marinus* of Forster. It has a thick skin, and reddish



Sea Lion of Forster (Phoca Jubata).

yellow, or dark brown hair, and a mane on the neck of the male reaching to the shoulders. It attains the length of 10 to 14 feet, and is found in the southern hemisphere.

**SEA-MAID, n.** [*sea* and *maid*.] The mermaid. [See *MERMAID*.]—2. A sea-nymph.

**SEA-MALL, } n.** A fowl, a species of

**SEA-MEW, } gull or Larus.**

**SEAMAN, n.** [*sea* and *man*.] A sailor; a mariner; a man whose occupation is to assist in the management of ships at sea.—2. By way of distinction, a skilful mariner; also, a man who is well versed in the art of navigating ships. In this sense, it is applied both to officers and common mariners. A complete seaman is called an *able seaman*, and is rated A. B.; one less competent, is called an *ordinary seaman*; and a man fresh from the shore, a *landsmán*.

—3. Merman, the male of the mermaid. [Little used.]

**SEAMANSHIP, n.** The skill of a good seaman; an acquaintance with the art of managing and navigating a ship; applicable both to officers and to men.—*Naval skill*, is the art of managing a fleet, particularly in an engagement; a very different thing from *seamanship*.

**SEA-MÁRK, n.** [*sea* and *mark*.] Any

elevated object on land which serves for a direction to mariners in entering a harbour, or in sailing along, or approaching a coast; a beacon; as a light-house, a mountain, &c.

**SEA-MEW, n.** A fowl, a species of gull or Larus.

**SEA-MILK'WORT, n.** A British plant of the genus *Glaux*, the *G. maritima*. [See *GLAUX*.]

**SEA-MONSTER, n.** [*sea* and *monster*.] A huge marine animal; Lam. iv.

**SEA-MOUSE, n.** [*sea* and *mouse*.] A dorsibranchiate annelid animal, of the genus *Aphrodita*, the *A. aculeata*, Linn. It is found on the coast of France, and with respect to its colouring, is one of the most splendid of all animals.

**SEA-NAVELWÓRT, n.** [*sea*, *navel* and *wort*.] A plant of the genus *Androsace*, growing in Syria, which is said to effect great cures of diseases.

**SEA-NEEDLE, n.** [*sea* and *needle*.] A name of the gar or garfish, of the genus *Esox*. [See *GARFISH*.]

**SEA-NETTLE, n.** [*sea* and *nettle*.] Another name for the animal flower, or sea-anemone.

**SEA-NURSED, a.** [*sea* and *nursed*.] Nursed by the sea.

**SEA-NYMPH, n.** [*sea* and *nymph*.] A nymph or goddess of the sea.

**SEA-ONION, n.** [*sea* and *onion*.] A plant, the *Scilla maritima*, or squill.

**SEA-OOZE, n.** [*sea* and *ooze*.] The soft mud on or near the sea-shore.

**SEA-ÓTTER, n.** [*sea* and *otter*.] A kind of otter, the *Lutra marina*, Linn. Its whole length is about four feet, of which the tail occupies thirteen inches. The ears are small and erect, and the whiskers long and white, the legs are short and thick, the hinder ones somewhat resembling those of a seal. The fur is extremely soft, and of a deep glossy black. The skins of the sea-otters are of great value, and have long been an article of considerable export from Russia.

**SEA-OWL, n.** [*sea* and *owl*.] Another name for the lump-fish, *Cyclopterus lumpus*.

**SEA-PAD, n.** The star-fish.

**SEA-PANTHER, n.** [*sea* and *panther*.] A fish like a lamprey.

**SEA-PARS'NEP, n.** A British plant of the genus *Echinophora*, the *E. spinosa*, called also sea prickly samphire. [See *ECHINOPHORA*.]

**SEA-PEA, n.** A British plant of the genus *Pisum*, the *P. maritimum*. [See *PISUM, PEA*.]

**SEA-PHEASANT, n.** [*sea* and *pheasant*.] The pin-tailed duck; or *Dafila caudacuta*.

**SEA-PIE, } n.** [*sea* and *pie*, *pica*.] A

**SEA-PYE, } fowl of the genus Hæmatopus, (H. ostralegus, Linn.), and grallac order; called also the oyster-catcher, from its thrusting its beak into oysters when open, and taking out the animal.**

**SEA-PIE, n.** [*sea* and *pie*.] A dish of food consisting of paste and meat boiled together; so named because common at sea.

**SEA-PIECE, n.** [*sea* and *piece*.] A picture representing a scene at sea; a representation of the different aspects of the ocean, together with any accidental circumstances connected therewith, such as a naval action.

**SEA-PIKE, n.** Another name for the *Garfish*,—which see.

**SEA-PLANT, n.** [*sea* and *plant*.] A plant that grows in salt water, as the *fucus*, &c.



**SEA-POOL, n.** [*sea and pool.*] A lake of salt water.

**SEAPORT, n.** [*sea and port.*] A harbour near the sea, formed by an arm of the sea or by a bay.—2. A city or town situated on a harbour, on or near the sea. We call a town a *seaport*, instead of a *seaport town*.

**SEA-PURSLANE, n.** A British plant of the genus *Atriplex*, the *A. portulacoides*, called also shrubby orache. [See **ORACHE.**]

**SEA-RAD'ISH, n.** A British plant of the genus *Raphanus*, the *R. maritimus*. [See **RAPHANUS.**]

**SEA-RISK, n.** [*sea and risk.*] Hazard or risk at sea; danger of injury or destruction by the sea.

**SEA-ROBBER, n.** [*sea and robber.*] A pirate; one that robs on the high seas.

**SEA-ROCKET, n.** A British plant of the genus *Cakile*, the *C. maritima*, growing on the sea shore in sand. It belongs to the nat. order Brassicaceæ.

**SEA-ROOM, n.** [*sea and room.*] Ample space or distance from land, shoals or rocks, sufficient for a ship to drive or scud without danger of shipwreck.

**SEA-RÖVER, n.** [*sea and rover.*] A pirate; one that cruises for plunder.—2. A ship or vessel that is employed in cruising for plunder.

**SEA-ROVING, a.** Wandering on the ocean.

**SEA-SCOR'PION, n.** [*sea and scorpion.*] A salt water fish, (*Cottus scorpius*) a foot in length, with a spine-armed head; it is very voracious.

**SEA-SERPENTS, n.** [*sea and serpent.*] The snakes belonging to the family Hydridæ, of several genera, as *Hydrus*, *Pelamis*, *Chersydrus*, &c. These animals frequent the seas of warm latitudes. They are found off the coast of Africa, and are very plentiful in the Mindoro and Sooloo seas. Some are exceedingly venomous, others innocuous. They delight in calms, and are fond of eddies and tide ways, where the ripple collects numerous fish and medusæ, on which they feed. The *Hydrus Stokesii* here depicted, inhabits

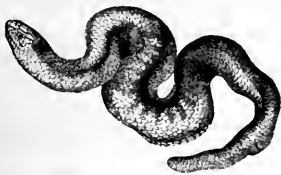

Sea Serpent (*Hydrus Stokesii*)

the Australian seas, and is as thick as a man's thigh.—2. An enormous marine animal resembling a serpent, said to have been repeatedly seen on the coasts of America. Some assert it to be 100 feet long, and others as many yards. All accounts, however, agree as to the protuberances on its back, its vertical sinuosities, and its serpent-shaped head. The following is a very likely account of the origin of this fabulous monster:—

"In the Sooloo seas, I have often witnessed the phenomenon which first gave origin to the marvellous stories of the great sea-serpent, namely, lines of rolling porpoises, resembling a long string of buoys, oftentimes extending seventy, eighty, or a hundred yards. These constitute the so-named protuberances of the monster's

back, keep in close single file, progressing rapidly along the calm surface of the water, by a succession of leaps, or demi-vaults forwards, part only of their uncouth forms appearing to the eye. At the same moment, I have seen beautifully banded water-snakes, of the thickness of a man's leg, lying extended supinely along the glassy surface, or diving and swimming gracefully, with slow undulating lateral movements of their vertically compressed bodies."

*Voyage of the Samarang, Vol. II, p. 354.*

**SEA-SHORE, n.** [*sea and shore.*] The coast of the sea; the land that lies adjacent to the sea or ocean.

**SEA-SICK, a.** [*sea and sick.*] Affected with sickness or nausea by means of the pitching or rolling of a vessel.

**SEA-SICKNESS, n.** The sickness or nausea accompanied by retchings and vomitings, which attacks most persons on first going to sea; sometimes continuing only a day or two, but often lasting the whole of a long voyage. The principal cause is no doubt the motion of the vessel, but it is often aggravated by the smells and effluvia of the vessel. The most effective antidote or remedy, consists in lying in a horizontal position. A common remedy among sailors, is a draught or two of sea water. The violence of the attacks not only varies in different individuals at different times, but the same person who escapes in one voyage shall suffer severely in another.

**SEA-SIDE, n.** [*sea and side.*] The land bordering on the sea; the country adjacent to the sea, or near it.

**SEA-STÄR, n.** [*sea and star.*] The star-fish, a genus of marine animals, called technically *Asterias*.

**SEA-STOCK, n.** A British plant of the genus *matthiola*, the *M. sinuata*. [See **MATTHIOLA.**]

**SEA-SURROUND'ED, a.** [*sea and surround.*] Encompassed by the sea.

**SEA-SWALLOW, n.** The terns, so called from their excessively long and pointed wings, and from their forked tail, which render their flight and carriage analogous to those of swallows. [See **TERN.**]

**SEA-TAN'GLE, n.** The common name of several species of sea weeds of the genus *Laminaria*. *L. digitata* is the well known tangle of the Scotch.

**SEA-TERM, n.** [*sea and term.*] A word or term used appropriately by seamen, or peculiar to the art of navigation.

**SEA-TAN'GLE, n.** The common name of several species of sea weeds of the genus *Laminaria*. *L. digitata* is the well known tangle of the Scotch.

**SEA-TERM, n.** [*sea and term.*] A word or term used appropriately by seamen, or peculiar to the art of navigation.

**SEA-TAN'GLE, n.** The common name of several species of sea weeds of the genus *Laminaria*. *L. digitata* is the well known tangle of the Scotch.

**SEA-TERM, n.** [*sea and term.*] A word or term used appropriately by seamen, or peculiar to the art of navigation.

**SEA-TOAD, n.** [*sea and toad.*] The angler or fishing frog. [See **FISHING FROG.**]

**SEA-TORN, a.** [*sea and torn.*] Torn by or at sea.

**SEA-TOSSED, a.** [*sea and tossed.*] Tossed by the sea.

**SEA-UN'ICORN, n.** The name of the narwhal, the *monodon monoceros* of Linnæus.

**SEA-URCHIN, n.** [*sea and urchin.*] A genus of marine animals, the *Echinus*, of many species. The body is roundish, covered with a bony crust, and often set with movable prickles. This and the sea-egg, and the sea-hedgehog, belong to the family of radiated animals.

**SEA-WALL'ED, a.** [*sea and walled.*] Surrounded or defended by the sea.

**SEAWARD, a.** [*sea and ward.*] Directed toward the sea.

**SEAWARD, adv.** Toward the sea.

**SEA-WATER, n.** [*sea and water.*]

Water of the sea or ocean, which is salt. Sea water is composed of chloride of sodium, 2.50; chloride of magnesium, 0.35; sulphate of magnesia, 0.58; carbonates of lime and magnesia, 0.02; sulphate of lime, 0.01; water, 96.54, in 100 parts.

**SEA-WEEDS, n.** Those plants which are found growing at the bottom of the sea. They form a large proportion of the numerous family *Algae*, and are all of them cryptogamic plants. The most important of these water plants are the *Fucoidæ*, which comprehend the *Fuci*, from the species of which kelp is manufactured; the *Lichineæ*, which resemble the lichens or liverworts; the *Laminariæ* or tangles; the *Dictyoleæ* or sea-net works; the *Floridaæ*, which include the Carrageen moss (*Chondrus crispus*), and the dulse of the Scotch (*Rhodomenia palmata*); the *Gastrocarpeæ*, which include the *Iridea edulis*, or edible dulse.

**SEA-WITHWIND, n.** Bindweed.

**SEA-WOLF, n.** [*sea and wolf.* See **WOLF.**] A fish of the genus *Anarrhicas*, the *A. lupus*. [See **WOLF-FISH.**]

**SEA-WORN, a.** Worn or abraded by the sea.

**SEAWORTHINESS, n.** The state of being able to resist the ordinary violence of wind and weather; as that of a ship.

**SEA-WORTHY, a.** [*sea and worthy.*] Fit for a voyage; worthy of being trusted to transport a cargo with safety; as, a *seaworthy* ship. It is provided in all charter-parties that the vessel chartered shall be "tight, staunch, and strong, well apparelled, furnished with an adequate number of men and mariners, tackle, provisions, &c."

If the ship be deficient in any of these particulars, the owners, though ignorant of the circumstance, will be liable for whatever damage may in consequence be done to the goods of the merchant; and if an insurance has been effected upon her, it will be void. But whether the condition of seaworthiness be expressed in the charter-party or not, it is always implied.

**SEA-WRACK, n.** A plant, the *Zostera marina*. [See **GRASSWRACK.**]

**SEACUN'IES, n.** [Hind. *soukhanies*, from *soukhan*, a helm.] In the *East Indies*, helmsmen or steersmen.

**SEAFOR'THIA, n.** A genus of palms indigenous to the eastern coast of tropical New Holland, and also in the nearest Asiatic island, named by Mr. Brown in honour of Francis, lord Seaforth, a patron of botany. The species are elegant in appearance, with pinnated fronds, the flowers polygamomonœcious, sessile on a branched spadix, with several incomplete spathes; the male flowers above, and with two supporting each female flower. One species, *S. elegans*, has been introduced into our collections, and thrives in light sandy loam and heath mould.

**SEAL, n.** [Sax. *seol*, *sele*, *syle*; Sw. *säl*.] The English name for a genus of marine carnivorous mammiferous quadrupeds, the *Phoca* of Linn., and now raised to the rank of a family under the name of *Phocidæ*. These animals are amphibious, most of them inhabiting the sea coasts, particularly in the higher latitudes. They have six or four incisors above, four or two below. Their hind feet are placed at

the extremity of the body, in the same direction with it, and serve the purpose of a caudal fin; the fore feet are also adapted for swimming, and furnished each with five claws; the external ears are either very small or wanting. The head of a seal bears a resemblance to that of a dog, whose intelligence and soft expressive look it also possesses. It is easily tamed, and soon becomes attached to its keeper or those who feed it. The seal not only furnishes food for the Esquimaux table, oil for his lamp, and clothing for his person; but even the bones and skin supply materials for his boats and his summer tents. There are numerous species; as the *leonina*, sometimes 18 feet in length, and the *jubata*, sometimes 25 feet in length, with a mane like a lion, both called *sea-lion*, and found in the



Marbled Seal (*Phoca discolor*.)

southern seas, and also in the N. Pacific; the *ursina*, or sea-bear, 8 or 9 feet in length, and covered with long thick and bristly hair, found in the N. Pacific; and the common seal [*P. vitulina*], from four to six feet in length, found generally throughout the Atlantic and the seas and bays communicating with it, covered with short, stiff, glossy hair, with a smooth head without external ears, and with the fore legs deeply immersed in the skin. As it frequents the British shores, the seal is well known and has been repeatedly described. Seals are principally hunted for their oil and skins. The skin, when tanned, is extensively employed in the making of shoes, and, when dressed with the hair on, serves for the covering of trunks, &c. In the arrangement of Cuvier, the morses, which form the genus *Trichecus* of Linn., are included among the Phocidae.

SEAL, *n.* [*Sax. sigel, sigle*; *G. siegel*; *Fr. sceau*; *L. sigillum*.] It is uncertain what was the original signification of *seal*, whether an image or some ornament. In Saxon, the word signifies a necklace, or ornament for the neck, a stud or boss, a clasp, and a seal.] 1. A piece of metal or other hard substance, usually round or oval, on which is engraved some image or device, and sometimes a legend or inscription for impressing the wax that makes fast a letter or other enclosed paper. It is also used by individuals, corporate bodies, and states, for making impressions on wax upon instruments of writing, as an evidence of their authenticity. *Seals* are sometimes worn in rings.—*Great seal*, a seal used for the united kingdoms of England and Scotland, and sometimes Ireland, in sealing the writs to summon parliament, treaties with foreign states, and all other papers of great moment.—*Privy seal*, a seal which the

sovereign of England uses previously in grants, &c., which are to pass the great seal, or in matters of subordinate consequence which do not require the great seal. *Lord privy seal*, the officer of state who keeps the privy seal. In Scotland, royal grants are the only deeds which are authenticated by means of seals. In addition to the great seal and privy seal, there is the quarter seal, so called from its having been originally the quarter, and merely the testimonial of the great seal.—*Seal of cause*. In Scotland, most royal burghs, and many superiors of burgh of barony, have conferred upon them, in their charters, the power of constituting subordinate corporations or crafts. The grant or charter by which such a constitution is given, and which defines the privileges and powers to be possessed by the subordinate corporation, is called the *seal of cause*.—2. The wax set to an instrument, and impressed or stamped with a seal. Thus we give a deed under hand and seal. Wax is generally used in sealing instruments, but other substances may be used.—3. The wax or wafer that makes fast a letter or other paper.—4. Any act of confirmation.—5. That which confirms, ratifies, or makes stable; assurance; 2 Tim. ii.—6. That which effectually shuts, confines, or secures; that which makes fast; Rev. xx. SEAL, *v. t.* [*Sw. besegla, försegla*; *G. siegeln*; *D. zegelen*. The root signifies, probably, to set, to fix, to impress, or to cut or engrave.] 1. To fasten with a seal; to attach together with a wafer, or with wax; as, to seal a letter.—2. To set or affix a seal as a mark of authenticity; as, to seal a deed. Hence,—3. To confirm; to ratify; to establish.

And with my hand I seal our true hearts' love. *Shak.*

When therefore I have performed this, and have sealed to them this fruit, I will come by you into Spain; Rom. xv.

4. To shut or keep close; sometimes with *up*. Seal your lips; seal up your lips.

Open your ears, and seal your bosom upon the secret concerns of a friend. *Dwight.*

5. To make fast.

So they went and made the sepulchre sure, sealing the stone and setting a watch; Matt. xxvii.

6. To mark with a stamp, as an evidence of standard exactness, legal size, or merchantable quality.—7. To keep secret.

Shut up the words, and seal the book; Dan. xii; Is. viii.

8. To mark, as one's property, and secure from danger; Cant. iv.—9. To close; to fulfil; to complete; with *up*; Dan. ix.—10. To imprint on the mind; as, to seal instruction; Job xxxiii.—11. To inclose; to hide; to conceal; Job xiv.—12. To confine; to restrain; Job xxxvii.—13. In *arch.*, to fix a piece of wood or iron in a wall with cement, plaster, or other binding material, for staples, hinges, &c.

SEAL, *v. i.* To fix a seal.

I will seal unto this bond. [*Unusual.*] *Shak.*

SEALED, *pp.* Furnished with a seal; fastened with a seal; confirmed; closed.

SEAL-ENGRAVING, *n.* The art of engraving gems for seals. [*See ENGRAVING.*]

SEALER, *n.* One who seals; an officer in chancery, who seals writs and instruments.—2. Hunters of the sea elephant and other kinds of seals, are sometimes called *sealers*.

SEALING, *ppr.* Fixing a seal; fastening with a seal; confirming; closing; keeping secret; fixing a piece of wood or iron in a wall with cement.

SEALING, *n.* [*from seal*, the animal.] The operation of catching seals, curing their skins, and obtaining their oil.—2. In *arch.*, the operation of fixing a piece of wood or iron on a wall, with plaster, mortar, cement, lead, or other binding, for staples, hinges, joints, &c. SEALING-WAX, *n.* [*seal* and *wax*.] A compound of the resin lac, with some less brittle resin, and various colouring matters, used for fastening a folded letter, and thus concealing the writing, and for receiving impressions of seals set to instruments. Sealing-wax is hard or soft, and may be of any colour. The best red sealing wax is made by melting, in a very gentle heat, 43 parts of shell-lac with 19 of Venice turpentine, and 1 of Peruvian balsam; 32 parts of the finest cinnabar, thoroughly levigated, are then stirred in, and the whole well mixed. When the mixture has cooled down, it is either rolled into sticks or shaped in brass moulds.

SEAM, *n.* [*Sax. seam*; *G. saum*; *Sw. sòm*, a seam, a suture; *sòma*, to sew. The *G. saum* signifies a hem or border. The word probably signifies the uniting by sewing. In Danish, *sømmer* signifies to hem, and to besew, to be seemly, to become, to be suitable. We see then that *seam* and *seem* are from one root. The primary sense is to meet, to come or put together. *See SAME* and *ASSEMBLE*.] 1. A suture; a juncture; the suture or uniting of two edges of cloth by the needle.

The coat was without seam, woven from the top throughout; John xix.

2. The joint or juncture of planks in a ship's side or deck; or rather the intervals between the edges of boards or planks in a floor, &c. The seams of ships are filled with oakum, and covered with pitch.—3. In *mines*, a vein or stratum of metal, ore, coal, and the like. In *geol.*, thin layers which separate thicker strata.—4. A cicatrix or scar.—5. A measure of eight bushels of corn; or the vessel that contains it.—A *seam of glass*, the quantity of 120 pounds, or 24 stone of five pounds each.

SEAM, *† n.* [*Sax. seim*; *W. saim*.] Tallow; grease; lard.

SEAM, *v. t.* To form a seam; to sew or otherwise unite.—2. To mark with a cicatrix; to scar; as, *seamed* with wounds.

SEAMAN. *See under SEA.*

SEAMED, *pp.* Marked with seams; having seams or scars.

SEAMEN, *n.* The name given to individuals engaged in navigating ships, barges, &c., upon the high seas. Those employed for this purpose upon rivers, lakes, or canals, are denominated *watermen*.

SEAMING, *ppr.* Marking with scars; making seams.

SEAMLESS, *a.* Having no seam; as, the *seamless* garment of Christ.

SEAMSTER, *n.* One that sews well, or whose occupation is to sew.

SEAMSTRESS, *n.* [*that is, Seamsteress*; *Sax. scamestre*.] A woman whose oc-

cupation is sewing; a sempstress,—*which see.*

**SEAMSTRESSY, n.** The business of a sempstress.

**SEAMY, a.** Having a seam; containing seams or showing them.

**SEAN, n.** A net. [*See SEINE.*]

**SEAPOY, } n.** [Pers. *sipahi*; Hindoo, SE'POY, } *sepahai*.] A native of India, in the military service of a European power, and disciplined after the European manner.

**SEAR, v. t.** [Sax. *searan*; Gr. *αζητος*, to dry; *ξηρανω*, to dry, to parch; *ξηρος*, dry; *σος*, the sun; *συστος*, to dry. Qu. L. *torreo*, in a different dialect.] 1. To burn to dryness and harden the surface of anything; to cauterize; to expose to a degree of heat that changes the colour of the surface, or makes it hard; as, to *sear* the skin or flesh.

I'm *sear'd* with burning steel. *Rowe.*

*Sear* is allied to *scorch* in signification; but it is applied primarily to animal flesh, and has special reference to the effect of heat in making the surface *hard*. *Scorch* is applied to flesh, cloth, or any other substance, and has no reference to the effect of hardness.—2. To wither; to dry.—3. To make callous or insensible.

Having their conscience *seared* with a hot iron; 1 Tim. iv.

To *sear up*, to close by searing or cauterizing; to stop.

Cherish veins of good humour, and *sear up* those of ill. *Temple.*

**SEAR, a.** Dry; withered; no longer green; as *sear* leaves.—To be *in the sear and yellow leaf*, is to be past the meridian of life, to have arrived at that age when the body begins to decay.

**SEARCE, v. t. (sers.)** To sift; to bolt; to separate the fine part of meal from the coarse. [*Little used.*]

**SEARCE, n. (sers.)** A sieve; a bolter. [*Little used.*]

**SEARCEL, n. (sers'er.)** One that sifts or bolts. [*Little used.*]

**SEARCH, v. t. (serch.)** [Fr. *chercher*; Arm. *herchat*, to seek, to ramble.] 1. To look over or through, for the purpose of finding something; to explore; to examine by inspection; as, to *search* the house for a book; to *search* the wood for a thief.

Send thou men, that they may *search* the land of Canaan; Num. xiii.

2. To inquire; to seek for.

Enough is left besides to *search* and know. *Milton.*

3. To probe; to seek the knowledge of, by feeling with an instrument; as, to *search* a wound.—4. To examine; to try; or put to the test; Ps. cxxxix.—To *search out*, to seek till found, or to find by seeking; as, to *search out* truth.

**SEARCH, v. i. (serch.)** To seek; to look for; to make search.

Once more *search* with me. *Shak.*

2. To make inquiry; to inquire.

It suffices that they have once with care sifted the matter, and *searched* into all the particulars. *Locke.*

To *search for*, to look for; to seek; to try to find; as, to *search for* a gentleman now in the house.

**SEARCH, n. (serch.)** A seeking or looking for something that is lost, or the place of which is unknown; with *for* or *after*; as, a *search for* lost money; a *search for* mines of gold and silver; a *search after* happiness or knowledge.—2. Inquiry; a seeking.

11.

He spent his life in *search* of truth.—3. Quest; pursuit for finding.

Nor did my *search* of liberty begin,

Till my black hairs were changed upon my chin. *Dryden.*

*Search of incumbances.* In Scots *law*, as it is of importance to discover the burdens which affect the borrower's or seller's estate, this is effected by what is technically called a *search*; and the system of records in Scotland furnishes the most advantageous means for this purpose. A *search* embraces the following particulars. 1st. A *search* of the general and particular register of sasines; 2nd. A *search* of the record of abbreviates of adjudications; and 3rd. A *search* of the general and particular register of inhibitions. Burdens, however, which do not enter the records, must be ascertained by inquiries made in other quarters. In general, a *search* of the records, comprehending a period of forty years, is supposed to give sufficient security, but to render the *search* complete, it ought to be continued down to the date of the recording of the purchaser's sasine.

**SEARCHABLE, a. (serch'able.)** That may be searched or explored.

**SEARCH'ABLENESS, n.** The state of being searchable.

**SEARCHED, pp. (serch'ed.)** Looked over carefully; explored; examined.

**SEARCHER, n. (serch'er.)** One who searches, explores, or examines, for the purpose of finding something.—2. A seeker; an inquirer.—3. An examiner; a trier; as, the *Searcher* of hearts.—4. An officer in London, appointed to examine the bodies of the dead, and report the cause of their death.—5. An officer of the customs, whose business is to search and examine ships outward bound, to ascertain whether they have prohibited goods on board, also baggage, goods, &c.—6. An inspector of leather. [*Local.*]—7. In *milit. affairs*, an instrument for examining ordnance, to ascertain whether guns have any cavities in them.

**SEARCHING, ppr. (serch'ing.)** Looking into or over; exploring; examining; inquiring; seeking; investigating.—2. *a.* Penetrating; trying; close; as, a *searching* discourse.

**SEARCHING, n. (serch'ing.)** Examination; severe inquiry; Judges v.

**SEARCH'INGLY, adv.** In a searching manner.

**SEARCH'INGNESS, n. (serch'ingness.)** The quality of severe inquiry or examination.

**SEARCHLESS, a. (serch'less.)** Inscrutable; eluding search or investigation.

**SEARCH WARRANT, n.** In *law*, a warrant granted by a justice of the peace to search for goods stolen, or respecting which other offences specified in the act under which it is granted, have been committed.

**SEAR-CLOTH, n.** [Sax. *sar-clath*, sore-cloth.] A cloth to cover a sore; a plaster.

**SEARED, pp. [from sear.]** Burnt on the surface; cauterized; hardened.

**SEARNEDNESS, n.** The state of being seared, cauterized, or hardened; hardness; hence, insensibility.

**SEAR WOOD, n.** Dry wood. [*See SEAR.*]

**SEASON, n. (se'zn.)** [Fr. *saison*; Arm. *seazon*, *sazun*; Port. *sazam*, *sezam*, season, proper time, state of being

seasoned; *sazonar*, to season, ripen, temper, sweeten, bring to maturity; Sp. *sazon*, season, maturity, taste, relish; *sazonar*, to season. The primary sense, like that of time and opportunity, is to fall, to come, to arrive, and this word seems to be allied to *seize* and *assess*; to fall on, to set on.] Season literally signifies that which comes or arrives; and in this general sense, is synonymous with *time*. Hence,—1. A fit or suitable time; the convenient time; the usual or appointed time; as, the messenger arrived in *season*; in good *season*. This fruit is out of *season*.—2. Any time, as distinguished from others.

The *season* prime for sweetest scents and airs. *Milton.*

3. A time of some continuance, but not long.

Thou shalt be blind, not seeing the sun for a *season*; Acts xiii.

4. One of the four divisions of the year, spring, summer, autumn, winter. The *season* is mild; it is cold for the *season*.

We saw, in six days' travelling, the several *seasons* of the year in their beauty.

*Addison.*

We distinguish the season by prefixing its appropriate name, as the spring-season, summer-season, &c. In *astron.*, the seasons are considered as beginning respectively when the sun enters the signs Aries, Cancer, Capricorn, and Libra. Hence the spring season commences about the 21st of March; summer about the 22d of June; autumn about the 23d of September; and winter about the 23d of December. The change of seasons may be divided into those which always recur every year in regular order, and those which are different in different years. The regular changes are explained by the sun's (or earth's) motion; and the irregular depend upon atmospheric and other circumstances, and belong to the science of meteorology.—To be *in season*, to be in good time, or sufficiently early for the purpose.—To be *out of season*, to be too late, beyond the proper time, or beyond the usual or appointed time.—From the sense of convenience, is derived the following: 5. That which matures or prepares for the taste; that which gives a relish.

You lack the *season* of all nature, sleep. *Shak.*

But in this sense, we now use *seasoning*.

**SEASON, v. t. [Fr. *assaisonner.*]** 1. To render palatable, or to give a higher relish to, by the addition or mixture of another substance more pungent or pleasant; as, to *season* meat with salt; to *season* any thing with spices; Lev. ii.—2. To render more agreeable, pleasant, or delightful; to give a relish or zest to by something that excites, animates, or exhilarates.

You *season* still with sports your serious hours. *Dryden.*

The proper use of wit is to *season* conversation. *Tillotson.*

3. To render more agreeable, or less rigorous and severe; to temper; to moderate; to qualify by admixture.

When mercy *seasons* justice. *Shak.*

4. To imbue; to tinge or taint. *Season* their younger years with prudent and pious principles. *Taylor.*

5. To fit for any use by time or habit; to mature; to prepare.

Who in want a hollow friend doth try,  
Directly seasons him an enemy. *Shak.*

6. To prepare for use, by drying or hardening; to take out or suffer to escape the natural juices; as, to season timber.—7. To prepare or mature for a climate; to accustom to and enable to endure; as, to season the body to a particular climate. Long residence in the West Indies, or a fever, may season strangers.

SEASON, *v. i.* To become mature; to grow fit for use; to become adapted to a climate, as the human body.—2. To become dry and hard, by the escape of the natural juices, or by being penetrated with other substance. Timber seasons well under cover in the air, and ship timber seasons in salt water.—3.† To betoken; to savour.

SEASONABLE, *a.* Opportune; that comes, happens, or is done in good time, in due season, or in proper time for the purpose; as, a *seasonable* supply of rain.

Mercy is *seasonable* in the time of affliction. *Ecclus.*

SEASONABLENESS, *n.* Opportuneness of time; the state of being in good time, or in time convenient for the purpose, or sufficiently early.

SEASONABLY, *adv.* In due time; in time convenient; sufficiently early; as, to sow or plant *seasonably*.

SEASONAGE,† *n.* Seasoning; sauce. SEASONAL, *a.* Pertaining to the seasons.

SEASONED, *pp.* Mixed or sprinkled with something that gives a relish; tempered; moderated; qualified; matured; dried and hardened.

SEASONER, *n.* He that seasons; that which seasons, matures, or gives a relish.

SEASONING, *pp.* Giving a relish by something added; moderating; qualifying; maturing; drying and hardening; fitting by habit.

SEASONING, *n.* That which is added to any species of food, to give it a higher relish; usually, something pungent or aromatic; as, salt, spices, or other aromatic herbs; acids, sugar, or a mixture of several things.—2. Something added or mixed to enhance the pleasure of enjoyment; as wit or humour may serve as a *seasoning* to eloquence.

Political speculations are of so dry and austere a nature, that they will not go down with the public without frequent *seasonings*. *Addison.*

SEASONLESS, *a.* Without seasonal succession.

SEAT, *n.* [It. *sedia*; Sp. *sede, sitio*, from L. *sedes, situs*; G. *sitz*; W. *séz*; Ir. *saidh*; W. with a prefix, *gosod*, whence *gosodi*, to *set*. [See SET and SIR.] The English *seat* retains the Roman pronunciation of *situs*, that is, *setus*.] 1. That on which one sits; a chair, bench, stool, or any other thing on which a person sits.

Christ...overthrew the tables of the money changers, and the *seats* of them that sold doves; *Matth.* xxi.

2. The place of sitting; throne; chair of state; tribunal; post of authority; as, the *seat* of justice; judgment *seat*.—3. Mansion; residence; dwelling; abode; as, Italy the *seat* of empire. The Greeks sent colonies to seek a new *seat* in Gaul.

In Alba he shall fix his *royal seat*. *Dryden.*

4. Site; situation. The *seat* of Eden

has never been incontrovertibly ascertained.—5. That part of a saddle on which a person sits.—6. In *horsemanship*, the posture or situation of a person on horseback.—7. A pew or sitting in a church; a place to sit in.

—8. The place where a thing is settled or established. London is the *seat* of business and opulence. So we say, the *seat* of the muses, the *seat* of arts, the *seat* of commerce.

SEAT, *v. t.* To place on a seat; to cause to sit down. We *seat* ourselves; we *seat* our guests.

The guests were no sooner *seated* but they entered into a warm debate.

*Arbutnot.*  
2. To place in a post of authority, in office, or a place of distinction. He *seated* his son in the professor's chair. Then high was king Richard *seated*.

*Shak.*  
3. To settle; to fix in a particular place or country. A colony of Greeks *seated* themselves in the south of Italy; another at Massilia in Gaul.—4. To fix; to set firm.

From their foundations, loosening to and fro, They pluck'd the *seated* hills. *Milton.*

5. To place in a church; to assign seats to.—6. To fit up with seats; as, to *seat* a church.—7. To repair by making the seat new; as, to *seat* a garment.—8. To settle; to plant with inhabitants; as, to *seat* a country. [Not much used.]

SEAT,† *v. i.* To rest; to lie down.

SEATED, *pp.* Placed in a chair or on a bench, &c.; set; fixed; settled; established; furnished with a seat.

SEATING, *pp.* Placing on a seat; setting; settling; furnishing with a seat.

SEAVES, *n. plur.* [Sw. *säf*; Dan. *sv*; Heb. *שׁוֹב*, *suf*.] Rushes. [Local.]

SEAVY, *a.* Overgrown with rushes. [Local.]

SEBACEOUS, *a.* [Low L. *sebaceus*, from *sebum, sebum*, tallow, W. *saim*. Qn. Eth. *sebach*, fat.] Made of tallow or fat; pertaining to fat.—*Sebaceous humour*, a snot-like or glutinous matter secreted by the sebaceous glands, which serves to defend the skin and keep it soft.—*Sebaceous glands*, small glands seated in the cellular membrane under the skin, which secrete the sebaceous humour.

SEBACIC, *a.* [supra.] In *chem.*, pertaining to fat; obtained from fat; as, the *sebacic acid*. When any oil or fat, containing oleine or oleic acid, is distilled, and the product boiled with water, the hot filtered liquid deposits, on cooling, *sebacic acid* in small crystals resembling benzoic acid. It is soluble in alcohol and ether.

SEBATE, *n.* [supra.] In *chem.*, a salt formed by the sebacic acid and a base; as, *sebate* of oxide of ethule.

SEBES'TEN, *n.* The Assyrian plum, a plant of the genus *Cordia*, a species of jujube. The fruit known by the name of *sebesten plums* is the produce of two species of *Cordia*, the *C. Myxa* and *C. Sebestena*.

SEBUNDY, SEBUN'DEE, *n.* In the *East Indies*, an irregular or native soldier or local militia-man, generally employed in the service of the revenue and police.

SE'CALE, *n.* Rye, *S. cornutum*, spurred rye. [See ERGOT.]

SECAMONE, *n.* A genus of plants belonging to the nat. order *Asclepiadaceæ*, found in the warm parts of

India, Africa, Australia, and in the West Indies. The species form erect or climbing smooth shrubs with opposite leaves. Some of them secrete a considerable portion of acrid principle which makes them useful in medicine. Thus the roots of *S. emetica*, being emetic in action, are employed as a substitute for *ipeacuanha*, while the substance called *Smyrna scammony* is said to be obtained from the Egyptian species, *S. agyptiaca* of Brown.

SE'CANT, *a.* [L. *secans, seco*, to cut or cut off, coinciding with Eng. *saw*.] Cutting; dividing into two parts.

SE'CANT, *n.* [Fr. and Sp. *secante*, supra.] 1. In *geom.*, a line that cuts another, or divides it into parts. The secant of a circle is a line drawn from the circumference on one side to a point without the circumference on the other. In *trigonometry*, a secant is a right line drawn from the centre of a circle, which, cutting the circumference, proceeds till it meets with a tangent to the same circle.—2. In *trigonometry*, the secant of an arc or of an angle

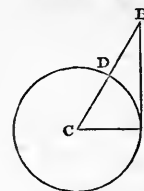

is a straight line drawn from the centre of the circle of which the arc is a part, to one extremity of the arc, and produced till it meets the tangent to the other extremity: Thus, C B is the secant of the arc A D, or of the angle A C D. The secant of an arc is a third proportional to the cosine and the radius.

SECEDE, *v. i.* [L. *secedo; se*, from, and *cedo*, to move. *Se* is an inseparable preposition or prefix in Latin, but denoting departure or separation.] To withdraw from fellowship, communion or association; to separate one's self; as, certain ministers *seceded* from the church of Scotland about the year 1733.

SECEDEE, *n.* One who secedes. In Scotland, the *seceders* are a numerous body of presbyterians who seceded from the communion of the established church, in the year 1733, on account of the toleration of certain alleged errors, the evils of patronage, and general laxity in discipline. The *seceders* or Associate Synod, as they called themselves, remained a united body till 1747, when they split into two on a quarrel about a clause in the oath required to be taken by the burghers or freemen of some of the Scottish burghs, declaratory of their profession and hearty allowance of the "true religion at present professed within the realm; and authorized by the laws thereof;" the larger division, who held that the oath might be conscientiously taken by seceders, calling themselves burghers, and their opponents taking the name of anti-burghers. But in 1820, the burghers and anti-burghers coalesced again into the United Associate Synod. A portion of the body of seceders, who adhered to the principle of an established church, separated in 1806, calling themselves the original seceders. They now form the Synod of United Original Seceders. In May, 1847, the body of dissenters forming the Relief Synod, and comprehending eleven pres-

byteries, united with the Associate Synod, and formed one body, named the United Presbyterian Church.

**SECÉDING**, *ppr.* Withdrawing from fellowship or communion.

**SECERN'**, *v. t.* [*L. secerno*; *se*, and *cerno*, to separate.] In the animal economy, to secrete.

The mucus *secerned* in the nose... is a laudable humour. *Arbutnot.*

**SECERN'ED**, *pp.* Separated; secreted.

**SECERN'ENT**, *n.* That which promotes secretion; that which increases the motions which constitute secretion.

**SECERN'ING**, *ppr.* Separating; secreting; as, *secerning* vessels.

**SECERN'MENT**, *n.* The process or act of secreting.

**SECESS'**, *n.* [*Lat. secessus.*] Retirement; retreat.

**SECESS'ION**, *n.* [*L. secessio.* See **SECEDE.**] 1. The act of withdrawing; particularly from fellowship and communion.—2. The act of departing; departure.—3. The whole body of seceders from the established church of Scotland. [*See SECEDE.*]

**SE'CHIUM**, *n.* A South American edible vegetable, the *Sechium* or *Siegos edulis*. The fruit, in size and form, resembles a large pear.

**SE'CLE**, *n.* [*Fr. siècle*; *L. seculum.*] A century.

**SECLÜDE**, *v. t.* [*L. secludo*; *se* and *claudo*, *cludo*, to shut.] 1. To separate, as from company or society, and usually to keep apart for some length of time, or to confine in a separate state; as, persons in low spirits *seclude* themselves from society.

Let Eastern tyrants from the light of heav'n *Seclude* their bosom slaves. *Thomson.*

2. To shut out; to prevent from entering; to preclude.

Inclose your tender plants in your conservatory, *secluding* all entrance of cold. *Evelyn.*

**SECLÜDED**, *pp.* or *a.* Separated from others; living in retirement; shut out.

**SECLÜDEDLY**, *adv.* In a secluded manner.

**SECLÜDING**, *ppr.* Separating from others; confining in solitude or in a separate state; preventing entrance.

**SECLÜSINESS**, *n.* The state of being secluded from society.

**SECLÜ'SION**, *n.* (*s* as *z*.) The act of separating from society or connection; the state of being separate or apart; separation; a shutting out; as, to live in *seclusion*.

**SECLÜ'SIVE**, *a.* That secludes or sequesters; that keeps separate or in retirement.

**SEC'OND**, *a.* [*Fr.* from *L. secundus*; from *L. sequor*, to follow. See **SEK.**]

1. That immediately follows the first; the next following the first in order of place or time; the ordinal of two. Take the *second* book from the shelf; enter the *second* house.

And he slept and dreamed a *second* time: Gen. xli.

2. Next in value, power, excellence, dignity or rank; inferior. The silks of China are *second* to none in quality. Lord Chatham was *second* to none in eloquence. Dr. Johnson was *second* to none in intellectual powers, but *second* to many in research and erudition.—*Second terms*, in *alge*, those where the unknown quantity has a degree of power less than it has in the term where it is raised to the highest.—*At second-hand*, in the second place

of order; not in the first place, or by or from the first; by transmission; not primarily; not originally; as, a report received *at second-hand*.

In imitation of preachers *at second-hand*, I shall transcribe from Bruyere a piece of rallery. *Tatler.*

**SEC'OND**, *n.* One who attends another in a duel, to aid him, mark out the ground or distance, and see that all proceedings between the parties are fair.—2. One that backs, supports, or maintains another; that which supports.

Being sure enough of *seconds* after the first onset. *Wotton.*

The term in this sense, is now obsolete, except for a *second* in a pugilistic encounter, or a duel.—3. The sixtieth part of a minute of time or of a degree, that is, the *second* minute or small division next to the hour. A degree of a circle and an hour of time are each divided into sixty minutes, and each minute into sixty seconds, in trigonometry marked thus 60''. [*See DEGREE, MINUTE.*] Sound moves above 1130 feet in a *second*.—4. In music, an interval of a conjoint degree, being the difference between any sound and the next nearest sound above or below it. There are three kinds of seconds, the minor second or semitone, the major second, and the extreme sharp second.

**SEC'OND**, *v. t.* [*L. secundo*; *Fr. seconder.*] 1. To follow in the next place.

Sin is *seconded* with sin. [*Little used.*] *South.*

2. To support; to lend aid to the attempt of another; to assist; to forward; to promote; to encourage; to act as the maintainer.

We have supplies to *second* our attempt. *Shak.*

The attempts of Austria to circumscribe the conquests of Buonaparte, were *seconded* by Russia. *Anon.*

In God, one single can its ends produce, Yet serves to *second* too some other use. *Pope.*

3. In legislation, to support, as a motion or the mover. We say, to *second* a motion or proposition, or to *second* the mover.

**SECONDARILY**, *adv.* [*from secondary.*] In the second degree or second order; not primarily or originally; not in the first intention. Duties on imports serve primarily to raise a revenue, and *secondarily* to encourage domestic manufactures and industry.

**SEC'ONDARINESS**, *n.* The state of being secondary.

**SEC'ONDARY**, *a.* [*L. secundarius*, from *secundus.*] 1. Succeeding next in order to the first; subordinate.

Where there is moral right on the one hand, no *secondary* right can discharge it. *L'Estrange.*

2. Not primary; not of the first intention.

Two are the radical differences; the *secondary* differences are as four. *Bacon.*

3. Not of the first order or rate; revolving about a primary planet. Primary planets revolve about the sun; *secondary* planets revolve about the primary.—4. Acting by deputation or delegated authority; as, the work of *secondary* hands.—5. Acting in subordination, or as second to another; as, a *secondary* officer.—*Secondary rocks*, or *Secondary strata*, in *geol.*, those stratified rocks older than the

tertiary, and newer than the primitive, which contain distinct organic remains, and which sometimes pass into the primitive or primary strata. The principal groups of the secondary formations, beginning with the uppermost and descending, are as follows.

1. The cretaceous group. 2. The wealden group. 3. The oolite, or Jura limestone group. 4. The lias group. 5. The new red-sandstone group. 6. The carboniferous group. 7. The graywacke group.—*Secondary creditor*, in *Scots law*, an expression used in contradistinction to *catholic creditor*;

Thus, a creditor who has an heritable security over two estates for the same debt, is a catholic creditor; and a creditor who has a postponed heritable security over one of those estates, is technically called a *secondary creditor*.—A *secondary fever*, is that which arises after a crisis, or a critical effort, as after the declension of the small pox or measles.—*Secondary circles*, or *secondaries*, in *astron.*, great circles of the sphere perpendicular to the plane of another great circle, which is regarded as the *primary*, and consequently passing through its poles: thus declination circles, or celestial meridians, are secondary to the equator. The secondaries to the ecliptic are the circles on which the celestial latitudes are measured.—*Secondary qualities*, are the qualities of bodies which are not inseparable from them, but which proceed from casual circumstances, such as colour, taste, odour, &c.—*Secondary formations*, in *geol.*, formations of substances, subsequent to the primitive.—*Secondary amputation*, in *sur.*, amputation deferred in cases of compound fracture or other severe injury, till the immediate effects of the injury on the constitution have passed away, and suppuration is established. When the amputation is performed immediately after the injury is received, it is termed *primary* amputation.—*Secondary hemorrhage*, hemorrhage occurring after wounds or operations, not immediately, but at a time when, supposing a healthy state of the parts, it would not have happened.

**SEC'ONDARY**, *n.* A delegate or deputy; one who acts in subordination to another; as, the *secondaries* of the Courts of Queen's Bench and of Common Pleas.—2. In *zool.*, a feather growing on the second bone of a fowl's wing.—3. A secondary circle; thus vertical circles are *secondaries* to the horizon.

**SEC'OND BRICKS**, *n.* Bricks of a quality next to the finest mail stocks or cutters. They are used in the principal fronts of buildings.

**SEC'OND COAT**, *n.* In *arch.*, either the finishing coat as inlaid and set, or inrendered and set; or it is the floating when the plaster is roughed in, floated and set for paper.

**SEC'OND-COUSIN**, *n.* The son or daughter of a cousin-german.

**SEC'ONDED**, *pp.* Supported; aided.

**SEC'ONDER**, *n.* One that supports what another attempts, or what he affirms, or what he moves or proposes; as, the *secorder* of an enterprise or of a motion.

**SEC'OND-HAND**, *n.* Possession received from the first possessor.

**SEC'OND-HAND**, *a.* Not original or primary; received from another.

They have but a *second-hand* or implicit knowledge. *Locke.*

2. Not new; that has been used by another; as, a *second hand book*.

**SEC'ONDINE**, *n.* In *bot.* See **SECONDINE**.

**SEC'ONDLY**, *adv.* In the second place. *Secondo*, in *music*, the second part.

**SEC'OND-RATE**, *n.* [*second and rate*.] The second order in size, quality, dignity or value.

They call it thunder of the *second-rate*.  
*Addison.*

So we say, a ship of the *second-rate*.  
**SEC'OND-RATE**, *a.* Of the second size, rank, quality or value; as, a *second-rate ship*; a *second-rate cloth*; a *second-rate champion*.

**SEC'OND-SIGHT**, *n.* The power of seeing things future or distant; a well known Highland superstition. It is alleged that not a few in the Highlands and Isles of Scotland possess the power of foreseeing future events, especially of a disastrous kind, by means of a spectral exhibition, to their eyes, of the persons whom these events respect, accompanied with such emblems as denote their fate. This power is called in Gaelic *Tuischitaraugh*, from *Taisch*, an unreal or shadowy appearance.

Nor less avail'd his optic sleight,  
And Scottish gift of *second-sight*.

*Trumbull.*

**SEC'OND-SIGHTED**, *a.* Having the power of second-sight.

**SE'CRECY**, *n.* [from *secret*.] Properly, a state of separation; hence, concealment from the observation of others, or from the notice of any persons not concerned; privacy; a state of being hid from view. When used of an individual, *secrecy* implies concealment from all others; when used of two or more, it implies concealment from all persons except those concerned. Thus a company of counterfeiters carry on their villany in *secrecy*.

The lady Anne,

Whom the king hath in *secrecy* long married.

*Shak.*

2. Solitude; retirement; privacy; seclusion from the view of others.—3. Forbearance of disclosure or discovery.

It is not with public as with private prayer; in this, rather *secrecy* is commanded than outward show.  
*Hooker.*

4. Fidelity to a secret; close silence; the act or habit of keeping secrets.  
For *secrecy* no lady closer.  
*Shak.*

**SE'CRET**, *a.* [Fr. *secret*; L. *secretus*.] This is given as the participle of *secreo*, but it is radically a different word; *W. segyr*, that is apart, inclosed or *sacred*; *segru*, to secrete or put apart; *ség*, that is without access. The radical sense of *ség* is to separate, as in L. *seco*, to cut off; and not improbably this word is contracted into the Latin *se*, a prefix in *segrego*, *separo*, &c.] 1. Properly, separate; hence, hid; concealed from the notice or knowledge of all persons except the individual or individuals concerned.

I have a *secret* errand to thee, O king;  
Judges iii.

2. Unseen; private; secluded; being in retirement.

There *secret* in her sapphire cell,  
He with the Nais went to dwell. *Fenton.*

3. Removed from sight; private; unknown.

Abide in a *secret* place, and hide thyself;  
1 Sam. xix.

4. Keeping secrets; faithful to secrets

intrusted; as, *secret Romans*. [*Unusual*.]—5. Private; affording privacy; as, the *secret top* of mount Sinai.—6. Occult; not seen; not apparent; as, the *secret operations* of physical causes.—7. Not revealed; known to God only.

*Secret* things belong to the Lord our God; Deut. xxix.

8. Privy; not proper to be seen; kept, or such as ought to be kept, from observation.

**SE'CRET**, *n.* [Fr. from L. *secretum*.] 1. Something studiously concealed. A man who cannot keep his own *secrets*, will hardly keep the *secrets* of others.

To tell our own *secrets* is often folly; to communicate those of others is treachery.

*Rambler.*

A talebearer revealeth *secrets*; Prov. xi.  
2. A thing not discovered and therefore unknown.

All *secrets* of the deep, all nature's works.

*Milton.*

Has't thou heard the *secret* of God? Job. xv.  
3. *Secrets*, plur., the parts which modesty and propriety require to be concealed.—In *secret*, in a private place; in privacy or secrecy; in a state or place not seen; privately.

Bread eaten in *secret* is pleasant; Prov. ix.  
**SE'CRET**; † *v. t.* To keep private.

**SE'CRETARIAL**, *a.* Pertaining to a secretary.

**SE'CRETARISHIP**, *n.* The office of a secretary.

**SE'CRETARY**, *n.* [Fr. *secrétaire*; from L. *secretus*, secret; originally a confident, one intrusted with secrets.]

1. A person employed by a public body, by a company or by an individual, to write orders, letters, despatches, public or private papers, records and the like. Thus legislative bodies have *secretaries*, whose business is to record all their laws and resolves. Ambassadors have *secretaries*.—2. An officer whose business is to superintend and manage the affairs of a particular department of government; as, the *secretary* of state, who conducts the correspondence of a state with foreign courts; the *secretary* of the treasury, who manages the department of finance; the *secretary* at war, of the navy, &c. In the British government there are three principal secretaries of state; viz., one for foreign affairs, one for the home department, and one for the colonies, each of whom has two under secretaries. The principal secretaries are always *ex officio* cabinet ministers. The secretary at war is attached to the War Office. The secretary of state, for Ireland, is keeper of the privy seal of that part of the kingdom, and chief secretary to the lord lieutenant.

**SE'CRETARY BIRD**, *n.* An African

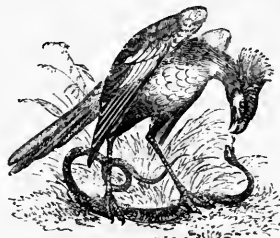

Secretary (*Gypogerranus serpentarius*).

bird of prey, of the genus *Gypogerranus*

the *G. serpentarius*, called also the snake-eater. It is about three feet in length; the legs are long, so as to resemble those of a heron; the beak is hooked, and the eyelids projecting. It has an occipital crest of feathers, which can be raised or depressed at pleasure. It inhabits the dry and open grounds in the vicinity of the Cape, where it hunts reptiles on foot. Cuvier places it among his *Diurnæ* or diurnal birds of prey.

**SE'CRÈTE**, *v. t.* To hide; to conceal; to remove from observation or the knowledge of others; as, to *secrete* stolen goods.—2. To secrete one's self; to retire from notice into a private place; to abscond.—3. In the animal economy, to secrete; to produce from the blood substances different from the blood itself, or from any of its constituents; as the glands. The liver *secretes* bile; the salivary glands *secrete* saliva. 4. In *vegetable physiology*, to separate substances from the sap.

**SE'CRETED**, *pp.* Concealed; secernd.

**SE'CRETING**, *ppr.* Hiding; secernd.

**SE'CRETION**, *n.* The act of secernd;

the act or process by which substances are separated from the blood, differing from the blood itself, or from any of its constituents, as bile, saliva, mucus, urine, &c. This was considered by the older physiologists as merely a separation from the blood of certain substances previously contained in it, the literal meaning of *secretion*; but this opinion is now generally exploded. The organs of secretion are of very various form and structure, but the most general are those called *glands*. The animal secretions are arranged by Bostock under the heads aqueous, albuminous, mucous, gelatinous, fibrinous, oleaginous, resinous and saline. Magendie arranges them into three sorts, 1. *Exhalations*, which are either external, as those from the skin and mucous membranes; and internal; as those from the surfaces of the closed cavities of the body, and the lungs.—2. *Follicular secretions*, which are divided into mucous and cutaneous; and 3. *Glandular secretions*, such as milk, bile, urine, saliva, tears, &c. Every organ and part of the body secretes for itself the nutriment which it requires.—2. The matter secreted, as mucus, perspirable matter, &c.—3. The process by which substances are separated from the sap of vegetables, also the matter secreted. The descending sap of plants is not merely subservient to nutrition, but furnishes various matters which are secreted or separated from its mass, and afterwards elaborated by particular organs. These secretions are exceedingly numerous, and constitute the great bulk of the solid parts of plants.

They have been divided into, 1. *General or Nutritious secretions*, the component parts of which are gun, sugar, starch, lignine, albumen, and gluten; and 2. *Special or local secretions*, which may be arranged under the heads of acids, alkalies, neuter principles, resinous principles, colouring matters, milks, oils, resins, &c.

**SE'CRETIST**, † *n.* A dealer in secrets.  
**SE'CRETIST'IOUS**, *a.* Parted by animal secretion.

**SE'CRETIVENESS**, *n.* In *phrenology*, that organ which, when largely developed, is said to impel the individual towards secrecy or concealment. It is situated at the inferior edge of the

parietal bones, immediately above De-struiveness.

SE'CRETLY, *adv.* Privately; privily; not openly; without the knowledge of others; as, to despatch a messenger *secretly*.—2. Inwardly; not apparently or visibly; latently.

Now *secretly* with inward grief she pin'd.

*Addison.*

SE'CRETNESS, *n.* The state of being hid or concealed.—2. The quality of keeping a secret.

SE'CRETORY, *a.* Performing the office of secretion; as, *secretory* vessels.

SECT, *n.* [Fr. *secte*; L. and Sp. *secta*; from L. *seco*, to cut off, to separate.]

1. A body or number of persons who follow some teacher or leader, or are united in some settled tenets, chiefly in philosophy or religion, but constituting a distinct party by holding sentiments different from those of other men. Any body which separates from the established religion of a country. Most sects have originated in a particular person, who taught and propagated some peculiar notions in philosophy or religion, and who is considered to have been its founder. Among the Jews, the principal sects were the Pharisees, Sadducees, and Essenes. In Greece were the Cynic sect, founded by Antisthenes; and the Academic sect, by Plato. The Academic sect gave birth to the Peripatetic, and the Cynic to the Stoic.—2. † A cutting or scion.

SECTA'RIAN, *a.* [L. *sectarius*.] Pertaining to a sect or to sects; peculiar to a sect; as, *sectarian* principles or prejudices.

SECTA'RIAN, *n.* One of a sect; one of a party in religion which has separated itself from the established church, or which holds tenets different from those of the prevailing denomination in a kingdom or state.

SECTA'RIANISM, *n.* The disposition to dissent from the established church or predominant religion, and to form new sects.

SECTARIAN'IZE, *v. t.* To imbue with sectarian principles or feelings.

SECT'ARISM, *n.* Sectarianism. [*Little used.*]

SECT'ARIST, *n.* A sectary. [*Not much used.*]

SECT'ARY, *n.* [Fr. *sectaire*.] 1. A person who separates from an established church, or from the prevailing denomination of Christians; one that belongs to a sect; a dissenter.—2. † A follower; a pupil.

SECTA'TOR, † *n.* [Fr. *sectateur*.] A follower; a disciple; an adherent to a sect.

SECT'ILE, *a.* [L. *sectilis*, from *seco*, to cut.] That may be cut; that may be separated by cutting. A sectile mineral is one that is midway between the brittle and the malleable, as soapstone and plumbago.

SECT'ION, *n.* [Fr. from L. *sectio*; *seco*, to cut off.—1. The act of cutting, or of separating by cutting; as, the *section* of bodies.—2. A part separated from the rest; a division.—3. In *books* and *writings*, a distinct part or portion; the subdivision of a chapter; the division of a law or other writing or instrument. In laws, a *section* is sometimes called a paragraph or article.—4. A distinct part of a city, town, country, or people; a part of territory separated by geographical lines, or of a people considered as distinct. Thus we say, the northern or eastern *section* of the

United States, the middle *section*, the southern or western *section*.—5. In *geom.*, the line formed by the intersection of two surfaces, and likewise the surface formed when a solid body is cut by a plane. When a plane is cut by a plane, the section is a straight line, called the *common section* of the two planes. When a sphere is cut by a plane, the section is a circle; and when a cone is cut by a plane, the section may be a triangle, a circle, an ellipse, a parabola, or an hyperbola, which five figures are called the *conic sections*. See *Conic sections*.—6. In *arch.*, the projection or geometrical representation of a building supposed to be cut by a vertical plane for the purpose of exhibiting the interior, and describing the height, breadth, thickness, and manner of construction of the walls, arches, domes, &c.—*Section of a Machine*, a drawing or representation of a machine, exhibiting it as it would appear if cut through by a plane.—7. In the *United States*, a square tract of land, of 640 acres.

SECT'IONAL, *a.* Pertaining to a section or distinct part of a larger body or territory.

SECT'IONALLY, *adv.* In a sectional manner.

SECT'OR, *n.* [Fr. *secteur*, from L. *seco*, to cut.] 1. In *geom.*, a part of a circle comprehended between two radii and the arc; or a mixed triangle, formed by two radii and the arc of a circle. Thus A C B, contained within the radii

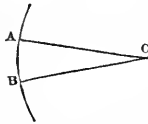

C A, C B, and the arc A B, is a sector of the circle of which the arc A B is a portion.—2. A mathematical instrument so marked with lines

of sines, tangents, secants, chords, &c., as to fit all radii and scales, and useful in making diagrams, laying down plans, &c. Its principal advantage consists in the facility with which it gives a graphical determination of proportional quantities. It becomes incorrect, comparatively, when the opening is great, or the result greater than the data. The sector is founded on the fourth proposition of the sixth book of Euclid, where it is proved that equiangular triangles have their homologous sides proportional. It consists of two rulers, (generally of brass or ivory), representing the radii of a circular arc, and moveable round a joint, the middle of which forms the centre of the circle. From this centre, there are drawn on the faces of the rulers various scales, the choice of which, and the order of their arrangement, may be determined by a consideration of the uses for which the instrument is intended.—3. In *astr.*, an instrument constructed for the purpose of determining with great accuracy the zenith distances of stars, passing within a few degrees of the zenith, where the effect of refraction is small. See ZENITH.—*Dip sector*, an instrument used for measuring the dip of the horizon.

SEC'ULAR, *a.* [Fr. *seculaire*; L. *secularis*, from *seculum*, the world or an age.] 1. Pertaining to this present world, or to things not spiritual or holy; relating to things not immediately or primarily respecting the soul, but the body; worldly. The *secular* concerns of life respect making provision

for the support of life, the preservation of health, the temporal prosperity of men, of states, &c. *Secular* power is that which superintends and governs the temporal affairs of men, the civil or political power; and is contradistinguished from *spiritual* or *ecclesiastical* power.—2. Among  *Catholics*, not regular; not bound by monastic vows or rules; not confined to a monastery, or subject to the rules of a religious community. Thus we say, the *secular* clergy, and the *regular* clergy.—3. Coming once in a century; as, a *secular* year.—*Secular games*, in Rome, were games celebrated once in an age or century, which lasted three days and nights, with sacrifices, theatrical shows, combats, sports, &c.—*Secular music*, any music or songs not adapted to sacred uses.—*Secular song* or *poem*, a song or poem composed for the secular games, or sung or rehearsed at those games.—*Secular equations*, in *astronomy*, corrections required to compensate such inequalities in the motions of the heavenly bodies, as are found to obtain in the course of a century.—*Secular refrigeration*, the periodical cooling, and consequent consolidation of the crust of the globe; a term used by geologists, in reference to the supposed central heat, and even fluidity of the globe, and to the phenomena of its gradual refrigeration.

SEC'ULAR, *n.* 1. Not a spiritual person; a layman; an ecclesiastic of the Romish church, not bound by monastic rules.

—2. A church officer or officiate, whose functions are confined to the vocal department of the choir.

SEC'ULARITY, *n.* Worldliness; supreme attention to the things of the present life.

SECULARIZA'TION, *n.* [from *secularize*.] 1. A making secular; the act of converting from spiritual appropriation to common use.—2. The act of converting a regular person, place, or benefice into a secular one. Most cathedral churches were formerly regular, that is, the canons were of religious or monastic orders; but they have since been secularized. For the *secularization* of a regular church, there is wanted the authority of the Pope, that of the prince, the bishop of the place, the patron, and even the consent of the people.—3. In *Politics*, the appropriation of church property to secular uses.

SEC'ULARIZE, *v. t.* [Fr. *seculariser*; from *secular*.] 1. To make secular; to convert from spiritual appropriation to secular or common use; or to convert that which is regular or monastic into secular; as, the ancient regular cathedral churches were *secularized*.

At the Reformation, the abbey was *secularized*.  
*Cuse, Switz.*

2. To make worldly or unspiritual.—3. To transfer the civil government of a bishopric or country from a prince bishop to a layman.—4. To make unworldly or unspiritual.

SEC'ULARIZED, *pp.* Converted from regular to secular.

SEC'ULARIZING, *ppr.* Converting from regular or monastic to secular.

SEC'ULARLY, *adv.* In a worldly manner.

SEC'ULARNESS, *n.* A secular disposition; worldliness; worldly mindedness.

SEC'UND, *a.* [L. *secundus*.] In *bot.*, arranged on one side only; unilateral;

as the leaves and flowers of *Convallaria majalis*.

**SECUNDATION**, † *n.* Prosperity.  
**SECUNDINE**, *n.* [Fr. *secondines*; from *second*, *L. secundus*, from *sequor*, to follow.] In *bot.*, the outermost but one of the enclosing sacs of the ovulum, immediately reposing upon the primine.—*Secundines*, in the plural, as generally used, are the several coats or membranes in which the fetus is wrapped in the womb; the after-birth.  
**SECUNDUM ARTEM**. [L.] According to art. In *med.*, a term frequently used in prescriptions to denote that the recipe must be made up with particular care and dexterity.—*Secundum naturam*, according to the course of nature.

**SECURE**, *a.* [L. *securus*. It coincides in elements with the oriental סֵכֶר, *sagar*, and סֵכֶר, *siker*, to shut or inclose, to make fast; but it may be from *se* or *sine*, and *cura*, care, free from anxiety.] 1. Free from danger of being taken by an enemy; that may resist assault or attack. The place is well fortified and very secure. Gibraltar is a secure fortress. In this sense, *secure* is followed by *against* or *from*; as, *secure against attack*, or *from an enemy*.—2. Free from danger; safe; applied to persons; with *from*.—3. Free from fear or apprehension of danger; not alarmed; not disturbed by fear; confident of safety; hence, careless of the means of defence. Men are often most in danger when they feel most secure.

Confidence then bore thee on, *secure*  
 To meet no danger. Milton.

4. Confident; not distrustful; with *of*. But thou, *secure* of soul, unbent with woes. Dryden.

It concerns the most *secure* of his strength, to pray to God not to expose him to an enemy. Rogers.

5. Careless; wanting caution.—6. Certain; very confident. He is *secure* of a welcome reception.

**SECURE**, *v. t.* To guard effectually from danger; to make safe. Fortifications may *secure* a city; ships of war may *secure* a harbour.

I spread a cloud before the victor's sight,  
 Sustain'd the vanquish'd and secured his flight. Dryden.

2. To make certain; to put beyond hazard. Liberty and fixed laws *secure* to every citizen due protection of person and property. The first duty and the highest interest of men is to *secure* the favour of God by repentance and faith, and thus to *secure* to themselves future felicity.—3. To inclose or confine effectually; to guard effectually from escape; sometimes, to seize and confine; as, to *secure* a prisoner. The sheriff pursued the thief with a warrant, and *secured* him.—4. To make certain of payment; as, to *secure* a debt by mortgage.—5. To make certain of receiving a precarious debt by giving bond, bail, surety, or otherwise; as, to *secure* a creditor.—6. To insure, as property.—7. To make fast; as, to *secure* a door; to *secure* a rafter to a plate; to *secure* the hatches of a ship.  
**SECURED**, *pp.* Effectually guarded or protected; made certain; put beyond hazard; effectually confined; made fast.  
**SECURELY**, *adv.* Without danger; safely; as, to pass a river on ice *securely*. But *safely* is generally used.—2. Without fear or apprehension; carelessly;

in an unguarded state; in confidence of safety.

His daring foe *securely* him defied. Milton.

Devise not evil against thy neighbour, seeing he dwelleth *securely* by thee; Prov. iii.

**SECUREMENT**, † *n.* Security; protection.

**SECURENESS**, *n.* Confidence of safety; exemption from fear; hence, want of vigilance or caution.

**SECURER**, *n.* He or that which secures or protects.

**SECURIFERS**, or **SECURIFERA**, *n.* [L. *securis*, a hatchet, and *fero*, to bear.] A family of Hymenopterous insects of the section Terebrantia, comprehending those in which the females have a saw-shaped or hatchet-shaped terebra or appendage to the posterior part of the abdomen, which not only serves for the purpose of depositing the eggs in the stems and other parts of plants, but for preparing a place for their reception.

**SECURIFORM**, *a.* [L. *securis*, an axe or hatchet, and *form*.] In *bot.*, having the form of an axe or hatchet.

**SECURIPALPS**, *n.* [L. *securis*, a hatchet, and *pulpo*, to feel.] A family of Coleopterous insects, in which the maxillary palps terminate in a joint which is elongated and hatchet-shaped.

**SECURITY**, *n.* [Fr. *sécurité*; L. *securitas*.] 1. Protection; effectual defence or safety from danger of any kind; as, a chain of forts erected for the *security* of the frontiers.—2. That which protects or guards from danger. A navy constitutes the *security* of Great Britain from invasion.—3. Freedom from fear or apprehension; confidence of safety; whence negligence in providing means of defence. *Security* is dangerous, for it exposes men to attack when unprepared. *Security* in sin is the worst condition of the sinner.—4. Safety; certainty. We have no *security* for peace with China, but the dread of our army.—5. Anything given or deposited, to secure the payment of a debt, or the performance of a contract; as a bond with surety, a mortgage, the indorsement of a responsible man, a pledge, &c.—6. Something given or done to secure peace or good behaviour. Violent and dangerous men are obliged to give *security* for their good behaviour, or for keeping the peace. This *security* consists in being bound with one or more sureties in a recognizance to the king or state.

**SEDAN**, *n.* [From the town of Sedan, in France, where they were first used.] A portable chair or covered vehicle for carrying a single person. It is borne on poles by two men. The sedan-chair was introduced into this country by Sir S. Duncombe in 1634.

**SEDATE**, *a.* [L. *sedatus*, from *sedo*, to calm or appease, that is, to set, to cause to subside.] Settled; composed; calm; quiet; tranquil; still; serene; untroubled by passion; undisturbed; as, a *sedate* soul, mind, or temper. So we say, a *sedate* look or countenance.

**SEDATELY**, *adv.* Calmly; without agitation of mind.

**SEDATENESS**, *n.* Calmness of mind, manner, or countenance; freedom from agitation; a settled state; composure; serenity; tranquillity; as, *sedateness* of temper or soul; *sedateness* of countenance; *sedateness* of conversation.

**SEDATION**, † *n.* The act of calming.

**SEDATIVE**, *a.* [Fr. *sedatif*, from L. *sedo*, to calm.] In *med.*, moderating; allaying irritability and irritation; diminishing irritative activity; assuaging pain.

**SEDATIVE**, *n.* A medicine which allays irritability and irritation, and irritative activity, and which assuages pain.

**SE DEFENDENDO**, [L.] In defending himself; the plea of a person charged with murder, who alleges that he committed the act in his own defence.

**SEDENT**, *a.* Sitting; inactive; quiet.  
**SEDENTARIES**, or **SEDENTARIA**, *n.* [L. *sedeo*, to sit.] A section of spiders, which remain motionless in the hiding place of their web, until their prey be entangled.

**SEDENTARILY**, *adv.* [from *sedentary*.] The state of being sedentary, or living without much action.

**SEDENTARINESS**, *n.* The state of being sedentary.

**SEDENTARY**, *a.* [Fr. *sedentaire*; L. *sedentarius*, from *sedens*, *sedeo*, to sit.] 1. Accustomed to sit much, or to pass most of the time in a sitting posture; as, a *sedentary* man. Students, tailors, and women are *sedentary* persons.—2. Requiring much sitting; as, a *sedentary* occupation or employment.—3. Passed for the most part in sitting; as, a *sedentary* life.—4. Inactive; motionless; sluggish; as, the *sedentary* earth.

The soul, considered abstractly from its passions, is of a remiss, *sedentary* nature. Spectator.

**SEDERUNT**. [L. they sat down] In *Scotland*, a term employed chiefly in minutes of the meetings of courts, to indicate that such and such members were present, and composed the meeting: thus, *sederunt* A. B., C. D., E. F., &c., signifies that these individuals were present (literally sat down) and composed the meeting. The same term is also used as a noun, to signify a sitting or meeting of a court: thus, an *evening sederunt* of the General Assembly signifies an evening sitting or meeting.

**SEDGE**, *n.* [Sax. *seg*; perhaps from the root of *L. seco*, to cut; that is, sword-grass, like *L. gladiolus*.] The *carex* of botanists, an extensive genus of grass-like plants mostly inhabiting the northern and temperate parts of the globe; class and order Monocia triandria, Linn.; nat. order Cyperaceæ. They are easily distinguished from the grasses by having the stem destitute of joints. They grow in marshes and swamps, and on the banks of rivers. Upwards of sixty species are enumerated by British botanists.

**SEDGE-BIRD**, *n.* The *Salicaria phragmitis* of Selby, a species of warbler



Sedge Warbler (*Salicaria phragmitis*).

which visits this country about the middle of April, and emigrates in Sep-



tember. It frequents the sedgy banks of rivers.  
**SEDG'ED**, *a.* Composed of flags or sedge.  
**SEDG'Y**, *a.* Overgrown with sedge.  
 On the gentle Severn's *sedgy* bank.

*Shak.*

**SEDLIA**, *n.* [*L. sedile*, a seat.] In *arch.*, stone seats for the priests in the south wall of the chancel, of many

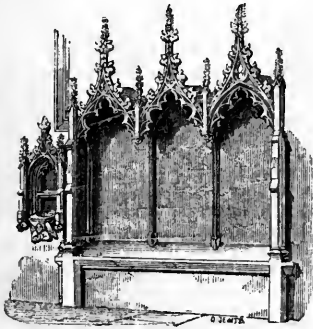

Sedilia, Bolton Percy, Yorkshire.

churches and cathedrals. They are usually three in number, for the use of the priest, the deacon, and subdeacon, during part of the service of high-mass.  
**SEDIMENT**, *n.* [*Fr.* from *L. sedimentum*, from *sedeo*, to settle.] The matter which subsides to the bottom of liquors; settlings; lees; dregs.

**SEDIMENT'ARY**, *a.* Containing sediment; consisting of sediment; formed by sediment; consisting of matter that has subsided.

**SEDIMENT'ARY ROCKS**, are those which have been formed by materials deposited from a state of suspension in water.

**SEDI'TION**, *n.* [*Fr.* from *L. seditio*; *L. sed-eo*; from *se*, a part, and *eo*, to go. The inseparable preposition *se* becomes *sed* before a vowel, in the same manner as *re* is changed into *red* before a vowel. *Sed-eo* must not be confounded with *sedeo*, to sit, the latter being derived from *Gr. ἵκουαι*, to sit. *Seditio*, then, may signify, literally, a separation, or departure from union or peace, from submission, or from obedience; hence, discord, dissension, insurrection amongst citizens.] A factious commotion of the people, or a tumultuous assembly of men rising in opposition to law, and in contravention of the public peace; Ezra iv.; Luke xxiii.; Acts xxiv.—2. In *law*, a general word, comprising, in common language, offences against the state which do not amount to high treason, but which tend to bring about or encourage the greater offence; such as the writing, publishing, or uttering of any words, tending to excite subjects to insurrection, though not urging them on to open rebellion, or total subversion of the government. The term *sedition*, however, is very difficult to define, and its meaning varies according to the state of political feeling at any given time. The act 36 Geo. III., provided against all seditious practices and attempts tending to high treason, and by the act 11 Victoria, the main provisions of the former were extended to Ireland, along with new enactments, which were made applicable to all parts of the United Kingdom. Ac-

cording to this latter act, now in force, any person or persons who shall, within the realm or without, compass, imagine, invent, devise, or intend to deprive or depose the Queen, her heirs and successors, from the style, honour, or royal name of the Imperial crown of this realm, or of any other of her Majesty's dominions and countries, or to levy war against her Majesty, her heirs and successors, within any part of the United Kingdom, in order by force or constraint to compel her or them to change her or their measures or counsels, or in order to put any force or constraint upon, or to intimidate or overawe both houses, or either house of parliament, or to move or stir any foreigner or stranger with force to invade the United Kingdom, or any other her Majesty's dominions, and such compassings, imaginations, inventions, devices, or intentions, or any of them, shall express, utter, or declare, by publishing any printing or writing, or by open and advised speaking, or by any overt act or deed, shall be deemed guilty of felony, and on being convicted, shall be liable, at the discretion of the court, to be transported beyond the seas for life, or for any term not less than seven years. Indictments for felony under this act are to be held valid, though the facts may amount to treason. In Scotland, the laws against sedition are more stringent than in England, being founded on old statutes against *leasing-making*, an offence still more difficult to define than sedition, though partaking generally of the same nature. Felonies under the present act in Scotland are not bailable, unless with consent of the public prosecutor, and the trial is to take place as prescribed by the act 1701.

**SEDI'TIONARY**, *n.* An inciter or promoter of sedition.

**SEDI'TIOUS**, *a.* [*Fr. seditieux*; *L. seditiosus*.] 1. Pertaining to sedition; partaking of the nature of sedition; as, *seditious* behaviour; *seditious* strife.—2. Tending to excite sedition; as, *seditious* words or writings.—3. Disposed to excite opposition to law or lawful authority; turbulent; factious; or guilty of sedition; as, *seditious* persons.

**SEDI'TIOUSLY**, *adv.* With opposition to law; in a manner to violate the public peace.

**SEDI'TIOUSNESS**, *n.* The disposition to excite popular commotion in opposition to law; or the act of exciting such commotion.

**SEDLITZ WATER**. See **SEIDLITZ WATER**.

**SEDU'CE**, *v. t.* [*L. seduco*; *se*, from, and *duco*, to lead; *Fr. seduire*.] 1. To draw aside or entice from the path of rectitude and duty in any manner, by flattery, promises, bribes, or otherwise; to tempt and lead to iniquity; to corrupt; to deprave.

Me the gold of France did not *seduce*.

*Shak.*

In the latter times, some will depart from the faith, giving heed to *seducing* spirits; 1 Tim. iv.

2. To entice to a surrender of chastity. He that can *seduce* a female, is base enough to betray her.

**SEDUCED**, *pp.* Drawn or enticed from virtue; corrupted; depraved.

**SEDUCEMENT**, *n.* The act of seducing; seduction.—2. The means employed to seduce; the arts of flattery, falsehood, and deception.

**SEDUCER**, *n.* One that seduces; a corrupter; one that by temptation or arts, entices another to depart from the path of rectitude and duty; pre-eminently, one that by flattery, promises, or falsehood, persuades a female to surrender her chastity. The *seducer* of a female is little less criminal than the murderer.—2. That which leads astray; that which entices to evil.

He whose firm faith no reason could remove, Will melt before that soft *seducer*, love.

*Dryden.*

**SEDUCIBLE**, *a.* Capable of being drawn aside from the path of rectitude; corruptible.

**SEDUCING**, *ppr.* Enticing from the path of virtue or chastity.

**SEDUCINGLY**, *adv.* In a seducing manner.

**SEDUC'TION**, *n.* [*Fr.* from *L. seductio*.]

1. The act of seducing, or of enticing from the path of duty; in a *general sense*.—2. *Appropriately*, the act or crime of persuading a female, by flattery or deception, to surrender her chastity. A woman who is above flattery, is least liable to *seduction*; but the best safeguard is principle, the love of purity and holiness, the fear of God and reverence for his commands.

**SEDUC'TIVE**, *a.* Tending to lead astray; apt to mislead by flattering appearances.

**SEDUC'TIVELY**, *adv.* In a seductive manner.

**SEDULITY**, *n.* [*L. sedulitas*. See **SEDULOUS**.] Diligent and assiduous application to business; constant attention; unremitting industry in any pursuit. It denotes *constancy* and *perseverance*, rather than *intensity* of application.

Let there be but the same propensity and bent of will to religion, and there will be the same *sedulity* and indefatigable industry in men's inquiries into it. *South*.

**SED'ULOUS**, *a.* [*L. sedulus*, from the root of *sedeo*, to sit; as, *assiduous*, from *assideo*.] Literally, sitting close to an employment; hence, assiduous; diligent in application or pursuit; constant, steady, and persevering in business, or in endeavours to effect an object; steadily industrious; as, the *sedulous* bee.

What signifies the sound of words in prayer, without the affection of the heart, and a *sedulous* application of the proper means that may lead to such an end?

*L'Estrange.*

**SED'ULOUSLY**, *adv.* Assiduously; industriously; diligently; with constant or continued application.

**SED'ULOUSNESS**, *n.* Assiduity; assiduousness; steady diligence; continued industry or effort.

**SE'DUM**, *n.* A genus of plants, nat. order *Crassulaceæ*. The species are mostly herbs or shrubby plants, with stems usually branched from the base. They are inhabitants of the temperate and warmer parts of the earth, and are mostly found in dry, barren, rocky, or arid situations, where nothing else will grow. Many of them are British, and a number of the foreign species are cultivated in our gardens. The British species are known by the common name of stonecrop. The leaves of *S. telephium*, or pine or tuberous stonecrop, are sometimes eaten as a salad, and the roots were formerly in request as a remedy in hemorrhoids and other diseases. *S. acre*, acrid stonecrop or wall-pepper, was formerly much used as a remedy in scorbutic diseases.

When applied to the skin it produces vesication, and when taken internally it causes vomiting. *S. album*, or white stoncrop, was also formerly used in medicine, and eaten cooked, or as a salad.

SEE, *n.* [Fr. *siège*; L. *sedes*; Scot. *sege*; Arm. *sich*.] 1. The seat of episcopal power; a diocese; the jurisdiction of a bishop.—2. The seat of an archbishop; a province or jurisdiction of an archbishop; as, an archi-episcopal *see*.—3. The seat, place, or office of the Pope or Roman pontiff; as, the papal *see*.—4. The authority of the Pope or court of Rome; as, to appeal to the *see* of Rome.—5.† The seat of power generally.

SEE, *v. t. pret. saw*; *pp. seen*. [Sax. *seon*, *seogan*, *geseon*; G. *sehen*. This verb is contracted, as we know by the Eng. *sight*, Dan. *sigt*, G. *gesicht*. Ch. סֵה, *saha*, סֵה, *sehah*, or סֵה, *sehi*, to see. In G. *besuchen* is to visit, to *see*, and this is from *suchen*, which is the Eng. to *seek*, and to *seek* is to look for. In G. *gesuch* is a *suit*, a seeking, demand, petition; and *tersuchen* is to try, Eng. *essay*. We have then decisive evidence that *see*, *seek*, L. *sequor*, and Eng. *essay*, are all from the same radix. The primary sense of the root is to strain, stretch, extend; and as applied to *see*, the sense is to extend to, to reach, to strike with the eye or sight.] 1. To perceive by the eye; to have knowledge of the existence and apparent qualities of objects by the organs of sight; to behold.

I will now turn aside and *see* this great sight; Exod. iii.

We have *seen* the land, and behold, it is very good; Judges xviii.

2. To observe; to note or notice; to know; to regard or look to; to take care; to attend, as to the execution of some order, or to the performance of something.

Give them first one simple idea, and *see* that they fully comprehend it before you go any further. *Locke*.

*See* that ye fall not out by the way; Gen. xlv.

3. To discover; to descry; to understand. Who so dull as not to *see* the device or stratagem? Very noble actions often lose much of their excellence when the motives are *seen*.—

4. To converse or have intercourse with. We improve by *seeing* men of different habits and tempers.—5. To visit; as, to call and *see* a friend. The physician *sees* his patient twice a day; 1 Sam. xv.; 1 Cor. xvi.—6. To attend; to remark or notice.

I had a mind to *see* him out, and therefore did not care to contradict him.

*Addison*. To behold with patience or sufferance; to endure.

It was not meet for us to *see* the king's dishonour; Ezra iv.

8. In *Scripture*, to hear or attend to.

I turned to *see* the voice that spoke with me; Rev. i.

9. To feel; to suffer; to experience.

Make us glad according to the days wherein thou hast afflicted us, and the years in which we have *seen* evil; Ps. xc.

If a man shall keep my saying, he shall never *see* death; John viii.; Luke ii.

10. To know; to learn.

Go, I pray thee, *see* whether it be well with thy brethren; Gen. xxxvii.

11. To perceive; to understand; to comprehend. I *see* the train of argu-

ment; I *see* his motives.—12. To perceive; to understand experimentally.

I *see* another law in my members; Rom. vii.

13. To beware.

*See* thou do it not; Rev. xix.

14. To know by revelation.

The word that Isaiah, the son of Amoz, *saw* concerning Judah and Jerusalem; Is. ii. xiii.

15. To have faith in and reliance on.

*Seeing* him who is invisible; Heb. xi.

16. To enjoy; to have fruition of.

Blessed are the pure in heart, for they shall *see* God; Matt. v.

SEE, *v. i.* To have the power of perceiving by the proper organs, or the power of sight. Some animals, it is said, are able to *see* best in the night.—2. To discern; to have intellectual sight; to penetrate; to understand; with *through* or *into*; as, to *see through* the plans or policy of another; to *see into* artful schemes and pretensions.—3. To examine or inquire. *See* whether the estimate is correct.—4. To be attentive.—5. To have full understanding.

But now ye say, we *see*, therefore your sin remaineth; John xix.

*See* to it, look well to it; attend; consider; take care.—*Let me see*, *let us see*, are used to express consideration, or to introduce the particular consideration of a subject, or some scheme or calculation.—*See* is used imperatively, or as an interjection, to call the attention of others to an object or a subject, signifying lo! look! behold! *See, see*, how the balloon ascends.

*See* what it is to have a poet in your house. *Pope*.

SEED, *n.* [Sax. *sæd*; G. *saat*; from the verb *sow*. Qu. W. *hād*, Arm. *had*.]

1. The substance, animal or vegetable, which nature prepares for the reproduction and conservation of the species. In plants the seed is the impregnated and matured ovule, which may be defined a body within the pericarp, and containing an organized embryo, which on being placed in favourable circumstances is developed, and converted into an individual similar to that from which it derived its origin. The reproductive organs of flowerless plants, such as sea-weeds and mushrooms, differ in structure, and in their mode of germination, and are not considered as true seeds, but are named *sporules*. The seed is attached to the placenta by a small pedicel or *umbilical cord*, also named *podosperm*. In some plants this pedicel is usually expanded, and rising round the seed, forms a partial covering to it, named the *arillus*; as in the nutmeg, in which it constitutes the part called *mace*. The point of attachment of the cord or *podosperm* is named the *hilum*. The seed is composed of an external skin, the *testa* or *perisperm*, and a *kernel* or *nucleus*. In some cases, the seeds constitute the fruit or valuable part of plants, as in the case of wheat and other esculent grain; sometimes the seeds are inclosed in the fruit, as in apples and melons.

When applied to animal matter, it has no plural.—2. That from which any thing springs; first principle; original; as, the *seeds* of virtue or vice.—3. Principle of production.

Praise of great acts he scatters as a *seed*. *Waller*.

4. Progeny; offspring; children; descendants; as, the *seed* of Abraham; the *seed* of David. In this sense, the

word is applied to one person, or to any number collectively, and admits of the plural form; but rarely used in the plural.—5. Race; generation; birth. Of mortal *seed* they were not held.

*Waller*.

SEED, *v. i.* To grow to maturity, so as to produce seed. Maize will not *seed* in a cool climate.—2. To shed the seed.

SEED, *v. t.* To sow; to sprinkle with seed, which germinates and takes root. SĒED BASKET, or SĒED CARRIER.

In *agriculture*, a basket for holding the seed to be sown.

SĒED-BUD, *n.* [*seed* and *bud*.] The germ, germen, or rudiment of the fruit in embryo.

SĒED-CAKE, *n.* [*seed* and *cake*.] A sweet cake containing aromatic seeds.

SĒED-COAT, *n.* In *bot.*, the aril of a seed.

SĒED-CORN, } *n.* Corn or grain for

SĒED-GRAIN, } seed.

SĒED-DOWN, *n.* The down on vegetable seeds.

SĒEDED, *pp. or a.* Bearing seed; covered thick with seeds; interspersed with seed.—2. Sown; sprinkled with seed.—3. In *her.*, an epithet applied to the seeds of roses, lilies, &c., when borne of a tincture different to the flower itself.

SĒEDER, *n.* One who sows.

SĒED-FARMERS, *n.* In *England*, small farmers who devote themselves chiefly to the growing of garden seeds for the London seedsmen, and for the distillers.

SĒED-FIELD, *n.* A field for raising seed.

SĒEDING, *ppr.* Sowing with seeds.

SEED-LAC. *See* LAC.

SEED-LEAF, *n.* In *bot.*, the primary leaf. The *seed-leaves* are the cotyledons or lobes of a seed expanded and in vegetation.

SEEDLING, *n.* A plant reared from the seed, as distinguished from one propagated by layers, buds, &c.

SEED-LIP, } *n.* A vessel in which a

SEED-LOP, } sower carries the seed to be dispersed.

SEED-LOBE, *n.* The lobe of a seed; the two halves into which the common pea splits are seed lobes; a cotyledon, —*which see*.

SEEDNESS, } *n.* Seed-time.

SEED-PEARL, *n.* [*seed* and *pearl*.] Small pearls about the size of small shot.

SEED-PLAT, } *n.* [*seed* and *plat*.] The

SEED-PLOT, } ground on which seeds are sown to produce plants for transplanting; hence,—2. A nursery; a place where any thing is sown or planted for cultivation.

SEEDSMAN, *n.* [*seed* and *man*.] A person who deals in seeds; also, a sower. SEED-TIME, *n.* [*seed* and *time*.] The season proper for sowing.

While the earth remaineth, *seed-time* and harvest, and cold and heat, and summer and winter, and day and night, shall not cease; Gen. viii.

SEED-VESSEL, *n.* In *bot.*, the pericarp which contains the seeds.

SEEDY, *a.* [from *seed*.] Abounding with seeds; running to seed.—2. Having a peculiar flavour, supposed to be derived from the weeds growing among the vines; applied to French brandy.—4. Exhausted; worn out; poor and miserable-looking; as, he looked *seedy*; a *seedy* coat. [*Colloq.*]

SEE'ING, *ppr.* [from *see*.] Perceiving by the eye; knowing; understanding; observing; beholding.

*Note*.—This participle, improperly classed by grammarians among conjunctions, appears to be used indefinitely, or without direct reference to a person or persons. "Wherefore come ye to me, *seeing* ye hate me?" Gen. xxvi. That is, since, or the fact being that or thus; because that. In this form of phraseology, *that* is understood or implied after *seeing*; why come ye to me, *seeing that*, ye hate me? The resolution of the phrase or sentence is, ye hate me; that fact being seen or known by you, why come ye to me? or, why come ye to me, ye *seeing* [knowing] that fact which follows, viz., ye hate me. In this case, *seeing* retains its participial character, although its relation to the pronoun is somewhat obscured. Originally, *seeing*, in this use, had direct relation to the speaker or to some other person. "Now I know that thou fearest God, *seeing* thou hast not withheld thy son;" Gen. xxii. Here *seeing* refers to I, or according to the language of syntax, agrees or accords with I. I know thou fearest God, for I see thou hast not withheld thine only son; I know thou fearest God by *seeing*, in consequence of *seeing* this fact, thou hast not withheld thine only son. But the use of *seeing* is extended to cases in which it can not be referred to a specific person or persons, in which cases it expresses the notoriety or admission of a fact in general, and is left, like the French *on*, in the phrases *on dit*, *on voit*, without application to any particular person.

SEE'ING, *n.* Sight; vision.

SEEK, *v. i. pres. and pp. sought*, pronounced *sawt*. [Sax. *secan*, *sacan*, to seek, to come to; *asecan*, to require; *gesecan*, to seek, to come to; *forsacan*, *forsæcan*, to forsake; G. *suchen*, to seek; *absuchen*, to pick off; *besuchen*, to visit, to see; *gesuch*, suit, petition; *gesuche*, a continued seeking; *versuchen*, to try, prove, *essay*, strive; *versuch*, trial, *essay*; D. *zoeken*, to seek, to look for, to try or endeavour; *bezoeken*, to visit, to try; *gezoch*, a seeking; *opzoeken*, to seek; *verzoeken*, to request, desire, invite, try, tempt, to visit; Dan. *søger*, to seek, to endeavour; *besøger*, to visit; *forsøger*, to try, to *essay*, to experiment, to tempt; *opsøger*, to seek or search after; *Sv. söka*, to seek, to sue, to court; *söka en lagligen*, to sue one at law; *besöka*, to visit; *försöka*, to try, to *essay*, to tempt. These words all accord with L. *sequor*, Ir. *seichim*, to follow; for to *seek* is to go after, and the primary sense is to advance, to press, to drive forward, as in the L. *peto*. See ESSAY, from the same root, through the Italian and French. Now in Sax. *forsacan*, *forsæcan*, is to forsake; *sacan* is to strive, contend, whence English *sake*, and *sacan*, *secan*, is to seek. But in Swedish, *försaka*, to forsake, to renounce, is from *sak*, thing, cause, suit, Sax. *saca*, English *sake*; in Danish, *forsager*, to renounce, is from *siger*, to say; *sag*, a thing, cause, matter, suit; *sagd*, a saying; G. *versagen*, to deny, to renounce, from *sagen*, to say, to tell; D. *verzaaken*, to deny, to forsake, to revoke, from *zaak*, thing, cause, and *zeggen* is to say or tell, which is the Sax. *seggan*, to say. These close affinities prove that *seek*, *essay*, *sag*, and L. *sequor*, are all from one radix, coinciding with Ch. פָּרַע, *asak*, to seek, to strive. The English verb *see* seems to be from the

same root.] 1. To go in search or quest of; to look for; to search for by going from place to place.

The man asked him, saying, What *seekest* thou? And he said, I *seek* my brethren; Gen. xxxvii.

2. To inquire for; to ask for; to solicit; to go; to find; to endeavour to find or gain by any means.

The young lions roar after their prey, and *seek* their meat from God; Ps. civ.

He found no place for repentance, though he *sought* it carefully with tears; Heb. xii. Others tempting him, *sought* of him a sign; Luke xi.

3. *Seek* is followed sometimes by *out* or *after*. To *seek out*, properly implies to look for a specific thing among a number. But in general, the use of *out* and *after* with *seek*, is unnecessary and inelegant.—To *seek God*, his name, or his face, in Scripture, to ask for his favour, direction and assistance; Ps. lxxiii.; lxxxiii.—*God seeks men*, when he fixes his love on them, and by his word and Spirit, and the righteousness of Christ, reclaims and recovers them from their miserable condition as sinners; Ezek. xxxiv; Ps. cxix; Luke xv.—To *seek after the life*, or *soul*, to attempt by arts or machinations; or to attempt to destroy or ruin; Ps. xxxv.—To *seek peace*, or *judgment*, to endeavour to promote it; or to practise it; Ps. xxxiv; Is. i.—To *seek an altar*, temple, or habitation, to frequent it; to resort to it often; 2 Chron. i; Amos v.—To *seek out God's works*, to endeavour to understand them; Ps. cxi.

SEEK, *v. i.* To make search or inquiry; to endeavour to make discovery.

*Seek* ye out of the book of the Lord, and read; Is. xxxiv.

2. To endeavour.

Ask not what pains, nor further *seek* to know

Their process, or the forms of law below. Dryden.

To *seek after*, to make pursuit; to attempt to find or take. [See No. 3, supra.] To *seek for*, to endeavour to find.—To *seek to*, to apply to; to resort to; 1 Kings x.—To *seek*, at a loss; without knowledge, measures, or experience.

Unpractised, unprepared, and still to *seek*. Milton.

SEEKER, *n.* One that seeks; an inquirer; as, a *seeker* of truth.—2. One of a sect in the time of Cromwell, that professed no determinate religion.

SEEKING, *n.* Act of attempting to find or procure.

SEEK-SORRÖW, † *n.* [*seek* and *sorrow*.] One that contrives to give himself vexation.

SEEL, *v. t.* [Fr. *sceller*, to seal.] To close the eyes; a term of falconry, from the practice of running a thread through the eyelids of a hawk, when first taken, so that she may see very little or not at all, to make her the better endure the hood. Hence, to hoodwink.

SEEL, † *v. i.* [Sax. *sylan*, to give. See SEEL.] To lean; to incline to one side.

SEEL, } † *n.* The rolling or agitation of a ship in a storm. SEELING, }  
SEEL, † *n.* [Sax. *sæl*.] Time; opportunity; season.

SEELILY, † *adv.* In a silly manner. SEELY, † *a.* [from *seel*.] Lucky; fortunate.—2. † Silly; foolish; simple. [See SILLY.]

SEEM, *v. i.* [G. *ziemen*, to become, to befit or suitable; *geziemen*, to become, to beseech, to be meet, decent, *seemly*. In D. *zweemen* is to be like, to resemble, and *taamen* is to fit or suit, to become. In Dan. *söm* is a *seam*, and *sömmer*, signifies to hem, and also to become, to beseech, to be suitable, decent, or *seemly*. This is certainly the G. *ziemen*; hence we see that *seam* and *seem* are radically the same word: It. *sembrare*, to seem; *sembiante*, like, similar, resembling; *rassemblerare*, to resemble; Sp. *semejar*, to be like; Fr. *sembler*, to seem, to appear. These words seem to be of one family, having for their radical sense, to extend to, to meet, to unite, to come together, or to press together. If so, the Dutch *taamen* leads us to the oriental roots, Heb. Ch. and Syr. דָּמָה, *damah*, to be like; Eth. *adam*, to please, to snit; Ar. *adama*, to add, to unite, to agree, to suit, to conciliate, to confirm concord. These verbs are radically one, and in these we find the primary sense of *Adam*; likeness, or form.] 1. To appear; to make or have a show or semblance.

Thou art not what thou *seem'st*. Shak. All *seem'd* well pleas'd; all *seem'd*, but were not all. Milton.

2. To have the appearance of truth or fact; to be specious; to be understood as true. The phrase *it seems* (it appears), is often used to express slight affirmation, and also ironically to condemn the thing mentioned, like the old English *forsooth*; as this, *it seems*, is to be my task.

A prince of Italy, it *seems*, entertained his mistress on a great lake. Addison.

SEEM, † *v. t.* To become; to befit; to beseech.

SEEMED, *pp.* Appeared; befitted.

SEEMER, *n.* One that carries an appearance or semblance.

Hence we shall see, If power change purpose, what our *seemers* be. Shak.

SEEMING, *ppr.* Appearing; having the appearance or semblance, whether real or not.—2. *a.* Specious; as, *seeming* friendship.

SEEMING, *n.* Appearance; show; semblance.—2. Fair appearance.

These keep *Seeming* and savour all the winter long. Shak.

3. Opinion or liking; favourable opinion. Nothing more clear to their *seeming*. Hooker.

His persuasive words impregn'd With reason to her *seeming*.† Milton.

SEEMINGLY, *adv.* In appearance; in show; in semblance. This the father *seemingly* complied with. Addison.

They depend often on remote and *seemingly* disproportioned causes. Atterbury.

SEEMINGNESS, *n.* Fair appearance; plausibility.

SEEMLESS, † *a.* Unseemly; unfit; inconducous.

SEEM'LIHED, } † *n.* [See HEAD and SEEM'LYHED,] HOOD.] Comely or decent appearance.

SEEMLINESS, *n.* [from *seemly*.] Comeliness; grace; fitness; propriety; decency; decorum.

When *seemliness* combines with portliness. Camden.

SEEMLY, *a.* [G. *ziemlich*.] Becoming; fit; suited to the object, occa-

sion, purpose or character; suitable; decent; proper.

Suspense of judgment and exercise of charity were safer and *seemlier* for Christian men, than the hot pursuit of these controversies. *Hooker.*

Honour is not *seemly* for a fool; Prov. xxvi.

SEEMLY, *adv.* In a decent or suitable manner.

SEEN, *pp.* of *See*. Beheld; observed; understood.—2. *a.* Versed; skilled.

Noble Boyle, not less in nature *seen*.†

*Dryden.*

SEER, *n.* [from *see*.] One who sees; as, a *seer* of visions.—2. A prophet; a person who foresees future events; 1 Sam. ix.

SEER, *n.* A weight which varies all over India; in Bengal there are forty *seers* to a maund, which is about 74 pounds avoirdupois.

SEER-WOOD. [See *SEAR*, and *SEAR-WOOD*, dry wood.]

SEE'-SAW, *n.* [Qu. *saw* and *saw*, or *sea* and *saw*.] A vibratory or reciprocating motion.—2. A child's game so called.

SEE'-SAW, *v. i.* To move with a reciprocating motion; to move backward and forward, or upward and downward.

SEETH, *v. t. pret.* *seethed*, *sod*; *pp.* *seethed*, *sodden*. [Sax. *seuthan*, *seuthan*, *sythan*; G. *sieden*; Gr. *ἴσσω*, contracted from *ἴσθω*; Heb. *ציד*, *zud*, to seethe, to boil, to swell, to be inflated.] To boil; to decoct or prepare for food in hot liquor; as, to *seethe* flesh.

Thou shalt not *seethe* a kid in its mother's milk; Exod. xxiii.

SEETHE, *v. i.* To be in a state of ebullition; to be hot. [This word is rarely used in the common concerns of life.]

SEETHED, *pp.* Boiled; decocted.

SEETHER, *n.* One that seethes; a boiler; a pot for boiling things.

SEETHING, *ppr.* Boiling; decocting.

SEG, † *n.* Sedge.

SEGAR. See *CIGAR*.

SEG'GAR, or SAG'GER, *n.* The cylindrical case of fire clay, in which fine stone-ware is enclosed while being baked in the kiln.

SEG'HOL, *n.* A Hebrew vowel-point, or short vowel, thus '·', indicating the sound of the English *e*, in *men*.

SEG'HOLATE, *a.* Marked with a seghol.

SEG'MENT, *n.* [Fr. from L. *segmentum*, from *seco*, to cut off. We observe here the Latin has *seg*, for *sec*, like the It. *segare*, and like the Teutonic *sagen*, *zaagen*, to *saw*; properly, a piece cut off. This term, in its general sense, needs no explanation.] 1. In *mensuration*, a term most frequently applied to the part cut off from a circle by a chord.

Thus, the segment of a circle is a part of the area contained by an arc and its chord, as ACB. The chord is sometimes called the base of the segment.

An angle in a segment is the angle contained by two straight lines drawn from any point in its arc, and terminating in the extremities of its chord or base.—*Similar segments of circles* are those which contain equal angles, or whose arcs contain the same number of degrees.—*Segment of a sphere*, any part of it cut off by a plane, not passing through the centre.

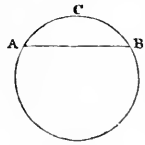

—2. In general, a part cut off or divided; as, the *segments* of a calyx.

SEG'NITUDE, } *n.* [from Lat. *segnis*.]  
SEG'NITY, } Sluggishness; dulness; inactivity. [Little used.]

SEG'REANT, *a.* In *her.*, a term used to express the griffin when standing upon its hind legs, with the wings elevated, and endorsed in the position of the lion when borne rampant.

SEG'REGATE, *v. t.* [L. *segrego*; *se*, from, and *grez*, flock.] To separate from others; to set apart.

SEG'REGATE, *a.* Select. [Little used.] *Segregate polygamy*, (*Polygamia segregata*, Linn.) a mode of inflorescence, when several florets comprehended within an antheridium, or a common calyx, are furnished also with proper perianths, as in the dandelion.

SEG'REGATED, *pp.* Separated; parted from others.

SEG'REGATING, *ppr.* Separating.  
SEG'REGATION, *n.* [Fr.] Separation from others; a parting.

SEGUE. [It., it follows.] In *music*, a word which, prefixed to a part, denotes that it is immediately to follow the last note of the preceding movement.

SEID'LITZ-WATER, *n.* The mineral water of Seidlitz, a village of Bohemia. Sulphate of magnesia, sulphate of soda, and carbonic acid, are its active ingredients.—*Seidlitz powders*, or *effervescent powders*, powders intended to produce the same effect as seidlitz-waters, though very different in composition. They are generally sold in separate papers, one containing 2 drachms of the potassa-tartrate of soda, mixed with 2 scruples of bicarbonate of soda, the other containing 35 grains of tartaric-acid. The former powder is dissolved in half a pint of water, and the latter in a separate wine-glassful; the solutions are then mixed, and taken in the act of effervescence.

SEIGNETTE-SALT, *n.* The same as Rochelle salt,—*which see*.

SEIGNEURIAL, *a.* (senn'rial.) [Fr. See *SEIGNIOR*.] 1. Pertaining to the lord of a manor; manorial.—2. Vested with large powers; independent.

SEIGNIOR, *n.* (see'nyor.) [Fr. *seigneur*; It. *signore*; Sp. *señor*; Port. *senhor*; from L. *senior*, elder; *senex*, old; Ir. *sean*.] A lord; the lord of a manor; but used also in the south of Europe as a title of honour. The Sultan of Turkey is sometimes called the *Grand Seigneur*.

SEIGNORAGE, or SEIGNORAGE, *n.* (see'nyorage.) An ancient prerogative of the crown, whereby it claimed a per-centage upon every ingot of gold and silver brought to the mint to be coined.

SEIGNORIAL, the same as *Seigneurial*.

SEIGNORIZE, *v. t.* (see'nyorize.) To lord it over. [Little used.]

SEIGNIORY, or SEIGNORY, *n.* (see'nyory.) [Fr. *seigneurie*.] 1. A lordship; a manor. In lower Canada the right of feudal superiority in real estate. The land held in seigniority, is said to amount to more than 15,000 square miles.—2. The power or authority of a lord; dominion.

O'Neal never had any *seignory* over that country, but what he got by encroachment upon the English. *Spenser.*

SEIN, or SEINE, *n.* [Sax. *segne*; Fr. *seine*; Arm. *seigne*; L. *sagena*; Gr. *σείνη*.] A large net for catching fish.

SEINER, *n.* A fisher with a sein or net. [Not much used.]

SEITY, *n.* [L. *se*, one's self.] Something peculiar to a man's self. [Not well authorised.]

SEIZABLE, *a.* That may be seized; liable to be taken.

SEIZE, *v. t.* [Fr. *saisir*; Arm. *seisza* or *sesya*; probably allied to *assess*, and to *sit*, *set*. The sense is to fall on, to throw one's self on, which is nearly the primary sense of *set*. It must be noticed that this word, in writers on law, is usually written *seize*; as also in composition, *disseize*, *disseisin*, *redisseize*. But except in law, it is usually or always written *seize*.] 1. To fall or rush upon suddenly and lay hold on; or to gripe or grasp suddenly. The tiger rushes from the thicket and *seizes* his prey. A dog *seizes* an animal by the throat. The hawk *seizes* a chicken with his claws. The officer *seizes* a thief.—2. To take possession by force, with or without right.

At last they *seize*

The sceptre, and regard not David's son.

*Milton.*

3. To invade suddenly; to take hold of; to come upon suddenly; as, a fever *seizes* a patient.

And hope and doubt alternate *seize* her soul.

*Pope.*

4. To take possession by virtue of a warrant or legal authority. The sheriff *seized* the debtor's goods; the whole estate was *seized* and confiscated. We say, to *arrest* a person, to *seize* goods.—5. To fasten; to fix. In *seamen's language*, to fasten two ropes or different parts of one rope together with a cord.—6. To make possessed; to put or to be in possession of; to have possession of; as, a griffin *seized* of his prey. A. B. was *seized* and possessed of the manor of Dale.—*To seize on or upon*, is to fall on and grasp; to take hold on; to take possession; Matt. xxi.—*To seize up*, a term used at sea; as, to *seize up* a man to the gratings, to be lashed.

SEIZED, *pp.* Suddenly caught or grasped; taken by force; invaded suddenly; taken possession of; fastened with a cord; having possession.

SEIZER, *n.* One that seizes.

SEIZIN, *n.* [Fr. *seizine*.] 1. In *law*, possession. *Seizin* is of two sorts, *seizin in deed* or *fact*, and *seizin in law*. *Seizin in fact* or *deed*, is actual or corporal possession; *seizin in law*, is when something is done which the law accounts possession or *seizin*, as enrolment, or when lands descend to an heir, but he has not yet entered on them. In this case, the law considers the heir as *seized* of the estate, and the person who wrongfully enters on the land is accounted a *disseizor*.—2. The act of taking possession. [Not used except in law].—3. The thing possessed; possession.—*Livery of seizin*. [See *LIVERY*.]—*Primer seizen*. [See *PRIMER*.]

SEIZING, *ppr.* Falling on and grasping suddenly; laying hold on suddenly; taking possession by force, or taking by warrant; fastening.

SEIZING, *n.* The act of taking or grasping suddenly. 2. In *seamen's language*, the operation of fastening together ropes with a cord; also, the cord or cords used for such fastening.

SEIZMOMETER, *n.* [Gr. *σεισμός*, an earthquake, and *μέτρον*, a measure.] An instrument for measuring the shock of earthquakes, and other concussions.

**SEIZOR**, *n.* In law, one who seizes or takes possession.

**SEIZURE**, *n.* The act of seizing; the act of laying hold on suddenly; as, the seizure of a thief.—2. The act of taking possession by force; as, the seizure of lands or goods; the seizure of a town by an enemy; the seizure of a throne by an usurper.—3. The act of taking by warrant; as, the seizure of contraband goods.—4. The state of being seized; as, with disease.—5. The thing taken or seized.—6. Gripe; grasp; possession.

And give me seizure of the mighty wealth.  
*Dryden.*

7. Catch; a catching.

Let there be no sudden seizure of a lapsed syllable, to play upon it. *Watts.*

**SE'JANT**, or **SE'JEANT**, *a.* In her.

sitting, like a cat, with the fore feet straight; applied to a lion or other beast.

—*Sejant rampant*, sitting with the two fore-feet lifted up.  
**SEJOIN'**, *v. t.* To separate. [*Not Eng. lish.*]



Sejant.

**SEJUN'GOUS**, *a.* [*L. sejugis; sear, six, and jugum, yoke.*] In bot., a sejugous leaf is a pinnate leaf having six pairs of leaflets.

**SEJUN'CTION**, *n.* [*L. sejunctio; se, from, and jungo, to join.*] The act of disjoining; a disuniting; separation. [*Little used.*]

**SEJUN'GIBLE**, *a.* [*supra.*] That may be disjoined. [*Little used.*]

**SEKE**, † for *Stck.* See *SICK.*

**SE'KOS**, *n.* [*Gr.*] A place in a temple in which pagans inclosed the images of their deities.

**SELA'CHIL**, *n.* The name given by Cuvier to the tribe of Chondropterygian fishes, which includes the sharks and rays.

**SE'LAH**, *n.* In the Psalms, supposed to signify silence or a pause in the musical performance of the song.

**SEL'COÜTH**, † *a.* [*Sax. sel, seld, rare, and couth, known.*] Rarely known; unusual; uncommon.

**SEL'DOM**, *adv.* [*Sax. selden, seldon; G. selten.* In Danish, *selshub*, [*sel and shape*], is a company, fellowship, or club. *Sel* probably signifies separate, distinct, coinciding with *L. solus*.] Rarely; not often; not frequently.

Wisdom and youth are seldom joined in one. *Hooker.*

**SEL'DOM**, *a.* Rare; unfrequent. [*Little used.*]

**SEL'DOMNESS**, *n.* Rareness; infrequency; uncommonness.

**SEL'D-SHOWN**, † *a.* [*Sax. seld and shown.*] Rarely shown or exhibited.

**SELE'CT'**, *v. t.* [*L. selectus, from seligo; se, from, and lego, to pick, cull, or gather.*] To choose and take from a number; to take by preference from among others; to pick out; to cull; as, to select the best authors for perusal; to select the most interesting and virtuous men for associates.

**SELECT'**, *a.* Nicely chosen; taken from a number by preference; choice; whence, preferable; more valuable or excellent than others; as, a body of select troops; a select company or society; a library consisting of select authors.

**SELECT'ED**, *pp. or a.* Chosen and taken by preference from among a number; picked; culled.

**SELECT'EDLY**, *adv.* With care in selection.

**SELECT'ING**, *ppr.* Choosing and taking from a number; picking out; culling.

**SELEC'TION**, *n.* [*L. selectio.*] 1. The act of choosing and taking from among a number; a taking from another by preference.—2. A number of things selected or taken from others by preference. I have a small but valuable selection of books.

**SELEC'TIVE**, *a.* Selecting; tending to select. [*Unusual.*]

**SELEC'TMAN**, *n.* [*select and man.*] In *New England*, a town officer chosen annually to manage the concerns of the town, provide for the poor, &c. Their number is usually from three to seven in each town, and these constitute a kind of executive authority.

**SELEC'TNESS**, *n.* The state of being select or well chosen.

**SELEC'TOR**, *n.* [*L.*] One that selects or chooses from among a number.

**SELE'NIATE**, *n.* A compound of selenic acid with a base; as *seleniate of soda*.

**SELE'NIC**, *a.* Pertaining to selenium; as, *selenic acid*, which is composed of one equivalent of selenium and three of oxygen. Selenic acid is formed when selenium is oxidized by fusion with nitre. It is very acid and corrosive, and resembles sulphuric acid very much. It has a great affinity for bases, forming with them salts called seleniates.

**SELE'NIUS ACID**, *n.* An acid derived from selenium. It is a compound of 1 equivalent of selenium and 2 of oxygen.

**SEL'ENITE**, *n.* [*Gr. selēnion, from selēnē, the moon; so called on account of its reflecting the moon's light with brilliancy.*] 1. Foliated or crystallized sulphate of lime. Selenite is a subspecies of sulphate of lime, of two varieties, massive and acicular.

**SELENI'IC**, } *a.* Pertaining to se-  
**SELENI'ICAL**, } lenite; resembling it, or partaking of its nature and properties.

**SELE'NIUM**, *n.* [*supra.*] An elementary acidifying and basifying substance, extracted from the pyrite of Fahlun in Sweden, and discovered in 1818 by Berzelius. In its general chemical habitudes it bears a resemblance to sulphur. It generally occurs in very small quantity in some of the varieties of iron pyrites. According to Dr. Prout, selenium constitutes the connecting link between sulphur and the metals. When precipitated, it appears as a red powder, which, when heated, melts, and on cooling, forms a brittle mass nearly black, but transmitting red light in their plates. When heated in the air it takes fire, burns with a blue flame, and produces a gaseous compound, oxide of selenium, which has a most penetrating and characteristic odour of putrid horse-radish.

**SELENIURET**, } *n.* A substance formed  
**SELENU'RET**, } by the combination of sulphur, phosphorus, the earths, or the metals with selenium.

**SELENIURETTED HYDROGEN**, *n.* A gaseous compound of hydrogen and selenium, obtained by the action of acids on metallic seleniurets. It has a smell resembling that of sulphuretted hydrogen, and when respired, is even more poisonous than that gas. Seleniuretted hydrogen is absorbed by water, and precipitates most metallic solutions, yielding seleniurets, corresponding to the respective oxides.

**SELENOGRAPH'IC**, } *a.* [*infra.*]  
**SELENOGRAPHICAL**, } Belonging to selenography.

**SELENOGRAPHY**, *n.* [*Gr. selēnē, the moon, and γραφω, to describe.*] A description of the moon and its phenomena; a branch of cosmography.

**SELF**, *a. or pron. plur. Selves;* used chiefly in composition. [*Sax. self, sylf; Dan. selv; G. selbst.* The primary sense of this word is probably to set or unite, or to separate from others. See *SELVEDGE*.] 1. In old authors, this word sometimes signifies particular, very, or same. "*And on thām sylfian gear;*" in that same year, that very year; *Sax. Chron.* A.D. 1052, 1061.

Shoot another arrow that self way.

On these self hills. *Shak.*  
At that self moment enters Palamon. *Rulegh.*

*Dryden.*

In this sense, *self* is an adjective, and is now obsolete, except when followed by *same*; as, on the *self-same* day; the *self-same* hour; the *self-same* thing; which is tautology; *Math.* viii.—2. In present usage, *self* is united to certain personal pronouns and pronominal adjectives, to express emphasis or distinction; also when the pronoun is used reciprocally. Thus for emphasis, *I myself* will write; *I will examine for myself.* Thou *thyself* shalt go; thou shalt see for *thyself.* You *yourself* shall write; you shall see for *yourself.* He *himself* shall write; he shall examine for *himself.* She *herself* shall write; she shall examine for *herself.* The child *itself* shall be carried; it shall be present *itself.* Reciprocally, *I* *abhor myself;* thou *enrichest thyself;* *I* *loves himself;* she *admires herself;* it *pleases itself;* we *value ourselves;* ye *hurry yourselves;* they *see themselves.* *I* *did not hurt him, he hurt himself;* he *did not hurt me, I hurt myself.* Except when added to pronouns used reciprocally, *self* serves to give emphasis to the pronoun, or to render the distinction expressed by it more emphatical. "*I myself* will decide," not only expresses my determination to decide, but the determination that no other shall decide. *Himself, herself, themselves,* are used in the nominative case, as well as in the objective.

Jesus *himself* baptized not, but his disciples; *John* iv. : See *Matth.* xxiii. 4.

3. *Self* is sometimes used as a noun, noting the individual subject to his own contemplation or action, or noting identity of person. Consciousness makes every one to be what he calls *self.*

A man's *self* may be the worst fellow to converse with in the world. *Pope.*

4. It also signifies personal interest, or love of private interest; selfishness.

The fondness we have for *self*...furnishes another long rank of prejudices. *Watts.*

*Self* is much used in composition.

**SELF-ABASED**, *a.* [*self and abase.*]

Humbled by conscious guilt or shame.

**SELF-ABASEMENT**, *n.* Humiliation or abasement proceeding from consciousness of inferiority, guilt, or shame.

**SELF-ABASING**, *a.* Humbling by the consciousness of guilt or by shame.

**SELF-ABHORRING**, *a.* Abhorring one's self.

**SELF-ABÜSE**, *n.* [*self and abuse.*] The abuse of one's own person or powers.

—2. Onanism.

**SELF-ACCUSED**, *a.* Accused by one's own conscience.

SELF-DECEIT

**SELF-ACCUSING**, *a.* [*self and accuse.*] Accusing one's self; as, a *self-accusing* look.

**SELF-ADMIRATION**, *n.* Admiration of one's self.

**SELF-AFFAIRS**, *n. plur.* [*self and affair.*] One's own private business.

**SELF-ALFRIGHTED**, *a.* [*self and fright.*] Frightened at one's self.

**SELF-AGGRANDIZEMENT**, *n.* The aggrandizement or exaltation of one's self.

**SELF-APPLAUSE**, *n.* (self-applauz'.) Applause of one's self.

**SELF-APPROVING**, *a.* That approves of one's own conduct.

**SELF-BANISHED**, *a.* [*self and banish.*] Exiled voluntarily.

**SELF-BEGOTTEN**, *a.* [*self and beget.*] Begotten by one's own powers.

**SELF-BORN**, *a.* [*self and born.*] Born or produced by one's self.

**SELF-CENTRED**, *a.* [*self and centre.*] Centred in itself.

The earth *self-centred* and unmoved. *Dryden.*

**SELF-CHARITY**, *n.* [*self and charity.*] Love of one's self.

**SELF-COMMAND**, *n.* That steady equanimity, which enables a man in every situation to exert his reasoning faculty with coolness, and to do what existing circumstances require.

**SELF-CONCEIT**, *n.* [*self and conceit.*] A high opinion of one's self; vanity.

**SELF-CONCEITED**, *a.* Vain; having a high or overweening opinion of one's own person or merits.

**SELF-CONCEITEDNESS**, *n.* Vanity; an overweening opinion of one's own person or accomplishments.

**SELF-CONDEMNATION**, *n.* Condemnation by one's own conscience.

**SELF-CONDEMNING**, *a.* Condemning one's self.

**SELF-CONFIDENCE**, *n.* [*self and confidence.*] Confidence in one's own judgment or ability; reliance on one's own opinion or powers, without other aid.

**SELF-CONFIDENT**, *a.* Confident of one's own strength or powers; relying on the correctness of one's own judgment, or the competence of one's own powers, without other aid.

**SELF-CONFIDING**, *a.* Confiding in one's own judgment or powers, without the aid of others.

**SELF-CONSCIOUS**, *a.* [*self and conscious.*] Conscious in one's self.

**SELF-CONSCIOUSNESS**, *n.* Consciousness within one's self.

**SELF-CONSIDERING**, *a.* [*self and consider.*] Considering in one's own mind; deliberating.

**SELF-CONSUMING**, *a.* [*self and consume.*] That consumes itself.

**SELF-CONTRADICTION**, *n.* [*self and contradiction.*] The act of contradicting itself; repugnancy in terms. To be and not to be at the same time, is a *self-contradiction*; a proposition consisting of two members, one of which contradicts the other.

**SELF-CONVICTED**, *a.* [*self and convict.*] Convicted by one's own consciousness, knowledge, or avowal.

**SELF-CONVICTION**, *n.* Conviction proceeding from one's own consciousness, knowledge, or confession.

**SELF-CREATED**, *a.* Created by one's self; not formed or constituted by another.

**SELF-DECEIT**, *n.* [*self and deceit.*] Deception respecting one's self, or that originates from one's own mistake; self-deception.

SELF-EXISTENCE

**SELF-DECEIVED**, *a.* [*self and deceive.*] Deceived or misled respecting one's self by one's own mistake or error.

**SELF-DECEPTION**, *n.* [*supra.*] Deception concerning one's self, proceeding from one's own mistake.

**SELF-DEFENCE**, *n.* (self-defens'.) [*self and defence.*] The act of defending one's own person, property, or reputation. A man may be justifiable in killing another in *self-defence*.

**SELF-DELUSION**, *n.* [*self and delusion.*] The delusion of one's self, or respecting one's self.

**SELF-DENIAL**, *n.* [*self and denial.*] The denial of one's self; the forbearing to gratify one's own appetites or desires.

**SELF-DENYING**, *a.* Denying one's self; forbearing to indulge one's own appetites or desires.

**SELF-DESTRUCTION**, *n.* [*self and destruction.*] The destruction of one's self; voluntary destruction.

**SELF-DESTRUCTIVE**, *a.* Tending to the destruction of one's self.

**SELF-DETERMINATION**, *n.* [*self and determination.*] Determination by one's own mind; or determination by its own powers, without extraneous impulse or influence.

**SELF-DETERMINING**, *a.* Determining by or of itself; determining or deciding without extraneous power or influence; as, the *self-determining* power of the will.

**SELF-DEVOTED**, *a.* [*self and devote.*] Devoted in person, or voluntarily devoted in person.

**SELF-DEVOTEMENT**, *n.* The devoting of one's person and services voluntarily to any difficult or hazardous employment.

**SELF-DEVOTING**, *a.* Devoting one's self.

**SELF-DEVOURING**, *a.* [*self and devour.*] Devouring one's self or itself.

**SELF-DOOMED**, *a.* Doomed by one's self.

**SELF-EDUCATED**, *a.* Educated by one's own efforts.

**SELF-ELECTED**, *a.* Elected by himself.

**SELF ELECTIVE**, *a.* Having the right to elect one's self, or as a body, of electing its own members.

**SELF-ENJOYMENT**, *n.* [*self and enjoyment.*] Internal satisfaction or pleasure.

**SELF-ESTEEM**, *n.* [*self and esteem.*] The esteem or good opinion of one's self.

**SELF-ESTIMATION**, *n.* The esteem or good opinion of one's self.

**SELF-EVIDENCE**, *n.* [*self and evidence.*] Evidence or certainty resulting from a proposition without proof; evidence that ideas offer to the mind upon bare statement.

**SELF-EVIDENT**, *a.* Evident without proof or reasoning; that produces certainty or clear conviction upon a bare presentation to the mind; as, a *self-evident* proposition or truth. That two and three make five, is *self-evident*.

**SELF-EXALTATION**, *n.* The exaltation of one's self.

**SELF-EXAMINATION**, *n.* [*self and examination.*] An examination or scrutiny into one's own state, conduct, and motives, particularly in regard to religious affections and duties.

**SELF-EXISTENCE**, *n.* [*self and existence.*] Inherent existence; the existence possessed by virtue of a

SELF-OPINIONED

being's own nature, and independent of any other being or cause; an attribute peculiar to God.

**SELF-EXISTENT**, *a.* Existing by its own nature or essence, independent of any other cause. God is the only *self-existent* being.

**SELF-FACED**, *a.* A term used to denote the natural face or surface of a flag-stone, in contradistinction to dressed or hewn.

**SELF-FLATTERING**, *a.* [*self and flatter.*] Flattering one's self.

**SELF-GLOARIOUS**, *a.* [*self and glorious.*] Springing from vain glory or vanity; vain; boastful.

**SELF-GRATULATION**, *n.* Gratulation of one's self.

**SELF-HEAL**, *n.* [*self and heal.*] A British plant of the genus *Prunella*, the *P. vulgaris*. [*See PRUNELLA.*]

**SELF-HEALING**, *a.* Having the power or property of healing itself. The *self-healing* power of living animals and vegetables is a property as wonderful as it is indicative of divine goodness.

**SELF-IMPOSTURE**, *n.* [*self and imposture.*] Imposture practised on one's self.

**SELF-INTEREST**, *n.* [*self and interest.*] Private interest; the interest or advantage of one's self.

**SELF-INTERESTED**, *a.* Having self-interest; particularly concerned for one's self.

**SELF-INVITED**, *a.* Come without being asked.

**SELF-JUDGING**, *a.* Judging one's self.

**SELF-KNOWING**, *a.* [*self and know.*] Knowing of itself, or without communication from another.

**SELF-KNOWLEDGE**, *n.* The knowledge of one's own real character, abilities, worth, or demerit.

**SELF-LÖVE**, *n.* [*self and love.*] The love of one's own person or happiness; an instinctive principle in the human mind, which impels every rational creature to preserve his life, and promote his own happiness.

*Self-love*, the spring of motion, acts the soul. *Pope.*

**SELF-LÖVING**, *a.* Loving one's self.

**SELF-LUMINOUS BODIES**, Those bodies which possess in themselves the property of giving out light; such as the sun, fixed stars, flames of all kinds, bodies which shine by being heated or rubbed. Bodies which shine by reflected light are termed *non luminous*.

**SELF-MOTION**, *n.* [*self and motion.*] Motion given by inherent powers, without external impulse; spontaneous motion.

Matter is not endued with *self-motion*. *Cheyne.*

**SELF-MÖVED**, *a.* [*self and move.*] Moved by inherent power without the aid of external impulse.

**SELF-MÖVING**, *a.* Moving or exciting to action by inherent power, without the impulse of another body or extraneous influence.

**SELF-MURDER**, *n.* [*self and murder.*] The murder of one's self; suicide.

**SELF-MURDERER**, *n.* One who voluntarily destroys his own life.

**SELF-NEGLECTING**, *n.* [*self and neglect.*] A neglecting of one's self.

*Self-love* is not so great a sin as *self-neglecting*. *Shnk.*

**SELF-OPINIONED**, *a.* Valuing one's own opinion highly.

**SELF-PLEASING**, *a.* [*self* and *please*.] Pleasing one's self; gratifying one's own wishes.

**SELF-POSSESS'ION**, *n.* The possession of one's powers; calmness; self-command.

**SELF-PRAISE**, *n.* [*self* and *praise*.] The praise of one's self; self-applause.

**SELF-PRESERVA'TION**, *n.* [*self* and *preservation*.] The preservation of one's self from destruction or injury.

**SELF-PRESERV'ING**, *a.* Preserving one's self.

**SELF-PROP'AGATING**, *a.* Propagating by itself or himself.

**SELF-REG'ISTERING**, *a.* That registers itself; as, a thermometer which marks the extreme points of its range within a given time.

**SELF-REG'ULATED**, *a.* Regulated by one's or itself.

**SELF-RELI'ANCE**, *n.* Reliance on one's own powers.

**SELF-RELY'ING**, *a.* Depending on one's self.

**SELF-REPEL'LING**, *a.* [*self* and *repel*.] Repelling by its own inherent power.

**SELF-REPRO'ACHED**, *a.* Reproached by one's own conscience.

**SELF-REPROVED**, *a.* [*self* and *reprove*.] Reproved by consciousness or one's own sense of guilt.

**SELF-REPROV'ING**, *a.* Reproving by consciousness.

**SELF-RESTRAINED**, *a.* [*self* and *restrain*.] Restrained by itself, or by one's own power or will; not controlled by external force or authority.

**SELF-RESTRAINING**, *a.* Restraining or controlling itself.

**SELF-RESTRAINT**, *n.* Restraint over one's self.

**SELF-RIGHT'EOUS**, *a.* Righteous in one's own esteem.

**SELF-RIGHT'ONESS**, *n.* Reliance on one's own supposed righteousness.

**SELF-SACRIFI'ING**, *a.* Yielding up one's own interest, feelings, &c.; sacrificing one's self.

**SELF-SAME**, *a.* [*self* and *same*.] Numerically the same; the very same; identical.

**SELF-SAT'ISFIED**, *a.* Satisfied with one's self.

**SELF-SAT'ISFYING**, *a.* Giving satisfaction to one's self.

**SELF-SEEKER**, *n.* One who seeks only his own interest.

**SELF-SEEKING**, *a.* [*self* and *seek*.] Seeking one's own interest or happiness; selfish.

**SELF-SLAUGHTER**, *n.* [*self-slan'ter*.] [*self* and *slaughter*.] The slaughter of one's self.

**SELF-SUBDU'ED**, *a.* [*self* and *subdue*.] Subdued by one's own power or means.

**SELF-SUFFI'CIENCY**, *n.* [*self* and *sufficiency*.] An overweening opinion of one's own strength or worth; excessive confidence in one's own competence or sufficiency.

**SELF-SUFFI'CIENT**, *a.* Having full confidence in one's own strength, abilities or endowments; whence, haughty; overbearing.

**SELF-TAUGHT**, *a.* Taught by one's self.

**SELF-TORMENT'ING**, *a.* [*self* and *torment*.] Tormenting one's self; as, *self-tormenting* sin.

**SELF-UPBRAIDING**, *a.* Reproaching one's self.

**SELF-VIOLENCE**, *n.* Violence to one's self.

**SELF-WILL'**, *n.* [*self* and *will*.] One's own will; obstinacy.

**SELF-WILL'ED**, *a.* Governed by one's own will; not yielding to the will or wishes of others; not accommodating or compliant; obstinate.

**SELF-WOR'SHIP**, *n.* The idol'izing of one's self.

**SELF-WRONG'**, *n.* [*self* and *wrong*.] Wrong done by a person to himself.

**SELF'ISH**, *a.* Regarding one's own interest chiefly or solely; void of regard for others; influenced in actions by a view to private advantage.

**SELF'ISHLY**, *adv.* In a selfish manner; with regard to private interest only or chiefly.

**SELF'ISHNESS**, *n.* The exclusive regard of a person to his own interest or happiness; or that supreme self-love or self-preference, which leads a person in his actions to direct his purposes to the advancement of his own interest, power, or happiness, without regarding the interest of others. Selfishness, in its worst or unqualified sense, is the very essence of human depravity, and stands in direct opposition to *benevolence*, which is the essence of the divine character. As God is *love*, so man, in his natural state, is *selfishness*.

*Selfishness*... a vice utterly at variance with the happiness of him who harbours it, and as such, condemned by self-love.

*Mackintosh.*

**SELF'LESS**, *a.* Having no regard to self.

**SELF'NESS**, *† n.* Self-love; selfishness.

**SEL'NUM**, *n.* Milk parsley, a genus of herbs, natives of Europe. [*See MILK PARSLEY*.]

**SEL'LION**, *n.* A ridge of land. [*Local*.]

**SELL**, for *Sell*; and *Sells* for *Selves*. [*Scot*.]

**SELL**, *† n.* [*Fr. selle*; *L. sella*.] A saddle, and a throne.

**SELL**, *v. t. pret.* and *pp. sold*. [*Sax. selan, sellan, sylan* or *syllan*, to give, grant, yield, assign or *sell*; *syllan* to *vote*, to give in compensation, to *give to boot*. The primary sense is to deliver, send, or transfer, or to put off. The sense of *sell*, as we now understand the word, is wholly derivative; as we see by the Saxon phrases, *syllan* to *apene*, to give for one's own; *syllan* to *gyfe*, to bestow for a gift, to bestow or confer gratis.] 1. To transfer property or the exclusive right of possession to another for an equivalent in money. It is correlative to *buy*, as one party *buys* what the other *sells*. It is distinguished from *exchange* or *barter*, in which one commodity is given for another; whereas in *selling* the consideration is money, or its representative in current notes. To this distinction there may be exceptions. "Eau *sold* his birthright to Jacob for a mess of pottage." But this is unusual. "Let us *sell* Joseph to the Ishmaelites—and they *sold* him for twenty pieces of silver;" Gen. xxxvii. Among the Hebrews, parents had power to *sell* their children.—2. To betray; to deliver or surrender for money or a reward; as, to *sell* one's country.—3. To yield or give for a consideration. The troops fought like lions, and *sold* their lives dearly; that is, they yielded their lives, but first destroyed many, which made it a dear purchase for their enemies.—4. In

*Scip.*, to give up to be harassed and made slaves.

He *sold* them into the hands of their enemies; Judges ii.

5. To part with; to renounce or forsake.

Buy the truth and *sell* it not; Prov. xxiii.

To *sell* one's self to do evil, to give up one's self to be the slave of sin, and to work wickedness without restraint; 1 Kings xxi; 2 Kings vii.

**SELL**, *v. i.* To have commerce; to practise selling.—2. To be sold. Corn *sells* at a good price.

**SELL**, *n.* In *arch*. [*See SELL*.]

**SELL'LANDER**, *n.* A dry scab in a horse's hough or pastern, owing to a want of cleanliness.

**SEL'LA TURC'ICA**, *n.* (so named from its supposed resemblance to a Turkish saddle.) A cavity in the spheroid bone, containing the pituitary gland, and surrounded by the four clinoid processes.

**SELL'ER**, *n.* The person that sells; a vender.

**SELL'ING**, *ppr.* Transferring the property of a thing for a price or equivalent in money.—2. Betraying for money.—To *sell* the *pass*, to betray one's countrymen, by giving information to the authorities. [*An Irish phrase*.]—*Selling out*, among stockbrokers, a transfer of the share of stock which one person holds to another person, in distinction from *buying in*, which is purchasing the share that another has in the stocks.—*Selling out* is also said of an officer who is permitted to retire from the service, and sell his commission; in distinction from *buying in*, or purchasing a commission.

**SELT'ZER**, or **SELT'ERS-WATER**, *n.* A highly-prized medicinal mineral water found at Brunnen-Selters, in the valley of the Lahn, Nassau, Germany. It contains chloride of sodium, carbonates of magnesia, soda, and lime, and a large quantity of free carbonic acid.

**SELVAGE**. *See SELVEDGE*.

**SELVAGEE'**, *n.* A kind of skin of rope-yarn, wound round with yarns or marline, used for stoppers, straps, &c.

**SELV'EDGE**, or **SEL'VAGE**, *n.* [*D. zelf-hant*, self-border; *G. sahl-leiste*, hall-list. The first syllable appears to be *self*, and the last is *edge*.] The edge of cloth, where it is closed by complicating the threads; a woven border, or border of close work; Ex. xxvii.—2. In *ships*, a piece of very flexible kind of rope, composed of yarns not twisted together, but laid parallel, and confined by external marline.

**SELV'EDGED**, or **SELV'AGED**, *a.* Having a selvedge.

**SELVES**, *plur.* of *Self*.

**SEM'APHORE**, *n.* [*Gr. σημα*, a sign, and *φορος*, to bear.] A term mostly synonymous with telegraph, but which may be applied to any means whatever employed to communicate intelligence by signals.

**SEMAPHOR'ICALLY**, *adv.* By means of a telegraph.

**SEMATOL'OGY**, *n.* [*Gr. σημα*, a sign, and *λογος*, discourse.] A word invented by Mr. Smart, author of Walker's Dictionary Remodelled, and applied by him as the name of a treatise on the doctrine of *signs*, particularly of verbal signs, in the operations of thinking and reasoning, comprehend-

ing the theory of grammar, logic, and rhetoric.

**SEM'BLABLE**, † *a.* [Fr.] Like; similar; resembling.

**SEM'BLABLY**, † *adv.* In like manner.

**SEM'BLANCE**, *n.* [Fr. *id.*; It. *sembianza*; Sp. *semeja* and *semejanza*; from the root of *similar*.] 1. Likeness; resemblance; actual similitude; as, the *semblance* of worth; *semblance* of virtue.

The *semblances* and imitations of shells. Woodward.

2. Appearance; show; figure; form. Their *semblance* kind, and mild their gestures were. Fairfax.

**SEM'BLANT**, † *n.* Show; figure; resemblance.

**SEM'BLANT**, † *a.* Like; resembling. **SEM'BLATIVE**, *a.* Resembling; fit; suitable; according to.

And all is *semblative* a woman's part. Shak.

**SEM'BLE**, † *v. t.* [Fr. *sembler*.] To imitate; to represent or to make similar.

Where *sembling* art may carve the fair effect. Prior.

**SEME'**, *a.* [Fr. *sown*.] In *her.*, a term employed to describe a field, or charge powdered, or strewed over with figures, as stars, billets, crosses, &c.



Semees-de-lis.

**SEMECAR'PUS**, *n.* [Gr. *σημιος*, a mark, and *καρπος*, fruit.]

A small Indian genus of plants, nat. order Terebinthaceæ, so named from the remarkable property possessed by the juice of the fruit, whence it is commonly called marking nut.—*S. anacardium*, has long been known for the corrosive resinous juice contained in the nut. This juice is at first of a pale milk colour, but when the fruit is perfectly ripe, it is of a pure black colour, and very acrid. It is employed in medicine by the natives of India, and to mark all kinds of cotton cloth. The bark is astringent, and yields various shades of a brown dye. A soft, tasteless, brownish coloured gum exudes from the bark.

**SEMEIOLOG'ICAL**, *a.* Relating to the doctrine of signs, or symptoms of diseases.

**SEMEIO'TIC**, *a.* [Gr. *σημιων*, a sign.] Relating to the signs or symptoms of diseases.

**SEMEIO'TICS**, **SEMEIO'LOGY**, *n.* [Gr. *σημιων*, and *λογος*, discourse.] In *medical science*, that branch which teaches how to judge of all the symptoms in the human body, whether healthy or diseased. It is now merged in *symptomatology*.

**SE'MEN**, *n.* [L.] The seed or prolific liquor of animals.—2. The seed of plants, or the matured ovule.

**SEMES'TER**, *n.* [L. *semestris*, *sex*, six, and *mensis*, month.] A period or term of six months.

**SEM'L**, *L. semi*, Gr. *ημι*, in composition, signifies half.

**SEMI-ACID'IFIED**, *a.* or *pp.* Half acidified. [See **ACIDIFY**.]

**SEMI-AMPLEX'CAUL**, *a.* [L. *semi*, *amplexus*, or *amplexor*, to embrace, and *caulis*, stem.] Partially amplexicaul. In *bot.*, embracing the stem half around, as a leaf.

**SEMI-AN'NUAL**, *a.* [*semi* and *annual*.] Half yearly.

**SEMI-AN'NUALLY**, *adv.* Every half year.

**SEMI-AN'NULAR**, *a.* [L. *semi* and *annulus*, a ring.] Having the figure of a half circle; that is, half round.

**SEMI-AP'ERTURE**, *n.* [*semi* and *aperture*.] The half of an aperture.

**SEMI-A'RIAN**, *n.* [See **ARIAN**.] In *eccles. history*, the Semi-arians were a branch of the Arians, who in appearance condemned the errors of Arius, but acquiesced in some of his principles, disguising them under more moderate terms. They did not acknowledge the Son to be consubstantial with the Father, that is, of the same substance, but admitted him to be of a like substance with the Father, not by nature, but by a peculiar privilege.

**SEMI-A'RIAN**, *a.* Pertaining to semi-arianism.

**SEMI-A'RIANISM**, *n.* The doctrines or tenets of the Semi-arians. The *semi-arianism* of modern times consists in maintaining the Son to have been from all eternity begotten by the will of the Father.

**SEMI-BARBA'RIAN**, *a.* [*semi* and *barbarian*.] Half savage; partially civilized.

**SEMI'BREVE**, *n.* [*semi* and *breve*; formerly written *Semi-bref*.] In *music*, a note of half the duration or time of the breve, a note not now in use. The *semi-breve* is the longest note now used, and the measure note by which all others are regulated. It contains the time of two minims, four crotchets, eight quavers, sixteen semiquavers, and thirty-two demisemiquavers.



Semibreve.

**SEMI-CAL'CINED**, *a.* [*semi* and *calcine*.] Half calcined; as, *semi-calcined* iron.

**SEMI-CAS'TRATE**, *v. t.* To deprive of one testicle.

**SEMI-CASTRA'TION**, *n.* Half castration; deprivation of one testicle.

**SEMI-CHAOT'IC**, *a.* Partially chaotic.

**SEMI-CHO'RUS**, *n.* A short chorus performed by a few singers.

**SEMI-CHRIS'TIANIZED**, *a.* Half christianized.

**SEMI'CIRCLE**, *n.* [*semi* and *circle*.] The half of a circle; the part of a circle comprehended between its diameter and half of its circumference.—2. Any body in the form of a half circle.

**SEMI'CIRCLED**, } *a.* Having the  
**SEMICIR'CLAR**, } form of a half circle.—*Semicircular canals*, in *anat.*, the name given to three canals from their figure. They belong to the organ of hearing, are situated in the petrous portion of the temporal bone, and open into the vestibule. [*Semicircular* is generally used.]

**SEMI'COLON**, *n.* [*semi* and *colon*.] In *gram.*, and *punctuation*, the point [;] the mark of a pause to be observed in reading or speaking, of less duration than the colon, double the duration of the comma, or half the duration of the period. It is used to distinguish the conjunct members of a sentence.

**SEMI-COLUMN**, *n.* A half column.

**SEMI-COLUM'NAR**, *a.* [*semi* and *columnar*.] Like a half column; flat on one side and round on the other; a botanical term, applied to a stem, leaf, or petiole.

**SEMI-COMPA'CT**, *a.* [*semi* and *com-*

*pack*.] Half compact; imperfectly indurated.

**SEMI-CRUSTA'CEOUS**, *a.* [*semi* and *crustaceous*.] Half crustaceous.

**SEMI-CRYS'TALLINE**, *a.* Half crystallized.

**SEMICUB'ICAL PARABOLA**, *n.* In *analysis*, a curve of the second order, defined by this property, that the cubes of the ordinates are proportional to the squares of the corresponding abscissa. This curve is the evolute of the common parabola.

**SEMI-CU'PIUM**, *n.* [Gr. *εμικύπελλον*.] A half-bath, or one that covers only the lower extremities and hips.

**SEMI-CYLIN'DRIC**, } *a.* [*semi* and  
**SEMI-CYLIN'DRICAL**, } *cylindric*.] Half cylindrical.—*Semicylindrical leaf*, one that is elongated, flat on one side, round on the other.

**SEMI-DEIST'ICAL**, *a.* Half deistical; bordering on deism.

**SEMI-DIAM'ETER**, *n.* [*semi* and *diameter*.] Half the diameter; a right line or the length of a right line drawn from the centre of a circle or sphere to its circumference; a radius.

**SEMI-DIAPA'SON**, *n.* [*semi* and *diapason*.] In *music*, an imperfect octave, or an octave diminished by a lesser semitone.

**SEMI-DIAPEN'TE**, *n.* An imperfect fifth; in *music*, air.

**SEMI-DIAPHANE'ITY**, *n.* [See **SEMI-DIAPHANOUS**.] Half or imperfect transparency. [*Little used*.] [Instead of this, *translucency* is now used.]

**SEMI-DIAPH'ANOUS**, *a.* [*semi* and *diaphanous*.] Half or imperfectly transparent. [Instead of this, *translucent* is now used.]

**SEMI-DIATES'SARON**, *n.* [*semi* and *diatessarion*.] In *music*, an imperfect or defective fourth.

**SEMI-DITONE**, or **SEMI-DI'TONO**, *n.* [*semi* and It. *ditono*.] In *music*, a lesser third, having its terms as 6 to 5; a hemiditone.

**SEMI-DOUBLE**, *n.* [*semi* and *double*.] In the *Romish breviary*, an office or feast celebrated with less solemnity than the double ones, but with more than the single ones.

**SEMI-FLO'R'ET**, † See **SEMI-FLOSCULE**.

**SEMI-FLOSCULE**, † *n.* [*semi* and *floscule*.] A floscule whose corolla consists of a single ligule, i. e. a single strap-shaped petal; as the floscules of *Leontodon Taraxacum*, or dandelion.

**SEMI-FLOS'CULOUS**, *a.* [*semi* and *L. flosculus*, a little flower. *Semifloscular* is also used, but is less analogical.] Composed of semiflorets or ligulate florets; as, a *semiflosculous* flower.

**SEMI-FLU'ID**, *a.* [*semi* and *fluid*.] Imperfectly fluid.

**SEMI-FORMED**, *a.* [*semi* and *formed*.] Half formed; imperfectly formed; as, *semi-formed* crystals.

**SEMI-HOR'AL**, *a.* Half hourly.

**SEMI-IN'DURATED**, *a.* [*semi* and *indurated*.] Imperfectly indurated or hardened.

**SEMI-LAPID'IFIED**, *a.* [*semi* and *lapidified*.] Imperfectly changed into stone.

**SEMI-LENTIC'ULAR**, *a.* [*semi* and *lenticular*.] Half lenticular or convex; imperfectly resembling a lens.

**SEMI-LIG'NEOUS STEM**. In *bot.*, a stem which is woody at the base, and herbaceous at the top; as, the common rue, sage, and thyme.



SEMI'LUNAR, } *a.* [Fr. *semilunaire*;  
SEMI'LUNARY, } *L. semi* and *luna*,  
moon.] Resembling in form a half  
moon.—*Semilunar ganglia*, in *anat.*,  
the ganglia formed by the great sym-  
phatic nerve on its entrance into the  
abdomen, from which nerves are sent  
to all the viscera.—*Semilunar valves*,  
the three valves at the beginning of  
the pulmonary artery and aorta; so  
named from their half-moon shape.

SEMI-MEMBRANEOSE MUSCLE, *n.*  
In *anat.*, a muscle of the thigh, so  
called from the long flat membrane-  
like tendon at its upper part. It  
serves to bend the leg.

SEMI-METAL, *n.* [*semi* and *metal*.]  
Among the old chemists, a metal that  
is not malleable, as bismuth, arsenic,  
nickel, cobalt, zinc, antimony, manga-  
nese, tungsten, molybden, and uranite.

SEMI-METALLIC, *a.* Pertaining to a  
semi-metal, or partaking of its nature  
and qualities.

SEMI-MINIM, *n.* In *music*, a half  
minim or crotchet.

SEMINAL, *a.* [Fr. from *seminalis*,  
from *semen*, seed; from the root of  
*sow*.] 1. Pertaining to seed, or to the  
elements of production.—2. Contained  
in seed; radical; rudimental; original;  
as, *seminal* principles of generation;  
*seminal* virtue.—*Seminal leaf*, the same  
as seed-leaf.

SEMINAL, *n.* Seminal state.

SEMINALITY, *n.* The nature of seed;  
or the power of being produced.

SEMINARIST, *n.* [from *seminary*.]  
A Romish priest educated in a foreign  
seminary.

SEMINARIZE, † *v. t.* To sow or plant.

SEMINARY, *n.* [Fr. *séminaire*; *L.*  
*seminarium*, from *semen*, seed; *semino*,  
to sow.] 1. † A seed-plot; ground  
where seed is sown for producing  
plants for transplantation; a nursery;  
as, to transplant trees from a *semi-  
nary*.—2. The place or original stock  
whence anything is brought.

This stratum, being the *seminary* or  
promptuary, furnishing matter for the for-  
mation of animal and vegetable bodies. †  
*Woodward.*

3. † Seminal state.—4. Source of propa-  
gation.—5. A place of education; any  
school, academy, college, or university,  
in which young persons are instructed  
in the several branches of learning  
which may qualify them for their future  
employments.—6. *Seminary priest*, a  
Roman catholic priest educated in a  
seminary; a seminarist.

SEMINARY, *a.* Seminal; belonging to  
seed.

SEMINATE, *v. t.* [*L. semino*.] To sow;  
to spread; to propagate.

SEMINATION, *n.* [*L. seminatio*.] 1.  
The act of sowing.—2. In *bot.*, the  
natural dispersion of seeds. The seeds  
of plants are dispersed in various ways.  
Some are heavy enough to fall directly  
to the ground; others are furnished  
with a pappus or down, by means of  
which they are dispersed by the wind;  
while others are contained in elastic  
capsules, which, bursting open with  
considerable force, scatter the seeds.—  
3. The process of seeding.

SEMINED, † *a.* Thick covered, as with  
seeds.

SEMINIFEROUS, *a.* [*L. semen*, seed;  
and *fero*, to produce.] Seed-bearing;  
producing seed.

SEMINIFICAL, } *a.* [*L. semen*, seed,  
SEMINIFICAL, } and *facio*, to make.]  
Forming or producing seed.

SEMINIFICATION, *n.* Propagation  
from the seed or seminal parts.

SEMI-NYMPH, In *entom.*, the nymph  
of insects which undergo a slight change  
only in passing to a perfect state.

SEMIOLÓGICAL, *a.* Relating to the  
doctrines of signs or symptoms of  
diseases.

SEMIOLÓGY, *n.* [Gr. *σημειωσις* and *λογος*.]  
That part of medicine which treats of  
the signs of diseases. It is now merged  
in *Symptomatology*.

SEMI-OPAQUE, } *a.* [*L. semi* and  
SEMI-OPACOUS, } *opacus*.] Half  
transparent only.

SEMI-OPAL, *n.* A variety of opal.

SEMI-ORBITULAR, *a.* [*semi* and  
*orbicular*.] Having the shape of a  
half orb or sphere.

SEMI-ORDINATE, *n.* [*semi* and  
*ordinate*.] In the *conic sections*, the  
half of an ordinate; but the semi-  
ordinate is now called the ordinate.  
[See *ORDINATE*.]

SEMI-OSSEOUS, *a.* [*semi* and *osseous*.]  
Of a bony nature, but only half as hard  
as bone.

SEMIO'TIC, *a.* [Gr. *σημειωσις*.] Relating  
to the signs or symptoms of diseases.

SEMI-OVATE, *a.* [*semi* and *ovate*.]  
Half ovate.

SEMI-OXYGENATED, or SEMI-  
OXYGENIZED, *a.* Combined with  
oxygen only in part.

SEMI-PAGAN, *a.* Half pagan.

SEMI-PALMATE, } *a.* [*semi* and  
SEMI-PALMATED, } *palmate*.] Half  
palmated or webbed. Having the toes  
connected together by a web, extend-  
ing along only their proximal half.

SEMIPIED, *n.* [*semi* and *L. pes*, a foot.]  
A half foot in poetry.

SEMIPE'DAL, *a.* Containing a half foot.

SEMI-PELAGIAN, *n.* In *eccl. hist.*, a  
follower of John Cassianus, a French  
monk, who, about the year 430, modified  
the doctrines of Pelagius, by deny-  
ing human merit, and maintaining the  
necessity of the Spirit's influences;  
while he rejected the doctrine of un-  
conditional election, the inability of  
man to do good, irresistible grace, and  
the certain perseverance of the saints.

SEMI-PELAGIAN, *a.* Pertaining to  
the Semi-pelagians, or their tenets.

SEMI-PELAGIANISM, *n.* The doc-  
trines or tenets of the Semi-pelagians,  
supra.

SEMI-PELLUCID, *a.* [*semi* and *pel-  
lucid*.] Half clear, or imperfectly  
transparent; as, a *semi-pellucid* gem.

SEMI-PELLUCIDITY, *n.* The quality  
or state of being imperfectly trans-  
parent.

SEMI-PERSPICUOUS, *a.* [*semi* and  
*perspicuous*.] Half transparent; im-  
perfectly clear.

SEMI-PHLOGISTICATED, † *a.* [*semi*  
and *phlogisticated*.] Partially impreg-  
nated with phlogiston.

SEMI-PHYLLIDIANS, *n.* The third  
division of Lamarck's gastropods, con-  
sisting of those whose branchiæ are  
placed under the border of the mantle,  
and disposed in a longitudinal series on  
the right side of the body alone. It  
comprises two genera, *Pleurobranchus*  
and *Umbrella*.

SEMI-PRIMIGENOUS, *a.* [*semi* and  
*primigenous*.] In *geol.*, of a middle  
nature between substances of primary  
and secondary formation.

SEMI-PROOF, *n.* [*semi* and *proof*.]  
Half proof; evidence from the testi-  
mony of a single witness. [*Little used*.]

SEMI-PROTOLITE, *n.* [*semi* and Gr.

*πρωτος*, first, and *λιθος*, stone.] A species  
of fossil of a middle nature between  
substances of primary and those of  
secondary formation.

SEMI-QUADRATE, } *n.* [*L. semi* and  
SEMI-QUARTILE, } *quadratus*, or  
*quartus*, fourth.] An aspect of the  
planets, when distant from each other  
the half of a quadrant, or forty-five  
degrees, one sign and a half.

SEMIQUAVER, *n.* [*semi* and *quaver*.]  
In *music*, a note of half  
the duration of the  
quaver; the sixteenth  
of the semi-breve.



Semiquaver.

SEMIQUAVER, *v. t.* To  
sound or sing in semi-  
quavers.

SEMI-QUINTILE, *n.*  
[*L. semi* and *quintilis*.] An aspect of  
the planets, when distant from each  
other half of the quintile, or thirty-six  
degrees.

SEMI-SAVAGE, *a.* [*semi* and *savage*.]  
Half savage; half barbarian.

SEMI-SAVAGE, *n.* One who is half  
savage or imperfectly civilized.

SEMI-SEX'TILE, *n.* [*semi* and *sextile*.]  
An aspect of the planets, when they  
are distant from each other the twelfth  
part of a circle, or thirty degrees.

SEMI-SOSPITO, *n.* [It.] In *music*, a  
small pause equal to the eighth part  
of a bar in common time.

SEMI-SPHERIC, or SEMI-SPHER-  
ICAL, *a.* [*semi* and *spherical*.] Having  
the figure of a half sphere.

SEMI-SPHEROIDAL, *a.* [*semi* and  
*spheroidal*.] Formed like a half spher-  
oid.

SEMITENDINOSE MUSCLE, *n.* In  
*anat.*, a muscle situated obliquely along  
the back part of the thigh. It assists  
in bending the leg, and at the same  
time draws it a little inwards.

SEMITER'TIAN, *a.* [*semi* and *tertian*.]  
Compounded of a tertian and quotidian  
ague.

SEMETER'TIAN, *n.* An intermittent  
compounded of a tertian and a quoti-  
dian.

SEMITYC LANGUAGES, *n.* One of  
the great families of languages. They  
have been divided thus: 1. Aramaean  
(in the north), including Eastern and  
Western Aramaean; the Eastern em-  
braces the Assyrian, the Babylonian,  
from which several dialects originated,  
as the Chaldaic, the Syro-Chaldaic;  
and the Samaritan. The Western  
Aramaean includes the Syriac dialect,  
the Palmyrene, and the Sabian idiom,  
a corrupted Syriac dialect. 2. Cana-  
naitish languages, which comprise  
the Phœnician language, with its dia-  
lect the Punic, the Hebrew with the  
Rabbinic dialect. 3. The Arabic lan-  
guage, from which originated the  
Ethiopian or Abyssinian.

SEMITONE, *n.* [*semi* and *tone*.] In  
*music*, half a tone; an interval of sound,  
as between *mi* and *fa* in the diatonic  
scale, which is only half the distance  
of the interval between *ut* and *re*, or  
*sol* and *la*. A semitone, strictly speak-  
ing, is not half a tone, as there are  
three kinds of semitones;—greater,  
lesser, and natural.

SEMITON'IC, *a.* Pertaining to a semi-  
tone; consisting of a semitone.

SEMI-TRANSEPT, *n.* [*semi* and *tran-  
sept*], *L. trans* and *septum*.] The half  
of a transept or cross aisle.

SEMI-TRANSPARENCY, *n.* Imper-  
fect transparency; partial opaqueness.

SEMI-TRANSPARENT, *a.* [*semi* and

*transparent.*] Half or imperfectly transparent.

**SEMI-VERTICILLATE**, *a.* Partially verticillate.

**SEMI-VITREOUS**, *a.* Partially vitreous.

**SEMI-VITRIFICATION**, *n.* [*semi* and *vitification.*] 1. The state of being imperfectly vitrified.—2. A substance imperfectly vitrified.

**SEMI-VITRIFIED**, *a.* [*See VITRIFY.*] Half or imperfectly vitrified; partially converted into glass.

**SEMI-VOCAL**, *a.* [*semi* and *vocal.*] Pertaining to a semi-vowel; half vocal; imperfectly sounding.

**SEMI-VOWEL**, *n.* [*semi* and *vowel.*] In *gram.*, a half vowel, or an articulation which is accompanied with an imperfect sound, which may be continued at pleasure. Thus *el, em, en*, though uttered without close organs, do not wholly interrupt the sound; and they are called *semi-vowels*.

**SEMNOPITHECUS**, *n.* Cuvier's name for a genus of monkeys, which differ from the long-tailed monkeys, by having an additional small tubercle, on the last of the inferior molars. These animals inhabit Eastern countries, and their long limbs and very long tail give them a peculiar appearance.

**SEMIONES**, *n.* [Contracted from *L. semi, half* and *hominēs, men.*] In *Roman classic antiquity*, deities holding a middle place between the twelve supreme gods, and the heroes; as Vertumnus, Priapus, Fauns, Satyrs, &c.

**SEMIOLE**, *n.* [Fr.] A name given to the large hard grains retained in the bolting machine, after the fine flour has been passed through it; [also written *semolina*, the Italian form of the word.]

**SEMPERVIRENT**, *a.* [*L. semper, always*, and *virens, flourishing.*] Always fresh; evergreen.

**SEMPERVIVUM**, *n.* House-leek, a genus of plants. [*See HOUSELEEK.*]

**SEMPITERNAL**, *a.* [Fr. *sempiternel; L. sempiternus; semper, always*, and *eternus, eternal.*] 1. Eternal in futurity; everlasting; endless; having beginning, but no end.—2. Eternal; everlasting.

**SEMPITERNITY**, *n.* [*L. sempiternitas.*] Future duration without end. *Sempre, in music*, throughout.

**SEMPSTER**, *n.* (*sen'ster*). A seamster, —*which see.*

**SEMPSTRESS**, *n.* [*Sax. seamestre.*] A woman who lives by needle-work.

**SEMUNCIA**, *n.* [*L. semi* and *uncia*, the twelfth part of an *as.*] A small Roman coin of the weight of four drachms, being the 24th part of the Roman pound.

**SENACIA**, *n.* A small genus of plants, nat. order Pittosporacæ. The species are natives of the West Indies, Mauritius, and the Himalayas. The wood of *S. undulata*, a native of the Mauritius, is handsomely veined, and is esteemed for its hardness.

**SENARY**, *a.* [*L. seni, senarius.*] Of six; belonging to six; containing six.

**SENATE**, *n.* [Fr. *senat; L. senatus, from senex, old, Ir. sean, W. hen; Ar. sanna, or sanah, to be advanced in years.* Under the former verb is the Arabic word signifying a tooth, showing that this is only a dialectical variation of the Heb. *שן, shen*. The primary sense is to extend, to advance, or to wear. A senate was originally a council of elders.] 1. An assembly or

council of senators; a body of the principal inhabitants of a city or state, invested with a share in the government. The senate of ancient Rome was one of the most illustrious bodies of men that ever bore this name. Some of the Swiss cantons have a senate, either legislative or executive.—2. In the United States, senate denotes the higher branch or house of a legislature. Such is the senate of the United States, or upper house of the congress; and in most of the states, the higher and least numerous branch of the legislature is called the senate. In the United States, the senate is an elective body. It is composed of two members for each state of the union, who are chosen by the state for six years. Besides its legislative functions, it is also a species of executive council assisting the president, its consent being necessary for the ratification of treaties, appointment of ambassadors, judges of the supreme court, heads of departments in the administration, &c. It is also the high court of impeachment for public functionaries.—3. In a looser sense, any legislative or deliberative body of men; as, the eloquence of the senate. In the university of Cambridge, the senate is equivalent to the convocation at Oxford, and consists of all masters of arts and higher graduates, being masters of art, who have each a voice in every public measure; as in granting degrees, in electing members of parliament, a chancellor, &c. In the Scotch universities, the senate is composed of the principal and professors.

**SENATE-HOUSE**, *n.* A house in which a senate meets, or a place of public council.

**SENATOR**, *n.* A member of a senate.

In Scotland, the lords of session are called *senators* of the college of justice.—2. A councillor; a judge or magistrate; Ps. cv.

**SENATORIAL**, *a.* Pertaining to a senator; or, *senatorialian*, *n.* *senate*; becoming a senator; as, *senatorial robes: senatorial eloquence.*—2. In the U. States, entitled to elect a senator; as, a *senatorial district*.

**SENATORIALLY**, *adv.* In the manner of a senate; with dignity or solemnity.

**SENATORSHIP**, *n.* The office or dignity of a senator.

**SENATUS CONSULTUM**. [*L.*] A decree of the Roman senate, pronounced on some question or point of law.

**SEND**, *v. t. pret.* and *pp. sent*. [*Sax. sendan; G. senden.*] 1. In a general sense, to throw, cast, or thrust; to compel or drive by force to a distance, either with the hand or with an instrument or by other means. We *send* a ball with the hand or with a bat; a bow *sends* an arrow; a cannon *sends* a shot; a trumpet *sends* the voice much farther than the unassisted organs of speech.—2. To dispatch; to cause to be conveyed or transmitted; as, to *send* letters or despatches from one country to another.—3. To cause to go or pass from place to place; as, to *send* a messenger from London to Madrid.—4. To commission, authorize, or direct to go and act.

I have not *sent* these prophets, yet they ran; Jer. xxiii.

5. To cause to come or fall; to bestow.

He *sends* rain on the just and on the unjust; Matth. v.

6. To cause to come or fall; to inflict.

The Lord shall *send* upon those cursing, vexation, and rebuke; Deut. xxviii.

If I *send* pestilence among my people; 2 Chron. vii.

7. To propagate; to diffuse.

Cherubic songs by night from neighbour'ing hills.

Aerial music *send*.

*Milton*  
To *send* away, to dismiss; to cause to depart.—To *send forth* or *out*, to produce; to put or bring forth; as, a tree *sends forth* branches.—2. To emit; as, flowers *send forth* their fragrance; James iii.

**SEND**, *v. i.* To dispatch a message; to dispatch an agent or messenger for some purpose.

See ye how this son of a murderer hath *sent* to take away my head? 2 Kings vi. So we say, we *sent* to invite guests; we *sent* to inquire into the facts.—2. In *marine language*, to pitch precipitately into the hollow, or interval between two waves; as, "every time the vessel *sends*, the topmasts complain."—To *send for*, to request or require by message to come or be brought; as, to *send for* a physician; to *send for* a coach. But these expressions are elliptical.

**SEN'DAL**, *n.* [*Sp. cendal.*] A light thin stuff of silk or thread.

**SENDER**, *n.* One that sends.

**SEN'E'CIO**, *n.* A genus of plants, known by the common names of Groundsel, and Ragwort. [*See GROUNDSEL, RAGWORT.*]

**SEN'E'GA**, *n.* A plant called rattle-SEN'E'KA, snake-root, of the genus *Polygala*, the *P. senega*. It is brought from North America; it has a peculiar pungent flavour, and promotes the flow of saliva. It is occasionally used in stimulating gargles, and in America as an antidote to the effects of the bite of the rattlesnake.

**SENEGAL**. See GUM-SENEGAL.

**SEN'E'GINE**, *n.* The bitter acrid principle of the *Polygala senega*, or rattle-snake root. See *POLYGALA*.

**SENES' CENCE**, *n.* [*L. senesco, from senex, old. See SENATE.*] The state of growing old; decay by time.

**SEN'ESCHAL**, *n.* [Fr. *senéchal; G. seneschall.*] The origin and signification of the first part of the word are not ascertained. The latter part is the Teutonic *schalk* or *scalc*, a servant, as in *marshal*.] A steward; an officer in the houses of princes and dignitaries, who has the superintendence of feasts and domestic ceremonies.

In some instances, the *seneschal* is an officer who has the dispensing of justice. It is a French title of office and dignity, derived from the middle ages, and answering to that of steward or high steward in England.

**SEN'GREEN**, *n.* A plant, the house-leek, of the genus *Sempervivum*.

**SEN'NILE**, *a.* [*L. senilis.*] Pertaining to old age; proceeding from age.

**SENILITY**, *n.* Old age. [*Not mu. us.*]

**SENIOR**, *a.* (*see nyor*) [*L. senior, comp. of senex, old. See SENATE.*] Elder or older; but as an adjective, it usually signifies older in office; as, the *senior* pastor of a church, where there are colleagues; a *senior* counsellor. In such use, *senior* has no reference to age, for a *senior* counsellor may be, and often is the younger man. When father and son, in one family, or two persons of unequal age, in the same establishment, &c., bear the same name

the elder of the two is entitled *senior*; as, John Blackie, *senior*. [See JUNIOR.] SENIOR, *n.* (see 'nyor). A person who is older than another; one more advanced in life.—2. One that is older in office, or one whose first entrance upon an office was anterior to that of another. Thus a senator or counsellor of sixty years of age, often has a *senior* who is not fifty years of age.—3. A student, the fourth year of the curriculum in American colleges, or the third year in their theological seminaries.—4. An aged person; one of the oldest inhabitants.

A *senior* of the place replies. *Dryden*. SENIORITY, *n.* Eldership; superior age; priority of birth. He is the elder brother, and entitled to the place by *seniority*.—2. Priority in office; as, the *seniority* of a pastor or counsellor.

SEN'NA, *n.* [Pers. and Ar. *sana*. Qu. from Ch. and Syr.  $\text{ܣܢܢܐ}$ , to strain, purge, purify. The common pronunciation, *seena*, is incorrect.] The leaves of various species of cassia, the best of which are natives of the East. The senna of the shops consists, according to Delille, of *Cassia acutifolia*, *Cassia senna*, and *cyananchem argel*; which latter plant is employed in Egypt to adulterate the senna proper. Aleppo senna is yielded by *Cassia obovata*, and the senna of Mecca by *C. lanceolata*.



Senna (*Cassia lanceolata*).

In addition to the leaflets, the leaf-stalks and pods are frequently present, especially in the Alexandrian senna. The true senna leaves are distinctly ribbed, thin, generally pointed, and, when chewed, have a peculiar nauseous flavour, and yield a dark brown infusion. It is a gripping, nauseating, and somewhat drastic purge, and a most valuable addition to, or vehicle for, other purgatives.

SE'NNIGHT, *n.* (sen'nit.) [contracted from *sevensnight*, as *fortnight* from *fourteennight*.] The space of seven nights and days; a week. The court will be held this day *se'nnight*, that is, a week from this day; or the court will be held next Tuesday *se'nnight*, a week from next Tuesday.

SEN'NIT, *n.* [from *seven* and *nit*.] In ships, a sort of flat braided cordage used for various purposes, and formed by plaiting five or seven rope-yarns together.

SENOC'ULAR, *a.* [L. *seni*, six, and *oculus*, the eye.] Having six eyes.

Most animals are binocular, spiders octonocular, and some *senocular*. *Derham*.

SENS'ATE, } *a.* [See SENSE.] PER-

SENS'ATED, } ceived by the senses.

SENSA'TION, *n.* [Fr.; It. *sensazione*; Sp. *sensacion*; from L. *sensus*, *sentio*, to perceive. See SENSE.] The perception of external objects by means of the senses, or the effect produced on the sensorium by something acting on the bodily organs. When an impression made on the extremity of a nerve is communicated to the sensorium so as to excite the consciousness of the mind, it is called a *sensation*. When the impression is produced by the action of a foreign body on an external part, it is called an *external sensation*; when it proceeds from some change taking place within the living system, and arising from its own actions, it is termed an *internal sensation*; thus the impression communicated to the mind by the effect of light on the retina, and the painful sensation produced by a blow, are *external sensations*; the feeling of hunger and of restlessness are *internal sensations*. The external organs by which those impressions which cause sensation are primarily received, are called the organs of the senses; these are, the eye, the ear, the nose, the tongue, palate, &c., which constitute the organ of taste; and the extremities of nerves, dispersed under the common integuments, which give rise to the common sensation, feeling, or touch. The faculty of the mind by which we acquire the knowledge of bodies and their qualities, or perception, has been by some philosophers called *external sensation*; and those faculties by which we perceive novelty, sublimity, beauty, imitation, harmony, and ridicule, have been by some termed *secondary sensations*, by others *secondary senses*, and by others *emotions*.

SENSE, *n.* (sens.) [Fr. *sens*; from L. *sensus*, from *sentio*, to feel or perceive; W. *syniac*, id.; *syn*, sense, feeling, perception; G. *sinn*, sense, mind, intention.] 1. The faculty by which animals perceive external objects by means of impressions made on certain organs of the body. The senses are those faculties by which we become acquainted with some of the conditions of our own bodies, and with certain properties and states of external things, such as their colour, taste, odour, size, form, density, motion, &c. The senses are five in number, namely, sight, hearing, taste, smell, and touch; and each of them is exercised in the recognition of an impression conveyed along some nerve to the brain. Not only are the fingers organs of touch, but every part of the body, and not only do sensations arise from the contact of other bodies, but from affections of the nerves and muscles, when no perceptible contact occurs. Indeed there are no kinds of sensation produced by external causes, which we may not also derive from conditions of the nerves, arising independently of such external causes; but the same internal cause acting on the organs of the several senses produces, through the medium of each, a sensation peculiar to itself, and similar in kind to that perceived in the exercise of that organ's normal function; so that a nerve of one sense, can in no case discharge the function of a nerve of any other sense. The great end of the senses, however, is to make us acquainted with external objects and their qualities, and our perception of

these is accompanied with a belief that they exist, and are what they appear to be.—2. Sensation; perception by the senses.—3. Perception by the intellect; apprehension; discernment.

This Basilus, having the quick *sense* of a lover—*Sydney*.

4. Sensibility; quickness or acuteness of perception.—5. Understanding; soundness of faculties; strength of natural reason; as, a man of *sense*.

Opprest nature sleeps;  
This rest might yet have balm'd thy broken *senses*.  
*Shak.*

6. Reason; reasonable or rational meaning.

Ho raves; his words are loose  
As heaps of sand, and scattering wide  
from *sense*.  
*Dryden*.

7. Opinion; notion; judgment.  
I speak my private but impartial *sense*  
With freedom.  
*Roscommon*.

8. Consciousness; conviction; as, a due *sense* of our weakness or sinfulness.—9. Moral perception.

Some are so hardened in wickedness, as  
to have no *sense* of the most friendly offices.  
*L'Estrange*.

10. Meaning; import; signification; as, the true *sense* of words or phrases. In interpretation, we are to examine whether words are to be understood in a literal or figurative *sense*. So we speak of a legal *sense*, a grammatical *sense*, an historical *sense*, &c.—*Common sense*, that power of the mind which, by a kind of instinct, or a short process of reasoning, perceives truth, the relation of things, cause and effect, &c. and hence enables the possessor to discern what is right, useful, expedient or proper, and adopt the best means to accomplish his purpose. This power seems to be the gift of nature, improved by experience and observation.—*Moral sense*, a determination of the mind to be pleased with the contemplation of those affections, actions, or characters of rational agents, which are called good or virtuous.

SENSE'D, *† pp.* Perceived by the senses.  
SENSEFUL, *† a.* (sens'ful.) Reasonable; judicious.

SENSELESS, *a.* (sens'less.) Incapable of sensation. Wanting the faculty of perception. The body when dead is *senseless*; but a limb or other part of the body may be *senseless*, when the rest of the body enjoys its usual sensibility.—2. Unfeeling; wanting sympathy.

The *senseless* grave feels not your pious sorrows.  
*Rowe*.

3. Unreasonable; foolish; stupid.  
They would repent this their *senseless* perverseness, when it would be too late.

*Clarendon*.  
4. Unreasonable; stupid; wanting understanding; acting without sense or judgment.

They were a *senseless* stupid race. *Swift*.  
5. Contrary to reason or sound judgment; as, to destroy by a *senseless* fondness the happiness of children.—6. Wanting knowledge; unconscious; with *of*; as, libertines *senseless* of any charm in love.—7. Wanting sensibility or quick perception.

SENSELESSLY, *adv.* (sens'lessly.) In a senseless manner; stupidly; unreasonably; as, a man *senselessly* arrogant.  
SENSELESSNESS, *n.* (sens'lessness.) Unreasonableness; folly; stupidity; absurdity.

SENSIBIL'ITY, *n.* [Fr. *sensibilité*; from *sensible*.] 1. Susceptibility of

impressions upon the organs of sense; the capacity of feeling or perceiving the impressions of external objects; *applied to animal bodies*; as when we say, a frozen limb has lost its *sensibility*. Among physiologists, *sensibility* is said to be that faculty of living parts by which they are capable of receiving impressions, which increase, diminish, alter, or suspend their functions. It is usually divided into *animal sensibility*, which gives rise to sensations; and *organic sensibility*, which calls into action the organic contractility. Some parts are endowed with a high degree of animal sensibility, while others possess hardly any. It is also more acute in some persons than in others.—2. Acuteness of sensation; *applied to the body*.—3. Capacity or acuteness of perception; that quality which renders us susceptible of impressions; delicacy of feeling; as, *sensibility to pleasure or pain*; *sensibility to shame or praise*; *exquisite sensibility*.—4. Actual feeling.

This adds greatly to my *sensibility*.

Burke.

[This word is often used in this manner for *sensation*.]—5. It is sometimes used in the plural.

His *sensibilities* seem rather to have been those of patriotism, than of wounded pride.

Marshall.

*Sensibilities* unfriendly to happiness, may be acquired.

Encyc.

6. Nice perception, so to speak of a balance; that quality of a balance which renders it movable with the smallest weight, or the quality or state of any instrument that renders it easily affected; as, the *sensibility of a balance* or of a thermometer.

**SENS'IBLE, a.** [Fr. and Sp. *id.*; It. *sensibile*.] 1. Capable of sensation; having the capacity of receiving impressions from external objects; capable of perceiving by the instrumentality of the proper organs. We say, the body or the flesh is *sensible*, when it feels the impulse of an external body. It may be more or less *sensible*.—2. Capable of exciting sensation; perceptible by the senses. The light of the moon furnishes no *sensible* heat.

Air is *sensible to the touch* by its motion.

Arbutnot.

3. Perceptible or perceived by the mind.

The disgrace was more *sensible* than the pain.

Temple.

4. Perceiving or having perception, either by the mind or the senses.

A man cannot think at any time, waking or sleeping, without being *sensible of it*.

Locke.

5. Having moral perception; capable of being affected by moral good or evil.

If thou wert *sensible of courtesy*,

I should not make so great a show of zeal.

Shak:

6. Having acute intellectual feeling; being easily or strongly affected; liable to quick emotion; taking quickly to heart; as, to be *sensible of wrong*.—7. Perceiving so clearly as to be convinced; satisfied; persuaded.

They are now *sensible* it would have been better to comply than to refuse.

Addison.

8. Intelligent; discerning; judicious; wise; as, a *sensible man*.—9. Movable by a very small weight or impulse; as, a *sensible balance* is necessary to ascertain exact weight.—10. Affected by a slight degree of heat or cold; as, a

*sensible* thermometer.—11. Containing good sense or sound reason.

He addressed Claudius in the following *sensible* and noble speech.

Henry.

*Sensible note*, in music, that which constitutes a third major above the dominant, and a semitone beneath the tonic.

**SENS'IBLE, n.** Sensation; also, whatever may be perceived. [Little used.] **SENS'IBLENESS, n.** Possibility of being perceived by the senses; as, the *sensibleness of odour or sound*.—2. Actual perception by the mind or body; as, the *sensibleness of an impression on the organs*. [But qu.]—3. Sensibility; quickness or acuteness of perception; as, the *sensibleness of the eye*.—4. Susceptibility; capacity of being strongly affected, or actual feeling; consciousness; as, the *sensibleness of the soul and sorrow for sin*.—5. Intelligence; reasonableness; good sense.—6. Susceptibility of slight impressions. [See SENSIBLE, No. 9, 10.]

**SENS'IBLY, adv.** In a manner to be perceived by the senses; perceptibly to the senses; as, pain *sensibly* increased; motion *sensibly* accelerated.—2. With perception, either of mind or body. He feels his loss very *sensibly*.—3. Externally; by affecting the senses.—4. With quick intellectual perception.—5. With intelligency or good sense; judiciously. The man converses very *sensibly* on all common topics.

**SENSIF'EROUS, a.** Producing sense.

**SENSIF'IC, a.** [L. *sensus* and *facio*.] Producing sensation.

**SENS'ITIVE, a.** [It. and Sp. *sensitivo*; Fr. *sensitif*; L. *sensitivus*, from *sensus*, *sentio*.] 1. Having sense or feeling, or having the capacity of perceiving impressions from external objects; as, *sensitive soul*; *sensitive appetite*; *sensitive faculty*.—2. Having feelings easily excited.—3. That affects the senses; as, *sensitive objects*.—4. Pertaining to the senses, or to sensation; depending on sensation; as, *sensitive motions*; *sensitive muscular motions* excited by irritation.

**SENS'ITIVELY, adv.** In a sensitive manner.

**SENS'ITIVENESS, n.** The state of being easily affected by external objects, events, or representations.

**SENS'ITIVE-PLANT, n.** A plant of the genus *Mimosa*, the *M. pudica*, so called from the susceptibility of its leaves and foot-stalks, which shrink,



Sensitive-plant (*Mimosa pudica*).

contract, and fall on being slightly touched. It inhabits the tropics of America; has a stem about a foot and a half high, covered with stiff hairs:

the leaves are bipinnate, and the flowers are collected in small pink balls. The same property belongs to other species of *Mimosa*, and to species of other genera, as the *Hedysarum gyrans*, the ternate and pinnate species of *Oxalis*, the *Dionaea Muscipula*, &c.

**SENSO'RIAL, a.** Pertaining to the sensory or sensorium; as, *sensorial faculties*; *sensorial motions or powers*. **SENSO'RIOUS, n.** [from L. *sensus*, *SENSO'RIOUS*, } *sentio*.] 1. The seat of sense and perception, almost universally supposed to be in the brain.—2. Organ of sense; as, double *sensories*, two eyes, two ears, &c. **SENS'UAL, a.** [It. *sensuale*; Fr. *sensuel*; from L. *sensus*.] 1. Pertaining to the senses, as distinct from the mind or soul.

Far as creation's ample range extends,  
The scale of *sensual*, mental powers ascends.

Pope.

2. Consisting in sense, or depending on it; as, *sensual appetites*, hunger, lust, &c.—3. Affecting the senses, or derived from them; as, *sensual pleasure or gratification*. Hence,—4. In *theol.*, carnal; pertaining to the flesh or body, in opposition to the spirit; not spiritual or holy; evil; James iii.; Jude 19.—5. Devoted to the gratification of sense; given to the indulgence of the appetites; lewd; luxurious.

No small part of virtue consists in abstaining from that in which *sensual men* place their felicity.

Atterbury.

**SENS'UALISM, n.** In *mental philosophy*, that theory which resolves all our mental acts and intellectual powers into various modifications of mere sensation. This theory is strenuously advocated by Condillac. The theory opposed to it is *Intellectualism*.—2. A state of subjection to sensual feelings and appetite.

**SENS'UALIST, n.** A person given to the indulgence of the appetites or senses; one who places his chief happiness in carnal pleasures.

**SENSUAL'ITY, n.** [It. *sensualità*; Fr. *sensualité*.] Devotedness to the gratification of the bodily appetites; free indulgence in carnal or sensual pleasures.

Those pamper'd animals

That rage in savage *sensuality*.

They avoid dress, lest they should have affections tainted by any *sensuality*.

Addison.

**SENSUALIZA'TION, n.** The act of sensualizing; the state of being sensualized.

**SENS'UALIZE, v. t.** To make sensual; to subject to the love of sensual pleasure; to debase by carnal gratifications; as, *sensualized by pleasure*.

By the neglect of prayer, the thoughts are *sensualized*.

T. H. Skinner.

**SENS'UALIZED, pp.** Made sensual.

**SENS'UALIZING, ppr.** Subjecting to the love of sensual pleasure.

**SENS'UALLY, adv.** In a sensual manner.

**SENS'UOUS, a.** Pertaining to sense; feeling; connected with sensible objects.

Poetry is more simple, *sensuous*, and passionate.

Milton.

**SENT, pret.** and *pp.* of *Send*.

**SEN'TENCE, n.** [Fr.; It. *sentenza*; from L. *sententia*, from *sentio*, to think.]

1. In *law*, the decree or judgment of the ecclesiastical or admiralty courts; but in popular language, a judgment pronounced by a court or judge upon

a criminal; a judicial decision publicly and officially declared in a criminal prosecution. In *technical language*, sentence is used only for the declaration of judgment against one convicted of a crime. In civil cases, the decision of a court is called a judgment. In criminal cases, *sentence* is a judgment pronounced; doom.—2. In *lan. not technical*, a determination or decision given, particularly a decision that condemns, or an unfavourable determination.

Let him set out some of Luther's works, that by them we may pass *sentence* upon his doctrines. *Atterbury*.

3. An opinion; judgment concerning a controverted point; Acts xv.—4. A maxim; an axiom; a short saying containing moral instruction.—5. Vindication of one's innocence; Ps. xvii.—6. In *gram.*, a period; a number of words containing complete sense or a sentiment, and followed by a full pause. Sentences are simple or compound. A simple sentence consists of one subject and one finite verb; as, "the Lord reigns." A compound sentence contains two or more subjects and finite verbs, as in this verse:

He fills, he bounds, connects and equals all. *Pope*.

A *dark sentence*, a saying not easily explained; Dan. viii.

SENTENCE, *v. t.* To pass or pronounce the judgment of a court on; to doom; as, to *sentence* a convict to death, to transportation, or to imprisonment.—2. To condemn; to doom to punishment.

Nature herself is *sentenced* in your doom. *Dryden*.

3. To express in a short energetic manner.

SENTENCED, *pp.* Doomed; condemned.

SENTENCER, *n.* One who pronounces a sentence.

SENTENCING, *ppr.* Pronouncing the judgment of a court on.

SENTENTIAL, *a.* Comprising sentences.—2. Pertaining to a sentence or full period; as, a *sentential* pause.

SENTENTIARY, *n.* Formerly, one who read lectures, or commented on the sentences of Peter Lombard, a school divine of the 12th century.

SENTENTIOSITY, *n.* Sententiousness.

SENTENTIOUS, *a.* [Fr. *sententieux*; It. *sentenzioso*.] 1. Abounding with sentences, axioms, and maxims; short and energetic; as, a *sententious* style or discourse; *sententious* truth.

How he apes his sire,

Ambitiously *sententious*. *Addison*.

2. Comprising sentences; as, *sententious* marks. [This should be *sentential*.]

SENTENTIOUSLY, *adv.* In short expressive periods; with striking brevity.

Nausicaa delivers her judgment *sententiously*, to give it more weight. *Broome*.

SENTENTIOUSNESS, *n.* Pithiness of sentences; brevity with strength.

The Medea I esteem for its gravity and *sententiousness*. *Dryden*.

SENTIENT, *a.* (sen'shent.) [L. *sentiens*, *sentio*.] That perceives; having the faculty of perception. Man is a *sentient* being; he possesses a *sentient* principle.

—2. In *phys.*, a term applied to those parts which are more susceptible of feeling than others; as, the *sentient* extremities of the nerves, &c.

SENTIENT, *n.* A being or person that has the faculty of perception.—2. He that perceives.

SENTIMENT, *n.* [Fr. *id.*; from L. *sentio*, to feel, perceive, or think.] 1. Properly, a thought prompted by passion or feeling; an opinion or thought which greatly affects or interests us.—2. In a *popular sense*, thought; opinion; notion; judgment; the decision of the mind formed by deliberation or reasoning. Thus in deliberative bodies, every man has the privilege of delivering his *sentiments* upon questions, motions, and bills.—3. The sense, thought, or opinion contained in words, but considered as distinct from them. We may like the *sentiment*, when we dislike the language.—4. Sensibility; feeling; emotion; as, a *sentiment* of admiration; *sentiments* of love, fear, hope, pride, humility, &c.—5. Among *phrenologists*, a term employed to designate the second division of the moral or affective faculties of the mind, the first being termed *propensities*. The propensities include those faculties which produce only desires or inclinations, such as amativeness, the love of life, philoprogenitiveness, combativeness, &c. The *sentiments* include such faculties as not only produce a desire to act, but are combined with some other emotion or affection, which is not mere propensity. The *sentiments* are subdivided into those which are common to man with the lower animals, and those which are proper to man. The first subdivision comprehends self-esteem, love of approbation, cautiousness, and benevolence; the second, veneration, firmness, conscientiousness, hope, wonder, ideality, wit, and imitation.

SENTIMENTAL, *a.* Abounding with sentiment, or just opinions or reflections; as, a *sentimental* discourse.—2. Expressing quick intellectual feeling.—3. Affecting sensibility; in a *contemptuous sense*.

SENTIMENTALISM, *n.* State of feeling or refined sensibility.

SENTIMENTALIST, *n.* One that affects sentiment, fine feeling or exquisite sensibility.

SENTIMENTALITY, *n.* Affectation of fine feeling or exquisite sensibility.

SENTIMENTALIZE, *v. i.* To affect exquisite sensibility.

SENTIMENTALLY, *adv.* With intellectual feeling or sensibility.

SENTINEL, *n.* [Fr. *sentinelle*; from L. *sentio*, to perceive.] In *military affairs*, a soldier set to watch or guard an army, camp, or other place from surprise, to observe the approach of danger and give notice of it. In popular use, the word is contracted into *Sentry*.

SENTINELLED, *a.* Furnished with a sentinel.

SENTRY, *n.* [See SENTINEL.] 1. A soldier placed on guard; a sentinel.—2. Guard; watch; duty of a sentinel.

SENTRY-BOX, *n.* A small shed to cover a sentinel at his post, and shelter him from the weather.

SENZA. [It. *without*.] In *music*, a term signifying without; as, *senza stromenti*, without instruments.

SEPAHL, *n.* In the *East Indies*, a native soldier; a sepoy.

SEPAL, *n.* [from L. *sepio*.] In *bot.*, the separate divisions of that sort of calyx which is called a perianth.

When a perianth consists of but one part it is said to be *monosepalous*, when of two or more parts, it is said



a. s. s. Sepals.

to be *di*, *tri*, *tetra*, *pentasepalous*, &c. When of a variable and indefinite number of parts, it is said to be *polysepalous*.

SEPALOID, *a.* Like a sepal, or distinct part of a perianth.

SEPARABILITY, *n.* [from *separable*.] The quality of being separable, or of admitting separation or disunion.

*Separability* is the greatest argument of real distinctness. *Glauco-ile*.

SEPARABLE, *a.* [Fr. from L. *separabilis*. See SEPARATE.] That may be separated, disjointed, disunited, or rent; as, the *separable* parts of plants; qualities not *separable* from the substance in which they exist.

SEPARABLENESS, *n.* The quality of being capable of separation or disunion.

Trials permit me not to doubt of the *separableness* of a yellow tincture from gold. *Boyle*.

SEPARABLY, *adv.* In a separable manner

SEPARATE, *v. t.* [L. *separo*; Fr. *separer*. The Latin word is compounded of *se*, a prefix, and *paro*, evidently coinciding with the oriental

פָּרַד *bera*, or פָּרַר *berar*, the sense of which is to throw or drive off. See PARE and PARRY.] 1. To disunite; to divide; to sever; to part, in almost any manner, either things naturally or casually joined. The parts of a solid substance may be *separated* by breaking, cutting, or splitting, or by fusion, decomposition, or natural dissolution.

A compound body may be *separated* into its constituent parts. Friends may be *separated* by necessity, and must be *separated* by death. The prism *separates* the several kinds of coloured rays. A riddle *separates* the chaff from the grain.—2. To set apart from a number for a particular service.

*Separate me Barnabas and Saul*, Acts xiii.

3. To disconnect; as, to *separate* man and wife by legal acts.—4. To make a space between. The Atlantic *separates* Europe from America. A narrow strait *separates* Europe from Africa.

To *separate one's self*, to withdraw; to depart.

*Separate thyself*, I pray thee, from me; Gen. xiii.

SEPARATE, *v. i.* To part; to be disunited; to be disconnected; to withdraw from each other. The parties *separated*, and each retired.—2. To cleave; to open; as, the parts of a substance *separate* by drying or freezing.

SEPARATE, *a.* [L. *separatus*.] 1. Divided from the rest; being parted from another; disjointed; disconnected; used of things that have been united or connected; Gen. xlix.; 2 Cor. vi.—

2. Unconnected; not united; distinct; *used of things that have not been connected.*

Christ was holy, harmless, undefiled, and separate from sinners; Heb. vii.

3. Disunited from the body; as, a separate spirit; the separate state of souls. SEPARATED, *pp.* Divided; parted; disunited; disconnected.

SEPARATELY, *adv.* In a separate or unconnected state; apart; distinctly; singly. The opinions of the council were separately taken.

SEPARATENESS, *n.* The state of being separate.

SEPARATICAL, *a.* Pertaining to separation in religion.

SEPARATING, *ppr.* Dividing; disjoining; putting or driving asunder; disconnecting; decomposing.

SEPARATION, *n.* [Fr. from *L. separatio*; *It. separazione*; *Sp. separacion*.]

1. The act of separating, severing, or disconnecting; disjunction; as, the separation of the soul from the body.  
—2. The state of being separate; disunion; disconnection.

All the days of his separation he is holy to the Lord; Num. vi.

3. The operation of disuniting or decomposing substances; chemical analysis.—4. Divorce; disunion of married persons.

*Note.*—In *Eng. law*, and *legislature*, there is a practical difference between a *divorce* and a *separation*. The ecclesiastical courts can grant the latter; it needs a special act of parliament, *pro nata*, to obtain the former. *Separation* gives no power to either of the parties separated, leave to marry again; while *divorce* allows at least one of them to do so. Yet by a strange anomaly, the legislature, in recent times, has uniformly refused to give a complete divorce, (i. e. with leave to marry again), to any injured English wife, however great the wrongs sustained by her may have been: all that female complainants have yet obtained from parliament, after enormous expense incurred, has been a final *separation*.

SEPARATISM, *n.* The act of separating; disposition to withdraw from a church, or practice of withdrawing.

SEPARATIST, *n.* [Fr. *séparatiste*.] One that withdraws from a church, or rather from an established church, to which he has belonged; a dissenter; a seceder; a schismatic; a sectary.—2. A religious sect which originated in Dublin, about the year 1803. From conscientious scruples, they refused to take an oath in courts of justice and other places. There is nothing very peculiar in their tenets, beyond their withdrawing from the fellowship of other Christian bodies. In 1833, an act of parliament was passed for their relief in the matter of oaths.

SEPARATOR, *n.* One that divides or disjoins; a divider.

SEPARATORY, *a.* That separates; as, *separatory* ducts. [*Little used*.]

SEPARATORY, *n.* A chemical vessel for separating liquors; and a surgical instrument for separating the pericranium from the cranium.

SEPAWN, } *n.* In the *United States*, a  
SEPON, } species of food consisting of meal of maize boiled in water.

SEPIA, *n.* [Gr. *σέπια* and *σείπια*, a bag.] The name given by Linnæus to the cuttle-fish; a genus of cephalopods, comprising several subgenera; the two most interesting of which are the Ar-

gonauta of Linnæus, and the Sepia of Lamarck. [See CUTTLE FISH.]—2. In the *fine arts*, a species of pigment prepared from a black juice secreted by certain glands of the sepia or cuttlefish. The *sepia officinalis*, so common in the Mediterranean, is chiefly sought after on account of the profusion of colour which it affords. When prepared with caustic lye, it forms a beautiful brown colour, with a fine grain, and has given name to a species of drawing now extensively cultivated for landscapes and other branches of the fine arts.

SEPIADÆ, *n.* A family of cephalopods, including those forms which are vulgarly called cuttle-fishes. Each divides the family into Octopods and Decapods. SEPILIBLE, *a.* That may be buried.

SEPIMENT, *n.* [*L. sepimentum*, from *sepio*, to inclose.] A hedge; a fence; something that separates or defends.

SEPIUM, *n.* The bone or internal shell of the cuttle-fish.

SEPOSE, † *v. t.* (sep'o'ze.) [*L. sepono*, *sepositus*.] To set apart.

SEPOSITION, † *n.* The act of setting apart; segregation.

SEPOY, *n.* [Pers. *stepahi*, a soldier, plur. *stepahis*, Hindoo, *sepahai*.] A name given in Hindostan to the native soldiers in the British service. They now form a large army, well trained in European discipline. They are of a size somewhat less than European soldiers, but quite as brave, as active, and as hardy, capable of undergoing as much fatigue and of sustaining even greater privations. To the attachment and bravery of the Sepoys, Great Britain is chiefly indebted for the possession of her Indian empire. The native troops in the pay of the British government have been roughly estimated at 152,000 infantry and 2100 cavalry, the total number, including artillery, engineers, &c., being probably about 184,000.

SEPS, *n.* [*L.* from Gr. *σέπας*.] Cuvier.] The name of a genus of scincoid saurian reptiles, sometimes called *serpent-lizards*. They are found in the East Indies, the Cape of Good Hope, and on the coasts of the Mediterranean. These animals have elongated bodies, short and indistinct feet, non-extensible tongues, and scales covering their bodies like tiles.

SEPT, *n.* [Qu. *sapia*, in the *L. prosapia*; or Heb. *שֶׁבֶט*, *shabet*.] A clan, race, or family, proceeding from a common progenitor; used of the races or families in Ireland.

SEPTA, *pl.* of *Septum*,—which see.

SEPTANGULAR, *a.* [*L. septem*, seven, and *angulus*, angle.] Having seven angles.

SEPTARIUM, *n. plur.* *Septaria*. [*L. septa*, partitions.] A name given to nodules or spheroidal masses of calcareous marl, whose interior presents numerous fissures or seams of some crystallized substance, which divide the mass. When calcined and reduced to powder, these septaria furnish the valuable mortar called *Roman* or *Parker's cement*, which has the property of hardening under water.

SEPTEMBER, *n.* [*L.* from *septem*, seven; *Fr. Septembre*.] The seventh month from March, which was formerly the first month of the year. September is now the ninth month of the year.

SEPTEMBRISTS, } *n.* The name  
SEPTEMBRIZERS, } given to the

agents of the dreadful massacre which took place in Paris on September 2d, 1792, in the first French Revolution.

SEPTEMPARTITE, *a.* Divided nearly to the base into seven parts.

SEPTENARY, *a.* [Fr. *septénaire*; *L. septenarius*, from *septem*, seven.] Consisting of seven; as, a *septenary* number. SEPTENARY, *n.* The number seven. SEPTENNIAL, *a.* [*L. septennis*; *septem*, seven, and *annus*, year.] 1. Lasting or continuing seven years; as, *septennial* parliaments.—2. Happening or returning once in every seven years; as, *septennial* elections in England. The British parliaments are septennial, the members of the House of Commons, after a dissolution, being elected for seven years.

SEPTENNIALLY, *adv.* Once in seven years. SEPTENTRION, *n.* [Fr. from *L. septentrio*.] The north or northern regions.

SEPTENTRION, } *a.* [*L. septen-*  
SEPTENTRIONAL, } *trionalis*.]  
Northern; pertaining to the north.

From cold *septentrion* blasts. *Milton.* SEPTENTRIONATE, *v. i.* To tend northerly. [This word *septentrion* and its derivatives are hardly anglicized; they are harsh, unnecessary, and little used, and may well be suffered to pass into disuse.]

SEPT-FOIL, *n.* [*L. septem* and *folium*; seven-leaved.] A British plant of the genus *Tormentilla*, the *T. officinalis*. [See TORMENTILLA.]

SEPTIC, - } *a.* [Gr. *σῆπιος*, from  
SEPTICAL, } *σῆπιος*, to putrefy.] Having power to promote putrefaction. Many experiments were made by Sir John Pringle to ascertain the *septic* and *antiseptic* virtues of natural bodies.

SEPTIC, † *n.* A substance that promotes the putrefaction of bodies.

SEPTICIDAL, *a.* [*L. septum*, a partition, and *caedo*, to cut or divide. See SEPTUM.] In *bot.*, applied to seed-vessels which open by dividing through the septa, or partitions of the ovary.

SEPTICITY, † *n.* Tendency to putrefaction.

SEPTIFA'RIOUS, *a.* Having seven different ways.

SEPTIFEROUS, *a.* [*L. septum*, and *fero*, to bear.] In *bot.*, bearing septa. [See SEPTUM.]

SEPTIFLUOUS, *a.* Flowing in seven streams.

SEPTIFO'LIUS, *a.* Having seven leaves.

SEPTIFORM, *a.* Having seven forms.

SEPTIFRAGAL, *a.* [*L. septum* a partition, and *frango*, to break.] A *septifragal dehiscence* of a pericarp occurs, when the dissepiments adhere to the axis, and separate from the valves.

SEPTILATERAL, *a.* [*L. septem*, seven, and *latus*, side.] Having seven sides; as, a *septilateral* figure.

SEPTIL'ION, *n.* In *arith.*, a million



Septifragal dehiscence.

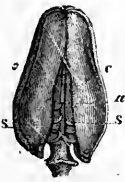

Septifragal dehiscence. Capsule of Mahogany. a, Axis; c, c, Carpels; e, e, Seeds.

raised to the seventh power; a number consisting of a unit with forty-two ciphers annexed.

**SEPTIN'SULAR**, *a.* [L. *septem*, seven, and *insula*, isle.] Consisting of seven isles; as, the *septinsular* republic of the Ionian isles.

**SEPTON**, *n.* [Gr. *σηται*, to putrefy.] That which promotes putrefaction.

**SEPTUAG'ENARY**, *a.* [Fr. *septuagenaire*; L. *septuagenarius*, from *septuaginta*, seventy.] Consisting of seventy.

**SEPTUAG'ENARY**, *n.* A person seventy years of age.

**SEPTUAGES'IMA**, *n.* [L. *septuagesimus*, seventieth.] The third Sunday before Lent, or before Quadragesima Sunday, supposed to be so called because it is about seventy days before Easter.

**SEPTUAGES'IMAL**, *a.* [supra.] Consisting of seventy.

Our abridged and *septuagesimal* age.

*Brown.*

**SEPTUAGINT**, *n.* [L. *septuaginta*, seventy; *septem*, seven, and some word signifying ten.] A Greek version of the Old Testament, so called because it is supposed to have been the work of seventy, or rather of seventy-two interpreters. This translation from the Hebrew is supposed to have been made in the reign and by the order of Ptolemy Philadelphus, king of Egypt, about two hundred and seventy or eighty years before the birth of Christ. It is supposed, however, by modern critics that this version of the several books is the work, not only of different hands, but of separate times. It is probable that at first only the Pentateuch was translated, and the remaining books gradually. The Septuagint was in use up to the time of our Saviour, and is that out of which most of the citations in the New Testament from the Old are taken. It is an invaluable help to the right understanding of the Hebrew Scriptures. [Dr. Campbell supposes this version was so called because it was approved by the Sanhedrim.]

**SEPTUAGINT**, *a.* Pertaining to the Septuagint; contained in the Greek copy of the Old Testament.

The *Septuagint* chronology makes fifteen hundred years more from the creation to Abraham, than the present Hebrew copies of the Bible.

*Encyc.*

**SEPTUARY**, *n.* [L. *septem*, seven.] Something composed of seven; a week.

**SEPTUM**, *n. pl.* *Septa.* [L. a partition.]

In *bot.*, any partition separating a body into two or more cells, in a direction parallel with the longer axis. Partitions parallel with the shorter axis are called *phragmata*.

—2. In *anat.*, the plate or wall which separates from each other two adjoining cavities; as the *septum* of the nose. The partitions of chambered cells are also called *septa*.

**SEPTUPLE**, *a.* [Low L. *septuplex*; *septem*, seven, and *plico*, to fold.] Seven-fold; seven times as much.

**SEPUL'CHRAL**, *a.* [L. *sepulchralis*, from *sepulchrum*.] Pertaining to burial, to the grave, or to monuments erected to the memory of the dead: as, a *sepulchral* stone; a *sepulchral* statue; a *sepulchral* inscription.—2. Deep; grave; hollow; as, a *sepulchral* tone of voice.



s, s, Septa.

**SEPULCHRE**, *n.* [Fr. *sepulchre*; from L. *sepulchrum*, from *sepelio*, to bury, which seems to be formed with a prefix on the Goth. *filhan*, to bury.] A grave; a tomb; the place in which the dead body of a human being is interred, or a place destined for that purpose. Among the Jews, *sepulchres* were often excavations in rocks; Is. xxii.; Matt. xxvii.

**SEPULCHRE**, *v. t.* To bury; to inter; to entomb; as, obscurely *sepulchred*.

**SEPULTURE**, *n.* [Fr. from L. *sepultura*, from *sepelio*.] Burial; interment; the act of depositing the dead body of a human being in the grave.

Where we may royal *sepulture* prepare.

*Dryden.*

*Rites of sepulture*, literally, the ceremonies performed in depositing the bodies of the dead in the earth; but the expression is applied in a more extended sense to all ceremonies of this kind, whether they consist in interment, incremation, or embalming.

**SEQUA'CIOUS**, *a.* [L. *sequax*, from *sequor*, to follow. See *SEEK*.] 1. Following; attendant.

Trees uprooted left their place,

*Sequacious* of the tyre.

*Dryden.*

The fond *sequacious* herd.

*Thomson.*

2. Ductile; pliant.

The forge was easy, and the matter ductile and *sequacious*. [Little used.] *Roy.*

**SEQUA'CIOUSNESS**, *n.* State of being *sequacious*; disposition to follow.

**SEQUACITY**, *n.* [supra.] A following, or disposition to follow.—2. Ductility; pliability. [Little used.]

**SE'QUEL**, *n.* [Fr. *séquelle*; L. It. and Sp. *secula*; from L. *sequor*, to follow.] 1. That which follows; a succeeding part; as, the *sequel* of a man's adventures or history.—2. Consequence; event. Let the sun or moon cease, fail, or swerve, and the *sequel* would be ruin.—3. Consequence inferred; consequentialness. [Lit. us.]

**SE'QUELS**, *n.* In *Scots law*, a term relating to thirlage, and signifying the small allowances of meal, or of manufactured victual, or of money composition made to the servants at the dominant mill for their real or implied trouble in grinding the victual of the servant lands.

**SE'QUENCE**, *n.* [Fr. from L. *sequens*, *sequor*; It. *sequenza*.] 1. A following, or that which follows; a consequent.—2. Order of succession.

How art thou a king

But by fair *sequence* and succession? *Shak.*

3. Series; arrangement; method.—4. In *music*, a regular alternate succession of similar chords; ascending or descending diatonically.—5. In *gaming*, a set of cards immediately following each other, in the same suit; as king, queen, knave, &c.; thus we say a *sequence* of three, four, or five cards.—6. In the *Roman catholic church*, a hymn introduced into the mass on certain festival days, and recited or sung immediately before the gospel, and after the gradual or introit; whence the name.

**SE'QUENT**, *a.* [supra.] Following; succeeding.—2. Consequential. [Little used.]

**SE'QUENT**, † *n.* A follower.

**SEQUEN'TIALLY**, *adv.* In succession.

**SEQUEST'ER**, *v. t.* [Fr. *séquestrer*; Low L. *sequestro*, to sever or separate, to put into the hands of an indifferent

person, as a deposit; *sequester*, belonging to mediation or umpirage, and as a noun, an umpire, referee, mediator. This word is probably a compound of *se* and the root of *questus*, *quasius*, sought. See *QUESTION*.] 1. To separate from the owner for a time; to seize or take possession of some property which belongs to another, and hold it till the profits have paid the demand for which it is taken.

Formerly the goods of a defendant in chancery were, in the last resort, *sequestered* and detained to enforce the decrees of the court. And now the profits of a benefice are *sequestered* to pay the debts of ecclesiastics.

*Blackstone.*

2. To take from parties in controversy and put into the possession of an indifferent person.—3. To put aside; to remove; to separate from other things.

I had wholly *sequestered* my civil affairs.

*Bacon.*

4. To *sequester one's self*, to separate one's self from society; to withdraw or retire; to seclude one's self for the sake of privacy or solitude; as, to *sequester one's self* from action.—5. To cause to retire or withdraw into obscurity.

It was his tailor and his cook, his fine fashions and his French ragouts, which *sequestered* him.

*South.*

**SEQUEST'ER**, *v. i.* To withdraw.—2. To decline, as a widow, any concern with the estate of her husband.

**SEQUEST'ERED**, *pp.* Seized and detained for a time, to satisfy a demand; separated; also, being in retirement; secluded; private; as, a *sequestered* situation.

**SEQUEST'ERING**, *ppr.* Seizing or taking possession of the property of another for a time, to satisfy a claim; removing; separating; secluding.

**SEQUEST'ERABLE**, *a.* That may be sequestered or separated; subject or liable to sequestration.

**SEQUEST'ERATE**, *v. t.* To sequester. [It is less used than *sequester*, but exactly synonymous.]

**SEQUESTRATION**, *n.* The act of taking a thing from parties contending for it, and intrusting it to an indifferent person.—2. In *English law*, a species of execution for debt in the case of a beneficed clergyman, issued by the bishop of the diocese on the receipt of a writ to that effect. The profits of the benefice are paid over to the creditor until his claim is satisfied.—*Sequestration in chancery*, is the setting aside from both parties the matter in controversy, till the right is determined by course of law. It is either *voluntary*, that is, by consent of the parties; or *necessary*, that is, when it takes place by order of the judge.—*Sequestration*, in *Scots law*, is, 1. A species of diligence used where two or more creditors are in competition for the property of a land estate; the owner of which is in insolvent circumstances, or where the right to a land estate is the subject of litigation. In these cases the court may, on application, sequesterate the rents, and employ a factor to collect them. 2. The process whereby the whole estate, both heritable and movable, of a bankrupt is distributed equitably amongst his creditors.—3. The act of taking property from the owner for a time, till the rents, issues, and profits satisfy a demand.—4. The act of seizing the

estate of a delinquent for the use of the state.—5. Separation; retirement; seclusion from society.—6. State of being separated or set aside.—7.† Disunion; disjunction.

**SEQUESTRA'TOR**, *n.* One that sequesters property, or takes the possession of it for a time, to satisfy a demand out of its rents or profits.—2. One to whom the keeping of sequestered property is committed.

**SE'QUIN**, *n.* [Ital. *zucchini*.] A gold coin of Italy, &c. The average value of the Italian *sequin*, which is almost peculiar to Austrian Italy and Tuscany, is about 9s. 3d. The *sequin soullany* of Turkey, Algiers, &c., is worth from 6s. to 7s.; that of Egypt, 5s. 4d.

**SERAGLIO**, *n.* (seral'yo.) [Fr. *sérial*; It. *serraglio*, from *serrare*, to shut or make fast, Fr. *serrer*; perhaps from *יצר* *yetzer*, or *יצר* *tzetar*. Castle deduces the word from the Persian *sarai*, *serai*, a great house, a palace. The Portuguese write the word *cerralho*, and Fr. *serrer*, to lock, they write *cerrar*, as do the Spaniards.] The palace of the Grand Seigneur or Turkish sultan, or the palace of a prince. The seraglio of the sultan is a long range of buildings inhabited by the Grand Seigneur and all the officers and dependents of his court; and in it is transacted all the business of government. In this also are confined the females of the harem. By Europeans the word *seraglio* is often confounded with *harem*, and hence is sometimes used to signify a house of women kept for debauchery.

**SER'AL**, *n.* In *India*, a place for the accommodation of travellers. In Persian, *serai* signifies a palace, the king's court, a large edifice; hence *karáván-serai*, by corruption, *caravanserie*, that is, place of rest for caravans. In Turkey these buildings are generally called *khan*s. The erection of them is considered highly meritorious by Hindus, as well as by Mohammedans, who frequently endow them with rents for their support.

**SER'APH**, *n.* plur. *Seraphs*; but sometimes the Hebrew plural, *seraphim*, is used, [from Heb. *שרפ*, *seraph*, to burn.] An angel of the highest order.

As full, as perfect in vile man that mourns,  
As the rapt *seraph* that adores and burns.

Pope.

**SERAPH'IC**, } *a.* Pertaining to a  
**SERAPH'ICAL**, } *seraph*; angelic;  
sublime; as, *seraphic* purity; *seraphic*  
fervour.—2. Pure; refined from sensuality.—3. Burning or inflamed with love or zeal. Thus, St. Bonaventure was called the *seraphic* doctor.

**SER'APHIM**, *n.* [The Hebrew plural of *Seraph*.] Angels of the highest order in the celestial hierarchy. [It is sometimes improperly written *Seraphims*.]

**SER'APHINE**, } *n.* [from *Seraph*.] A  
**SERAPHINA**, } keyed wind instrument,  
the tones of which are generated by the play of wind upon metallic reeds, as in the accordion. It consists, like the organ, of a key board, wind-chest and bellows. By means of a pedal, the stress of the wind upon the reeds may be so regulated as to give, with fine effect, the expression of accent, crescendo and diminuendo.

**SERA'PIS**, *n.* A tutelary god of Egypt, by some considered as an old deity

identical with Osiris, by others as introduced from abroad. In Alexandria, he was the chief deity.

**SERAS'KIER**, or **SERAS'QUIER**, *n.* A Turkish general or commander of land forces.

**SERASS'**, *n.* A fowl of the East Indies, of the crane kind.

**SERE**, *a.* Dry; withered; usually written *Sear*—*which see*.

**SERE**,† *n.* [Qu. Fr. *serrer*, to lock or make fast.] A claw or talon.

**SERENADE**, *n.* [Fr. from It. and Sp. *serenata*, from L. *serenus*, clear, serene.] 1. Properly, music performed in a clear night; hence, an entertainment of music given in the night by a lover to his mistress under her window. It consists generally of instrumental music, but that of the voice is sometimes added. The songs composed for these occasions are also called *serenades*. This practice, which was formerly very general in Spain and Italy, has latterly fallen greatly into disuse in these countries; but it is still very common in the German university towns, where the students are in the habit of assembling in the evening under the windows of a favourite professor, and offering him a musical tribute.—2. Music performed in the streets during the stillness of the night; as, a midnight *serenade*.

**SERENÁDE**, *v. t.* To entertain with nocturnal music.

**SERENÁDE**, *v. i.* To perform nocturnal music.

**SER'NA GUT'TA**. See **GUTTA SERENA**.

**SERENA'TA**, *n.* A vocal piece of music on an amorous subject.

**SERENE**, *a.* [Fr. *serein*; L. *serenus*; Heb. Ch. Syr. and Ar. *זהר*, *zehar*, to shine.] 1. Clear or fair, and calm; as, a *serene* sky; a *serene* air. *Serene* imports great purity.—2. Bright.

The moon, *serene* in glory, mounts the sky.

Pope.

3. Calm; unruffled; undisturbed; as, a *serene* aspect; a *serene* soul.—4. A title given to several princes and magistrates in Europe; as, *serene* highness; most *serene*. Before the dissolution of the German empire, *serene*, and most *serene* highness, were the appropriate addresses of princely houses, holding immediately of the empire. Since that period, it appears that these titles belong to members of the families of sovereign houses in the confederacy, and also to members of ci-devant sovereign houses now mediatised.

**SERENE**,† *n.* 1. The fresh cool air.—2.† A cold damp evening.

**SERENE**, *v. t.* To make clear and calm; to quiet.—2. To clear; to brighten.

**SERENELY**, *adv.* Calmly; quietly. The setting sun now shone serenely bright.

Pope.

2. With unruffled temper; coolly.

**SERENENESS**, *n.* The state of being serene; serenity.

**SERENTUDE**,† *n.* Calmness.

**SERENITY**, *n.* [Fr. *serenité*; L. *serenitas*.] 1. Clearness and calmness; as, the *serenity* of the air or sky.—2. Calmness; quietness; stillness; peace.

A general peace and serenity newly succeeded general trouble.

Templ.

3. Calmness of mind; evenness of temper; undisturbed state; coolness.

I cannot see how any men should transgress those moral rules with confidence and serenity.

Locke.

4. A title of respect or courtesy.

**SERF**, *n.* [Fr. *serf*; L. *servus*. See **SERVE**.] The French name for the lowest class of slaves in the dark ages; those who were incapable of holding property, attached to the land, and liable to feudal services of the lowest description.

**SERFAGE**, } *n.* The state or condition  
**SERFDOM**, } of a serf or serfs.

**SERGE**, *n.* [Fr. *serge*; Sp. *serga*, coarse frieze, and jargon; It. *sargia*, a coverlet.] A woollen quilted stuff manufactured in a loom with four treddles, after the manner of ratteens.—*Silk serge*, a twilled silken stuff, used by tailors for lining garments.

**SER'GEANT**, } *n.* [Fr. *sergent*.] There  
**SERJEANT**, } is an almost incurable  
irregularity existent in spelling this word. The first mode is most consonant to etymology; but the second was unquestionably earliest, and longest in use, among us. On the other hand, we find most of our contemporaries, especially in military works, despatches, gazettes, &c., adopting the former spelling; hence has arisen an attempt among typographers to print the word *sergeants* when those of the army are mentioned, and confine the title *serjeant* to legal gentlemen of that rank. This practice is convenient at least, though, perhaps, hardly countenanced by any rule of analogy. [See **SERJEANT**, &c.]

**SERGE-MAKER**, *n.* A manufacturer of serges.

**SER'GES**, *n.* The great wax candles burnt before the altars in Roman Catholic churches.

**SER'IAL**, *a.* Pertaining to a series; consisting of a series.

**SERIALS**, *n. plur.* Tales, or other writings, commenced in one number of a periodical work, and continued in successive numbers.—2. Periodicals.

**SERIA'NA**, or **SERJA'NIA**, *n.* An entirely tropical South American and West Indian genus of plants, belonging to the nat. order Sapindaceæ. The species consist of climbing or twining shrubs with tendrils, and the flowers white, arranged in racemes. Some of them possess very poisonous properties. *S. triterinata* is acrid and narcotic, and employed for the purpose of stupefying fish.

**SER'IATE**, *a.* Arranged in a series or succession.

**SER'IATELY**, *adv.* In a regular series.

**SERIA'TIM**, *adv.* [L.] In sequent order.

**SER'ICA**, *n.* A genus of coleopterous insects of the family Melolonthidæ. The British species, *S. brunnea*, is the type of the genus.

**SER'ICATE**, *n.* A salt formed by the union of sericic acid with a base.

**SER'I'CEOUS**, *a.* [L. *sericus*, from *sericum*, silk.] Pertaining to silk; consisting of silk; silky. In *bot.*, covered with very soft hairs pressed close to the surface; as, a *sericeous* leaf.

**SER'ICIC ACID**, *n.* [L. *sericum*, silk.] An acid which exists in combination with oxide of glycerule, in the butter of nutmegs, which are the fruit of *myristica moschata*, and hence also called myristic acid. It forms brilliant white scales of a silky lustre; hence the name.

When heated with potash and a little water, it forms a beautiful white soap.

**SER'ICINE**, *n.* Sericate of oxide of glycerule.

**SER'IES**, *n.* [L. This word belongs probably to the Shemitic, *שׁר*, *yashar*, the primary sense of which is to stretch



or strain.] 1. A continued succession of things in the same order, and bearing the same relation to each other; as, a *series* of kings; a *series* of successors.—2. Sequence; order; course; succession of things; as, a *series* of calamitous events.—3. In *nat. hist.*, an order or subdivision of some class of natural bodies.—4. In *arith.* and *alge.*, a number of terms in succession, increasing or diminishing according to a certain law; as, arithmetical *series* and geometrical *series*. The usual form of a series is a set of terms connected by the signs + or —. When the number of terms is greater than any assignable number, the series is said to be *infinite*. A *converging series* is one in which the successive terms become less and less. A *diverging series*, one in which any term is greater than the preceding. A *recurring series*, one in which each term is a certain constant function of two or more of the preceding terms; as,  $1 + 3x + 4x^2 + 7x^3 + 11x^4$  &c. An *exponential series*, one whose terms depend on exponential quantities. A *logarithmic series*, one whose terms depend on logarithms. A *circular series*, one whose terms depend on circular functions, as sines, cosines, &c. The *general term* of a series is a function of some indeterminate quantity  $x$ , which, on substituting successively the numbers 1, 2, 3, &c., for  $x$ , produces the terms of the series.—*Law of a series*, that relation which subsists between the successive terms of a series, and by which their general term may be denoted.—*Summation of series*, the method of finding the sum of a series whether the number of terms be finite or infinite. [See PROGRESSION.]

SERIN, *n.* [Fr.] A song-bird of the finch tribe, found in the central parts of Europe. It has a small, horny, and short bill; and its habits are mostly similar to those of the canary bird.

SERIO-COMIC, } *a.* Having a  
SERIO-COMTEAL, } mixture of seriousness and sportiveness.

SERIOUS, *a.* [Fr. *serieux*; L. *serius*.] 1. Grave in manner or disposition; solemn; not light, gay, or volatile; as, a *serious* man; a *serious* habit or disposition.—2. Really intending what is said; being in earnest; not jesting or making a false pretence. Are you *serious*, or in jest?—3. Important; weighty; not trifling.

The holy Scriptures bring to our ears the most *serious* things in the world. *Young.*

4. Particularly attentive to religious concerns or one's own religious state.

SERIOUSLY, *adv.* Gravely; solemnly; in earnest; without levity. One of the first duties of a rational being is to inquire *seriously* why he was created, and what he is to do to answer the purpose of his creation.

SERIOUSNESS, *n.* Gravity of manner or of mind; solemnity. He spoke with great *seriousness*, or with an air of *seriousness*.—2. Earnest attention, particularly to religious concerns.

That spirit of religion and *seriousness* vanished all at once. *Atterbury*

SERJEANT, *n.* (sarjent.) [Fr. *sergent*; It. *sergente*; Sp. and Port. *sargento*; from L. *serviens*, serving, for so was this word written in Latin. But Castle deduces the word from the Persian *sarchank* or *sarjank*, a prefect, a sub-altern military officer. See *Cast.* If this is correct, two different words are

blended.] 1. Formerly, an officer in England, nearly answering to the more modern bailiff of the hundred; also, an officer whose duty was to attend on the king, and on the lord high steward in court, to arrest traitors and other offenders. This officer is now called *serjeant-at-arms* or *mace*. A similar officer, termed a *serjeant-at-arms*, attends the lord chancellor; another, the speaker of the house of commons, and another the lord mayor of London, on solemn occasions.—*Common serjeant*, an officer of the city of London who attends the lord mayor and court of aldermen on court days, and is in council with them on all occasions. He is more particularly to take care of the orphans' estates. There are at present other officers of an inferior kind, who attend mayors and magistrates to execute their orders.—2. In *milit. affairs*, a non-commissioned officer in a company of infantry or troop of dragoons, whose duty is to see discipline observed, to order and form the ranks, be helpful to young officers, &c.—*Serjeant-major*, a non-commissioned officer who acts as assistant to the adjutant.—*Colour-serjeants*, certain non-commissioned officers, appointed to attend the officers who have charge of the colours of the regiment.—3. In *England*, a lawyer of the highest rank, and answering to the doctor of the civil law. He is called *serjeant-at-law*, and all must proceed through this degree before attaining the dignity of judge. *Serjeants-at-law* are now made by the king's writ, commanding them to take their degree.—4. A title sometimes given to the king's servants; as, *serjeant surgeon*, servant surgeon.—*King's serjeant*, the name given to one or more of the serjeants-at-law, whose presumed duty is to plead for the king in causes of a public nature, as indictments for treason, &c.

SERJEANTSHIP, *n.* (sarjentship.)

The office of a serjeant.

SERMOCINATION, } *n.* Speech-making.

SERMOCINATOR, } *n.* One that makes sermons or speeches.

SERMON, *n.* [Fr. from L. *sermo*, from the root of *sero*, the primary sense of which is to *throw* or *thrust*. See *ASSET*, *INSERT*.] 1. A discourse delivered in public by a licensed clergyman for the purpose of religious instruction, and usually grounded on some text or passage of Scripture. Sermons are extemporary addresses, or written discourses.

His preaching much, but more his practice wrought,

A living *sermon* of the truths he taught.

*Dryden.*

2. A printed discourse.—3. A serious exhortation. [Colloq.]

SERMON, *v. t.* To discourse as in a sermon. [Little used.] 2. To tutor; to lesson; to teach. [Little used.] SERMON, } *v. i.* To compose or deliver a sermon.

SERMONING, } *n.* Discourse; instruction; advice.

SERMONISH, *a.* Resembling a sermon.

SERMONIZE, *v. i.* To preach.—2. To inculcate rigid rules.—3. To make sermons; to compose or write a sermon or sermons.

SERMONIZER, *n.* One that composes sermons.

SERMONIZING, *ppr.* Preaching; inculcating rigid precepts; composing sermons; the act of instructing in a formal manner.

SERMOUNTAIN, *n.* A plant of the genus *Laserpitium*; laserwort; seseli.

SEROON', *n.* [Sp. *seron*, a frail or basket.] 1. A seroon of almonds is the quantity of two hundred pounds; of aise seed, from three to four hundred weight; of Castile soap, from two hundred and a half to three hundred and three quarters.—2. A bale or package made of hide or leather for holding drugs, &c.

SEROSITY, *n.* [Fr. *serosité*. See SERUM.] In *med.*, the watery part of the blood which exudes from the serum when it is coagulated by heat. It contains common salt, sulphates, phosphates, and carbonates.

SEROTINE, *n.* A species of European bat, the *Scotophilus serotinus* of Gray.

SERROUS, *a.* [Fr. *serreux*. See SERUM.] 1. Thin; watery; like whey; used of that part of the blood which separates in coagulation from the grumous or red part.—2. Pertaining to serum.—*Serous membranes*. [See SERUM.]

SERPENT, *n.* [L. *serpens*, creeping; *serpo*, to creep. In Welsh, *sarf*, a serpent, seems to be from *sâr*. The Sanscrit has the word *sarpa*, serpent.]

1. Ophidian reptiles without feet. Their bodies are extremely elongated, and move by means of the folds they form when in contact with the ground. Their hearts have two auricles. This is the widest use of the term *serpent*. This term is likewise applied to a family of ophidian reptiles, which comprises all the genera without a sternum, and without any vestige of a shoulder, &c. In Cuvier's arrangement, serpents constitute the order *Ophidia*. [See OPHIDIA.] They are divided into *pseudophidians*, or spurious ophidians, and ophidians proper. The chief divisions of the true ophidians are the *amphisbena*, the *typhlopes*, the *roles*, the *boas*, the *pythons*, the *colubers*, the *acrochords*,—all which tribes are non-venomous. The *pseudoboas*, *rattlesnakes*, *trigonocephali*, and *vipers*, are the venomous tribes.—2. In *astron.*, a constellation in the northern hemisphere, containing, according to the British catalogue, sixty-four stars.—3. An instrument of music, serving as a bass to the cornet, to sustain a chorus of singers in a large edifice. It consists of a long conical tube covered with leather, having a mouth-piece, ventages, and keys, and bent in a serpentine form; hence its name. Its use is confined to military bands. The ophicleide is an instrument of far superior utility. [See OPHICLEIDE.]—4. Figuratively, a subtle or malicious person.—5. In *myth.*, a symbol of the sun. In *her.*, the serpent is borne coiled and

twisted in various forms, as *torqued*, *bowed-embowed*, *regardant*, *nowed*, *reverted*, &c.—6. A kind of firework.—*Serpent stones* or *snake stones*, are fossil shells of different sizes, found in strata of stones and clays.

**SERPENT-CUCUMBER**, *n.* A plant of the genus *Trichosanthes*.

**SERPENT-EATER**, *n.* A fowl of Africa that devours serpents. [*See* SECRETARY BIRD.]

**SERPENT-FISH**, *n.* A fish resembling a snake, but of a red colour. [*Qn.* *Cepola tania* or *rubescens*, Linn., the band-fish, *Fr. ruban*.]

**SERPENT'S-TONGUE**, *n.* A plant of the genus *Ophioglossum*.

**SERPENTARIA**, *n.* A name given to numerous plants that have been reputed to be remedial of snake bites; as *Aristolochia Serpentaria*, *Prenanthes Serpentaria*, &c. [*See* SNAKE-ROOT.]

**SERPENTARIUS**, *n.* A constellation in the northern hemisphere, containing seventy-four stars.

**SERPENTIFORM**, *a.* Having the form of a serpent.

**SERPENTIGENOUS**, *a.* Bred of a serpent.

**SERPENTINE**, *a.* [*L. serpentinus*, from *serpens*.] 1. Resembling a serpent; usually, winding or turning one way and the other, like a moving serpent; anfractuons; as, a *serpentine* road or course.—2. Spiral; twisted; as, a *serpentine* worm of a still.—3. Like a serpent; having the colour or properties of a serpent.—*Serpentine tongue*, in the manege. A horse is said to have a *serpentine* tongue, when he is constantly moving it, and sometimes passing it over the bit.—*Serpentine verse*, a verse which begins and ends with the same word.

**SERPENTINE**, } *n.* A species  
**SERPENTINE-STONE**, } of talc or magnesium stone, usually of an obscure green colour, with shades and spots resembling a serpent's skin.—2. In *geol.*, a rock generally unstratified, which is principally composed of hydrated silicate of magnesia. Many of the alpine districts of Europe contain beds and rocks of serpentine. In the United States it is met with abundantly. Its degree of hardness, and the peculiar arrangement of its colours, form the distinctive characters of serpentine. Serpentine is often nearly allied to the harder varieties of steatite and potstone. It presents two varieties, precious serpentine and common serpentine.

**SERPENTINE**, † *v. t.* To wind like a serpent.

**SERPENTINELY**, *adv.* In a serpentine manner.

**SERPENTIZE**, *v. t.* To wind; to turn or bend, first in one direction and then in the opposite; to meander.

The road *serpentinized* through a tall shrubbery. *Barrow, Trav. in Africa.*

**SERPENTRY**, *n.* A winding like that of a serpent.

**SERPENT**, † *n.* A basket.

**SERPICULA VERTICILLATA**, *n.* The *Serpicula*, now *Hydrilla verticillata*, of modern botanists, is a plant belonging to the nat. order Hydrocharaceæ. It is used in India in refining sugar, the same way that clay is employed in other countries.

**SERPIGNOUS**, *a.* [*from L. serpigo*, from *serpo*, to creep.] Affected with serpigo.

**SERPIGO**, *n.* [*L. from serpo*, to creep.]

An exploded name of *Herpes circinatus* or *ringworm*.

**SERPLATH**, *n.* A weight equal to eighty stones. [*Scotch.*]

**SERPU'LIÐÆ**, or **SERPU'LIÐANS**, *n.* A family of cephalobranchiate annelidans, of which the genus *Serpula*

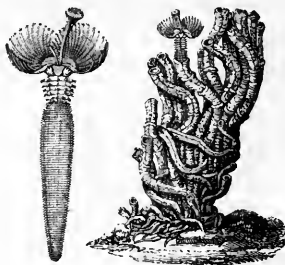

Serpulidæ.

is the type. They inhabit calcareous tubes of a cylindrical and tortuous form, and are generally parasitic upon stones and shells. They are also named *Tubicolæ*.

**SERPU'LIÐAN**, *n.* An animal with a winding shell; a worm shell.

**SER'PULITE**, *n.* Petrified shells or fossil remains of the genus *Serpula*.

**SERR**, † *v. t.* [*Fr. serrer*; *Sp.* and *Port. cerrar*.] To crowd, press, or drive together.

**SERRANUS**, *n.* A genus of fishes nearly allied to the perches, but readily distinguished by their possessing only

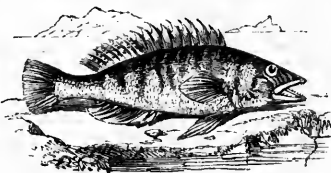

Lettered Serranus (S. scriba).

one dorsal fin, and seven branchiostegous rays. The *S. cabrilla*, and *S. couchii*, are found off the British coast.

**SERRATE**, } *a.* [*L. serratus*, from  
**SERRATED**, } *serro*, to saw; *serra*, a saw.] Notched on the edge like a

saw. In *bot.*, having sharp notches about the edge, pointing toward the extremity; as, a *serrate* leaf.

When a serrate leaf has small serratures upon the large ones, it is said to be *doubly serrate*, as in the elm. We say also, a *serrate* calyx, corolla, or stipule. A *serrate-ciliate* leaf, is one having fine hairs, like the eye-lashes, on the serratures. A *serrate-dentate* leaf has the serratures toothed. A *serrulate* leaf, is one finely serrated, with very small notches—2. In *zool.*, applied to those parts or margins which have jagged incisions like the teeth of a saw.—3. In *anat.*, applied to muscles and other parts from their appearance.

**SERRATION**, *n.* Formation in the shape of a saw.

**SERRATULA**, *n.* A genus of plants. [*See* Saw-Woat.]



Serrated Leaf.

**SERVATURE**, *n.* A notching in the edge of any thing, like a saw.

**SERRICORNES**, or **SERRICORNS**, *n.* [*L. serra*, a saw, and *cornu*, a horn.]

Cuvier's third family of coleopterous insects, comprehending those which have serrated or saw-shaped antennæ; as the *Buprestis*, *Elater*, &c.

**SERRIED**, *pp.* or *a.* Crowded; compacted; as, *serried* files.

**SERRIOUS**, *a.* Like the teeth of a saw; irregular. [*Little used.*]

**SERRULATE**, } *a.* Finely serrate;  
**SERRULATED**, } having very minute notches. When the edges of leaves or margins of shells are very finely jagged or notched, they are said to be *serrulated*, not *serrated*.

**SERRULATIONS**, *n.* Notchings like the teeth of a saw.

**SERRY**, † *v. t.* [*Fr. serrer*.] To crowd; to press together.

**SERTULARIA**, *n.* A Linnæan genus of Polypharia, now the type of a numerous family Sertularidæ.

**SERUM**, *n.* [*L.*] The thin transparent part of the blood; also the lymph-like fluid secreted by certain membranes in the human body, such as the pericardium, pleura, peritoneum, &c. which are thence denominated *serous membranes*. The serum of the blood, which separates from the crassamentum, during the coagulation of that liquid, has a pale, straw-coloured, or greenish-yellow colour, is transparent when carefully collected, has a slightly saline taste, and is somewhat unctuous to the touch. It usually constitutes about three-fourths of the blood, the pressed coagulum forming about one-fourth. [*See* BLOOD.]—2. The thin part of milk; whey.

**SERVAL**, *n.* A digitigrade carnivorous mammal of the cat genus, the *Felis Serval* of Southern Africa. It is a middle sized species with a long tail and black spots.

**SERVANT**, *n.* [*Fr.* from *L. servans*, from *servo*, to keep or hold; properly one that waits, that is, stops, holds, attends, or one that is bound.] 1. A person, male or female, that attends another for the purpose of performing menial offices for him, or who is employed by another for such offices or for other labour, and is subject to his command. The word is correlative to *master*. *Servant* differs from *slave*, as the servant's subjection to a master is voluntary, the slave's is not. Every slave is a servant, but every servant is not a slave. Servants are of various kinds; as *household* or *domestic servants*, menial servants; *labourers*, who are hired by the day, week, or other term, and do not reside with their employers, or if they board in the same house, are employed abroad and not in domestic services; *apprentices*, who are bound for a term of years to serve a master, for the purpose of learning his trade or occupation. In a *legal sense*, stewards, factors, bailiffs, and other agents, are *servants* for the time they are employed in such character, as they act in subordination to others.—2. One in a state of subjection.—3. In *Scripture*, a slave; a bondman; one purchased for money, and who was compelled to serve till the year of jubilee; also, one purchased for a term of years: Exod. xxi.—4. The subject of a king; as, the *servants* of David or of Saul.

The Syrians became *servants* to David; 2 Sam. viii.

5. A person who voluntarily serves another or acts as his minister; as, Joshua was the *servant* of Moses, and the apostles the *servants* of Christ. So Christ himself is called a *servant*; Isa. xlii. Moses is called the *servant* of the Lord; Deut. xxiv.—6. A person employed or used as an instrument in accomplishing God's purposes of mercy or wrath. So Nebuchadnezzar is called the *servant* of God; Jer. xxv.—7. One who yields obedience to another. The saints are called the *servants* of God, or of righteousness; and the wicked are called the *servants* of sin; Rom. vi.—8. That which yields obedience, or acts in subordination as an instrument; Ps. cxix.—9. One that makes painful sacrifices in compliance with the weakness or wants of others; 1 Cor. ix.—10. A person of base condition or ignominious spirit; Eccles. x.—11. A word of obedience. I am, sir, your humble or obedient *servant*.

Our betters tell us they are our humble *servants*, but understand us to be their slaves. *Swift*.

*Servant of servants*, one debased to the lowest condition of servitude; Gen. ix. SERV'ANT, † v. t. To subject. SERVE, v. t. (serv.) [Fr. *servir*; It. *servire*; Sp. *servir*; from L. *servio*. This verb is supposed to be from the noun *servus*, a servant or slave, and this from *servo*, to keep. If *servus* originally was a slave, he was probably so named from being *preserved* and taken prisoner in war, or more probably from being bound, and perhaps from the Shemitic *tzur*, *tzur*, *tzur*, *tzur*, to bind. But the sense of *servant* is generally a waiter, one who attends or waits, and from the sense of stopping, holding, remaining.] 1. To work for; to bestow the labour of body and mind in the employment of another.

Jacob loved Rachel and said, I will *serve* thee seven years for Rachel thy younger daughter; Gen. xxix.

No man can *serve* two masters; Matth. vi. 2. To act as the minister of; to perform official duties to; as, a minister *serves* his prince.

Had I *served* God as diligently as I have *served* the king, he would not have given me over in my grey hairs. *Cardinal Wolsey*.

3. To attend at command; to wait on. A goddess among gods, adored and *serv'd* By angels numberless, thy daily train. *Milton*.

4. To obey servilely or meanly. Be not to wealth a *servant*.—5. To supply with food; as, to be *served* in plate.—6. To be subservient or subordinate to. Bodies bright and greater should not *seve* The less not bright. *Milton*.

7. To perform the duties required in; as, the curate *served* two churches.—8. To obey; to perform duties in the employment of; as, to *serve* the king or the country in the army or navy.—9. To be sufficient to, or to promote; as, to *serve* one's turn, end, or purpose.—10. To help by good offices; as, to *serve* one's country.—11. To comply with; to submit to.

They think herein we *serve* the time, because thereby we either hold or seek preferment. *Hooker*.

12. To be sufficient for; to satisfy; to content.

One half pint bottle *serves* them both to dine, And is at once their vinegar and wine. *Pope*.

13. To be in the place of any thing to one. A sofa *serves* the Turks for a seat and a couch.—14. To treat; to requite; as, he *served* me ungratefully; he *served* me very ill. We say also, he *served* me a trick, that is, he deceived me, or practised an artifice upon me.—15. In *Scripture* and *theol.*, to obey and worship; to act in conformity to the law of a superior, and treat him with due reverence.

Fear the Lord, and *serve* him in sincerity and truth. As for me and my house, we will *serve* the Lord; Josh. xxiv.

16. In a *bad sense*, to obey; to yield compliance or act according to. *Serving* divers lusts and pleasures; Tit. iii.

17. To worship; to render homage to; as, to *serve* idols or false gods; Ezek. xx.—18. To be a slave to; to be in bondage to; Gen. xv.—19. † To *serve* one's self of, to use; to make use of; a *Gallicism*.—20. To use; to manage; to apply. The guns were well *served*.—21. In *seamen's lan.*, to wind something round a rope to prevent friction.—To *serve* up, to place on the table; as, to *serve* up a sirloin of beef in plate; the dinner was *served* up. [This phrase derives its origin from the circumstance of the kitchen being usually below the level of the dining room.]—To *serve* in, as used by Shakspeare, to bring in, as meat by an attendant.—To *serve* out, to distribute in portions; as, to *serve* out provisions to soldiers. In *vulgar lan.*, to be revenged on some one; as, I'll *serve* him out; I have *served* her out.—To *serve* a writ, to read it to the defendant; or to leave an attested copy at his usual place of abode.—To *serve* an attachment, or writ of attachment, to levy it on the person or goods by seizure; or to seize.—To *serve* an execution, to levy it on lands, goods, or person by seizure or taking possession.—To *serve* a warrant, to read it, and to seize the person against whom it is issued. In general, to *serve* a process, is to read it so as to give due notice to the party concerned, or to leave an attested copy with him or his attorney, or at his usual place of abode.—To *serve* a person heir to a property, in *Scots law*, is to take the necessary legal steps for putting him in possession of the property. [See SERVICE.]—To *serve* an office, to discharge a public duty.

SERVE, v. i. (serv.) To be a servant or slave. The Lord shall give thee rest from thy sorrow, and from thy fear, and from the hard bondage wherein thou wast made to *serve*; Is. xiv. 2. To be employed in labour or other business for another; Gen. xxix.—3. To be in subjection; Is. xliii.—4. To wait; to attend; to perform domestic offices to another; Luke x.—5. To perform duties, as in the army, navy, or in any office. An officer *serves* five years in India, or under a particular commander.—6. To answer; to accomplish the end. She feared that all would not *serve*. *Sidney*.

[It is more usual to say, *serve* the turn.] 7. To be sufficient for a purpose. This little brand will *serve* to light your fire. *Dryden*.

8. To suit; to be convenient. Take this, and use it as occasion *serves*.—9. To conduce; to be of use. Our victory only *served* to lead us on to further visionary prospects. *Swift*.

10. To officiate or minister; to do the honours of; as, to *serve* at a public dinner.

SERVED, *pp*. Attended; waited on; worshipped; levied.

SERV'ER, n. A salver or plate.—*Time-server*. [See under TIME.]

SERVICE, n. [Fr.; It. *servizio*; from L. *servitium*.] 1. In a general sense, labour of body or of body and mind, performed at the command of a superior, or in pursuance of duty, or for the benefit of another. *Service* is *voluntary* or *involuntary*. *Voluntary* service is that of hired servants, or of contract, or of persons who spontaneously perform something for another's benefit. *Involuntary* service is that of slaves, who work by compulsion.—2. The business of a servant; menial office.—3. Attendance of a servant.—4. Place of a servant; actual employment of a servant; as, to be out of *service*.—5. Any thing done by way of duty to a superior.

This poem was the last piece of *service* I did for my master King Charles. *Dryden*.

6. Attendance on a superior. Madam, I entreat true peace of you, Which I will purchase with my duteous *service*. *Shak*.

7. Profession of respect uttered or sent. Pray do my *service* to his majesty. *Shak*.

8. Actual duty; that which is required to be done in an office; as, to perform the *services* of a clerk, a sheriff, or judge.—9. That which God requires of man; worship; obedience.

God requires no man's *service* upon hard and unreasonable terms. *Tillotson*.

10. Employment; business; office; as, to qualify a man for public *service*.

11. Use; purpose. The guns are not fit for public *service*.—12. Military duty by land or sea; as, military or naval *service*.—To retire from the *service*, to quit the navy.—To see *service*, to be in actual contact with the enemy at sea, &c.—Home *service*, the naval or military duty which is carried on within the limits of Great Britain and Ireland.—Foreign *service*, the duty performed at any distant place, or on a foreign station.—13. A military achievement.—14. Any duty performed in behalf of government.—Secret *service*, any *service* performed in a perfectly clandestine manner; as, the gaining intelligence respecting the proceedings of a court, the movements of an army, &c.—Secret *service* money, money paid by government as the reward or compensation for such *services*.—15. Useful office; advantage conferred; that which promotes interest or happiness. Medicine often does no *service* to the sick; calumny is sometimes of *service* to an author.—16. Favour.

To thee a woman's *services* are due. *Shak*.

17. The duty which a tenant owes to his lord for his fee. Personal *service* consists in homage and fealty, &c.—Annual *service* is rent, suit to the court of the lord, &c.—Accidental *services* are heriots, reliefs, &c.—18. Public worship, or office of devotion. Divine *service* was interrupted.—19. A musical church composition consisting of choruses, trios, duets, solos, &c. The name given, in *English cathedral music*, to the *Te Deum*, and *Jubilate*, the *Magnificat*, and *Nunc Dimittis*, the *Cantate Domino*, and *Deus Misereatur*, collectively or separately.—20. The

official duties of a minister of the gospel, as in church, at a funeral, marriage, &c.—21. Course; or, order of dishes at table.

There was no extraordinary *service* seen on the board. *Hakewill.*

22. A set or number of vessels ordinarily used together; as, a *service* of plate or glass.—23. In *seamen's lan.*, the materials used for serving a rope, as spun yarn, small lines, &c.—24. The common name of two species of plants of the genus *Pyrus*. [See *SERVICE TREE*.]—*Service of an heir*, in *Scots law*, is a proceeding before a jury for ascertaining the heir of a person deceased. It is either general or special. A *general service* ascertains generally who is heir of another; it is equal to an assignation to the heir served of all personal rights held by the deceased, and therefore of all procuratories and precepts held by him and not executed. A *special service* ascertains who is heir to particular lands or heritage in which a person dies infert. It entitles the heir served to a precept of *clare constat*, or charter of confirmation, and precept of *clare constat* from the superior for infertment.—*Service of a writ, process, &c.*, the reading of it to the person to whom notice is intended to be given, or the leaving of an attested copy with the person or his attorney, or at his usual place of abode.—*Service of an attachment*, the seizing of the person or goods according to the direction.—*The service of an execution*, the levying of it upon the goods, estate, or person of the defendant.

**SERVICEABLE, a.** That does service; that promotes happiness, interest, advantage, or any good; useful; beneficial; advantageous. Rulers may be very *serviceable* to religion by their example. The attentions of my friends were very *serviceable* to me when abroad. Rain and manure are *serviceable* to land.—2. Active; diligent; officious.

I know thee well, a *serviceable* villain.

[Unusual.] *Shak.*

**SERVICEABLENESS, n.** Usefulness in promoting good of any kind; beneficialness.

All action being for some end, its aptness to be commanded or forbidden must be founded upon its *serviceableness* or dis-serviceableness to some end. *Norris.*

2. Officiousness; readiness to do service.

**SERVICEABLY, adv.** In a *serviceable* manner.

**SERVICE-BOOK, n.** A missal or prayer-book; as, the *service-book* of the episcopal church, attempted to be established in Scotland in the seventeenth century.

**SERVICE PIPE, n.** A pipe, usually of lead or iron, for the supply of water to a building.

**SERVICE TREE, n.** The true service tree is the *Pyrus domestica*, and the wild service tree is the *Pyrus torminalis*. [See *PYRUS*.]

**SERVIENT,† a.** [L. *serviens*.] Subordinate.—*Servient tenement*, in *Scots law*, a tenement or subject over which a predial servitude is constituted; an estate in respect of which a service is owing; the *dominant tenement* being that to which the service is due.

**SERVILE, a.** [Fr. from L. *servilis*, from *servio*, to serve.] 1. Such as pertains to a servant or slave; slavish; mean; such as proceeds from dependence; as, *servile* fear; *servile* obe-

dience.—2. Held in subjection; dependent.

Ev'n fortune rules no more a *servile* land. *Pope.*

3. Cringing; fawning; meanly submissive; as, *servile* flattery.

She must bend the *servile* knee. *Thomson.*

4. In *gram.*, not belonging to the original root; as, a *servile* letter.

**SERVILELY, adv.** Meanly; slavishly; with base submission or obsequiousness.—2. With base deference to another; as, to copy *servilely*; to adopt opinions *servilely*.

**SERVILENESS, } n.** Slavery; the condition of a slave or bondman.

To be a queen in bondage, is more vile Than is a slave in base *servility*. *Shak.*

2. Mean submission; baseness; slavishness.—3. Mean obsequiousness; slavish deference; as, the common *servility* to custom; to copy manners or opinions with *servility*.

**SERVING, prp.** Working for; acting as a servant; acting in subordination to; yielding obedience to; worshipping; also, performing duties; as, *serving* in the army.

**SERVING, n.** In *marine lan.*, the operation of winding any thing round a rope to prevent it from being rubbed or chafed. The materials used for this purpose, which are called *service*, are generally spun yarn, small lines, senit, or ropes; sometimes leather, old canvas, &c.—*Serving board*, a small piece of board with a notch or groove, in which spun yarn is twisted.—*Serving mallet*, a mallet used in serving the rigging, which binds the spun yarn more firmly about it than could possibly be done by the hand.

**SERVING-MAID, n.** A female servant; a menial.

**SERVING-MAN, n.** A male servant; a menial.

**SERVITOR, n.** [It. *servitore*; Fr. *serviteur*; from L. *servio*, to serve.] 1. A servant; an attendant.—2. One that acts under another; a follower or adherent.—3. One that professes duty and obedience.—4. In the *university of Oxford*, an under graduate who is partly supported by the college funds, and whose duty it was formerly to wait at table on the fellows and gentlemen commoners; hence the name. The servitors at Oxford are the same class as the sizars at Cambridge. [See *SIZAR*.]

**SERVITORSHIP, n.** The office of a servitor.

**SERVITUDE, n.** [Fr. from L. *servitudo* or *servitus*; It. *servitù*. See *SERVE*.] 1. The condition of a slave; the state of involuntary subjection to a master; slavery; bondage. Such is the state of the slaves in America. A large portion of the human race are in *servitude*.—2. The state of a servant. [Less common and less proper.]—3. The condition of a conquered country.—4. A state of slavish dependence. Some persons may be in love with splendid *servitude*.—5.† Servants, collectively.—*Servitude*, in *civil law*, is the right to the use of a thing without property in the same for all or for some particular purposes. It is divided into real or predial, mixed, and personal: the first being the subjection of an inheritable thing to certain duties or services towards another inheritable thing; the second that of an inheritable thing towards a person; the third, that of a

person towards a person or thing, *i. e.* *slavery*, whether by dependence on a person or on the soil. The word *servitude* is equally applicable to the duty or burden, and to the right of exacting it, *e. g.*, the right of way which A. enjoys on the land of B., and B.'s liability to permit that right to be exercised, are both designated by the term *servitude*, the first active, the latter passive. Real servitudes are numerous, and fall into several classes or divisions. They are, for example, either *visible*, such as the right to light, and air, sewers, &c.; or, *latent*, such as the right of way, right of drawing water, &c., which appear only when they are exercised. In *Scots law*, servitudes are either predial, or personal. A predial servitude is defined to be a servitude constituted over one subject or tenement in favour of the proprietor of another subject or tenement. Personal servitudes are those constituted over a subject in favour of a person without reference to his possession of another subject. In Scotland the only rights classed under personal servitudes are the different kinds of usufruct;—life-rent by reservation or constitution, *terce*, and *courtesy*.

**SES'AME, } n.** [Fr. *sesame*; L. *sesames* *AMUM*, } *ma*; Gr. *σησαμιον, σησαμιος*.] Oily grain; a genus of annual herbaceous plants, nat. order Pedaliaceae. The species, though now cultivated in many countries, are supposed to have been originally natives of India. They have alternate leaves and axillary solitary flowers. The species *S. orientale*,



Sesame (*Sesamum orientale*).

*indicum, luteum, laciniatum, and radiatum*, are cultivated in various countries, especially in India, Egypt, and Syria. They have also been taken to the West Indies, where the plant is called bango and oil-plant. Sesamum seeds are sometimes added to broths, frequently to cakes by the Jews, and likewise in the East. The oil expressed from them is bland, and of a fine quality, and will keep many years without becoming rancid, and is often used in India as a salad oil. The leaves of the plant are mucilaginous, and are employed for poultices. Of the seeds, two varieties are known in commerce, the one white and the other black.

**SES'AMOID BONES, n.** [Gr. *σησαμιον*, a seed or grain, and *σidos*, form.] Small bones formed at the articulations of the great toes, and occasionally at the joints of the thumbs.

**SESBA'NIA, n.** A genus of plants, nat. order Leguminosae. The species are

shrubs or herbs found in Egypt and the equinoctial parts of the world. *S. aegyptiaca*, the Egyptian species, found also in India, forms a small and very elegant tree, the wood of which is employed in making the best charcoal for gunpowder. *S. cannabina*, the Dhanchi of Bengal, is cultivated on account of the fibres of the bark, which are generally employed for the drag-ropes, and other cordage about fishing nets.

**SES'ELI**, *n.* [L. Gr. *seselis*.] A genus of umbelliferous plants. *S. libanotis* is a British plant, found in chalky pastures, in Cambridgeshire. It is known by the name of mountain meadow-saxifrage.

**SE'SIA**, *n.* A genus of lepidopterous insects, belonging to the family Sphingidae.

**SESE'RIA**, *n.* Moor-grass, a genus of plants. [See MOOR-GRASS.]

**SES'QUI**, *n.* [L.] A prefix signifying one integer or whole, and a half; as, *sesqui granum*, a grain and a half, &c. In *chem.*, this term is used to designate compounds in which an equivalent and a half of one substance are combined with one of another; thus, *sesquicarbonate* of soda is a salt composed of one equivalent and a half of carbonic acid with one of soda. In *music*, it signifies a whole and a half: joined with *altera*, *terza*, *quarta*, it is much used in the Italian music, to express a set of ratios, particularly the several species of triple time. In *geom.*, it expresses a ratio in which the greater term contains the less once, and leaves a certain aliquot part of the less over; but such terms are nearly obsolete.

**SESQUIAL'TER**, *n.* The name of a stop on the organ, containing three ranks of pipes, thus giving three pipes to each organ key, which are tuned in different but harmonic intervals. Sometimes the *mixture stop* is considered as part of the sesquialter, in which case the latter is said to contain five ranks of pipes, all tuned in harmonic intervals.

**SESQUIAL'TER**, } *a.* [L. from *sesquialteral*, } *qui*, the whole and half as much more, and *alter*, other.]  
1. In *arith.* and *geom.*, designating a ratio where one quantity or number contains another once, and half as much more; as 9 contains 6 and its half.—2. A *sesquialteral floret* is when a large fertile floret is accompanied with a small abortive one.

**SESQUIAL'TERATE**, *a.* In *arith.* and *geom.*, designating a ratio between two numbers, lines, &c., in which the greater is equal to once and a half of the less.

**SESQUIBRO'MIDE**, *n.* A basic compound of bromine with another element, in the proportions of three equivalents of bromine to two of the other element.

**SESQUICAR'BONATE**, *n.* A salt composed of three equivalents of carbonic acid, with two equivalents of any base; as the *sesquicarbonate* of ammonia, *i. e.* the common volatile salt of hartshorn.

**SESQUICHELO'RIDE**, *n.* A basic compound of chlorine with another element, in the proportions of three equivalents of chlorine to two of the other element.

**SESQUICY'ANIDE**, *n.* A basic compound of cyanogen with some element, in the proportions of three equivalents of cyanogen to two of the other element.

**SESQUIDU'PLE**, *a.* [L. *sesquiduplus*,] is sometimes used in the same manner as *sesquiduplicate*, to denote the pro-

portions of two and a half to one, or rather of five to two.

**SESQUIDU'PLICATE**, *a.* [L. *sesqui*, supra, and *duplicatus*, double.] Designating the ratio of two and a half to one, or where the greater term contains the lesser twice and a half, as that of 50 to 20.

**SESQUI'ODIDE**, *n.* A basic compound of iodine with another element, in the proportions of three equivalents of iodine to two of the other element.

**SESQUIP'EDAL**, } *a.* [L. *sesqui*,  
**SESQUIPEDA'LIAN**, } one and a half, and *pedalis*, from *pes*, a foot.] Containing a foot and a half; as, a *sesquipedalian* pigmy.

**SESQUIP'LICATE**, *a.* [L. *sesqui*, one and a half, and *plicatus*, *plico*, to fold.] Designating the ratio of one and a half to one; as, the *sesquuplicate* proportion of the periodical times of the planets.

**SESQUISUL'PHIDE**, *n.* A basic compound of sulphur with some other element, in the proportions of three equivalents of sulphur to two of the other element.

**SESKITER'TIAN**, } *a.* [L. *sesqui*,  
**SESKITER'TIONAL**, } one and a half, and *tertius*, third.] Designating the ratio of one and one third.

**SES'QUITONE**, *n.* In *music*, a minor third, or interval of three semitones.

**SESQUOX'IDE**, *n.* A basic compound of oxygen with some other element, in the proportions of three equivalents of the oxygen to two of the other element.

**SESS**, *n.* [L. *sessio*.] A tax. [Lit. *us.*, or *not at all*. See CESS, ASSESSMENT.]

**SES'SILE**, *a.* [L. *sessilis*.] Having a sitting position, or as if sitting. In *bot.*, a *sessile* leaf issues directly from the main stem or branch, without a petiole or footstalk. A *sessile* flower has no peduncle. A *sessile gland* is one not elevated on a stalk. A *sessile stigma* is one without a style, as in the poppy.

**SES'SION**, *n.* [Fr. from L. *sessio*, from *sedeo*. See SET.] 1. A sitting or being placed; as, the ascension of Christ, and his *session* at the right hand of God.

—2. The actual sitting of a court, academic body, council, legislature, &c.; or the actual assembly of the members of these or any similar body, for the transaction of business. Thus we say, the court is now in *session*, meaning that the members are assembled for business.—3. The time, space, or term during which a court, council, legislature, and the like, meet daily for business; or the space of time between the first meeting and the prorogation, with no other interval than adjournments. Thus a *session* of parliament is opened with a speech from the throne, and closed by prorogation. The *session* of a judicial court is called a term. Thus a court may have two *sessions* or four *sessions* annually.—*Sessions of the peace*. In *English law*, the term "*session of the peace*" is applied to designate a sitting of justices of the peace for the execution of those duties which are confided to them by their commission, and by charter or statute. Such are:—1. A petty session, which is a private meeting of two or more justices of the peace for the execution of some power vested in them by law; as, the holding parties to bail against whom a charge of felony has been entertained. 2. A *special session*, which is principally distinguished from the former by being public. Special sessions are held to

grant licences, execute the provisions of the highway act, appoint overseers for the poor, and for many other purposes.—3. *Quarter sessions*. [See QUARTER.] In most corporate towns there are quarter sessions, &c., and the sovereign is empowered to grant a court of quarter sessions to those municipal corporations who shall petition for the same under particular circumstances. There are sessions of constables of hundreds, or high constables, held at particular times, generally in the autumn, for regulating the hiring of servants, who go thither for the purpose of being hired; these are called statute sessions, or a statute fair.—*Court of session*, the supreme civil court of Scotland, having jurisdiction in all civil questions of whatever nature. It was instituted in 1532. The number of judges is thirteen; the lord president, the lord justice clerk, and eleven ordinary lords. They sit in two divisions, the lord president and three ordinary lords forming the first division, and the lord justice clerk, and other three ordinary lords, the second division. The chambers in which they hold their sittings is called the inner house. There are five permanent lords ordinary, the last appointed of whom officiates on the bills during session, and performs the other duties discharged by the junior lord ordinary; and the other four perform in weekly rotation the duties of ordinary in the outer house. All who consider themselves aggrieved by judgments of the court of session have the power of appealing to the house of lords. The judges hold their office *ad vitam aut culpam*, and their nomination and appointment are in the crown.—*Kirk session*. [See KIRK.]

**SESS'-POOL**, *n.* [*sess* and *pool*.] A cavity sunk in the earth to receive and retain the sediment of water conveyed in drains. *Sess-pools* should be placed at proper distances in all drains, and particularly should one be placed at the entrance. [It is also written *cess-pool*.]

**SESTERCE**, or **SESTERTIUS**, *n.* [Fr. from L. *sestertius*.] A Roman coin or denomination of money, in value the fourth part of a denarius, and originally containing two asses and a half, about two pence sterling. The Romans generally reckoned sums of money in sestertii, although the coin used in making payments was commonly the denarius. Large sums they reckoned by sestertia; that is, sums of a thousand *sestertii*. The coin itself was called *sestertius*, or *sestertius nummus*, or simply *nummus*. The sum of a thousand *sestertii* (about £8) was expressed by  *mille sestertii*, or *M. sestertium*, or *M. nummi*, or *M. nummum*, or *nummorum*, or *M. sestertii nummi*, or *M. sestertium nummum*. The singular, *sestertium*, is never used alone for a thousand *sestertii*, but the plural, *sestertia*, for all multiples of a thousand *sestertii*, up to a thousand. One qualification of a Roman knight was the possession of estate of the value of four hundred thousand sesterces; that of a senator was double this sum. Authors mention also a copper *sesterce*, of the value of one third of a penny sterling. *Sesterce* was also used by the ancients for a thing containing two wholes and a half; the *as* being taken for the integer.

SES'TET, } n. [It. *settetto*.] In music,  
 SES'TET TO, } a composition, vocal  
 or instrumental, consisting of six distinct  
 parts.

SET, v. t. *pret.* and *pp. set.* [Sax. *settan, setan, settan*, to set or place, to seat or fix, to appease, to calm, L. *sedo*; to compose, as a book, to dispose or put in order, to establish, found, or institute, to possess, to cease; G. *setzen*, to set, to risk or lay, as a wager, to plant, to appoint, to leap or make an onset; W. *sodi*, to fix, to constitute; *gosodi*, to set, to lay, to put, to establish, to ordain; *gosod*, a setting or placing, a site, a statute, an onset or assault; L. *sedo, sedeo, and sido*, coinciding with *sit*, but all of one family. From the Norman orthography of this word, we have *assess, assise*. See *ASSESS*. Heb. and Ch. יָסַד *yasad* and שִׁית *shuth*, to set, to place; Syr. *seti*, to found, to establish. The primary sense is to throw, to drive, or intransitively, to rush.]

1. To put or place; to fix or cause to rest in a standing posture. We set a house on a wall of stone; we set a book on a shelf. In this use, *set* differs from *lay*; we set a thing on its end or basis; we lay it on its side.—2. To put or place in its proper or natural posture. We set a chest or trunk on its bottom, not on its end; we set a bedstead or a table on its feet or legs.—3. To put, place, or fix in any situation. God set the sun, moon, and stars in the firmament.

I do set my bow in the cloud; Gen. ix.  
 4. To put into any condition or state.

The Lord thy God will set thee on high; Deut. xxviii.

I am come to set a man at variance against his father; Matt. x.

So we say, to set in order, to set at ease, to set to work, or at work.—5. To put; to fix; to attach to.

The Lord set a mark upon Cain; Gen. iv.

So we say, to set a label on a vial or a bale.—6. To fix; to render motionless; as, the eyes are set; the jaws are set.

—7. To put or fix, as a price. We set a price on a house, farm, or horse.—8. To fix; to state by some rule.

The gentleman spoke with a set gesture and countenance. *Carew*.

The town of Berne has handsome fountains planted at set distances from one end of the street to the other. *Addison*.

9. To regulate or adjust; as, to set a time-piece by the sun.

He sets his judgment by his passion.

10. To fit to music; to adapt with notes; as, to set the words of a psalm to music.

Set thy own songs, and sing them to thy lute. *Dryden*.

11. To pitch; to begin to sing in public.

He set the hundredth psalm. *Spectator*.

12. To plant, as a shrub, tree, or vegetable.—13. To variegate, intersperse, or adorn with something fixed; to stud; as, to set any thing with diamonds or pearls.

High on their heads, with jewels richly set, Each lady wore a radiant coronet.

14. To return to its proper place or state; to replace; to reduce from a dislocated or fractured state; as, to

set a bone or a leg.—15. To fix; to place; as, the heart or affections.

Set your affections on things above; Col. iii.

Minds altogether set on trade and profit. *Addison*.

16. To fix firmly; to predetermine.

The heart of the sons of men is fully set in them to do evil; Eccles. viii. Hence we say, a thing is done of set purpose; a man is set, that is, firm or obstinate in his opinion or way.—17. To fix by appointment; to appoint; to assign; as, to set a time for meeting; to set an hour or a day.—18. To place or station; to appoint to a particular duty.

Am I a sea or a whale, that thou settest a watch over me? Job vii.

19. To stake at play. [*Little used*.]—20. To offer a wager at dice to another.

[*Little used*.]—21. To fix in metal.

And him too rich a jewel to be set In vulgar metal for a vulgar use.

22. In the U. States, to fix; to cause to stop; to obstruct; as, to set a coach in the mire. The waggon or the team was set at the hill. In some of the states, *stall* is used in a like sense.—23. To embarrass; to perplex.

They are hard set to represent the bill as a grievance. *Addison*.

24. To put in good order; to fix for use; to bring to a fine edge; as, to set a razor.—25. To loose and extend; to spread; as, to set the sails of a ship.—26. To point out without noise or disturbance; as, a dog sets birds.—27. To oppose.

Will you set your wit to a fool's? *Shak*.  
 28. To prepare with runnet for cheese; as, to set milk.—29. To dim; to darken or extinguish.

Alijah could not see; for his eyes were set by reason of his age; 1 Kings xiv.

To set the land or the sun by the compass, to observe how the land bears on any point of the compass, or on what point the sun is.—To set the chase by the compass, to observe on what point the chased ship bears.—To set the sails, to loosen and expand them.—To set sail, also signifies to set out on a voyage; to begin to sail.—To set about, to begin, as an action or enterprise; to apply to. He has planned his enterprise, and will soon set about it.—To set one's self against, to place in a state of enmity or opposition.

The king of Babylon set himself against Jerusalem the same day; Ezek. xxiv.

To set against, to oppose; to set in comparison, or to oppose as an equivalent in exchange; as, to set one thing against another; or to set off one thing against another.—To set apart, to separate to a particular use; to separate from the rest.—To neglect for a time.—To set aside, to omit for the present; to lay out of the question.

Setting aside all other considerations, I will endeavour to know the truth and yield to that. *Tillotson*.

2. To reject.

I embrace that of the deluge, and set aside all the rest. *Woodward*.

3. To annul; to vacate. The court set aside the verdict, or the judgment.—To set abroad, to spread.—To set a-going, to cause to begin to move.—To set by, to set apart or on one side; to reject. [In this sense, *by* is emphatical.]—2. To esteem; to regard; to value. [In this sense, *set* is pronounced with more emphasis than

*by*.]—To set down, to place upon the ground or floor.—2. To enter in writing; to register.

Some rules were to be set down for the government of the army. *Clarendon*.

3. To explain or relate in writing.—4. To fix on a resolve. [*Little used*.]

—5. To fix; to establish; to ordain. This law we may name eternal, being that order which God hath set down with himself to do all things by.

To set forth, to manifest; to offer or present to view; Rom. iii.—2. To publish; to promulgate; to make appear.—3. To send out; to prepare and send.

The Venetian admiral had a fleet of sixty galleys, set forth by the Venetians.†

4. To display; to exhibit; to present to view; to show.—To set forward, to advance; to move on; also, to promote.—To set in, to put in the way to begin.

If you please to assist and set me in, I will recollect myself. *Collier*.

To set off, to adorn; to decorate; to embellish.

They set off the worst faces with the best airs. *Addison*.

2. To give a pompos or flattering description of; to enlarge; to recommend; as, to set off a character.—3. To place against as an equivalent; as, to set off one man's services against another's.—4. To separate or assign for a particular purpose; as, to set off a portion of an estate.—To set on or upon, to incite; to instigate; to animate to action.

Thou, traitor, hast set on thy wife to this. *Shak*.

2. To assault or attack; seldom used transitively, but the passive form is often used.

Alphonsus...was set upon by a Turkish pirate and taken. *Knolles*.

3. To employ, as in a task. Set on thy wife to observe. *Shak*.

4. To fix the attention; to determine to any thing with settled purpose.

It becomes a true lover to have your heart more set upon her good than your own. *Sidney*.

To set out, to assign; to allot; as, to set out the share of each proprietor or heir of an estate; to set out the widow's thirds.—2. To publish, as a proclamation. [*Not elegant nor common*.] 3. To mark by boundaries or distinctions of space.

Determinate portions of those infinite abysses of space and duration, set out, or supposed to be distinguished from all the rest by known boundaries. *Locke*.

4. To adorn; to embellish.

An ugly woman in a rich habit, set out with jewels, nothing can become. *Dryden*.  
 5. To raise, equip, and send forth; to furnish.

The Venetians pretend they could set out, in case of great necessity, thirty men of war. [*Not elegant and lit. us.*] *Addison*.  
 6. To show; to display; to recommend; to set off.

I could set out that best side of Luther. *Atterbury*.

7. To show; to prove. Those very reasons set out how heinous his sin was. [*Little used and not elegant*.] *Atterbury*.

To set up, to erect; as, to set up a building; to set up a post, a wall, a pillar.—2. To begin a new institution; to institute; to establish; to found;

as, to *set up* a manufactory; to *set up* a school.—3. To enable to commence a new business; as, to *set up* a son in trade.—4. To raise; to exalt; to put in power; as, to *set up* the throne of David over Israel; 2 Sam. iii.—5. To place in view; as, to *set up* a mark.—6. To raise; to utter loudly; as, to *set up* the voice.

I'll *set up* such a note as she shall hear.

*Dryden.*

7. To advance; to propose as truth or for reception; as, to *set up* a new opinion or doctrine.—8. To raise from depression or to a sufficient fortune. This good fortune quite *set* him up.—9. In *seamen's language*, to extend, as the shrouds, stays, &c.—To *set at naught*, to undervalue; to contemn; to despise.

Ye have *set at naught* all my counsel, Prov. 1.

To *set in order*, to adjust or arrange; to reduce to method.

The rest will I *set in order* when I come; 1 Cor. xi.

To *set eyes on*, to see; to behold; or to fix the eyes in looking on; to fasten the eyes on.—To *set the teeth on edge*, to affect the teeth with a painful sensation.—To *set over*, to appoint or constitute as supervisor, inspector, ruler or commander.—2. To assign; to transfer; to convey.—To *set right*, to correct; to put in order.—To *set at ease*, to quiet; to tranquillize; as, to *set the heart at ease*.—To *set free*, to release from confinement, imprisonment, or bondage; to liberate; to emancipate.—To *set at work*, to cause to enter on work or action; or to direct how to enter on work.—To *set on fire*, to communicate fire to; to inflame; and figuratively, to enkindle the passions; to make to rage; to irritate; to fill with disorder; James iii.—To *set before*, to offer; to propose; to present to view; Deut. xi.; xxx.—To *set a trap, snare, or gin*, to place in a situation to catch prey; to spread; figuratively, to lay a plan to deceive and draw into the power of another.

SET, *v. i.* To decline; to go down; to pass below the horizon; as, the sun *sets*; the stars *set*.—2. To be fixed hard; to be close or firm.—3. To fit music to words.—4. To congeal or concrete; to solidify.

That fluid substance in a few minutes begins to *set*.

*Boyle.*

5. To begin a journey. The king is *set* from London.—[This is obsolete. We now say, to *set out*.]—6. To plant; as, "to sow dry, and to *set wet*."—7. To flow; to have a certain direction in motion; as, the tide *sets* to the east or north; the current *sets* westward.—8. To catch birds with a dog that *sets* them, that is, one that lies down and points them out, and with a large net.—9. To point out game; as a sportsman's dog.—To *set one's self about*, to begin; to enter upon; to take the first steps.—To *set one's self*, to apply one's self.—To *set about*, to fall on; to begin; to take the first steps in a business or enterprise.—To *set in*, to begin. Winter, in England, usually *sets in* about December.—2. To become settled in a particular state.

When the weather was *set in* to be very bad.

*Adison.*

To *set forward*, to move or march; to begin to march; to advance.

The sons of Aaron and the sons of Merari *set forward*; Num. x.

To *set on*, or *upon*, to begin a journey or an enterprise.

He that would seriously *set upon* the search of truth. . . .

*Locke.*

2. To assault; to make an attack.—To *set off*, to start.—To *set out*, to begin a journey or course; as, to *set out* for London or from London; to *set out* in business; to *set out* in life or the world.—2. To have a beginning.—To *set to*, to apply one's self to.—To *set up*, to begin business or a scheme of life; as, to *set up* in trade; to *set up* for one's self.—2. To profess openly; to make pretensions. He *sets up* for a man of wit; he *sets up* to teach morality.

SET, *pp.* *placed*; put; located; fixed; adjusted; composed; studded or adorned; reduced, as a dislocated or broken bone.—2. *a.* Regular; uniform; formal; as, a *set* speech or phrase; a *set* discourse; a *set* battle.—3. Fixed in opinion; determined; firm; obstinate; as, a man *set* in his opinions or way.—4. Established; prescribed; as, *set* forms of prayer.

SET, *n.* A number or collection of things of the same kind and of similar form, which are ordinarily used together; as, a *set* of chairs; a *set* of teacups; a *set* of China or other ware.—2. A number of things fitted to be used together, though different in form; as, a *set* of dining-tables. A *set* implies more than two, which are called a *pair*.—3. A number of persons customarily or officially associated, as, a *set* of men, a *set* of officers; or a number of persons having a similitude of character, or of things which have some resemblance or relation to each other. Hence our common phrase, a *set* of opinions.

This falls into different divisions or *sets* of nations connected under particular religions, &c. *Ward's Law of Nations.*

4. A number of particular things that are united in the formation of a whole; as, a *set* of features.—5. A young plant for growth; as, *sets* of white thorn or other shrub.—*Sets and eyes of potatoes*, slices of the tubers of the potato for planting, each slice having at least one eye or bud.—6. The descent of the sun or other luminary below the horizon; as, the *set* of the sun.—7. A wager at dice.

That was but civil war, an equal *set*.

*Dryden.*

8. A game.

We will, in France, play a *set* Shall strike his father's crown into the hazard. *Shak.*

*Set or sett of a burgh*, in *Scots law*, the constitution of the burgh. The *sets* are either established by immemorial usage, or were at some time or other modelled by the convention of burghs.—A *dead set*, the act of a setter dog when it discovers the game, and remains intently fixed in pointing it out. The term is said by Grose to signify also a concerted scheme to defraud a person by gaming.—To *be at a dead set*, is to be in a fixed state or condition which precludes further progress.—To *make a dead set upon*, to make a determined onset, or an importunate application.

SETA, *n. plur.* *Setæ*. [L.] A term used by botanists in various senses. It is the stalk that supports the theca, capsule, or sporangium of mosses; the awn or beard of grasses, where it proceeds from the extreme point of a palea or glume; sometimes the glandular

aculeus of roses, and also the abortive stamens, or rudimentary perianth of Cyperaceous plants.

SETACEOUS, *a.* [L. *seta*, a bristle.] 1. Bristly; set with bristles; consisting of bristles; as, a stiff *setaceous* tail.—2. In *bot.*, bristle-shaped; having the thickness and length of a bristle; as, a *setaceous* leaf or leaflet.—*Setaceous worm*, a name given to a water worm that resembles a horse hair, vulgarly supposed to be an animated hair. But this is a mistake.—*Setaceo-rostrate*, having a beak with the figure of a bristle.

SETÆ, *n. plur.* [L.] Bristles. [See SETA.]

SETARIA, *n.* A genus of grasses, containing a few species cultivated as corn-grains in some countries. The species are found in both the hot and temperate parts of the world. Two are indigenous in England, *S. verticillata*, and *S. viridis*, and are called bristle-grass. *S. germanica* is cultivated in Hungary as food for horses, and *S. Italica* is cultivated in Italy and other parts of Europe, and sometimes called millet. The genus is sometimes included under *Panicum*.

SET-DOWN, *n.* A powerful rebuke or reprehension.

SET-FAIR, *n.* In *arch.*, the coat of plaster used after roughing in, and floated, or pricked up and floated.

SET-FOIL. See SEPT-FOIL.

SETIFEROUS, *a.* [L. *seta* and *fero*.] Producing or having bristles.

SETIFORM, *a.* [L. *seta*, a bristle, and *form*.] Having the form of a bristle.

SETIGEROUS, *a.* [L. *seta*, a bristle, and *gero*, to bear.] Covered with bristles.

SETIREME, *n.* [L. *seta* and *remus*.] An animal that has a dense fringe of hairs on the inner side of jointed legs, by which it moves on the water.

SETINESS, *n.* Regulation, adjustment; obstinacy. [Not much used.]

SET-OFF, *n.* [*set* and *off*.] 1. A demand on the other side against a previous demand; a counterbalance; also, a recommendation or decoration.—2. In *law*, the act of admitting one claim to counterbalance another. In a *set-off*, the defendant acknowledges the justice of the plaintiff's demand, but *sets up* a demand of his own to counterbalance it in whole or in part. It is only in actions for the non-payment of money that set-offs are allowable; set-offs not being allowed against unliquidated damages, penalties of bonds for the performance of covenants, &c.—3. The part of a wall, &c., which is exposed horizontally when the portion above it is reduced in thickness; also called *offset*.—4. Among printers, a *set-off* means the transferred impression from a printed page, the ink on which is undried, to an opposite page, when the two leaves are pressed together; this often occurs when printed sheets are too hastily bound up.

SETON, *n.* [Fr. from L. *seta*, a bristle.] In *sur.*, an artificial sinus made under the skin, by means of a few horse hairs or small threads, or a twist of silk, drawn through the skin by a large needle, called a seton needle, by which a small opening is made and continued for the discharge of humours.

SETOUS, *a.* [It. *setoso*; L. *setosus*, SETOSE, } from *seta*, a bristle.] In *bot.*, bristly; having the surface set

with bristles; as, a *setous* leaf or receptacle.

**SET-SPEECH**, *n.* A speech or discourse carefully prepared before it is delivered in public.

**SETT**, *n.* In *pitling*, a piece placed temporarily on the head of a pile which cannot be reached by the monkey or weight, but by means of some intervening matter.—*Sett of a burgh*. [See **SET**.]

**SETTEE**, *n.* [from *set*.] A long seat with a back to it.—2. A vessel with

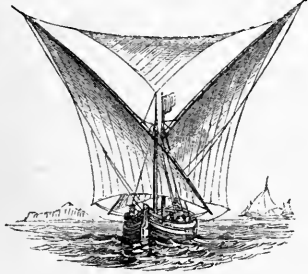

Settee.

one deck and a very long sharp prow, carrying two or three masts with sixteen sails; used in the Mediterranean.

**SETTER**, *n.* One that sets; as, a *setter* on, or inciter; a *setter up*; a *setter forth*, &c.—2. A dog that beats the field and starts birds for sportsmen. The setter is a variety of the dog, which partakes of the characters of the pointer and spaniel, *canis familiaris* index of Cains. When a well-broken, well-bred setter is hunted frequently, no dog trained to the gun does his work better, or is more staunch. The breed originated in all probability between the large English spaniel and the Spanish pointer. This variety possesses a high degree of intelligence, and is capable of the strongest attachment.—3. A man that performs the office of a setting dog, or finds persons to be plundered.—4. One that adapts words to music in composition.—5. † Whatever sets off, adorns, or recommends.—6. In *gunnery*, a round stick for driving fuses, or any other compositions, into cases made of paper.

**SETTER-WORT**, *n.* A plant, a species of *Helleborus*, the *H. fetidus*, a perennial.

**SETTING**, *ppr.* Placing; putting; fixing; studying; appointing; sinking below the horizon, &c.

**SETTING**, *n.* The act of putting, placing, fixing, or establishing.—2. The act of sinking below the horizon; as the sun or a star. The setting of stars is of three kinds, *cosmical*, *acronical*, and *heliacal*. [See these words.]—3. The act or manner of taking birds by a setting dog.—4. Inclosure; as, *settings* of stones; Exod. xxviii.—5. The direction of a current at sea.—6. In *arch.*, the quality of hardening in plaster or cement; also, the fixing of stones in walls or vaults.—*Setting coat*, the best sort of plastering on ceilings or walls.

**SETTING BOARD**, *n.* In *glazing*, where lead-work for lights is employed, a board on which the ridge of the light is worked and divided into squares, and struck out with a chalk line or drawn with a lath, which serve to guide the workman. One side and

end are squared with a projecting bead and fillet.—*Setting knife*, a blade with a round end, loaded with lead at the bottom of the blade, and having a long square handle. The square end of the handle serves to force the squares home tight in the lead. The knife serves for cutting off the ends of the lead.

**SETTING-DOG**, *n.* A setter; a dog trained to find and start birds for sportsmen.

**SETTING-OUT ROD**, *n.* A rod used by joiners for setting-out frames, as of windows, doors, &c.

**SETTLE**, *n.* [Sax. *setl*, *setll*; G. *sessel*; L. *sedile*. See **SET**.] A seat or bench; something to sit on.

**SETTLE**, *v. t.* [from *set*.] To place in a permanent condition after wandering or fluctuation.

I will settle you after your old estate; Ezek. xxxvi.

2. To fix; to establish; to make permanent in any place.

I will settle him in my house and in my kingdom for ever; 1 Chron. xvii.

3. To establish in business or way of life; as, to settle a son in trade.—4. To marry; as, to settle a daughter.—5. To establish; to confirm.

Her will alone could settle or revoke. *Prior.*

6. To determine what is uncertain; to establish; to free from doubt; as, to settle questions or points of law. The supreme court have settled the question.—7. To fix; to establish; to make certain or permanent; as, to settle the succession to a throne in a particular family. So we speak of settled habits and settled opinions.—8. To fix or establish; not to suffer to doubt or waver.

It will settle the wavering and confirm the doubtful. *Swift.*

9. To make close or compact.

Cover ant-hills up that the rain may settle the turf before the spring. *Mortimer.*

10. To cause to subside after being heaved and loosened by frost; or to dry and harden after rain. Thus clear weather settles the roads.—11. To fix or establish by gift, grant, or any legal act; as, to settle a pension on an officer, or an annuity on a child.—12. To fix firmly. Settle your mind on valuable objects.—13. To cause to sink or subside, as extraneous matter in liquors. In fining wine, we add something to settle the lees.—14. To compose; to tranquillize what is disturbed; as, to settle the thoughts or mind when agitated.—15. To establish in the pastoral office; to ordain over a church and society, or parish; as, to settle a minister.—16. To plant with inhabitants; to colonize. The French first settled Canada; the Puritans settled New England.

Provinces first settled after the flood. *Mtford.*

Land which they are unable to settle and cultivate. *Vattel, Trans.*

17. To adjust; to close by amicable agreement or otherwise; as, to settle a controversy or dispute by agreement, treaty, or by force.—18. To adjust; to liquidate; to balance, or to pay; as, to settle accounts.—To settle the main-top-sail halcyards, to ease off a small portion of them so as to lower the yard a little.—To settle the land, to cause it to sink or appear lower by receding from it.

**SETTLE**, *v. i.* To fall to the bottom

of liquor; to subside; to sink and rest on the bottom; as, lees or dregs settle. Slimy particles in water settle and form mud at the bottom of rivers. This word is used of the extraneous matter of liquors, when it subsides spontaneously. But in chemical operations, when substances mixed or in solution are decomposed, and one component part subsides, it is said to be precipitated. But it may also be said to settle.—2. To lose motion or fermentation; to deposit, as feces.

A government on such occasions, is always thick before it settles. *Addison.*

3. To fix one's habitation or residence. Belgians had settled on the southern coast of Britain before the Romans invaded the isle.—4. To marry and establish a domestic state. Where subsistence is easily obtained, children settle at an early period of life.—5. To become fixed after change or fluctuation; as, the wind came about and settled in the west.—6. To become stationary; to quit a rambling or irregular course for a permanent or methodical one.—7. To become fixed or permanent; to take a lasting form or state; as, a settled conviction.

Chyle runs through the intermediate colours till it settles in an intense red.

*Asbutnot.*

8. To rest; to repose.

When time hath worn out their natural vanity, and taught them discretion, their fondness settles on its proper object. *Spectator.*

9. To become calm; to cease from agitation.

Till the fury of his highness settle, Come not before him. *Shak.*

10. To make a jointure for a wife. He sighs with most success that settles well. *Garth.*

11. To sink by its weight; and in loose bodies, to become more compact. We say, a wall settles; a house settles upon its foundation; a mass of sand settles and becomes more firm.—12. To sink after being heaved, and to dry; as, roads settle in spring after frost and rain.—13. In *marine lan.*, to lower or sink, as, the deck has settled; that is, it has sunk below its first plan by the wood drying.—14. In *America*, to be ordained or installed over a parish, church, or congregation.—15. To adjust differences or accounts; to come to an agreement. He has settled with his creditors.

**SETTLED**, *pp.* Placed; established; fixed; determined; composed; adjusted.

**SETTLEDNESS**, *n.* The state of being settled; confirmed state. [Little used.]

**SETTLEMENT**, *n.* The act of settling, or state of being settled.—2. The falling of the foul or foreign matter of liquors to the bottom; subsidence.—3. † The matter that subsides; lees; dregs. [For this we use *Settlings*.]—4. The act of giving possession by legal sanction.

My flocks, my fields, my woods, my pastures take, With settlement as good as law can make. *Dryden.*

5. A jointure granted to a wife, or the act of granting it. We say, the wife has a competent settlement for her maintenance; or she has provision made for her by the settlement of a jointure.—6. The act of taking a domestic state; the act of marrying and going to housekeeping.—7. A becom-



ing stationary, or taking a permanent residence after a roving course of life.—8. The act of planting or establishing, as a colony; also, the place, or the colony established; as, the British settlements in America or India.—9. Adjustment; liquidation; the ascertainment of just claims, or payment of the balance of an account.—10. Adjustment of differences; pacification; reconciliation; as, the settlement of disputes or controversies.—11. The ordaining of a clergyman over a parish or congregation.—12. In America, a sum of money or other property granted to a minister on his ordination, exclusive of his salary.—13. Legal residence or establishment of a person in a particular parish; or the right which an individual acquires to parochial assistance under the statutes for the relief of the poor in that parish or district to which he legally belongs, and in which he is said to have the settlement. In England, the statutes 12 Richard II. and 19 Henry VII. seem to be the first rudiments of parish settlements. By statutes 13 and 14 Charles II. a legal settlement is declared to be gained by birth, by inhabitation, by apprenticeship, or by service for forty days. But the gaining of a settlement by so short a residence produced great evils, which were remedied by statute 1 James II. The law of settlement has in our day undergone considerable alterations by the Poor Laws Amendment Act 4 and 5 Will. IV., cap. 76.—14. Act of settlement, in British history, the statute of 12 and 13 William III., by which the crown was limited to her present majesty's house, or the house of Orange.—15. In law, a settlement, in the most general sense of the word, is a disposition of property of any kind, made for certain purposes by the owner, who, in relation to such disposition, is called the settlor or grantor. A settlement in this case may be made either by deed or by will, but the term is most commonly applied to such settlements as are made by deed, and these may be either made upon valuable or good consideration, or they may be purely voluntary. The most important species of settlements are marriage settlements. In Scots law, in cases of bankruptcy, when the creditors agree to give the insolvent person a discharge in full, on his paying them a part, instead of the whole of the debt he owes them, this is termed a settlement.—Disposition and settlement. [See under DISPOSITION.]—16. In arch., settlements are those parts in a building in which failures by sinking have occurred.

**SETTLER, n.** One who settles; particularly one who fixes his residence in a new colony.

**SETTLING, ppr.** Placing; fixing; establishing; regulating; adjusting; planting or colonizing; subsiding; composing; ordaining or installing.

**SETTLING, n.** The act of making a settlement; a planting or colonizing.—2. The act of subsiding, as lees.—3. The adjustment of differences.—4. *Settlings, plur.* lees; dregs; sediment.

**SETTLOR, n.** In law, the person who makes a settlement.

**SET-TÖ, n.** A conflict at fisty-cuffs.—2. Contentious argumentation. [*Familial.*]

**SETT' OFF, n.** In arch., the horizontal projection left in carrying up a wall,

where the thickness of it diminishes at its different stages or stories. Also, the sloped mouldings which divide Gothic buttresses into stages. It is also written *offset*.

**SETTS, n.** In mast-making, powers made use of, where force is required, to bring or unite two or more pieces together. This is performed by screws, shores, &c.

**SET'WALL, n.** [*set and wall.*] A plant. The garden *setwall* is a species of *Valeriana*.

**SEVEN, a.** (sev'n.) [*Sax. seofa, seofan; G. sieben; L. septem, whence Fr. sept, Sans. sapta; Pers. haft; Gr. ἑπτά; Ar. saba; Heb. Ch. Syr. and Eth. שבע, sheba.* In Ch. and Syr. שבע, *seba*, signifies to fill, to satisfy; in Ar. seven, and to make the number seven. In Heb. and Ch. שבע, *sheba*, is seven; Ar. *shabia*, to fill. With this orthography coincides the spelling of the Teutonic and Gothic words whose elements are *Sb*, or their cognates. But the Latin and Sanscrit have a third radical letter, as has the Persian, viz. *t*, and these coincide with the Ar. *sabata*, to observe the sabbath, to rest, Heb. Ch. and Syr. שבת, *shabath*. It is obvious then that *seven* had its origin in these verbs, and if the Persian and Greek words are from the same source, which is very probable, we have satisfactory evidence that the sibilant letter *s* has been changed into an aspirate. And this confirms an opinion that a similar change has taken place in the Gr. ἅλς, salt, W. *halen*, and in many other words.] Four and three; one more than six or less than eight. *Seven days* constitute a week. We read in Scripture of seven years of plenty, and seven years of famine, seven trumpets, seven seals, seven vials, &c. *Seven stars*, the *Pleiadas*,—which see. *Seven wise men*, or *seven sages of Greece*, a name commonly applied to seven philosophers, several of whom were legislators, at an early period of Grecian history. They were Periander of Corinth, Pittacus of Mitylene, Thales, Solon, Bias, Chilo, and Cleobulus. *Seven wonders of the world.* [See *WONDER*.]

**SEVENFOLD, a.** [*seven and fold.*] Repeated seven times; doubled seven times; increased to seven times the size or amount; as the sevenfold shield of Ajax; sevenfold rage.

**SEVENFOLD, adv.** Seven times as much or often.

Whoever slayeth Cain, vengeance shall be taken on him sevenfold; Gen. iv.

**SEVEN-HILLED, a.** Having seven hills.

**SEVENNIGHT, n.** [*seven and night.*] A week; the period of seven days and nights; or the time from one day of the week to the next day of the same denomination preceding or following. Our ancestors numbered the diurnal revolutions of the earth by *nights*, as they reckoned the annual revolutions by *winters*. *Sevennight* is now contracted into *Se'night*,—which see.

**SEVENSCORE, n.** [*seven and score*, twenty notches or marks.] Seven times twenty, that is, a hundred and forty.

The old countess of Desmond, who lived seven score years, denized twice or thrice.

*Bucon.*

**SEVENTEEN, a.** [*Sax. seofontyne; seven-ten.*] Seven and ten.

**SEVENTENTH, a.** [*from seventeen.*] The Saxon *seofonteotha* or *seofon-teo-*

*getha* is differently formed.] The ordinal of seventeen; the seventh after the tenth.

On the *seventeenth* day of the second month ... all the fountains of the great deep were broken up; Gen. vii.

**SEVENTH, a.** [*Sax. seofeltha.*] 1. The ordinal of seven; the first after the sixth.

On the *seventh* day God ended his work which he had made, and he rested on the *seventh* day from all his work which he had made; Gen. ii.

2. Containing or being one part in seven; as, the *seventh* part.

**SEVENTH, n.** The seventh part; one part in seven.—2. In music, a dissonant interval or heptachord. An interval consisting of four tones and two major semitones, is called a *seventh* minor. An interval composed of five tones and a major semitone, is called a *seventh* major.—*Defective seventh*, an interval consisting of three tones and three greater semitones.—*Extreme sharp seventh*, an interval which is only a comma less than the octave.

**SEVENTHLY, adv.** In the seventh place.

**SEVENTIETH, a.** [*from seventy.*] The ordinal of seventy; as, a man in the *seventieth* year of his age.

**SEVENTY, a.** [*D. seventig; Sax. seofa, seven, and tig, ten; Goth. tig, Gr. ἑξήκοντα, ten, but the Saxon writers prefixed hund, as hund-seofontig. See Lye ad voc. and Sax. Chron. A. D. 1083.*] Seven times ten.

That he would accomplish *seventy* years in the desolations of Jerusalem; Dan ix.

**SEVENTY, n.** The number which is made up of seven times ten.—2. The Septuagint or seventy translators of the Old Testament into the Greek language.

**SEVER, v. t.** [*Fr. severer; It. severare.*] There may be a doubt whether *sever* is derived from the Latin *separo*. The French has both *severer*, as well as *séparer*; and the Italian, *severare, sceverare* and *severare*, as well as *separare*. The *It. severare* coincides well in orthography with Eng. *shiver*, and this with Heb. שבר, *shabar*, Ch. Syr. and Ar. שבר, *shebar*, to break. The latter are the same word with different prefixes.] 1. To part or divide by violence; to separate by cutting or rending; as, to *sever* the body or the arm at a single stroke.—2. To part from the rest by violence; as, to *sever* the head from the body.—3. To separate; to disjoin, as distinct things, but united; as, the dearest friends *severed* by cruel necessity.—4. To separate and put in different orders or places.

The angels shall come forth and *sever* the wicked from among the just; Matt. xiii. 5. To disjoin; to disunite; in a general sense, but usually implying violence.—6. To keep distinct or apart; Exod. viii.—7. In law, to disunite; to disconnect; to part possession; as, to *sever* an estate in joint-tenancy.

**SEVER, v. i.** To make a separation or distinction; to distinguish.

The Lord will *sever* between the cattle of Israel and the cattle of Egypt; Exod. ix. 2. To suffer disjunction; to be parted or rent asunder.

**SEVERAL, a.** [*from sever.*] Separate; distinct; not common to two or more; as, a *several* fishery; a *several* estate. A *several* fishery is one held by the owner of the soil, or by title derived from the owner. A *several*

estate is one held by a tenant in his own right, or a distinct estate unconnected with any other person.—2. Separate; different; distinct.

Divers sorts of drunks came from several parts to drink. Bacon.

Four several armies to the field are led. Dryden.

3. Divers; consisting of a number; more than two, but not very many. Several persons were present when the event took place.—4. Separate; single; particular.

Each several ship a victory did gain. Dryden.

5. Distinct; appropriate. Each might his several province well command.

Would all but stoop to what they understand. Pope.

A joint or several note or bond, is one executed by two or more persons, each of whom is bound to pay the whole, in case the others prove to be insolvent.

SEVERAL, *n.* Each particular, or a small number, singly taken.

Several of them neither rose from any conspicuous family, nor left any behind them. Addison.

There was not time enough to hear The severals. Shak.

[This latter use, in the plural, is now infrequent or obsolete.]—2. An inclosed or separate place; inclosed ground; as, they had their several for the heathen, their several for their own people; put a beast into a several. [These applications are nearly or wholly obsolete.]—In several, in a state of separation or partition.

Where pastures in several be. [Lit. used.] Tusser.

SEVERAL'ITY, *† n.* Each particular singly taken; distinction.

SEVERALIZE, *† v. t.* To distinguish.

SEVERALLY, *adv.* Separately; distinctly; apart from others. Call the men severally by name.

I could not keep my eye steady on them severally so as to number them. Newton.

To be jointly and severally bound in a contract, is for each obligor to be liable to pay the whole demand, in case the other or others are not able.

SEVERALTY, *n.* A state of separation from the rest, or from all others. An estate in severalty, is that which the tenant holds in his own right, without being joined in interest with any other person. It is distinguished from jointtenancy, coparcenery, and common.

SEVERANCE, *n.* Separation; the act of dividing or disuniting. The severance of a jointure is made by destroying the unity of interest. Thus when there are two joint-tenants for life, and the inheritance is purchased by or descends upon either, it is a severance. So also when two persons are joined in a writ, and one is nonsuited; in this case severance is permitted, and the other plaintiff may proceed in the suit. So also in assize, when two or more disseizes appear upon the writ, and not the other, severance is permitted.

SEVERE, *a.* [Fr. from *L. severus*; It. and Sp. *severo*.] 1. Rigid; harsh; not mild or indulgent; as, severe words; severe treatment; severe wrath.—2. Sharp; hard; rigorous.

Let your zeal... be more severe against thyself than against others. Taylor.

3. Very strict; or sometimes perhaps, unreasonably strict or exact; giving no indulgence to faults or errors; as, se-

vere government; severe criticism.—4. Rigorous, perhaps cruel; as, severe punishment; severe justice.—5. Grave; sober; sedate to an extreme; opposed to cheerful, gay, light, lively.

Your looks must alter, as your subject does, From kind to fierce, from wanton to severe. Waller.

6. Rigidly exact; strictly methodical; not lax or airy. I will not venture on so nice a subject with my severe style.—7. Sharp; afflictive; distressing; violent; as, severe pain, anguish, torture, &c.—8. Sharp; biting; extreme; as, severe cold.—9. Close; concise; not luxuriant.

The Latin, a most severe and copious language. Dryden.

10. Exact; critical; nice; as, a severe test. SEVERED, *pp.* Parted by violence; disjointed.

SEVERELY, *adv.* Harshly; sharply; as, to chide one severely.—2. Strictly; rigorously; as, to judge one severely.

To be or fondly or severely kind. Savage.

3. With extreme rigour; as, to punish severely.—4. Painfully; afflictively; greatly; as, to be severely afflicted with the gout.—5. Fiercely; ferociously.

More formidable Hydra stands within, Whose jaws with iron teeth severely grin. Dryden.

SEVERING, *ppr.* Parting by violence; disuniting.

SEVERITE, *n.* A mineral found near St. Sever, in France, occurring in small masses, white without lustre, a little harder than lithomarge. It is composed of silica, alumina, and water.

SEVERITY, *n.* [L. *severitas*.] 1. Harshness; rigour; austerity; want of mildness or indulgence; as, the severity of a reprimand or reproof.—2. Rigour; extreme strictness; as, severity of discipline or government.—3. Excessive rigour; extreme degree or amount.

Severity of penalties or punishments often defeats the object by exciting pity.—4. Extremity; quality or power of distressing; as, the severity of pain or anguish.—5. Extreme degree; as, the severity of cold or heat.—6. Extreme coldness or inclemency; as, the severity of the winter.—7. Harshness; cruel treatment; sharpness of punishment; as, severity practised on prisoners of war.—8. Exactness; rigour; niceness; as, the severity of a test.—9. Strictness; rigid accuracy.

Confining myself to the severity of truth. Dryden.

SEVERY, } *n.* In arch., a compart-  
SEB'EREE, } ment in a vaulted roof.

SIB'ARY, } Also, a compartment or  
division of scaffolding.

SEVOCA'TION, *n.* [L. *sevooco*.] A calling aside.

SEVRU'GA, *n.* A fish, the *Acipenser stellatus* of the Caspian sea.

SEW, *†* to follow. [See SUE.]

SEW, *v. t.* (so.) [Sax. *siwian*, *suwian*; Goth. *siuyan*; Sw. *sy*; Dan. *syer*; L. *suo*. This is probably a contracted word, and if its elements are *Sb* or *Sf*, it coincides with the Eth. *shafai*, to sew; and the Ar. has *ashafai*, an awl. The Hindoo has *siwawa*, and the Gipsy *siwena*. But the elements are not obvious.] To unite or fasten together with a needle and thread.

They sewed fig leaves together, and made themselves aprons; Gen. iii.

To sew up, to inclose by sewing; to inclose in any thing sewed.

Thou sewest up mine iniquity; Job xiv. Sew me up the skirts of the gown. Shak.

SEW, *v. i.* To practise sewing; to join things with stitches.

SEW, *† v. t.* [L. *sicco*, to dry.] To drain a pond for taking the fish.

SEW'EL, *pp.* United by stitches. In *marine lan.*, a term applied to the situation of a ship which rests upon the ground; and while the depth of water around her is not sufficient to float her, she is said to be sewed by as much as is the difference between the surface of the water and the ship's floating-mark or water-line.

SEW'EL, *n.* Among *huntsmen*, something hung up to prevent deer from entering a place.

SEW'ER, *n.* (shore.) [Fr. *suivre*, to follow; *issir*, to issue, to go or depart out, to flow forth.] A subterranean channel or canal, formed in cities, towns, and other places, to carry off superfluous water, soil, and other matters. [The word is sometimes pronounced *soer*, and *soor*.]

SEW'ER, *† n.* [D. *schaffer*, from *schaffen*, to provide, to dish up; G. *schaffner*. See SNAPE.] An officer who serves up a feast and arranges the dishes.

SEW'ER, *n.* One who sews, or uses the needle.

SEW'ERAGE, } *n.* The system of sewers  
SEW'AGE, } or subterranean con-  
duits for receiving and carrying off the superfluous water and filth of a city; as, the sewage of the city of London. [See SEWER.]—2. The matter carried off by sewers.

SEW'ING, *ppr.* Joining with the needle or with stitches.

SEW'ING, *n.* The act or occupation of sewing or using the needle; that which is sewed by the needle.

SEW'ITUDE, *n.* A term from the civil law, equivalent to easement.

SEW'STER, *† n.* A woman that sews or spins.

SEX, *n.* [Fr. *sexe*; L. *sexus*; qu. G. *siche*, she, female; from L. *seco*, to divide.] 1. The distinction between male and female; or that property or character by which an animal is male or female. The male sex is usually characterized by muscular strength, boldness, and firmness. The female sex is characterized by softness, sensibility, and modesty. In bot., the structure of plants which corresponds to sex in animals. The Linnæan method of botany is formed on the sexes in plants. [See SEXUAL.]—2. By way of emphasis, womankind; females.

Unhappy *sezi* whose beauty is your snare. Dryden.

The sex, whose presence civilizes ours. Cowper.

SEXAGENA'RIAN, *n.* [infra.] A person who has arrived at the age of sixty years.

SEX'AGENARY, *a.* [Fr. *sexagénaire*; L. *sexagenarius*, from *sex*, six, and a word signifying ten, seen in *viginti*; *bigenti*.] Designating the number sixty; as, a noun, a person sixty years of age; also, something composed of sixty.—*Sexagenary arithmetic*, that which proceeds according to the number 60, as the common arithmetic does by the number 10. [See SEXAGESIMAL.]

SEXAGES'IMA, *n.* [L. *sexagesimus*, sixtieth.] The second Sunday before Lent, the next to Shrove-Sunday, so called as being about the 60th day before Easter.

SEXAGESIMAL, *a.* Sixtieth; pertaining to the number sixty.—*Sexagesimal* or *sexagenary arithmetic* is a method

of computation by sixties, as that which is used in dividing minutes into seconds.—*Sexagesimals*, or *sexagesimal fractions*, are those whose denominators proceed in the ratio of sixty; as,  $\frac{1}{60}$ ,  $\frac{1}{3600}$ ,  $\frac{1}{216000}$ . The denominator is sixty, or its multiple. These fractions are called also astronomical fractions, because formerly there were no others used in astronomical calculations. They are still retained in the division of the circle, and of time, where the degree or hour is divided into 60 minutes, the minute into 60 seconds, and so on.

**SEX'ANGLE**, *n.* In *geom.*, a figure having six angles, and, consequently, six sides.

**SEXAN'GLED**, } *a.* [L. *sex*, six, and  
**SEXAN'GULAR**, } *anyulus*, angle.]

Having six angles; hexagonal.

**SEXAN'GULARLY**, *adv.* With six angles; hexagonally.

**SEXDEC'IMAL**, *a.* [L. *sex*, six, and *decem*, ten.] In *crystallography*, when a prism or the middle part of a crystal has six faces and two summits, and taken together, ten faces, or the reverse.

**SEXDUODEC'IMAL**, } *a.* [L. *sex*, six, and  
**sexduodecim**, twelve.] In *crystallography*, designating a crystal when the prism or middle part has six faces and two summits, having together twelve faces.

**SEXEN'NIAL**, *a.* [L. *sex*, six, and *annus*, year.] Lasting six years, or happening once in six years.

**SEXEN'NIALY**, *adv.* Once in six years.

**SEX'FID**, *a.* [L. *sex*, six, and *findo*, to divide.] In *bot.*, six-cleft; as, a *sexfid* calyx or nectary.

**SEX'FOIL**, *n.* [L. *sex*, six, and *folium*, a leaf.] A plant or flower with six leaves.

**SEXIL'ION**, for *Sextillion*. [See **SEXTILLION**.]

**SEX'LESS**, *a.* Having no sex.

**SEXLOC'ULAR**, *a.* [L. *sex*, six, and *loculus*, a cell.] In *bot.*, six-celled; having six cells for seeds; as, a *sexlocular* pericarp.

**SEX'TAIN**, *n.* [L. *sextans*, a sixth, from *sex*, six.] A stanza of six lines.

**SEX'TANT**, *n.* [L. *sextans*, a sixth. The Romans divided the *as* into 12 ounces; a sixth, or two ounces, was the *sextans*.] 1. In *math.*, the sixth part of a circle. Hence,—2. An instrument formed like a quadrant, excepting that its limb comprehends only 60 degrees, or the sixth part of a circle.

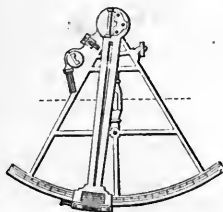

Sextant.

It is used for measuring the angular distances of objects by reflection. It is capable of very general application, but it is chiefly employed as a nautical instrument for measuring the altitudes of celestial objects, and their apparent angular distances. It is an instrument of the utmost importance in navigation.

The principle of the sextant, and of reflecting instruments in general, depends upon an elementary theorem in catoptrics; viz., if an object be seen by reflection from two mirrors which are perpendicular to the same plane, the angular distance of the object from its image is double the inclination of the mirrors. The angle of inclination of the two mirrors, in the case of the sextant, is measured by means of a graduated arch or limb, and an index. The double of this angle gives the apparent altitude of the observed object. The sextant used at sea generally goes by the name of Hadley's sextant, or quadrant.—3. In *astron.*, a constellation situated across the equator and south of the ecliptic.

**SEX'TARY**, *n.* [L. *sextarius*.] An ancient measure containing about a pint and a half.

**SEX'TARY**, } *n.* The same as *Sacris-*  
**SEX'TRY**, } *tan*.

**SEX'TILE**, *n.* [L. *sextilis*, from *sex*, six.] Denoting the aspect or position of two planets, when distant from each other 60 degrees or two signs. This position is marked thus \*.

**SEXTIL'ION**, *n.* [from L. *sex*, six, and *million*.] The sixth power of a million according to the English notation, but the third power of a million according to the French notation.

**SEX'TON**, *n.* [contracted from *sacristan*,—which see.] An under officer of the church, whose business, in ancient times, was to take care of the vessels, vestments, &c. belonging to the church. The greater simplicity of protestant ceremonies has rendered this duty one of small importance, and in the *church of England* it is now usually performed by the parish clerk; so that the sexton has sunk into an officer whose business it is to see to the preparation of graves, and to assist in depositing the corpses.

To him also belongs the care of sweeping the church, and other similar menial offices.

**SEX'TONSHIP**, *n.* The office of a sexton.

**SEX'TUPLE**, *a.* [Low L. *sextuplus*; *sex*, six, and *duplus*, double.] 1. Sixfold; six times as much.—2. In *music*, denoting a mixed sort of triple, beaten in double time, or a measure of two times composed of six equal notes, three for each time.

**SEX'UAL**, *a.* [from *sex*.] Pertaining to sex or the sexes; distinguishing the sex; denoting what is peculiar to the distinction and office of male and female; as, *sexual* characteristics; *sexual* intercourse, connection, or commerce.—2. *Sexual method*, in *bot.*, the method which is founded on the distinction of sexes in plants, as male and female, each sex being furnished with appropriate organs or parts; the male producing a pollen or dust which fecundates the stigma of the pistil or female organ, and is necessary to render it prolific. It is found that most plants are hermaphrodite, the male and female organs being contained in the same flower. This doctrine was taught, to a certain extent, by Theophrastus, Dioscorides, and Pliny among the ancients, but has been more fully illustrated by Cæsalpinus, Grew, Camerarius, Linnæus, and many others among the moderns.

**SEX'UALIST**, *n.* One who believes and maintains the doctrine of sexes in plants; or one who classifies plants by

the differences of the sexes and parts of fructification.

**SEXUAL'ITY**, *n.* The state of being distinguished by sex.

**SEX'UALLY**, *adv.* In a sexual manner.

**SFORZA'TO**. [It. forced.] In *music*, a term written over a note to signify that it is to be played or struck louder than the rest.

**SFUMA'TO**. [It. smoky.] In *painting*, a term applied to that style of painting wherein the tints are so blended that the outline is scarcely perceptible, the whole presenting an indistinct misty appearance.

**SGRAFFI'TO**. [It. scratched.] A species of painting in which the ground is prepared with dark stucco, on which a white coat is applied; which last being removed, the chipping it away opens the black ground, and forms the shadows, giving it the appearance of a chiaro-scuro painting.

**SHAB**, } *v. i.* To play mean tricks.

**SHAB**, *n.* A disease incident to sheep; a kind of itch which makes the wool fall off.

**SHABBED**, } *a.* Mean; shabby.

**SHAB'BILY**, *adv.* [from *shabby*.] Raggedly; with rent or ragged clothes; as, to be clothed *shabbily*.—2. Meanly; in a despicable manner.

**SHAB'BINESS**, *n.* Raggedness; as, the *shabbiness* of a garment.—2. Meanness; paltriness.

**SHAB'BY**, *a.* [D. *schabbig*; G. *schübig*, from *schaben*, to rub, to shave, to scratch; *schabe*, a moth, a shaving tool, a *scab*. This is a different orthography of *Scabby*.] 1. Ragged; torn or worn to rags; as, a *shabby* coat; *shabby* clothes.—2. Clothed with ragged garments.

The dean was so *shabby*. *Swift*.  
3. Mean; paltry; despicable; as, a *shabby* fellow; *shabby* treatment. [For the idea expressed by *shabby*, there is not a better word in the language.]

**SHAB'RACK**, *n.* The cloth furniture of a cavalry officer's charger; a term of Hungarian origin.

**SHABUN'DER**, *n.* In the *East Indies*, a master attendant, or harbour-master; generally the king's agent and merchant.

**SHACK**, *n.* In *ancient customs of England*, a liberty of winter pasturage. In Norfolk and Suffolk, the lord of a manor has *shack*, that is, liberty of feeding his sheep at pleasure on his tenants' lands during the six winter months. In Norfolk, *shack* extends to the common for hogs, in all men's grounds, from harvest to seed-time; whence to go *a-shack*, is to feed at large.—2. In *New England*, beech, oak, &c., mast for swine's food.—3. A shiftless fellow; a sturdy beggar; a vagabond. [*American*.]

**SHACK**, *v. i.* To shed, as corn at harvest. [*Local*.]—2. To feed in stubble, or upon the waste corn of the field. [*Local*.]

**SHACK'LE**, *n.* Stubble. [In Scotch, *shag* is the refuse of barley, or that which is not well filled, and is given to horses. The word *shack* then is probably from a root which signifies to break, to reject, or to waste, or it may be allied to *shag* and *shake*.]

**SHACK'LE**, *v. t.* [Sax. *scacul*; D. *schakel*, a link or mesh; Sax. *scac-line*, a rope to fasten the foot of a sail. Qu. the root  $\text{ṣḥ}$ , *shuk*. But we find the word perhaps in the Ar. *shahal*, from *shakala*, to tie the feet of a beast or bird.] 1. To chain; to fetter; to tie

or confine the limbs so as to prevent free motion.

So the stretched cord the *shackled* dancer tries,

As prone to fall as impotent to rise. *Smith*.  
2. To bind or confine so as to obstruct or embarrass action.

You must not *shackle* him with rules about indifferent matters *Locke*.

SHACK'LE, } *n.* [generally used in SHACK'LES, } the plural.] Fetters, gyves, handcuffs, cords, or something else that confines the limbs so as to restrain the use of them, or prevent free motion.—2. That which obstructs or embarrasses free action.

His very will seems to be in bonds and *shackles*. *South*.

3. Among *seamen*, *shackles* is the name given to the rings by which the ports are secured by hooking the port-bars to them. Also, a sort of iron rings to hook tackles to.

SHACK'LE-BONE, *n.* The wrist. [*Scotch*.]

SHACK'LED, *pp.* Tied; confined; embarrassed.

SHACK'LING, *ppr.* Fettering; binding; confining.

SHAD, *n.* It has no plural termination. *Shad* is singular or plural. [*G. schade*. In *W. ysgadan*, *Ir. sgadam*, is a hering.] A fish, a species of *Clupea*, the *C. alosa*, Linn., which inhabits the sea near the mouths of large rivers, and in the spring ascends them to deposit its spawn. It attains a length of three feet, and is distinguished by the absence of sensible teeth, and by an irregular spot behind the gills. Two species of shad are found off the British coast; the *Twait* and the *Allice shad*, Yarrel; but their flesh is dry and not much esteemed here. In the *U. States*, the shad is much esteemed and is consumed in great quantities in the fresh state. This fish is plentiful in the Hudson, Delaware, and Chesapeake.

SHAD'DOCK, *n.* [The name of the man who first carried this fruit from the East to the West Indies.] A large species of orange, the produce of the *Citrus decumana*. It is a native of



Shaddock Tree (*Citrus decumana*).

China and Japan, and was brought to the West Indies by a Captain Shaddock, hence the name. The pulp is white, of a sweet taste mingled with acidity.

SHADE, *n.* [*Sax. scad, scead, sced*, shade; *scendan*, to separate, divide, or shade;

*G. Schatten*, shadow, and to shade; *D. schaduw, schaduwen*; *Dan. shatterer*, to shade a picture; *W. ysgawd*, a shade; *ysgodi*, to shade or shelter; *cysgodi*, id.; *Corn. shod* or *shez*; *Ir. sgath*, and *sgatham*, to cut off, to shade. The *Gr. σκία* is probably the same word contracted, and perhaps *σκιος*, darkness. In the sense of cutting off or separating, this word coincides exactly, as it does in elements, with the *G. scheiden*, *L. scindo*, for *scido*, which is formed on *caedo*, to strike off. Hence *Sax. gescead*, distinction, *L. scutum*, a shield, *Sp. escudo*; that which cuts off or intercepts. Owen deduces the Welsh word from *cawl*, something that incloses; but probably the sense is that which cuts off or defends.] 1. Literally, the interception, cutting off, or interruption of the rays of light; hence, the obscurity which is caused by such interception. *Shade* differs from *shadow*, as it implies no particular form or definite limit; whereas a *shadow* represents in form the object which intercepts the light. Hence, when we say, let us resort to the *shade* of a tree, we have no reference to its form; but when we speak of measuring a pyramid or other object by its *shadow*, we have reference to its extent.—2. Darkness; obscurity; as, the *shades* of night. The *shade* of the earth constitutes the darkness of night.—3. An obscure place, properly in a grove or close wood, which precludes the sun's rays; and hence, a secluded retreat.

Let us seek out some desolate *shade*, and there

Weep our sad bosoms empty. *Shak.*

4. A screen; something that intercepts light or heat.—5. Protection; shelter. [*See SHADOW*.]—6. In *painting*, the dark part of a picture.—7. Degree or gradation of light.

White, red, yellow, blue, with their several degrees or *shades* and mixtures, as green, come only in by the eyes. *Locke*.

8. In *com.*, a small degree; as, coffee is a *shade* lower.—9. A shadow. [*See SHADOW*.]

Envy will merit, as its *shade*, pursue. *Pope*. [This is allowable in poetry.]—10. The soul, after its separation from the body; so called because the ancients supposed it to be perceptible to the sight, not to the touch; a spirit; a ghost; as, the *shades* of departed heroes.

Swift as thought the fitting *shade*. *Dryden*.  
SHADE, *v. t.* [*Sax. sceadan, gesceadan*, to separate, to divide, to shade.] 1. To shelter or screen from light by intercepting its rays; and when applied to the rays of the sun, it signifies to shelter from light and heat; as, a large tree *shades* the plants under its branches; *shaded* vegetables rarely come to perfection.

I went to crop the sylvan scenes,  
And *shade* our altars with their leafy greens. *Dryden*.

2. To overspread with darkness or obscurity; to obscure.

Thou *shad'st*  
The full blaze of thy beams. *Milton*.

3. To shelter; to hide.  
Ere in our own house I do *shade* my head. *Shak.*

4. To cover from injury; to protect; to screen.—5. To paint in obscure colours; to darken.—6. To mark with gradations of colour; as, the *shading* pencil.—7. To darken; to obscure.

SHADED, *pp.* Defended from the rays of the sun; darkened.

SHADER, *n.* He or that which shades. SHADES, *n. plur.* The lower region or place of the dead. Hence,—2. Deep obscurity; total darkness.

SHAD'ILY, *adv.* Umbrageously. SHADINESS, *n.* [from *shady*.] The state of being shady; umbrageousness; as, the *shadiness* of the forest. SHADING, *ppr.* Sheltering from the sun's rays.

SHADING, *n.* The act or process of making a shade.

SHAD'OW, *n.* [*Sax. scadu, sceadu*. *See SHADE*.] 1. Shade within defined limits; obscurity or deprivation of light, apparent on a plane and representing the form of the body which intercepts the rays of light; as, the *shadow* of a man, of a tree or a tower. The *shadow* of the earth in an eclipse of the moon is proof of its sphericity. Shadow in *optics*, may be defined a portion of space from which light is intercepted by an opaque body. Every opaque object on which light falls is accompanied with a shadow on the side opposite to the luminous body, and the shadow appears more intense in proportion as the illumination is stronger. An opaque object illuminated by the sun, or any other source of light which is not a single point, must have an infinite number of shadows though not distinguishable from each other, and hence the shadow of an opaque body received on a plane is always accompanied by a *penumbra*, or partial shadow. In certain states of the atmosphere, the shadows of opaque objects projected on a white wall are frequently observed, about the time of sunset or sunrise, to be of a blue colour. — 2. Darkness; shade; obscurity.

Night's sable *shadows* from the ocean rise. *Denham*.

3. Shelter made by any thing that intercepts the light, heat, or influence of the air.

In secret *shadow* from the sunny ray  
On a sweet bed of lilies softly laid. *Spenser*.

4. Obscure place; secluded retreat.

To secrete *shadows* I retire.† *Dryden*.

5†. Dark part of a picture.—6.† A spirit; a ghost. [In this sense, *shade* is now used.]—7. In *painting*, the representation of a real shadow, or of the form which a solid object projects on a surface or surfaces, by being interposed between the surface or surfaces and the sun or other luminous body. The doctrines relating to the projection of shadows have received the name of *sciagraphy*. *Shade* is a term applied to that part of the object which is not obvious to the luminous body.—8. An imperfect and faint representation; opposed to *substance*.

The law having a *shadow* of good things to come; Heb. x.

9. Inseparable companion.  
Sin and her *shadow*, death. *Milton*.

10. Type; mystical representation.  
Types and *shadows* of that destin'd seed. *Milton*.

11. Protection; shelter; favour; Lam. iv.; Ps. xci.—12. Slight or faint appearance; James i.—*Shadow of death*, terrible darkness, trouble, or death; Job iii.

SHAD'OW, *v. t.* To overspread with obscurity.

The warlike elf much wonder'd at this tree  
So fair and great, that *shadow'd* all the ground. *Spenser*.

[*Shade* is more generally used.] 2. To cloud; to darken.

The *shadow'd* livery of the burning sun.  
*Shak.*

3. To make cool; to refresh by shade; or to shade.

Flowery fields and *shadow'd* waters.  
*Sidney.*

4. To conceal; to hide; to screen.

Let every soldier hew him down a bough,  
And bear't before him; thereby shall we  
*shadow*

The number of our host. [Unusual.]

*Shak.*

5. To protect; to screen from danger; to shroud.

*Shadowing* their right under your wings  
of war.  
*Shak.*

6. To mark with slight gradations of colour or light.—[In this sense, *shade* is chiefly used.]—7. To paint in obscure colours; as, void spaces deeply *shadowed*.—8. To represent faintly or imperfectly.

Augustus is *shadowed* in the person of  
Æneas.  
*Dryden.*

9. To represent typically. The healing power of the brazen serpent *shadoweth* the efficacy of Christ's righteousness. In this sense the word is frequently followed by *forth*; as, to *shadow forth* the gospel dispensation. [The two last senses are in use. In place of the others, *shade* is now more generally used.]

SHAD'OW-CASTING, *a.* Casting a shadow.

SHAD'OWED, *pp.* Represented imperfectly or typically.

SHAD'OW-GRASS, *n.* A kind of grass so called.

SHAD'OWINESS, *n.* The state of being shadowy.

SHAD'OWINESS, *n.* State of being shadowy or unsubstantial.

SHAD'OWING, *ppr.* Representing by faint or imperfect resemblance; typifying.

SHAD'OWING, *n.* Shade or gradation of light and colour. [This should be *shading*.] 2. A typifying.—3. In *drawing*, the art of correctly casting the shadows of objects, and representing their degrees of shade.

SHAD'OWLESS, *a.* Having no shadow.

SHAD'OWY, *a.* [Sax. *sceadowig*.] 1. Full of shade; dark; gloomy.

This *shadowy* desert, unfrequented woods.  
*Shak.*

2. Not brightly luminous; faintly light.

More pleasant light,  
*Shadowy* sets off the face of things.  
*Milton.*

3. Faintly representative; typical; as, *shadowy* expiations.—4. Unsubstantial; unreal.

Milton has brought into his poems two actors of a *shadowy* and fictitious nature, in the persons of Sin and Death.

*Addison.*

5. Dark; obscure; opaque.

By command ere yet dim night  
Her *shadowy* cloud withdraws.  
*Milton.*

SHAD'RACH, *n.* In the *smelting of iron*, a mass of iron in which the operation of smelting has failed of its intended effect. [Local.]

SHAD'Y, *a.* [from *shade*.] Abounding with shade or shades; overspread with shade.

And Amaryllis fills the *shady* groves  
*Dryden.*

2. Sheltered from the glare of light or sultry heat.

Cast it also that you may have rooms  
*shady* for summer and warm for winter.

*Bacon.*

SHAF'FLE, † *v. i.* [See SHUFFLE.] To hobble or limp.

SHAF'FLER, † *n.* A hobbler; one that limps.

SHAFT, *n.* [Sax. *scaft*; D. and G. *schaft*; L. *scapus*; from the root of *shape*, from setting, or shooting, extending.] 1. An arrow; a missile weapon; as, the archer and the *shaft*. So lofty was the pile, a Parthian bow  
With vigour drawn must send the *shaft*  
below.  
*Dryden.*

2. In *mining*, a pit or long narrow opening or entrance into a mine. The direction of the shaft is either vertical or much inclined to the horizon. It is never less than 32 inches in its narrowest diameter, and sometimes amounts to several yards. Its depth may extend to 1000 feet or more. [This may possibly be a different word, as in German it is written *schacht*, Dan. *skæfte*.]—3. In *arch.*, the shaft of a column is the body of it, between the base and the capital. It is also called the *fast*, or *trunk* of the column. It always diminishes in diameter, sometimes from the bottom, sometimes from a quarter, and sometimes from a third of its height, and sometimes it has a slight swelling, called the *entasis*, in the lower part of its height. In the Ionic and Corinthian columns, the difference of the upper and lower diameters of the shaft, varies from a fifth to a twelfth of the lower diameter. [See COLUMN.] *Vaulting shafts*, those which support ribs, or other parts of a vault.—*Shaft of a king-post*, the part between the joggles.—*Shaft of a chimney*, the part which rises above the roof for discharging the smoke into the air.—4. Any thing straight; as, the shaft of a steeple and many other things.—5. The stem or stock of a feather or quill.—6. The pole of a carriage, sometimes called *tongue* or *neap*. The thills of a chaise or gig are also called *shafts*.—7. The handle of a weapon.—8. In *mech.*, axes of considerable dimensions are called shafts, while smaller axes are denominated spindles. Thus *shaft* is applied to the axis of a fly wheel or steam boat paddle, while the axis of a turning lathe is called a *spindle*.

Shafts are made of various forms and materials according to circumstances. The different pieces which make up continuous lines of shafting, for conveying motion to a distance from the prime mover, are connected together by means of pieces called *couplings*.—*Shaft*, or *white-shaft*, a species of Trochilus or humming-bird, having a bill twenty lines in length, and two long white feathers in the middle of its tail.

SHAF'TED, *a.* Having a handle; a term in heraldry, applied to a spear-head.

SHAF'TMENT, † *n.* [Sax. *scaftmund*.] A span, a measure of about six inches.

SHAG, *n.* [Sax. *sceacga*, hair, shag; Dan. *skiæg*; Sw. *shägg*, the beard, a brush, &c. In Eth. *shahy*, a hair cloth.] 1. Coarse hair or nap, or rough woolly hair.

True Witney broadcloth, with its *shag* unshorn.  
*Gay.*

2. A kind of cloth having a long coarse nap.—3. In *zool.*, an aquatic fowl, the green cormorant or crested cormorant;

*Phalacrocorax cristatus*.—4. A kind of tobacco; tobacco leaves shredded for being smoked.

SHAG, *a.* Hairy; shaggy.

SHAG, *v. t.* To make rough or hairy.

*Shag* the green zone that bounds the boreal  
skies.  
*J. Barlow.*

2. To make rough or shaggy; to deform.

SHAG'BARK, *n.* In the *U. States*, a trivial name for *Curia squamosa*, a kind of hickory; some call it *shell-bark*.

SHAG'GED, } *a.* Rough with long hair  
SHAG'GY, } or wool.

About his shoulders hangs the *shaggy* skin.  
*Dryden.*

2. Rough; rugged; as, the *shaggy* tops of hills.

And throw the *shaggy* spoils about your  
shoulders.  
*Addison.*

SHAG'GEDNESS, } *n.* The state of  
SHAG'GINESS, } being shaggy;  
roughness with long loose hair or  
wool.

SHAGREEN, *n.* [Pers. *sagri*, the erup-  
per skin of a mule or an ass, dressed.]  
A species of leather supposed formerly  
to have been prepared from the skin  
of the *shagree*, a species of whale. It  
is prepared from horse or ass skin, its  
granular appearance being given by  
imbedding in it, whilst soft, the seeds of  
a species of chenopodium, and after-  
wards shaving down the surface. It  
is dyed with the green produced by  
the action of sal ammoniac on copper  
filings. It is also made of the skins of  
the sea otter, seal, &c. It was former-  
ly much used for watch, spectacle,  
and instrument cases, and was made  
chiefly in Astracan.

SHAGREEN, } *a.* Made of the lea-  
SHAGREENED, } ther called shag-  
green.

SHAGREEN, for *Chagrin*. [See CHA-  
GRIN.]

SHAH, *n.* The title of *Shah* is given by  
European writers to the monarch of  
Persia, but in his own country he is  
designated by the compound appella-  
tion of *Padishah*.—2. A chieftain.

SHAIK, } *n.* Among the Arabians and  
SCHEIK, } Moors, an old man; and  
hence a chief, a lord, a man of emi-  
nence. [See SHEIK.]

SHAIL, *v. t.* To walk sidewise. [*Low*  
and not in use.] [This word is proba-  
bly the G. *schielen*, Dan. *shieler*, to  
squint.]

SHAKE, *v. t.* pret. *Shook*; pp. *Shaken*.  
[Sax. *sceacan*, to shake, also to flee, to  
depart, to withdraw; D. *schohken*, to  
shake, to jolt, to heap; *schoh*, a shock,  
jolt or bounce; W. *ysgegiaw*, to shake  
by seizing one by the throat; *cegiaw*,  
to choke, from *cég*, a choking, the  
mouth, an entrance. If the Welsh  
gives the true origin of this word, it  
is remarkably expressive, and character-  
istic of rough manners. I am not con-  
fident that the Welsh and Saxon are  
from a common stock.] 1. To cause to  
move with quick vibrations; to move  
rapidly one way and the other; to  
agitate; as, the wind *shakes* a tree; an  
earthquake *shakes* the hills or the  
earth.

I *shook* my lap, and said, So God *shake*  
out every man from his house; Neh. v.

He *shook* the sacred honours of his head.  
*Dryden.*

As a fig-tree casteth her untimely fruit,  
when it is *shaken* by a mighty wind; Rev.  
vi.

2. To make to totter or tremble.

The rapid wheels *shake* heaven's basis.

*Milton.*

3. To cause to shiver; as, an ague *shakes* the whole frame.—4. To throw down by a violent motion.

Macbeth is ripe for *shaking*. *Shak.*

[But see *Shake off*, which is generally used.]—5. To throw away; to drive off.

'Tis our first intent

To *shake* all cares and business from ourage. [See *SHAKE OFF*.] *Shak.*

6. To move from firmness; to weaken the stability of; to endanger; to threaten to overthrow. Nothing should *shake* our belief in the being and perfections of God, and in our own accountability.—7. To cause to waver or doubt; to impair the resolution of; to depress the courage of.

That ye be not soon *shaken* in mind; 2 Thess. ii.

8. To trill; as, to *shake* a note in music.—To *shake hands*, sometimes, to unite with; to agree or contract with; more generally, to take leave of, from the practice of shaking hands at meeting and parting.—To *shake off*, to drive off; to throw off or down by violence; as, to *shake off* the dust of the feet; also, to rid one's self; to free from; to divest of; as, to *shake off* disease or grief; to *shake off* troublesome dependents.

**SHAKE**, *v. i.* To be agitated with a waving or vibratory motion; as, a tree *shakes* with the wind; the house *shakes* in a tempest.

The foundations of the earth do *shake*; Is. xxiv.

2. To tremble; to shiver; to quake; as, a man *shakes* in an ague; or he *shakes* with cold, or with terror.—3. To totter.

Under his burning wheels

The steadfast empyrean *shook* throughout, All but the throne itself of God. *Milton.*

**SHAKE**, *n.* Concussion; a vacillating or wavering motion; a rapid motion one way and the other; agitation.

The great soldier's honour was composed of thicker stuff which could endure a *shake*.

*Herbert.*

2. A trembling or shivering; agitation.—3. A motion of hands clasped.

Our salutations were very hearty on both sides, consisting of many kind *shakes* *Addison.*

4. In music, a trill; a rapid reiteration of two notes comprehending an interval not greater than one whole tone, nor less than a semitone.—5. A fissure or rent in timber occasioned by its being dried too suddenly, or exposed to too great heat. Shakes frequently occur in growing timber from various causes.—6. The season of the year when mast, &c., falls from the trees.

**SHAKE-DOWN**, *n.* A temporary substitute for a bed, as that formed on chairs or on the floor. The term is possibly derived from straw being used to form the rough beds of early times.

**SHAKEN**, *pp.* (sha'kn.) Impelled with a vacillating motion; agitated.—2. a. Cracked or split; as, *shaken* timber.

Nor is the wood *shaken* nor twisted, as those about Cape-town. *Barrow.*

**SHAKER**, *n.* A person or thing that shakes or agitates; as, the *shaker* of the earth.—2. A variety of pigeon.

**SHAK'ERS**, *n.* In the *U. States*, a fanat-

ical sect, which originated in Manchester, about 1747, with one Ann Lee, a blacksmith's daughter. This person, who seems to have been a hypochondriacal religionist, emigrated to America with a few proselytes in 1774, and formed a settlement at Niskayuna, a few miles from Albany, in the state of New York. The *shakers*, who were at first called *shaking quakers*, from similarity of garb, take the name of the "millennial church." Their doctrines are a strange mixture of crude errors, intermixed with some gospel truths. Their devotional exercises are accompanied with dancing, or rather jumping, and singing. The members, male and female, lead a life of celibacy, and all the goods of the community, which is or has been a thriving one, are held and enjoyed in common. There are about fifteen shaker settlements, or villages, in the *U. States*, the chief of which is "New Lebanon," fourteen miles S.E. from Albany, in the state of New York.

**SHAKING**, *ppr.* Impelling to a wavering motion; causing to vacillate or waver; agitating.—2. Trembling; shivering; quaking.—*Shaking quags*, or *Shaking bogs*, a name given to wet spongy soil, that shakes or trembles when trodden upon.

**SHAKING**, *n.* The act of shaking or agitating; brandishing; Job xli.—2. Concussion.—3. A trembling or shivering.

**SHAK'O**, *n.* [Fr. *schako*.] A military cap.

**SHA'KY**, *a.* Cracked, split, or cleft, as timber.—2. Loosely put together; ready to come to pieces. [*Familiar*.]

**SHALE**, *v. t.* To peel. [See *SHELL*.]

**SHALE**, *n.* [G. *schale*; a different orthography of *shell*, but not in use. See *SHELL*.] 1. A shell or husk.—2. In

*nat. hist.*, a species of schist or schistons clay; slate clay; generally of a bluish or yellowish gray colour, more rarely of a dark blackish or reddish gray, or grayish black, or greenish colour. Its fracture is slaty, and in water it moulders into powder. It is often found in strata in coal mines, and commonly bears vegetable impressions. It is generally the forerunner of coal. Bituminous shale is a subvariety of argillaceous slate, is impregnated with bitumen, and burns with flame. There are sandy, calcareous, purely argillaceous and carbonaceous shales.

**SHALL**, *v. i.* verb auxiliary. pret. *Should* [Sax. *scealan*, *scylan*, to be obliged. It coincides in signification nearly with *ought*, it is a duty, it is necessary; D. *zal*, *zul*; G. *soll*; Sw. *shola*, pret. *skulle*; Dan. *shal*, *skulle*, *skulde*. The German and Dutch have lost the palatal letter of the verb; but it appears in the derivative G. *schuld*, guilt, fault, culpability, debt; Sax. *scyld*, debt, offence, L. *scelus*. The literal sense is to hold or be held, hence to owe, and hence the sense of guilt, a being held bound or liable to justice and punishment. In the Teutonic dialects, *schuld*, *shyld*, are used in the Lord's prayer, as, "forgive us our debts," but neither *debt* nor *trespass* expresses the exact idea, which includes sin or crime, and liability to punishment. The word seems to be allied in origin to *skill*, L. *calleo*, to be able, to know. See *SKILL*. *Shall* is defective, having no infinitive, imperative, or participle. It ought to be written *shal*, as the original has one

l only, and it has one only in *shalt* and *should*.] 1. *Shall* is primarily in the present tense, and in our mother tongue was followed by a verb in the infinitive, like other verbs. "*Ice sceal fram the beon gefullod*," I have need to be baptized of thee; Matt. iii. "*Ice nu sceal singan sarcwidas*;" I must now sing mournful songs. We still use *shall* and *should* before another verb in the infinitive, without the sign to; but the signification of *shall* is considerably deflected from its primitive sense. It is now treated as a mere auxiliary to other verbs, serving to form some of the tenses. In the present tense, *shall*, before a verb in the infinitive, forms the future tense; but its force and effect are different with the different persons or personal pronouns. Thus in the first person, *shall* simply foretells or declares what will take place; as, I or we *shall* ride to town on Monday. This declaration simply informs another of a fact that is to take place. The sense of *shall* here is changed from an expression of need or duty, to that of previous statement or information, grounded on intention or resolution. When uttered with emphasis, "I *shall* go," it expresses firm determination, but not a promise.—2. In the second and third persons, *shall* implies a promise, command, or determination. "You *shall* receive your wages," "he *shall* receive his wages," imply that you or he *ought* to receive them; but usage gives to these phrases the force of a *promise* in the person uttering them. When *shall* is uttered with emphasis in such phrases, it expresses determination in the speaker, and implies an authority to enforce the act. "Do you refuse to go? Does he refuse to go? But you or he *shall* go."—3. *Shall I go, shall he go*, interrogatively, asks for permission or direction. But *shall you go*, asks for information of another's intention.—4. But after another verb, *shall*, in the third person simply foretells. He says that he *shall* leave town to-morrow. So also in the second person; you say that you *shall* ride to-morrow.—5. After *if*, and some verbs which express condition or supposition, *shall*, in all the persons, simply foretells; as,

If I *shall* say, or we *shall* say,  
If Thou *shalt* say, ye or you *shall* say,  
He *shall* say, they *shall* say.

6. *Should*, in the first person, implies a conditional event. "I *should* have written a letter yesterday, had I not been interrupted." Or it expresses obligation, and that in all the persons.

I *should*,  
Thou *shouldst*,  
He *should*,  
You *should*,  
that have paid the bill on demand; it was my duty, your duty, his duty to pay the bill on demand, but it was not paid.

7. *Should*, though properly the past tense of *shall*, is often used to express a contingent future event; as, if it *should* rain to-morrow; if you *should* go to London next week; if he *should* arrive within a month. In like manner after *though*, *grant*, *admit*, *allow*.

**SHALLOON**, *n.* [said to be from *Chalons*, in France; Sp. *chaleon*; Fr. *ras de Chalons*.] A slight woollen stuff.

**SHALLOP**, *n.* [Fr. *chaloupe*; G. *scha-luppe*. This word is changed into *sloop*; but the two words have now different significations.] 1. A sort of large boat with two masts, and usually rigged like

a schooner.—2. A small light vessel with a small main-mast and fore-mast, with lug-sails.

**SHALLOT**, or **ESCHALOT**, *n.* A plant, the *Allium ascalonicum*, a species of onion, the mildest cultivated. It grows wild in many parts of Syria, especially near Ascalon, whence it derives its specific name. It is soboliferous, and propagated by the clove, and is sufficiently hardy to endure the severest winters of England. The shallot is used to season soups and made dishes, and makes a good addition in sauces, salads, and pickles.

**SHALLOW**, *a.* [from *shoal*, Sax. *scœol*, a crowd, or rather *scylf*, a shelf.] 1. Not deep; having little depth; shoal; as, shallow water; a shallow stream; a shallow brook.—2. Not deep; not entering far into the earth; as, a shallow furrow; a shallow trench.—3. Not intellectually deep; not profound; not penetrating deeply into abstruse subjects; superficial; empty; silly; as, a shallow mind or understanding; shallow skill.

Deep vers'd in books, and shallow in himself.  
*Milton.*

4. Slight; not deep; as, a shallow sound. **SHALLOW**, *n.* A shoal; a shelf; a flat; a sand-bank; any place where the water is not deep.

A swift stream is not heard in the channel, but upon shallows of gravel. *Bacon.*  
Dash'd on the shallows of the moving sand.  
*Dryden.*

**SHALLOW**, *v. t.* To make shallow. [Little used.]

**SHALLOW-BRAINED**, *a.* Weak in intellect; foolish; empty headed.

**SHALLOWLY**, *adv.* With little depth.—2. Superficially; simply; without depth of thought or judgment; not wisely.

**SHALLOWNESS**, *n.* Want of depth; small depth; as, the shallowness of water, of a river, of a stream.—2. Superficialness of intellect; want of power to enter deeply into subjects; emptiness; silliness.

**SHALLOW-SEARCHING**, *a.* Searching superficially.

**SHALM**, } † *n.* [G. *schalmie*, from SHAWM, } *schallen*, to sound.] A kind of musical pipe.

**SHALOTE**, *n.* The French *echalote* anglicised. [See **ESCHALOT** and **SHALLOT**.]

**SHALSTONE**, *n.* [G. *schale*, a scale, and *stone*, G. *stein*.] A mineral which appears in masses, composed of thin laminae, collected into large prismatic concretions; sometimes in hexahedral prisms or tables. Its natural joints are parallel to the sides of a prism slightly rhombic. It is imperfectly foliated and somewhat shining and pearly. It is called by Hausman, tafelspath; by Phillips, tabular spar. Its localities, Ceylon, United States, and Tennessee. **SHALT**, the second person singular of *shall*; as, thou shalt not steal.

**SHA'LY**, *a.* Partaking of the qualities of shale.

**SHAM**, *n.* [W. *siom*, vacuity, void, balk, disappointment.] That which deceives expectation; any trick, fraud, or device that deludes and disappoints; delusion; imposture. [Not an elegant word.]

Believe who will the solemn sham, not I.  
*Addison.*

**SHAM**, *a.* False; counterfeit; pretended; as, a sham fight.

**SHAM**, *v. t.* [W. *siomi*, to balk or disappoint.] 1. To deceive expectation;

to trick; to cheat; to delude with false pretences.

They find themselves fooled and shammed into conviction. [Not elegant.] *L'Étrange.*

2. To obtrude by fraud or imposition.

**SHAM**, *v. i.* To pretend; to make false pretences.—To sham Abraham, a sailor's term; to pretend illness, in order to avoid doing duty in the ship, &c. **SHAM'AN**, *n.* In Russia, a wizard or conjuror, who by enchantment pretends to cure diseases, ward off misfortunes, and foretell events.

**SHAM'ANISM**, *n.* The idolatrous worship of the Ostiaks, Samoyedes, &c. **SHAM'BLE**, *v. i.* To walk awkwardly and unsteadily, as if the knees were weak.

**SHAM'BLER**, *n.* [Sax. *scamel*, L. *scamnum*, a bench, It. *scanno*, Sp. *escano*; from L. *scando*.] 1. Properly, the tables or stalls where butchers expose meat for sale; a slaughter house; a flesh market; 1 Cor. x.—2. In mining, a niche or shelf left at suitable distances to receive the ore which is thrown from one to another, and thus raised to the top.

**SHAM'BLING**, *a.* [from *scamble*, *scambling*.] Moving with an awkward, irregular, clumsy pace; as, a shambling trot; shambling legs.

**SHAM'BLING**, *n.* An awkward, clumsy, irregular pace or gait.

**SHAME**, *n.* [Sax. *scama*, *sceam*, *sceom*; G. *scham*; Qu. Ar. *chashama*, with a prefix, to cause shame, to blush, to reverence.] 1. A painful sensation excited by a consciousness of guilt, or of having done something which injures reputation; or by the exposure of that which nature or modesty prompts us to conceal. Shame is particularly excited by the disclosure of actions which, in the view of men, are mean and degrading. Hence it is often or always manifested by a downcast look or by blushes, called *confusion of face*.

Hide, for shame,

Romans, your grandsires' images,  
That blush at their degenerate progeny.

*Dryden.*

Shame prevails when reason is defeated.  
*Rambler.*

2. The cause or reason of shame; that which brings reproach, and degrades a person in the estimation of others. Thus an idol is called a *shame*; Hos. ix. Guides, who are the *shame* of religion.  
*South.*

3. Reproach; ignominy; derision; contempt.

Ye have borne the *shame* of the heathen; Ezek. xxxvi.

4. The parts which modesty requires to be covered.—5. Dishonour; disgrace; Prov. ix.

**SHAME**, *v. t.* To make ashamed; to excite a consciousness of guilt or of doing something derogatory to reputation; to cause to blush.

Who shames a scribbler, breaks a cobweb through.  
*Pope.*

I write not these things to shame you; 1 Cor. iv.

2. To disgrace. And with foul cowardice his carcass shames.  
*Spenser.*

3. To mock at. Ye have shamed the counsel of the poor; Ps. xiv.

**SHAME**, *v. i.* To be ashamed.

To its trunk authors give such a magnitude, as I shame to repeat. *Raleigh.* [This verb is no longer used intransitively.]

**SHAMED**, *pp.* Made ashamed.

**SHAMEFACED**, *a.* [Lye supposes this to be a corruption of Sax. *scam-fast*, shame-fast, held or restrained by shame.] Bashful; easily confused or put out of countenance. A man may be *shamefaced* to excess.

Conscience is a blushing *shamefaced* spirit.

*Shnk.*

Your *shamefaced* virtue shunn'd the people's praise.  
*Dryden.*

**SHAMEFACEDLY**, *adv.* Bashfully; with excessive modesty.

**SHAMEFACEDNESS**, *n.* Bashfulness; excess of modesty.

**SHAMEFUL**, *a.* [shame and full.] That brings shame or disgrace; scandalous; disgraceful; injurious to reputation. It expresses less than *infamous* and *ignominious*.

His naval preparations were not more surprising than his quick and *shameful* retreat.  
*Arbutnot.*

2. Indecent; raising shame in others. Phœbus flying so most *shameful* sight.  
*Spenser.*

**SHAMEFULLY**, *adv.* Disgracefully; in a manner to bring reproach. He *shamefully* deserted his friend.—2. With indignity or indecency; in a manner that may cause shame.

How *shamefully* that maid he did torment.  
*Spenser.*

**SHAMEFULNESS**, *n.* Disgracefulness. **SHAMELESS**, *a.* [shame and less.] Destitute of shame; wanting modesty; impudent; brazen-faced; immodest; audacious; insensible to disgrace.

Such *shameless* bards we have. *Pope.*

2. Done without shame; indicating want of shame; as, a *shameless* denial of truth.

**SHAMELESSLY**, *adv.* Without shame; impudently; as, a man *shamelessly* wicked.

**SHAMELESSNESS**, *n.* Destitution of shame; want of sensibility to disgrace or dishonour; impudence.

He that blushes not at his crime, but adds *shamelessness* to shame, has nothing left to restore him to virtue. *Taylor.*

**SHAMER**, *n.* One who makes ashamed; that which confounds.

**SHAM-FIGHT**, *n.* A pretended fight or engagement.

**SHAMING**, *ppr.* Making ashamed; causing to blush; confounding.

**SHAMMER**, *n.* [from *sham*.] One that shams; an impostor. [Low.]

**SHAMMY**, or **SHAM'OY**, *n.* [Fr. *chamois*; from Sp. *gama*, a doe, or its root; W. *gavry*, a goat; Corn. and Ir. *gavar*.] 1. A species of antelope, the *Antilope rupicapra*, a ruminant mammal of the tribe Capridæ, inhabiting the mountains of Savoy, Piedmont, and the Pyrenees. [See **CHAMOIS**.]—2. A kind of leather prepared from the skin of this animal. It is dressed in oil or tanned, and much esteemed for its softness, pliancy, and the quality of bearing soap without damage. A great part of the leather which bears this name is counterfeit, being made of the skin of the common goat, the kid, or even of sheep. It is often improperly written *Shamois*.

**SHAMPOO**, *v. t.* [Oriental?] To press the joints and rub the limbs after the East Indian manner, in order to free from lassitude or pain. It is used in connection with the hot bath. What is now popularly called *tripping*, was anciently called *tripsis*, and it is still so called technically.

SHAMPOO'ED, *pp.* Rubbed, pressed, &c., in connection with the hot bath.

SHAMPOO'ING, *pp.* Rubbing and pressing the limbs and joints, in connection with the hot bath.

SHAMPOO'ING, *n.* A name given to an operation in the East, which consists in pressing the joints and rubbing the limbs, so as to mitigate pain, and restore tone and vigour to the parts. It is performed in the baths.

SHAM'ROCK, *n.* [In the Gaelic *seam-ray*, probably in the Irish and Gaelic languages a generic term for trefoils.] The name commonly given to the national emblem of Ireland, as the rose of England and the thistle of Scotland, It is generally supposed to be the plant called white clover, *Trifolium repens*; but it appears to be rather the wood sorrel, *Oxalis acetosilla*,—*which see.*

SHANG'IE, } *n.* A shackle; a stick.  
SHANG'AN, } cleft at one end for putting the tail of a dog in by way of mischief, or to frighten him away. [*Scotch.*]

SHANK, *n.* [*Sax. scanc, seane; G. and D. schenkel; Sw. shank.*] 1. The whole joint from the knee to the ankle. In a horse, the part of the fore leg between the knee and the fetlock.—2. The tibia or large bone of the leg; as, crooked *shanks*.—3. The long part of an instrument; as, the *shank* of a key. The beam or shaft of an anchor, having the ring at one end and the arms at the other.—4. A plant (*Bryonia*).—5. In *arch.*, another name for the shaft of a column. *Shanks* or *legs*, names given to the plain space between the channels of the triglyph of a Doric frieze.

SHANK'ED, *a.* Having a shank.

SHANK'ER, *n.* [from *Fr. chancre.*] A primary syphilitic ulcer, always occasioned by the application of the specific secretion from another primary syphilitic ulcer. It is always the first manifestation of true and regular syphilis. [This word is now generally written *Chancre.*]

SHANK'LIN SAND, *n.* In *geol.*, another name for lower green sand. It is the lowest member of the cretaceous group. [See under LOWER.]

SHANK-PAINTER, *n.* With *scavens*, a short rope and chain which sustains the shank and flukes of an anchor against the ship's side, as the stopper fastens the ring and stock to the cat-head.

SHAN'SCRIT, *n.* The Sanscrit, or ancient language of Hindoostan. [See SANSKRIT.]

SHAN'TY, for *janty*, gay; showy. [*Not in use or local.*]

SHAN'TY, *n.* [said to be from *Ir. sean*, old, and *tig*, a house.] A hut, or mean dwelling.

SHAPE, *v. t.* pret. *Shaped*; *pp.* *Shaped* or *Shapen*. [*Sax. sceppian, scieppan, scipan, or scyppan*, to form, to create; *G. schaffen*, to create, to make or get, to procure, furnish, or supply; *Sans. shajana*. The *Sw.* has *shaffa*, to provide, and the *Dan.* *shaffer*.] 1. To form or create.

I was *shapen* in iniquity; Ps. li.

2. To mould or make into a particular form; to give form or figure to; as, to *shape* a garment.

Grace *shap'd* her limbs, and beauty deck'd her face. *Prior.*

3. To mould; to cast; to regulate; to adjust; to adapt to a purpose. He *shapes* his plans or designs to the temper of the times.—4. To direct; as, to

*shape* a course.—5. To image; to conceive.

Of my jealousy

*Shapes* faults that are not. *Shak.*

SHAPE, *v. i.* To square; to suit; to be adjusted.

SHAPE, *n.* Form or figure as constituted by lines and angles; as, the *shape* of a horse or a tree; the *shape* of the head, hand, or foot.—2. External appearance.

He beat me grievously in the *shape* of a woman. *Shak.*

3. The form of the trunk of the human body; as, a clumsy *shape*; an elegant *shape*.—4. A being as endowed with form.

Before the gates there sat  
On either side, a formidable *shape*. *Milton.*

5. Idea; pattern.—6. Form. This application comes before the legislature in the *shape* of a memorial.—7. Manner.

SHAPED, } *pp.* Formed; moulded; cast;  
SHAPEN, } conceived.

SHAPELESS, *a.* Destitute of regular form; wanting symmetry of dimensions; as, deformed and *shapeless*.

The *shapeless* rock or hanging precipice.

SHAPELESSNESS, *n.* Destitution of regular form.

SHAPELINESS, *n.* [from *shapely*.] Beauty or proportion of form. [*Little used.*]

SHAPELY, *a.* [from *shape*.] Well formed; having a regular shape; symmetrical.

SHAPESMITH, *n.* [*shape* and *smith*.] One that undertakes to improve the form of the body. [*In burlesque.*]

SHAPING, *pp.* Forming; moulding; casting; conceiving; giving form.

SHAPING, *n.* The act of forming a shape.

SHAPOURNATED. [*Her.*] See CHAPOURNATED.

SHAPOURNET. [*Her.*] See CHAPOURNET.

SHARD, } *n.* [*Sax. sceard*, from *searan*,  
to shear, to separate.] 1. A piece or fragment of an earthen vessel or of any brittle substance.—2. The shell of an egg or of a snail; also the sheath that covers the wing of an insect.—3. A plant (*chard*).—4. A frith or strait; as, a perilous *shard*.—5. A gap.—6. A fish.

SHARD'-BORNE, } *a.* [Which of these  
SHARD'-BORN, } is the right spelling is somewhat uncertain, but not unimportant, as the true sense of the epithet depends upon the choice. Some, says Halliwell, are of opinion, that Shakspeare wrote the word *shard-born*, *i. e.*, born among shards; but neither he nor any of the later lexicographers adopts this opinion.] A beetle borne along the air by its shards, or scales.

The *shard-borne* beetle with his drowsy hums. *Shak.*

SHARD'ED, *a.* Having wings sheathed with a hard case; as, the *sharded* beetle.—2. Inhabiting shards.

SHARE, *n.* [*Sax. sear, sceara*, from *searan*, to shear; *W. ysgar*, which is a compound.] 1. A part; a portion; a quantity; as, a small *share* of prudence or good sense.—2. A part or portion of a thing owned by a number in common; that part of an undivided interest which belongs to each proprietor; as, *shares* in a bank; *shares* in a railway; a ship owned in ten *shares*; a tonnage building owned in a hundred *shares*.—3. The part of a thing allotted or distributed to each individual of a number; dividend; separate portion. Each

heir has received his *share* of the estate.—4. A part belonging to one; portion possessed.

Nor I without my *share* of fame. *Dryden.*

5. A part contributed. He bears his *share* of the burden.—6. The broad iron or blade of a plough which cuts the bottom of the furrow-slice.—*To go shares*, to partake; to be equally concerned.

SHARE, *v. t.* [*Sax. scearan, scyran*; but we have *shear* directly from this verb, and *share* seems to be from the noun; *W. ysgariaw*.] 1. To divide; to part among two or many.

Suppose I *share* my fortune equally between my children and a stranger. *Swift.*  
And *share* his burden where he *shares* his heart. *Dryden.*

2. To partake or enjoy with others; to seize and possess jointly or in common. Great Jove with Cesar *shares* his sov'reign sway. *Milton.*

While avarice and rapine *share* the land. *Id.*

3. † To cut; to shear.

And the *shar'd* visage hangs on equal sides. *Dryden.*

SHARE, *v. i.* To have part or a dividend.

A right of inheritance gave every one a title to *share* in the goods of his father. *Locke.*

SHARE-BONE, *n.* The *os pubis*, the smallest of the three portions of the *os innominatum*, which is placed at the upper and fore part of the pelvis.

SHARED, *pp.* Held or enjoyed with another or others; divided; distributed in shares.

SHAREHOLDER, *n.* [*share* and *holder*.] One that holds or owns a share in a joint stock or property.

SHARE LINE, *n.* The summit line of elevated ground.

SHARER, *n.* A partaker; one that participates anything with another; one who enjoys or suffers in common with another or others; as, a *sharer* in another's good fortune; a *sharer* in the toils of war; a *sharer* in a lady's affections.

SHARING, *pp.* Partaking; having a part with another; enjoying or suffering with others.

SHARING, *n.* Participation.

SHARK, *n.* [*L. carcharias*; *Gr. καρχαρις*, from *καρχαρις*, sharp; *Corn. shar-hias*; *Ger. schurke*, a rascal.] The genus *Squalus*, Linn., or the modern Squalidæ; a family of cartilaginous fishes, allied to the Rays, and celebrated for the size and voracity of many of the species. The form of the body is elongated and the tail thick and fleshy.

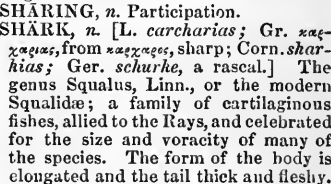

White Shark (*Carcharias vulgaris*).

The mouth is large, and armed with several rows of compressed sharp-edged and sometimes serrated teeth. The skin is usually very rough, covered with a multitude of little osseous tubercles. They are the most formidable and voracious of all fishes, pursue other



marine animals, and seem to care little whether they prey be living or dead. They often follow vessels for the sake of picking up any offal which may be thrown overboard, and man himself often becomes a victim to their rapacity. The basking shark is by far the largest species, sometimes attaining the length of forty feet, but it has none of the ferocity of the others. The hammer-headed sharks are very voracious, and often attack man. The long-tailed shark is distinguished by having the tail as long as the body. The shark is oviparous or ovo-viviparous according to circumstances. [See *SQUALIDÆ*.]—2. A greedy artful fellow; one who fills his pockets by sly tricks. [*Low*.]—3. Trick; fraud; petty rapine; as, to live upon the *shark*. [*Little used*.]

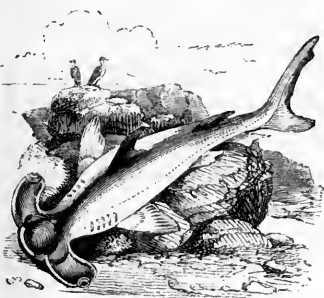

Hammer-headed Shark (*Zygenus malleus*).

SHARK, *v. t.* To pick up hastily, slyly, or in small quantities. [*Low*.]

SHARK, *v. i.* To play the petty thief; or rather to live by shifts and petty stratagems.—2. To cheat; to trick. [*Low*.]—3. To fawn upon for a dinner; to beg.—To *shark out*, to slip out or escape by low artifices. [*Vulgar*.]

SHARK'ER, *n.* One that lives by sharking; an artful fellow.

SHARK'ING, *ppr.* Picking up in haste; living by petty rapine, or by shifts and devices.

SHARK'ING, *n.* Petty rapine; trick.—2. The seeking of a livelihood by shifts and devices.

SHAR'OCK, *n.* A silver coin in India, worth about a shilling sterling.

SHARP, *a.* [Sax. *scearp*; G. *scharf*; probably from the root of *shear*, *shire*, *short*; the radical letters being *Cr* or *Gr*.] 1. Having a very thin edge or fine point; keen; acute; not blunt. Thus we say, a *sharp* knife, or a *sharp* needle. A *sharp* edge easily severs a substance; a *sharp* point is easily made to penetrate it.—2. Terminating in a point or edge; not obtuse; as, a hill terminates in a *sharp* peak, or a *sharp* ridge.—3. Forming an acute or too small angle at the ridge; as, a *sharp* roof.—4. Acute of mind; quick to discern or distinguish; penetrating; ready at invention; witty; ingenious.

Nothing makes men *sharper* than want. Addison.

Many other things belong to the material world, wherein the *sharpest* philosophers have not yet obtained clear ideas. *Watts*. 5. Being of quick or nice perception; applied to the senses or organs of perception; as, a *sharp* eye; *sharp* sight. To *sharp* eyed reason this would seem untrue. Dryden.

6. Affecting the organs of taste like fine points; sour; acid; as, *sharp* vine-

gar; *sharp* tasted citrons.—7. Affecting the organs of hearing like sharp points; piercing; penetrating; shrill; as, a *sharp* sound or voice; a *sharp* note or tone; opposed to a *flat* note or sound.—8. Severe; harsh; biting; sarcastic; as, *sharp* words; *sharp* rebuke.

Be thy words severe,

*Sharp* as he merits; but the sword forbear. Dryden.

9. Severely rigid; quick or severe in punishing; cruel.

To that place the *sharp* Athenian law

Cannot pursue us. Shak.

10. Eager for food; keen; as, a *sharp* appetite.—11. Eager in pursuit; keen in request. My falchion now is *sharp* and passing empty. Shak.

12. Fierce; ardent; fiery; violent; as, a *sharp* contest.

A *sharp* assault already is begun. Dryden

13. Keen; severe; pungent; as, *sharp* pain.—14. Very painful or distressing; as, *sharp* tribulation; a *sharp* fit of the gout.—15. Very attentive or vigilant.

*Sharp* at her utmost ken she cast her eyes. Dryden.

16. Making nice calculations of profit; or close and exact in making bargains or demanding dues.—17. Biting; pinching; piercing; as, *sharp* pair; *sharp* wind or weather.—18. Subtle; nice; witty; acute; *used of things*; as, a *sharp* discourse.—19. Among *workmen*, hard; as, *sharp* sand.—20. Emaciated; lean; thin; as, a *sharp* visage.—To *brace sharp*, in seamanship, to turn the yards to the most oblique position possible, that the ship may lay well up to the wind.

SHARP, *n.* In music, an acute sound.—2. A note artificially raised a semitone; or,—3. The character which, prefixed to a note, signifies that it is to be sung or played a semitone higher than it naturally would have been without such character. It is formed thus ♯.

*Sharp* is also a musical term applied to those keys, the basis of which is the perfect harmonic triad. [See *FLAT*.]—*Double sharp*, a character (×) used in chromatic music, and which raises a note two semitones above its natural state.—4. † A pointed weapon.

SHARP, *v. t.* To make keen or acute.—2. To render quick.—3. To mark with a sharp, in musical composition; or to raise a note a semitone.

SHARP, *v. i.* To play tricks in bargaining; to act the sharper.

SHARP'ED, *pp.* Made keen.—2. Marked with a sharp in musical composition.

SHARP-EDG'ED, *a.* Having a fine keen edge.

SHARP'EN, *v. t.* (shårpn.) [G. *schårfen*.] 1. To make sharp; to give a keen edge or fine point to a thing; to edge; to point; as, to *sharpen* a knife, an axe, or the teeth of a saw; to *sharpen* a sword.

All the Israelites went down to the Philistines to *sharpen* every man his share and his coultter, and his axe and his mattock; 1 Sam. xiii.

2. To make more eager or active; as, to *sharpen* the edge of industry.—3. To make more pungent and painful. The abuse of wealth and greatness may hereafter *sharpen* the sting of conscience.—4. To make more quick, acute, or ingenious. The wit or the intellect is *sharpened* by study.—5. To render perception more quick or acute.

The air *sharpen'd* his visual ray To objects distant far. Milton.

6. To render more keen; to make more eager for food or for any gratification; as, to *sharpen* the appetite; to *sharpen* a desire.—7. To make biting, sarcastic, or severe.

*Sharpen* each word. *Smith*.

8. To render less flat, or more shrill or piercing. Inclosures not only preserve sound, but increase and *sharpen* it. Bacon.

9. To make more tart or acid; to make sour; as, the rays of the sun *sharpen* vinegar.—10. To make more distressing, as, to *sharpen* grief or other evil.—11. In music, to raise a sound by means of a sharp.

SHARP'EN, *v. i.* To grow or become sharp.

SHARP'ENED, *pp.* or *a.* Made sharp; edged; pointed; rendered more active, acute, keen, &c.

SHARP'ENING, *ppr.* See the verb.

SHARP'ER, *n.* A shrewd man in making bargains; a tricky fellow; a rascal; a cheat in bargaining or gaming.

*Sharpers* as pikes, prey upon their own kind. *L'Estrange*.

SHARP'ING, *ppr.* Making keen or acute.—2. Marking with a sharp, in musical composition.

SHARP'ING, *n.* In former times, a customary present of corn, made about Christmas, by farmers in some parts of England, to blacksmiths, for sharpening their iron implements of husbandry.

SHARP'LY, *adv.* With a keen edge or a fine point.—2. Severely; rigorously; roughly; Tit. i.

They are to be more *sharply* chastised and reformed than the rude Irish. *Spenser*.

3. Keenly; acutely; vigorously; as, the mind and memory *sharply* exercised.—4. Violently; vehemently.

At the arrival of the English ambassadors, the soldiers were *sharply* assailed with wants. *Hayward*.

5. With keen perception; exactly; minutely.

You contract your eye, when you would see *sharply*. Bacon.

6. Acutely; wittily; with nice discernment.

SHARP NAIL, *n.* A kind of nail with a flat shank and sharp point, much used in the West Indies.

SHARP'NESS, *n.* Keeness of an edge or point; as, the *sharpness* of a razor or a dart.—2. Not obtuseness.—3. Pungency; acidity; as, the *sharpness* of vinegar.—4. Pungency of pain; keenness; severity of pain or affliction; as, the *sharpness* of pain, grief, or anguish.—5. Painfulness; afflictiveness; as, the *sharpness* of death or calmsity.

And the best quarrels in the heat are curst By those that feel their *sharpness*. *Shak*.

6. Severity of language; pungency; satirical sarcasm; as, the *sharpness* of satire or rebuke.

Some did all folly with just *sharpness* blame. Dryden.

7. Acuteness of intellect; the power of nice discernment; quickness of understanding; ingenuity; as, *sharpness* of wit or understanding.—8. Quickness of sense or perception; as, the *sharpness* of sight.—9. Keeness; severity; as, the *sharpness* of the air or weather.

SHARP'POINTED, *a.* Having a sharp point.

SHARP'-SET, *a.* [*sharp* and *set*.] Eager in appetite; affected by keen hunger; ravenous; as, an eagle or a lion *sharp-set*.—2. Eager in desire of gratification. [*Familiar in both senses*.]

The town is *sharp-set* on new plays. Pope.

**SHARP-SHOOTER**, *n.* [*sharp* and *shoot*] One skilled in shooting at an object with exactness; one skilled in the use of the rifle. Formerly there were, in several armies, a few men attached to each company of troops, who carried rifles and took aim at particular individuals, and did not shoot with the mass of the troops. These were called *sharp-shooters*; but the better organization of modern armies has caused them to be abolished. Instead of them riflemen are employed in the British army, and *tirailleurs* in the French army.

**SHARP-SHOOTING**, *n.* A shooting with great precision and effect, as rifle-men.

**SHARP-SIGHTED**, *a.* [*sharp* and *sight*.] Having quick or acute sight; as, a *sharp-sighted* eagle or hawk.—2. Having quick discernment or acute understanding; as, a *sharp-sighted* opponent; *sharp-sighted* judgment.

**SHARP-SIGHTEDNESS**, *n.* The state of having acute sight.

**SHARP-VISAGED**, *a.* [*sharp* and *visage*.] Having a sharp or thin face.

**SHARP-WITTED**, *a.* Having an acute or nicely discerning mind.

**SHAS'TER**, } *n.* [Properly *sastra*.] **ASHAS'TRA**, } *mong the Hindoos*, a law, or legal institutes; applied particularly to a book containing the authorized institutes of their religion, and considered of divine origin. The term is applied, in a wider sense, to Hindoo treatises containing the laws or institutes of the various arts and sciences, as rhetoric.

**SHAT'TER**, *v. t.* [D. *schateren*, to crack, to make a great noise. This word seems to be allied to *scatter* and to *scath*, waste. The sense is to force or drive apart.] 1. To break at once into many pieces; to dash, burst, rend, or part by violence into fragments; as, explosion *shatters* a rock or a bomb; lightning *shatters* the sturdy oak; steam *shatters* a boiler; a monarchy is *shattered* by revolt.—2. To rend; to crack; to split; to rive into splinters.—3. To dissipate; to make incapable of close and continued application; as, a man of *shattered* humour.—4. To disorder; to derange; to render delirious; as, to *shatter* the brain. The man seems to be *shattered* in his intellect.

**SHAT'TER**, *v. i.* To be broken into fragments; to fall or crumble to pieces by any force applied.

Some *shatter* and *fly* in many places.

**SHAT'TER-BRAINED**, } *Bacon.* **SHAT'TER-PATED**, } *a.* [*shatter* and *brain* or *pate*.] Disordered or wandering in intellect.—2. Heedless; wild; not consistent.

**SHAT'TERED**, *pp.* Broken or dashed to pieces; rent; disordered.

**SHAT'TERING**, *ppr.* Dashing or breaking to pieces; rending; disordering.

**SHAT'TERS**, *n.* [used only in the plural.] The fragments of any thing forcibly rent or broken; used chiefly or solely in the phrases, to *break* or *rend* into *shatters*.

**SHAT'TERY**, *a.* Brittle; easily falling into many pieces; not compact; loose of texture; as, *shattery* spar.

**SHAVE**, *v. t.* pret. *Shaved*; *pp.* *Shaved* or *Shaven*. [Sax. *sceafan*, *scafan*; D. *schaaven*; G. *schaben*.] 1. To cut or pare off something from the surface of a body by a razor or other edged instrument, by rubbing, scraping, or

drawing the instrument along the surface; as, to *shave* the chin and cheeks; to *shave* the head of its hair.

He shall *shave* his head in the day of his cleansing; Num. vi.

2. To *shave off*, to cut off.

Neither shall they *shave off* the corner of their beard; Lev. xxi.

3. To pare close.

The bending scythe

*Shaves* all the surface of the waving green. *Gay.*

4. To cut off thin slices; or to cut in thin slices.—5. To skim along the surface or near it; to sweep along.

He *shaves* with level wing the deep. *Milton.*

6. To strip; to oppress by extortion; to fleece.—7. To make smooth by paring or cutting off slices; as, to *shave* hoops or staves.

**SHAVE**, *n.* [Sw. *shaf*; G. *schabe*; Sax. *scafa*, *scafa*; D. *schaaf*, a plane.] An instrument with a long blade and a handle at each end for shaving hoops, &c.; called also a *drawing knife*.

**SHAVED**, *pp.* Pared; made smooth with a razor or other cutting instrument; fleeced.

**SHAVE-GRASS**, *n.* A plant of the genus *Equisetum*.

**SHAVELING**, *n.* A man shaved; a friar or religious; *in contempt*.

**SHAVER**, *n.* One that shaves or whose occupation is to shave.—2. One that is close in bargains or a sharp dealer.

This Lewis is a cunning *shaver*. *Swift.*  
3. One that fleeces; a pillager; a plunderer.

By these *shavers* the Turks were stripped of all they had. *Knolles.*

**SHAVE'R**, *n.* A humorous fellow; a wag. A low word, borrowed from the idea of taking off the beard. [*Scotch.*]

**SHAVIE**, *n.* A trick or prank. [*Scotch.*]

**SHAVING**, *ppr.* Paring the surface with a razor or other sharp instrument; making smooth by paring; fleecing.

**SHAVING**, *n.* The act of paring the surface.—2. A thin slice pared off with a shave, a knife, a plane, or other cutting instrument.

**SHAW**, *n.* [Sax. *scua*, *scuwa*; Sw. *shugga*; Dan. *shove*, a thicket, and *shygge*, a shade.] A thicket; a small wood; a shady place. [*Local.*]

**SHAW-FOWL**, *n.* [*shaw* and *fowl*.] The representation or image of a fowl made by fowlers to shoot at.

**SHAWL**, *n.* [Fr. *châle*.] A long or square vestment, not specially shaped for any individual, but which is generally used by persons of both sexes, in the East, to form the folds of their turbans, or is worn as a mantle or a girde, and sometimes serves as a carpet to sit or lie on. The shawls of Cashmere are the most valued.—2. A large piece of woven stuff, often imitative of the foregoing, in material, pattern, and colour, worn by the females of Europe and N. America, as a loose body or shoulder covering, or neckerchief. Shawls are of several sizes, and divers materials; as, shawls of silk, cotton, hair, or wool; and occasionally they are formed of a mixture of some or all these staples. The use of the shawl in Europe, at least of a vestment under that name, belongs almost entirely to the present century.

**SHAWM**, } *n.* [G. *schalmeie*, from *schal-*  
**SHÄLM**, } *ten*, to sound.] In ancient music, a wind instrument, similar in form to the clarionet; now superseded by the hautboy and bassoon.

**SHE**, pronoun personal of the feminine gender. [Sax. *seo*; Goth. *si*; D. *zy*; G. *sie*. The Danes and Swedes use for *he* and *she*, the word from which the English has *hen*; Dan. *han*, he, the male; *hun*, she, the female; *hane*, a cock; Sw. *han*, he; *hanne*, a cock; *hon*, *hennes*, *henne*, she. This is the root of *Henry*. *She* is perhaps the Heb. שָׂה, *ishah*, a woman or wife. In the Saxon, *seo* is used as an adjective, and may be rendered *the* or *a*. It is also used as a relative, answering to *who*, L. *quæ*. It is also used for *he* and *that*. In English, *she* has no variation, and is used only in the nominative case. In the oblique cases, we use *hers* and *her*, a distinct word.] 1. A pronoun which is the substitute for the name of a female, and of the feminine gender; the word which refers to a female mentioned in the preceding or following part of a sentence or discourse.

Then Sarah denied, saying, I laughed not; for *she* was afraid; Gen. xviii.

2. *She* is sometimes used as a noun for *woman* or *female*, and in the plural; but in contempt or in ludicrous language.

Lady, you are the cruellest *she* alive.

*Shak.*

The *sher* of Italy shall not betray my interest. *Shak.*

3. *She* is used also in composition for female, representing sex; as, a *she-bear*; a *she-cat*.

**SHEA** or **BUTTER TREE**, *n.* The *Bassia butyracea* of botanists, a native of tropical Asia and Africa, and believed to be the Fulwa or Fulwara tree of India. The African *shea tree*, (says Mr. John Duncan,) resembles the laurel in the shape and colour of its leaves, but usually grows to the height of 18 or 20 feet. The *shea*, or vegetable butter, is found in the nut, and is obtained pure by crushing, boiling, and straining. The nuts grow in bunches, and are attached to the boughs by slender filaments. They are of the shape and size of a pigeon's egg, of a light drab when new, but the colour deepens afterwards to that of chocolate. A good sized tree, in prolific condition, will yield a bushel of nuts.

**SHEADING**, *n.* [G. *scheiden*, Sax. *scedan*, to divide.] In the *Ile of Man*, a riding, tithing, or division, in which there is a coroner or chief constable. The *isle* is divided into six *sheadings*.

**SHEAF**, *n. plur.* *Sheaves*. [Sax. *scaef*; D. *schoof*.] It appears to be connected with the D. *schuivent*, *schoof*, to *shove*, Sax. *scafan*. The sense then is a mass or collection driven or pressed together.] 1. A quantity of the stalks of wheat, rye, oats, or barley bound together; a bundle of stalks or straw. The reaper fills his greedy hands,

And binds the golden *sheaver* in brittle bands. *Dryden.*

2. Any bundle or collection; as, a *sheaf* of arrows.—3. In *mechanics*, a solid cylindrical wheel fixed in a channel, and movable about an axis, as in the block of a pulley. [See *SHEAVE*.]

**SHEAF**, *v. t.* To collect and bind; to make sheaves.

**SHEAL**, } *to shell*.

**SHEAL'ING**, **SHEEL'ING**, or **SHEIL'ING**, *n.* A hut or residence for those who have the care of sheep; also a hut for fishermen. [*Scotch.*]

**SHEAR**, *v. t.* pret. *Sheared*; *pp.* *Sheared* or *Shorn*. The old pret. *shore* is en-

tirely obsolete. [Sax. *scæaran*, *scyræn*, *sciran*, to shear, to divide, whence *share* and *shire*; G. *scheren*, to shear or shave, and to vex, to rail, to *jeer*; *schier dich weg*, get you gone; *schier dich aus dem wege*, move out of the way; D. *scheeren*, to shave, shear, banter, stretch, warp; *de geh scheeren*, to play the fool; *zig weg scheeren*, to shear off; Dan. *skierer*, to cut, carve, saw, hew; *shieris*, a jest, jeer, banter; *shiertser*, to sport, mock, jeer; Sw. *skittra*, to reap, to mow, to cut off, to cleanse, to rinse; Sans. *schaura* or *chaura*, to shave; W. *ysgar*, a part, a share; *ysgariau*, to separate. The Greek has *εφαειν*, to shave, and *εφαειν*, to shave, shear, cut off, or lay waste. The primary sense is to separate or force off in general; but a prominent signification is to separate by rubbing, as in *scouring*, or as in *shaving*, cutting close to the surface. Hence the sense of *jeering*, as we say, to give one the rub. See SCOUR.] 1. To cut or clip something from the surface with an instrument of two blades; to separate any thing from the surface by shears, scissors or a like instrument; as, to shear sheep; to shear cloth. It is appropriately used for the cutting of wool from sheep or their skins, and for clipping the nap from cloth, but may be applied to other things; as, a horse shears the ground in feeding much closer than an ox.—2. To separate by shears; as, to shear a fleece.—3. In *Scotland*, to reap. SHEAR, v. i. To divide, as the two parts of anything when cut or sheared.—2. To deviate. [See SHEER.]

SHEAR, n. A year as applied to the age of a sheep, denominated from the yearly shearing; as, sheep of one shear, of two shears, &c. [Local.]

SHEAR-BILL, n. [*Shear* and *bill*.] A fowl, the black skimmer or cut-water, *Rhynchops nigra*, of the Antilles. [See SKIMMER.]

SHEARD, n. A shard. [See SHARD.] SHEARED, pp. Clipped; deprived of wool, hair, or nap.

SHEARER, n. One that shears; as, a shearer of sheep. In *Scotland*, one that reaps corn.

SHEARING, ppr. Clipping; depriving of wool, hair, or nap.

SHEARING, n. The term used in *Scotland* for reaping.—*Shearing sheep*, the operation of clipping off the wool from the bodies of ewes and lambs, generally performed in the beginning of summer.

SHEARING-MACHINE, n. A machine used by boiler-makers and engineers for cutting plates and bars of iron and other metals. [See PUNCHING MACHINE.]

SHEARLING, n. A sheep that has been but once sheared.

SHEARMAN, n. One whose occupation is to shear cloth.

SHEARS, n. plur. [from the verb.] An instrument consisting of two blades with a bevel edge, movable on a pin, used for cutting cloth and other substances by interception between the two blades. Shears differ from scissors chiefly in being larger.

Fate urg'd the shears and cut the sylph in twain. Pope.

The shears used by farriers, sheep-shearers, weavers, &c., are made of a single piece of steel, bent round until the blades meet, which open of themselves by the elasticity of the metal.—2. Something in the form of the blades

of shears.—3. † Wings.—4. An engine for raising heavy weights. [See SURENS.] SHEAR STEEL, n. (so called because fitted for making clothiers' shears, scythes, &c.) A kind of steel prepared by laying several bars of common steel together, and heating them in a furnace until they acquire the welding temperature. The bars are then beaten together with forge hammers, after which they are drawn anew into bars for sale.

SHEAR-WATER, n. A fowl, *Larus niger*. A species of petrel, (*Procellaria puffinus*, Linn., and *Puffinus cinereus*



Shearwater (*Procellaria puffinus*).

Stephens, found on the coasts of Great Britain and Ireland; and also common on the coast of Peru and Cape Horn. The shearwaters fly rapidly, skimming over the waves, whence they pick up small fishes, crustaceans, molluscs, &c. The cut-water, *Rhynchops nigra*.

SHEAT. See SHEET.

SHEAT-FISH, n. [G. *scheide*.] A fish, a species of Silurus, having a long slimy body destitute of scales, and the back dusky, like that of the eel. It is the largest fresh-water fish of Europe, being sometimes six feet or more in length.

SHEATH, n. [Sax. *scæath*, *scæthe*; G. *scheide*; from separating, G. *scheiden*, Sax. *sceadan*. See SHADE.] 1. A case for the reception of a sword or other long and slender instrument; a scabbard. A sheath is that which separates, and hence a defence.—2. In bot., a term applied to a petiole when it embraces the branch from which it springs, as in grasses; or to a rudimentary leaf which wraps round the stem on which it grows, as in the scapus of many Endogenous plants.—3. Any thin covering for defence; the wing-case of an insect.—4. A land-guard of loose stones for confining a river within its banks.

SHEATHE, v. t. To put into a case or scabbard; as, to sheathe a sword or dagger.—2. To inclose or cover with a sheath or case.

The leopard... keeps the claws of his fore feet turned up from the ground, and sheathed in the skin of his toes. Grew.

'Tis in my breast she sheathes her dagger now. Dryden.

3. To cover or line; as, to sheathe the bowels with demulcent or mucilaginous substances.—4. To obtund or blunt, as acrimonious or sharp particles.—5. To fit with a sheath.—6. To case or cover with boards or with sheets of copper; as, to sheathe a ship to preserve it from the worms.—To sheathe the sword, a figurative phrase, to put an end to war or enmity; to make peace. It corresponds to the Indian phrase, to bury the hatchet.

SHEATHED, pp. Put in a sheath; inclosed or covered with a case; covered; lined; invested with a membrane.

SHEATHER, n. One that sheathes.

SHEATHING, ppr. Putting in a sheath; inclosing in a case; covering; lining;

investing with a membrane.—*Sheathing leaf*, a leaf which forms a sheath to the stem; as in wheat, oats, and grasses.

SHEATHING, n. The casing or covering of a ship's bottom and sides; or the materials for such covering. The object of sheathing is to protect the ship from worms. Sheets of thin copper nailed on with copper nails, constitutes at present the sheathing of all the better kind of vessels.

SHEATHING NAILS, n. Nails used in fastening sheathing to ships.

SHEATHLESS, a. Without a sheath or case for covering; unsheathed.

SHEATH-WINGED, a. [*sheath* and *wing*.] Having cases for covering the wings; as, a sheath-winged insect.

SHEATHY, a. Forming a sheath or case.

SHEAVE, n. [in D. *schyf* is a slice, a truckle, a quoit, a fillet, a draughtsman, a pane. In G. *scheibe* is a mark, a pane, a wheel, the knee-pan, a slice.] In *seamen's lan.*, a wheel on which the rope works in a block. It is made of hard wood or of metal. When made of wood, it is sometimes *bushed*, that is, has a piece of perforated brass let into its centre, the better to sustain the friction of the pin or axis.

SHEAVE, † v. t. To bring together; to collect.

SHEAVED, † a. Made of straw.

SHEAVE-HOLE, n. A channel cut in a mast, yard, or other timber, in which to fix a sheave.

SHEAVING, n. The operation of binding wheat, oats, barley, &c., into sheaves.

SHECHYNAH, SHEKYNAH, n. The Jewish name for the divine presence which rested in the shape of a cloud over the mercy seat; Lev. xvi. 2.

SHECKL'ATON, † n. [Fr. *ciclaton*.] A kind of gilt leather.

SHED, v. t. pret. and pp. *Shed*. [Sax. *scedan*, to pour out. If *s* is a prefix, this word coincides in elements with D. *gieten*, to pour, to cast, G. *giessen*, Eng. *gush*. It coincides also in elements with *shoot*. See the Noun.] 1. To cause or suffer to flow out; to pour out; to spill; as, to shed tears; to shed blood. The sun sheds light on the earth; the stars shed a more feeble light.

This is my blood of the New Testament, which is shed for many for the remission of sins; Matt. xxvi.

2. To let fall; to cast; as, the trees shed their leaves in autumn; the fowls shed their feathers; and serpents shed their skin.—3. To scatter; to emit; to throw off; to diffuse; as, flowers shed their sweets or fragrance. [The peculiar sense of this word is to cast off something that belongs to the body, either a substance or a quality. Applied to animals and plants, it expresses a periodical casting off of a natural covering.]

SHED, v. i. To let fall its parts.

White oats are apt to shed most as they lie, and black as they stand. Mortimer.

SHED, n. [Sax. *sced*, a shade; Sw. *shydd*, a defence; *shydd*, to protect, to defend or shelter; Dan. *shytter*, id.; *shytter*, a shooter; *shyts*, a defence; *shyt*, a gun; *shyder*, to shoot; G. *schützen*, to defend; *schütze*, a shooter; D. *schutten*, to defend, to parry or stop; *schutter*, a shooter. It appears that *shed*, the noun and verb, and *shoot*, are from one source, and *shade*, *scud*, *scath*, and several other words, when traced, all terminate in the same radical sense, to thrust, rush, or drive.]

1. A slight building; a covering of timber and boards, &c., for shelter against rain and the inclemencies of weather; a poor house or hovel.

The first Aletes born in lowly *shed*. *Fairfax*.  
2. In *agriculture*, a slight temporary building to shelter cattle or implements of husbandry from the weather. *Sheets* of reeds which summer's heat reel.

*Smdys.*

3. In *composition*, effusion; as in blood-*shed*. [See the Verb.]

SHED, *v. t.* To keep off; to prevent from entering; as a hut, umbrella, or garment that *sheds* rain.

SHED'DER, *n.* One that sheds or causes to flow out; as, a *shedder* of blood.

SHED'DING, *ppr.* Effusing; causing to flow out; letting fall; casting; throwing off; sending out; diffusing; keeping off.  
SHED'DING, *n.* That which is cast off.—2. The act of casting off or out.

SHED LINE, *n.* The summit line of elevated ground.

SHED ROOF, *n.* The simplest kind of roof, formed by rafters sloping between a high and a low wall.

SHĒEN, } *a.* [Sax. *scene*, *scen*, bright.  
SHĒENY, } This is the old orthography of *Shine*,—*which see*.] Bright; glittering; showy. [Poetical.]

The *sheen* of their spears was like stars on the sea. *Byron*.

SHĒEN, *n.* Brightness; splendour.

SHEEP, *n. sing. and plur.* [Sax. *scēap*, *scēp*; G. *schaf*.] 1. An animal of the genus *Ovis*, which is among the most useful species that the Creator has bestowed on man, as its wool constitutes a principal material of warm clothing, and its flesh is a great article of food. The skin dressed, forms different parts of our apparel, and is used for covers of books. The entrails, properly prepared and twisted, serve for strings for various musical instruments. The milk is thicker than that of cows, and consequently yields a greater quantity of butter and cheese. The sheep is remarkable for its harmless temper and its timidity. The varieties are numerous. The principal varieties of the English sheep are the large Lincolnshire, the Dorset breed, the South-down, and the Cheviot. The foreign breeds of sheep are exceedingly numerous, but of these perhaps the Asiatic variety is the most singular.



Barbary Broad-tailed Sheep (*Ovis stratyoga*).

In India, the sheep is long-tailed; and in Persia, Tartary, and China, &c., the tail is not only elongated, but loaded with a mass of fat, in some instances weighing ten pounds. The variety most celebrated for the fineness of the wool is the Spanish merino, [see *MERINO*,] as improved in Germany. The wild sheep or Argali [see *ARGALI*] is found in Asia, Africa, and America. The Rocky Mountain sheep

is nearly related to the goat, and its fleece is said to be as fine as that of the



Rocky Mountain Sheep (*Ovis montanus*)

shawl goat of Cashmere.—2. In contempt, a silly fellow.—3. Figuratively, God's people are called *sheep*, as being under the government and protection of Christ, the great Shepherd; John x.—4. A congregation considered as under a spiritual shepherd or pastor. More usually termed a *flock*.

SHEEP-BITE, *† v. t.* [*sheep and bite*.] To practise petty thefts.

SHEEP-BITER, *† n.* One who practises petty thefts.

SHEEPCOT, *n.* [*sheep and cot*.] A small inclosure for sheep; a pen.

SHEEPFOLD, *n.* [*sheep and fold*.] A place where sheep are collected or confined.

SHEEPHOOK, *n.* [*sheep and hook*.] A hook fastened to a pole, by which shepherds lay hold on the legs of their sheep.

SHEEPISH, *a.* Like a sheep; bashful; timorous to excess; over-modest; meanly diffident.—2. Pertaining to sheep.

SHEEPISHLY, *adv.* Bashfully; with mean timidity or diffidence.

SHEEPISHNESS, *n.* Bashfulness; excessive modesty or diffidence; mean timorousness.

SHEEP-MARKET, *n.* A place where sheep are sold.

SHEEP-MASTER, *n.* [*sheep and master*.] A feeder of sheep; one that has the care of sheep.

SHEEP'S BIT, *n.* A plant of the genus *Jasione*, the *J. montana*. [See *JASIONE*.]

SHEEP'S-EYE, *n.* [*sheep and eye*.] A modest, diffident look, such as lovers cast at their mistresses.

SHEEP-SHANK, *n.* [*sheep and shank*.] Among *seamen*, a knot in a rope made to shorten it, as on a runner or tie.—*To sheep-shank*, to shorten the top-gallant backstays, &c.

SHEEP'S-HEAD, *n.* [*sheep and head*.] A fish caught on the shores of Connecticut and of Long Island, so called from the resemblance of its head to that of a sheep. It is esteemed delicious food.

SHEEP-SHEARER, *n.* [*sheep and shear*.] One that shears or cuts off the wool from sheep; Gen xxxviii.

SHEEP-SHEARING, *n.* The act of shearing sheep.—2. The time of shearing sheep; also, a feast made on that occasion.

SHEEP-SILVER, *n.* A sum of money anciently paid by tenants to be released from the service of washing the lord's sheep.—In *Scot.*, the popular name of *mea*.

SHEEP-SKIN, *n.* The skin of a sheep; or leather prepared from it.

SHEEP'S-SORREL, *n.* An herb, (*Ru-*

*mez acetosella*), growing naturally on poor, dry, gravelly soil.

SHEEP-STEALER, *n.* [*sheep and steal*.] One that steals sheep.

SHEEP-STEALING, *n.* The act of stealing sheep.

SHEEP-WALK, *n.* [*sheep and walk*.] Pasture for sheep; a place where sheep feed; a track or path made by sheep.

SHEER, *a.* [Sax. *scir*, *scyr*; G. *schier*; Dan. *skier*; Sans. *charu*, *tscharu*; from the root of *shear*, to separate; whence *sheer* is clear, pure. It might be deduced from the Shemitic זָהָר, *zehar*, to be clear. But the Danish and Saxon orthography coincides with that of *Shear*.]

1. Pure; clear; separate from anything foreign; unmingled; as *sheer* ale. But this application is unusual. We say, *sheer* argument, *sheer* wit, *sheer* falsehood, *sheer* ignorance, *sheer* stupidity &c.—2. Clear; thin; as, *sheer* muslin.

SHEER, *† adv.* Clean; quite; at once.

SHEER, *† v. t.* To shear.

SHEER, *v. i.* [See *SHEAR*.] 1. In *seamen's lan.*, to decline or deviate from the line of the proper course, as a ship when not steered with steadiness.—2. To slip or move aside.—*To sheer off*, to turn or move aside to a distance; to part or separate from; to move off or away.—*To sheer up*, to turn and approach to a place or ship.

SHEER, *n.* The curve which the line of ports or of the deck presents to the eye when viewing the side of a ship. When these lines are straight or the extremities do not rise, as is most usual, the ship is said to have a straight *sheer*.—*To quicken the sheer*, among *shipwrights*, is to shorten the radius which strikes out the curve.—*To straighten the sheer*, to lengthen the radius.—2. The position in which a ship is sometimes kept at single anchor, to keep her clear of it.—*To break sheer*, to deviate from that position.

SHEER-HOOKS, *n.* An instrument with prongs and hooks, placed at the



Sheer-Hooks.

extremities of the yards of fire-ships, to entangle the enemy's rigging, &c.

SHEER-HULK, *n.* An old ship of war,



Sheer-Hulk.

fitted with sheers or apparatus to fix or take out the masts of other ships.

SHEERLY,† *adv.* At once; quite; absolutely.

SHEERS, *n. plur.* In *ships*, an apparatus consisting of two or more pieces of timber or poles erected in a mutually inclined position, and fastened together near the top, their lower ends being secured to the opposite sides of the vessel. Tackle blocks are suspended to them for the purpose of hoisting in or getting out the masts of a vessel; the same contrivance is also used for other purposes, such as the loading or unloading of the vessel, &c.

SHEER-STRAKE, *n.* In *shipbuilding*, the strake under the gunwale in the top-side. [See STRAKE.]

SHEET, *n.* [Sax. *scæt*, *sceta*, *scyta*; L. *scheda*; Gr. *σχῆδη*.] The Saxon *scæt* signifies a garment, a cloth, towel, or napkin; *sceta* is rendered a *sheet*, and the Greek and Latin words signify a table or plate for writing on; from the root of Sax. *scædan*, to separate, L. *scindo*, Gr. *σχίζω*.] 1. A broad and large piece of cloth, as of linen or cotton; the linen of a bed.—2. A broad piece of paper as it comes from the manufacturer. *Sheets* of paper are of different sizes, as royal, demy, foolscap, pot, and post paper.—3. A piece of paper printed, folded, and bound, or formed into a book in blank, and making four, eight, sixteen, or twenty-four pages, &c.—4. Any thing expanded; as, a *sheet* of water or of fire; a *sheet* of copper, lead, or iron.—5. *Sheets*, *plur.* a book or pamphlet. The following *sheets* contain a full answer to my opponent.—6. In *poetry*, a sail. [Improper.]

SHEET, *n.* [Fr. *escoute*. This word seems to be connected with *scot* or *shot*; Sp. *escotar*, to cut out clothes, to pay one's *scot* or share of taxes, and in *nautical lan.*, to free a ship of water by pumping. The word is probably from that root, or from *shoot*.] In *nautical lan.*, a rope fastened to one or both the lower corners of a sail to extend and retain it in a particular situation. In the square sails above the courses, the ropes attached to both clues are called *sheets*; in all other cases the weathermost one is called a *tack*. When a ship sails with a side-wind, the lower corners of the main and fore sails are fastened with a *tack* and a *sheet*. The stay-sails and studding-sails have only one *tack* and one *sheet* each.

SHEET, *v. t.* To furnish with sheets. [Little used.]—2. To fold in a sheet. [Little used.]—3. To cover as with a sheet; to cover with something broad and thin.

When snow the pasture *sheets*. *Shak.*  
To *sheet home*, is to haul home a sheet, or extend the sail till the clue is close to the sheet-block.

SHEET-ANCHOR, *n.* [originally written *shote-anchor*, that is, the anchor thrown out for security or preservation.] The largest anchor of a ship, which in stress of weather is sometimes the seaman's last refuge to prevent the ship from going ashore. Hence,—2. The chief support; the last refuge for safety.

SHEET-COPPER, *n.* Copper in broad thin plates.

SHEETING, *n.* Cloth for sheets.

SHEET-IRON, *n.* Iron in sheets, or broad thin plates.

SHEET-LEAD, *n.* Lead formed into sheets. [See LEAD.]

SHEET-PILES, } *n.* Piles formed  
SHEETING-PILES, } of thick plank,  
shot or jointed on the edges, and sometimes grooved and tongued, driven closely together between the main or gauge piles of a cofferdam or other hydraulic work, to enclose the space either to retain or exclude water, as the case may be. Sheetting piles have of late been formed of iron.

SHEETS, *n.* The ropes attached to sails, by which they are set and the top-sails hauled up. [See SHEET.]

SHEIK, *n.* [In Ar. elder, or eldest.] A title of dignity properly belonging to the chiefs of the Arabic tribes or clans. The heads of monasteries are sometimes called sheiks among the Mohammedans, and it is also the title of the higher order of religious persons who preach in the mosques.

SHEK'EL, *n.* [Heb. שֶׁקֶל, *shakel*, to weigh; Ch.Syr. Ar. and Eth. *id.*; Eth. to append or suspend; Low L. *sichus*; Fr. *sicle*. From this root we have *skilling*. Payments were originally made by weight, as they still are in some countries. See POUND.] An ancient weight and coin among the Jews and other nations of the same stock. Dr. Arbuthnot makes the weight to have been equal to 9 pennyweights 2½ grains, Troy weight, and the value 2s. 3½d. sterling. Others make its value 2s. 6d. sterling. The golden shekel was worth £1 16s. 6d. sterling. The shekel of the sanctuary was used in calculating the offerings of the temple, and all sums connected with the sacred law. It differed from the common shekel, and is supposed to have been double its value.

SHELD'AFLE, } *n.* A chaffinch. This  
SHELD'APPLE, } word is also written  
*Shell-apple*.

SHEL'DRAKE, *n.* An aquatic fowl of the duck kind, the *Anas tadorna*, which is the type of the subgenus *Tadorna* of Ray, and of modern ornithologists. It is also called bargander, St. George's duck, burrow duck, sly-goose, skeel duck, and skeeling goose. These birds inhabit the sea coasts, and breed in rabbit holes. They feed on small fish, marine insects and sea-weeds.

SHEL'DUCK, *n.* A species of wild duck.

SHELF, *n. plur.* *Shelves*. [Sax. *scylf*, whence *scylfan*, to shelve; Fr. *écueil*, a sand-bank.] 1. A platform of boards or planks, elevated above the floor, and fixed or set on a frame or contiguous to a wall, for holding vessels, utensils, books, and the like.—2. A sand-bank in the sea, or a rock or ledge of rocks, rendering the water shallow and dangerous to ships.—3. In *mining*, fast ground; that part of the internal structure of the earth which lies in an even, regular form.—To *put* or *lay* on the *shelf*, to put aside or out of use.

SHELF, *v. t.* To place on a shelf; to furnish with shelves. More usually written *Shelve*,—which *see*.

SHELFY, *a.* Full of shelves; abounding with sand-banks or rocks lying near the surface of the water, and rendering navigation dangerous; as, a *shelfy* coast.—2.† Hard; firm. [See SHELF, No. 3.]

SHELL, *n.* [Sax. *scyl*, *scyll*, *scell*, a shell, and *scæle*, a scale; G. *schale*; Fr. *ecaille*. The word primarily signifies that which is peeled or separated, as rind or the outer coat of plants, or their fruit; and as *shells* were used for dishes, the word came to signify a dish.

See SCALE.] 1. The hard or stony covering of certain fruits, and of certain animals; as, the *shell* of a nut; the *shell* of an oyster or lobster. The *shells* of animals are crustaceous or testaceous; crustaceous, as that of the lobster, and testaceous as that of the oyster and clam. That branch of natural history which treats of the nature, form, structure, classification, &c., of shells and shell-fish is termed *conchology*,—which *see*.—2. The hard covering of anything; particularly the outer coat of an egg.—3. The outer part of a house unfinished. We say of a building that wants the interior timbers or finishing, that it is a mere *shell*.—4. A coarser kind of coffin.—5. An instrument of music, like *testudo* in Latin; the first lyre being made, it is said, by drawing strings over a tortoise-shell.—6. The outer frame or case of a block.—7. Outer or superficial part; as, the shell of religion.—8. The handle of a fencing foil.—9. In *artillery*, a hollow sphere of iron, which being filled with gunpowder, and fired from a mortar, bursts into pieces by the explosion of the gunpowder, and produces very destructive effects. See BOMB.—*Fossil shells*, shells dug from the earth.

SHELL, *v. t.* To strip or break off the shell; or to take out of the shell; as, to *shell* nuts or almonds.

SHELL, *v. i.* To fall off, as a shell, crust, or exterior coat.—2. To cast the shell or exterior covering. Nuts *shell* in falling.

SHELL'-BARK, *n.* A species of hickory, (*Carya squamosa*), whose bark is loose and peeling. This species produces the most palatable nut.

SHELL'-BIT, *n.* A boring tool used with the brace in boring wood; it is shaped like a gongee, that is, its section is the segment of a circle, and when used it shears the fibres round the margin of the hole, and removes the wood almost as a solid core.

SHELL'ED, *ppr.* Deprived of the shell.

SHELL'-FISH, *n.* A testaceous mollusc, whose external covering consists of a shell; as, oysters, clams, &c.

SHELL'ING, *ppr.* Taking off the shell; casting the external hard covering; separating from the husk and falling.

SHELL'LAC, *n.* Seed-lac melted, and formed into thin cakes. [See LAC.]

SHELL'-MARL, *n.* A deposit of clay, and other substances mixed with shells, which collects at the bottom of lakes.

SHELL'-MEAT, *n.* Food consisting of shell-fish, or testaceous molluscs.

SHELLS, *n. pl.* The husks or envelopes of the cocoa bean, a decoction of which is used as a substitute for cocoa or chocolate.

SHELL'-WORK, *n.* Work composed of shells, or adorned with them.

SHELLY, *a.* Abounding with shells; as, the *shelly* shore.—2. Consisting of shells.

SHEL'TER, *n.* [Sw. *shyla*, to cover; Dan. *shiul*, a shed or cover, a *shelter*; *shiuler*, to hide, conceal, cloak; L. *celo*.] 1. That which covers or defends from injury or annoyance. A house is a *shelter* from rain and other inclemencies of the weather; the foliage of a tree is a *shelter* from the rays of the sun.

The healing plant shall aid,  
From storms a *shelter*, and from heat a shade. *Pope*.

2. The state of being covered and protected; protection; security.

Whointo *shelter* takes their tender bloom.  
Young.

3. He that defends or guards from danger; a protector; Ps. lxi.

SHEL'TER, *v. t.* To cover from violence, injury, annoyance, or attack; as, a valley sheltered from the north wind by a mountain.

Those ruins shelter'd once his sacred head.  
*Dryden.*

We besought the deep to shelter us.  
*Milton.*

2. To defend; to protect from danger; to secure or render safe; to harbour. What endless honour shall you gain, To save and shelter Troy's unhappy train?  
*Dryden.*

3. To betake to cover or a safe place. They sheltered themselves under a rock.  
*Abbot.*

4. To cover from notice; to disguise for protection. In vain I strove to check my growing flame, Or shelter passion under friendship's name.  
*Prior.*

SHEL'TER, *v. i.* To take shelter.

There the Indian herdsman, slumming heat, Shelters in cool.  
*Milton.*

SHEL'TERED, *pp.* or *a.* Covered from injury or annoyance; defended; protected.

SHEL'TERING, *ppr.* Covering from injury or annoyance; protecting.

SHEL'TERLESS, *a.* Destitute of shelter or protection; without home or refuge.

Now sad and shelterless perhaps she lies.  
*Rowe.*

SHEL'TERY, *a.* Affording shelter. [*Little used.*]

SHEL'TIE, *n.* A small but strong horse in Scotland; so called from Shetland, where it is produced.

SHELVE, *v. t.* (shelv.)† To place on a shelf or on shelves; to put aside or out of use.—2. To furnish with shelves.

SHELVE, *v. i.* (shelv.) [Sax. *scylfan*, to reel.] To incline; to be sloping.

SHELVES, *n. plur.* [See SHELF.] A general name given to any dangerous shallows, sand-banks, or rocks lying immediately under the surface of the water.

SHELV'ING, *ppr.* or *a.* Inclining; sloping; having declivity.

With rocks and shelving arches vaulted round.  
*Addison.*

SHELV'ING, *n.* The operation of fixing up shelves; materials for shelves.

SHELVY, *a.* Full of rocks or sand-banks; shallow; as, a shelvy shore. [See SHELFY.]

SHEMITE, *n.* A descendant of Shem. SHEMITIC, or SHEMIT'ISH, *a.* Pertaining to Shem, the son of Noah. The Shemitic languages are the Chaldee, Syriac, Arabic, Hebrew, Samaritan, Ethiopic, and Old Phœnician. [See SEMITIC.]

SHEMITISM, *n.* The system or peculiar forms of the Shemitic languages.

SHEND, *v. t.* pret. and *pp.* Shent. [Sax. *scendan*; D. *schenden*, to violate, spoil, slander, revile; G. *schänden*, to mar, spoil, disfigure, violate, abuse, debauch. This is from the root of *scandal*.] 1.† To injure, mar, or spoil.

That much I fear my body will be shent.  
*Dryden.*

2. To blame, reproach, revile, degrade, disgrace.

The famous name of knighthood foully shent.  
*Spenser.*

3.† To overpower or surpass. She pass'd the rest as Cynthia doth shent The lesser stars.  
*Spenser.*

SHENT, *pp.* Injured. [Obsolete, unless in poetry.]

SHEP'HERD, *n.* [Sax. *sccep-heard* or *hyrd*; *sheep* and *herd*.] 1. A man

employed in tending, feeding, and guarding sheep in the pasture.—2. A swain; a rural lover.—3. The pastor of a parish, church, or congregation; a minister of the gospel, who superintends a church or parish, and gives instruction in spiritual things. God and Christ are in Scripture denominated *Shepherds*, as they lead, protect, and govern their people, and provide for their welfare; Ps. xxiii. lxxx; John x. SHEP'HERDESS, *n.* A woman that tends sheep; hence, a rural lass. She put herself into the garb of a *shepherdess*.  
*Sidney.*

SHEP'HERDISH, *a.* Resembling a shepherd; suiting a shepherd; pastoral; rustic.

SHEP'HERDISM, *n.* Pastoral life or occupation.

SHEP'HERDLY, *a.* Pastoral; rustic.

SHEP'HERD'S DOG, *n.* The *canis domesticus*, Linn., distinguished by its rather pointed muzzle, convex forehead, erect or semi-erect ears, rather long pile, and moderate size. It stands at the head of the class of farm dogs. This breed of dogs is said to be preserved in the greatest purity in the northern part of Scotland, where its aid is highly necessary in managing the numerous herds of sheep in those extensive wilds.

SHEP'HERD'S NEE'DLE, *n.* A plant of the genus *Scandix*, the *S. pecten veneris*, or *Venus's comb*. [See SCANDIX.]

SHEP'HERD'S PURSE, *n.* Capsella, a genus of plants of the class Tetrady-namia, and order Siliculosa, Linn.; nat. order Crucifera. It is distinguished by its siliques being emarginate at the apex, with the valves winged at the back; the petals are equal, the pedicels bractless, and the flowers are white. *C. bursa pastoris*, common Shepherd's purse, grows plentifully by waysides.

SHEP'HERD'S ROD, } *n.* A plant of SHEP'HERD'S STAFF, } the genus *Dipsacus*, the *D. pilosus*; called also small teasel.

SHERAR'DIA, *n.* A genus of plants. [See FIELD-MADDER.]

SHER'BET, *n.* [Pers. *sharbat*. This word, as well as *sirup* and *shrub*, L. *sorbeo*, and Fr. *sorbet*, is from the Ar. *sharaba*, to drink, to imbibe.] A drink composed of water, lemon-juice, and sugar, sometimes with perfumed cakes dissolved in it, with an infusion of some drops of rose-water. Another kind is made with violets, honey, juice of raisins, &c. It is a favourite beverage in the East.

SHERD, *n.* A fragment, as a *pot-sherd*. Sherdis usually written *Shard*,—*whicli see*. *Sherds*, fragments of potting employed by gardeners to drain their flower-pots.

SHER'IFF, *n.* [Sax. *scir-gerefa*; *scyre*, *scire*, a shire or division, and *gerefa*, a reeve, a count, prefect, bailiff, provost, or steward; G. *graf*, D. *graaf*.] In Eng., an officer appointed in each county by the crown, to execute process, preserve the peace, and give assistance to justices, and others in doing so. During his office, which is but for a year, he is the first man in his county, and has at his disposal the whole civil force of that county, so as to enable him to preserve the peace. He only executes in person such parts of his office as are either purely honorary, or are of some dignity and public importance, his other functions being performed by a deputy or under sheriff,

for whose conduct he is responsible. The sheriffs of London and Middlesex, are chosen by the citizens of London. In Scotland, the sheriff is the chief local judge of a county. He is properly sheriff depute, the principal sheriffship being a mere nominal office. He is nominated by the crown, and holds his office *ad vitam aut culpam*. He is entitled to appoint sheriff substitutes, executes writs, returns juries, &c., decides on claims for enrolment in the county lists of parliamentary voters, and exercises a certain criminal jurisdiction. He holds also civil courts for the recovery of small debts, and a court of record, the jurisdiction of which extends to all personal actions, and possessory actions for the recovery of real property.—*Sheriff clerk*, the clerk to the sheriff's court.—*Sheriff in that part*, a person appointed by the sovereign in signet letters, to supply the place of the sheriff. He was termed the sheriff in that part, from being appointed to execute a particular duty which previously had been in use to be performed by the sheriff. By uniform and immemorial custom, all the diligences of the law are directed to messengers-at-arms as *sheriffs in that part*.

SHER'IFFALTY, } *n.* The office or ju-SHER'IFFDOM, } risdiction of a she-SHER'IFFSHIP, } riff. These words SHER'IFFWICK, } are now rarely used. [See SHIREVALTY, the word now in use.]

SHER'RIFFE, } *n.* The title of a de-SHER'IF, } scendant of Moham-SCHER'IF, } med by Hassan Ibn Ali. [See SCHERIF.]

SHER'NIS SACK,† } *n.* Sherry. SHER'RY SACK,† }

SHER'RY, *n.* [sometimes written *Sher-ris*.] A species of wine; so called from Xeres in Spain, where it is made. Genuine sherry is a rich dry wine, containing from 20 to 23 per cent. of alcohol; there are many varieties, and it is extensively imitated and adulterated.

SHEUGH, or SEUCH, *n.* A furrow; a ditch; a gulf. [Scotch.]

SHEW, SHEW'ED, SHEWN. See SHOW, SHOWN, SHOWN.

SHEW-BREAD. See SHOW-BREAD.

SHEWER, *n.* One that shows. [See SHOWER.] Shewers in *Scots law*, in jury causes, are the persons named by the court, usually on the suggestion of the parties, to accompany the six jurors when a view is allowed. [See VIEWERS.]

SHEW'ING. See SHOWING.

SHIB'BOLETH, *n.* [Heb. an ear of corn, or a stream of water.] 1. A word which was made the criterion by which to distinguish the Ephraimites from the Gileadites. The Ephraimites not being able to pronounce the letter *v* sh, pronounced the word *sibboleth*; See Judges xii. Hence,—2. The criterion of a party; or that which distinguishes one party from another; and usually, some peculiarity in things of little importance.

SHIDE, *n.* [Sax. *sceadan*, to divide.] A piece split off; a cleft; a piece; a billet of wood; a splinter. [Local in England.]

SHIE, or SHY, *v. t.* To throw; as to shie a stone. [Familiar.]

SHIELD, *n.* [Sax. *scyld*; D. and G. *schild*.] This word is from covering, defending, Sw. *shylda*, to cover; or from separating, Sax. *scylan*, Dan. *skiller*, to separate. Protection is deduced from either, and indeed both may be radically

one. See *SHIELTER*. The *L. scutum* coincides in elements with the *Sax. sceadan*, to separate, and *clupeus* with the *Gr. κλυπείων*, to cover.] 1. A broad piece of defensive armour; a buckler; used in war for the protection of the body. The shields of the ancients were of different shapes and sizes, triangular, square, oval, &c., made of leather, or wood covered with leather, and borne on the left arm. This species of armour was a good defence against arrows, darts, spears, &c., but would be no protection against bullets.—2. Defence; shelter; protection; or the person that defends or protects; as a chief, the ornament and shield of the nation.

Fear not, Abram; I am thy shield, and thy exceeding great reward; Gen. xv. 3. In *her.*, the escutcheon or field on which are placed the bearings in coats of arms. The shape of the shield upon which heraldic bearings are displayed is left to fancy; the form of the lozenge, however, is preserved for single ladies and widows. The shield used in funeral

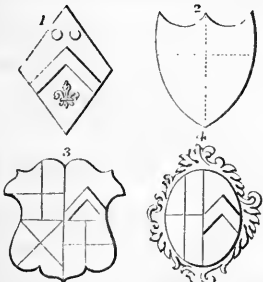

1. Lozenge Shield. 2. Norman Shield. 3, 4. Fanciful variations of the Shield.

processions is of a square form, something larger than the escutcheon, and divided per pale, the proper half being sable, or the whole black, as the case may be, with a scroll border around, and in the centre the arms of the deceased upon a shield of the usual form. *Shields* in *bot.*, little coloured cups or lines with a hard disc, surrounded by a rim, and containing the fructification of lichens.

**SHIELD**, *v. t.* To cover, as with a shield; to cover from danger; to defend; to protect; to secure from assault or injury.

To see the son the vanquish'd father shield.  
*Dryden.*  
Hear one that comes to shield his injur'd honour.  
*Smith.*

2. To ward off; to defend against; as, clothes to shield one from cold.

**SHIELDED**, *pp.* Covered, as with a shield; defended; protected.

**SHIELD FERN**, *n.* *Aspidium*, a genus of Cryptogamian plants belonging to the nat. order Polypodiaceæ, and so named from the form of the indusium of the fructification. The sori are roundish and scattered, or deposited in ranks; the endusia solitary, roundly-peltate, or kidney-shaped, fixed by the middle or the edge. The species are numerous, and among the most beautiful of all the fern tribes. Thirteen are natives of Britain, among which is the malesield-fern, (*A. filix-mas*), the stem of which has been employed as an anthelmintic, and as an emmenagogue and purgative. Fragrant shield-fern (*A. fragrans*), has been employed as a substitute for tea.

**SHIELDING**, *ppr.* Covering, as with a shield; defending from attack or injury; protecting.

**SHIELDLESS**, *a.* Destitute of a shield or of protection.

**SHIELDLESSLY**, *adv.* Without protection.

**SHIELDLESSNESS**, *n.* Destitution of a shield or of protection.

**SHIFT**, *v. i.* [*Sax. scyftan*, to order or appoint, to divide or distribute, also to verge or decline, also to drive; *D. schiften*, to divide, distinguish, part, turn, discuss; *Dan. skifte*, a parting, sharing, division, lot, share; *shifter*, to part, share, divide; *Sw. skifta*, to shift, to distribute. This verb is apparently from the same root as *shiver*; *Dan. shifer sig*, to shiver; *Sw. skifta om*, to change. The primary sense is to move, to depart; hence to separate. We observe by the Swedish, that *skifta om*, [om about or round,] was originally the true phrase, to move about or round, and we still say, to shift about.] 1. To move; to change place or position. Vegetables are not able to shift and seek nutriment.—2. To change its direction; to vary; as, the wind shifted from south to west.—3. To change; to give place to other things.—4. To change dress, particularly the under garment or chemise.—5. To resort to expedients for a livelihood, or for accomplishing a purpose; to move from one thing to another, and seize one expedient when another fails.

Men in distress will look to themselves, and leave their companions to shift as well as they can.  
*L' Etrange.*

6. To practise indirect methods.—7. To seek methods of safety.

Nature teaches every creature how to shift for itself in cases of danger.

*L' Etrange.*

8. To change place; as, a cargo shifts from one side to the other.

**SHIFT**, *n. t.* To change; to alter; as, to shift the scenes.—2. To transfer from one place or position to another; as, shift the helm; shift the sails.—3. To put out of the way by some expedient.  
*I shifted him away. Shak.*

4. To change, as clothes; as, to shift a coat.—5. To dress in fresh clothes, particularly fresh linen. Let him have time to shift himself.—To shift about, to turn quite round, to a contrary side or opposite point.—To shift off, to delay; to defer; as, to shift off the duties of religion.—2. To put away; to disengage or disencumber one's self, as of a burden or inconvenience.

**SHIFT**, *n.* A change; a turning from one thing to another; hence, an expedient tried in difficulty; one thing tried when another fails.

I'll find a thousand shifts to get away.  
*Shak.*

2. In a bad sense, mean refuge; last resource.

For little souls on little shifts rely.

*Dryden.*

3. Fraud; artifice; expedient to effect a bad purpose; or, an evasion; a trick to escape detection or evil.—4. A woman's under garment; a chemise.—5. In music, the motion of the hand along the finger-board of a violin, violoncello, &c., necessary in the execution of passages, the notes of which, in point of gravity or acuteness, lie at a considerable distance from each other.—Shift of crops, in agriculture, an alteration or variation in the succession of crops.

**SHIFT'ED**, *pp.* Changed from one place or position to another.

**SHIFTER**, *n. i.* One that shifts or changes; as, scene-shifter.—2. One that plays tricks or practises artifice.—3. In ships, a person employed to assist the ship's cook in washing, steeping, and shifting the salt provisions.

**SHIFTING**, *ppr.* Changing place or position; resorting from one expedient to another.—*Shifting beach*, a beach of gravel liable to be shifted or moved by the action of the sea, or the current of rivers.

**SHIFTING**, *n.* Act of shifting.

**SHIFTINGLY**, *adv.* By shifts and changes; deceitfully.

**SHIFT'LESS**, *a.* Destitute of expedients, or not resorting to successful expedients; wanting means to act or live; as, a shiftless fellow.

**SHIFTL'LESSLY**, *adv.* In a shiftless manner.

**SHIFT'LESSNESS**, *n.* A state of being shiftless.

**SHY'ITES**, *n. pl.* [Heretics, from *shiah*, heresy.] That class of the Mahomedans to which the Persians belong. They reject the three first caliphs, and consider Ali as being the only rightful successor of Mahomed. They do not acknowledge the Sunna, or body of traditions respecting Mahomed, as any part of the law, and on these accounts are treated as heretics by the Sunnites, or orthodox Mahomedans.

**SHILF**, *n.* [*G. schiff*, sedge.] Straw.

**SHILL**, *† v. t.* To put under cover; to steal.

**SHIL'LING**, *n.* [*Sax. scill*, scilling; *G. schilling*; *D. schelling*; *Sw. and Dan. skilling*; *Fr. escabin*; from the oriental *שש* shahal, to weigh. See *SNEKEL*.] An English silver coin equal to twelve pence, or the twentieth part of a pound. The English shilling, or shilling sterling, is equivalent nearly to 22 cents 22 hundredths, money of the United States. Among the ancient Saxons, the value of the shilling was only 5d. It afterwards underwent many alterations, containing sometimes 16d. and often 20d. The period when it attained its present value is assigned to the reign of Edward I.

**SHIL'LY-SHAL'LY**, *n.* [*Russ. shalyu*, to be foolish, to play the fool, to play wanton tricks.] Foolish trifling; irresolution. [*Vulgar.*] To stand shilly-shally-*ing*, is to stand hesitating. [This word has probably been written *Shill-I-Shall-I*, from an ignorance of its origin.]

**SHILOH**, *n.* [*Heb. שילוש*, shiloh, differently rendered, Son, He who is sent, or the Sent, the Peaceable, or the Prosperous.] The name given to the Messiah by Jacob in his prophecy; Gen. xlix. 10.  
**SHILY**. See *SHILLY*.

**SHIM'MER**, *† v. i.* [*Sax. scymrian*; *G. schimmern*.] To gleam; to glisten.

**SHIN**, *n.* [*Sax. scina*, *scyne*, *shin*, and *scinban*, shin-bone; *G. schiene*, *schienebeln*.] The fore part of the leg, particularly of the human leg; the fore part of the crural bone, called *tibia*. This bone being covered only with skin, may be named, from that circumstance, *shin-bone*; or it may be formed from the root of *chine*, edge.

**SHINE**, *v. i.* pret. *Shined* or *Shone*; pp. *Shined* or *Shone*. [*Sax. scinan*; *G. scheinen*. If *s* is a prefix, this word accords with the root of *L. canus*, *cameo*; *W. can*, white, bright. See *CANT*.] 1. To emit rays of light; to give light; to beam with steady radiance; to ex-

hibit brightness or splendour; as, the sun *shines* by day; the moon *shines* by night. *Shining* differs from *sparkling*, *glistening*, *glittering*, as it usually implies a steady radiation or emission of light, whereas the latter words usually imply irregular or interrupted radiation. This distinction is not always observed, and we may say, the fixed stars *shine*, as well as that they *sparkle*. But we never say, the sun or the moon *sparkles*.—2. To be bright; to be lively and animated; to be brilliant.

Let thine eyes *shine* forth in their full lustre. *Denham*.

3. To be unclouded; as, the moon *shines*.—4. To be glossy or bright, as silk. Fish with their fins and *shining* scales.

*Milton*.

5. To be gay or splendid.

So proud she *shined* in her princely state.

*Spenser*.

6. To be beautiful.

Once bright *shin'd* this child of heat and air.

*Pope*.

7. To be eminent, conspicuous, or distinguished; as, to *shine* in courts; Phil. ii.

Few are qualified to *shine* in company.

*Swift*.

8. To give light, real or figurative.

The light of righteousness hath not *shined* to us.

*Wisdom*.

9. To manifest glorious excellences; Ps. lxxx.—10. To be clearly published; Is. ix.—11. To be conspicuously displayed; to be manifest.

Let your light so *shine* before men; Matth. v.

To *cause the face to shine*, to be propitious; Num. vi; Ps. lxvii.

**SHINE**, *n.* Fair weather.

Be it fair or foul, rain or *shine*. *Dryden*.

2. Brightness; splendour; lustre; gloss. The glittering *shine* of gold.

*Decay of Piety*.

Fair opening to some court's propitious *shine*. [Not elegant.] *Pope*.

**SHINE**, *n.* A tool used in tillage to break down the land, or to cut it up and clear it of weeds.

**SHIN'NESS**. See **SHYNESS**.

**SHIN'GLE**, *n.* [G. *schindel*; Gr. *σχινοειδής*; L. *scindula*, from *scindo*, to divide, G. *scheiden*.] 1. A wooden tile. Shingles are small pieces of thin wood used like slates for covering a roof or building. They are from eight to twelve inches long, and about four inches broad, thicker on one edge than the other.—2. Round, water-worn, and loose gravel and pebbles. The coarse gravel or accumulation of small rounded stones found on the shores of rivers or the sea.

The plain of La Crau, in France, is composed of *shingle*. *Pinkerton*.

**SHIN'GLE**, *v. t.* To cover with shingles; as, to *shingle* a roof.—2. To perform the process of shingling; as, to *shingle* iron.

**SHIN'GLED**, *pp.* Covered with shingles. **SHIN'GLE-ROOFED**, *a.* Having a roof covered with shingles.

**SHIN'GLES**, *n.* [L. *cingulum*.] A kind of herpes, viz., Herpes zoster, which spreads around the body like a girdle; an eruptive disease.

**SHIN'GLING**, *pp.* Covering with shingles.

**SHIN'GLING**, *n.* The process of making a roof with shingles.—2. In iron manufacture, the process of expelling the scoriae and other impurities from the metal in its conversion from the cast to the malleable state. This operation

is performed by subjecting the puddled iron either to the blows of a ponderous forge hammer, to the action of squeezers, or to the pressure of rollers. [See **PUNDDLING** and **ROLLING MILL**.]

**SHIN'GLY**, *a.* Abounding with gravel or shingle.

**SHINING**, *pp.* Emitting light; beaming; gleaming.—2. *a.* Bright; splendid; radiant.—3. Illustrious; distinguished; conspicuous; as, a *shining* example of charity.—*Shining stem*, one whose surface is polished, so as strongly to reflect the light; as in *Hippuris vulgaris*.

**SHINING**, *n.* Effusion or clearness of light; brightness; 2 Sam. xxiii.

**SHININGNESS**, *n.* Brightness; splendour.

**SHIN'LOG**, *n.* The brick building by which the mouth of a brick kiln is closed.

**SHINY**, *a.* Bright; luminous; clear; unclouded.

Like distant thunder on a *shiny* day.

*Dryden*.

**SHIP**, as a termination, denotes state or office; as in *lordship*.

**SHIP**. See **SHAPE**.

**SHIP**, *n.* [Sax. *scip*, *scyp*; D. *schip*; G. *schiff*; L. *scapha*; from the root of *shape*; Sax. *scæpian*, *scippan*, *scyppan*, to create, form, or build.] In a general sense, a vessel or building of a peculiar structure, adapted to navigation, or floating on water by means of sails. In an appropriate sense, a building of a structure or form fitted for navigation, furnished with a bowsprit and three masts, a main-mast, a fore-mast, and a mizen-mast, each of which is composed of a lower-mast, a top-mast, and top-gallant-mast, and square rigged.

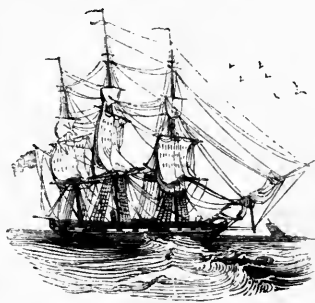

Ship.

Ships are of various sizes, and fitted for various uses, and receive various names, as man of war ships, [see **NAVY**], frigates, merchantmen, brigs, schooners, luggers, sloops, rebees, galleys, &c.—2. *Armed ship*, in the English usages of war, a private vessel occasionally taken into the service of government in time of war, armed and equipped like a regular ship of war, and commanded by an officer of the navy with the rank of master and commander.—*Ship's papers*, the papers or documents required for the manifestation of the property of the ship and cargo. They are of two sorts: viz., 1st. Those required by the law of a particular country, as the certificate of registry, license, charter-party, bills of lading, bills of health, &c., required by the law of England to be on board British ships. 2d. Those required by the law of nations to be on board neutral ships to vindicate their title to that character.—*Registry of ships*, in commercial navigation, the registration or enrolment of ships at the

custom-house, so as to entitle them to be classed among, and to enjoy the privileges of, British built ships. [See **REGISTER ACTS**.]—*Ship's husband*, in Scotland, the person whose duty it is to arrange every thing for the outfit and repair of the ship, to enter into the contract of affreightment, and superintend the papers of the ship.

**SHIP**, *v. t.* [Sax. *scipian*.] 1. To put on board of a ship or vessel of any kind; as to *ship* goods at Glasgow for New York.—2. To transport in a ship; to convey by water.

The sun no sooner shall the mountains touch,

But we will *ship* him hence. *Shak.*

3. To engage for service on board a ship or other vessel; as, to *ship* seamen.

—4. To receive into a ship or vessel; as, to *ship* a sea.—*To ship the oars*, to place them in the rowlocks.—*To ship the tiller*, to place it on the head of the rudder.—*To ship off*, to send away by water; as, to *ship off* convicts.

**SHIP**, *v. i.* To engage for service on board a ship.

**SHIPBOARD**, *adv.* [*ship* and *board*.]

To go on *shipboard* or a *shipboard* is to go aboard; to enter a ship; to embark; literally, to go over the side. It is a peculiar phrase, and not much used. Seamen say, to go aboard or on board.—*To be on shipboard*, to be in a ship; but seamen generally say, *aboard* or *on board*.—2. *n.* The plank of a ship; Ezek. xxvii.

**SHIP'-BOY**, *n.* [*ship* and *boy*.] A boy that serves on board of a ship.

**SHIP'-BRÖKER**, *n.* A broker who procures insurance on ships.

**SHIP'-BUILDER**, *n.* [*ship* and *builder*.]

A man whose occupation is to construct ships and other vessels; a naval architect; a shipwright.

**SHIP'-BUILDING**, *n.* [*ship* and *build*.] Naval architecture; the art of constructing vessels for navigation, particularly ships and other vessels of a large kind, bearing masts; in distinction from *boat-building*.

**SHIP'-CAPTAIN**, *n.* The commander or master of a ship. [See **CAPTAIN**.]

**SHIP'-CARPENTER**, *n.* A shipwright; a carpenter that works at ship-building.

**SHIP'-CHÄNDLER**, *n.* [*ship* and *chandler*, G. *handler*, a trader or dealer.] One who deals in cordage, canvas, and other furniture of ships.

**SHIP'-HOLDER**, *n.* [*ship* and *hold*.] The owner of a ship, or of shipping.

**SHIP'LESS**, *a.* Destitute of ships.

**SHIP'MAN**, *n.* [*ship* and *man*.] A seaman or sailor; 1 Kings ix; Acts xxviii.

**SHIP'MÄSTER**, *n.* [*ship* and *master*.] The captain, master, or commander of a ship; Jonah i.

**SHIP'MATE**, *n.* [*ship* and *mate*.] One who serves in the same ship with another.

**SHIP'MENT**, *n.* The act of putting any thing on board of a ship or other vessel; embarkation; as, he was engaged in the *shipment* of coal for London.—2. The goods or things shipped, or put on board of a ship or other vessel. We say, the merchants have made large *shipments* to the United States.

**SHIP'-MONEY**, *n.* [*ship* and *money*.]

In *English hist.*, an imposition formerly charged on the ports, towns, cities, boroughs, and counties of England, for providing and furnishing certain ships for the king's service. This imposition being laid by the king's writ



under the great seal, without the consent of parliament, was held to be contrary to the laws and statutes of the realm, and abolished by stat. 17 Car. II.

SHIP-OWNER, *n.* The owner of a ship or ships.

SHIP'PED, *pp.* Put on board of a ship or vessel; received on board.

SHIP'PEN, *n.* [Sax. *scipen.*] A stable; a cow-house. [Local.]

SHIP'PER, *n.* One who places goods on board a vessel for transportation.

SHIP'PING, *ppr.* Putting on board of a ship or vessel; receiving on board.—2. *a.* Relating to ships; as *shipping* concerns.

SHIP'PING, *n.* Ships in general; ships or vessels of any kind for navigation. The *shipping* of the English nation exceeds that of any other.—*Shipping articles*, articles of agreement between the captain of a vessel and the seamen on board, in respect to the amount of wages, length of time for which they are shipped, &c.—*To take shipping*, to embark; to enter on board a ship or vessel for conveyance or passage; John vi.

SHIP-SHAPE, *adv.* In a seamanlike manner, or after the fashion of a ship; as, the mast is not rigged *ship-shape*; trim your sails *ship-shape*.

SHIP-WORM, *n.* The *Teredo navalis*, Linn.; a testaceous mollusc which is very destructive to ships, piles, and all submarine wood-works. The ravages of this mollusc at one time threatened Holland with submersion by the destruction of its dykes. It swarms in our seas, but is supposed to have been imported originally from a warm climate.

SHIP WRECK, *n.* [*ship* and *wreck.*] The destruction of a ship or other vessel by being cast ashore or broken to pieces by beating against rocks and the like. *Shipwreck* on the open sea, is the loss of a vessel, from the water leaking in at the bottom faster than the pumps can discharge it; or from the sea coming over one of the decks, and getting below in great quantity; or from the vessel being upset by the wind.—2. The parts of a shattered shipwreck. [Unusual.]—3. Destruction; miscarriage.—*To make shipwreck concerning faith*, is to apostatize from the love, profession, and practice of divine truth which had been embraced; 1 Tim. i.

SHIP WRECK, *v. t.* To destroy by running ashore or on rocks or sandbanks. How many vessels are annually *shipwrecked* on the Bahama rocks!—2. To suffer the perils of being cast away; to be cast ashore with the loss of the ship. The *shipwrecked* mariners were saved.

SHIP WRECKED, *pp.* Cast ashore; dashed upon the rocks or banks; destroyed.—2. Thrown or cast into distress or difficulty, as by a shipwreck.

SHIP WRIGHT, *n.* [*ship* and *wright.* See WORK.] One whose occupation is to construct ships; a builder of ships or other vessels.

SHIRE, *n.* [Sax. *scir*, *scire*, *scyre*, a division, from *sciran*, to divide. See SHARE and SHEAR.] It is pronounced in compound words, *shir*, as in *Hampshire*, *Berkshire*.] In England, a division of territory, otherwise called a county, but some smaller districts in the north of England retain the provincial appellation of shires; as Rich-

mondshire in the North Riding of Yorkshire, Hallamshire, or the manor of Hallam, in the West Riding, which is nearly co-extensive with the parish of Sheffield. The *shire* was originally a division of the kingdom under the jurisdiction of an earl or count, whose authority was intrusted to the *sheriff*; [*shire-reeve.*] On this officer the government ultimately devolved. The English county members of the House of Commons are called *knights of the shire*. [See COUNTY.]

SHIRE CLERK, *n.* In England, an officer appointed by the sheriff to assist in keeping the county court.

SHIRE-MOTE, } *n.* [Sax. *scyr-gemote*,  
SHIRE-GEMOT, } *shire-meeting.*]—Anciently, in England, the county court; sheriff's town or court.

SHIRK, *v. t. or i.* To avoid or get off from; to slink away.

SHIRK, *n.* One who seeks to avoid duty; one who lives by shifts or tricks. [See SHARK.] [Both familiar.]

SHIRL, a different spelling of *Shorl*. [See SHORL.]

SHIRLEY, *n.* A bird, by some called the greater bullfinch; having the upper part of the body of a dark brown, and the throat and breast red.

SHIR'RED, *a.* An epithet applied to articles having lines or cords inserted between two pieces of cloth, as the lines of India rubber in men's braces.

SHIRT, *n.* (shurt.) [Dan. *skiorte*, Sw. *skiorta*, a shirt; Dan. *skiort*, a petticoat; Ice. *scyrta*. This word seems to be named from its *shortness* or cutting off, and might have signified originally a somewhat different garment *shortened*; Sax. *scyrst*, short, L. *curtus*.] A loose garment of linen, cotton, or other material, worn by men and boys under the outer clothes.

SHIRT, *v. t.* (shurt.) To cover or clothe, as with a shirt.—2. To change the shirt and put on a clean one.

SHIRT'ING, } *ppr.* Covering with a shirt.

SHIRT'ING, *n.* Cloth for shirts.

SHIRTLESS, *a.* (shurt'less.) Wanting a shirt.

SHIST, } *n.* A species of argilla-  
SHIST'US, } ceous earth or slate; clay  
slate. [See SCHIST.]

SHIST'OSE, } *a.* Pertaining to shist, or  
SHIST'OUS, } partaking of its pro-  
SHIST'IC, } perties.

SHIT'TAH, } *n.* In Scripture, a sort of  
SHIT'TIM, } precious wood, of which the tables, altars, and boards of the tabernacle were made among the Jews.



Shittim wood (Acacia vera).

The wood is said to be hard, tough, and smooth, and very beautiful. It is thought that the shittim of Scripture is a species of *Acacia*, probably the

*A. vera*, or *A. seyal*, which grows abundantly in Upper Egypt, in the mountains of Sinai, and in the deserts. It is of the size of a large mulberry tree.

SHIT'TLE, } *a.* [See SNOOT.] Waver-  
SHIT'TLE-CK, } ing; unsettled;

SHIT'TLENESS, } *n.* Unsettledness;  
inconstancy.

SHIVE, *n.* (shiv.) [D. *schyf*; G. *scheibe*. If *s* is a prefix, this word agrees radically with *chip*.] 1. A slice; a thin cut; as a *shive* of bread.—2. A thin flexible piece cut off.—3. A little piece or fragment; as, the *shives* of flax made by breaking.

SHIVER, *n.* [G. *schiefer*, a splinter, slate; *schiefeln*, to shiver, to scale; Dan. *shive*, Sw. *shifva*, a slice; Dan. *shifer*, *shiver*, a slate; *shifer*, *sig*, to shiver, peel, or split.] 1. In *min.*, a species of blue slate; shist; shale.—2. In *seamen's lan.*, a little wheel; a sheave.

SHIVER, *v. t.* [supra. Qu. Heb. שָׁבַר, *shabar*, to break into pieces.] To break into many small pieces or splinters; to shatter; to dash to pieces by a blow. The ground with *shiver'd* armour strown. Milton.

SHIV'ER, *v. i.* To fall at once into many small pieces or parts.

The natural world, should gravity once cease, would instantly *shiver* into millions of atoms. Woodward.

2. To quake; to tremble; to shudder; to shake, as with cold, ague, fear or horror.

The man that *shiver'd* on the brink of sin. Dryden.

Prometheus is laid  
On icy Caucasus to *shiver*. Swift.

3. To be affected with a thrilling sensation, like that of chilliness.

Any very harsh noise will set the teeth on edge, and make all the body *shiver*. Bacon.

4. In *marine lan.*, a term used in speaking of a sail when it shakes or flutters in the wind, as being neither full nor aback, but in a medium between both, as well with regard to its absolute position, as to its relative effect on the vessel.

SHIVER, *n.* A small piece or fragment into which a thing breaks by any sudden violence.

He would pound thee into *shivers* with his fist, as a sailor breaks a biscuit. Shak.

2. A shaking fit.

SHIVERED, *pp.* Broken or dashed into small pieces.

SHIVERING, *ppr.* Breaking or dashing into small pieces.—2. Quaking; trembling; shaking, as with cold or fear.

SHIVERING, *n.* The act of breaking or dashing to pieces; division; severance.—2. A trembling; a shaking with cold or fear.

SHIVERINGLY, *adv.* With shivering, or slight trembling.

SHIVER-SPÄR, *n.* [G. *schiefer-spath.*] A carbonate of lime, so called from its slaty structure; called also *slate-spar*.

SHIV'ERY, *a.* Easily falling into many pieces; not firmly cohering; incompact; as, *shiv'ery* stone.

SHOÄD, *n.* Among *miners*, a train of metallic stones which serves to direct them in the discovery of mines.

SHOÄD-STONE, *n.* A small stone, or

fragment of ore, made smooth by the action of water passing over it.

**SHOAL**, *n.* [Sax. *sceol*, a crowd. It should rather be written *Shole*.] 1. A great multitude assembled; a crowd; a throng; as, *shoals* of people. Immense *shoals* of herring appear on the coast in summer.

The vices of a prince draw *shoals* of followers. *Devey of Piety.*

2. A place where the water of a river, lake, or sea is shallow or of little depth; a sand-bank or bar; a shallow. The entrance of rivers is often rendered difficult or dangerous by *shoals*.

**SHOAL**, *v. i.* To crowd; to throng; to assemble in a multitude. The fishes *shoaled* about the place.—2. To become more shallow. The water *shoals* as we approach the town.

**SHOAL**, *a.* Shallow; of little depth; as, *shoal* water.

**SHOALINESS**, *n.* [from *shoaly*.] Shallowness; little depth of water.—2. The state of abounding with shoals.

**SHOALY**, *a.* Full of shoals or shallow places.

The tossing vessel sail'd on *shoaly* ground. *Dryden.*

**SHOAR**, *n.* A prop. [See **SHORE**.]

**SHOAT**, *n.* A young hog. [See **SHOTE**.]

**SHOCK**, *n.* [D. *schock*, a bounce, jolt, or leap; Fr. *choc*, a striking or dashing against. See **SHAKE**.] 1. A violent collision of bodies, or the concussion which it occasions; a violent striking or dashing against.

The strong unshaken mounds resist the *shocks*

Of tides and seas. *Blackmore.*  
2. Violent onset; conflict of contending armies or foes.

He stood the *shock* of a whole host of foes. *Addison.*  
3. External violence; as the *shocks* of fortune.—4. Offence; impression of disgust.

Fewer *shocks* a statesman gives his friend. *Young.*

5. In *electricity*, the effect on the animal system of a discharge of the fluid from a charged body.—6. A pile of sheaves of wheat, rye, &c.; a stook or buttock.—*Shocks* are assemblages of sheaves set together on their ends, consisting of never more than ten sheaves in those places where the tithes is paid in kind. In *Scot.*, a *shock* consists of from ten to twelve sheaves, independently of the two or four hood or roof sheaves. And cause it on *shocks* to be by and by set. *Tusser.*

Behind the master walks, builds up the *shocks*. *Thomson.*

7. A dog with long rough hair or shag. [from *shag*.]

**SHOCK**, *v. t.* [D. *schokken*; Fr. *choquer*.] 1. To shake by the sudden collision of a body.—2. To meet force with force; to encounter.—3. To strike, as with horror or disgust; to cause to recoil, as from something odious or horrible; to offend extremely; to disgust. I was *shocked* at the sight of so much misery. Avoid every thing that can *shock* the feelings of delicacy.

Advise him not to *shock* a father's will. *Dryden.*

4. To make up *shocks* of corn.

**SHOCK**, *v. i.* To collect sheaves into a pile; to pile sheaves.

**SHOCKED**, *pp.* Struck, as with horror; offended; disgusted.—2. Piled, as sheaves.

**SHOCK-HEADED**, *a.* Having a thick and bushy head of hair.

**SHOCK'ING**, *ppr.* Shaking with sudden violence.—2. Meeting in onset or violent encounter.

And now with shouts the *shocking* armies clos'd. *Pope.*

3. *a.* Striking, as with horror; causing to recoil with horror or disgust; extremely offensive or disgusting.

The French humour. is very *shocking* to the Italians. *Addison.*

**SHOCK'ING**, *n.* In *agriculture*, the operation of setting up sheaves of corn, &c., on their ends in pairs leaning against each other. This, in *Scotland*, is called *stooking*. [See **SHOCK**.]

**SHOCK'INGLY**, *adv.* In a manner to strike with horror or disgust.

**SHOCK'INGNESS**, *n.* The state of being shocking.

**SHOD**, for *Shoed*, *pret.* and *pp.* of *Shoe*.

**SHOD'DY**, *n.* Old woollen rags torn up by machinery, and mixed with fresh but inferior wool, to be re-spun and made into cheap cloth, table-covers, &c.

**SHOD'DY**, *a.* Made of shoddy; as, *shoddy* cloth. The *shoddy* trade is chiefly located at Dewsbury, in Yorkshire.

**SHODE**, † *n.* A bush of hair; the head.

**SHÖE**, *n. plur. Shoes*. [Sax. *sceo*, *sceog*; G. *schuh*; Dan. *shoe*, a shoe; *skoer*, to bind with iron, to shoe. It is uncertain to what this word was originally applied, whether to a band of iron, or to something worn on the human foot. It is a contracted word. In G. *handschuh*, hand-shoe, is a glove. The sense is probably a cover, or that which is put on.] 1. A covering for the foot, usually of leather, composed of a thick species for the sole, and a thinner kind for the vamp and quarters. Shoes for ladies often have some species of cloth for the vamp and quarters.—2. A plate or rim of iron nailed to the hoof of a horse to defend it from injury; also, a plate of iron for an ox's hoof, one for each division of the hoof.—3. The plate of iron which is nailed to the bottom of the runner of a sleigh, or any vehicle that slides on the snow in winter.—4. A piece of timber fastened with pins to the bottom of the runners of a sledge, to prevent them from wearing.—5. Something in form of a shoe.—6. A cover for defence.—7. The inclined piece at the bottom of a water-trunk or lead pipe for turning the course of the water, and discharging it from the wall of a building.—8. An iron socket used in timber framing to receive the foot of a rafter or the end of a strut.—*Shoe of an anchor*, a small block of wood, convex on the back, with a hole to receive the point of the anchor fluke; used to prevent the anchor from tearing the planks of the ship's bow, when raised or lowered.

**SHÖE**, *v. t.* *pret.* and *pp.* *Shod*. To furnish with shoes; to put shoes on; as, to *shoe* a horse.—2. To cover at the bottom.—To *shoe an anchor*, to cover the flukes with a broad triangular piece of plank whose area is larger than that of the fluke. This is intended to give the anchor a stronger hold in soft grounds.

**SHÖEBLACK**, *n.* [*shoe* and *blach*] A person that cleans shoes.

**SHÖEBLACKER**, *n.* Same as *shoeblack*.

**SHÖEBOY**, *n.* [*shoe* and *boy*.] A boy that cleans shoes.

**SHÖEBUCKLE**, *n.* [*shoe* and *buckle*.] A buckle for fastening the shoe to the foot.

**SHÖEING**, *ppr.* Putting on shoes.

**SHÖEING-HORN**, or **SHÖE-HORN**, *n.* [*shoe* and *horn*.] A horn used to facilitate the entrance of the foot into a narrow shoe.—2. Any thing by which a transaction is facilitated; any thing used as a medium; in contempt.

Most of our fine young ladies retain in their service supernumerary insignificant fellows, which they use like whifflers, and commonly call *shoeing-horns*. *Spectator*

**SHÖE-LATCHET**, *n.* A shoe-tye.

**SHÖE-LEATHER**, *n.* [*shoe* and *leather*.] Leather for shoes.

**SHÖELESS**, *a.* Destitute of shoes.

Caltraps very much incommode the *shoeless* Moors. *Dr. Addison.*

**SHÖE-MAKER**, *n.* [*shoe* and *maker*.] Properly, a maker of shoes, though this name is often applied to every one connected with the calling, as the person who makes boots or any other article in the trade, and also to the employing party, as well as the employed.

**SHÖE-MAKING**, *n.* The trade of making shoes.

**SHÖER**, *n.* One that fits shoes to the feet; one that furnishes or puts on shoes; as a farrier.

**SHÖE-STRÄP**, *n.* A strap for a shoe.

**SHÖE-STRING**, *n.* [*shoe* and *string*.] A string used to fasten the shoe to the foot.

**SHÖE-TRADE**, *n.* The trade of making boots and shoes.

**SHÖE-TYE**, *n.* [*shoe* and *tye*.] A ribbon used for fastening a shoe to the foot.

**SHOG**, † *n.* for *Shock*, a violent concussion.

Another's diving hog he did adore, Which, with a *shog*, cast all the hair before. *Dryden.*

**SHOG**, † *v. t.* To shake; to agitate.

**SHOG**, † *v. i.* To move off; to be gone; to jog. [See **JOG**.]

**SHOG'GING**, † *n.* Concussion.

**SHOG'GLE**, † *v. t.* To shake; to joggle. [See **JOGLE**.]

**SHOLE**, *n.* [Sax. *sceol*, a crowd.] A throng; a crowd; a great multitude assembled. [See **SHOAL**.]

**SHONE**, *pp.* of *Shine*.

**SHOO**, *v. t.* [Ger. *scheuchen*, to scare.] To scare or drive away by frightening; hence, begone. [A word used in scaring away fowls, sheep, &c. Only used in the imperative. It is also written *shough*, *shue*, and *shue*.]

**SHOOK**, *pp.* of *Shake*.

**SHÖOK**, *n.* In *com.*, *shooks* are casks of hogshead staves prepared for use.

Boards for boxes of sugar, prepared or fitted for use, bear the same name.

**SHOOK**, *v. t.* To pack staves in casks.

**SHÖON**, † *old plur.* of *Shoe*.

**SHÖOT**, *v. t.* *pret.* and *pp.* *Shot*. The old participle *Shotten* is obsol. [Sax. *scoetan*, *sceytan*, to shoot, to dart, to rush, to lay out or bestow, to transfer, to point with the finger, whence to lead or direct; G. *schossen*, to shoot, and to pay scot, *schuessen*, to shoot, to dart; Ir. *scéithim*, to vomit; *sciot*, an arrow or dart; It. *scattare*, to shoot an arrow; L. *sceateo*, to shoot out water; W. *ysguthaw*, *ysgudaw*, to send; *ysgudu*, to thrust; *ysgythu*, to spout.] 1. To let fly and drive with force; as, to *shoot* an arrow.—2. To discharge and cause to be driven with violence; as, to *shoot* a ball.—3. To send off with force; to dart.

And from about her shot *darts* of desire. *Milton.*

4. To let off; used of the instrument.

The two ends of a bow *shot* off, fly from one another. *Boyle.*

5. To strike with any thing shot; as, to *shoot* one with an arrow or a bullet.—6. To send out; to push forth; as, a plant *shoots* a branch.—7. To push out; to emit; to dart; to thrust forth. Beware the secret snake that *shoots* a sting.  
*Dryden.*

8. To push forward; to drive; to propel; as, to *shoot* a bolt.—9. To push out; to thrust forward.

They *shoot* out the lip; Ps. xxii.

The phrase, to *shoot out the lip*, signifies to treat with derision or contempt.—10. To pass through with swiftness; as, to *shoot* the Stygian flood.—11. To pass rapidly under, by the force of a current; as, to *shoot* a bridge.—12. To plane straight, or fit by planing; a workman's term.

Two pieces of wood that are *shot*, that is, planed or pared with a chisel. *Mozon.*

12. To kill by a ball, arrow, or other thing shot; as, to *shoot* a duck. SHOOT, *v. i.* To perform the act of discharging, sending with force, or driving any thing by means of an engine or instrument; as, to *shoot* at a target or mark.

When you *shoot* and shut one eye. *Prior.*

The archers have sorely grieved him, and shot at him; Gen. xlix.

2. To germinate; to bud; to sprout; to send forth branches.

Onions, as they hang, will *shoot* forth. *Bacon.* But the wild olive *shoots* and shades the ungrateful plain. *Dryden.*

Delightful task,

To teach the young idea how to *shoot*.

*Thomson.*

3. To form by shooting, or by an arrangement of particles into spicula. Metals *shoot* into crystals. Every salt *shoots* into crystals of a determinate form.—4. To be emitted, sent forth, or driven along.

There shot a streaming lamp along the sky. *Dryden.*

5. To protuberate; to be pushed out; to jut; to project. The land *shoots* into a promontory.—6. To pass, as an arrow or pointed instrument; to penetrate.

Thy words *shoot* through my heart.

*Addison.*

7. To grow rapidly; to become by rapid growth. The boy soon *shoots* up to a man.

He'll soon *shoot* up a hero. *Dryden.*

8. To move with velocity; as a *shooting* star.—9. To feel a quick darting pain. My temples *shoot*.—To *shoot ahead*, to outstrip in running, flying, or sailing.—To be *shot of*, to be quit of, to be freed from.

SHOOT, *n.* The act of propelling or driving any thing with violence; the discharge of a fire-arm or bow; as, a good *shoot*.

The Turkish bow giveth a very forcible *shoot*. *Bacon.*

2. The act of striking or endeavouring to strike with a missive weapon.—3. A young branch, which *shoots* out from the main stock.

Prune off superfluous branches and *shoots* of this second spring. *Evelyn.*

4. A young swine.—5. The thrust of an arch.

SHOOTER, *n.* One that shoots; an archer; a gunner.

SHOOT'ING, *ppr.* Discharging as fire-arms; driving or sending with violence; pushing out; protuberating; germinating; branching; glancing; as pain.—*Shooting* stars, well-known meteors,

of which the origin and nature are involved in great obscurity, and which have of late years excited extraordinary interest by their periodical appearances in unusually great numbers. They appear to be equally numerous in all climates. They are observed at all seasons of the year, but, generally speaking, they appear to be more abundant in the end of summer and autumn than at other seasons. They burst from the clear azure sky, and, darting along the heavens, are extinguished without leaving any residuum, except a vapour-like smoke, and generally without noise. Many of them appear at altitudes far beyond the limits of the atmosphere, which clearly proves that they are not of atmospheric origin. Some have supposed that they have a lunar origin, and others that there are myriads of bodies revolving in groups round the sun which only become visible when inflamed by entering our atmosphere. They have been observed to be unusually abundant at certain periods of the year, as for instance on the 12th and 13th of November, the first two weeks, and particularly the 10th day of August.

SHOOT'ING, *n.* The act of discharging fire-arms, or of sending an arrow with force; a firing.—2. Sensation of a quick glancing pain.—3. In *sportsmanship*, the act or practice of killing game with guns or fire-arms.—4. In *joinery*, the operation of planing the edge of a board straight, and out of winding.—*Shooting boards*, two boards joined together, with their sides lapped upon each other, so as to form a rebate for making short joints.—*Shooting stich*, in *printing*, an implement for tightening and loosening the quoins that wedge up the pages in a chase. It is in the shape of a wedge, about one inch broad and nine inches long, and is usually made of boxwood.

SHOP, *n.* [Norm. *schope*; Fr. *échope*; Sax. *sceoppa*, a depository, from *scæpan*, to form or shape; Sw. *shop*, a repository; Dan. *shab*, a cupboard or chest of drawers.] 1. A building or apartment in which goods, wares, drugs, &c., are sold by retail.—2. A building in which mechanics work, and where are kept the manufactures for sale.

Keep your *shop* and your *shop* will keep you. *Franklin.*

SHOP, *v. i.* To visit shops for purchasing goods; used chiefly in the participle; as, the lady is *shopping*.

SHOP BOARD, *n.* [*shop* and *board*.] A bench on which work is performed; as, a doctor or divine taken from the *shopboard*.

SHOP BOOK, *n.* [*shop* and *book*.] A book in which a tradesman keeps his accounts.

SHOPKEEPER, *n.* [*shop* and *keep*.] A trader who sells goods in a shop or by retail; in distinction from a merchant, or one who sells by wholesale.—2. An article that has been long on hand; as, that bonnet is an old *shopkeeper*. [*Familiar*.]

SHOP LIFTER, *n.* [*shop* and *lift*. See *LIFT*.] One who steals any thing in a shop, or takes goods privately from a shop; one who under pretence of buying goods, takes occasion to steal.

SHOP LIFTING, *n.* Larceny committed in a shop; the stealing of any thing from a shop.

SHOP LIKE, *a.* Low; vulgar.

SHOPMAN, *n.* [*shop* and *man*.] A petty trader.—2. One who serves in a shop.

SHOPPING, *ppr.* Visiting shops for the purchase of goods.

SHOPPING, *n.* The act of visiting shops to purchase or cheapen goods; as, this continual *shopping* grows tiresome.

SHORE, *†* the old pret. of *Shear*.

SHORE, *n.* [Sax. *score*.] The coast or land adjacent to the ocean or sea, or to a large lake or river. This word is applied primarily to the land contiguous to water; but it extends also to the ground near the border of the sea or of a lake, which is covered with water. We also use the word to express the land near the border of the sea or of a great lake, to an indefinite extent; as when we say, a town stands on the *shore*. We do not apply the word to the land contiguous to a small stream. This we call a bank.

SHORE, *n.* A sewer,—which see.

SHORE, *n.* [Sp. and Port. *escora*; D. *schoor*.] In *arch*, a piece of timber or other material placed in such a manner as to prop up a wall or other heavy body.—*Dead-shore*, an upright piece fixed in a wall that has been cut or broken through for the purpose of making some alterations in the building. In *marine lan.*, *shores* are props

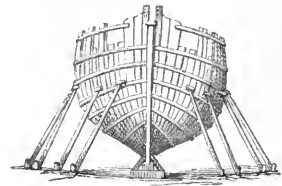

Vessel on the stocks supported by Shores.

or stanchions fixed under a ship's side or bottom, to support her on the stocks, or when laid on the blocks on the slip.

SHORE, *v. t.* To prop; to support by a post or buttress; usually with *up*; as, to *shore up* a building.—2. *†* To set on shore.

SHORE, *v. t.* To threaten; to offer.

[*Scotch*.]

SHOREA, *n.* A small genus of Indian plants, belonging to the nat. order Dipteracæ. One species, *S. robusta*,



Shorea robusta.

is a lofty and ornamental tree with showy inflorescence. It yields the timber called in India *saul* or *sal*, which is employed in the north-western provinces, in all government works, house timbers, gun-carriages, &c. The wood is of a uniform light-brown colour, close grained and strong. The tree

exudes a resin, called by the natives *ral* or *dhoona*, and by the Europeans one of the kinds of Dammer, being used for the same purpose as many other resins, and in Bengal very frequently as a substitute for pitch in the dockyards. It is also sometimes used by the Hindoos as an incense.

**SHORED**, *pp.* Propped; supported by a prop.

**SHORING**, *ppr.* Propping; supporting.  
**SHORELESS**, *a.* Having no shore or coast; of indefinite or unlimited extent; as, a *shoreless* ocean.

**SHORELING**, } *n.* In *Eng.*, the skin of  
**SHORLING**, } a living sheep shorn, as distinct from the *morling*, or skin taken from the dead sheep. Hence in some parts of England, a *shorling* is a sheep shorn, and a *morling* is one that dies.

**SHORE WEED**, *n.* A British plant of the genus *Littorella*, the *L. lacustris*.

**SHORL**, or **SCHORL**, *n.* [Sw. *shörl*, from *shör*, brittle; Dan. *shjör*.] A mineral, usually of a black colour, found in masses of an indeterminate form, or crystallized in three or nine-sided prisms, which when entire are terminated by three-sided summits. The surface of the crystals is longitudinally streaked. The amorphous sort presents thin straight distinct columnar concretions, sometimes parallel, sometimes diverging or stelliform. This is called also *tourmalin*. The shorl of the mineralogists of the last century comprehended a variety of substances which later observations have separated into several species. The green shorl is the epidote, or the vesuvian, or the actinolite. The violet shorl and the lenticular shorl are the axinite. The black volcanic shorl is the augite. The white vesuvian shorl is the somnite. The white granatiform is the leucite. The white prismatic is the pyenite, a species of the topaz, and another is a variety of feldspar. Of the blue shorl, one variety is the oxide of titanium, another the sappare, and another the phosphate of iron. The shorl cruciform is the grenatite. The octahedral shorl is the octahedrite or anatase. The red shorl of Hungary and the purple of Madagascar, are varieties of the oxide of titanum. The spathic shorl is the spodumene. The black shorl and the electric shorl only remain, and to this species the name *tourmalin* was given by that celebrated mineralogist, the Abbé Haüy. Blue shorl is a variety of Hauyne. Red and titanitic shorl is rutile.

**SHORLA'CEOUS**, or **SCHORLA'CEOUS**, *a.* Like shorl; partaking of the nature and characters of shorl.

**SHORLITE**, or **SCHORLITE**, *n.* A mineral of a greenish white colour, sometimes yellowish; mostly found in irregular oblong masses or columns, inserted in a mixture of quartz and mica or granite. Shorlite or shorlous topaz, the pyenite of Werner, is of a straw yellow colour.

**SHÖRN**, *pp.* of *Shear*. Cut off; as, a lock of wool *shörn*.—2. Having the hair or wool cut off or sheared; as, a *shörn* lamb.—3. Deprived; as, a prince *shörn* of his honours.

**SHORT**, *a.* [Sax. *seort*, *scyr*; G. *hur*; Fr. *court*; L. *curtus*; Ir. *gear*; Russ. *hortay*], to shorten. It is from cutting off or separating. Qn. Dan. *shjör*, Sw. *skor*, brittle.] 1. Not long; not having great length or extension; as,

a *short* distance; a *short* ferry; a *short* flight; a *short* piece of timber.

The bed is *shorter* than that a man can stretch himself on it; Is. xxviii.

2. Not extended in time; not of long duration.

The triumphing of the wicked is *short*; Job xx.; 1 Thess. ii.

3. Not of usual or sufficient length, reach, or extent.

Weak though I am of limb, and *short* of sight. Pope.

4. Not of long duration; repeated at small intervals of time; as, *short* breath.—5. Not of adequate extent or quantity; not reaching the point demanded, desired, or expected; as, a quantity *short* of our expectations.

Not therefore am I *short* Of knowing what I ought. Milton.

6. Deficient; defective; imperfect. This account is *short* of the truth.—7. Not adequate; insufficient; scanty; as, provisions are *short*; a *short* allowance of water for the voyage.—8. Not sufficiently supplied; scantily furnished.

The English were inferior in number, and grew *short* in their provisions.

Hayward.

9. Not far distant in time; future.

He commanded those who were appointed to attend him, to be ready by a *short* day.

Clarendon.

We now say, at *short* notice. In *mercantile lan.*, a note or bill is made payable at *short* sight, that is, in a little time after being presented to the payer.—10. Not fetching a compass; as, in the phrase, to turn *short*.—11. Not going to the point intended; as, to stop *short*.—12. Defective in quantity; as sheep *short* of their wool.

13. Narrow; limited; not extended; not large or comprehensive.

Their own *short* understandings reach No further than the present. Rowe.

14. Brittle; friable; breaking all at once without splinters or shatters; as, marl so *short* that it cannot be wrought into a ball.—15. Not bending.

The lance broke *short*. Dryden.

16. Abrupt; brief; pointed; petulant; severe. I asked him a question, to which he gave a *short* answer.—*To be short*, to be scantily supplied; as, to be *short* of bread or water; to be *short* of money; to be *short* of breath.—*To come short*, to fail; not to do what is demanded or expected, or what is necessary for the purpose; *applied to persons*. We all *come short* of perfect obedience to God's will.—2. Not to reach or obtain; Rom. iii.—3. To fail; to be insufficient. Provisions *come short*.—*To cut short*, to abridge; to contract; to make too small or defective; also, to destroy or consume; 2 Kings x.—*To fall short*, to fail; to be inadequate or scanty; as, provisions *fall short*; money *falls short*.—2. To fail; not to do or accomplish; as, to *fall short* in duty.—3. To be less. The measure *falls short* of the estimate.—*To stop short*, to stop at once; also, to stop without reaching the point intended.—*To turn short*, to turn on the spot occupied; to turn without making a compass.

For turning *short* he struck with all his might. Dryden.

*To be taken short*, to be seized with urgent necessity.—*In short*, in few words; briefly; to sum up or close in a few words.—*Short entry in a banker's*

*bill*, an entry which is made by stating the amount in an inner column, and carrying it out into the account between the parties only when the bill is paid.

*Short-allowance money*, a pecuniary allowance made to the officers and seamen of any of his (her) Majesty's ships for the period they have been necessitated to subsist on a diminution of the established allowance. This is commonly made where the service on which they were sent has not been performed within the time limited for that purpose.—*Short allowance*, in seamen's *lan.*, also signifies a limited quantity of meat and drink when provisions fall short.—*At short*, a commercial abbreviation of *at a short date*; as, the ordinary exchange at Paris on London *at short* (or at sight) is 25.50; that is, an English pound exchanges for twenty-five and a half francs.

**SHORT**, *n.* A summary account; as, the *short* of the matter.

The *short* and long in our play is preferred. Shak.

**SHORT**, *adv.* Not long; as, *short*-enduring joy; a *short*-breathed man. In connection with verbs, *short* is a modifying word, or used adverbially; as, to come *short*, &c.

**SHORT**, *v. t.* To shorten.—2. † *v. i.* To fail; to decrease.

**SHORT-BREATHED**, *a.* Having short breath or quick respiration.

**SHORT-CAKE**, } *n.* A sweet and  
**SHORT-BREAD**, } friable cake, in which butter or lard has been mixed with the flour.

**SHORT-COMING**, *n.* A failing of the usual produce, quantity, or amount; as of a crop.—2. A failure of full performance, as of duty.

**SHORT-DATED**, *a.* [short and date.] Having little time to run.

**SHORT-DRAWN**, *a.* Being of short breathing; imperfectly inspired, as breath.

**SHORTEN**, *v. t.* (short'n.) [Sax. *scyr-tan*.] 1. To make short in measure, extent, or time; as, to *shorten* distance; to *shorten* a road; to *shorten* days of calamity; Matt. xxiv.—2. To abridge; to lessen; as, to *shorten* labour or work.—3. To curtail; as, to *shorten* the hair by clipping.—4. To contract; to lessen; to diminish in extent or amount; as, to *shorten* sail; to *shorten* an allowance of provisions.—5. To confine; to restrain.

Here where the subject is so fruitful, I am *shortened* by my chain. Dryden.

6. To lop; to deprive.

The youth...*shortened* of his ears. Dryden.

7. To make paste short or friable, with butter or lard.

**SHORTEN**, *v. i.* (short'n.) To become short or shorter. The day *shortens* in northern latitudes from June to December.—2. To contract; as, a cord *shortens* by being wet; a metallic rod *shortens* by cold.

**SHORTENED**, *pp.* Made shorter; abridged; contracted.

**SHORTENING**, *ppr.* Making shorter; contracting.

**SHORTENING**, *n.* Something used in cookery to make paste short or friable, as butter or lard.

**SHORT-HAND**, *n.* [short and hand.] Short writing; a compendious method of writing by substituting characters, abbreviations, or symbols for words; otherwise called *stenography*.

**SHORT-HAULS**, *n.* A term in rope-

making for the hauls of yarn which fall short of the ordinary length.

**SHORT-JOINTED**, *a.* [*short* and *joint*.] A horse is said to be *short-jointed*, when the pastern is too short.

**SHORT-LAID**, *a.* A term in rope-making for short-twisted.

**SHORT-LIVED**, *a.* [*short* and *live*.] Not living or lasting long; being of short continuance; as, a *short-lived* race of beings; *short-lived* pleasure; *short-lived* passion.

**SHORTLY**, *adv.* Quickly; soon; in a little time.

The armies came *shortly* in view of each other. *Clarendon.*

2. In few words; briefly; as, to express ideas more *shortly* in verse than in prose.

**SHORT'ENER**, *n.* He or that which shortens.

**SHORT'NESS**, *n.* The quality of being short in space or time; little length or little duration; as, the *shortness* of a journey or of distance; the *shortness* of the days in winter; the *shortness* of life.—2. Fewness of words; brevity; conciseness; as, the *shortness* of an essay. The prayers of the church, by reason of their *shortness*, are easy for the memory.—3. Want of reach or the power of retention; as, the *shortness* of the memory.—4. Deficiency; imperfection; limited extent; as, the *shortness* of our reason.

**SHORT OCTAVES**, *n.* An appellation given to some of the lower octaves of an organ, because, from the omission of some of the intermediate notes, the extreme keys lie nearer to each other than those of the full octaves.

**SHORT-RIB**, *n.* [*short* and *rib*.] One of the lower ribs; a rib shorter than the others, below the sternum; a false rib.

**SHORTS**, *n. plur.* The bran and coarse part of meal, in mixture.—2. A term in rope-making for the topplings and tailings of hemp, which are dressed for bolt-ropes and whale lines. The term is also employed to denote the distinction between the long-hemp used in making staple-ropes and inferior hemp.

**SHORT-SIGHT**, *n.* Near-sightedness; myopia; vision accurate only when the object is near.

**SHORT-SIGHTED**, *a.* [*short* and *sight*.] Not able to see far; having limited vision; in a *literal* sense. [*See NEAR-SIGHTED*, a better term.]—2. Not able to look far into futurity; not able to understand things deep or remote; of limited intellect.

**SHORT-SIGHTEDNESS**, *n.* A defect in vision, consisting in the inability to see things at a distance, or at the distance to which the sight ordinarily extends.—2. Defective or limited intellectual sight; inability to see far into futurity or into things deep or abstruse.

**SHORT-WAISTED**, *a.* [*short* and *waist*.] Having a short waist or body.

**SHORT-WIND'ED**, *a.* [*short* and *wind*.] Affected with shortness of breath; having a quick respiration; as dyspnoic and asthmatic persons.

**SHORT-WINGED**, *a.* [*short* and *wing*.] Having short wings; as, a *short-winged* hawk.

**SHORT-WIT'ED**, *a.* Having little wit; not wise; of scanty intellect or judgment.

**SHORY**, *a.* [*from shore*.] Lying near the shore or coast. [*Little used*.]

**SHOT**, *pret.* and *pp.* of *Shoot*.

**SHOT**, *n.* [*Sax. scyt*; *D. schoot, schot. See SHOOT* and *SCOR*.] 1. The act of shooting; discharge of a missile weapon.

He caused twenty *shot* of his greatest cannon to be made at the king's army.

*Clarendon.*

*Note.*—The plural *shots*, may be used, but *shot* is used in both numbers.—2. A missile weapon, particularly a ball or bullet. *Shot* is properly whatever is discharged from fire-arms or cannon by the force of gunpowder. *Shot* used in war is of various kinds; as, *round shot* or *balls*; those for cannon made of iron, those for muskets and pistols, of lead. Secondly, *double headed shot* or *bar shot*, consisting of a bar with a round head at either end.



Bar-shot.

Thirdly, *chain-shot*, consisting of two balls chained together. Fourthly, *grape-shot*, consisting of a number of balls bound together with a cord in canvas, on an iron bottom.



Chain-shot.

Fifthly, *case shot* or *canister shot*, consisting of a great number of small bullets in a cylindrical tin box. Sixthly, *langrel* or *langrage*, which consists of pieces of iron of any kind or shape. *Small shot*, denotes musket or pistol balls.—3. Small globular masses of lead, used by sportsmen for killing birds and other small game. They are numbered according to their sizes.

In manufacturing this kind of shot, the melted lead is poured into a kind of sieve, elevated about 200 feet from the ground. It falls down in a shower, and in descending the streams separate into drops or globules, on the principle of cohesion. Before they reach the ground they are cooled and become solid.—4. The flight of a missile weapon, or the distance which it passes from the engine; as, a cannon *shot*; a musket *shot*; a pistol *shot*; a bow *shot*.—5. A reckoning; charge or proportional share of expense. [*See SCOR*.]

—6. Anything emitted, cast, or thrown forth.—*To shot the guns*, is to load the pieces of ordnance with the necessary quantity of gunpowder and ball.—*Shot-boxes*, boxes in which grape, case, and small arms shot are packed for service.—*Shot gauge*, an instrument for measuring the diameter of shot.—*Shot locker*. [*See LOCKER*.]—*Shot-racks*, wooden frames bolted to the coverings and head-ledges round the hatchways on the decks, to contain the different species of shot.—*Shot-pile*. [*See PILE*.]—*Shot of a cable*, in seamen's lan., the splicing of two cables together; or the whole length of two cables thus united. A ship will ride easier in deep water with one *shot of cable* thus lengthened, than with three short cables.

**SHOT, v. t.** To load with shot over a cartridge; as, to *shot* a gun. [The term is merely confined to charging cannon, for to *load* is the word used in the case of small arms.]

**SHOT, pp.** That which has been emptied at one movement; as, a cart of rubbish has been *shot*.

**SHOT-BELT**, *n.* A leathern receptacle for shot and other ammunition; as, the Circassians wear conspicuous *shot-belts*.

**SHOT-BELTED**, *a.* Wearing a belt carrying shot and ammunition.

**SHOTE**, *n.* [*Sax. sceota*; from *shooting, darting*.] 1. A fish resembling the trout. [*See SHOT*.]

**SHOT-FREE**, *a.* [*shot* and *free*.] Free from charge; exempted from any share of expense; scot-free.—2.† Not to be injured by shot.—3.† Unpunished.

**SHOT-HOLE**, *n.* A hole made by a bullet discharged.

**SHOT'ED**, *pp.* or *a.* Loaded with shot over a cartridge; as, great guns.

**SHOTTEN**, *a.* [*shot*'n.] [*from shoot*.] Having ejected the spawn; as, a *shotten* herring.—2. Shooting into angles.—3. Shot out of its socket; dislocated; as a bone.

**SHOUGH**,† *n.* (*shok*.) A kind of shaggy dog. [*See SHOOK*.]

**SHOUGH**,† *interj.* (*shoo*.) [*Ger. scheuchen*.] A cry used to scare away fowls.

**SHOULD**, (*shood*.) The preterit of *Shall*, but now used as an auxiliary verb, either in the past time or conditional present. "He *should* have paid the debt at the time the note became due." *Should* here denotes past time. "I *should* ride to town this day if the weather would permit." He *should*, expresses present or future time conditionally. In the second and third persons, it denotes obligation or duty, as in the first example above.—1. *I should go*. When *should* in this person is uttered without emphasis, it declares simply that an event would take place, on some condition or under other circumstances. But when expressed with emphasis, *should* in this person denotes obligation, duty, or determination.—

2. *Thou shouldst* } Without emphasis.  
                           } *You should go*. phasis, *should*, in the second person, is nearly equivalent to *ought*; you ought to go, it is your duty, you are bound to go. [*See SHALL*.] With emphasis, *should* expresses determination in the speaker conditionally to compel the person to act. "If I had the care of you, you *should* go, whether willing or not."—

3. *He should go*. *Should*, in the third person, has the same force as in the second.—4. If *I should*, if you *should*, if he *should*, &c. denote a future contingent event.—5. After *should*, the principal verb is sometimes omitted, without obscuring the sense.

*So* subjects love just kings, or so they *should*. *Dryden.*

That is, so they *should* love them.—6. *Should* be, ought to be; a proverbial phrase, conveying some censure, contempt, or irony. Things are not as they *should* be.

The boys think their mother no better than she *should* be. *Addison.*

7. "We think it strange that stones *should* fall from the aerial regions." In this use, *should* implies that stones do fall. In all similar phrases, *should* implies the actual existence of the fact, without a condition or supposition.

**SHOULDER**, *n.* [*Sax. sculder, sculdor, sculder*; *G. schulter*.] 1. The joint by which the arm of a human being or the fore leg of a quadruped is connected with the body; or in man, the projection formed by the bones called *scapula* or shoulder-blades, which extend from the basis of the neck in a horizontal direction.—2. The upper joint of the fore leg of an animal cut for the market; as, a *shoulder* of mut-

ton.—3. *Shoulders*, in the plural, in the upper part of the back.

Adown her *shoulders* fell her length of hair.  
*Dryden.*

4. *Figuratively*, support; sustaining power; or that which elevates and sustains.

For on thy *shoulders* do I build my seat.  
*Shak.*

5. Among artificers, something like the human shoulder; a horizontal or rectangular projection from the body of a thing.—*Shoulder of a tenon*, the plane transverse to the length of a piece of timber from which the tenon projects. It does not, however, always lie in the plane here defined, but sometimes lies in different planes.—6. In *fort.*, the angle of a bastion included between the face and flank.—7. In *archery*, the broad part of the arrow-head.

SHOULDER, *v. t.* To push or thrust with the shoulder; to push with violence. Around her numberless the rabble flow'd  
*Shouldering* each other, crowding for a view.  
*Rowe.*

As they the earth would *shoulder* from her seat.  
*Spenser.*

2. To take upon the shoulder; as, to *shoulder* a basket.—3. In *milit. phrase*, to lay any thing on the shoulder, or to rest any thing against; as, to *shoulder* arms; to *shoulder* a musket, &c.

SHOULDER-BELT, *n.* [*Shoulder* and *belt*.] A belt that passes across the shoulder.

SHOULDER-BLADE, *n.* [*Shoulder* and *blade*.] The bone of the shoulder, or blade bone, broad and triangular, covering the hind part of the ribs; called by anatomists *scapula* and *omoplatra*.

SHOULDER-BLOCK, *n.* Among *ship carpenters*, a large single block left almost square at the upper end, and cut sloping in the direction of the sheave.



Shoulder-block.

SHOULDER-CLAPPER, † *n.* [*Shoulder* and *clap*.] One that claps another on the shoulder, or that uses great familiarity.—2. † A sheriff's officer.

SHOULDERED, *pp.* Pushed or thrust with the shoulder.—2. Supported on the shoulder.

SHOULDERING, *pp.* Pushing with the shoulder.—2. Taking upon the shoulder.

SHOULDER-KNOT, *n.* [*Shoulder* and *knot*.] An ornamental knot of ribbon or lace worn on the shoulder; an epanulet.

SHOULDER-PEGGED, *a.* An epithet for horses that are gourdy, stiff, and almost without motion.

SHOULDER-SHOTTEN, *a.* [*Shoulder* and *shot*.] Strained in the shoulder, as a horse.

SHOULDER-SLIP, *n.* [*Shoulder* and *slip*.] Dislocation of the shoulder or of the humerus.

SHOULDER-SPLAYED, *a.* An epithet for a horse when he has given his shoulders such a violent shock, as to disjoint the shoulder-joint from the body.

SHOULDER-WRENCH, *n.* A wrench in the shoulder of a horse.

SHOUT, *v. i.* [This word coincides with *shoot*, *W. ysgythu*, to jet, to spout.] To utter a sudden and loud outcry, usually in joy, triumph, or exultation, or to animate soldiers in an onset.

It is not the voice of them that *shout* for mastery; Exod. xxxii.

When ye hear the sound of the trumpet, all the people shall *shout* with a great shout; Josh. vi.

SHOUT, *n.* A loud burst of voice or voices; a vehement and sudden outcry, particularly of a multitude of men, expressing joy, triumph, exultation, or animated courage. It is sometimes intended in derision; Josh. vi.; Ezra iii.

The Rhodians seeing the enemy turn their backs, gave a great *shout* in derision.  
*Knolles.*

SHOUT, *v. t.* To treat with shouts or clamour, followed by *at*.

SHOUTED, *pp.* Treated with shouts.

SHOUTER, *n.* One that shouts.

SHOUTING, *pp.* Uttering a sudden and loud outcry in joy or exultation.

SHOUTING, *n.* The act of shouting; a loud outcry expressive of joy or animation; 2 Sam. vi.

SHOVE, *v. t.* [*Sax. scufan*, to push or thrust; *scufan*, to suggest, to hint; *G. schieben*, *schuppen*.] 1. To push; to propel; to drive along by the direct application of strength without a sudden impulse; particularly, to push a body by sliding or causing it to move along the surface of another body, either by the hand or by an instrument; as, to *shove* a bottle along a table; to *shove* a table along the floor; to *shove* a boat on the water.

And *shove* away the worthy bidden guest.  
*Milton.*

*Shoving* back this earth on which I sit.  
*Dryden.*

2. To push; to press against.

He used to *shove* and elbow his fellow servants to *get* near his mistress.  
*Arbutnot.*

To *shove* away, to push to a distance; to thrust off.—To *shove* by, to push away; to delay, or to reject; as, to *shove* by the hearing of a cause; or to *shove* by justice. [*Not elegant*.]—To *shove* off, to thrust or push away.—To *shove* down, to overthrow by pushing.

SHOVE, *v. i.* To push or drive forward; to urge a course.—2. To push off; to move in a boat or with a pole; as, he *shoved* from shore.—To *shove* off, to move from shore by pushing with poles or oars.

SHOVE, *n.* The act of pushing or pressing against by strength, without a sudden impulse.—2. A sudden push.

SHOVED, *pp.* Pushed; propelled.

SHOVEL, *n.* (*shuv'l*.) [*Sax. scofl*; *G. schaufel*; *Dan. shuffe*, a *scoop* or *shovel*; from *shoving*.] An instrument consisting of a broad scoop or hollow blade with a handle; used for taking up and removing a quantity of loose substances together; as coals, sand, loose earth, gravel, corn, money, &c. The construction of shovels is necessarily very much varied to adapt them for their particular purposes. A *fire shovel* is an utensil for taking up coals, cinders, or ashes. The *barn shovel*, for lifting and removing grain, has the blade generally of wood.

SHOVEL, *v. t.* To take up and throw with a shovel; as, to *shovel* earth into a heap or into a cart, or out of a pit.—2. To gather in great quantities.

SHOVEL-BOARD, *n.* A board on which they play by sliding metal pieces at a mark.

SHOVELLED, *pp.* Thrown with a shovel.

SHOVELLER, *n.* [from *shovel*.] A species of duck, remarkable for the length and terminal expansion of the bill. It is the *Anas clypeata* of Linnaeus.

SHOVELLING, *pp.* Throwing with a shovel.

SHOVELLING, *n.* The act of taking up, and removing loose substances, as sand, gravel, &c. with a shovel.

SHOW, *v. t.* pret. *Showed*; pp. *Shown* or *Showed*. It is sometimes written *shew*, *shewed*, *shewn*. [*Sax. sceccwian*; *G. schauen*. This word in most of the Teutonic dialects, signifies merely to look, see, view, behold. In Saxon it signifies to show, look, view, explore, regard. This is doubtless a contracted word. If the radical letter lost was a labial, *show* coincides with the Gr. *σῶωμι*, *συνέωμαι*. If a dental has been lost, this word accords with the Sw. *skada*, to view or behold.] 1. To exhibit or present to the view of others.

Go thy way, *show* thyself to the priest; Matt. viii.

2. To afford to the eye or to notice; to contain in a visible form.

Nor want we skill or art, from whence to raise

Magnificence; and what can heaven *show* more?  
*Milton.*

3. To make or enable to see.—4. To make or enable to perceive.—5. To make to know; to cause to understand; to make known to; to teach or inform; Job x.

Know, I am sent  
To *show* thee what shall come in future days.  
*Milton.*

6. To prove; to manifest.

I'll *show* my duty by my timely care. *Dryden.*

7. To inform; to teach; with *of*.

The time cometh when I shall no more speak to you in proverbs but I shall *show* you plainly of the Father; John xvi.

8. To point out, as a guide.

Thou shalt *show* them the way in which they must walk; Exod. xviii.

9. To bestow; to confer; to afford; as, to *show* favour or mercy on any person; Ps. cxii. 5.—10. To prove by evidence, testimony, or authentic registers or documents.

They could not *show* their father's house; Ezra ii.

11. To disclose; to make known.

I durst not *show* you mine opinion; Job xxxii.

12. To discover; to explain; as, to *show* a dream or interpretation; Dan. ii.—

To *show* forth, to manifest; to publish; to proclaim; 1 Pet. ii.—To *show* off, to set off, to exhibit one's accomplishments in an ostentatious manner.—To *show* up, to expose; to show the way up, or to an audience of some one; as, *Show* up that gentleman, Sir.—2. To expose to animadversion, to ridicule, or to contempt; as, the power which public journalists have of *showing* up private individuals, ought not to be recklessly exercised. [*Colloquial*.]

SHOW, *v. i.* To appear; to look; to be in appearance.

Just such she *shows* before a rising storm.  
*Dryden.*

2. To have appearance; to become or suit well or ill.  
My lord of York, it better *show'd* with you. †  
*Shak.*

SHOW, *n.* Superficial appearance; not reality.

Mild heav'n  
Disapproves that care, though wise in *show*.  
*Milton.*

2. A spectacle; something offered to view for money.—3. Ostentatious display or parade.

I envy none their pageantry and *show*. *Young.*

4. Appearance as an object of notice.  
The city itself makes the noblest *show* of any in the world.  
*Addison.*

5. Public appearance, in distinction from concealment; as, an open *show*.—6. Semblance; likeness.

In *show* plebeian angel militant. *Milton.*

7. Speciousness; plausibility.

But a short exile must for *show* precede. *Dryden.*

8. External appearance.

And forc'd, at least in *show*, to prize it more. *Dryden.*

9. Exhibition to view; as, a *show* of cattle, or *cattle-show*.—10. Pomp; magnificent spectacle.

As for triumphs, masks, feasts, and such *shows*. *Bacon.*

11. A phantom; as, a *show*.—12. Representative action; as, a *dumb show*.—13. External appearance; hypocritical pretence.

Who devour widows' houses, and for a *show* make long prayers; Luke xx.

—A *show of hands*; a raising of hands, as a means of indicating the sentiments of a meeting upon some proposition.

**SHOW-BILL**, *n.* A placard, usually printed, and placed at a shop door, or window, containing announcements of books, or other wares, sold within.

**SHOW-BOX**, *n.* A box containing some object or objects of curiosity, carried round as a *show*.

**SHOW-BREAD**, *† n.* [*show* and *bread*.]

**SHAW-BREAD**, } Among the Jews, bread of exhibition; the loaves of bread which the priest of the week placed before the Lord, on the golden table in the sanctuary. They were shaped like a brick, were ten palms long and five broad, weighing about eight pounds each. They were made of fine flour unleavened, and changed every sabbath. The loaves were twelve in number, and represented the twelve tribes of Israel. They were to be eaten by the priest only.

**SHOW-CASE**, *n.* A case or box fixed (generally on the counter) in a shop, with plates of glass, through which light or valuable small wares can be seen by a purchaser.

**SHOWER**, *n.* One who shows or exhibits. One who shows any thing. [The word where it has this uncommon meaning, ought to be spelt *shewer*.]

**SHOWER**, *n.* [Sax. *scur*; G. *schauer*, a shower, horror; *schauern*, to shower, to shiver, shudder, quake. Qu. Heb. Ch. and Ar. *שער*, *shaar*, to be rough, to shudder.] 1. A fall of rain or hail, of short duration. It may be applied to a like fall of snow, but this seldom occurs. It is applied to a fall of rain or hail of short continuance, of more or less violence, but never to a storm of long continuance.—2. A fall of things from the air in thick succession; as, a *shower* of darts or arrows; a *shower* of stones.—3. A copious supply bestowed; liberal distribution; as, a great *shower* of gifts.

**SHOWER**, *v. t.* To water with a shower; to wet copiously with rain; as, to *shower* the earth.—2. To bestow liberally; to distribute or scatter in abundance.

Cesar's favour,

That *show'rs* down greatness on his friends.

*Addison.*

3. To wet with falling water, as in the shower-bath.

**SHOW'ER**, *v. i.* To rain in showers.

**SHOW'ER-BATH**, *n.* Water let fall upon a person's body, from above in a mass of drops; also, a contrivance for effecting this.

**SHOW'ERED**, *pp.* Wet with a shower;

watered abundantly; bestowed or distributed liberally.

**SHOWERING**, *ppr.* Wetting with a shower, or with falling water; raining in showers; bestowing liberally.

**SHOW'ERLESS**, *a.* Without showers.

**SHOW'ERY**, *a.* Raining in showers; abounding with frequent falls of rain.

**SHOW'ILY**, *adv.* In a showy manner; pompously; with parade.

**SHOW'INESS**, *n.* State of being showy; pomposness; great parade.

**SHOWING**, *ppr.* Presenting to view; exhibiting; proving.

**SHOW'ING**, *n.* A presentation to view; exhibition.

**SHOW'ISH**, *a.* Splendid; gaudy. [*Little used*.]—2. Ostentations.

**SHOW'N**, *pp.* of *Show*. Exhibited; manifested; proved.

**SHOW-ROOM**, *n.* An apartment in a warehouse for the display of fancy goods, to attract purchasers. Also, an apartment in a milliner's or dressmaker's establishment for the display of articles of dress.

**SHOWY**, *a.* Splendid; gay; gaudy; making a great show; fine.—2. Ostentatious.

**SHRAG**, *† v. t.* To lop.

**SHRAG**, *† n.* A twig of a tree cut off.

**SHRAG'GER**, *† n.* One that lops; one that trims trees.

**SHRANK**, *prct.* of *Shrink*, nearly obsolete.

**SHRAP**, } *† n.* A place baited with SHRAPE, } chaff to invite birds.

**SHRAP'NEL SHELLS**, *n.* In *gunnery*, shells filled with a quantity of musket balls which, when the shell explodes after being fired, are projected about 150 yards further. They are fired from guns, mortars, and howitzers, and have been found most effective.

**SHREAD' HEAD**, *n.* The same as *jerkin head*,—which see.

**SHRED**, *v. t.* pret. and *pp.* *Shred*. [Sax. *screadan*, to cut off; Sw. *shradare*, a tailor.] To cut into small pieces, particularly narrow and long pieces, as of cloth or leather. It differs from *mince*, which signifies to chop into pieces fine and short.

**SHRED**, *n.* A long narrow piece cut off; as, *shreds* of cloth.—2. A fragment; a piece; as, *shreds* of wit.

**SHRED'DING**, *ppr.* Cutting into shreds.

**SHRED'DING**, *n.* That which is cut off; a piece.

**SHRED'DINGS**, *n.* In old buildings, short light pieces of timber, fixed as bearers below the roof, forming a straight line with the upper side of the rafters.

**SHRED'LESS**, *a.* Having no shreds.

**SHREW**, *n.* [If this word signifies a brawler, it may be from *D. schreeuwen*, to brawl, *G. schreien*. But *beshrew*, in Chaucer, is interpreted to *curse*.] 1. A peevish, brawling, turbulent, vexatious woman. It appears originally to have been applied to males as well as females; but is now restricted to the latter.

The man had got a *shrew* for his wife, and there could be no quiet in the house with her. *L'Estrange.*

2. A *shrew-mouse*.

**SHREW**, *† v. t.* To *beshrew*; to curse. **SHREW'D**, *† a.* Having the qualities of a *shrew*; vexatious; troublesome; mischievous.—2. Sly; cunning; arch; subtle; artful; astute; as, a *shrew'd* man.

—3. Sagacious; of nice discernment; as, a *shrew'd* observer of men.—4. Proceeding from cunning or sagacity, or

containing it; as, a *shrew'd* saying; *a shrew'd* conjecture.—5. Painful; vexatious; troublesome.

Every of this number

That have endured *shrew'd* nights and days with us.† *Shak.*

No enemy is so despicable but he may do one a *shrew'd* turn.† *L'Estrange.*

**SHREW'D'LY**, *adv.* Mischievously; destructively.

This practice hath most *shrew'dly* past upon thee † *Shak.*

2. Vexatiously; *used* of *slight mischief*.

The obstinate and schismatical are like to think themselves *shrew'dly* hurt by being cut from that body they chose not to be off. *South.*

Yet seem'd she not to wince, though *shrew'dly* pain'd.† *Dryden.*

3. Archly; sagaciously; with goodness; as, I *shrew'dly* suspect; he *shrew'dly* observed.

**SHREW'D'NESS**, *n.* Sly cunning; archness.

The neighbours round admire his *shrew'dness*. *Swift.*

2. Sagaciousness; sagacity; the quality of nice discernment.—3.† Mischievousness; vexatiousness.

**SHREW'ISH**, *a.* Having the qualities of a *shrew*; froward; peevish; petulantly clamorous.

My wife is *shrew'ish* when I keep not hours. *Shak.*

**SHREW'ISHLY**, *adv.* Peevishly; clamorously; turbulently.

He speaks very *shrew'ishly*. *Shak.*

**SHREW'ISHNESS**, *n.* The qualities of a *shrew*; frowardness; petulance; turbulent clamorousness.

I have no gift in *shrew'ishness*. *Shak.*

**SHREW'-MOUSE**, **SHREW'-MOLE**; *n.* [Sax. *screawca*.] An insectivorous mammal resembling a mouse, but belonging to the genus *Sorex*; an animal

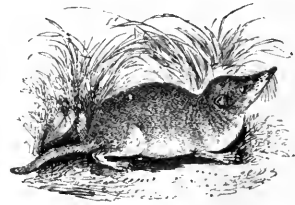

Common Shrew Mouse (*Sorex araneus*).

that burrows in the ground, feeding on the larvæ of insects, &c. It is a harmless animal. [*See* **SOREX**.]

**SHRIEK**, *v. i.* [*G. schreien*; *D. schreijen*; the two latter contracted; *W. ysgreçian*, from *creg*, a scream or shriek, also rough, rugged, Eng. to *creak*, whence *screach*, and vulgarly *screach*; hence *W. ysgreç*, a jay, from its scream; *creg*, hoarse, *crygi*, hoarseness, roughness, from the root of *rugged*, and *L. ruga*, wrinkled, *ruço*, to bray; all from straining, and hence breaking, bursting, cracking; allied to *crach* and *crackle*.] To utter a sharp shrill cry; to scream; as in a sudden fright, in horror or anguish.

At this she *shrieked* aloud. *Dryden.*

It was the owl that *shrik'd*. *Shak.*

**SHRIEK**, *n.* A sharp shrill outcry or scream, such as is produced by sudden terror or extreme anguish.

*Shrieks*, clamorous murmurs fill the affrighted town. *Dryden.*

**SHRIEK'ER**, *n.* One who shrieks.

SHRIEKING, *ppr.* Crying out with a shrill voice.

SHRIEVAL, † *n.* Pertaining to a sheriff.  
SHRIEVALTY, *n.* [from *sheriff*.] The office or jurisdiction of a sheriff. [See *SHERIFFALTY*.]

It was ordained by 23 Edw. I. that the people shall have election of sheriff in every shire, where the *shrievalty* is not of inheritance. *Blackstone.*

SHRIEVE, † *n.* Sheriff.

SHRIET, † *n.* [Sax. *scrift*.] Confession made to a priest.

SHRIGHT, for *Shrieked*.

SHRIGHT, † *n.* A shriek.

SHRIKES, *n.* The English ornithological name of the butcher-birds, which form the genus *Lanius* of Linn., and the *Laniadae* of modern ornithologists. Cuvier arranges them under the denticrostral division of his order of *Passerine* birds. Swainson arranges the *Laniadae* into five sub-families:—1. The *Tyranninae*, or tyrant-shrikes; 2. the *Ceblyprinae* or caterpillar-shrikes; 3. the *Dicruvinae*, or drongo-shrikes; 4. the *Thamnohilinae*, or bush-shrikes; and, 5. the *Lanianae*, or true-shrikes. The



Great Grey Shrike (*Lanius excubitor*).

shrikes are characterized by a strong compressed conical beak, more or less hooked, and emarginate near the point, as in the other denticrostrals. They live in families, and fly irregularly and precipitately, uttering shrill cries. They build in trees, lay five or six eggs, and take great care of their young. They

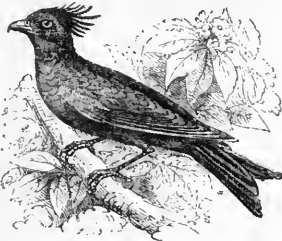

Forked-tail Crested Shrike (*Lanius forficatus*).

have a habit of imitating a part of the songs of such birds as live in their vicinity. The larger and stronger birds are predatory, and attack, slay, and devour smaller birds, frogs, mice, lizards, and beetles. They have been called butcher-birds from their habit of suspending their prey, after depriving it of life, upon thorns.

SHRILL, *a.* [W. *grill*, a sharp noise; Arm. *scrilh*, a cricket, L. *gryllus*, Fr. *grillon*, It. *strillare*, to scream.] 1. Sharp; acute; piercing; as sound; as, a *shrill* voice; *shrill* echoes.—2. Utter-

ing an acute sound; as, the cock's *shrill* sounding throat; a *shrill* trumpet.

*Note*.—A *shrill* sound may be tremulous or trilling; but this circumstance is not essential to it, although it seems to be from the root of *trill*.

SHRILL, *v. i.* To utter an acute piercing sound.

Break we our pipes that *shrill'd* as loud as lark. *Spenser.*

SHRILL, *v. t.* To cause to make a *shrill* sound.

SHRILL'NESS, *n.* Acuteness of sound; sharpness or fineness of voice.

SHRIL'LY, *adv.* Acutely, as sound; with a sharp sound or voice.

SHRIMP, † *v. t.* [D. *krimpen*; Dan. *skrumper*, to crumple, to shrink; G. *schrumpfen*; W. *crom, cren*, bending or shrinking in.] To contract.

SHRIMPS, *n.* [supra.] The Salicoques of the French, a very numerous family of macerous decapod crustaceans, whose body is generally compressed laterally, their abdomen very large, and their tegument simply horny. They have long slender feelers, claws with a single hooked fang, three pairs of legs, and seven joints in the tail. The *Crangon vulgaris*, or common shrimp, inhabits the shores of Britain in vast quantities, and is esteemed delicious food.—2. A little wrinkled man; a dwarf; in contempt.

SHRINE, *n.* [Sax. *scrin*; Ger. *schrein*; Fr. *écrin, escrin*, from Lat. *scrinium*, a wooden case for keeping books, papers, unguents, &c., in a chest, box, &c.] A reliquary, or box for holding the bones, or other remains of departed saints. The primitive form of the shrine was that

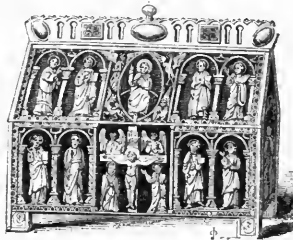

Portable Shrine, Malmesbury Abbey.

of a small church with a high-ridged roof, and similar to the hog-backed tombs of the ancient Greeks, still seen in Anatolia. Hence, 2. A tomb, of shrine-like configuration; and, 3. A mausoleum of a saint, of any form; as, the shrine of St. Thomas à Becket at Canterbury.

SHRINK, *v. i.* pret. and pp. *Shrank*. The old pret. *Shrank* and pp. *Shrunken* are nearly obsolete. [Sax. *serincan*. If *n* is not radical, the root is *rig* or *ryg*.] 1. To contract spontaneously; to draw or be drawn into less length, breadth, or compass by an inherent power; as, woollen cloth *shrinks* in hot water; a flaxen or hempen line *shrinks* in a humid atmosphere. Many substances *shrink* by drying.—2. To shivel; to become wrinkled by contraction; as the skin.—3. To withdraw or retire, as from danger; to decline action from fear. A brave man never *shrinks* from danger; a good man does not *shrink* from duty.—4. To recoil, as in fear, horror, or distress. My mind *shrinks* from the recital of our woes.

What happier natures *shrink* at with affright,  
The hard inhabitant contends is right. *Pope.*

5. To express fear, horror, or pain by shrugging or contracting the body.

SHRINK, *v. t.* To cause to contract; as, to *shrink* flannel by immersing it in boiling water.

O mighty Cesar, dost thou lie so low!  
Are all thy conquests, glories, triumphs,  
spoils,

*Shrunk* to this little measure! *Shak.*

SHRINK, *n.* Contraction; a spontaneous drawing into less compass; corrugation.—2. Contraction; a withdrawing from fear or horror.

SHRINK'AGE, *n.* A shrinking or contraction into a less compass. Make an allowance for the *shrinkage* of grain in drying.

SHRINK'ER, *n.* One that shrinks; one that withdraws from danger.

SHRINK'ING, *ppr.* Contracting; drawing together; withdrawing from danger; declining to act from fear; causing to contract.

SHRINK'ING, *n.* The act of drawing back through fear.—2. The contracting of a piece of timber in its breadth by seasoning by hot water.

SHRINK'INGLY, *adv.* By shrinking.

SHRIVALTY. See *SHRIEVALTY*.

SHRIVE, *v. t.* pret. *Shrove*, pp. *Shrived*, *Shriven*. [Sax. *scrifan*, to take a confession. But the sense seems to be to enjoin or impose penance, or simply to enjoin.] To hear or receive the confession of; to administer confession; as a priest.

He *shrives* this woman. † *Shak.*

SHRIVEL, *v. i.* (*shriv'l*) [from the root of *riuel*, Sax. *gerifeld*.] To contract; to draw or be drawn into wrinkles; to shrink and form corrugations; as, a leat *shrivels* in the hot sun; the skin *shrivels* with age.

SHRIVEL, *v. t.* To contract into wrinkles; to cause to shrink into corrugations. A scorching sun *shrivels* the blades of corn.

Aud *shrivel'd* herbs on withering stems decay. *Dryden.*

SHRIVELLED, *pp.* Contracted into wrinkles.

SHRIVELLING, *ppr.* Contracting into wrinkles.

SHRIVER, † *n.* [from *shrive*.] A confessor.

SHRIVING, † *n.* Shrift; confession taken.

SHROFF, *n.* In the *East Indies*, a banker or money-changer.

SHROUD, *n.* [Sax. *scrud*, clothing.] 1. A shelter; a cover; that which covers, conceals, or protects.

Swaddled, as new born, in sable *shrouds*. *Sandys.*

2. The dress of the dead; a winding sheet.—3. *Shroud* or *shrouds* of a ship,

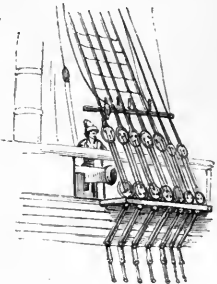

Shrouds.

a range of large ropes extending from the head of a mast to the right and left



sides of the ship, to support the mast. The shrouds, as well as the sails, &c., are denominated from the masts to which they belong; they are the main, fore, and mizen shrouds, the main-top-mast, fore-top-mast, or mizen-top-mast shrouds; and the main-top-gallant, fore-top-gallant, or mizen-top-gallant shrouds. There are also futtock shrouds, bowsprit shrouds, &c.—4. A branch of a tree. [*Not proper.*]

5. A shroud, or shroude, in *Arch.*, an old name for the crypt of a church.

SHROUD, *v. t.* To cover; to shelter from danger or annoyance.

Under your beams I will me safely shroud.  
*Spenser.*

One of these trees with all its young ones, may shroud four hundred horsemen.  
*Raleigh.*

2. To dress for the grave; to cover; as a dead body.

The ancient Egyptian mummies were shrouded in several folds of linen besmeared with gums.  
*Bacon.*

3. To cover; to conceal; to hide; as, to be shrouded in darkness.

Some tempest rise,  
And blow out all the stars that light the skies,  
To shroud my shame.  
*Dryden.*

4. To defend; to protect by hiding.

So Venus from prevailing Greeks did shroud  
The hope of Rome, and sav'd him in a cloud.  
*Walter.*

5. To overwhelm; as, to be shrouded in despair.—6. To lop the branches of a tree. [*Unusual or improper.*]

SHROUD, *v. i.* To take shelter or harbour.

If your stray attendants be yet lodg'd  
Or shroud within these limits.  
*Milton.*

SHROUDED, *pp.* Dressed; covered; concealed; sheltered; overwhelmed.

SHROUD'ING, *pp.* Dressing; covering; concealing; sheltering; overwhelming.

SHROUDS, } *n.* In water wheels,  
SHROUD'ING, } the plates at the periphery of the wheels which form the sides of the buckets.

SHROUD'Y, *a.* Affording shelter.

SHROVE, } *v. i.* To join in the festivities of Shrove-tide.

SHROVE-TIDE, } *n.* [from *shrove*,  
SHROVE-TUESDAY, } pret. of *Shrive*, to take a confession. See *Tide* and *TUESDAY*.] Confession-time; confession-Tuesday; the Tuesday after Quinquagesima Sunday, or the day immediately preceding the first of Lent, or Ash Wednesday; on which day, all the people of England, when Roman catholics, were obliged to confess their sins one by one to their parish priests; after which they dined on pancakes or fritters. The latter practice still continues, and it has given this day the vulgar appellation of Pancake Tuesday. The Monday preceding was by the vulgar called collop Monday, from the primitive custom of eating eggs on collops or slices of bread.—2. In Scotland, shrove-tide is called *Fastern's e'en* or *Fasten's e'en*.

SHROVING, *n.* The festivity of Shrove-tide.

SHRUB, *n.* [*Sax. scrob, G. schraff, rugged; Ir. sgrabach, rough.* See *SCRUB*.] A low dwarf tree; a woody plant of a size less than a tree; or more strictly, a plant with several permanent woody stems, dividing from the bottom, more slender and lower than in trees. All plants are divided into herbs, shrubs, and trees. A shrub ap-

proaches the tree in its duration and consistence, but never attains the height of a tree, and is generally taller than the herb. It varies in height from about four to twelve feet. For practical purposes shrubs are divided into the deciduous and ever-green kinds. The most ornamental flowering shrubs, are those belonging to the genera *Rosa*, *Rhododendron*, *Azalea*, *Kalmia*, *Andromeda*, *Vaccinium*, &c. Among the ever-green shrubs, are the holly, the ivy, the jasmine, the box, various heaths, &c.

Gooseberries and currants are shrubs; oaks and cherries are trees.  
*Locke.*

SHRUB, *n.* [*Ar. shurbon*, drink, and from the same source, *sirap*. The Arabic verb signifies to drink, to imbibe, whence *L. sorbeo*. See *SHERBERT* and *ANSORR*.] A liquor composed of acid and sugar, with spirit (chiefly rum) to preserve it; usually the acid of lemons.

SHRUB, *v. t.* To clear of shrubs.

SHRUB'BERY, *n.* Shrubs in general.—2. A plantation of shrubs, formed for the purpose of adorning gardens and pleasure grounds.

SHRUB'BINESS, *n.* The state or quality of being shrubby.

SHRUB'BING, *pp.* Clearing of shrubs.

SHRUB'BY, *a.* Full of shrubs; as, a shrubby plain.—2. Resembling a shrub; as, plants shrubby and curled.—3. Consisting of shrubs or brush; as, shrubby browse.—4. A shrubby plant is perennial, with several woody stems.

SHRUB'LESS, *a.* Having no shrubs.

SHRUFF, } *n.* [*G. schraff, rugged.*]  
Dross; recrement of metals.

SHRUG, *v. t.* [This word is probably formed from the root of *G. rüchen*, the back, *D. rug*, *Sax. hric* or *hryg*, the back, a ridge, *W. crug*, a heap, *crwg*, a crook, *L. ruga*, a wrinkle, *Eng. rough*.] To draw up; to contract; as, to shrug the shoulders. The word seems to be limited in its use to the shoulders, and to denote a particular motion which raises the shoulders and rounds the back.

SHRUG, *v. i.* To raise or draw up the shoulders, as in expressing horror, dissatisfaction, aversion, &c.

They grin, they shrug,  
They bow, they snarl, they scratch, they hug.  
*Swift.*

SHRUG, *n.* A drawing up of the shoulders; a motion usually expressing dislike.

The Spaniards talk in dialogues  
Of heads and shoulders, nods, and shrugs.  
*Hudibras.*

SHRUG'GING, *pp.* Drawing up, as the shoulders.

SHRUNK, *pret.* and *pp.* of *Shrink*.

SHRUNK'EN, *pp.* of *Shrink*. [*Nearly obsolete.*]

SHUCK, *n.* The husk or shells of grain.

SHUD'DER, *v. i.* [*G. schaudern, schüt-teln; D. schudden*. This word contains the same elements as the *L. quatit*.] To quake; to tremble or shake with fear, horror, or aversion; to shiver.

SHUD'DER, *n.* A tremour; a shaking with fear or horror.

SHUD'DERING, *pp.* or *a.* Trembling or shaking with fear or horror; quaking.

SHUD'DERINGLY, *adv.* With tremour;

SHUFFLE, *v. t.* [*D. schoffelen*, to shove, to shovel, to shuffle; *dim.* of *Shove*. See *SHOVE* and *SCUFFLE*.] 1. Properly, to shove one way and the other; to push from one to another; as, to shuffle money from hand to hand.—2. To mix by pushing or shoving; to

confuse; to throw into disorder; especially, to change the relative positions of cards in the pack.

A man may shuffle cards or rattle dice from noon to midnight, without tracing a new idea in his mind.  
*Rambler.*

3. To remove or introduce by artificial confusion.

It was contrived by your enemies, and shuffled into the papers that were seized.  
*Dryden.*

To shuffle off, to push off; to rid one's self of. When you lay blame to a child, he will attempt to shuffle it off.—To shuffle up, to throw together in haste; to make up or form in confusion or with fraudulent disorder; as, he shuffled up a piece.

SHUFFLE, *v. i.* To change the relative position of cards in a pack by little shoves; as, to shuffle and cut.—2. To change the position; to shift ground; to prevaricate; to evade fair questions; to practise shifts to elude detection.

Hiding my honour in my necessity, I am fain to shuffle.  
*Shak.*

3. To struggle; to shift.

Your life, good master,  
Must shuffle for itself.  
*Shak.*

4. To move with an irregular gait; as, a shuffling nag.—5. To shove the feet; to scrape the floor in dancing. [*Vulgar.*]

To shuffle off, to move off with low, short, irregular steps; to evade.—6. To evade doing some duty; to prevaricate. [*Familiar.*]

SHUFFLE, *n.* A shoving, pushing, or jostling; the act of mixing and throwing into confusion by change of places.

The unguided agitation and rude shuffles of matter.  
*Bentley.*

2. An evasion; a trick; an artifice.—3. In dancing, a rapid scraping movement with the feet; a compound sort of this is the double shuffle.

SHUFFLE-BOARD, the old spelling of *Shovel-board*.

SHUFFLE-CAP, *n.* A play performed by shaking money in a hat or cap.

SHUFFLED, *pp.* Moved by little shoves; mixed.

SHUFFLER, *n.* One that shuffles or prevaricates; one that plays tricks; one that shuffles cards.

SHUFFLING, *pp.* Moving by little shoves one way and the other; changing the places of cards; prevaricating; evading; playing tricks.—2. *a.* Evasive; as, a shuffling excuse.

SHUFFLING, *n.* The act of throwing into confusion, or of changing the relative position of things by shoving or motion.—2. Trick; artifice; evasion.—3. An irregular gait.

SHUFFLINGLY, *adv.* With shuffling; with an irregular gait or pace.

SHUMACH. See *SUMACH*.

SHUN, *v. t.* [*Sax. scunian, ascunian*; allied perhaps to *D. schuinen*, to slope.] 1. To avoid; to keep clear of; not to fall on or come in contact with; as, to shun rocks and shoals in navigation. In *shunning* Scylla, take care to avoid Charybdis.—2. To avoid; not to mix or associate with; as, to shun evil company.—3. To avoid; not to practise; as, to shun vice.—4. To avoid; to escape; as, to shun a blow.—5. To avoid; to decline; to neglect.

I have not shunned to declare the whole counsel of God; Acts xx.

SHUN'LESS, *a.* Not to be avoided; inevitable; unavoidable; as, shunless destiny. [*Little used.*]

SHUN'NED, *pp.* Avoided.

SHUN'NING, *ppr.* Avoiding; keeping clear from; declining.

SHUN'T, *n.* [Contraction of *shun it.*] In *railways*, a turning off to a short rail, that the principal rail may be left free.

SHUT, *v. t. pret. and pp. Shut.* [Sax. *scittan, scyttan*, to bolt or make fast, to shut in. This seems to be derived from or connected with *scytel*, a bolt or bar, a *scuttle*, *scytta*, a shooter, an archer, *scytan, sceotan, scottan*, to shoot, D. *schutzen*, to stop, defend, parry, pound, confine, which seems to be allied to *schutter*, a shooter. So in G. *schützen*, to defend, and *schütze*, a shooter, Dan. *skytter*, to defend; *skytte*, a shooter; Sw. *skydda*, to defend; *skytt*, a marksman. The sense of these words is expressed by *shoot*, and this is the primary sense of a bolt that fastens, from thrusting, driving.] 1. To close so as to hinder ingress or egress; as, to *shut* a door or gate; to *shut* the eyes or the mouth.—2. To prohibit; to bar; to forbid entrance into; as, to *shut* the ports of a kingdom by a blockade. Shall that be *shut* to man, which to the beast Is open? *Milton.*

3. To preclude; to exclude. But *shut* from every shore. *Dryden.*

4. To close, as the fingers; to contract; as, to *shut* the hand.—To *shut in*, to include; to confine.

And the Lord *shut* him in; Gen. vii.

2. Spoken of points of land, when by the progress of a ship, one point is brought to cover or intercept the view of another. It is then said, we *shut in* such a point, we *shut in* the land; or one point *shuts* in another.—To *shut out*, to preclude from entering; to deny admission to; to exclude; as, to *shut out* rain by a tight roof. An interesting subject occupying the mind, *shuts out* all other thoughts.—To *shut up*, to close; to make fast the entrances into; as, to *shut up* a house.—2. To obstruct.

Dangerous rocks *shut up* the passage. *Raleigh.*

3. To confine; to imprison; to lock or fasten in; as, to *shut up* a prisoner.—4. To confine by legal or moral restraint.

Before faith came we were kept under the law, *shut up* to the faith, which should afterward be revealed; Gal. iii.

5. To end; to terminate; to conclude. When the scene of life is *shut up*, the slave will be above his master, if he has acted better. *Collier.*

SHUT, *v. i.* To close itself; to be closed. The door *shuts* of itself; it *shuts* hard. Certain flowers *shut* at night and open in the day.

SHUT, *pp.* Closed; having the entrance barred.—2. *a.* Rid; clear; free.

SHUT, *n.* Close; the act of closing; as, the *shut* of a door; the *shut* of evening. [Little used.]—2. A small door or cover. But *Shutter* is more generally used.

SHUTTER, *n.* A person that shuts or closes.—2. A door; a cover; something that closes a passage.—3. In *arch.*, *shutters* are the boards which close the aperture of a window. The shutters of principal windows are usually in two divisions or halves, each subdivided into others, so that they may be received within the boxings or reeds into which the shutters are folded or fall back. The front shutter is of the exact breadth of the boxing, and also flush with it; the others, which are hidden in the boxing, are somewhat less in breadth, and are termed back-

folks or backflaps. Shutters may be considered as the doors of window openings, and are formed upon the same principles as doors. [See BOXINGS OF A WINDOW.]

SHUTTING, *ppr.* Closing; prohibiting entrance; confining.

SHUTTING, *n.* In *anchor-making*, the act of joining or welding one piece of iron to another.

SHUTTLE, *n.* [from the root of *shoot*; Ice. *shutull.*] An instrument used by weavers for passing or shooting the thread of the wool in weaving from one side of the cloth to the other, between the threads of the warp. In the middle of the shuttle is a kind of cavity, called its eye or chamber, in which is enclosed the *spool*, which is part of the thread destined for the woof.—*Fly-shuttle*, an improved kind of shuttle contrived by John Kay of Lancashire, in 1738, and so named from the rapidity with which it can be wrought. In throwing the common hand shuttle both hands must be used alternately, and the process is consequently slow; but the fly-shuttle, by means of an apparatus connected with it, can be propelled from side to side of the web with great rapidity by one hand only, the other being occupied in managing the lay.

SHUTTLE-CKOCK, *n.* [*shuttle* and *cork* or *cork.*] A cork stuck with feathers, made to be struck by a battledore in play; also, the play.

SHWAN'PAN, *n.* The calculating instrument of the Chinese. It is similar in shape and construction to the Roman abacus, and is used in the same manner.

SHY, *a.* [G. *scheu*, shy; *scheuchen* to scare, and *scheuen*, to shun; D. *schuw*, shy; *schuwen*, to shun; Sw. *skugg*, shy and *sky*, to shun; Dan. *sky*, shy, and *skyer*, to shun, to eschew. In Sp. *esquivo* is *shy*, and *esquivar*, to shun; It. *schifo*, shy, and *schifare*, to shun. The two last mentioned languages have a labial for the last radical, but possibly the words may be of the same family. The G. *scheuchen*, to scare, is our *shough*, a word used for scaring away fowls.] 1. Fearful of near approach; keeping at a distance through caution or timidity; shunning approach; as, a *shy* bird.

She is represented in a *shy* retiring posture. *Addison.*

2. Reserved; not familiar; coy; avoiding freedom of intercourse.

What makes you so *shy*, my good friend? *Arbutnot.*

3. Cautious; wary; careful to avoid committing one's self or adopting measures.

I am very *shy* of using corrosive liquors in the preparation of medicines. *Boyle.*

4. Suspicious; jealous. Princes are by wisdom of state some what *shy* of their successors. *Wotton.*

SHY, *v. i.* In *horsemanship*, to turn aside or start away from any object that causes fear; as, a horse *shies* at a post.—To *shy one*, in an active sense, is to shun or avoid him. [Low or Colloq.] SHY, *v. t.* To throw; as, to *shy* a stone at one. [Vulgar.]

SHY'ING, *ppr.* The act of starting aside; as, a horse given to *shying*.

SHY'LY, *adv.* In a shy or timid manner; not familiarly; with reserve.

SHY'NESS, *n.* Fear of near approach or of familiarity; reserve; coyness.

SI. In *music*, the name for the seventh sound added by Le Maire, a French-

man, at the latter end of the seventeenth century, to the six ancient notes, ut, re, mi, fa, sol, la, of Guido. SIALOGOGUE, *n.* (*sial'ogog.*) [Gr. *σάλων*, saliva, and *αγωγος*, leading.] A medicine that promotes the salivary discharge. Sialogogues are divided into *local* and *remote*. Of the local some are *gaseous*, and are called *masticatories*, and others solid; as scilla, nicotiana, piper, &c. Remote sialogogues are first received into the system by the stomach or other channels, and these exert a peculiar influence on the salivary glands; such are the various preparations of mercury.

SIB, *† a.* [Sax. *sib*, *syb*, *sybbe*, peace, quietness, concord, agreement, kindred, alliance, affinity.] Akin; in affinity; related by consanguinity. [Retained in the *Scottish dialect.*]

SIBBAL'DIA, *n.* A genus of hardy trailing shrubs, and perennial herbs; of the class Pentandria, and order hexagynia, Linn.; nat. order Rosaceæ. *S. procumbens* is a British plant, and found on the summits of the higher mountains of Scotland.

SIB'BENS, or SIV'VENS, *n.* A disease which is endemic in some of the western counties of Scotland. It strikingly resembles the yaws in many respects, but entirely differs in others. It is propagated, like syphilis, by the direct application of contagious matter. This disease has not yet been thoroughly investigated.

SIBERIAN, *a.* [Russ. *siver*, north. *Siberia* is formed by annexing the Greek *ta*, country, from the Celtic, to *siver*, north.] Pertaining to *Siberia*, a name given to a great and indefinite extent of territory in the north of Asia; as, a *Siberian* winter.

SIB'ERITE, *n.* Red tourmalin, or rubellite.

SIB'ILANT, *a.* [L. *sibilo*, to hiss, Fr. *siffler*.] Hissing; making a hissing sound. *S* and *z* are called *sibilant* letters.

SIB'ILANT, *n.* A letter that is uttered with a hissing of the voice; as *s* and *z*. SIBILATION, *n.* A hissing sound.

SIBTHORP'IA, *n.* A genus of plants, named after Dr. Humphry Sibthorp, formerly professor of botany at Oxford. It belongs to the nat. order Scrophulariaceæ, and consists of small, creeping, rooting, tufted herbs, with small alternate uniform leaves, and axillary, solitary, inconspicuous flowers. *S. Europæa* is a native of Europe, and is found in Portugal, Spain, and France, and in Devonshire and Cornwall, in England, where it is known by the name of Cornish money-wort.

SIB'YL, *n.* [from the L.] In *pagan antiquity*, the Sibyls were certain women said to be endowed with a prophetic spirit. Their number is variously stated; but the opinion of Varro, who states them to have been ten, is generally adopted. These ten Sibyls resided in Persia, Lybia, Delphi, Cumæ in Italy, Erythraea, Samos, Cumæ in Æolia, Marpessa on the Hellespont, Ancyra in Phrygia, and Tiburtis. The most celebrated were the Sibyl of Cumæ, fabled to have been consulted by Æneus, and the prophetess who offered her books to Tarquin the Proud. It is pretended that they wrote certain prophecies on leaves in verse, which are called Sibylline verses, Sibylline oracles, or Sibylline books. They were supposed to contain the fate of the

Roman empire, and were held in great authority by the Romans. Sibylline verses are often quoted by Christian



Sibyl of Delphi.

writers, as containing prophecies respecting Christianity, but these are spurious, a forgery of the second century. **SIBYLLINE**, *a.* Pertaining to the Sibyls; uttered, written, or composed by Sibyls; prophetic; as, *Sibylline leaves*, *Sibylline oracles*, *Sibylline verses*.

**SIC**, *adv.* [L.] Thus, or it is so; as, *sic* in the work (or the MS.) quoted; or, briefly, *sic*.

**SIC TRANSIT GLORIA MUNDI**. [L.] Thus passes away the glory of the world.

**SIC'AMORE**, *n.* More usually written *Sycamore*,—*which see*.

**SIC'GATE**, *† v. t.* To dry.

**SICGA'TION**, *† n.* The act or process of drying.

**SIC'GATIVE**, *a.* [from L. *sicco*, to dry, Fr. *secher*.] Drying; causing to dry.

**SIC'GATIVE**, *n.* That which promotes the process of drying.

**SICCIF'IC**, *a.* Causing dryness.

**SIC' CITY**, *n.* [L. *siccitas*.] Dryness; aridity; destitution of moisture; as, the *siccity* of the flesh or of the air.

**SICE**, *n.* (size.) [Fr. *siz*.] The number six at dice.

**SICH**, for *Such*. [See **SUCH**.]

**SICILLANO**, in *music*, a composition in measures of  $\frac{3}{4}$  or  $\frac{6}{8}$ , to be performed in a slow and graceful manner.

**SICILIAN VESPERS**, *n.* In *modern hist.*, the name commonly given to the great massacre of the French in Sicily in the year 1282. The insurrection which led to this massacre, broke out on the evening of Easter Tuesday, whence the name.

**SICK**, *a.* [Sax. *seoc*; Ice. *syke*.] 1. Affected with nausea; inclined to vomit; as, *sick* at the stomach. [This is probably the primary sense of the word.] Hence,—2. Disgusted; having a strong dislike to; with *of*; as, to be *sick of* flattery; to be *sick of* a country life.

He was not so *sick of* his master as of his work. *L' Etrange*.

3. Affected with disease of any kind; not in health; followed by *of*; as, to be *sick of* a fever. [Little used.]—4. Corrupted. [Not in use nor proper.]—5. The *sick*, the person or persons affected with disease. *The sick* are healed.

**SICK**, *† v. t.* To make sick. [See **SICKEN**.]

**SICK'BERTH**, *n.* In a ship of war, an apartment for the sick.

**SICK'-BRAINED**, *a.* Disordered in the brain.

**SICKEN**, *v. t.* (sik'n.) To make sick; to disease.

Raise this to strength, and *sicken* that to death. *Prior*.

2. To make squeamish. It *sickens* the stomach.—3. To disgust. It *sickens* one to hear the fawning sycophant.—4. † To impair.

**SICK'EN**, *v. i.* To become sick; to fall into disease.

The judges that sat upon the jail, and those that attended, *sickened* upon it and died. *Bacon*.

2. To be satiated; to be filled to disgust.—3. To become disgusting or tedious.

The toiling pleasure *sickens* into pain.

*Goldsmith*.

4. To be disgusted; to be filled with aversion or abhorrence. He *sickened* at the sight of so much human misery.—5. To become weak; to decay; to languish. Plants often *sicken* and die.

All pleasures *sicken*, and all glories sink. *Pope*.

**SICK'ENED**, *pp.* Made sick.

**SICK'ENING**, *ppr.* Becoming sick; making sick.—2. Disgusting.

**SICK'ER**, *† a.* [L. *securus*; Dan. *sikher*; G. *sicher*.] Sure; certain; firm.

**SICK'ER**, *† adv.* Surely; certainly.

**SICK'ERLY**, *† adv.* Surely.

**SICK'ERNES**, *† n.* Security.

**SICK'ISH**, *a.* [from *sick*.] Somewhat sick or diseased.—2. Exciting disgust; nauseating; as, a *sickish* taste.

**SICK'ISHLY**, *adv.* In a sickish manner.

**SICK'ISHNESS**, *n.* The quality of exciting disgust.

**SICKLE**, *n.* (sik'l.) [Sax. *sicel*, *sicol*; G. *sichel*; D. *zihkel*; Gr.  $\sigma\iota\kappa\iota\lambda\iota\sigma$ ,  $\zeta\alpha\gamma\kappa\lambda\omicron\sigma$ ; L. *sicula*, from the root of *seco*, to cut.] A reaping-hook; an instrument used in agriculture for cutting down corn.

It is simply a curved blade or hook of steel with a handle, and having the edge of the blade in the interior of the curve.

Thou shalt not move a *sickle* to thy neighbour's standing corn; Deut. xxiii.

**SICK'LED**, *a.* Furnished with a sickle.

**SICK'LEMAN**, *n.* One that uses a **SICK'LER**, } sickle; a reaper.

**SICK'LE-SHAPED**, *a.* Shaped like a sickle.

**SICK'LE-WÖRT**, *n.* A plant of the genus *Coronilla*.

**SICK'LINESS**, *n.* [from *sickly*.] The state of being sickly; the state of being habitually diseased; applied to persons.

—2. The state of producing sickness extensively; as, the *sickliness* of a season.—3. The disposition to generate disease extensively; as, the *sickliness* of a climate.

**SICK'-LIST**, *n.* A list containing the names of the sick.

**SICK'LY**, *a.* Not healthy; somewhat affected with disease; or habitually in disposed; as, a *sickly* person, or a *sickly* constitution; a *sickly* plant.—2. Producing disease extensively; marked with sickness; as, a *sickly* time; a *sickly* autumn.—3. Tending to produce disease; as, a *sickly* climate.—4. Faint; weak; languid.

The moon grows *sickly* at the sight of day. *Dryden*.

**SICK'LY**, *† v. t.* To make diseased.

**SICK'LY**, *adv.* Not in health; not soundly, faintly, languidly.

**SICK'NESS**, *n.* [G. *sucht*.] 1. A parti-

cular state of the stomach which occurs under three forms,—nausea, retching, and vomiting.—2. State of being diseased.

I do lament the *sickness* of the king.

*Shak*.

3. Disease; malady; a morbid state of the body of an animal or plant, in which the organs do not perfectly perform their natural functions. [In this sense little used at the present day.]

Trust not too much your now resistless charms;

Those age or *sickness* soon or late disarms. *Pope*

Himself took our infirmities, and bore our *sicknesses*; Matt. viii.

**SID'A**, *n.* A genus of plants belonging to the nat. order Malvaceæ. The species are very numerous, and very extensively distributed throughout the warm parts of the world, and are abundant in the peninsula and plains of India. They abound in mucilage like all malvaceous plants, and some of them have tough ligneous fibres, which are employed for the purposes of cordage in different countries; as *S. rhomboidea*, *rhombifolia*, *periplocifolia*, and *tiliacifolia*. *S. indica*, *astatica*, and *populifolia*, are employed in India as demulcents. The chewed leaves of *S. carpinifolia*, are applied in Brazil to the stings of wasps and bees. At Rio Janeiro, the straight shoots of *S. macrantha* are employed as rocket-sticks.

**SIDE**, *n.* [Sax. *sida*, *side*, *sida*, a side, also wide, like L. *latus*; D. *zyde*, side, flank, page; *zid*, far; G. *seite*; Sw. *sida*; Dan. *side*, a side; *sid* or *stid*, long, trailing; *sidst*, last; Scot. *side*, long. These words indicate the radical sense to be to extend, dilate, or draw out.] 1. The broad and long part or surface of a thing, as distinguished from the *end*, which is of less extent and may be a point; as, the *side* of a plank; the *side* of a chest; the *side* of a house or of a ship. One *side* of a lens may be concave, the other convex. *Side* is distinguished from *edge*; as, the *side* of a knife or sword.—2. Margin; edge; verge; border; the exterior line of any thing, considered in length; as, the *side* of a tract of land or a field, as distinct from the *end*. Hence we say, the *side* of a river; the *side* of a road.—3. The part of an animal between the back and the face and belly; the part on which the ribs are situated; as, the *right side*; the *left side*.

This in quadrupeds is usually the broadest part.—4. The part between the top and bottom; the slope, declivity, or ascent, as of a hill or mountain; as, the *side* of Mount Etna.—5. One part of a thing, or its superficies, as seen by the eye; as, the *side* of a ball or sphere.—*Side*, in *geom.*, is used for any line which forms one of the boundaries of a right-lined figure; as, the *side* of a triangle, square, &c. Also, any of the bounding surfaces of a solid is termed a *side*; as, the *side* of a parallelepiped, prism, &c.—6. Any part considered in respect to its direction or point of compass; as, to whichever *side* we direct our view. We see difficulties on every *side*.—7. Party; faction; sect; any man or body of men considered as in opposition to another. One man enlists on the *side* of the Tories; another on the *side* of the Whigs. Some persons change *sides* for

the sake of popularity and office, and sink themselves in public estimation. And sets the passions on the *side* of truth.

Pope.

8. Interest; favour.

The Lord is on my *side*; Ps. cxviii

9. Any part being in opposition or contradistinction to another; *used of persons or propositions*. In that battle, the slaughter was great on both *sides*. Passion invites on one *side*; reason restrains on the other.

Open justice bends on neither *side*.

Dryden.

10. Branch of a family; separate line of descent; as, by the father's *side* he is descended from a noble family; by the mother's *side* his birth is respectable.—11. Quarter; region; part; as, from one *side* of heaven to the other.—To take *sides*, to embrace the opinions or attach one's self to the interest of a party when in opposition to another.—To choose *sides*, to select parties for competition in exercises of any kind.

SIDE, *a.* Lateral; as, a *side* post; but perhaps it would be better to consider the word as compound.—2. Being on the side, or toward the side; oblique; indirect.

The law hath no *side* respect to their persons.

Hooker.

One mighty squadron with a *side* wind sped.

Dryden.

So we say, a *side* view, a *side* blow.—3. † Large; extensive.

SIDE, *v. i.* To lean on one side. [Little used.]—2. To embrace the opinions of one party or engage in its interest, when opposed to another party; often followed by *with*; as, to *side* with the ministerial party.

All *side* in parties and begin th' attack. Pope.

SIDE, † *v. t.* To stand at the side of.—2. † To suit; to pair.

SIDE-BAR, *n.* In the court of session, the name given to the bar in the outer parliament house, at which the lords ordinary were in use to call their hand-rolls.

SIDEBOARD, *n.* [*side* and *board*.] A piece of furniture or cabinet work consisting of a table or box with drawers or cells placed at the side of a room or in a recess, and used to hold dining utensils, &c.—2. In *joinery*, the board placed vertically which forms the side of the bench next to the workman. It is pierced with holes ranged at different heights in diagonal directions, so as to admit of pins for holding up one end of the object to be planed, the other end being supported by the bench-screw.

SIDE-BOX, *n.* [*side* and *box*.] A box or inclosed seat on the side of a theatre, distinct from the seats in the pit.

SIDE-CUT, *n.* A canal branching out from the main one. [American.]

SIDE-CUTTING, *n.* A term applied in a double sense in engineering. 1. An excavation made along the side of a canal or railroad in order to obtain material to form an embankment.—2. The formation of a road or canal along the side of a slope, where the centre of the work being nearly on the surface, the ground requires to be cut only on the upper side to form one half of the work, while the material thrown down forms the other half in embankment. This is sometimes called *side-forming*.

SIDE-FLY, *n.* An insect.

SIDE-HOOK, *n.* In *joinery*, a rectan-

gular prismatic piece of wood, with a projecting knob at the ends of its opposite sides. The use of the side-hook is to hold a board fast, its fibres being in the direction of the length of the bench, while the workman is cutting across the fibres with a saw or grooving plane, or in *traversing* the wood, which is planing it in a direction perpendicular to the fibres.

SIDELONG, *a.* [*side* and *long*.] Lateral; oblique; not directly in front; as, a *sidelong* glance.

SIDELONG, *adv.* Laterally; obliquely; in the direction of the side.—2. On the side; as, to lay a thing *sidelong*.

SIDE-POSTS, *n.* In *arch*, a kind of truss-posts placed in pairs, each disposed at the same distance from the middle of the truss, for the purpose of supporting the principal rafters, braces, crown or camber beams, as well as for hanging the tie-beam below. In extended roofs two or three pairs of side-posts are used.

SIDER, † *n.* One that takes a side or joins a party.

SIDERATED, *a.* [L. *sideratus*.] Blast-ed; planet-struck.

SIDERATION, *n.* [L. *sideratio*; *sidero*, to blast, from *sidus*, a star.] A blasting or blast in plants; a sudden deprivation of sense; an apoplexy; a slight erysipelas; † A sphacelus, or a species of erysipelas, vulgarly called a *blast*.

SIDERAL, } *a.* [L. *sideralis*, from

SIDERAL, } *sidas*, a star.] 1. Pertaining to a star or stars; astral; as, *sideral* light.—2. Containing stars; starry; as, *sideral* regions.—*Sideral day*, the time in which the earth makes a complete revolution on its axis in respect of the fixed stars; or it is the time which elapses between the instant when a star is in the meridian of a place, and the instant when it arrives at the meridian again. This period is always the same, and is about four minutes less than the mean solar day.—*Sideral year*, in *astron.*, the period in which the fixed stars apparently complete a revolution and come to the same point in the heavens. Or it is the time that elapses between the sun's leaving any fixed star, and his return to the same star. It is equal to 365 d. 6 h. 9 m. 9.6 sec., being 19.9 sec. longer than the tropical year.—*Sideral time* is equal to 1.00273791 × mean solar time.—*Mean solar time* is equal to 0.99726957 × *sideral time*.—*Sideral magnetism*, according to the believers in animal magnetism, the beneficial influence of the stars upon patients.

SIDERISMUS, *n.* [from *sideros*, iron.] The name given by the believers in animal magnetism to the effects produced by bringing metals and other inorganic bodies into a magnetic connection with the human body.

SIDERITE, *n.* [L. *sideritis*; Gr. *id.*, from *sidus*, iron.] 1. The loadstone; also, iron-wort, a plant; also, the common ground pine, (*Teucrium chamaepitys*, Linn.)—2. In *min.*, a phosphate of iron.

SIDERITIS, *n.* Iron-wort, a genus of plants belonging to the nat. order Lamiales. The species are numerous, and are inhabitants of Europe, and the northern parts of Asia; they consist of herbs and shrubs, with small yellowish flowers arranged in whorls.—*S. canariensis*, or canary iron-wort, and *S. syriaca*, Syrian or sage-leaved iron-wort, are cultivated in gardens. In

both species the leaves are clothed with a villous wool on both surfaces.

SIDERO-CAL'CITE, *n.* The brown spar of Werner.

SIDEROCLEP'TE, *n.* A mineral of a yellowish green colour, soft and translucent, occurring in reniform or botryoidal masses.

SIDERODENDRON, *n.* [Gr. *sidus*, iron, and *δένδρον*, a tree.] The iron-wood tree. [See SIDERONYLON.]

SIDEROGRAPHIC, } *a.* [See Si-

SIDEROGRAPHICAL, } DEROGRAPHY.] Pertaining to siderography, or performed by engraved plates of steel; as, *siderographic* art; *siderographic* impressions.

SIDEROGRAPHER, *n.* One who engraves steel plates, or performs work by means of such plates.

SIDEROGRAPHY, *n.* [Gr. *sidus*, steel, or iron, and *γραφω*, to engrave.] The art or practice of engraving on steel, by means of which, impressions may be transferred from a steel plate to a steel cylinder in a rolling press of a particular construction.

SIDE ROMANCY, *n.* [Gr. *sidus*, iron, and *μαντεία*, divination.] A species of divination performed by burning straws, &c., upon red-hot iron. By observing their figures, bendings, sparking, and burning, prognostics were obtained.

SIDE ROSCOPE, *n.* [Gr. *sidus*, iron, and *σκοπεω*, to view or explore.] An instrument invented in France, for detecting small quantities of iron in any substance, mineral, vegetable, or animal.

SIDEROXYLON, *n.* [Gr. *sidus*, iron, and *ξύλον*, wood.] A genus of plants belonging to the nat. order Sapotaceae. The species are natives of Africa, America, the East Indies, and New Holland. They are evergreen trees, with axillary and lateral fascicles of flowers. They are remarkable for the hardness and weight of their wood, which sinks in water; and the genus has hence derived the name of iron-wood. The *S. incense*, or smooth iron-wood, is a native of the Cape of Good Hope, and has long been cultivated in the green-houses of Europe.

SIDERUM, *n.* [L. from Gr. *sidus*, iron.] The name given by Bergman to phosphure of iron.

SIDE-SADDLE, *n.* [*side* and *saddle*.] A saddle for a woman's seat on horseback.

SIDE-SADDLE-FLOWER, *n.* A species of Sarracenia, or Sarrazinia.

SIDE-SCRIPTION, *n.* In *Scots law*, before the introduction of the present system of writing deeds "bookwise," the sheets were pasted together at length, and in order to authenticate them, the party was required to sign his name at each junction, half on one sheet and half on the other. This was called *side-scription*.

SIDESMAN, *n.* [*side* and *man*.] An assistant to the churchwarden.—2. A party man.

SIDE-TABLE, *n.* A table placed either against the wall, or aside from the principal table.

SIDETAKING, *n.* A taking sides, or engaging in a party.

SIDEWAYS, } *adv.* [*side* and *way*; but SIDEWISE, } *sidewise* is the proper combination.] 1. Toward one side; inclining; as, to hold the head *sidewise*.

—2. Laterally; on one side; as, the refraction of light *sidewise*.

SIDING, *ppr.* Joining one side or party.

**SIDING, n.** The attaching of one's self to a party.—2. In *engineering*, a short additional line of rails laid at the side of a main line, and so joined to it at each end that a carriage may either pass into the siding or continue its course along the line. [See RAILWAY.]

**SIDDLE, v. t.** To go or move side foremost; as, to *siddle* through a crowd.—2. To lie on the side.

**SIDLING, adv.** [from *sidle*; D. *zydelings*.] 1. Sidewise; with the side foremost; as, to go *siddling* through a crowd. It may be used as a participle; as, I saw him *siddling* through the crowd.—2. Sloping.

**SIEGE, n.** [Fr. *siège*, a seat, a siege, the see of a bishop; Norm. *sage*, a seat; Arm. *sich*, *sicha*, *sich enn*. The radical sense is to set, to fall or to throw down; Sax. *sgan*, to fall, set, or rush down. These words seem to be connected with *sink*, and with the root of *seal*, L. *sigillum*.] 1. The setting of an army around or before a fortified place for the purpose of compelling the garrison to surrender; or the surrounding or investing of a place by an army, and approaching it by passages and advanced works, which cover the besiegers from the enemy's fire. A *siege* differs from a *blockade*, as in a *siege* the investing army approaches the fortified place to attack and reduce it by force; but in a *blockade*, the army secures all the avenues to the place to intercept all supplies, and waits till famine compels the garrison to surrender.—2. Any continued endeavour to gain possession.

Love stood the *siège*, and would not yield his breast. *Dryden*.

3 † Seat; throne.—4. † Rank; place; class.—5. † Stool.—6. The bench or other support on which a mason places his stone to be hewn. A banker or mason's bench.

**SIEGE, † v. t.** To besiege.

**SIE'NITE, } n.** A compound granular  
**SY'ENITE, } rock composed of quartz,**  
hornblende, and feldspar, of a grayish colour; so called, because there are many ancient monuments consisting of this rock, brought from Syene, in Upper Egypt. *Sienite* often bears the general aspect of a granite, but it is the presence of hornblende as a constituent part which distinguishes this rock from certain granites that accidentally contain hornblende. It frequently contains mica, and occasionally talc, and epidote. The structure of *sienite* is commonly granular, but the grains are sometimes coarse, and sometimes very fine.

**SIENITIC, a.** Containing *sienite*; resembling *sienite* or possessing some of its properties.—*Sienitic granite* contains hornblende; *sienitic porphyry* is fine-grained *sienite* containing large crystals of feldspar.

**SIER'RA, a.** [Sp.] A word, meaning *saw*, introduced by the Spaniards into geography, to designate a mass of mountains with jagged ridges.

**SIES'TA, n.** [Sp.] The name given to the practice indulged in by the Spaniards, and the inhabitants of hot countries generally, of resting two or three hours in the middle of the day or after dinner, when the heat is too oppressive to admit of their going from home.

**SIEUR, n.** [Fr.] A title of respect used by the French.

**SIEVE, n.** (siv.) [Sax. *sife*, *syfe*; G. *sieb*; D. *zeef*, *zift*; the *sifter*. See **SIFT**.] An instrument for separating the

smaller particles of substances from the grosser; as flour from bran. Sieves are made of various forms and sizes, to suit the article to be sifted; but in its most usual form, a sieve consists of a hoop from two to six inches in depth, forming a flat cylinder, and having its bottom, which is stretched tightly over the hoop, constituted of basket-work, coarse or fine hair, gut, skin perforated with small holes, canvas, muslin, lawn, net-work, or wire, according to the use intended. In *agriculture*, sieves are used for separating corn or other seed from dust, or other extraneous matter.—*Drum-sieve*, a kind of sieve in extensive use amongst druggists, dyersalters, and confectioners, so named from its form. It is used for sifting very fine powders, and consists of three parts or sections, the top and bottom sections being covered with parchment or leather, and made to fit over and under a sieve of the usual form, which is placed between them. The substance to be sifted being thus closed in, the operator is not annoyed by the clouds of powder which would otherwise be produced by the agitation, and the material under operation is at the same time saved from waste.

**SIFT, v. t.** [Sax. *sifan*; G. *sieben*.] 1. To separate by a sieve, as the fine part of a substance from the coarse; as, to *sift* meal; to *sift* powder; to *sift* sand or lime.—2. To separate; to part.—3. To examine minutely or critically; to scrutinize. Let the principles of the party be thoroughly *sifted*.

We have *sifted* your objections. *Hooker*.

**SIFT'ED, pp.** Separated by a sieve; purified from the coarser parts; critically examined.

**SIFTER, n.** One that sifts; that which sifts; a sieve.

**SIFTING, ppr.** Separating the finer from the coarser part by a sieve; critically examining.

**SIG, a** Saxon word signifying victory, is used in names, as in *Sigbert*, bright victory. It answers to the Greek  $\nu\iota\kappa$  in *Nicander*, and the L. *vic*, in *Victorinus*.  
**SIGH, v. i.** [Sax. *sican*, to sigh; D. *zucht*, a sigh; *zuyten*, to sigh; allied perhaps to *suck*, a drawing in of the breath.] To inhale and respire audibly, as from grief; to suffer a deep single respiration.

He *sighed* deeply in his spirit; *Mark viii*.

**SIGH, v. t.** To lament; to mourn.

Agēs to come and men unborn  
Shall bless her name and *sigh* her fate. *Prior*.

2. To express by sighs.

The gentle swain *sighs* back her grief. *Hoole*.

**SIGH, n.** A single deep respiration; a long breath; the inhaling of a larger quantity of air than usual; and the sudden emission of it. This is an effort of nature to dilate the lungs and give vigour to the circulation of the blood, when the action of the heart and arteries is languid from grief, depression of spirits, weakness, or want of exercise. Hence, *sighs* are indications of grief or debility.

**SIGHER, n.** One that sighs.

**SIGHING, ppr.** Suffering a deep respiration; taking a long breath.

**SIGHING, n.** The act of suffering a deep respiration, or taking a long breath.

**SIGHTINGLY, adv.** With sighing.

**SIGHT, n.** [Sax. *gesiht*, with a prefix; D. *geziht*; G. *sicht*; Sw. *sicht*, from the root of *see*.] 1. The act of seeing; perception of objects by the eye; view; as, to gain *sight* of land; to have a

*sight* of a landscape; to lose *sight* of a ship at sea.

A cloud received him out of their *sight*; *Acts i*.

2. The faculty of vision, or of perceiving objects by the instrumentality of the eyes. It has been doubted whether moles have *sight*. Milton lost his *sight*. The *sight* usually fails at or before fifty years of age.

O loss of *sight*, of thee I most complain.

*Milton*.

3. Open view; the state of admitting unobstructed vision; a being within the limits of vision. The harbour is in *sight* of the town; a mountain is or is not within *sight*; an engagement at sea is within *sight* of land.—4. Notice from seeing; knowledge; as, a letter intended for the *sight* of one person only.—5. Eye; the instrument of seeing. From the depth of hell they lift their *sight*.

*Dryden*.

6. A small aperture through which objects are to be seen; as, the *sight* of a quadrant.—7. That which is beheld; a spectacle; a show; particularly, something novel and remarkable; something wonderful.

They never saw a *sight* so fair. *Spenser*.  
Moses said, I will now turn aside and see this great *sight*, why the bush is not burned; *Exod. iii*.

Fearful *sights* and great signs shall there be from heaven; *Luke xxi*.

8. A small piece of metal fixed on the muzzle of a musket, &c., to aid the eye in taking aim.—At *sight*, in *mercantile affairs*, when presented; as, a bill of exchange payable at *sight*.—To take *sight*, to take aim; to look for the purpose of directing a piece of artillery, &c.—To take a *sight* of, to take a look at; to view; to examine. [Familiar.]

**SIGHT, v. t.** In *navigators' language*, to come in sight or view of; as, we *sighted* Madeira, but did not touch at it.

**SIGHTED, a.** In *composition only*, having sight, or seeing in a particular manner; as, *long-sighted*, seeing at a great distance; *short-sighted*, able to see only at a small distance; *quich-sighted*, readily seeing, discerning, or understanding; *sharp-sighted*, having a keen eye or acute discernment.

**SIGHTFULNESS, †** n. Clearness of sight.

**SIGHTLESS, a.** Wanting sight; blind. Of all who blindly creep, or *sightless* soar.

*Pope*.

2. Offensive or unpleasing to the eye; as, *sightless* stains. [Not well authorized.] —3. † Not appearing to sight; invisible.

**SIGHTLESSLY, adv.** In a sightless manner.

**SIGHTLESSNESS, n.** Want of sight.

**SIGHTLINESS, n.** Comeliness; an appearance pleasing to the sight.

**SIGHTLY, a.** Pleasing to the eye; striking to the view.

Many brave *sightly* horses. *L'Estrange*.

2. Open to the view; that may be seen from a distance. We say, a house stands in a *sightly* place.

**SIGHTS'MAN, n.** Among *musicians*, one who reads music readily at first sight.

**SIG'IL, n.** [L. *sigillum*.] A seal; signature.

**SIGILLARIA, n.** [L. *sigillum*, a seal.] The name given by M. Brongniart, to certain large, and, in moderate vegetation, unknown forms of plants, discovered in the coal formation. They were so named from the peculiar impressions on the stems. The stems are of various sizes, from a few inches

to upwards of three feet in circumference, and of great length. They are

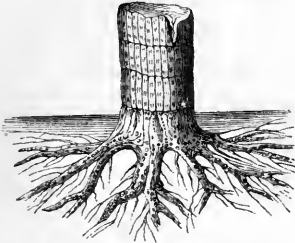

Stigmaria in a coal mine near Liverpool.

supposed to have been allied to *ferns*; and the roots seem to be the plant known by the name *stigmara*.

**SIGILLATIVE**, *a.* [Fr. *sigillatif*; L. *sigillum*.] Fit to seal; belonging to a seal; composed of wax.

**SIGMA**, *n.* The name of the Greek  $\Sigma$ ,  $\sigma$ . The Greeks originally used for this letter the form of the English C, and the Romans adopted this form for their tables. The most honourable places at the table were the extremities.

**SIGMOID**, or **SIGMOIDAL**, *a.* [Gr. *σῆμα* and *σῆμα*.] Curved like the Greek  $\Sigma$  sigma.—2. In *anat.*, a term applied to several parts, as the valves of the heart, the cartilages of the trachea, the semilunar cavities of the bones, and the flexure of the colon. The *sigmoid flexure* is the last curve of the colon, before it terminates in the rectum.

**SIGN**, *n.* (sine.) [Fr. *signe*; L. *signum*; Sax. *segen*; Arm. *sygn*, *syn*; Ir. *signin*; G. *zeichen*; Sans. *zaga*. From the last three words it appears that *n* is not radical; the elements being *Sg*. If so, and the G. *zeichen* is of this family, then we learn that *sign* is only a dialectical orthography of *token*, for *zeichen* is the D. *teeken*, Dan. *tegn*, Sw. *techen*, coinciding perhaps with Greek *δύναμις*.] 1. A token; something by which another thing is shown or represented; any visible thing, any motion, appearance, or event which indicates the existence or approach of something else. Thus we speak of *signs* of fair weather or of a storm, and of external marks which are *signs* of a good constitution.—2. A motion, action, nod, or gesture indicating a wish or command.

They made *signs* to his father, how he would have him called; Luke i.

3. A wonder; a miracle; a prodigy; a remarkable transaction, event, or phenomenon.

Through mighty *signs* and wonders; Rom. xv.

4. Some visible transaction, event, or appearance intended as proof or evidence of something else; hence, proof; evidence by sight.

Show me a *sign* that thou talkest with me; Judges vi.

5. Something hung or set near a house or over a door, to give notice of the tenant's occupation, or what is made or sold within; as, a trader's *sign*; a tailor's *sign*; the *sign* of the eagle.—

6. A memorial or monument; something to preserve the memory of a thing.

What time the fire devoured two hundred and fifty men, and they became a *sign*; Num. xxvi.

7. Visible mark or representation; as, an outward *sign* of an inward and spiritual grace.—8. A mark of distinction.—9. Typical representation; symbol.

The holy symbols or *signs* are not barely significative. *Brevewood.*

10. In *astron.*, the twelfth part of the ecliptic. The signs are reckoned from the point of intersection of the ecliptic and equator at the vernal equinox, and are counted onwards, proceeding from west to east, according to the annual course of the sun, all round the ecliptic. In *printing*, they are represented by the following marks, which are attached to their respective names:—Aries  $\Upsilon$ , Taurus  $\mathcal{T}$ , Gemini  $\Pi$ , Cancer  $\var�$ , Leo  $\mathcal{L}$ , Virgo  $\mathcal{M}$ , Libra  $\mathcal{L}$ , Scorpio  $\mathcal{M}$ , Sagittarius  $\mathcal{S}$ , Capricornus  $\mathcal{W}$ , Aquarius  $\mathcal{A}$ , Pisces  $\mathcal{X}$ .

The first six signs, commencing with Aries, are called *northern signs*, because they lie on the north side of the equator; and the other six, commencing with Libra, are called *southern signs*, because they lie on the south side of the equator. The six beginning with Capricornus are called *ascending signs*, because the sun passes through them while advancing from the winter to the summer solstice, and is consequently acquiring altitude with respect to inhabitants of the northern hemisphere. The other six, beginning with Cancer, are called *descending signs*, because the sun in passing through them diminishes his altitude with respect to inhabitants of the northern hemisphere. [See ECLIP-TIC.] These names are borrowed from the constellations of the zodiac of the same denomination, which were respectively comprehended within the foregoing equal divisions of the ecliptic, at the time when those divisions were first made; but on account of the precession of the equinoxes, the positions of these constellations in the heavens no longer correspond with the divisions of the ecliptic of the same name, but are considerably in advance of them.

Thus the constellation Aries is now in that part of the ecliptic called Taurus.—11. In *alge.*, a character indicating the relation of quantities, or an operation performed by them; as the sign + [plus] prefixed to a quantity, indicates that the quantity is to be added; the sign - [minus] denotes that the quantity to which it is prefixed is to be subtracted. The former is prefixed to quantities called *affirmative* or *positive*; the latter to quantities called *negative*. The sign  $\times$  [into] stands for multiplication,  $\div$  [divided by] for division,  $\surd$  for the square root,  $\sqrt[3]{}$  for the cube root,  $\sqrt[n]{}$  for the *n*th root, &c. The signs denoting a relation are, = equal to, > greater than,

< less than, &c.—12. The subscription of one's name; signature; as, a *sign manual*. *Sign manual* is a term particularly applied to the royal signature superscribed at the top of bills of grants or letters-patent.—13. Among *physicians*, an appearance or symptom in the human body, which indicates its condition as to health or disease.—14. In *music*, any character, as a flat, sharp, dot, &c.—*Sign manual*, one's own name written by himself. [See No. 12.]—*Sign*, or *sign of the cross*, a

ceremonial observance much in use among Roman Catholics and in the Greek church.

He dies, and makes no *sign*. *Shak.*

**SIGN**, *v. t.* (sine.) To mark with characters or one's name. To *sign a paper*, *note*, *deed*, &c., is to write one's name at the foot, or underneath the declaration, promise, covenant, grant, &c., by which the person makes it his own act. To *sign one's name* is to write or subscribe it on paper. Signing does not now include sealing.—2.† To signify; to represent typically.—3. To mark.—4. To signify by the hand; to move the hand for intimating something to another. To *sign with the cross*, is to perform a common Roman Catholic and Greek Catholic ceremonial observance.

**SIGN**,† *v. i.* To be a sign or omen.

**SIGNAL**, *n.* [Fr. *signal*; from L. *signum*.] A sign that gives or is intended to give notice; or the notice given. Signals are used to communicate notice, information, orders, and the like, to persons at a distance, and by any persons and for any purpose. A signal may be a motion of the hand, the raising of a flag, the fring of a gun, or any thing which being understood by persons at a distance, may communicate notice. Signals are particularly useful in the navigation of fleets and in naval engagements. There are *day-signals*, which are usually made by the sails, by flags and pendants, or guns; *night-signals*, which are lanterns, disposed in certain figures, or false fires, rockets, or the firing of guns; *fog-signals*, which are made by sounds, as firing of guns, beating of drums, ringing of bells, &c. There are signals of evolution, addressed to a whole fleet, to a division, or to a squadron; signals of movements to particular ships; and signals of service, general or particular. Signals used in an army are mostly made by a particular beat of the drum, or by the bugle.

**SIGNAL**, *a.* Eminent; remarkable; memorable; distinguished from what is ordinary; as, a *signal* exploit; a *signal* service; a *signal* act of benevolence. It is generally but not always used in a good sense.

**SIGNALFIRE**, *n.* A fire intended for a signal.

**SIGNALITY**,† *n.* Quality of being signal or remarkable.

**SIGNALIZE**, *v. t.* [from *signal*.] To make remarkable or eminent; to render distinguished from what is common. The soldier who *signalizes* himself in battle, merits his country's gratitude. Men may *signalize* themselves, their valour, or their talents.

**SIGNALIZED**, *pp.* Made eminent.

**SIGNALIZING**, *ppr.* Making remarkable.

**SIGNALLY**, *adv.* Eminently; remarkably; memorably; in a distinguished manner.

**SIGNATION**,† *n.* Sign given; act of betokening.

**SIGNATORY**, *a.* Relating to a seal; used in sealing.

**SIGNATURE**, *n.* [Fr. from L. *signo*, to sign.] 1. A sign, stamp, or mark impressed.

The brain being well furnished with various traces, *signatures* and images.

The natural and indelible *signature* of God, stamped on the human soul.

*Bentley.*

2. In *old medical writers*, an external mark or character on a plant, which was supposed to indicate its suitability to cure particular disease, or diseases of particular parts. Thus plants with yellow flowers were supposed to be adapted to the cure of jaundice, &c.

Some plants bear a very evident *signature* of their nature and use. *More.*

3. A mark for proof, or proof from marks.—4. Sign manual; the name of a person written or subscribed by himself.—5. Among *printers*, a letter or figure at the bottom of the first page of a sheet or half sheet, by which the sheets are distinguished and their order designated, as a direction to the binder.

Every successive sheet has a different letter or figure, and if the sheets are more numerous than the letters of the alphabet, then a small letter is added to the capital one; thus A a, B b. In large volumes, the signatures are sometimes composed of letters and figures; thus 5 A, 5 B. But some printers now use figures only for signatures.—6. In *physiognomy*, an external mark or feature by which some persons pretend

to discover the nature and qualities of a thing, particularly the temper and genius of persons.—7. In *music*, the flats and sharps placed after the clef at the beginning of the staff, which affect throughout the movement all notes of the same letter.—8. In *Scots law*, a writing prepared and presented by a writer to the signet to the Baron of Exchequer, as the ground of a Royal grant to the person in whose name it is presented; which having, in the case of an original charter the sign-manual of the sovereign, and in other cases the *cachet*, appointed by the act of union for Scotland, attached to it, becomes the warrant of a conveyance under one or other of the seals, according to the nature of the subject, or the object in view.

**SIGNATURE**, *v. t.* To mark; to distinguish.

**SIGNATORIST**, *n.* One who holds to the doctrine of signatures impressed upon objects, indicative of character or qualities. [*Little used.*]

**SIGN-BOARD**, *n.* A board on which a man sets a notice of his occupation or of articles for sale.

**SIGNED**, *pp.* Marked; subscribed.

**SIGNER**, *n.* One that signs or subscribes his name; as, a memorial with a hundred *signers*.

**SIGNET**, *n.* A seal; particularly in Great Britain; the seal used by the king in sealing his private letters, and grants that pass by bill under his majesty's hand. It is in the custody of the secretary of state for the home department. The *signet* in Scotland is the seal by which the king's letters and writs for the purpose of justice are now authenticated. Hence the title of *clerks to the signet*, or *writers to the signet*, whose business is nearly the same with that of attorneys in England. Their duty is to prepare the warrants of all charters of lands flowing from the crown; to sign all summonses for citing parties to appear in the court of session, and almost all diligences of the law for affecting the person or estate of a debtor, or for compelling implement of the decrees of the supreme court. They have further the privilege of acting as agents or attorneys in conducting causes before the court of session.—*Clerk of the*

*signet*, an officer in England continually in attendance upon the principal secretary of state, who has the custody of the privy signet.

**SIGNIFICANCE**, } *n.* [from L. *significatio*.] **SIGNIFICANT**, } *ficans.* See **SIGNIFICATORY**. 1. Meaning; import; that which is intended to be expressed; as, the *significance* of a nod, or of a motion of the hand, or of a word or expression.—2. Force; energy; power of impressing the mind; as, a duty enjoined with particular *significance*.—3. Importance; moment; weight; consequence.

Many a circumstance of less *significance* has been construed into an overt act of high treason. *Admim.*

**SIGNIFICANT**, *a.* [L. *significans*.] 1. Expressive of something beyond the external mark.—2. Bearing a meaning; expressing or containing signification or sense; as, a *significant* word or sound; a *significant* look.—3. Betokening something; standing as a sign of something.

It was well said of Plotinus, that the stars were *significant*, but not efficient.

*Rulegh.*

4. Expressive or representative of some fact or event. The passover among the Jews was *significant* of the escape of the Israelites from the destruction which fell on the Egyptians. The bread and wine in the sacrament are *significant* of the body and blood of Christ. 5. † Important; momentous.

**SIGNIFICANTLY**, *adv.* With meaning.—2. With force of expression.

**SIGNIFICATION**, *n.* [Fr. from L. *significatio*. See **SIGNIFY**.] 1. The act of making known, or of communicating ideas to another by signs or by words, by any thing that is understood, particularly by words.

All speaking or *signification* of one's mind, implies an act or address of one man to another. *South.*

2. Meaning; that which is understood to be intended by a sign, character, mark, or word; that idea or sense of a sign, mark, word, or expression which the person using it intends to convey, or that which men in general who use it, understand it to convey. The *signification* of words was originally arbitrary, and is dependent on usage. But when custom has annexed a certain sense to a letter or sound, or to a combination of letters or sounds, this sense is always to be considered the *signification* which the person using the word intends to communicate. So by custom certain signs or gestures have a determined *signification*. Such is the fact also with figures, algebraic characters, &c.

**SIGNIFICATIVE**, *a.* [Fr. *significatif*.] 1. Betokening or representing by an external sign; as, the *significative* symbols of the eucharist.—2. Having signification or meaning; strongly expressive; expressive of a certain idea or thing.

Neither in the degrees of kindred were they destitute of *significative* words. *Camden.*

**SIGNIFICATIVELY**, *adv.* So as to represent or express by an external sign.

**SIGNIFICATIVENESS**, *n.* The quality of being *significative*.

**SIGNIFICATOR**, *n.* That which signifies.

**SIGNIFICATORY**, *a.* That betokens.

**SIGNIFY**, *v. t.* That betokens, signifies, or represents.

**SIGNIFIED**, *pp.* Made known by signs or words.

**SIGNIFY**, *v. t.* [Fr. *signifier*; L. *significo*; *signum*, a sign, and *facio*, to make.] 1. To make known something, either by signs or words; to express or communicate to another any idea, thought, wish, purpose, or command, either by words, by a nod, wink, gesture, signal, or other sign. A man *signifies* his mind by his voice or by written characters; he may *signify* his mind by a nod or other motion, provided the person to whom he directs it, understands what is intended by it. A general or an admiral *signifies* his commands by signals to officers at a distance.—2. To mean; to have or contain a certain sense. The word sabbath *signifies* rest. *Less*, in composition, as in *faithless*, *signifies* destitution or want. The prefix *re*, in *recommend*, seldom *signifies* any thing.—3. To import; to weigh; to have consequence; *used in particular phrases*; as, it *signifies* much or little; it *signifies* nothing. What does it *signify*? What *signify* the splendours of a court? Confession of sin without reformation of life, can *signify* nothing in the view of God.—4. To make known; to declare.

The government should *signify* to the Protestants of Ireland, that want of silver is not to be remedied. *Swift.*

**SIGNIFY**, *v. i.* To express meaning with force. [*Little used.*]

**SIGNIFYING**, *ppr.* Making known by signs or words.

**SIGNING**, *ppr.* Marking; subscribing; signifying by the hand.

**SIGNOR**, } *n.* (see *nyur*.) A title of **SIGNOR**, } respect among the Italians, equivalent to the English *Lord*, *Sir*, or *Mr.*, the French *Monsieur*, and the German *Herr*. [See **SEIGNOR**.]

**SIGNORIZE**, *v. i.* (see *nyurize*.) To exercise dominion; or to have dominion. [*Little used.*]

**SIGNIORY**, *n.* (see *nyury*.) A different, but less common spelling of *seignory*,—*which see*. It signifies lordship, dominion, and in Shakspeare, *seniority*.

**SIGN-POST**, *n.* [*sign* and *post*.] A post on which a sign hangs, or on which papers are placed to give public notice of any thing.

**SIK**, } † *a.* Such.

**SIKE**, } † *a.* Sure; surely. [See **SICKER**.]

**SIK'ER**, † *a. or adv.* Sure; surely. [See **SICKER**.]

**SIK'ERNESS**, † *n.* Sureness; safety.  
**SIKHS**, or **SEIKS**, *n.* A religious sect in Hindostan, (founded about A. D. 1500), which professes the purest Deism, and is chiefly distinguished from the Hindoos by worshipping one only invisible God. The name Sikhs, or lions, was given to the sect, on account of the heroic manner in which they resisted their Mohamedan oppressors, against whom they long fought with varying success. They ultimately subdued Lahore, and established for themselves a country which includes the Punjaub, a part of Mooltan, &c.

**SILE**, † *n.* A sieve; a strainer.

**SILE**, *v. t.* To strain, as fresh milk from the cow. [*Local.*]

**SILED**, *pp.* Strained.

**SILENACEÆ**, *n.* A natural order of plants belonging to the syncarpous group of the polypetalous sub-class of Exogens. It is a part of the larger order caryophyllæ of Jussieu, and was originally separated by De Candolle. It differs from the remaining portion of

the order Caryophyllæ, (now called Alsiniacæ), in the possession of a tubular calyx, and petals with claws. The plants of this order are natives principally of the temperate and frigid parts of the world, where they inhabit mountains, hedges, rocks, and waste places. The Dianthus and Lychnis are handsome flowers, but the greater part are mere weeds.

**SILENCE**, *n.* [Fr. from *L. silentium*, from *sileo*, to be still. The sense is to stop or hold; but this may proceed from setting, throwing down. See **SILL**.] 1. In a general sense, stillness, or entire absence of sound or noise; as, the *silence* of midnight.—2. In animals, the state of holding the peace; forbearance of speech in man, or of noise in other animals.

I was dumb with *silence*; I held my peace, even from good; Ps. xxxix.

3. Habitual taciturnity; opposed to *loquacity*.—4. Secrecy. These things were transacted in *silence*.—5. Stillness; calmness; quiet; cessation of rage, agitation, or tumult; as, the elements reduced to *silence*.—6. Absence of mention; oblivion.

Eternal *silence* be their doom. *Milton*.  
And what most merits fame, in *silence* hid.

7. *Silence!* is used elliptically for *let there be silence*, an injunction to keep silence.

**SILENCE**, *v. t.* To oblige to hold the peace; to restrain from noise or speaking.—2. To still; to quiet; to restrain; to appease.

This would *silence* all further opposition.

These would have *silenced* their scruples. *Clarendon*.  
*Rogers*.

3. To stop; as, to *silence* complaints or clamour.—4. To still; to cause to cease firing; as, to *silence* guns or a battery.—5. In the *United States*, to restrain from preaching by revoking a license to preach; as, to *silence* a minister of the gospel.—6. To put an end to; to cause to cease.

The question between agriculture and commerce has received a decision which has *silenced* the rivalships between them. *Hamilton*.

**SILENCED**, *pp.* Stilled; hushed.

**SILENCING**, *ppr.* Stilling.

**SILENE**, *n.* An extensive genus of plants belonging to the nat. order Siliacæ. The species are in general herbaceous; the stems are leafy, jointed, branched, and frequently glutinous below each joint. The greatest proportion are inhabitants of the South of Europe, and north of Africa. Ten species are enumerated by British botanists, which are known by the names of campion and catch-fly. Several are cultivated in gardens as ornamental flowers. *S. compacta* or close-flowered catch-fly, is one of the most beautiful of the genus. *S. inflata*, or bladder-catch-fly, possesses edible properties. The young shoots, boiled, are a good substitute for green peas or asparagus. **SILENT**, *a.* Not speaking; mute; Ps. xxii.—2. Habitually taciturn; speaking little; not inclined to much talking; not loquacious.

Ulysses, he adds, was the most eloquent and the most *silent* of men. *Broom*.

3. Still; having no noise; as, the *silent* watches of the night; the *silent* groves; all was *silent*.—4. Not operative; want-

ing efficacy.—5. Not mentioning; not proclaiming.

This new created world, of which in hell Fame is not *silent*. *Milton*.

6. Calm; as, the winds were *silent*.—7. Not acting; not transacting business in person; as, a *silent* partner in a commercial house.—8. Not pronounced; having no sound; as, *e* is *silent* in *fable*.

**SILENTIARY**, *n.* One appointed to keep silence and order in court; one sworn not to divulge secrets of state. **SILENTLY**, *adv.* Without speech or words.

Each *silently*

Demands thy grace, and seems to watch thy eye. *Dryden*.

2. Without noise; as, to march *silently*.—3. Without mention. He mentioned other difficulties, but this he *silently* passed over.

**SILENTNESS**, *n.* State of being silent; stillness; silence.

**SILENT SYSTEM**. Abstinence from all communication by words, and even looks, enforced in some penitentiaries.

We prefer the *silent system* to the solitary system. *Prison Inspectors' Reports*.

**SILENUS**, *n.* (*σἰληνός*). A Grecian divinity, the foster-father and attendant of Bacchus, and likewise leader of the satyrs. He was represented as a robust old man in a state of intoxication, and riding on an ass with a can in his hand.

**SILESIA**, *n.* (*sil'zha*.) A duchy or country now chiefly belonging to Prussia; hence, a species of linen cloth so called; thin coarse linen.

**SILESIAN**, *a.* (*sil'zhan*.) Pertaining to Silesia; made in Silesia; as, *Silesian* linen.

**SIL'EX**, } *n.* [*L. silex*, flint.] Silicic  
**SIL'ICA**, } acid, generally impure, as it is found in nature. This important substance constitutes the characteristic ingredient of a great variety of minerals; among which rock-crystal, quartz, chalcedony, and flint may be considered as silica nearly pure. It also predominates in many of the rocky masses which constitute the crust of our globe, such as granite, the varieties of sandstone, and quartz rock. It is the chief substance of which glass is made; also an ingredient, in a pulverized state, in the manufacture of stoneware, and it is essential in the preparation of tenacious mortar. Sil'ex, when pure, is a fine powder, hard, insipid, and inodorous; rough to the touch, scratches and wears away glass. It combines in definite proportions with many salifiable bases, and its various compounds have been termed silicates. Plate glass and window glass, or, as it is commonly called, crown glass, are silicates of soda or potassa, and flint glass is a similar compound, with a large addition of silicate of lead. Recent experiments prove silica to be a compound substance, the base of which is a metal called silicium or silicon. Silica then is an oxide of silicium. [See **SILICIC ACID**.]

**SIL'HOUETTE**, *n.* (*sil'hoet*.) In the *fine arts*, a name given to the representation of an object filled in of a black colour, and in which the inner parts are sometimes indicated by lines of a lighter colour, and shadows or extreme depths by the aid of a heightening of gum or other shining medium. This sort of drawing derives its name from its inventor

Etienne de Silhouette, the French minister of finance, in 1759.

**SIL'ICATE**, *n.* A salt composed of silicic acid and a base. Silicates formed by the union of silicic acid, or silica, with the bases alumina, lime, magnesia, potassa, soda, &c., constitute the greater number by far of the hard minerals which encrust the globe. The silicates of potash and soda, when heated to redness, form glass.

**SIL'ICATED**, *a.* Coated or mixed with flint.

**SILICIC ACID**, *n.* A name given to silica, because although it has none of the ordinary, or more obvious properties of an acid, it combines with many salifiable bases, and expels carbonic acid when fused with the carbonated alkalis. According to Thomson, it is composed of one equivalent of silicium or silicon, and one of oxygen; or, according to Berzelius, one of silicium, or silicon, and three of oxygen. **SILICIFALCAREOUS**, *a.* [*silex* and *calcareous*.] Consisting of silex and calcareous matter.

**SILICIFAL'CE**, *n.* [*L. silex* or *silica* and *calx*.] A mineral of the silicious kind, occurring in amorphous masses; its colour is gray or brown. It is a mixture of flint and carbonate of lime.

**SILICIFEROUS**, *a.* [*L. silex* and *fero*, to produce.] Producing silex; or united with a portion of silex.

**SILICIFICA'TION**, *n.* Petrification; the conversion of any substance into stone by silicious matter.

**SILICIFIC'Æ**, *n.* Substances petrified or mineralized by silicious earth.

**SILIC'IFIED**, *pp.* Petrified by flint.

**SILIC'IFY**, *v. t.* [*L. silex*, flint, and *facio*, to make.] To convert into silex, or petrify by flint.

The specimens... found near Philadelphia, are completely *silicified*. *Say*.

**SILIC'IFY**, *v. i.* To become silic.

**SILIC'IFYING**, *ppr.* Petrifying by silex.

**SILICIMU'RITE**, *n.* [*silex* and *muria*, brine.] An earth composed of silex and magnesia.

**SIL'ICIOUS**, *a.* Pertaining to silex, or partaking of its nature and qualities, as *silicious* limestone; *silicious* slate; *silicious* nodules, &c. *Silicious waters*, such as contain silica in solution; as the boiling springs of the Geyser in Iceland.—*Silicious earth*, silica,—which see.

**SILIC'ITED**, *a.* Impregnated with silex.

**SILIC'IUM**, } *n.* [*L. silex*, flint.] The  
**SIL'ICON**, } base of silica, a dark, nut-brown elementary substance, destitute of a metallic lustre. It is probably not metallic, as has been supposed. It bears a greater analogy to boron than any known principle. It is a non-conductor of electricity, incombustible in air and oxygen, infusible by the blow pipe, and not acted upon by any single acid; but it is readily soluble in a mixture of the nitric and hydrofluoric acids. Its external characters are much altered after exposure to a high temperature.

**SIL'ICLE**, } *n.* [*L. silicula*.] In bot.,  
**SIL'ICULA**, } a kind of fruit. In its structure it resembles the siliqua, and differs in nothing but its figure, which is rounded and much shorter, and in the number of its seeds. It is never more than four times as long as broad, and often much shorter. Examples of it may be seen in the whitlow-grass,



in the shepherd's purse, and in the horse radish. [See SILIQUA.]

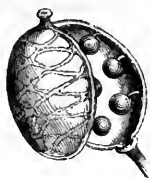

Siliqua.

**SILICO-FLUORIC ACID**, *n.* When silicic acid is dissolved by hydrofluoric acid a gas is produced which is colourless, fuming strongly in the air. It is absorbed by water, and hydrated silicic acid is deposited, while an acid is found in the water, which is termed *silico-fluoric acid*. With bases this acid forms salts called *silico-fluorides*, which are nearly all insoluble.

**SILICULO'SA**, *n.* One of the two orders into which Linnæus divided his class Tetradynamia. It comprehends those plants which have a silicle. [See SİLICLE.]

**SILIC'ULOUS**, } *a.* Having silicles, or  
**SILIC'ULOSE**, } pertaining to them.

**SILIG'INOUS**, } *a.* [L. *siligo*.] Made  
**SILIG'INOSE**, } of fine wheat.

**SILING**, *pp.* Straining.

**SILING-DISH**, } *n.* [Dan. *siler*, to  
 strain.] A colander.

**SIL'QUA**, *n.* [L.] With gold finers, a carat, six of which made a scruple.

**SIL'QUA**, } *n.* [L. *siliqua*.] In bot., a  
**SIL'QUE**, } species of fruit. It is

characterized by having one or two cells, with many seeds, dehiscent by two valves, which separate from a central portion called the *replum*. It is linear in form, and is always superior to the calyx and corolla. The seeds are attached to two placenta, which adhere to the replum, and are opposite to the lobes of the stigma. This kind of seed-vessel is possessed by a large number of plants belonging to the order Cruciferae, and examples may be seen in the stock or wall-flower, in the ladies' smock, and in the cabbage, turnip, and mustard.



Siliqua.

**SIL'QUA'RIA**, *n.* A genus of marine univalves found both fossil and recent.

The shell is tabular, spiral at its beginning, continued in an irregular form, divided laterally through its whole length by a narrow slit, and formed into chambers by entire septa. Recent siliquariae have been found in sponges. Cuvier places the genus in the order Tnbulibranchiata.



Siliquaria anguina.

**SIL'QUIFORM**, *a.* Having the form of a siliqua.

**SIL'QUO'SA**, *n.* One of the two orders into which Linnæus divided his class

Tetradynamia, the other being Silienosa. It comprehends those plants which have a silique, as the cabbage, turnip, and mustard.

**SIL'QUOSE**, } *a.* [L. *siliquosus*.] Hav-  
**SIL'QUOUS**, } ing that species of peci-  
 ricarp called *silique*; as, *siliquose* plants.

**SILK**, *n.* [Sax. *seolc*; Sw. *silke*; Russ. *schilk*; properly any thread, from Ar. *salaka*, to send or thrust in, to insert, to pass or go.] 1. The fine, soft thread produced by the larva of the insect called *silk-worm* or *Bombyx Mori*. That which we ordinarily call *silk*, is a thread composed of several finer threads, which the worm draws from its bowels, like the web of a spider, and with which the silk-worm envelops itself, forming what is called a *cocoon*. *Raw silk* is produced by the operation of winding off, at the same time, several of the balls or cocoons (which are immersed in hot water to soften the natural gum on the filament) on a common reel, thereby forming one smooth even thread. Before it is fit for weaving it is converted into one of three forms.—viz., *singles*, *tram*, or *organzine*. *Singles* (a collective noun) is formed of one of the reeled threads, being twisted in order to give it strength and firmness. *Tram* is formed of two or more threads twisted together. In this state it is commonly used in weaving, as the *shoot* or *weft*. *Thrown silk* is formed of one, two, three, or more singles, according to the substance required, twisted together in a contrary direction to that in which the singles of which it is composed are twisted. This process is termed *organzining*, and the silk so twisted *organzine*.—2. Cloth made of silk. In this sense, the word has a plural, *silks*, denoting different sorts and varieties, as black *silk*, white *silk*, coloured *silks*.—*Virginia silk*, a plant of the genus *Periploca*, which climbs and winds about other plants, trees, &c.

**SILK**, *a.* Pertaining to silk; consisting of silk.

**SILK COTTON-TREE**, *n.* A tree of the genus *Bombax*, the *B. ceita*, Linn., growing to an immense size; a native of both the Indies. It is so called because the seed capsule contains a downy substance like silk, which is employed for stuffing mattresses and cushions in India. This tree is cultivated in the Mauritius, where there are two varieties. In the West Indies the wood is used in the construction of canoes, and is formed into laths for roofs, and other domestic purposes.

**SILKEN**, *a.* (silk'n.) [Sax. *seolcen*.] 1. Made of silk; as, *silken* cloth; a *silken* veil.—2. Like silk; soft to the touch.—3. Soft; delicate; tender; smooth; as, mild and *silken* language.—4. Dressed in silk; as, a *silken* wanton.

**SILKEN**, *v. t.* (silk'n.) To render soft or smooth.

**SILK'ENED**, *pp.* Rendered soft or smooth.

**SILK'-GRASS**, *n.* A filamentous plant, of the genus *Yucca*.

**SILK'INESS**, *n.* [from *silky*.] The qualities of silk; softness and smoothness to the feel.—2. Softness; effeminacy; pusillanimity. [*Little used*.]

**SILK'MAN**, *n.* [*silk* and *man*.] A dealer in silks.

**SILK'-MERCER**, *n.* [*silk* and *mercere*.] A dealer in silks.

**SILK'-MILL**, *n.* A factory for reeling, spinning, and manufacturing silk.

**SILK'-THROWER**, } *n.* One who  
**SILK'-THROWSTER**, } winds, twists,  
 spins, or throws silk, to prepare it for weaving.

**SILK'-WEAVER**, *n.* [*silk* and *weaver*.] One whose occupation is to weave silk stuffs.

**SILK'-WEED**, *n.* A plant of the genus *Asclepias* (also called *wild cotton*), whose seed-vessels contain a long silky down.

**SILK'-WORM**, *n.* [*silk* and *worm*.] The worm which produces silk, the larva of a lepidopterous insect called the *Bombyx Mori*. [See **BOMBYX**.] Silk-worms are said to have been first introduced into the Roman empire from China, in the reign of Justinian.

**SILK'-WORM-GUT**, *n.* A substance prepared from the entrails of silk-worms, used in making lices for angling.

**SILK'Y**, *a.* Made of silk; consisting of silk.—2. Like silk; soft and smooth to the touch.—3. Pliant; yielding.—In bot., the surface of a plant is said to be silky when it is covered with long, very slender, close-pressed, glistening hairs.

**SILL**, or **CILL**, *n.* [Sax. *syl*, *syle*, *syll*; Fr. *seuil*; G. *schwelle*; W. *sail*, *syl*, or *seiler*; foundation; *seiliaw*, to found; L. *solum*; allied to *solid*.] The primary sense is probably to lay, set, or throw down.] 1. Properly, the basis or foundation of a thing; appropriately, a piece of timber on which a building rests; the lowest timber of any structure; as, the *sills* of a house, of a bridge, of a loom, and the like.—2. In arch., the horizontal piece of timber or stone at the bottom of a framed case; such as that of a door or window.—*Ground sills*, are the timbers on the ground which support the posts and superstructure of a timber building. The word *sill* is also used to denote the bottom pieces which support quarter and truss partitions.—*Sills of the ports*, or *portsills*, in *ship-building*, pieces of oak-timber let in horizontally between the frames, to form the upper and lower sides of the ports.—3. The shaft or thill of a carriage. [*Local*.]

**SIL'LABUB**, *n.* A liquor made by mixing wine or cider with milk, and thus forming a soft curd.

**SIL'LLY**, *adv.* [from *silly*.] In a silly manner; foolishly; without the exercise of good sense or judgment.

**SIL'LMANITE**, *n.* A mineral found in Saybrook in Connecticut, so named in honour of Professor Silliman of Yale College. It occurs in long, slender, rhombic prisms, engaged in gneiss. Its colour is dark grey and hair brown; lustre shining upon the external planes, but brilliant and pseudo-metallic upon those produced by cleavage in a direction parallel with the longer diagonal of the prism. Hardness about the same with quartz. Specific gravity, 3.410.

**SIL'LINESS**, *n.* Weakness of understanding; want of sound sense or judgment; simplicity; harmless folly.

**SIL'LOCK**, *n.* The name given in the Orkney islands to the fry of the coal-fish, a congener of the cod; also spelled *silloc*, *silik*, and *selloh*.

**SIL'LON**, *n.* [Fr.] In fort., a work raised in the middle of a ditch, to defend it when it is too wide.

**SIL'LY**, *a.* [The Sax. *asealcan* signifies to be dull, inert, lazy. This corresponds with the Ar. *hasela*, to be stupid, Heb. *בבב*, *casal*. This may be radically the same word with a prefix.] 1. Ori-

ginally, harmless, simple, guileless; innocent.—2. Weak in intellect; foolish; witless; destitute of ordinary strength of mind; simple; as, a *silly* man; a *silly* child.—3. Proceeding from want of understanding or common judgment; characterized by weakness or folly; unwise; as, *silly* thoughts; *silly* actions; a *silly* scheme; writings stupid or *silly*.—4. Weak; helpless.

After long storms...

With which my *silly* bark was toss'd.†

*Spenser.*

**SIL'LYHOW,**† *n.* [Sax. *sælig*, happy, prosperous, and *houwe*, a hood.] The membrane that covers the head of the fetus.—In *Scotland*, a film or membrane stretched over the heads of children new-born is called a *sillyhow*, that is, a holy or fortunate cap or hood.

**SIL'PHA,** *n.* A genus of coleopterous insects known in English as the carrion-beetle.

**SIL'PHIDÆ,** *n.* The name given by Leach to a family of coleopterous insects, belonging to the section Pentamera, and subsection Necrophaga, having five distinct joints in all the tarsi, and the mandibles terminated in an entire point, and not notched. It comprehends the genera Necrophorus, Necrodes, Oiceoptoma, Silpha, Phosphuga, &c. These insects subsist upon carcases, bones, and other putrifying substances. The most interesting genus is Necrophorus, which contains sexton-beetles or burying-beetles. The carrion-beetle belongs to the genus Silpha. [See NECROPHORUS.]

**SILT,** *n.* [Sw. *sylta*, to pickle.] 1. Saltiness, or salt marsh or mud.—2. A deposit of mud or fine earth, from running or standing water.

**SILT,** *v. t.* To choke, fill, or obstruct with silt or mud. Sometimes *silt up* is the term used.

**SILT'ING,** *ppr.* Choking, filling, or obstructing with silt or mud.

**SILURE,** } *n.* The sheat-fish; also, a  
**SILUR'US,** } name of the sturgeon.  
**SILURIAN ROCKS** or **STRATA.**

The name given by Murchison to a series of rocks forming the upper subdivision of the sedimentary strata found below the old red sandstone, and formerly designated the *greywacke series*. These strata are well developed in that part of England and Wales formerly included in the ancient British kingdom of the Silures.

**SILURIDÆ,** *n.* A family of fishes of the order Malacopterygii, placed by Cuvier between the Esocidæ or pike-tribe, and the Salmonidæ or family of

bony plates; the foremost ray of the dorsal and pectoral fins almost always consists of a strong bony ray, often serrated either in front or behind, or on both sides. The mouth is almost always provided with barbules. The only known European species of Silurus is the *Silurus glanis*, Linn., a fish of a very large size, which is found in the lakes of Switzerland, in the Danube, the Elbe, and all the rivers of Hungary. It takes its prey by lying in wait for it. The flesh, which is fat, is used in some places for the same purposes as lard.

**SILURIDANS,** *n. plur.* The Siluridæ; the family of fishes of which the *Silurus* is the type.

**SIL'VA,** *n.* [L.] A collection of poems, written also *Sylva*.—2. The natural history of the forest trees of a country.

**SIL'VAN,** *a.* [L. *silva*, a wood or grove. It is also written *sylvan*.] 1. Pertaining to a wood or grove; inhabiting woods.—2. Woody; abounding with woods. Betwixt two rows of rocks, a *silvan* scene. *Dryden.*

[See SYLVAN.]

**SIL'VAN,** *n.* Another name of *tellurium*.

**SILVA'NUS,** *n.* An Italian rural deity, so called from Lat. *sylva*, a wood. He is usually represented with a sickle in his right hand, and a bough in his left. He is described as the protector of herds and trees from wolves and lightning, the god of agriculture, or the defender of boundaries.

**SIL'VER,** *n.* [Sax. *seolfer*, *siluer*; G. *silber*; Sw. *silfver*. Qu. Russ. *serebro*; r for l.] 1. A metal of a white colour and lively brilliancy. It has neither taste nor smell; its specific gravity is 10.552, according to Bergman, but according to Kirwan it is less. A cubic foot weighs about 660 lbs. Its ductility is little inferior to that of gold. It is harder and more elastic than tin or gold, but less so than copper, platinum, or iron. It is superior to gold in lustre, but inferior to it in malleability; it is, however, so malleable that it may be beaten into leaves not exceeding the 100,000th part of an inch in thickness. It is not altered by air or moisture, but is blackened or tarnished by sulphuretted hydrogen. The only pure acids which act upon silver are the nitric and sulphuric. It is found native in thin plates or leaves, or in fine threads, or it is found mineralized by various substances; it is also found in the state of sulphuret, constituting the varieties of black and vitreous silver ore. It likewise occurs in combination with several other metals, and more especially with the sulphurets of lead. Great quantities of this metal are furnished by the mines of South America, and it is found in small quantities in Norway, Germany, Spain, the United States, &c. The numerous uses and applications of silver are well known. In its pure state it is too soft for coin, plate, and most ornamental purposes, and is therefore in such cases alloyed with copper, by which, in proper proportion, its colour is not materially impaired, and it is considerably hardened. The standard silver of our coin is an alloy of 11 oz. 2 dwts. of pure silver, and 19 dwts. of copper to the pound Troy, and this weight is coined into 66 shillings.—*German silver*, an alloy of copper, zinc, and nickel, which is now extensively used as a substitute for silver for ornamental purposes.—2.

Money; coin made of silver.—3. Any thing of soft splendour.

Pallas...piteous of her plaintive cries,  
In slumber clos'd her *silver*-streaming eyes. *Pope.*

**SIL'VER,** *a.* Made of silver; as, a *silver* cup.—2. White like silver; as, *silver* hair.

Others on *silver* lakes and rivers bath'd  
Their downy breast. *Milton.*

3. White or pale; of a pale lustre; as, the *silver* moon.—4. Soft; as, a *silver* voice or sound. [Italian, *suono argentino*.]

**SIL'VER,** *v. t.* To cover superficially with a coat of silver; as, to *silver* a pin or a dial-plate.—2. To foliate; to cover with tinfoil amalgamated with quick-silver; as, to *silver* glass.—3. To adorn with mild lustre; to make smooth and bright.

And smiling calmness *silver'd* o'er the deep. *Pope.*

4. To make hoary.

His head was *silver'd* o'er with age. *Gay.*  
**SIL'VER-BEATER,** *n.* [*silver* and *beater*.] One that foliates silver or forms it into a leaf.

**SIL'VER-BUSH,** *n.* A plant, a species of Anthyllis, the *A. barba jovis*, Linn.

**SIL'VER-BUSKINED,** *a.* Wearing buskins made of, or adorned with, silver.

**SIL'VERED,** *pp.* Covered with a thin coat of silver; rendered smooth and lustrous; made white or hoary.

**SIL'VER-FIR,** *n.* A species of fir, the *Abies picea*, Linn. It is a native of the mountains of the middle and south of Europe. Planks of indifferent quality, on account of their softness, are sawn from its trunk, which also yields Burgundy pitch, and Strasburg turpentine.

**SIL'VER-FISH,** *n.* A fish of the size of a small carp, having a white colour, striped with silvery lines. It is a variety of the *Cyprinus auratus*, Linn., or gold-fish.

**SIL'VER-GLANCE,** *n.* A mineral, a sulphuret of silver.

**SIL'VER-GRAIN,** *n.* The name given by persons who work on wood to the medullary rays.

**SIL'VER-HAIRED,** *a.* Having hair of the colour of silver.

**SIL'VERING,** *ppr.* Covering the surface with a thin coat of silver; foliating; rendering mildly lustrous; rendering white.

**SIL'VERING,** *n.* The art, operation, or practice of covering the surface of any thing with silver; as, the *silvering* of copper or brass.—2. The silvering thus laid on.

**SIL'VER-LEAF,** *n.* Silver foliated or beaten out into a thin leaf.

**SIL'VERLING,** *n.* A silver coin; Is. vii.

**SIL'VERLY,** *adv.* With the appearance of silver.

**SIL'VERSMITH,** *n.* [*silver* and *smith*.] One whose occupation is to work in silver, or in manufactures of which the precious metals form a part.

**SIL'VER-THISTLE,** } *n.* [*silver* and  
**SIL'VERY-THISTLE,** } *thistle*.] A plant, *Carduus argentatus*.

**SIL'VER-TREE,** *n.* A plant of the genus Protea, the *P. argentea*, Linn., so called from the appearance of the leaves, which are lanceolate and silky. It is a large evergreen shrub with handsome foliage, a native of the Cape of Good Hope.

**SIL'VER-WEED,** *n.* A plant of the genus Potentilla, the *P. anserina*, Linn., called also goose-grass, and wild tansy. [See POTENTILLA.]

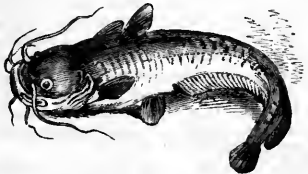

Sly Silurus (*Silurus glanis*).

the salmons. The family Siluridæ constitutes a very extensive section of fishes, the species of which are, for the most part, confined to the fresh waters of warm climates. They present great diversity of form, but their most obvious external characters are the want of true scales: the skin is generally naked, but in parts protected by large

shillings.—*German silver*, an alloy of copper, zinc, and nickel, which is now extensively used as a substitute for silver for ornamental purposes.—2.

**SIL'VERY**, *a.* [from *silver*.] Like silver; having the appearance of silver; white; of a mild lustre.

Of all the enamel'd race whose *silvery* wing Waves to the tepid zephyrs of the spring.

*Pope.*

2. Besprinkled or covered with silver.

**SIM'AR**. In *arch.*, another name for *Cyma*. [See *CYMATIUM*.]

**SIM'AGRÉE**, *f. n.* [Fr. *simagrée*.] Grimace.

**SIM'AR**, } *f. n.* [Fr. *simarre*.] A wo-  
**SIM'ARE**, } man's robe.

**SIMAR'UBA**, *n.* A genus of plants belonging to the nat. order Simarubaceæ. The bark of the root of *S. officinalis*, a tall tree, a native of Guyana, and of Jamaica, is also called simaruba. It is a tough, fibrous, bitter bark; the infusion is occasionally used in medicine as a tonic.

**SIMARUBA'CEÆ**, *n.* A nat. order of arborescent or shrubby exogens, inhabiting the tropics. The plants of this order are all intensely bitter. The wood of *Quassia* is well known. The *Simaruba versicolor* is so bitter that no insects will attack it.

**SIM'IA**, *n.* [L. *simus*, flat-nosed.] The generic name applied by Linnæus to all the quadrumanous mammals (monkeys), except the lemurs. The Linnæan Simiæ are divided into numerous subgenera, to none of which the name *Simia* is now applied, except by some modern naturalists to the orang-outan, (*Simia satyrus*) and *S. moris*.

**SIM'IADEÆ**, *n.* A quadrumanous family of mammals, including apes, ateles, baboons, cheiro-poda, chimpanzee, hylobates, lagothrix mycetes, nasalis, orang-outan, sakis, sapajous, semnopithecus, &c.

**SIM'ILAR**, *a.* [Fr. *similaire*; L. *similis*; *W. heval*, *hevalyz*; from *mal*, like, Gr. *ἴσως*.] The Welsh *mal* signifies small, light, ground, bruised, smooth, allied to *mill*, *W. mabu*, to grind. But we are not confident that these words are of one family.] Like; resembling; having a like form or appearance. *Similar* may signify exactly alike, or having a general likeness, a likeness in the principal points. Things perfectly *similar* in their nature, must be of the same essence, or homogeneous; but we generally understand *similar* to denote a likeness that is not perfect. In *geom.*, *similar rectilinear figures* are such as have their several angles equal each to each, and the sides about the equal angles proportional. Such figures are to one another as the squares of their homologous sides.—*Similar segments* of circles, are those which contain equal angles.—*Similar curves*, are curves whose equations are of the same form, and the ratio of the constants in those equations equal.—*Similar arches of circles*, are those which contain the same number of degrees and parts of a degree, or which are the same parts of their respective circles.—*Similar solids*, are such as are contained by the same number of similar planes, similarly situated, and having like inclinations to one another. Such solids are to one another as the cubes of their homologous sides.

**SIMILAR'ITY**, *n.* Likeness; resemblance; as, a *similarity* of features. There is a great *similarity* in the features of the Laplanders and Sanoïedes, but little *similarity* between the features of Europeans and the woolly-haired Africans.

11.

**SIMILARLY**, *adv.* In like manner; with resemblance.

**SIMILE**, *n.* (sim'ily.) [L.] In *rhet.*, similitude; a comparison of two things which, however different in other respects, have some strong point or points of resemblance; by which comparison, the character or qualities of a thing are illustrated or presented in an impressive light. Thus, the eloquence of Demosthenes was like a rapid torrent; that of Cicero, like a large stream that glides smoothly along with majestic tranquillity.

**SIMIL'ITER**, *adv.* [L. in like manner.] In *law*, the technical designation of the form by which either party, in pleading, accepts the issue tendered by his opponent.

**SIMIL'ITUDE**, *n.* [Fr. from L. *similitudo*.] 1. Likeness; resemblance; likeness in nature, qualities, or appearance; as, *similitude* of substance.

Let us make man in our image, man  
In our *similitude*. *Milton.*  
Fate some future bard shall join  
In sad *similitude* of griefs to mine.

*Pope.*

2. Comparison; simile. [See *SIMILE*.]  
Tasso, in his *similitudes*, never departed  
from the woods. *Dryden.*

3. In *geom.*, the relation of figures that are similar to each other.

**SIMILITU'DINARY**, *a.* Denoting resemblance or comparison.

**SIM'TLOR**, *n.* A name given to an alloy of red copper and zinc, made in the best proportions to imitate silver and gold.

**SIM'IOUS**, *a.* [L. *simia*.] Pertaining to or like the monkey.

**SIMITAR**. See *SCIMITAR*.

**SIM'NER**, *v. i.* [Qu. Gr. *ζυμω*, ζυμωσ, to ferment.] To boil gently, or with a gentle hissing. *Simmering* is incipient ebullition, when little bubbles are formed on the edge of the liquor next to the vessel. These are occasioned by the escape of heat and vapour.

**SIM'MERING**, *ppr.* Boiling gently.

**SIM'NEL**, *n.* [Dan. *simle*; Sw. *simla*; G. *semmel*.] A kind of sweet cake; a bun.

**SIMO'NIAC**, *n.* [Fr. *simoniaque*. See *SIMONY*.] One who buys or sells preferment in the church.

**SIMONI'ACAL**, *a.* Guilty of simony.—2. Consisting in simony, or the crime of buying or selling ecclesiastical preferment; as, a *simoniacal* presentation.

**SIMONI'ACALLY**, *adv.* With the guilt or offence of simony.

**SIMO'NIANS**, *n. plur.* In *eccles. hist.*, the followers of Simon Magus.

**SIMO'NIANS**, *ST.* See *SAIN'T SIMONIANS*.

**SIMO'NIOUS**, *a.* Partaking of simony; given to simony.

**SIM'ONY**, *n.* [from *Simon* Magus, who wished to purchase the power of conferring the Holy Spirit; Acts viii.] The crime of buying or selling ecclesiastical preferment; or the corrupt presentation of any one to an ecclesiastical benefice for money or reward. By stat. 31 Elizabeth, c. vi., severe penalties are enacted against this crime. In the church of Scotland, simoniacal practices afford a ground for deposing a clergyman who has been guilty of them, or for depriving a probationer of his licensure.

**SIMOOM**, *n.* A hot, suffocating wind, that blows occasionally in Africa and Arabia, generated by the extreme heat of the parched deserts or sandy plains.

761

Its approach is indicated by a redness in the air, and its fatal effects are only to be avoided by falling on the face and holding the breath.

**SIM'MOUS**, *a.* [L. *simo*, one with a flat nose, Gr. *σμοος*.] 1. Having a very flat or snub nose, with the end turned up.—2. Concave; as the *simous* part of the liver.

**SIM'PTEP**, *v. i.* To smile in a silly manner.

**SIM'PTEP**, *n.* A smile with an air of silliness.

**SIM'PERING**, *ppr.* Smiling foolishly.

**SIM'PERING**, *n.* The act of smiling with an air of silliness.

**SIM'PERINGLY**, *adv.* With a silly smile.

**SIM'PLE**, *a.* [Fr. from L. *simplex*; *sine*, without, and *plex*, *plica*, doubling, fold.] 1. Single; consisting of one thing; uncompounded; unmingled; uncombined with any thing else; as, a *simple* substance; a *simple* idea; a *simple* sound.—2. Plain; artless; not given to design, stratagem, or duplicity; undesigning; sincere; harmless.

A *simple* husbandman in garments grey.  
*Hubbard.*

3. Artless; unaffected; unconstrained; inartificial; plain.

In *simple* manners all the secret lies.

*Young.*

4. Unadorned; plain; as, a *simple* style or narration; a *simple* dress.—5. Not complex or complicated; as, a machine of *simple* construction.—6. Weak in intellect; not wise or sagacious; silly.

The *simple* believeth every word; but the prudent looketh well to his going; Prov. xiv.

7. In *bot.*, undivided, as a root, stem, or spike; only one on a petiole, as, a *simple* leaf; only one on a peduncle, as a *simple* flower; having only one set of rays, as an umbel; having only one series of leaflets, as, a *simple* calyx; not plumose or feathered, as a pappus.—A *simple body*, in *chem.*, is one that has not been decomposed, or separated into two or more bodies. [See *ELEMENTARY SUBSTANCES*.]—*Simple equation*, in *alge*, an equation in which only the first power of the unknown quantity or quantities enter; as  $7ax = b$ ;  $3x + ax = b$ . [See *EQUATION*.]—*Simple quantity*, that which consists but of one term; as *ab*,  $3ax$ , &c.—*Simple contract*. In *Eng. law*, a debt by simple contract, is where the contract is ascertained, neither by matter of record, nor by deed or special instrument, but by mere oral evidence, or notes unsealed.

**SIM'PLE**, *n.* Something not mixed or compounded. In the *materia medica*, the general denomination of an herb or plant, as each vegetable is supposed to possess its particular virtue, and therefore to constitute a simple remedy. *Simple*, when applied to minerals and rocks, has reference to their homogeneity, and not to the number of elements which enter into their composition.

**SIM'PLE**, *v. i.* To gather simples or plants.

As *simpling* on the flowery hills he stray'd.  
*Garth.*

**SIM'PLE-HEARTED**, *a.* Having a simple heart.

**SIM'PLE-MINDED**, *a.* Artless; undesigning; unsuspecting.

**SIM'PLE-MINDEDNESS**, *n.* Artlessness.

**SIM'PLE MINERAL**, *n.* A mineral composed of a single substance. Rocks

5D

are generally aggregates of several simple minerals cemented together.

**SIMPLENESS, n.** The state or quality of being simple, single, or uncompounded; as, the *simplicity* of the elements.—2. Artlessness; simplicity.—3. Weakness of intellect.

**SIMPLER, n.** One that collects simples; an herbalist; a simplist.

**SIMPLESS, for** *Simplicity* or *Silliness*, is not in use.

**SIMPLETON, n.** A silly person; a person of weak intellect; a trifler; a foolish person.

**SIMPLI'CIAN, † n.** An artless, unskilled, or undesigning person.

**SIMPLICITY, n.** [L. *simplicitas*; Fr. *simplicité*.] 1. Singleness; the state of being unmixed or uncompounded; as, the *simplicity* of metals or of earths.—2. The state of being not complex, or of consisting of few parts; as, the *simplicity* of a machine.—3. Artlessness of mind; freedom from a propensity to cunning or stratagem; freedom from duplicity; sincerity.

Marquis Dorset, a man for his harmless *simplicity* neither misliked nor much regarded. *Huyward.*

4. Plainness; freedom from artificial ornament; as, the *simplicity* of a dress, of style, of language, &c. *Simplicity* in writing is the first of excellences.—

5. Plainness; freedom from subtlety or abstruseness; as, the *simplicity* of Scriptural doctrines or truth.—6. Weakness of intellect; silliness.—*Simplicity*, in the fine arts, is that quality in works of art, through which the elements whereof it is composed are arranged in the most natural order; and in which the ideas and images are presented to us, so that the principal objects are not eclipsed by the accessories, and the details are in due subordination to the whole.—*Godly simplicity*, in *Script.*, is a fair, open profession and practice of evangelical truth, with a single view to obedience and to the glory of God.

**SIMPLIFICATION, n.** [See **SIMPLIFY**.] The act of making simple; the act of reducing to simplicity, or to a state not complex.

**SIMPLIFIED, pp.** Made simple or not complex.

**SIMPLIFY, v. t.** [L. *simplex*, simple, and *facio*, to make; Fr. *simplifier*.] To make simple; to reduce what is complex to greater simplicity; to make plain or easy.

The collection of duties is drawn to a point, and so far *simplified*. *Hamilton.*

It is important in scientific pursuits, to be cautious in *simplifying* our deductions. *Nicholson.*

This is the true way to *simplify* the study of science. *Lavoisier, Trans.*

**SIMPLIFYING, ppr.** Making simple; rendering less complex.

**SIMPLIST, n.** One skilled in simples or medicinal plants.

**SIMPLOCE.** See **SYMPLOCE**.

**SIMPLY, adv.** Without art; without subtlety; artlessly; plainly.

Subverting worldly strong and worldly weak By *simply* meek. *Milton.*

2. Of itself; without addition; alone.

They make that good or evil, which otherwise of itself were not *simply* the one nor the other. *Hooker.*

3. Merely; solely.  
— *Simply* the thing I am *Shak.*

4. Weakly; foolishly.

**SIMULACHRE, † n.** [L. *simulacrum*.] An image.

**SIMULAR, † n.** [See **SIMULATE**.] One who simulates or counterfeits something.

**SIMULATE, v. t.** [L. *simulo*, from *similis*, like.] To feign; to counterfeit; to assume the mere appearance of something, without the reality. The wicked often *simulate* the virtuous and good.

**SIMULATE, a.** [L. *simulatus*.] Feigned; pretended.

**SIMULATED, pp. or a.** Feigned; pretended; assumed; artificially.

**SIMULATING, ppr.** Feigning; pretending; assuming the appearance of what is not real.

**SIMULATION, n.** [Fr. from L. *simulatio*.] The act of feigning to be that which one is not; the assumption of a deceitful appearance or character. *Simulation* differs from *dissimulation*. The former denotes the assuming of a false character; the latter denotes the concealment of the true character. Both are comprehended in the word *hypocrisy*.

**SIMULTANEOUS, a.** [Fr. *simultanée*; from L. *simul*, at the same time.] Existing or happening at the same time; as, *simultaneous* events. The exchange of ratifications may be *simultaneous*.

**SIMULTANEOUSLY, adv.** At the same time.

**SIMULTANEOUSNESS, n.** The state or quality of being or happening at the same time; as, the *simultaneousness* of transactions in two different places.

**SIMULTY, † n.** [L. *simultas*.] Private grudge or quarrel.

**SIN, n.** [Sax. *sin* and *syn*; G. *sünde*; Lapponic, Finnish, *sindia*; allied perhaps to Ir. *sainim*, to alter, to vary, to *sunder*. The primary sense is probably to depart, to wander.] 1. The voluntary departure of a moral agent from a known rule of rectitude or duty, prescribed by God; any voluntary transgression of the divine law, or violation of a divine command; a wicked act; iniquity. Sin is either a positive act in which a known divine law is violated, or it is the voluntary neglect to obey a positive divine command, or a rule of duty clearly implied in such command. Sin comprehends not actions only, but neglect of known duty, all evil thoughts, purposes, words, and desires, whatever is contrary to God's commands or law; 1 John iii.; Matt. xv.; James iv.

Sinners neither enjoy the pleasures of *sin*, nor the peace of piety. *Rob. Hall.* Among divines, sin is *original* or *actual*. *Actual sin*, above defined, is the act of a moral agent in violating a known rule of duty. *Original sin*, as generally understood, is native depravity of heart; that want of conformity of heart to the divine will, that corruption of nature or deterioration of the moral character of man, which is supposed to be the effect of Adam's apostasy; and which manifests itself in moral agents by positive acts of disobedience to the divine will, or by the voluntary neglect to comply with the express commands of God, which require that we should love God with all our heart and soul and strength and mind, and our neighbour as ourselves. This native depravity or alienation of affections from God and his law, is supposed to be what the apostle calls

the *carnal mind* or *mindedness*, which is enmity against God, and is therefore denominated *sin* or *sinfulness*.—*Unpardonable sin*, or blasphemy against the Holy Spirit, is supposed to be a malicious and obstinate rejection of Christ and the gospel plan of salvation, or a contemptuous resistance made to the influences and convictions of the Holy Spirit; Matt. xii.—2. A sin-offering; an offering made to atone for sin.

He hath made him to be *sin* for us, who knew no sin; 2 Cor. v.

3. † A man enormously wicked. [*Sin* differs from *crime*, not in nature, but in application. That which is a *crime* against society, is *sin* against God.]

**SIN, v. t.** [Sax. *singian*, *syngian*.] 1. To depart voluntarily from the path of duty prescribed by God to man; to violate the divine law in any particular, by actual transgression, or by the neglect or non-observance, of its injunctions; to violate any known rule of duty.

All have *sinned* and come short of the glory of God; Rom. iii.

It is followed by *against*.

*Against* thee, thee only, have I *sinned*; Ps. li.

2. To offend against right, against men or society; to trespass.

I am a man  
More *sinn'd* against than *sinning*. *Shak.*  
And who but wishes to invert the laws  
Of order, *sins* against th' eternal Cause. *Pope.*

**SIN, for** *Since*, [Scot. *syne*,] obsolete or vulgar.

**SINAITIC, a.** [from Sinai, the mountain.] Pertaining to Mount Sinai; given or made at Sinai.

**SINAP'IS, n.** Mustard, a genus of plants belonging to the nat. order Crucifere. [See **MUSTARD**.]

**SINAP'ISINE, n.** A white crystallizable substance extracted from mustard seed (*sinapis alba*). It is inodorous, and has a bitter taste, accompanied by the flavour of mustard.

**SINAPISM, n.** [L. *sinapis*, *sinape*, mustard, G. *senf*, Sax. *senep*.] In *phar.*, a cataplasm or poultice, which is a mixture of mustard and vinegar, applied to various parts of the body, and intended to supersede the use of a blister.

**SINAP'OLINE, n.** A new base obtained by depriving oil of mustard of its sulphur by the action of baryta, or of oxide of lead. It is soluble in hot water and alcohol, and crystallizes in shining, fatty, fusible scales. It combines with acids, and is separated from them by ammonia. It is a compound of 14 equivalents of carbon, 12 of hydrogen, 2 of nitrogen, and 2 of oxygen.

**SIN'BORN, a.** Derived from sin.

**SINCE, prep. or adv.** [Sw. *sedan*; D. *sint*; supposed to be contracted from Sax. *siththan*, which is from *sithian*, to pass, to go; and *siththan* may be the participle, and denote past, gone, and hence after, afterward. *Sith* in Saxon, has a like sense. Our early writers used *sith*, *sithen*, *sithence*; the latter is evidently a corruption of *siththan*. It may be doubted whether Sw. *sen*, Dan. *seen*, slow, late, is a contraction of this word; more probably it is not.] 1. After; from the time that. The proper signification of *since* is *after*, and its appropriate sense includes the whole period between an event and the pre-

sent time. I have not seen my brother since January.

The Lord hath blessed thee, *since* my coming; Gen. xxx.

Holy prophets, who have been *since* the world began; Luke i.; John ix.

*Since* then denotes, during the whole time after an event; or at any particular time during that period.—2. Ago; past; before this. "About two years *since*, an event happened," that is, two years having *passed*.—3. Because that; this being the fact that.

*Since* truth and constancy are vain,

*Since* neither love nor sense of pain,

Nor force of reason can persuade,

Then let example be obey'd. *Glennville*.

*Since*, when it precedes a noun, is called a preposition, but when it precedes a sentence it is called an adverb. The truth is, the character of the word is the same in both cases. It is probably an obsolete participle, and according to the usual classification of words, may be properly ranked with the prepositions. In strictness, the last clause of the passage above cited is the case absolute. "The Lord hath blessed thee, *since* my coming," that is, my arrival being past. So, *since* the world began, is strictly, *past* the world began, the beginning of the world being *past*. In the first case, *since*, considered as a preposition, has *coming*, a noun, for its object, and in the latter case, the clause of a sentence. So we say, *against* your arrival, or *against* you come.—*Since* is considered by many grammarians as a conjunction when taken to signify because that, seeing, or seeing that.

**SINCERE**, *a.* [Fr. from *L. sincerus*, which is said to be composed of *sine*, without, and *cera*, wax; as if applied originally to pure honey.] 1. Pure; unmixed.

As new-born babes, desire the *sincere* milk of the word; 1 Pet. ii.

A joy which never was *sincere* till now.

*Dryden*.

There is no *sincere* acid in any animal juice.

*Arbutnot*.

I would have all gallicisms avoided, that our tongue may be *sincere*.

*Fellon*.

[This sense is for the most part obsolete. We use the phrases, *sincere* joy, *sincere* pleasure, but we mean by them, *unfeigned*, *real* joy or pleasure.]

2. Unhurt; uninjured.

Th' inviolable body stood *sincere*.

*Dryden*.

3. Being in reality what it appears to be; not feigned; not simulated; not assumed or said for the sake of appearance; real; undissembling; honest; uncorrupt; not hypocritical or pretended. [This is the present use of the word.] Let your intentions be pure and your declarations *sincere*. Let love and friendship be *sincere*. No prayer can avail with a heart-searching God, unless it is *sincere*.

**SINCERELY**, *adv.* Honestly; with real purity of heart; without simulation or disguise; unfeignedly; as, to speak one's mind *sincerely*; to love virtuously *sincerely*.

**SINCERENESS**, *n.* Sincerity.

**SINCERITY**, *n.* [Fr. *sincérité*; *L. sinceritas*.] 1. Honesty of mind or intention; freedom from simulation or hypocrisy. We may question a man's prudence, when we cannot question his *sincerity*.—2. Freedom from hypocrisy, disguise or false pretence; as, the *sincerity* of a declaration of love.

**SINCIPUT**, *n.* [L.] The fore part of the head from the forehead to the coronal suture, in contradistinction to the *occiput* or back part of the head.

**SINDON**, *n.* [L. *finelinen*.] A wrapper.

**SINE**, *n.* [L. *sinus*.] In *trigonometry*, the sine of any arc of a circle, or of the angle measured by it, is the straight line drawn from one extremity of the arc perpendicular to the diameter passing through the other extremity. Thus

in the circle

ACH, let AOH

be a diameter,

and let CE be

perpendicular

thereto; then

shall CE be the

sine of the arc

CH, or of the

angle COH, and

of its supplement

COA.

The sine of a quadrant, or of a right angle, is equal to the radius. The sine of any arc is half the chord of twice that arc.

—*Versed sine*, of an arc or angle, the segment of the diameter intercepted between the sine and the extremity of the arc; thus EH is the versed sine of the arc CH, or of the angle COH, and of its supplement COA.—*Arithmetic of sines*, a term employed to denote analytical trigonometry. Its object is to exhibit the relation of the sines, cosines, tangents, &c. of arcs, multiple arcs, &c.—*Line of sines*, a line on the sector or Gunter's scale, &c., divided according to the sines, or expressing the sines.—*Artificial sines*, logarithmic sines.—*Natural sines*, sines expressed by natural numbers.

**SINE**, (*si'ney*.) A Latin preposition signifying *without*.

**SINECURE**, *n.* [L. *sine*, without, and *cura*, cure, care.] An office which has revenue without employment; in church affairs, a benefice without cure of souls. [This is the original and proper sense of the word.] There are three sorts of ecclesiastical sinecures.

1. Where the benefice is a donative, and is committed to the incumbent by the patron expressly without cure of souls, the cure either not existing, or being entrusted to a vicar; this is the strictest sinecure.

2. Certain cathedral offices, viz., the canonries and prebends, and, according to some authorities, the deanery.

3. Where a parish is destitute, by some accident, of parishioners; this last kind has been called depopulations, rather than sinecures.

**SINECURISM**, *n.* The state of having a sinecure.

**SINECURIST**, *n.* One who has a sinecure.

**SINE DIE**, [L. without day.] In *legal* and *parliamentary usage*, an adjournment or prorogation.—*Sine die* signifies an adjournment without any specified day or time for resuming the subject or business, or reassembling. When a defendant is suffered to go *sine die*, he is dismissed the court.

**SINE PARI**, [L.] In *anat.*, a term applied to several muscles, veins, arteries, &c., which are without a fellow.

**SINEPITE**, *n.* [L. *sinape*, mustard.] Something resembling mustard-seed.

**SINE QUA NON**, [L.] Without which a thing cannot be; hence, an indispensable condition.

**SINE QUO NON**, [L. without whom nobody.] In *Scots law*, a term applied

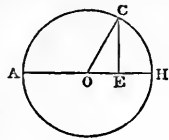

Sine.

to a trustee without whom the others cannot act.

**SINEW**, *n.* [Sax. *sinu*, *sinuw*, *sinwe*; G. *sehne*.] The primary sense is stretched, strained, whence the sense of strong; G. *sehnen*, to long; Ir. *sinnim*, to strain.] 1. In *anat.*, a tendon; that which unites a muscle to a bone.—2. In the plural, strength; or rather that which supplies strength. Money is the *sinew* of war.—3. Muscle; nerve.

**SINEWY**, *v. t.* To knit as by sinews.

**SINEWED**, *a.* Furnished with sinews; as, a strong-sinewed youth.—2. Strong; firm; vigorous.

When he sees

Ourselves well *sinewed* to our defence.

*Shark*.

**SINEWLESS**, *a.* Having no strength or vigour.

**SINEW-SHRUNK**, *a.* Gaunt-bellied; having the sinews under the belly shrunk by excess of fatigue, as a horse.

**SINEWY**, *a.* Consisting of a sinew or nerve.

The *sinewy* thread my brain lets fall. *Donne*.

2. Nervous; strong; well braced with sinews; vigorous; firm; as, the *sinewy* Ajax.

The northern people are large, fair complexioned, strong, *sinewy* and courageous.

*Holt*.

**SINFUL**, *a.* [from *sin*.] Tainted with sin; wicked; iniquitous; criminal; unholly; as, *sinful* men.

Ah, *sinful* nation, a people laden with iniquity! *Isa. i.*

2. Containing sin, or consisting in sin; contrary to the laws of God; as, *sinful* actions; *sinful* thoughts; *sinful* words.

**SINFULLY**, *adv.* In a manner which the laws of God do not permit; wickedly; iniquitously; criminally.

**SINFULNESS**, *n.* The quality of being sinful or contrary to the divine will; wickedness; iniquity; criminality; as, the *sinfulness* of an action; the *sinfulness* of thoughts or purposes.—2. Wickedness; corruption; depravity; as, the *sinfulness* of men or of the human race.

**SING**, *v. i.* pret. *Sung*, *Sang*; pp. *Sung*.

[Sax. *singan*, *syngan*; Goth. *siggean*; G. *singen*.] It would seem from the Gothic that *n* is casual, and the elements *Sy*. If so, it coincides with *say* and *seek*, all signifying to strain, urge, press, or drive.] 1. To utter sounds with various inflections or melodious modulations of voice, as fancy may dictate, or according to the notes of a song or tune.

The noise of them that *sing* do I hear; Exod. xxxii.

2. To utter sweet or melodious sounds, as birds. It is remarkable that the female of no species of birds ever *sings*.

And *singing* birds in silver cages hung.

*Dryden*.

3. To make a small shrill sound; as, the air *sings* in passing through a crevice.

O'er his head the flying spear

*Sang* innocent, and spent its force in air.

*Pope*.

4. To tell or relate something in numbers or verse.

*Sing*

Of human hope by cross events destroyed.

*Prior*.

**SING**, *v. t.* To utter with musical modulations of voice.

And they *sung* the song of Moses, the servant of God, and the song of the Lamb; Rev. xv.

2. To celebrate in song; to give praises to in verse.

The last, the happiest British king,  
Whom thou shalt paint or I shall sing.  
*Addison.*

3. To relate or rehearse in numbers, verse, or poetry.

Arms and the man I sing. *Dryden.*  
While stretch'd at ease you sing your  
happy loves. *Dryden.*

SINGE, *v. t.* (sinj.) [Sax. *sængan*; G. *sengen*.] To burn slightly or superficially; to burn the surface of a thing, as the nap of cloth, or the hair of the skin; as, to *singe* off the beard.

Thus riding on his curls, he seem'd to pass  
A rolling fire along, and *singe* the grass.  
*Dryden.*

SINGE, *n.* A burning of the surface; a slight burn.

SING'ED, *pp.* Burnt superficially.

SING'EING, *ppr.* Burning the surface.

SING'ER, *n.* [from *sing*.] One that sings.—2. One versed in music, or one whose occupation is to sing; as, a chorus of *singers*. The chief elements of a good singer are: 1. a voice distinguished for melody and compass; 2. skill to read notes correctly and readily, and accurate intonation; 3. a distinct utterance; and 4. adaptation of the delivery to the meaning of the words, in which the singer shows his taste and feeling.—3. A bird that sings.

SING'ER, *n.* One who sings.

SINGH, *n.* [Hindu, a lion.] In the *East Indies*, a distinctive appellation of the khatries or military caste; and now assumed by many barbarous tribes converted by the Brahmans.

SINGHARA NUTS, *n.* In the *East Indies*, the name given to the fruit of a species of *Trapa*, the *T. bispinosa*, belonging to the nat. order Onagraceæ, and sub-order Hydrocaryes. These nuts are sweet and edible, and form an extensive article of cultivation in Cashmere, and other parts of the East.

SING'ING, *ppr.* or *a.* Uttering melodious or musical notes; making a shrill sound; celebrating in song; reciting in verse.

SING'ING, *n.* The act of uttering sounds with musical inflections; musical articulation; the utterance of melodious notes; Cant. ii. There are three chief methods or schools of singing—the Italian, German and French. Singing in its perfection unites music with lyric poetry.

SING'ING BIRD, *n.* A bird that sings.

SING'ING-BOOK, *n.* A music-book, as it ought to be called; a book containing tunes.

SING'INGLY, *adv.* With sounds like singing; with a kind of tune.

SING'ING-MAN, *n.* [singing and man.] A man who sings, or is employed to sing; as in cathedrals.

SING'ING-MASTER, *n.* A music-master; one that teaches vocal music.

SING'ING-WOMAN, *n.* A woman employed to sing.

SING'LE, *a.* [L. *singulus*; probably from a root that signifies to separate.] 1. Separate; one; only; individual; consisting of one only; as, a *single* star; a *single* city; a *single* act.—2. Particular; individual.

No *single* man is born with a right of controlling the opinions of all the rest. *Pope.*

3. Uncompounded.

Simple ideas are opposed to complex, and *single* to compound. *Watts.*

4. Alone; having no companion or assistant.

Who *single* hast maintain'd  
Against revolted multitudes the cause of  
truth. *Milton.*

5. Unmarried; as, a *single* man; a *single* woman.—6. Not double; not complicated; as, a *single* thread; a *single* strand of a rope.—7. Performed with one person or antagonist on a side, or with one person only opposed to another; as, a *single* fight; a *single* combat.—8. Pure; simple; incorrupt; unbiased; having clear vision of divine truth; Matth. vi.—9. † Small; weak; silly.—10. In *bot.*, a *single* flower is when there is only one on a stem, and in common usage, one not double.—*Single perianth*, a perianth of one verticil; as in the tulip and lily.—*Single frame and naked floor*, in *arch.*, a floor with only one tier of joists.—*Single flooring*, flooring constructed with only one series of joists.—*Single hung*, a term applied to a pair of window sashes in which one only is movable. *Single joists*, joists which are employed singly in a floor.—*Single-joist floor*, one that has no binding joists.—*Single measure*, a term applied to a door which is square on both sides. When it is moulded on both sides it is said to be *double measure*; and when moulded on one side and square on the other it is said to be *measure and half*.—*Single wind-rows*, in *agriculture*, a single range of new made hay before it is packed into cocks.

SING'LE, *v. t.* To select, as an individual person or thing from among a number; to choose one from others.

A dog who can *single* out his master in the dark. *Bacon.*

2. † To sequester; to withdraw; to retire; as, an agent *singling* itself from comforts.—3. † To take alone; as, men commendable when *singled* from society.—4. To separate.

SING'LED, *pp.* Selected from among a number.

SING'LE-HANDED, *a.* Having one hand or workman only.

SING'LE-HEARTED, *a.* Having no duplicity.

SING'LE-MINDED, *a.* Having a single purpose.

SING'LENESS, *n.* The state of being one only or separate from all others; the opposite of doubleness, complication, or multiplicity.—2. Simplicity; sincerity; purity of mind or purpose; freedom from duplicity; as, *singleness* of belief; *singleness* of heart.

SING'LES, *n. pl.* The reeled filaments of silk, twisted to give them firmness.

SING'LE-SEEDED, *a.* Containing one seed only.

SING'LE-STICK, *n.* A cudgel, called also a backword.

SING'LE-VALVED, *a.* Having one valve only.

SING'LING, *ppr.* Selecting from among a number.

SING'GLY, *adv.* Individually; particularly; as, to make men *singly* and personally good.—2. Only; by himself. Look thee, 'tis so, thou *singly* honest man. *Shak.*

3. Without partners, companions, or associates; as, to attack another *singly*. At ombre *singly* to decide their doom. *Dryden.*

4. Honestly; sincerely.

SING-SONG, *n.* A term for bad singing or cant; repetition of similar words or tones.

SING'ULAR, *a.* [Fr. *singulier*; L.

*singularis*; from *singulus*, single.] 1. Single; not complex or compound.

That idea which represents one determinate thing, is called a *singular* idea, whether simple, complex, or compound. *Watts.*

2. In *gram.*, expressing one person or thing; as, the *singular* number. The *singular* number stands opposed to *dual* and *plural*.—3. Particular; existing by itself; unexampled; as, a *singular* phenomenon. Your case is hard, but not *singular*.—4. Remarkable; eminent; unusual; rare; as, a man of *singular* gravity, or *singular* attainments.—5. Not common; odd; implying something censurable or not approved.

His zeal  
None seconded, as *singular* and rash. *Milton.*

6. Being alone; that of which there is but one.

These busts of the emperors and empresses are scarce, and some of them almost *singular* in their kind. *Addison.*

*Singular term*, in *logic*, a term which stands for one individual.—A *singular proposition*, is one which has for its subject either a singular term, or a common term limited to one individual, by a singular sign. [See TERM, PROPOSITION.]—*Singular successor*. In *Scots law*, a purchaser or other donee, or acquirer by titles, whether judicial or voluntary, is called a *singular successor*, in contradistinction to the heir, who succeeds by a general title of succession or universal representation.

SING'ULAR, *n.* A particular instance. [Unusual.]—2. In *gram.*, the singular number.

SING'ULARIST, *n.* One who affects singularity.

SINGULAR'ITY, *n.* [Fr. *singularité*.] 1. Peculiarity; some character or quality of a thing by which it is distinguished from all, or from most others.

Pliny addeh this *singularity* to that soil, that the second year the very falling of the seeds yieldeth corn. *Addison.*

2. An uncommon character or form; something curious or remarkable.

I took notice of this little figure for the *singularity* of the instrument. *Addison.*

3. Particular privilege, prerogative, or distinction.

No bishop of Rome ever took upon him this name of *singularity*, (universal bishop.) *Hooker.*

Catholicism must be understood in opposition to the legal *singularity* of the Jewish nation. *Pearson.*

4. Character or trait of character different from that of others. The *singularity* of living according to the strict precepts of the gospel is highly to be commended.—5. Oddity.—6. † Celibacy.

SIN'GULARIZE, † *v. t.* To make single.

SIN'GULARLY, *adv.* Peculiarly; in a manner or degree not common to others. It is no disgrace to be *singularly* good.—2. Oddly; strangely.—3. So as to express one or the singular number.

SIN'GULI IN SOLIDUM, [L.] A term in *Scots law*, signifying each for the whole.

SIN'GULT, † *n.* [L. *singultus*.] A sigh.

SIN'GULTUS, *n.* [L.] The hicough; a convulsive motion of the diaphragm and parts adjacent.

SIN'ICAL, *a.* [from *sine*.] Pertaining to a sine.—*Sinical quadrant*, a quadrant formerly used for taking the altitude

of the sun. It had lines drawn from each side intersecting each other, with an index divided by sines, also with 90° on the limb, and sights at the edge.

**SIN'ISTER, a.** [L. Probably the primary sense is, weak, defective.] 1. Left; on the left hand, or the side of the left hand; opposed to *dexter* or *right*; as, the *sinister* cheek. In *her.*, a term denoting the left side of the escutcheon, as the *sinister chief point*, and the *sinister base point*.—2. Evil; bad; corrupt; perverse; dishonest; as, *sinister means*; *sinister* purpose.

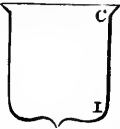

*Sinister.*  
C, I, *Sinister* side;  
C, *Sinister* chief;  
I, *Sinister* base.

He seems to undermine another's interest by any *sinister* or inferior arts. *South.*

3. Unlucky; inauspicious.—*Sinister aspect*, in *astrol.*, an appearance of two planets happening according to the succession of the signs; as Saturn in Aries, and Mars in the same degree of Gemini.

**SIN'ISTER-HANDED, † a.** Left-handed, unlucky.

**SIN'ISTERLY, adv.** Absurdly; perversely; unfairly.

**SIN'ISTRAL, a.** In *conchology*, *sinistral* shells are those in which the turns of the spiral are made to the left instead of to the right.

**SINISTROUSAL, a.** [*sinister* and Gr. *ageas*, to rise.] Rising from left to right, as a spiral line or helix.

**SINISTROUS, a.** Being on the left side; inclined to the left.—2. Wrong; absurd; perverse.

A knave or fool can do no harm, even by the most *sinistrous* and absurd choice.

**SIN'ISTROUSLY, adv.** Perversely; wrongly.—2. With a tendency to use the left as the stronger hand.

**SINK, v. i. pret. Sunk; pp. id.** The old pret. *sank*, and pp. *sunken*, are now little used. [Sax. *sencan*, *sincan*; G. *sinken*; coinciding with *siege*.] 1. To fall by the force of greater gravity, in a medium or substance of less specific gravity; to go to the bottom; not to swim; to subside; opposed to *swim* or *float*. Some species of wood or timber will *sink* in water. Oil will not *sink* in water and many other liquids, for it is specifically lighter.

I *sink* in deep mire; Ps. lxxix.

2. To fall gradually.

He *sunk* down in his chariot; 2 Kings ix.

3. To enter or penetrate into any body. The stone *sunk* into his forehead; 1 Sam. xvii.

4. To fall; to become lower; to subside or settle to a level.

The Alps and Pyrenees *sink* before him.

5. To be overwhelmed or depressed. Our country *sinks* beneath the yoke.

6. To enter deeply; to be impressed.

Let these sayings *sink* down into your ears; Luke ix.

7. To become deep; to retire or fall within the surface of any thing; as, the eyes *sink* into the head.—8. To fall; to decline; to decay; to decrease. A free state gradually *sinks* into ruin. It is the duty of government to revive a *sinking* commerce.

Let not the fire *sink* or slacken.

9. To fall into rest or indolence; as, to *sink* away in pleasing dreams.—10. To

be lower; to fall; as, the price of land will *sink* in time of peace.

**SINK, v. t.** To cause to sink; to put under water; to immerse in a fluid; as, to *sink* a ship.—2. To make by digging or delving; as, to *sink* a pit or a well.—3. To depress; to degrade. His vices *sink* him in infamy, or in public estimation.—4. To plunge into destruction.

If I have a conscience, let it *sink* me.

5. To cause to fall or to be plunged.—6. To bring low; to reduce in quantity. You *sunk* the river with repeated draughts.

7. To depress; to overbear; to crush. This would *sink* the spirit of a hero.—8. To diminish; to lower or lessen; to degrade.

I mean not that we should *sink* our figure out of covetousness.

9. To cause to decline or fail. Thy cruel and unnatural lust of power Has *sunk* thy father more than all his years.

10. To suppress; to conceal; to intercept.

If sent with ready money to buy any thing and you happen to be out of pocket, *sink* the money, and take up the goods on account. [Unusual.]

11. To depress; to lower in value or amount. Great importations may *sink* the price of goods.—12. To reduce; to pay; to diminish or annihilate by payment; as, to *sink* the national debt.—13. To waste; to dissipate; as, to *sink* an estate.—14. To reduce a capital sum of money, for the sake of greater profit or interest out of it.—To *sink* the shop, to avoid allusion to one's calling. [Familiar.]

**SINK, n.** [Sax. *sinc*.] 1. A drain to carry off filthy water; a jakes.—2. A kind of basin of stone or wood to receive filthy water.—3. Any place where corruption is gathered.

**SINK'ER, n.** A weight on something, as a fish-line, to sink it.

**SINK'-HOLE, n.** An orifice in a sink; a hole for dirty water to pass through.

**SINK'ING, ppr.** Falling; subsiding; depressing; declining. *Sinking fund*, in *finance*, a fund created for *sinking* or paying a public debt, or purchasing the stock for the government, consisting of the surplusage of other funds.

**SIN'LESS, a.** [from *sin*.] Free from sin; pure; perfect. Christ yielded a *sinless* obedience.—2. Free from sin; innocent; as, a *sinless* soul.

**SIN'LESSNESS, n.** Freedom from sin and guilt.

**SIN'NAMINE, n.** In *chem.*, a basic substance obtained from thiosinamine, another basic substance obtained from oil of mustard. Sinamine appears in the form of fine transparent crystals; it is a powerful base, expels ammonia from the salts, and precipitates the solutions of peroxide of iron, of copper, and of lead. It combines with acids, but yields no crystallizable salts. When heated it gives off ammonia, and leaves a resinoid matter, which is also basic.

**SIN'NER, n.** One that has voluntarily violated the divine law; a moral agent who has voluntarily disobeyed any divine precept, or neglected any known duty.—2. It is used in contradistinction to *saint*, to denote an unregenerate person; one who has not received the pardon of his sins.—3. An offender; a criminal.

**SIN'NER, v. i.** To act as a sinner; in *ludicrous language*.

Whether the charmer *sinner* it or saint it. *Pope.*

**SIN'NET, n.** In *seamen's lan.*, rope-yarn bound about ropes to prevent them from chafing; also written *senit*.

**SIN'-OFFERING, n.** [*sin* and *offering*.] A sacrifice for sin; something offered as an expiation for sin; Exod. xxix.

**SIN'OPER, n.** [L. *sinopsis*; Gr. *σινωπία*.] Red ferruginous quartz, of a blood or brownish red colour, sometimes with a tinge of yellow. It occurs in small but very perfect crystals, and in masses that resemble some varieties of jasper.

**SIN'OPIS, n.** In *painting*, a sort of red earth, in colour near to minium.

**SIN'O'PLE, n.** In *her.*, the Continental designation for the colour green; by English heralds called *vert*.

**SIN'-OPPRESS'ED, a.** Oppressed with a sense of sin.

**SIN-STUNG, a.** Stung with remorse for sin.

**SIN'TER, n.** In *min.*, calcareous sinter is a variety of carbonate of lime, composed of a series of successive layers, concentric, plane, or undulated, and nearly or quite parallel. It appears under various forms. Silicious sinter is white or grayish, light, brittle, porous, and of a fibrous texture.

Opaline silicious sinter somewhat resembles opal. It is whitish, with brownish, blackish, or bluish spots, and its fragments present dendritic appearances. Pearl sinter, or forite, occurs in stalactitic, cylindrical, botryoidal, and globular masses, white or grayish.

**SIN'TOC, } n.** The bark of a species  
**SIN'DOC, } of cinnamonum, which  
SYN'DOC, } has been called *C. sintoc*,  
by Blume, who says it is a tree 80 feet**

in height, indigenous in the primeval forests of Java. It is in flattish pieces, of a warm spicy taste, but is seldom seen in this country.

**SIN'UATE, v. t.** [L. *sinuo*.] To wind; to turn; to bend in and out.

**SIN'UATE, } a.** In *bot.*, a *sinuate*  
**SIN'UATED, } leaf** is one that has large curved breaks in the margin, resembling bays, as in the oak. *Sinuato-dentate*, sinuate and toothed, as a leaf.

**SIN'UATING, ppr.** Winding; turning; bending in and out.

**SINUA'TION, n.** A winding or bending in and out.

**SINUOS'ITY, n.** [L. *sinuosus*, *sinus*.] The quality of bending or curving in and out; or a series of bends and turns in arches or other irregular figures.

**SIN'UOUS, a.** [Fr. *sinueux*, from L. *sinus*.] Winding; crooked; bending in and out; as, a *sinuous* pipe.

Streaking the ground with *sinuous* trace. *Milton.*

2. In the *fine arts*, of a serpentine or undulating form.

**SIN'US, n.** [L. a bay.] A bay of the sea; a recess in the shore, or an opening into the land.—2. In *anat.*, a cavity in a bone or other part, wider at the bottom than at the entrance. The veins of the dura mater are called *sinuses*.—3. In *sur.*, a little elongated cavity, in which pus is collected; an elongated abscess with only a small orifice.—4. An opening; a hollow.—5. In *conch.*, a groove or cavity.

**SIP, v. t.** [Sax. *sipan*, to sip, to drink in, to macerate; G. *saufen*; Ir. *subham*; W. *sipiaw*; to draw the lips; *spiam*, to sip; Fr. *soupe*, *souper*; Eng. *sop*,

*sup, sup[er].* } 1. To take a fluid into the mouth in small quantities by the lips; as, to *sip* wine; to *sip* tea or coffee.—2. To drink or imbibe in small quantities.

Every herb that *sips* the dew. *Milton.*

3. To draw into the mouth; to extract; as, a bee *sips* nectar from the flowers.—4. To drink out of.

They skim the floods, and *sip* the purple flowers. *Dryden.*

SIP, *v. i.* To drink a small quantity; to take a fluid with the lips.

SIP, *n.* The taking of a liquor with the lips; or a small draught taken with the lips.

One *sip* of this

Will bathe the drooping spirits in delight,  
Beyond the bliss of dreams. *Milton.*

SIFE, } *v. i.* To ooze; to issue slowly;  
SEEP, } as, a fluid. [*Scotch.*]

SIPHILIS, *n.* The venereal disease. [*See SYPHILIS.*]

SIPHON, } *n.* [*L. siphō, sipo*; *Gr. SYPHON*, } *σιφων*; *Fr. siphon*; *Qn.* from the root of *sip*.] 1. A bent pipe or tube whose legs are of unequal length, used for drawing liquor out of a vessel by causing it to rise over the rim or top. For this purpose, the shorter leg is inserted in the liquor, and the air is exhausted by being drawn through the longer leg. (*See fig. 1.*) The liquor then rises by the weight of the atmosphere to supply the vacuum, till it reaches the top of the vessel, and then descends in the longer leg of the siphon, and continues to flow till the vessel is emptied. The action of the siphon depends on the difference between the lengths of the two legs, estimated in a perpendicular direction, the shorter leg being always inserted in the liquid. Sometimes an exhausting tube is placed on the longer leg for exhausting the air by suction, (*see fig. 2.*) and causing the flow to com-

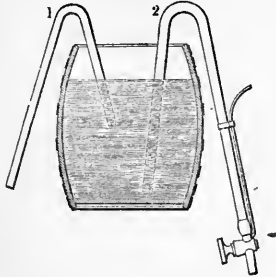

Fig. 1. Common Siphon. Fig. 2. Improved Siphon, with exhausting tube for filling it.

mence, but the more general method is to fill the tube in the first place with the liquid, and then stopping the mouth of the longer leg, to insert the shorter leg in the vessel; upon removing the stop the liquid will immediately begin to flow. The limits within which the siphon can act, are determined by the specific gravity of the fluid. Water cannot be raised by the siphon to a greater height than 34 feet, nor mercury to a greater height than 30 inches.—*Württemberg siphon*, (so called from its having been first used at that place), a siphon with both legs equal, and turned up at the extremities; in which case, so long as the extremities are kept on the same level, it will continue always full and ready for use.

SIPHON, } *n.* In *zool.*, the name  
SIPHUNCLE, } of the membranous, and calcareous tubes which traverse the septa, and the interior of Polythalamous shells. Also applied to the tubular prolongation of the mantle in certain univalve and bivalve molluscs; and by Latreille to the mouth of certain suctorious, crustaceous, and apterous insects.

SIPHONAPTERANS, *n.* A name given by Latreille to an order of insects including those apterous species which have a mouth in the form of a siphon.

SIPHONIA, *n.* A genus of plants belonging to the nat. order Euphorbiaceae, consisting of two species. *S. elastica*, which yields the true caoutchouc, is a tree from 50 to 60 feet in height, common in the forests of Guiana and Brazil, and which has been introduced into the West Indies. Caoutchouc is the milky juice of the tree which exudes on incisions being made, and solidifies on exposure to the air. This tree was named *Jatropha elastica* by the younger Linnaeus.

SIPHONIC, *a.* Pertaining to a siphon.  
SIPHONIFERA, *n.* M. D'Orbigny's name for an order of testaceous molluscs, including all those species which have a siphon contained within a polythalamous shell.

SIPHONBRANCHIATE, *a.* In *malacology*, provided with a siphon or tube, by which the water to be inhaled is carried to the gills, as in the siphonobranchiata. The molluscs which have no siphons are called *asiphonobranchiate*.

SIPHONBRANCHIATES, *n.* (*σιφων*, and *βραγχια*, gills.) The name of an order of gastropods, including those in which the branchial cavity terminates in a tube or siphon more or less prolonged, by which the respiratory current of water is received and expelled.  
SIPHONOTOMES, *n.* (*σιφων*, and *στομα*, a mouth.) The name of a family of crustaceans, comprehending those which have a siphon-shaped mouth for suction.

SIPHUNCLE. *See* SIPHON.

SIPHUNCULAR, *a.* Pertaining to a siphuncle.

SIPHUNCULATED, } *a.* [*L. siphunculus*, a little siphon.] Having a siphuncle; having a little siphon or spout, as a valve.

SIPING, *n.* The act of oozing. [*Scotch.*]

SIPPED, *pp.* Drawn in with the lips; imbibed in small quantities.

SIPPER, *n.* One that sips.

SIPPET, } *n.* A small sop.

SIPPING, *ppr.* Drawing in with the lips; imbibing in small quantities.

SI QUIS. [*L.* if any one.] These words give name to a notification by a candidate for orders of his intention to inquire whether any impediment may be alleged against him.

SIR, *n.* (*sur.*) [*Fr. sire*, and *sieur*, in *monsieur*; *Norm. sire*, lord; *Corn. sira*, father; *Heb. שׁוּר*, *shur*, to sing, to look, observe, watch, also to rule. The primary sense is to stretch, strain, hold, &c., whence the sense of a ruler or chief.] 1. A word of respect used in addresses to men, as *madam* is in addresses to women. It signifies properly *lord*, corresponding to *dominus* in Latin, *don* in Spanish, and *herr* in German. It is used in the singular or plural. Speak on, *Sir*. *Shak.*

But, *Sirs*, be sudden in the execution. *Shak.*

2. The title of a knight or baronet pre-

fixed to the Christian name; as, *Sir* Horace Vere.—3. It is used by *Shakspere* for *man*.

In the election of a *sir* so rare.† *Shak.*

4. In American colleges, the title of a master of arts.—5. It is prefixed to *loin*, in *sirloin*; as, a *sirloin* of beef. This practice is said to have originated in the knighting of a loin of beef by one of the English kings in a fit of good humour.—6. Formerly the title of a priest, whence a *Sir* John came to be a nickname of a priest.

SIR'CAR, *n.* A Hindoo clerk or accountant.

SIR'DAR, *n.* [*Hindustanee.*] A chieftain, captain, head-man.—*Sirdar-bearer* (frequently contracted *sirdar*), the chief of the palankeen bearers, and generally his master's valet.

SIRE, *n.* [*supra.*] A father; *used in poetry.* And raise his issue like a *loving sire*. *Shak.* Since the 16th century the word *sire* has been used in prose only in addressing sovereign princes.—2. The male parent of a beast; particularly used of horses; as, the horse had a good *sire*, but a bad dam.—3. It is used in composition; as, in *grandsire*, for grandfather; great *grandsire*, great grandfather.—4. A term of respect, of French origin, by which the king is addressed.

SIRE, *v. t.* To beget; to procreate; *used of beasts.*

SIRED, *pp.* Begotten.

SIREDON, *n.* Wagler's name for the Axolotl, a singular genus of batrachian reptiles belonging to the perennibranchiate family, or those which retain their gills throughout life. *Siredons*



Siredon axolotl.

are true amphibiae, being possessed of both lungs and gills. They resemble, in many respects, the salamander, and are found abundantly in the lakes of Mexico, in which country their flesh is esteemed a delicacy.

SIREN, *n.* [*L.*; *Fr. sirène*; from *Heb. שׁוּר*, *shur*, to sing.] 1. In *ancient myth.*, a mermaid or goddess, who enticed



Siren.

men into her power by the charms of music, and devoured them. Hence in



modern use, an enticing woman; a female reudered dangerous by her enticements.

Sing, *siren*, to thyself, and I will dole.

*Shak.*

2. A genus of perennibranchiate Batrachians, which have only one pair of feet, and are supplied both with lungs and external gills, by this means being rendered truly amphibial. They are peculiar to the southern provinces of the United States.

SIREN, *a.* Pertaining to a siren, or to the dangerous enticements of music; bewitching; fascinating; as, a *siren* song.

SIRENE, *n.* In *acoustics*, an instrument for determining the velocity of aerial vibrations, corresponding to the different pitches of musical sounds.

SIRENIZE, *v. i.* To use the enticements of a siren; to charm.

SIRENIZED, *pp.* Charmed.

SIRENIZING, *ppr.* Charming.

SIREX, *n.* A genus of hymenopterous insects, called in English tailed wasps.

SIRIASIS, *n.* [*Gr. sigais.* See SIRIUS.]

A disease occasioned by the excessive heat of the sun; almost peculiar to children.

SIRIUS, *n.* [*L.* from the *Gr. σιρ*, the sun.] The large and bright star called the dog-star, in the mouth of the constellation *Canis major*.

SIRLOIN, *n.* The loin of beef, said to have been knighted by one of our kings. [See SIR.]

SIRNAME, is more correctly written *Surname*.

SIRO, *n.* A mite.

SIROCO, or SCIROCO, *n.* [*It. id.*; *Sp. siroco* or *xalogue*.] An oppressive relaxing wind coming from Northern Africa, over the Mediterranean, to Italy, Sicily, &c. It produces on the human frame excessive languor, and a sinking of the mental energies. The setting in of the sirocco is followed by a considerable rise of the thermometer, and is attended with a haze which obscures the atmosphere.

SIRRAH, *n.* A compellation of reproach and insult; used in addressing servile characters. It is applied sometimes to children in a kind of playfulness, or to servants in hastiness.

Go, *sirrah*, to my cell. *Shak.*

[It is not known whence we have this word. The common derivation of it from *sir*, *ha*, is ridiculous.]

SIRT, † *n.* (*sert*). [*L. syrtris*.] A quicksand.

SIRUP, *n.* [*Oriental*. See *SHERBER* and *ABSORB*.] The sweet juice of vegetables or fruits, or other juice sweetened; or sugar boiled with vegetable infusions.

SIRUPED, *a.* Moistened or tinged with sirup or sweet juice.

SIRUPY, *a.* Like sirup, or partaking of its qualities.

SIRVENTE, *n.* (*sur-vangt'*). [*Fr.*] In the literature of the middle ages, a species of poem in common use among the Troubadours, usually satirical, and divided into strophes of a peculiar construction.

SISAL-HEMP, } *n.* The prepared  
SISAL-GRASS, } fibre of the Agave Americana, or American aloe, used for cordage; so called from Sisal, a port in Yucatan.

SISE, for *Assize*.

SISE, *n.* Six, a term in games.

SISKIN, *n.* A bird; another name of the aberdavine. The siskin or aberdavine is the *Fringilla spinus*.

SISON, *n.* A genus of plants belonging

to the nat. order Umbelliferæ. Two species are found in Britain: *S. anomum*, hedge-stonewort, or bastard stone-parsley; and *S. segetum*, corn-parsley or stonewort. *S. anomum* grows chiefly in chalk soils in rather moist ground, under hedges, &c. The green-plant, when bruised, has a peculiarly nauseous smell, something like that of bugs. The seeds are pungent and aromatic, and were formerly celebrated as a diuretic.

SIS'OOO, *n.* A tree well known throughout the Bengal Presidency, and highly valued on account of its timber, which furnishes the Bengal ship-builders with their crooked timbers and knees. It is universally employed both by Europeans, and natives of the north-west provinces of India, where strength is required. It is the *Dalbergia sissoo* of botanists, and belongs to the papilionaceous division of the nat. order Leguminosæ.

SIST, *v. i.* [*L. sistere*, to stop.] To stop; to stay.—*To sist proceedings* or *process*, to delay judicial proceeding in a cause; used both in civil and ecclesiastical courts.—2. To cite or summon.—*To sist one's self*, to take a place at the bar of a court where one's cause is to be judicially tried and determined. [*Scotch*.]

SIST, *n.* In *Scots law*, the act of legally staying diligence, or execution on decrees for civil debts.—*Sist on a suspension*, in the court of session, the order or injunction of the lord ordinary prohibiting diligence to proceed, where relevant grounds of suspension have been stated in the bill of suspension. [See SUSPENSION.]

SISTER, *n.* [*Sax. sweoster*; *G. schweste*; *Sw. syste*.] 1. A female born of the same parents; correlative to *brother*.—2. A woman of the same faith; a female fellow Christian.

If a brother or sister be naked and destitute of daily food... James ii.

3. A female of the same kind.—4. One of the same kind, or of the same condition; as, *sister-fruits*.—5. A female of the same society; as the nuns of a convent.

SISTER, *v. t.* To resemble closely. [*Little used*.]

SISTER, *v. i.* To be akin; to be near to. [*Little used*.]

SISTERHOOD, *n.* [*sister* and *hood*.] Sisters collectively, or a society of sisters; or a society of females united in one faith or order.—2. The office or duty of a sister. [*Little used*.]

SISTER-IN-LAW, *n.* A husband's or wife's sister.

SISTERLY, *a.* Like a sister; becoming a sister; affectionate; as, *sisterly* kindness.

SISTERS OF CHARITY, *n. plur.* An order of uncloistered nuns, first instituted in France, who attend sick in hospitals, criminals in prison, &c.; or give instruction to the ignorant, and set the idle to work. In England, a similar body of nuns, of recent institution, is called *sisters of mercy*.

SISTRUM, *n.* [*Gr. σιστρον*, from *σειν*, to shake.] A kind of timbrel which the Egyptian priests of Isis used to shake with their hands at the festivals of that goddess.

SISYMBRIUM, *n.* A genus of plants belonging to the nat. order Crucifereæ. The species, which are numerous, are mostly perennial or annual herbs, with yellow or white flowers, and leaves very variable on the same plant. A few are well known on account of their uses.—*S. officinale* is our common hedge-mustard. [See HEDGE-MUSTARD.]—*S. irio*, or London rocket, is a native of waste places throughout Europe, especially about London. The whole plant possesses the hot biting character of the mustard.—*S. sophia*, or fine-leaved hedge-mustard, or flix-weed, is frequent in Great Britain. It was formerly supposed to have the power of controlling diarrhoea, dysentery, &c.—*S. millefolium*, or mill-foil leaved flix-weed, is a green-house species.

SISYPHUS, *n.* In *ancient myth*., one of the descendants of Æolus, distinguished for his craftiness and cunning. His punishment in Tartarus, for his crimes committed on earth, consisted in rolling a huge stone to the top of a hill, which constantly recoiled, and rendered his labour incessant.

SIT, *v. i.* pret. *Sat*; old *pp.* *Sitten*.

[*Goth. sitan*; *Sax. sitan* or *sittan*; *G. sitten*; *L. sedeo*; *Fr. seoir*, whence *asseoir*, to set or place, to lay, to assess, from the participle of which we have *assise*, *assize*, a sitting, a session, whence *size*, by contraction; *W. seza*, to sit habitually; *sczu*, to seat; *gorseze*, a supreme seat; *gorsezu*, to preside; *Arm. azeza*, *diaseza*, *sizhea*, to sit; *Ir. suidhim*, *elsidhim*, and *seisim*; *Corn. seadha*, to sit. It coincides with the *Ch.* and *Heb.* *שׂבַּד*, *yasud*, and *Heb.* *שׂוּבַד*, *shuth*, to set, place, or found, and perhaps with the *Ar. sadda*, to stop, close, or make firm. See *SER*. The *Sp. sitar*, to besiege, is the same word differently applied.] 1. To rest upon the buttocks, as animals; as, to sit on a sofa or on the ground.—2. To perch; to rest on the feet; as fowls.—3. To occupy a seat or place in an official capacity.

The scribes and the Pharisees sit in Moses' seat; Matt. xxiii.

4. To be in a state of rest or idleness.

Shall your brethren go to war, and shall ye sit here; Num. xxxii.

5. To rest, lie, or bear on, as a weight or burden; as, grief sits heavy on his heart.—6. To settle; to rest; to abide.

Pale horror sat on each Arcadian face.

*Dryden*.

7. To incubate; to cover and warm eggs for hatching; as a fowl.

As the partridge *sit*eth on eggs and hatcheth them not; Jer. xvii.

8. To be adjusted; to be, with respect to fitness or unfitness; as, a coat sits well or ill.

This new and gorgeous garment, majesty, sits not so easy on me as you think.

*Shak.*

9. To be placed in order to be painted; as, to sit for one's picture.—10. To be in any situation or condition.

Suppose all the church lands to be thrown up to the laity; would the tenants sit easier in their rents than now? *Swift*.

11. To hold a session; to be officially engaged in public business; as, judges, legislators, or officers of any kind. The house of commons sometimes sits till late at night. The judges or the courts sit in Westminster Hall. The commissioners sit every day.—12. To exercise authority; as, to sit in judgment.

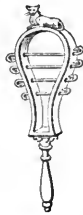

Sistrum.

One council *sits* upon life and death.  
—13. To be in any assembly or council as a member; to have a seat.  
—14. To be in a local position. The wind *sits* fair. [*Unusual.*]—*To sit at meat*, to be at table for eating.—*To sit down*, to place one's self on a chair or other seat; as, *to sit down* at a meal.  
—2. To begin a siege. The enemy *sat down* before the town.—3. To settle; to fix a permanent abode.—4. To rest; to cease as satisfied.

Here we cannot *sit down*, but still proceed in our search. *Rogers.*  
*To sit out*, to sit till all is done; also, to be without engagement or employment. [*Lit. us.*]—*To sit up*, to rise or be raised from a recumbent posture.

He that was dead *sat up*, and began to speak: Luke vii.

2. Not to go to bed; as, *to sit up* late at night; also, to watch; as, *to sit up* with a sick person.

SIT, *v. t.* To keep the seat upon. He *sits* a horse well. [*This phrase is elliptical.*]—2. *To sit* me down, *to sit him* down, *to sit* them down, equivalent to *I seated myself*, &c. are familiar phrases used by good writers, though deviations from strict propriety.

They *sat* them down to weep. *Milton.*  
3. "The court was *sat*," an expression of Addison, is a gross impropriety.

SITE, *n.* [*L. situs*, Eng. *seat*; from the root of *L. sedeo*, *to sit*. The Roman pronunciation was *seetus*.] 1. Situation; local position; as, the *site* of a city or of a house.—2. The posture of a thing with respect to itself.

The semblance of a lover fix'd  
In melancholy *site*. *Thomson.*

[*This is improper.*] 3. In *arch.*, the situation of a building, or the plot of ground on which it stands.

SIT'ED, *† a* Placed; situated.

SIT'FAST, *n.* A hard knot growing on a horse's back under the saddle.

SITH, *† adv.* [*Sax. sith*, *siththan*.] Since; seeing that; in later times.

SITHE, *† n.* Time.

SITHE. See SCYTHE.

SITHENCE, *† adv.* [*Sax. siththan*.]  
SITHES, } Since; in later times.

SITIOLOGY, *n.* [*Gr. sitos*, aliment, and *logos*, discourse.] That department of medicine which relates to the regulation of diet. It is synonymous with *dietetics*.

SITTA, *n.* A genus of birds known by the name of Nuthatches. [*See NUT-HATCH.*]

SIT'TER, *n.* [from *sit*.] One that sits. The Turks are great *sitters*.—2. A bird that sits or incubates.—3. One who is placed so that a painter may draw his likeness.

SITTING, *ppr.* Resting on the buttocks, or on the feet, as fowls; incubating; brooding; being in the actual exercise of authority, or being assembled for that purpose.—2. *a.* In *bot.*, sessile, i. e. without petiole, peduncle or pedicel, &c.

SITTING, *n.* The posture of being on a seat.—2. The act of placing one's self on a seat; as, a *sitting* down.—3. The act or time of resting in a posture for a painter to take the likeness. For a portrait, six or seven *sittings* may be required.—4. A session; the actual presence or meeting of any body of men in their seats, clothed with authority to transact business; as, a *sitting* of the judges of the king's bench; a *sitting* of the house of commons; during the *sitting* of the supreme court.

—5. An uninterrupted application to business or study for a time; course of study unintermitted.

For the understanding of any one of Paul's epistles, I read it through at one *sitting*. *Locke.*

6. A time for which one sits, as at play, at work, or on a visit.—7. Incubation; a resting on eggs for hatching; as fowls.

The male bird amuses the female with his songs, during the whole time of her *sitting*. *Addison.*

SIT'UATE, *a.* [*Fr. situer*; from *L. situs*, *sedeo*.] 1. Placed, with respect to any other object; as, a town *situate* on a hill or on the sea shore.—2. Placed, consisting.

Pleasure *situate* in hill and dale. *Milton.*

SIT'UATED, *a.* [*See SITUATE.*] Seated, placed, or standing with respect to any other object; as, a city *situated* on a declivity, or in front of a lake; a town well *situated* for trade or manufactures; an observatory well *situated* for observation of the stars. Newcastle is *situated* about the fifty-fifth degree of north latitude.—2. Placed or being in any state or condition with regard to men or things. Observe how the executor is *situated* with respect to the heirs.

SITUA'TION, *n.* [*Fr.*; *It. situazione*.] 1. Position; seat; location in respect to something else. The *situation* of London is more favourable for foreign commerce than that of Paris. The *situation* of a stranger among people of habits differing from his own, cannot be pleasant.—2. State; condition. He enjoys a *situation* of ease and tranquillity.—3. Circumstances; temporary state; *used of persons in a dramatic scene*.—4. Place; office. He has a *situation* in the war department, or under government.

SITUM, *n.* A genus of plants belonging to the nat. order Umbelliferae. The best known species is *S. sisarum*, or skirret,—*which see*.

SIVA, *n.* In *Hindoo myth.*, a title given to the Supreme Being, considered in the character of the avenger or destroyer.

SIVAN, *n.* The third month of the Jewish ecclesiastical year, answering to part of our May and part of June.

SIVATHE'RIUM, *n.* [*Siva*, an Indian deity, and *Gr. theos*, a wild animal.] The name of an extinct genus of Ruminantia, found in fossil remains in the tertiary strata of the Sivalik Sub-Himalayan range. It surpassed all known ruminants in size. It had four horns and a proboscis, and must have resembled an immense antelope.

SIX, *a.* [*Fr. six*; *L. sex*; *G. sechs*; *Dan.* and *Sw. sex*; *Sax. six*; *Gr. ἕξ*.] Twice three; one more than five.

SIX, *n.* The number of six or twice three.—*To be at six and seven*, or as more generally used, at *sizes* and *sevens*, is to be in disorder and confusion.

SIX-CLERKS, *n.* Officers formerly in chancery, whose duty was to transact and file all proceedings by bill and answer, and also issue some patents that pass the great seal, as pardons of men for chance-medley, patents for ambassadors, sheriff's patents, and some others. They likewise signed all office copies of bills, and answers to be read in court, and also certificates of their being filed, and were required to attend upon the court in term, by two

at a time, at Westminster, and there read the pleadings. The office of the six clerks has been abolished.

SIX'FOLD, *a.* [*six* and *fold*; *Sax. six* and *feald*.] Six times repeated; six double; six times as much.

SIX'PENNY, *n.* [*six* and *pence*.] An English silver coin of the value of six pennies; half a shilling.—2. The value of six pennies or half a shilling.

SIX'-PENNY, *a.* Worth sixpence; as, a *six-penny* loaf.

SIX'-PETALED, *a.* In *bot.*, having six distinct petals or flower leaves.

SIX'SCORE, *a.* [*six* and *score*.] Six times twenty; one hundred and twenty.

SIX'TEEN, *a.* [*Sax. sixtene*, *sixtyme*.] Six and ten; noting the sum of six and ten.

SIX'TEENTH, *a.* [*Sax. sixteotha*.] The sixth after the tenth; the ordinal of sixteen.

SIXTH, *a.* [*Sax. sixta*.] The first after the fifth; the ordinal of six.

SIXTH, *n.* The sixth part.—2. In *music*, a hexachord, an interval of two kinds; the minor sixth, consisting of three tones and two semitones major, and the major sixth, composed of four tones and a major semitone.

SIXTH'LY, *adv.* In the sixth place.

SIX'TIETH, *a.* [*Sax. sixteogotha*.] The ordinal of sixty.

SIX'TY, *a.* [*Sax. siatiug*.] Ten times six.

SIX'TY, *n.* The number of six times ten.

SIZAR, *n.* [from *size*.] *Sizars* are the lowest class of students at Cambridge and Dublin. At Oxford, the same class go in different colleges by the denominations of servitors, &c. They are such as have certain allowances made in their battels, (college bills), through the benefactions of founders, or other charitable persons. The *sizars* at Cambridge are now almost entirely on the same footing with independent students; at Oxford they are somewhat lower, and some relics of their former degraded condition still subsist in certain colleges, in the customs of bringing up dishes to dinner, dining off the remnants of the fellows' dinners, &c.

SIZE, *n.* [either contracted from *assize*, or from the *L. scissus*. Probably it is from the former, and from the sense of setting, as we apply the word to the *assize* of bread.] 1. Bulk; bigness; comparative magnitude; extent of superficies. *Size* particularly expresses thickness; as, the *size* of a tree or of a mast; the *size* of a ship or of a rock. A man may be tall, with little *size* of body.—2. A settled quantity or allowance.—3. In *college phraseology*, a portion of bread, meat, &c., allotted to a student, and hence the name *sizar*. [Contracted from *assize*.]—4. Figurative bulk; condition as to rank and character; as, men of less *size* and quality. [*Not much used.*]—5. With *shoemakers, hatters*, &c., a measure of length.

SIZE, *n.* [*W. syth*, stiff, rigid, and *size*; *Sp. sisa*; from the root of *assize*, that which sets or fixes.] 1. A sort of varnish, paint, or glue used by painters, paper manufacturers, and in many other trades. It is made of the shreds and parings of leather, parchment, or vellum, boiled in water and purified. It is also made from common glue, and from potatoes.—2. An instrument consisting of thin leaves fastened together

at one end by a rivet; used for ascertaining the size of pearls.

**SIZE, v. t.** To adjust or arrange according to size or bulk.—2. To settle; to fix the standard of; as, to *size* weights and measures. [*Now little used.*]—3. To cover with size; to prepare with size.—4. To swell; to increase the bulk of.—5. Among Cornish miners, to separate the finer from the coarser parts of a metal by sifting them through a wire sieve.

**SIZE, v. i.** At the *university of Cambridge*, to order food or drink from the buttery, in addition to the regular commons; a word corresponding to *battel* at Oxford. [*See the noun.*]

**SIZEABLE, a.** [from *size*.] Of considerable bulk.—2. Being of reasonable or suitable size; as, *sizeable* timber.

**SIZED, pp.** Adjusted according to size; prepared with size.—2. *a.* Having a particular magnitude.

And as my love is *sized* my fear is so.

*Shak.*

**Note.**—This word is used in compounds; as, *large-sized*, *common-sized*, *middle-sized*, &c.

**SIZE'EL, n.** In *coining*, the residue of bars of silver, after pieces are cut out for coins.

**SIZER, n.** In the *university of Cambridge*, a student of the rank next below that of a pensioner. [*See SIZAR.*]

**SIZE-STICK, n.** With shoemakers, a measuring stick.

**SIZINESS, n.** [from *sizy*.] Glutinousness; viscousness; the quality of size; as, the *siziness* of blood.

**SIZING, ppr.** Arranging according to size.

**SIZING, n.** A glutinous substance used in manufactures. [*See SIZE.*]

**SIZY, a.** [from *size*.] Glutinous; thick and viscous; ropy; having the adhesiveness of size; as, *sizy* blood.

**SKAD'DLE, † n.** [Sax. *scath*, *seath*.] Hurt; damage.

**SKAD'DLE, † a.** Hurtful; mischievous.

**SKAD'DONS, † n.** The embryos of bees.

**SKAIL, or SKALE, v. t.** [Sax. *scylan*.]

To disjoin; to separate; to disperse; to scatter; to spill. [*Scotch.*]

**SKAIL, or SKALE, v. i.** To part; to separate one from another; as, an assembly or congregation. [*Scotch.*]

**SKÄIN.** *See SKÉIN.*

**SKÄINSMATE, † n.** A messmate; a companion.

**SKÄITH, n.** [Sax. *scaethan*, to injure.] Hurt; damage; injury. [*Scotch.*]

**SKÄLD, n.** [Qui. Sw. *scalla*, to sing.]

An ancient Scandinavian poet or bard.

**SKAR, or SKAIR, v. n.** To take fright; to be affrighted. [*Scotch.*]

**SKAR, or SKAIR, a.** Timorous; easily affrighted or startled; shy. [*Scotch.*]

**SKAR, or SKAIR, n.** A fright. [*Scotch.*]

**SKATE, n.** [D. *schaats*; probably from the root of *shoot*; It. *scatto*, a slip or slide.] A sort of shoe furnished with a smooth iron for sliding on ice.

**SKATE, v. i.** To slide or move on skates.

**SKATE, n.** [Sax. *sceadda*; L. *squatius*, *squatina*; W. *cáth vor*, or *morgath*, that is, *seacat*.] This shows that *skate* is formed on *cat*. The primary sense of *cat* is not well ascertained; but in W. *cáth eithen*, is a hair; that is, *furze* or *gorse-cat*.] A name used in England, as well as the term Ray, to designate numerous fishes of the genus *Raia*,

with cartilaginous skeletons, having the body much depressed, and more or less approaching to a rhomboidal form. The peculiar form of the skate arises chiefly from the great size and expansion of the pectoral fins. Nine species of skate or rays are found on the Bri-

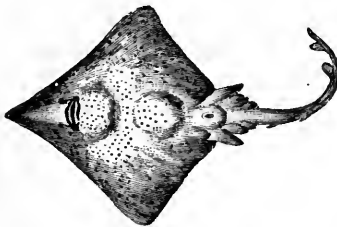

Grey Skate (*Raia batis*).

titish coast, among which are the true skate, called in Scotland *blue skate* and *gray skate*, (*Raia batis*, of which the flesh is so much esteemed as food,) the long-nosed skate, the sharp-nosed skate, the thornback, &c.

**SKATER, n.** One who skates on ice.

**SKÄTING, ppr.** Sliding or moving on skates.

**SKÄTING, n.** The act or exercise of moving upon ice by means of skates.

The best skaters are found in Holland.

**SKEAN, † n.** [Sax. *sægen*.] A short sword, or a knife, formerly used by the Irish, and Highlanders of Scotland.

**SKEED.** *See SKID.*

**SKEEL, n.** [G. *schale*, Eng. *shell*.] A shallow wooden vessel for holding milk or cream.

**SKEET, n.** A sort of long scoop, used to wet the decks and sides of a ship in order to keep them cool, and to prevent them from splitting by the heat of the sun. It is also employed in small vessels to wet the sails, in order to render them more efficacious in light breezes.

**SKEG, n.** A sort of wild plum.

**SKEG'GER, n.** A little salmon.

**SKEIGH, a.** [G. *scheuch*, shy.] Timorous; apt to startle; skittish; coy; shy. [*Scotch.*]

**SKÉIN, SKÄIN, or SKÉAN, n.** [Fr. *escavigne*.] A quantity of thread, yarn, or silk put up together after it is taken off the reel. The *skéin* contains 80 threads, each 54 inches long.

**SKEL'DER, † n.** A cant term for a vagrant.

**SKEL'ETON, n.** [Fr. *squelette*; Gr. *σκαλιτος*, dry, from *σκαλλω*, to dry, that is, to contract; allied perhaps to L. *calleo*, *callus*.] 1. The bones of an animal body, separated from the flesh and retained in their natural position or connections. When the bones are connected by the natural ligaments, it is called a *natural* skeleton; when by wires, or any foreign substance, an *artificial* skeleton.—2. The compages, general structure, or frame of any thing; the principal parts that support the rest, but without the appendages.—3. A very thin or lean person.—

*Skeleton bills*, in *Scots law*, signed blank papers, stamped with a bill stamp. The subscriber is held the drawer or acceptor, as it may be, of any bill afterwards written above his name, for any sum which the stamp will cover.

**SKEL'ETON, a.** Containing mere outlines or heads; as, a *skeleton sermon*, or other discourse.—A *skeleton regiment* is one, the officers, &c., of which are kept up after the men are disbanded, with a view to future service.

**SKEL'ETON-KEY, n.** A thin, light key, with nearly the whole of the bits filed away, so that it may be less obstructed by the wards of a lock.

**SKEL'LUM, † n.** [G. *schelm*.] A scoundrel.

**SKEL'LY, v. i.** To squint.

**SKELP, v. t.** [Isl. *shelfa*.] To strike with the open hand; to strike in whatever way. [*Scotch.*]

**SKEP, n.** A sort of basket, narrow at the bottom and wide at the top.—

2. In *Scot.*, the repository in which bees lay their honey.

**SKEP'TIC.** *See SCEPTIC.*

**SKER'RY, n.** A rocky isle.

**SKETCH, n.** [D. *schets*; G. *skizze*; Fr. *esquisse*; Sp. *esquicio*; It. *schizzo*, a sketch, a squinting, a spurt, a gushing, a leap, hop, or frisking; *schizzare*, to squirt, to spin, stream, or spout. We see the primary sense of the verb is to throw, the sense of *shoot*, L. *scateo*.]

An outline or general delineation of any thing; a first rough or incomplete draught of a plan or any design; as, the *sketch* of a building; the *sketch* of an essay.—2. In *painting*, the first delineated idea of the artist's conception of a subject, in which are usually distinguishable the fire and enthusiasm with which the subject is expressed and felt. Sketches are made either with carbon, with the pen, or the pencil; in general, that method is preferred which seems to present the greatest promptitude and facility.

**SKETCH, v. t.** To draw the outline or general figure of a thing; to make a rough draught.—2. To plan by giving the principal points or ideas.

**SKETCH'ED, pp.** Having the outline drawn.

**SKETCH'INESS, n.** State of being sketchy.

**SKETCH'ING, ppr.** Drawing the outline.

**SKETCH'Y, a.** Containing slight sketches; or resembling sketches; unfinished; a *sketchy drawing* or *painting* is one performed in a slight and perfunctory style.

**SKREW, adv.** [G. *schief*; Dan. *shiev*.] Awry; obliquely. [*See ASKEW.*]

**SKEW, † v. t.** [Dan. *skiev*, to twist or distort.] 1. To look obliquely upon; to notice slightly.—2. † To shape or form in an oblique way.

**SKEW, v. i.** To walk obliquely. [*Local.*]

**SKEW, a.** Distorted; oblique; as, a *skew* bridge.

**SKEW, n.** A term used in the north for the coping of a gable.

**SKEW'-BACK, n.** In *arch*, that part of a straight or curved arch which recedes on the springing from the vertical line of the opening. In bridges, it is the course of masonry forming the abutment for the voussours of a segmental arch, and in iron bridges for the ribs.

**SKEW' BRIDGE, n.** A bridge in which the passages over and under the arch intersect each other obliquely. In conducting a road or railway through a district in which there are many natural or artificial water-courses, or in making a canal through a country in which roads are frequent, such intersections very often occur. Before the introduction

of railways skew bridges were seldom erected, it being more usual to build the bridge at right angles, and to divert the course of the road or the stream to accommodate it. But in a railway, and sometimes in a canal, such a deviation from the straight line of direction is inadmissible, and it therefore becomes necessary to build the bridge obliquely.—*Skew arch*, an oblique arch.—*which see*.

**SKEW'-CORBEL,** } *n.* A stone built  
**SKEW'-PUT,** } into the bottom  
of a gable to support the coping above.

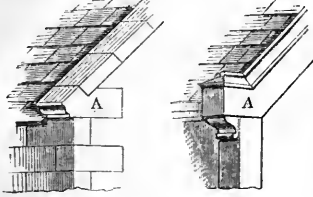

Skew-Corbels.

**SKEWER,** *n.* A pin of wood or iron for fastening meat to a spit, or for keeping it in form while roasting.

**SKEWER,** *v. t.* To fasten with skewers.

**SKEWERING,** *ppr.* Fastening with skewers.

**SKEW-FILLET,** *n.* A fillet nailed on a roof along the gable coping, to raise the slates there and throw the water away from the joining.

**SKEW-WHEEL,** *n.* In *mech.*, skew-wheels are a species of bevel wheels having the teeth formed obliquely on the rim. Their purpose is to transfer motion between shafts whose axes do not admit of being united in a point. Such wheels being difficult of construction are only employed in cases of absolute necessity.

**SKID,** *n.* A curving timber to preserve a ship's side from injury by heavy bodies hoisted or lowered against it; a slider.—2. A shoe or drag used for preventing the wheels of a waggon or carriage from revolving when descending a steep hill.

**SKIFF,** *n.* [Fr. *esquif*; It. *schifo*; L. *scapha*; G. *schiff*; from the same root as *skip*.] A small light boat resembling a yawl. Also, a wherry, without masts or sails, usually employed to pass a river.

**SKIFF,** *v. t.* To pass over in a light boat.

**SKILFUL,** *a.* Knowing; well versed in any art; hence, dextrous; able in management; able to perform nicely any manual operation in the arts or professions; as, a *skilful* mechanic; a *skilful* operator in surgery.—2. Well versed in practice; as, a *skilful* physician. It is followed by *at* or *in*; as, *skilful* at the organ; *skilful* in drawing.

**SKILFULLY,** *adv.* With skill; with nice art; dextrously; as, a machine *skilfully* made; a ship *skilfully* managed.

**SKILFULNESS,** *n.* The quality of possessing skill; dextrousness; ability to perform well in any part or business, or to manage affairs with judgment and exactness, or according to good taste or just rules; knowledge and ability derived from experience.

**SKILL,** *n.* [Sax. *scylan*, to separate, to distinguish; Ice and Sw. *skilta*, Dan. *skiller*, to divide, sever, part; whence

*shield*, that which separates, and hence that which protects or defends; D. *scheelen*, to differ; *schillen*, to peel or pare. *Scale* is from the root of these words, as in *shell*, Sax. *scyl*, *seal*. In Heb. כִּלְיָה, *sahal*, is foolish, perverse, and as a verb, to pervert, to be foolish or perverse; in Ch. to understand or consider, to look, to regard, to cause to know, whence knowledge, knowing, wise, wisdom, understanding; Rab. to be ignorant or foolish; Syr. to be foolish, to wander in mind, also to cause to understand, to know, to perceive, to discern, also to err, to do wrong, to sin, to fail in duty; whence foolish, folly, ignorance, error, sin, and understanding; Sam. to be wont or accustomed, to look or behold. The same verb with, ש, Heb. כִּלְיָה, *sahal*, signifies to understand, to be wise, whence wisdom, understanding, also to waste, to scatter or destroy, to bereave, also to prosper; Ch. to understand; עֲשֵׂה, *shahel*, to complete, to perfect; כָּלַל, *halal*, with a prefix. This signifies also to found, to lay a foundation; Syr. to found, also to finish, complete, adorn, from the same root; Ar. *shakala*, to bind or tie, whence Eng. *shackles*; also to be dark, obscure, intricate, difficult, to form, to make like, to be of a beautiful form, to know, to be ignorant, to agree, suit, or become. These verbs appear to be formed on the root כָּל, *hal*, כָּלַל, *halal*, to hold or restrain, which coincides in signification with the Ch. and Eth. כָּלַל, *hehal*, to be able, L. *calleo*, that is, to strain, stretch, reach, and with כָּלַל, *halal*, to perfect, that is, to make sound, or to reach the utmost limit. The sense of folly, error, sin, perverseness, is from wandering, deviation, Gr. *σχιζος*: the sense of *skill* and understanding is from separation, discernment, or from taking, holding, or reaching to, for strength and knowledge are allied, and often from tension. The sense of ignorance and error is from wandering or deviation, or perhaps it proceeds from a negative sense given to the primary verb by the prefix, like *ex* in Latin, and *s* in Italian. The Arabic sense of binding and shackles is from straining. The Eng. *shall* and *should* belong to this family.]

1. The familiar knowledge of any art or science, united with readiness and dexterity in execution or performance, or in the application of the art or science to practical purposes. Thus we speak of the *skill* of a mathematician, of a surveyor, of a physician or surgeon, of a mechanic or seaman. So we speak of *skill* in management or negotiation.—2.† Any particular art.

**SKILL,**† *v. t.* To know; to understand.

**SKILL,**† *v. i.* To be knowing in; to be dextrous in performance.—2.† To differ; to make difference; to matter or be of interest. [This is the Teutonic and Gothic sense of the word.]

**SKILLED,** *a.* Having familiar knowledge united with readiness and dexterity in the application of it; familiarly acquainted with; followed by *in*; as, a professor *skilled* in logic or geometry; one *skilled* in the art of engraving.

**SKILLESS,** *a.* Wanting skill; artless.

**SKILLET,** *n.* [Qu. Fr. *ecuelle*, *ecuelle*.] A small vessel of iron, copper, or other metal, with a long handle; used for heating and boiling water and other culinary purposes.

**SKILT;**† *n.* [See **SKILL.**] Difference.

**SKIM,** *n.* [A different orthography of *Scum*; Fr. *écume*; G. *schaum*; Ir. *sgéimh*, to skim.] Scum; the thick matter that forms on the surface of a liquor. [Little used.]

**SKIM,** *v. t.* To take off the thick gross matter which separates from any liquid substance and collects on the surface; as, to *skim* milk by taking off the cream.—2. To take off by skimming; as, to *skim* cream.—3. To pass near the surface; to brush the surface slightly.

The swallow *skins* the river's wat'ry face.

Dryden.

**SKIM,** *v. i.* To pass lightly; to glide along in an even smooth course, or without flapping; as, an eagle or hawk *skims* along the ethereal regions.—2. To glide along near the surface; to pass lightly.—3. To hasten over superficially or with slight attention.

They *skim* over a science in a superficial survey.

Watts.

**SKIMBLE-SCAMBLE,** *a.* [A duplication of *scamble*.] Wandering; disorderly. [A trivial word.]

**SKIM'-COULTER,** *n.* A coulter for paring off the surface of land.

**SKIM'INGTON,** } A vulgar word from  
**SKIM'ITRY,** } the Dan. *skient*, a jest or sport; *skiemter*, to jest, joke, sport: used in the phrase, to *ride skim-ington* or *skimetry*.

**SKIMMED,** *pp.* Taken from the surface; having the thick matter taken from the surface; brushed along.

**SKIM'MER,** *n.* An utensil in the form of a scoop; used for skimming liquors.—2. One that skims over a subject.

[Little used.]—3. The *Rynchops* or *Rhynchops* of Linn., a genus of aquatic palmipede birds, so called because they skim over the surface of the water. These birds resemble the terns in their small feet, long wings, and forked tail; but are distinguished from all birds by their extraordinary bill, the upper mandible of which is shorter than the under, both being flattened so as to form simple blades, which meet without clasping. Their only mode of feeding is by skimming their aliment from the surface of the water with the lower mandible, which they effect while on the wing. Only one species is known, *R. nigra*, or

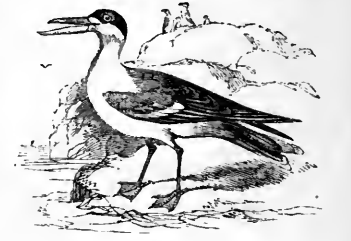

Skimmer (*Rynchops nigra*).

black skimmer, called also cutwater and shearwater. It is found in the tropical and temperate parts of America. It is scarcely so large as a pigeon.

**SKIM'-MILK,** } *n.* Milk from  
**SKIM'-MED-MILK,** } which the cream has been taken.

**SKIMMING,** *ppr.* Taking from the surface, as cream from milk.—2. Gliding lightly along near the surface.

**SKIMMINGS**, *n. plur.* Matter skimmed from the surface of liquors.

**SKIN**, *n.* [Sax. *scin*; Sw. *skinn*; Dan. *skind*, a skin; G. *schinden*, to flay; Ir. *scann*, a membrane; W. *ysgin*, a robe made of skin, a pelisse, said to be from *cin*, a spread or covering. But in Welsh, *cen* is skin, peel, or rind. This may signify a covering, or a peel, from stripping.] 1. The natural covering of animal bodies. It consists of three layers; 1st. the *epidermis*, or scarf-skin, or cuticle, an albuminous membrane; 2d. the *rete mucosum* (mucous network), a thin layer of soft or pulpy matter, which performs the secretions, and is the seat of colour; 3d. the *cutis vera*, or true skin, a gelatinous texture of which leather is made, and which, when boiled in water, is converted into glue. The skin, besides its use as a covering, performs the functions of perspiration and absorption. The epidermis protects the terminations of the nerves, whose sensibilities would otherwise soon become blunted.—2. A hide; a pelt; the skin of an animal separated from the body, whether green, dry, or tanned. In *commercial lan.*, the term is applied to the skins of those animals, as calves, deer, goats, lambs, &c., which, when prepared, are used in the lighter works of bookbinding, the manufacture of gloves, parchment, &c.; while the term hides is applied to the skins of the ox, horse, &c., which, when tanned, are used in the manufacture of shoes, harness, and other heavy and strong articles.—3. The body; the person; in *ludicrous language*.—4. The bark or husk of a plant; the exterior coat of fruits and plants.

**SKIN**, *v. t.* To strip off the skin or hide; to flay; to peel.—2. To cover with skin.—3. To cover superficially.—*To skin up a sail in the bunt*, in *nautical lan.*, to make that part of the canvas which covers the sail when furled, smooth and neat, by turning the sail well up on the yards.

**SKIN**, *v. i.* To be covered with skin; as, a wound *skins* over.

**SKIN'DEEP**, *a.* Superficial; not deep; slight.

**SKIN'FLINT**, *n.* [*skin* and *flint*.] A very niggardly person.

**SKINK**, *n.* [Sax. *scenc*.] 1. † Drink; pottage. In *Scotland*, a kind of soup made with the knees and sinews of beef, cut in small pieces, and long boiled.—2. [L. *scincus*.] A small lizard of Egypt; also, the common name of

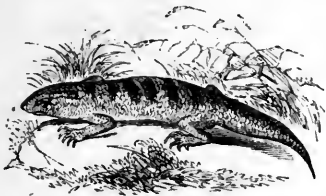

Skink (*Scincus officinalis*).

a genus of lizards, with a long body entirely covered with rounded imbricate scales, all natives of warm climates.

**SKINK**, † *v. i.* [Sax. *scencan*; G. and D. *schinken*; Ice. *shenka*, to bestow, to make a present.] To serve drink.

**SKINK'ER**, † *n.* One that serves liquors.

**SKIN'LESS**, *a.* [from *shin*.] Having

no skin, or having a thin skin; as, *skinless* fruit.

**SKIN'NED**, *pp.* Stripped of the skin; flayed.—2. Covered with skin.

**SKIN'NER**, *n.* One that skins.—2. One that deals in skins, pelts, or hides.

**SKIN'INESS**, *n.* The quality of being skinny.

**SKIN'NING**, *ppr.* Stripping of the skin; flaying.

**SKIN'NY**, *a.* Consisting of skin, or of skin only; wanting flesh.

**SKIP**, *v. i.* [Dan. *kipper*, to leap; Ice. *skopa*.] To leap; to bound; to spring; as a goat or lamb.

The lamb thy riot dooms to bleed to-day,  
Had he thy reason, would he skip and play?  
Pope.

*To skip over*, to pass without notice; to omit.

**SKIP**, *v. t.* To pass over or by; to omit; to miss.

They who have a mind to see the issue,  
may skip these two chapters. Burnett.

**SKIP**, *n.* A leap; a bound; a spring.—2. In *music*, a passage from one sound to another by more than a degree at one time.

**SKIP'JACK**, *n.* An upstart.

**SKIP'KENNEL**, *n.* A lackey; a foot-boy.

**SKIP'PER**, *n.* [Dan. *shipper*; D. *schipper*. See SHIP.] 1. The master of a small trading or merchant vessel; a sea captain.—2. [from *skip*.] A dancer.—3. A youngling; a young thoughtless person.—4. A name given to the saury pike, *Scombrox saurus*.—5. The cheese maggot.

**SKIP'PET**, † *n.* [See SHIP and SKIFF.] A small boat.—2. In *antiqu.*, a small cylindrical turned box for keeping records.

**SKIP'PING**, *ppr.* Leaping; bounding.—*Shipping notes*, in *music*, are notes that are not in regular course, but separate.—In *her.*, the crocodile, salamander, camelion, newt, asker, spider, ant, and all other oviparous animals are said to be *erected*, *mounting*, *leaping*, or *shipping*.

**SKIP'PINGLY**, *adv.* by leaps.

**SKIP'PING-ROPE**, *n.* A short cord, with a handle at each end, used for exercise by short leaps above the rope.

**SKIPS**, *n.* [See SKEP.] The boxes used in shaft-sinking for raising the excavated material to the surface.

**SKIRL**, *v. i.* [Suiso-Goth. *shoerl*.] To shriek; to cry with a shrill voice. [Scotch.]

**SKIRMISH**, *n.* (skur' mish.) [Fr. *escarmouche*; G. *scharmützel*; W. *ysgarm*, outcry; *ysgarmu*, to shout; *ysgarmes*, a shouting, a skirmish; from *garm*, a shout. The primary sense is to throw or drive. In some of the languages, *skirmish* appears to be connected with a word signifying *defence*; but defence is from driving, repelling.] 1. A slight fight in war; a light combat by armies at a great distance from each other, or between detachments and small parties.—2. A contest; a contention.

They never meet but there's a *skirmish* of wit. Shak.

**SKIRM'ISH**, *v. i.* To fight slightly or in small parties.

**SKIRM'ISHER**, *n.* One that skirmishes.

**SKIRM'ISHING**, *ppr.* Fighting slightly or in detached parties.

**SKIRM'ISHING**, *n.* The act of fighting in a loose or slight encounter.

**SKIR'V**, † *v. t.* To scour; to ramble over in order to clear.

**SKIR'V**, † *v. i.* To scour; to scud; to run hastily.

**SKIR'RET**, *n.* A plant, the *Stium Sisarum*, a native of China, Cochinchina, Corea, Japan, &c. It has been cultivated in Europe, time immemorial, for the sake of its esculent tuberous root, which somewhat resembles the parsnep



Skirret (*Stium sisarum*).

in flavour. It is eaten boiled, with butter, pepper, &c., or half boiled and subsequently fried. It was formerly much esteemed as a culinary vegetable, but is now gone greatly into disuse. In the north of Scotland, where it is still used, it is called *crummock*.

**SKIRT**, *n.* (skurt.) [Sw. *skjorta*, a shift or close garment; Dan. *skjorte*, a petticoat; *skjorte*, a shirt, a shift. These words seem to be from the root of *short*, from cutting off.] 1. The lower and loose part of a coat or other garment; the part below the waist; as, the *skirt* of a coat or mantle; 1 Sam. xv.—2. The edge of any part of dress.—3. Border; edge; margin; extreme part; as, the *skirt* of a forest; the *skirt* of a town.—4. A woman's garment like a petticoat.—5. The diaphragm or midriff in animals.—*To spread the skirt over*, in *scrip.*, to take under one's care and protection; Ruth, iii.

**SKIRT**, *v. t.* To border; to form the border or edge; or to run along the edge; as, a plain *skirted* by rows of trees; a circuit *skirted* round with wood.

**SKIRT**, *v. i.* To be on the border; to live near the extremity.

Savages... who *skirt* along our western frontiers. S. S. Smith.

**SKIRT'ED**, *pp.* Bordered.

**SKIRT'ING**, *ppr.* Bordering; forming a border.

**SKIRT'ING**, or **SKIRT'ING BOARD**, *n.* In *arch.*, the narrow vertical board placed round the margin of a floor. Where there is a dado this board forms a plinth for its base; otherwise, it is a plinth for the room itself.

**SKIRTS**, *n.* In *arch.*, several superficies in a plane which would cover a body without one part lapping over the other.

**SKIT**, † *n.* A wanton girl; a reflection; a jeer or jibe; a whim.

**SKIT'TISH**, *a.* 1. Shy; easily frightened; shunning familiarity; timorous; as, a restive *skittish* jade.—2. Wanton; volatile; hasty.—3. Changeable; fickle; as, *skittish* fortune.

**SKIT'TISHLY**, *adv.* Shyly; wantonly; changeably.

**SKIT'TISHNESS**, *n.* Shyness; aptness

to fear approach; timidity.—2. Fickleness; wantonness.

SKIT-TLES, *n.* Nine pins.

SKI-VER, *n.* [*G. schiefern*, to shiver, to scale; *D. schuf*, a slice; *Dan. shive*, a slice, *shifer*, *shiver*, a slate.] A split skin; sheepskin, used in binding books.

SKOLÉZITE, } *n.* A mineral allied  
SCOLÉCITE, } to Thomsonite, occurring crystallized and massive, colourless and nearly transparent. When a small portion of it is placed in the exterior flame of the blowpipe, it twists like a worm, [*σκαλιζέ*], becomes opaque, and is converted into a blebby colourless glass.

SKONCE. See SCONCE.

SKORODITE, } *n.* [*Gr. σκοροδον*, garlic;  
SCORODITE, } from its smell under the blowpipe.] Cupreous arseniate of iron; a mineral of a greenish colour of different shades, or brown and nearly black, resembling the martial arseniate of copper. It occurs massive, but generally crystallized in rectangular prisms. It is found in Cornwall, Saxony, near Huttenburg in Carinthia, Brazil, &c.

SKOR'ZITE, *n.* A mineralogical synonym of a variety of epidote, from Skorza.

SKREEN. See SCREEN.

SKÖE. See SKEW.

SKUG, } [*Suijo-Goth. skugga*, a  
SCOUG, } shade.] A shade; that which defends from the heat; a shelter.

As a verb trans., to shade; to shelter; to screen. As a verb intrans., to flee for shelter; to hide one's self. [*Scotch.*]

SKULK, *v. i.* To lurk; to withdraw into a corner or into a close place for concealment. [*See SCULK.*]

SKULK, } *n.* A person who skulks,  
SKULK'ER, } or avoids performing duties.

SKULK'ED, *pp.* Lurked; concealed.

SKULK'ING, *ppr.* Lurking; withdrawing into a close place for concealment.

SKULK'INGLY, *adv.* In a skulking manner.

SKULL, *n.* [*Sw. skalle*, skull; *skäl*, a shell; *Dan. skul*, a shell, the skull, and *skoll*, the skull; *G. hirsenschale*, brain-shell. See SHELL.] 1. The bone that forms the exterior of the head, and incloses the brain. It forms the forehead, and every part of the head except the face. It consists of eight bones; namely, the frontal and occipital bones upon its fore and back part; the two temporal and parietal bones, forming the temples and the sides of the skull; and the sphenoid and ethmoid bones concerned in the formation of the orbits and nose.—2. A person.

*Skulls* that cannot teach and will not learn.

*Cowper.*

3. † Skull, for *shoal* or *school*, of fish.

SKULL'-CAP, *n.* Sometimes also called *Brain-cap*. In *military antiquities*, an



Skull Caps.

iron defence for the head, sewed inside of the cap.—2. The common name of two British species of plants, of the genus *Scutellaria*. [*See SCUTELLARIA.*]

SKUNK, *n.* A digitigrade carnivorous mammal, the *Mephitis Americana*, found over a very wide extent of country,

both in North and South America. It is nearly allied to the weasel, on the one hand, and to the otter on the other.



Skunk (*Mephitis Americana*).

This animal has two glands, near the inferior extremity of the alimentary canal, which secrete an extremely fetid liquor, and which the animal has the power of emitting at pleasure as a means of defence. This liquor possesses valuable medicinal powers, but its extreme offensiveness interferes with its use.

SKUNK'CABBAGE, } *n.* A plant of the  
SKUNK'WEED, } genus *Symplocarpus*, the *S. fetida*, so named from its smell. The root and seeds are powerful antispasmodics; they are also expectorants, and useful in phthisical coughs. They have considerable reputation in North America as palliatives in paroxysms of asthma.

SKUR'RY, *n.* Haste; impetuosity. [*Disused*, except as a component part of the familiar term *hurry-skurry*.]

SKUTE, *n.* A boat. [*See SCOW.*]

SKY, *n.* [*Sw. sky*, *Dan. skye*, a cloud; *Dan. sky himmel*, the vault of heaven.] 1. The aerial region which surrounds the earth; the apparent arch or vault of heaven, which in a clear day is of a blue colour.—2. The heavens.—3. The weather; the climate.—4. † A cloud; a shadow.

SKY-BLUE, *a.* Of the blue colour of the sky.

SKY-BORN, *a.* Born or produced in the sky.

SKY-BUILT, *a.* Built in the sky.

SKY-COLOUR, *n.* The colour of the sky; a particular species of blue colour; azure.

SKY-COLOURED, *a.* Like the sky in colour; blue; azure.

SKY-DRAIN, *n.* A cavity formed round the walls of a building, to prevent the earth from lying against them and causing dampness.

SKY-DYED, *a.* Coloured like the sky.

SKY'ED, *a.* Enveloped by the skies.

SKY'EY, *a.* Like the sky; ethereal.

SKY-HIGH, *adv.* High as the sky; very high; much elevated or excited.

SKY'ISH, *a.* Like the sky, or approaching the sky.

The *skyish* head

Of blue Olympus. [*A bad word.*] *Shuk. SKY-LÄRK, n.* A lark that mounts and sings as it flies. *Alauda arvensis.*

SKY-LÄRKING, *n.* A term used by seamen to denote wanton play about the rigging or tops, or in any part of the ship, which is frequently productive of mischief and serious accidents.

SKY-LIGHT, *n.* A window placed in the top of a house, or a frame consisting of one or more inclined planes of glass placed in a roof to light passages or rooms below.

SKY'-POINTING, *a.* Pointing to the sky.

SKY'-ROCKET, *n.* A rocket that ascends high and burns as it flies; a species of firework.

SKY'-ROOFED, *a.* Having the sky for a roof.

SKY'-SAIL, } *n.* A small triangu-  
SKY'-SCRAPER, } lar sail sometimes set above the royal.

SKYWARD, *a.* Toward the sky.

SLAB, † *a.* Thick; viscous.

SLAB, *n.* [*W. llab, yslab*, a thin strip.] 1. A plane or table of stone; as, a marble slab.—2. An outside piece taken from timber in sawing it into boards, planks, &c.—3. A puddle. [*See SLOP.*]

*Slabs of tin*, the lesser masses which the workers cast the metal into. These are run into moulds of stone.

SLABBER, *v. t.* [*D. slabben*; *G. schlaben, schlabern*.] To let the saliva or other liquid fall from the mouth carelessly; to drivel. It is also written *slaver*.

SLABBER, † *v. t.* To sup up hastily, as liquid food.—2. To wet and foul by liquids suffered to fall carelessly from the mouth.—3. To shed; to spill.

SLABBERER, *n.* One that slabbers; an idiot.

SLABBERING, *ppr.* Drivelling.

SLABBY, *a.* Thick; viscous. [*Not much used.*—2. Wet. [*See SLOPPY.*]

SLAB'-LINE, *n.* A line or small rope by which seamen truss up the main-sail or fore-sail.

SLACK, *a.* [*Sax. slac*; *Sw. slak*; *W. llac, yslac*. See the VERB.] 1. Not tense; not hard drawn; not firmly extended; loose; relaxed; as, a *slack* rope; *slack* rigging.—2. Weak; remiss; not holding fast; as, a *slack* hand.—3. Remiss; backward; not using due diligence; not earnest or eager; not fully employed by business; as, *slack* in duty or service; *slack* in business.—4. Not violent; not rapid; slow; as, a *slack* pace.—*Slack in stays*, in seamen's language, slow in going about; as a ship.

SLACK WATER, *n.* In seamen's language, the time when the tide runs slowly, or the water is at rest; or the interval between the flux and reflux of the tide.

SLACK, *adv.* Partially; insufficiently; not intensely; as, *slack* dried hops; bread *slack* baked.

SLACK, *n.* The part of a rope that hangs loose, having no stress upon it.

SLACK, } *v. i.* [*Sax. slacian*; *D. slacken*, } *slachen*; *W. yslacáu* and *yslaciaw*, to slacken, to loosen, from *llac, llag*, slack, loose, lax, *sluggish*.]

1. To become less tense, firm or rigid; to decrease in tension; as, a wet cord *slackens* in dry weather.—2. To be remiss or backward; to neglect; *Deut. xxiii.*—3. To lose cohesion or the quality of adhesion; as, lime *slackens* and crumbles into powder.—4. To abate; to become less violent.

Whence these raging fires  
Will *slacken*, if his breath stir not their flames.

5. To lose rapidity; to become more slow; as, a current of water *slackens*; the tide *slackens*.—6. To languish; to fail; to flag.

SLACK, } *v. t.* To lessen tension; to  
SLACK'EN, } make less tense or tight; as, to *slacken* a rope or a bandage.—2. To relax; to remit; as, to *slacken* exertion or labour.—3. To mitigate; to diminish in severity; as, to *slacken* pain.

—4. To become more slow; to lessen rapidity; as, to *slacken* one's pace.—5. To abate; to lower; as, to *slacken* the heat of a fire.—6. To relieve; to unbend; to remit; as, to *slacken* cares.—7. To withhold; to use less liberally.—8. To deprive of cohesion; as, to *slack* lime. [See SLAKE.]—9. To repress; to check.

I should be griev'd, young prince, to think my presence  
Unbent your thoughts and *slacken'd* 'em to arms. Addison.

10. To neglect.

*Slack* not the good presage. Dryden.

11. To repress, or make less quick or active.

SLACK, *n.* Small coal; coal broken into small pieces.

SLACK, *n.* A valley or small shallow dell. [Local.]

SLACK'ED, *pp.* or *a.* Relaxed; deprived of cohesion; as, a *slack*ed rope, *slack*ed lime. [In the latter case *slack*ed is the more correct epithet.]

SLACK'EN, *n.* Among *miners*, a spongy semi-vitrified substance which they mix with the ores of metals, to prevent their fusion. [See SLAKIN.]

SLACK'ENED, *pp.* or *a.* Relaxed or remitted.

SLACK'ENING, *pp.* Relaxing or remitting.

SLACK'-JAW, *n.* Impertinent language. [Vulgar.]

SLACK'LY, *adv.* Not tightly; loosely.—2. Negligently; remissly.

SLACK'NESS, *n.* Looseness; the state opposite to tension; not tightness or rigidity; as, the *slackness* of a cord or rope.—2. Remissness; negligence; inattention; as, the *slackness* of men in business or duty; *slackness* in the performance of engagements.—3. Slowness; tardiness; want of tendency; as, the *slackness* of flesh to heal.—4. Weakness; not intensesness.

SLADE, *n.* [Sax. *slæd.*] A little dell or valley; also, a flat piece of low, moist ground. [Local.]

SLAG, *n.* [Dan. *slagg*; G. *schlacke.*] The imperfect glossy or vitrifiable compounds which are produced during the reduction of metallic ores by various fluxes. In the ironworks it is sometimes called *cinder*.

SLAG'GY, *a.* Pertaining to or resembling slag.

SLÅIE, *n.* (sla.) [Sax. *slæ.*] A weaver's reed. It is also written *slay*.

SLAIN, *pp.* of *Slay*; so written for *slayen*. Killed.

SLAKE, *v. t.* [Sw. *slåcha*, Ice. *slæcha*, to quench. It is allied to *lay*.] To quench; to extinguish; as, to *slake* thirst.

And *slake* the heav'nly fire. Spenser.

SLAKE, *v. t.* (slak.) To mix with water so that a true chemical combination shall take place, or to powder; as to *slake* lime. *Slack*ed lime is quicklime reduced to a state of powder by the action of water upon it, or the hydrate of lime. In this state the lime is combined with about one-third of its weight of water. During the process of *slaking* lime, a great evolution of heat takes place.

SLAKE, *v. i.* To go out; to become extinct.—2. To grow less tense; to slack or slacken. [A mistake for *Slack*.]

SLAK'ED, *pp.* Quenched; mixed with water so that a combination takes place.

SLAK'IN, *n.* A term used by smelters to express a spongy, semi-vitrified sub-

stance, which they mix with the ores of metal to prevent their fusion. It is the scoria or scum, separated from the surface of a former fusion of metals.

SLAK'ING, *pp.* Extinguishing, as, thirst.—2. Mixing with water so as to produce combination, as with lime.

SLAM, *v. t.* [Ice. *lema*, to strike, Old Eng. *lam*; Sax. *hlemman*, to sound.]

1. To strike with force and noise; to shut with violence; as, to *slam* a door.—2. To beat; to cuff. [Local.]—3. To strike down; to slaughter. [Local.]—4. To win all the tricks in a hand; as we say, to take all at a stroke or dash.

SLAM, *n.* A violent driving and dashing against; a violent shutting of a door.—2. Defeat at cards, or the winning of all the tricks.—3. The refuse of alum-works; used in Yorkshire as a manure, with sea weed and lime. [Local.]

SLAM'KIN, } *n.* [G. *schlampe*.]

SLAM'MERKIN, } A slut; a slatternly woman. [Not used or local.]

SLAMMING, *pp.* Striking or shutting with violence.

SLÅNDER, *n.* [Norm. *esclaunder*; Fr. *esclandre*; Russ. *klenu*, *klianu*, to slander; Sw. *hlandra*, to accuse or blame.] 1. A false tale or report maliciously uttered, and tending to injure the reputation of another, by lessening him in the esteem of his fellow-men, by exposing him to impeachment and punishment, or by impairing his means of living; defamation, detraction.

*Slander*, that worst of poisons, ever finds An easy entrance to ignoble minds.

Harvey.

2. Disgrace; reproach; disreputation; ill name.

SLÅNDER, *v. t.* To defame; to injure by maliciously uttering a false report respecting one; to tarnish or impair the reputation of one by false tales maliciously told or propagated.

SLÅNDERED, *pp.* Defamed; injured in good name by false and malicious reports.

SLÅNDERER, *n.* A defamer; one who injures another by maliciously reporting something to his prejudice.

SLÅNDERING, *pp.* Defaming.

SLÅNDEROUS, *a.* That utters defamatory words or tales; as, a *slanderous* tongue.—2. Containing slander or defamation; calumnious; as, *slanderous* words, speeches, or reports, false and maliciously uttered.—3. Scandalous; reproachful.

SLÅNDEROUSLY, *adv.* With slander; calumniously; with false and malicious reproach.

SLÅNDEROUSNESS, *n.* The state or quality of being slanderous or defamatory.

SLANG, *old pret.* of *Sling*. We now use *slung*.

SLANG, *n.* Low, vulgar, unmeaning language. The cant language of the vulgar, especially of sharpers, gipsies, and other vagabonds. [Low.]

SLANG'-WHANGER, *n.* A noisy, frothy demagogue; a turbulent partizan. [Familiar, and American.]

SLANK, *n.* A plant, an Alga.

SLÅNT, *a.* [Sw. *slinta*, *slant*, to slip; perhaps allied to W. *ysglent*, a slide.] Sloping; oblique; inclined from a direct line, whether horizontal or perpendicular.

SLÅNT, *v. t.* To turn from a direct line; to give an oblique or sloping direction to.—*Slant* of wind, among seamen, a

transitory breeze, or the period of its duration.

SLÅNT, } *n.* An oblique reflection  
SLÅNT'ING, } or gibe; a sarcastic remark. [In vulgar use.]—2. A copper coin of Sweden, of which 196 pass for one rik-dollar.

SLÅNTING, *pp.* or *a.* Giving or having an oblique direction; inclining from a right line; slant, as, a *slanting* ray of light; a *slanting* direction.

SLÅNTINGLY, *adv.* With a slope or inclination; also, with an oblique hint or remark.

SLÅNTLY, } *adv.* Obliquely; in an  
SLÅNTWISE, } inclined direction.

SLAP, *n.* [G. *schlappe*, a slap; *schlappen*, to lap; W. *yslapiaw*, to slap, from *ylab*, that is, lengthened, from *llab*, a stroke or slap; *llabiaw*, to slap, to strap. L. *alapa* and *schloppus*; Ch. and Syr. *slap*, *szelaph*.] A blow given with the open hand, or with something broad.—2. A gap; a breach in a wall. [Local.]

SLAP, *v. t.* To strike with the open hand, or with something broad.—2. In building, to break out an opening in a solid wall. [Local.]

SLAP, *adv.* With a sudden and violent blow; plumply.

SLAP'DASH, *adv.* [*slap* and *dash*.] All at once. [Low.]

SLAP'DASH, *n.* A provincial term more commonly called by builders *rough-casting*. It is a composition of lime and coarse sand, reduced to a liquid form, and applied to the exterior of walls as a preservative.

SLAPE, *a.* Slippery; smooth. [Local.]

SLAP'JACK, *n.* A sort of pan-cake.

SLAP'PER, } *a.* Very large. [Vulgar.]

SLAP'PING, } *a.* Very large. [Vulgar.]

SLASH, *v. t.* [Ice. *slasa*, to strike, to *lash*; W. *lâth*, Qu.] 1. To cut by striking violently and at random; to cut in long cuts.—2. To lash.

SLASH, *v. i.* To strike violently and at random with a sword, hanger, or other edged instrument; to lay about one with blows.

Hewing and *slashing* at their idle shades. Spenser.

SLASH, *n.* A long cut; a cut made at random.—2. A large slit in the thighs and arms of old dresses, such as those of Queen Elizabeth's days, made to show a rich coloured lining through such openings or *slashes*.

SLASH'ED, *pp.* or *a.* Cut at random; as cut in long strips or slits.—2. Having artificial gaps; as, *slashed* sleeves.

SLASH'ING, *pp.* Striking violently, and cutting at random.

SLATCH, *n.* In *seamen's* lan., the period of a transitory breeze.—2. An interval of fair weather.—3. Slack. [See SLACK.]

SLATE, *n.* [Fr. *eclater*, to split, Sw. *slita*; Ir. *sglata*, a tile.]—1. An argillaceous stone which readily splits into plates; argillite; argillaceous schist. Slate is commonly of a bluish or greenish colour, with a silky lustre. It consists of silex, alumina, oxide of iron, manganese, potash, carbon, and water. It is opaque, may be scratched by the knife, and fuses into a blackish slag. The substances that go under the name of slate, may be distributed into the following species.—*Mica-slate*, occasionally used for covering houses.—*Clay-slate*, the proper roofing slate.—*Whet-slate*, or Turkey hone.—*Polishing-slate*.—*Drawing-slate*, or black chalk.—*Adhesive-slate*.—*Bituminous slate*.—*Slate-clay*.—2. A piece of smooth

argillaceous stone, used for covering buildings. Clay-slates is most commonly used for roofing. It is a simple schistose mass of a bluish gray, or grayish black colour, of various shades. It is extensively distributed in Great Britain. Roofing slates are of various sizes, and are denominated Imperials, Queens, Princesses, Duchesses, Countesses, Ladies, &c.—3. A piece of smooth stone of the above species, used for writing on.—*Slate system*, in *geol.* This group is subdivided into, 1st. the Plynlimmon rocks; 2d. The Bala limestone; 3d. The Snowdon rocks, consisting of fine grained slates of various shades. In the strata of the slate system, are found the most ancient organic remains.

**SLATE**, *v. t.* To cover with slate, or plates of stone; as, to *slate* a roof.

**SLATE**, *v. t.* To set a dog loose at **SLETE**, } any thing. [*Local.*]

**SLATE-AXE**, *n.* A mattock with an ax-end; used in slating.

**SLATED**, *pp. or a.* Covered with slate.

**SLATE-KNIFE**, *n.* An instrument for splitting slates.

**SLATE-PENCIL**, *n.* A pencil-shaped bit of soft slate, used for writing or figuring on framed pieces of slate in schools, &c.

**SLATER**, *n.* One that lays slates, or whose occupation is to slate buildings.

**SLATING**, *ppr.* Covering with slates.

**SLATING**, *n.* The operation of covering roofs with slates.—2. The cover thus put on.

**SLAT'TER**, *v. t.* [*G. schlottern*, to hang loosely; *schlotterig*, negligent. See **SLUR**.] 1. To be careless of dress and dirty.—2. To be careless, negligent, or awkward; to spill carelessly.

**SLAT'TERN**, *n.* A woman who is negligent of her dress, or who suffers her clothes and furniture to be in disorder; one who is not neat and nice.

**SLAT'TERN**, *v. t.* To *slattern away*, to consume carelessly or wastefully; to waste. [*Unusual.*]

**SLAT'TERNLINESS**, *n.* State of being slatternly.

**SLAT'TERNLY**, *adv.* Negligently; awkwardly.

**SLATY**, *a.* [from *slate*.] Resembling slate; having the nature or properties of slate; as, a *slaty* colour or texture; a *slaty* feel.

**SLAUGHTER**, *n.* (slaw'ter.) [*Sax. slage*; *D. slagting*; *G. schlachen*, to kill; *Ir. slaihte*; *slaihim*, to slay. See **SLAY**.] 1. In a general sense, a killing. Applied to men, slaughter usually denotes great destruction of life by violent means; as, the *slaughter* of men in battle.—2. Applied to beasts, butchery; a killing of oxen or other beasts for market.

**SLAUGHTER**, *v. t.* (slaw'ter.) To kill; to slay; to make great destruction of life; as, to *slaughter* men in battle.—2. To butcher; to kill for the market; as, *beasts*.

**SLAUGHTERED**, *pp.* (slaw'tered.) Slain; butchered.

**SLAUGHTERER**, *n.* A person employed in slaughtering; a butcher.

**SLAUGHTER-HOUSE**, *n.* (slaw'ter-house.) A house where beasts are butchered for the market.

**SLAUGHTERING**, *ppr.* (slaw'tering.) Killing; destroying human life; butchering.

**SLAUGHTER-MAN**, *n.* (slaw'ter-man.) One employed in killing.

**SLAUGHTEROUS**, *a.* (slaw'terous.) Destructive; murderous.

**SLAUGHTEROUSLY**, *adv.* Destructively; murderously.

**SLAVE**, *n.* [*D. slaaf*; *G. sclave*; *Dan. slave, sclave*; *Fr. esclave*. Low Lat. *sclavus*, whence the *schiaivo* of the Italians, whose custom it once was to buy Slavonians for serfs. Vossius derives the word from old *G. slaef* or *slave*, now *Sklave*, one of the Slavonic tribes reduced to bondage by Charlemagne.] 1. A person who is wholly subject to the will of another; one who has no will of his own, but whose person and services are wholly under the control of another. In the early state of the world, and to this day, among some barbarous nations, prisoners of war are considered and treated as *slaves*. The *slaves* of modern times are more generally purchased, like horses and oxen.—2. One who has lost the power of resistance; or one who surrenders himself to any power whatever; as, a *slave* to passion, to lust, to ambition.—3. A mean person; one in the lowest state of life.—4. A drudge; one who labours like a slave.

**SLAVE**, *v. i.* To trudge; to toil; to labour as a slave.

**SLAVEBORN**, *a.* Born in slavery.

**SLAVEHOLDER**, *n.* One who owns slaves.

**SLAVEHOLDING**, *a.* Holding persons in slavery.

**SLAVELIKE**, *a.* Like or becoming a slave.

**SLAVER**, *n.* A vessel engaged in the slave-trade.

**SLAVER**, *n.* [the same as *Slabber*.] Saliva drivelling from the mouth; drivel.

**SLAVER**, *v. i.* To suffer the spittle to issue from the mouth.—2. To be smeared with saliva.

**SLAVER**, *v. t.* To smear with saliva issuing from the mouth; to defile with drivel.

**SLAVERED**, *pp.* Defiled with drivel.

**SLAVEREL**, *n.* A driveller; an idiot.

**SLAVERING**, *ppr.* Letting fall saliva.

**SLAVERINGLY**, *adv.* With slaver or drivel.

**SLAVERY**, *n.* [See **SLAVE**.] Bondage; the state of entire subjection of one person to the will of another. *Slavery* is the obligation to labour for the benefit of the master, without the contract or consent of the servant; or it is the establishment of a right which gives one person such a power over another, as to make him absolute master of his life and property. But the condition of a slave is susceptible of innumerable modifications, and there are few nations, whether of ancient or modern times, among whom slavery has been long established, that have not enacted certain laws for limiting the power of a master over his slave. Slavery may proceed from crimes, from captivity, or from debt. Slavery is also *voluntary* or *involuntary*; *voluntary*, when a person sells or yields his own person to the absolute command of another; *involuntary*, when he is placed under the absolute power of another without his own consent. Slavery no longer exists in Great Britain, nor in any of her colonies, nor in the northern states of America.—2. The offices of a slave; drudgery.

**SLAVE-TRADE**, *n.* [*slave* and *trade*.] The barbarous and wicked business of purchasing men and women, transporting them to a distant country, and selling them for slaves. The slave-trade was generally carried on by European nations between the western coasts of Africa and the American settlements. It was abolished as far as Great Britain was concerned in 1808, and the whole of the European nations have now agreed to put a stop to this abominable traffic.

**SLAVISH**, *a.* Pertaining to slaves; servile; mean; base; such as becomes a slave; as, a *slavish* dependence on the great.—2. Servile; laborious; consisting in drudgery; as, a *slavish* life.

**SLAVISHLY**, *adv.* Servilely; meanly; basely.—2. In the manner of a slave or drudge.

**SLAVISHNESS**, *n.* The state or quality of being slavish; servility; meanness.

**SLAVONIC**, *a.* Pertaining to the Slavons, or ancient inhabitants of Russia. [See **SLAVONIAN**.]

**SLAVONIC**, *n.* The Slavonic language.

**SLAY**, *v. t.* pret. *Slew*; pp. *Slain*. [*Sax. slagan, slagan*; *Goth. slahan*; *G. schlagen*; *Dan. slaaer*, to strike, to kill. The proper sense is to *strike*, and as beating was an early mode of killing, this word, like *smite*, came to signify to *kill*. It seems to be formed on the root of *lay*; as we say, to *lay on*.] 1. To kill; to put to death by a weapon or by violence. We say, he *slew* a man with a sword, with a stone, or with a club, or with other arms; but we never say, the sheriff *slays* a malefactor with a halter, or a man is *slain* on the gallows or by poison. So that *slay* retains something of its primitive sense of *striking* or *beating*. It is particularly applied to killing in battle, but is properly applied also to the killing of an individual, man or beast.—2. To destroy.

**SLAYER**, *n.* One that slays; a killer; a murderer; an assassin; a destroyer of life.

**SLAYING**, *ppr.* Killing; destroying life.

**SLEAVE**, *n.* [*Ice. stefu*.] The knotted or entangled part of silk or thread; silk or thread untwisted.

**SLEAVE**, *v. t.* To separate threads; or to divide a collection of threads; to *slae*; a word used by weavers.

**SLEAVED**, *a.* Raw; not spun or wrought.

**SLEAVING**, *ppr.* Separating threads.

**SLEA'ZINESS**, *n.* The state or quality of being sleazy.

**SLEAZY**, *a.* [Probably from the root of *loose*; *Sax. lysan, alysan*, to loose.] Thin; flimsy; wanting firmness of texture or substance; as, *sleazy* silk or muslin.

**SLED**, *n.* [*D. sleede*; *G. schlitten*; *Sw. slade*; *W. yslod*; probably from *sliding* or *drawing*.] In *America*, a carriage or vehicle moved on runners, much used for conveying heavy weights in winter, as timber, wood, stone, and the like.

**SLED**, *v. t.* In *America*, to convey or transport on a sled; as, to *sled* wood or timber.

**SLED'DED**, *pp.* In *America*, conveyed on a sled.—2. Mounted on a sled.

**SLED'DING**, *ppr.* In *America*, conveying on a sled.

**SLED'DING**, *n.* In *America*, the act of transporting on a sled.

**SLEDGE**, *n.* [*Sax. slecge, stege*; *D. sley*; *Dan. slægge*; *Sw. slägga*; from the root of *slay*, to strike.] 1. A large heavy hammer; used chiefly by ironsmiths; called, also, a *sledge-hammer*.—2. A



vehicle moved on runners or on low wheels, or without wheels, for the conveyance of heavy weights, as huge stones, &c. In *Scotland and America* it is called a *sled*. Sledges, or carriages without wheels, are much used in Russia and the northern countries



Russian Sledge.

of Europe during winter, instead of wheel-carriages.—3. In *husbandry*, a carriage without wheels, but shod with iron, on which ploughs and other implements are drawn from place to place. SLEEK, *a.* [*D. lekken*, to leak, to smooth, or sleek; *geleht*, made smooth; *G. schlicht*; allied to *lick*, or *G. gleich*, even, equal, like. See *LIKE*.] 1. Smooth; having an even, smooth surface; whence glossy; as, *sleek hair*.

So sleek her skin, so faultless was her make. *Dryden*.

2. Not rough or harsh.

Those rugged names to our like smooths grow sleek. *Milton*.

SLEEK, *† n.* That which makes smooth; varnish.

SLEEK, *v. t.* To make even and smooth: as, to sleek the hair.—2. To render smooth, soft, and glossy. Gentle, my lord, sleek o'er your rugged locks. *Shak.*

SLEEK'IT, *a.* [*Suio-Goth. sliha*, to creep, or *sleha*, to lick; *Ger. schleichen* to insinuate one's self.] Parasitical in manner and design; flattering; deceitful.

SLEEKLY, *adv.* Smoothly; nicely.

SLEEKNESS, *n.* Smoothness of surface.

SLEEKSTONE, *n.* A smoothing stone.

SLEEKY, *† a.* Of a sleek or smooth appearance.

SLEEP, *v. i.* pret. and pp. *Slept*. [*Sax. slepan, slapan*; *G. schlafen*. This word seems to be allied to words which signify to rest or to relax; *G. schlaff*.] 1. To take rest by a suspension of the voluntary exercise of the powers of the body and mind. The proper time to sleep is during the darkness of night.—2. To rest; to be unemployed; to be inactive or motionless; as, the sword sleeps in its sheath.—3. To rest; to lie or be still; not to be noticed or agitated. The question sleeps for the present.—4. To live thoughtlessly.

We sleep over our happiness. *Atterbury*.

5. To be dead; to rest in the grave for a time; 1 *Thess. iv.*—6. To be careless, inattentive, or unconcerned; not to be vigilant.

SLEEP, *n.* A natural and healthy, but temporary and periodical suspension of the functions of the hemispheres of the cerebrum, or in other words, of the intellectual powers. Sleep may be

complete or incomplete. That state of an animal in which the voluntary exertion of his mental and corporeal powers is suspended, and he rests unconscious of what passes around him, and not affected by the ordinary impressions of external objects. Sleep is generally attended with a relaxation of the muscles, but the involuntary motions, as respiration and the circulation of the blood, are continued. The mind is often very active in imperfect sleep, but its powers not being under the control of reason, its exercises are very irregular. Sleep is the natural rest or repose intended by the Creator to restore the powers of the body and mind, when exhausted or fatigued. The quantity of sleep required by different individuals is various, from six to nine hours being the average proportion, but persons of very active dispositions and abstemious habits will be satisfied with four or five hours.—2. Slumber; rest; repose.—3. Death; rest in the grave.—*Sleep of plants*, a state of plants at night when their flowers close, the leaves become more erect, and fold themselves together, while vitality seems to retire from the periphery. This is chiefly owing to the withdrawal of the stimulus of light to which they are subjected during the day. With the approach of night, too, an important change takes place in the functions of plants, for instead of exhaling oxygen and absorbing carbon from the atmosphere, as, during the day, their action at night is directly the reverse. There are also plants, which, like certain animals, sleep through the day and are awake at night; and it has been ascertained that the leaves of plants kept constantly in the dark, open and close at regular intervals, as during sleep; so that there must be some cause of the sleep of plants, more intimately connected with their organization, than the mere withdrawal of light.

SLEEP-CHARGED, *a.* Heavy with sleep.

SLEEPER, *n.* A person that sleeps; also, a drone or lazy person.—2. *†* That which lies dormant, as a law not executed.—3. An animal that lies dormant in winter, as the bear, the marmot, &c.—4. In *arch.*, a piece of timber on which are laid the ground joists of a floor, and also the ground joists themselves.—*Sleepers* are also pieces of timber, now rarely used, in foundations crossed by planks, &c., and at right angles to them, where the soil is bad. Formerly the term was used to denote the valley rafters of a roof.—In *railways*, *sleepers* are beams of wood or blocks of stone firmly embedded in the ground to sustain the rails, which are usually fixed to the sleepers by means of cast-iron supports called *chairs*.—In *Suffolk*, the root stocks, when left in the soil, of such trees as are sawed off level with the surface, are called *sleepers*.—5. In *ship-building*, a thick piece of timber placed longitudinally in a ship's hold, opposite the several scarfs of the timbers, for strengthening the bows and stern-frame, particularly in the Greenland ships; or a piece of long compass-timber fayed and bolted diagonally upon the transoms.—6. In *the glass trade*, a large iron bar crossing the smaller ones, hindering the passage of coals, but leaving room for the ashes.—7. A platform.—8. A fish, *Evocetus*.

SLEEPFUL, *a.* Strongly inclined to sleep. [*Little used*.]

SLEEPFULNESS, *n.* Strong inclination to sleep. [*Little used*.]

SLEEPILY, *adv.* Drowsily; with desire to sleep.—2. Dully; in a lazy manner; heavily.—3. Stupidly.

SLEEPINESS, *n.* Drowsiness; inclination to sleep.

SLEEPING, *ppr.* or *a.* Resting; reposing in sleep.—*Sleeping partners*, in *Scots law*, partners of a company not proclaimed or known as such. They are otherwise called *dormant partners*: they differ in no respect from ordinary partners; and are equally liable for the debts of the company.—*Sleeping of process*, in the *judicial procedure of the court of session*, a process in the outer house is said to be asleep, when a year and a day have elapsed without any judicial order or interlocutor having been pronounced therein. [*See WAKENING*.]

SLEEPING, *n.* The state of resting in sleep.—2. The state of being at rest, or not stirred or agitated.—3. *a.* Occupied with sleep; as, *sleeping hours*.

SLEEPING PARTNER. See under SLEEPING.

SLEEPLESS, *a.* Having no sleep; without sleep; wakeful.—2. Having no rest; perpetually agitated; as, *Biscay's sleepless bay*.

SLEEPLESSLY, *adv.* In a sleepless manner.

SLEEPLESSNESS, *n.* Want or destitution of sleep.

SLEEP-WAKER, *n.* One under the influence of magnetic sleep.

SLEEP-WAKING, *n.* The state of one who is mesmerised, or one understood to be at once asleep and awake.

SLEEP-WALKER. See SOMNAMBULIST.

SLEEP-WALKING. See SOMNAMBULISM.

SLEEPY, *a.* Drowsy; inclined to sleep.—2. Not awake.

She wak'd her sleepy crew. *Dryden*.

3. Tending to induce sleep; soporiferous; somniferous; as, a *sleepy drink* or *potion*.—4. Dull; lazy; heavy; sluggish.

SLEEPY-LOOKING, *a.* Appearing to be sleepy.

SLEET, *n.* [*Dan. stud*, loose weather, rain and snow together; *Ice. stetta*.]

1. A fall of hail or snow and rain together, usually in fine particles.—2. In *gunnery*, the part of a mortar passing from the chamber to the trunnions for strengthening that part.

SLEET, *v. i.* To snow or hail with a mixture of rain.

SLEETY, *a.* Bringing sleet.—2. Consisting of sleet.

SLEEVE, *n.* [*Sax. slef, styf*; *W. llawes*; said to be from *llaw*, the hand.] 1. The part of a garment that is fitted to cover the arm; as, the *sleeve* of a coat or gown.—2. The ravelled *sleeve* of care, in *Shakspeare*. [*See SLEAVE*.]—To laugh in the sleeve, to laugh privately or unperceived; that is perhaps, originally, by hiding the face under the sleeve or arm.—To hang on the sleeve, to be or make dependent on others.—To have in one's sleeve, to offer a party's name for a vacant place; as, *Dean Swift*, though himself a tory, yet when he waited on his tory patron, *Harley*, had always some whig in his sleeve. [*This phrase, no doubt, arose from the wide sleeves of other days, sometimes serving as pockets for memorials, &c.*]

**SLEEVE**, *v. t.* To furnish with sleeves; to put in sleeves.

**SLEEVE-BUTTON**, *n.* A button to fasten the sleeve or wristband.

**SLEEVED**, *a.* Having sleeves.

**SLEEVELESS**, *a.* Having no sleeves; as, a *sleeveless* coat.—2. Wanting a cover, pretext, or palliation; unreasonable; as, a *sleeveless* tale of transubstantiation; a *sleeveless* errand. [*Little used.*]

**SLEEVES**, *n.* In *hydrometry*, narrow troughs or channels of water formed by a river winding among sand banks on a flat shore.

**SLEEVEING**, *ppr.* Furnishing with sleeves.

**SLEID**, *v. t.* To prepare for use in the weaver's sley or slaie.

**SLEIDED**, *pp.* Prepared for use in the weaver's slaie.

**SLEIDING**, *ppr.* Preparing for use in the weaver's slaie.

**SLEIGH**, *n.* (sla.) [probably allied to *sleek*.] In *America*, a vehicle moved on runners, and greatly used for transporting persons or goods on snow or ice. In *England* it is written and pronounced *sledge*, and applied to what the Americans call a *sled*.

**SLEIGHING**, *n.* In *America*, the state of the snow which admits of running sleighs.—2. The act of riding in a sleigh.

**SLEIGHT**, *n.* (slite.) [G. *schlich*, trick, cunning; *schlicht*, plain, sleek; Sw. *slög*, dextrous; D. *sluik*, underhand; *sluiken*, to smuggle; Ir. *slighthead*, sly.] 1. An artful trick; sly artifice; a trick or feat so dextrously performed that the manner of performance escapes observation; as, *sleight* of hand.—2. Dextrous practice; dexterity.

**SLEIGHTFUL**, *a.* Artful; cunningly

**SLEIGHTY**, *a.* dextrous.

**SLEIGHTLY**, *adv.* Craftily.

**SLENDER**, *a.* (old D. *slinder*. This word is probably formed on the root of *lean*, Teutonic *klein*.) 1. Thin; small in circumference compared with the length; not thick; as, a *slender* stem or stalk of a plant.—2. Small in the waist; not thick or gross. A *slender* waist is considered as a beauty.—3. Not strong; small; slight.

Mighty hearts are held in *slender* chains. Pope.

4. Weak; feeble; as, *slender* hope; *slender* probabilities; a *slender* constitution.—5. Small; inconsiderable; as, a man of *slender* parts.—6. Small; inadequate; as, *slender* means of support; a *slender* pittance.—7. Not amply supplied.

The good Ostorius often deign'd  
To grace my *slender* table. Philip.

8. Spare; abstemious; as, a *slender* diet.

**SLENDERLY**, *adv.* Without bulk.—2. Slightly; meanly; as, a debt to be *slenderly* regarded.—3. Insufficiently; as, a table *slenderly* supplied.

**SLENDERNESS**, *n.* Thinness; smallness of diameter in proportion to the length; as, the *slenderness* of a hair.—2. Want of bulk or strength; as, the *slenderness* of a cord or chain.—3. Weakness; slightness; as, the *slenderness* of a reason.—4. Weakness; feebleness; as, the *slenderness* of a constitution.—5. Want of plenty; as, the *slenderness* of a supply.—6. Spareness; as, *slenderness* of diet.

**SLEPT**, *pret.* and *pp.* of *Sleep*

**SLEUTH**, *n.* [Qu. from Eng. *slot*, the

track of a deer.] The track of man or beast, as known by the scent.

**SLEUTH-HOUND**, *n.* A blood-hound.

[*Scotch.*]

**SLEW**, *pret.* of *Slay*.

**SLEY**. See **SLAIE**.

**SLICE**, *v. t.* [G. *schleissen*, to slit; Sax. *slitan*.] 1. To cut into thin pieces, or to cut off a thin broad piece.—2. To cut into parts.—3. To cut; to divide.

**SLICE**, *n.* A thin broad piece cut off; as, a *slice* of bacon; a *slice* of cheese; a *slice* of bread.—2. A broad piece; as, a *slice* of plaster.—3. A peel, or fire-shovel.—4. A spatula; an instrument consisting of a broad plate with a handle, used by apothecaries for spreading plasters, &c.—5. In *ship-building*, a tapering piece of plank to be driven between the timbers before planking.

**SLICED**, *pp.* Cut into broad thin pieces.

**SLICH**, or **SLICK**, *n.* The ore of a metal, particularly of gold, when pounded and prepared for working.

**SLICING**, *ppr.* Cutting into broad thin pieces.

**SLICK**, *a.* Sleek. [*Obs.* or *vulgar.*]

**SLICK**, *adv.* Immediately; thoroughly. [*American.*]

**SLICKEN-SIDES**, *n.* A name which workmen give to a variety of galena or sulphuret of lead, in Derbyshire. It occurs lining the walls of very small rents. It has a most remarkable property, that when the rock in which it is contained is struck with a hammer, a crackling noise is heard, which is generally followed by an explosion of the rock in the direction and neighbourhood of the vein.

**SLID**, *pret.* of *Slide*.

**SLID**, *pp.* of *Slide*.

**SLID'DEN**, *pp.* of *Slide*.

**SLID'DER**, *v. i.* [Sax. *sliderian*, *slid-rian*. See **SLIDE**.] To slide with interruption.

**SLID'DER**, *a.* [See **SLIDE**.] Slip-slid'dery, *p.*

**SLIDE**, *v. i.* *pret.* *Slid*; *pp.* *Slid*, *Slidden*. [Sax. *slidan*; probably *glide*, with a different prefix; G. *gleiten*.] 1. To move along the surface of any body by slipping, or without bounding or rolling; to slip; to glide; as, a sledge *slides* on snow or ice; a snow-slip *slides* down the mountain's side.—2. To move along the surface without stepping; as, a man *slides* on ice.—3. To pass inadvertently. Make a door and a bar for thy mouth; beware thou *slide* not by it. Eccles.

4. To pass smoothly along without jerks or agitation; as, a ship or boat *slides* through the water.—5. To pass in silent unobserved progression.

Ages shall *slide* away without perceiving. Dryden.

6. To pass silently and gradually from one state to another; as, to *slide* insensibly into vicious practices, or into the customs of others.—7. To pass without difficulty or obstruction. Parts answering parts shall *slide* into a whole. Pope.

8. To practise sliding or moving on ice. They bathe in summer, and in winter *slide*. Water.

9. To slip; to fall.—10. To pass with an easy, smooth, uninterrupted course or flow.

**SLIDE**, *v. t.* To slip; to pass or put in imperceptibly; as, to *slide* in a word to vary the sense of a question.—2. To thrust along; or to thrust by slipping; as, to *slide* along a piece of timber.

**SLIDE**, *n.* A smooth and easy passage; also, a slider.—2. Flow; even course.

—3. A portion of a frozen footway, or other surface covered with ice, used for exercise in winter, by young persons.—4. The name given to an inclined plane for facilitating the descent of heavy bodies by the force of gravity, as the *slide* of Alpnach in Switzerland.

—5. In *music*, a grace used in the German school, and consisting of two small notes moving by degrees.

**SLIDER**, *n.* One that slides.—2. The part of an instrument or machine that slides.

**SLIDE RAIL**, *n.* A contrivance for connecting a siding or crossway on a railway with the main line. [See **RAILWAY**.]

**SLIDE REST**, *n.* In *mech.*, an appendage to the turning lathe for facilitating and insuring accuracy in the motion of the cutting tool. The slide rest imparts motion to the cutting tool in two directions, the one being parallel and the other at right angles to the axis of the lathe.

**SLIDE VALVE**, *n.* In *mech.*, a contrivance extensively employed in modern practice to supersede the use of cocks in regulating the admission or escape of steam or water. A familiar example of the slide valve is found in the ordinary steam valve of a steam engine. [See **D-VALVE**.]

**SLIDING**, *ppr.* Moving along the surface by slipping; gliding; passing smoothly, easily, or imperceptibly.

**SLIDING**, *n.* Lapse; falling; used in *backsliding*.—2. In *mech.*, the motion of a body along a plane, when the same face, or surface of the moving body keeps in contact with the surface of the plane; and is thus distinguished from *rolling*, in which the several parts of the moving body come successively in contact with the plane on which it rolls.

**SLIDING KEEL**, *n.* A narrow oblong frame or platform let down vertically through the bottom of a small vessel, like the deepening of a keel throughout a portion of her length. Its use is like that of the leeboard, to sustain the vessel against the lateral force of the wind.

**SLIDING-RULE**, *n.* A mathematical instrument or scale, consisting of two parts, one of which slides along the other, and each having certain sets of numbers engraved on it, so arranged that when a given number on the one scale is brought to coincide with a given number on the other, the product or some other function of the two numbers is obtained by inspection. The numbers may be adapted to answer various purposes, but the instrument is chiefly used in gauging and for the mensuration of timber, to determine measure or quantity without compasses, by sliding the parts one by another.

**SLIDING-SCALE**, *n.* In *British legislation*, a device for regulating the prices of grain, by means of a variable tax upon it. The first *sliding scale* act was passed July 15, 1828; the second, April 29, 1842. Both have been abolished.

**SLIGHT**, *a.* [D. *slegt*; G. *schlecht*, plain, simple, mean; D. *slegten*, to level; G. *schlecken*, to lick. It seems that *slight* belongs to the family of *sleeb*, smooth. Qu. Dan. *slæt*, by contraction.] 1. Weak, slim; inconsiderable; small; not forcible; as, a *slight* impulse; a *slight* effort.—2. Not deep; as, a *slight* impression; not strong or firm; not

calculated to endure; as, a *slight* structure.—3. Not violent; as, a *slight* disease, illness, or indisposition.—4. Trifling; of no great importance. *Slight* is the subject, but not so the praise.

Pope.

5. Not strong; not cogent.

Some firmly embrace doctrines upon *slight* grounds.

Locke.

6. Negligent; not vehement; not done with effort.

The shaking of the head is a gesture of *slight* refusal.

Bacon.

7. Not firm or strong; thin; of loose texture; as, *slight* silk.—8. † Foolish; silly; weak in intellect.

**SLIGHT, n.** Neglect; disregard; a moderate degree of contempt manifested negatively by neglect. It expresses less than contempt, disdain, and scorn.—2. Artifice; dexterity. [See **SLIGHTLY**.]

**SLIGHT, v. t.** To neglect; to disregard from the consideration that a thing is of little value and unworthy of notice; as, to *slight* the divine commands, or the offers of mercy.—2. † To overthrow; to demolish. "The rogues *slighted* me into the river," in Shakspeare, is not used. [D. *slegten*.] To *slight over*, to run over in haste; to perform superficially; to treat carelessly; as, to *slight over* a theme.

**SLIGHTED, pp. or a.** Neglected; disregarded; jilted; as, a *slighted* lover.

**SLIGHTEN, † v. t.** To slight or disregard.

**SLIGHTER, n.** One who neglects.

**SLIGHTING, ppr.** Neglecting; disregarding.

**SLIGHTINGLY, adv.** With neglect; without respect.

**SLIGHTLY, adv.** Weakly; superficially; with inconsiderable force or effect; in a small degree; as, a man *slightly* wounded; an audience *slightly* affected with preaching.—2. Negligently; without regard; with moderate contempt.

**SLIGHTNESS, n.** Weakness; want of force or strength; superficialness; as, the *slightness* of a wound or an impression.—2. Negligence; want of attention; want of vehemence.

How does it reproach the *slightness* of our sleepy heartless addresses!

Decay of Piety.

**SLIGHTY, a.** Superficial; slight.—2. Trifling; inconsiderable.

**SLILY, adv.** [from *slily*.] With artful or dextrous secrecy. [Sometimes written *slily*.]

Satan *slily* robs us of our grand treasure.

Decay of Piety.

**SLIM, a.** [Ice.] Slender; of small diameter or thickness in proportion to the height; as, a *slim* person; a *slim* tree.—2. Weak; slight; unsubstantial.—3. Worthless.

**SLIME, n.** [Sax. *slim*; D. *stym*; G. *schlamm*; L. *limus*.] Soft moist earth having an adhesive quality; viscous mud.

They had brick for stone, and *slime* had they for mortar; Gen. xi.

**SLIME-PIT, n.** A pit of slime or adhesive mire.

**SLIMINESS, n.** The quality of slime; viscosity.

**SLIMNESS, n.** State of being slim.

**SLIMY, a.** Abounding with slime; consisting of slime.—2. Overspread with slime; as, a *slimy* eel.—3. Viscous; glutinous; as, a *slimy* soil.

**SLINESS, n.** [from *slily*.] Dextrous artifice to conceal any thing; artful secrecy. [Often written *Sliness*.]

**SLING, n.** [D. *slinger*.] 1. An instrument for throwing stones, consisting

of a strap and two strings which are attached to it. The stone is lodged in the strap, and the ends of the strings being held in the hand, the sling, with the stone in it, is whirled rapidly round in a circle, and the stone is thrown by letting go one of the strings. By means of a sling, a stone or other missile is projected with much greater velocity than could be given to it by the hand without such assistance. The velocity with which the projectile is discharged, is the same as that with which it is whirled round in a circle, having the string for its radius. The sling was a very general instrument of war among the ancients. With a *sling* and a stone David killed Goliath.—2. A throw; a stroke.—3. A kind of hanging bandage put round the neck, in which a wounded limb is sustained.—4. In *nautical affairs*, a rope fitted to encircle a cask,



Sling, used in unloading vessels.

jar, bale, or case, and suspend it whilst hoisting and lowering. *Boat slings*, are strong ropes furnished with hooks and iron thimbles, whereby to hook the tackles, in order to hoist the boats in and out of the ship.—*Slings of a yard*, ropes fixed round the middle of the yard, serving to suspend it for the greater ease of working, or for security in an engagement. This term also applies to the middle or that part of the yard on which the slings are placed.

**SLING, n.** [G. *schlingen*, to swallow.] A drink composed of equal parts of rum or spirit and water sweetened.

**SLING, v. t.** pret. and pp. *Slung*. [Sax. *slingan*; D. *slingeren*; Sw. *slinka*, to dangle; Dan. *slingerer*, to reel. The primary sense seems to be to swing.] 1. To throw with a sling.—2. To throw; to hurl.—3. To hang so as to swing; as, to *sling* a pack.—4. To move or swing by a rope which suspends the thing.—5. In *ships*, to hoist or lower the boats, casks, ordnance, or any other weighty body by means of slings for that purpose. To *sling the yards for action*, to secure them close up by means of iron chains, which are not so liable to be cut through by the enemy's shot as ropes are.

**SLINGER, n.** One who slings or uses the sling.—2. A soldier who used a sling.

**SLING'ING, ppr.** Throwing with a sling; hanging so as to swing; moving by a sling.

**SLINK, v. i.** pret. and pp. *Slunk*. [Sax. *slincan*; G. *schleichen*.] 1. To sneak; to creep away meanly; to steal away.

He would pinch the children in the dark, and then *slink* into a corner. *Arbitrator*.

2. To miscarry, as a beast. [Used in *low style*.]

**SLINK, v. t.** To cast prematurely; to abort or miscarry of; as, the female of a beast. [Used in *low style*.]

**SLINK, a.** Produced prematurely, as the young of a beast. [Used in *low style*.]

**SLIP, v. i.** [Sax. *slepan*; G. *schlüpfen*, *schliefen*; W. *yslib*, smooth, glib, from *lib*; L. *labor*, to slide.] 1. To slide; to glide; to move along the surface of a thing without bounding, rolling, or stepping.—2. To slide; not to tread firmly. Walk carefully, lest your foot should *slip*.—3. To move or fly out of place; usually with *out*; as, a bone may *slip out* of its place.—4. To sneak; to slink; to depart or withdraw secretly; with *away*.

Thus one tradesman *slips away*.

To give his partner fairer play. *Prior*.

5. To err; to fall into error or fault.

One *slippeth* in his speech, but not from his heart. *Ecclesi.*

6. To glide; to pass unexpectedly or imperceptibly.

And thrice the fitting shadow *slipp'd* away. *Dryden*.

7. To enter by oversight. An error may *slip* into a copy, notwithstanding all possible care.—8. To escape insensibly; to be lost.

Use the most proper methods to retain the ideas you have acquired, for the mind is ready to let many of them *slip*. *Watts*.

**SLIP, v. t.** To convey secretly.

He tried to *slip* a powder into her drink.

*Arbitrator*.

2. To omit; to lose by negligence. Let us not *slip* the occasion.

And *slip* no advantage

That may secure you. *B. Jonson*.

3. To part twigs from the branches or stem of a tree.

The branches also may be *slipp'd* and planted. *Mortimer*.

4. To escape from; to leave slyly.

Lucentio *slipp'd* me like his greyhound.

*Shak.*

From is here understood.

5. To let loose; as, to *slip* the hounds.

—6. To throw off; to disengage one's self from; as, a horse *slips* his bridle.

—7. To pass over or omit negligently; as, to *slip* over the main points of a subject.—8. To taffer off; as, to *slip* off a twig.—9. To suffer abortion; to miscarry; as a beast.—To *slip a cable*, to veer out and let go the end.—To *slip on*, to put on in haste or loosely; as, to *slip* on a gown or coat.

**SLIP, n.** A sliding; act of slipping.—

2. An unintentional error or fault.—

3. A twig separated from the main stock; as, the *slip* of a vine.—4. A leash or string by which a dog is held; so called from its being so made as to slip or become loose by relaxation of the hand.—5. An escape; a secret or unexpected desertion.—6. A long narrow piece; as, a *slip* of paper.

Hence,—7. Among *printers and journalists*, a portion of a work or newspaper not yet formed into pages or columns.—In *pottery*, clay diffused in water till of the consistence of cream.—8. † A counterfeit piece of money, being brass covered with silver.—9. Matter found in troughs of grindstones after the grinding of edge-tools. [Local.]—10.

A particular quantity of yarn. [Local.]—

11. In *New York*, an opening between wharves or in a dock.—12. A place having a gradual descent on the bank of a river or harbour, convenient for ship-building; also a contrivance for hauling vessels out of the water for

5 F

repairs, &c. A carriage is constructed with truck wheels, which run upon the iron railways of an inclined plane. The ship is placed on the carriage while in the water, and the carriage, together with the ship, is drawn up the inclined plane by means of wheels and pinions wrought by men.—13. In the *United States*, a long seat or narrow pew in churches.—14. In *geol.*, *slips* are masses of strata separated vertically or aslant.—*Slip*, in *Scots law*. In the contract of insurance the policy is preceded by a note of the contract, made out for the purpose of asking the consent of underwriters to the proposed policy. This is called a *slip*. It is merely a jotting or short memorandum of the terms, to which the underwriters subscribe their initials, with the sums for which they are willing to engage. It has no force as a contract of insurance.—*Slip-cheese*, a soft rich cheese made from new milk hot from the cow, and the afterings. *Land-slip*. [See under LAND.]

SLIP-BOARD, *n.* A board sliding in grooves.

SLIP-KNOT, *n.* A bow-knot; a knot which will not bear a strain, but slips along the rope or line around which it is made.

SLIP-PED, *pp.* of *Slip*.

SLIP-PED, In *her.*, an epithet for a flower or branch plucked from the stalk.

SLIPPER, *n.* [Sax.] A kind of shoe consisting of a sole and vamp without quarters, which may be slipped on with ease and worn in undress; a slipshoe.—2. In *colloq. lan.*, a kind of apron for children, to be slipped over their other clothes to keep them clean, called also a slip.—3. A plant. [*L. crepis*.]

SLIPPER, † *a.* [Sax. *slipur*.] Slippery.

SLIPPER-BATH, *n.* A bathing-box, made usually of tinned iron, or zinc plates, shaped like a high shoe, to enable the bather to take a half horizontal, half-vertical position.

SLIPPERED, *a.* Wearing slippers.

SLIPPERILY, *adv.* [from *slippery*.] In a slippery manner.

SLIPPERINESS, *n.* The state or quality of being slippery; lubricity; smoothness; glibness; as, the *slipperiness* of ice or snow; the *slipperiness* of the tongue.—2. Uncertainty; want of firm footing.—3. Lubricity of character.

SLIPPER WORT, *n.* Calceolaria, a genus of plants. [See CALCEOLARIA.]

SLIPPERY, *a.* Smooth; glib; having the quality opposite to adhesiveness; as, oily substances render things *slippery*.—2. Not affording firm footing or confidence; as, a *slippery* promise.

The *slippery* tops of human state.

Cowley.

3. Not easily held; liable or apt to slip away.

The *slippery* god will try to loose his hold.

Dryden.

4. Not standing firm; as, *slippery* standers.—5. Unstable; changeable; mutable; uncertain; as, the *slippery* state of kings.—6. Not certain in its effect; as, a *slippery* trick.—7. Lubricous; wanton; unchaste.

SLIPPY, *a.* Slippery. [Not in use, except in Scotland. Sax. *slipig*.]

SLIP-ROPE, *n.* In ships, a rope used to trice the bight of the cable into the head; and also employed in casting off a vessel, till she is got in a tide-way, &c.

SLIPSHOD, *a.* [*slip* and *shod*.] Wear-

ing shoes like slippers, without pulling up the quarters.

SLIP-SHOE, *n.* A slipper.

SLIP-SLOP, *n.* Bad liquor.—2. Feeble composition.

SLIP-STRING, *n.* [*slip* and *string*.] One that has shaken off restraint; a prodigal; called also *sliphthrift*. [*Lit. us.*]

SLISH, *n.* A cross-cut. [This word, used trivially as a component of *stish slash*, by Shakspeare, is now obsolete.]

SLIT, *v. t.* pret. *Slit*; pp. *Slit* or *Slitted*. [Sax. *slitan*; G. *schleissen*; D. *sluten*; Dan. *slider*. The two latter signify to wear out or waste. The German has the signification of splitting and of wearing out.]

1. To cut lengthwise; to cut into long pieces or strips; as, to *slit* iron bars into nail rods.—2. To cut or make a long fissure; as, to *slit* the ear or tongue, or the nose. [The latter barbarous practice was not uncommon in England. In consequence of a flagrant instance of it, the stat. 22, c. 2, called "the Coventry act," was passed in 1670, and remained unrepealed till 1828-9.]—3. To cut in general.—4. To rend; to split.

SLIT, *n.* A long cut; or a narrow opening; as, a *slit* in the ear.—2. A cleft or crack in the breast of cattle.

SLIT DEAL, *n.* Fir boards a full half inch thick.

SLITH'ER, *v. i.* To slide. [*Local*.]

SLITH'ERY, *a.* Slippery. [*Local*.]

SLIT PLANTING, *n.* A method of planting, which is performed by making slits in the soil with a spade, so as to cross each other, and inserting the plant at the point where the slits cross.

SLITTER, *n.* One that slits.

SLITTING, *ppr.* Cutting lengthwise.

SLITTING-MILL, *n.* A mill where iron bars are slit into nail rods, &c.

SLIVE, *v. i.* To sneak. [*Local*.]

SLIVE, † *v. t.* [See SLIVER.] To cleave; to split; to divide.

SLIVER, *v. t.* [Sax. *stifan*; W. *ysleiviaw*, from *yslaiv*, a slash or slice, from *glaiw*, a sword or scimitar; *l্লাiv*, shears or a shave; but all probably from the sense of cutting or separating.] To cut or divide into long thin pieces, or into very small pieces; to cut or rend lengthwise; as, to *sliver* wood.

SLIVER, *n.* A long piece cut or rent off, or a piece cut or rent lengthwise.

SLIVERED, *pp.* Divided into long thin pieces; cut or rent lengthwise.

SLIVERING, *ppr.* Cutting or rending lengthwise into long thin pieces, or very small pieces.

SLOAM, *n.* In *mining*, layers of earth or clay between those of coal. [*A worker's term*.]

SLOAT, *n.* [from the root of Dan. *slutter*, to fasten, D. *sluiten*, Sw. *sluta*, G. *schliessen*; from the root of *L. claudo*.] A narrow piece of timber which holds together larger pieces; as, the *sloats* of a cart.

SLOBBER, and its derivatives, are a different orthography of *Slabber*, the original pronunciation of which was probably *slobber*. [See SLABBER and SLAVER.] To *slobber over work*, is to do it in a slovenly or half-finished manner. [*Familiär*.]

SLOCK, *v. t.* To quench, is a different orthography of *Slake*, but not used. *Stoeken* or *Stoken*, to quench, as fire; to allay, as thirst, is *Scotch*.

SLOE, *n.* [Sax. *slag*, *sla*; G. *schlehe*; D. *slee*, in *sleepruim*, and *slee* signifies sour; *slee-boom*, the sloe-tree; Dan. *slaae*, *slaaen*, or *slaaen-torne*.] A

British species of plant of the genus *Prunus*, the *P. spinosa*, called also



Sloe (*Prunus spinosa*).

blackthorn. It is a low shrubby tree, with irregularly spreading round branches; leaves serrate; flowers very numerous, with pure white petals; fruit black with a bluish bloom, very austere. It grows in thickets, hedges, and on dry banks, and is used as stocks on which to engraft the plum and some other species. [See PRUNUS.]

SLO'GAN, *n.* The war-cry, or gathering word or phrase of one of the old Highland clans.

SLOOM, *n.* Slumber. [Not in use or local.]

SLOOMY, *a.* Sluggish; slow. [Not in use or local.]

SLOOP, *n.* [D. *stoeop*, *sloepschip*; G. *schaluppe*; Fr. *chaloupe*.] It is written also *Shallop*.] A vessel with one mast, the main-sail of which is attached to a

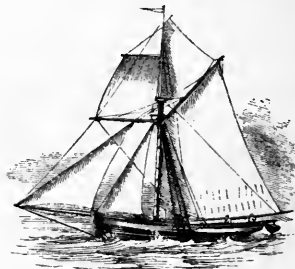

Sloop.

gaff above, to a boom below, and to the mast on its foremost edge. It differs from a cutter by having a fixed steering bowsprit and a jib-stay. Sloops are of various sizes, from the size of a boat to that of more than 100 tons burthen.—*Sloop of war*, a vessel of war rigged either as ship, brig, or schooner, and usually carrying from 18 to 32 guns.

SLOP, *v. t.* [probably allied to *lap*.] To drink greedily and grossly. [*Little used*.]

SLOP, *n.* [probably allied to *slobber*.] Water carelessly thrown about on a table or floor; a puddle; a soiled spot. 2. Mean liquor; mean liquid food.

SLOPE, *a.* [This word contains the elements of *l. labor*, *lapsus*, and Eng. *slip*; also of *L. levo*. Eng. *lift*.] Inclined or inclining from a horizontal direction; forming an angle with the plane of the horizon; as, *slope* hills. [*Little used*.]

SLOPE, *n.* An oblique direction; a line or direction inclining from a horizontal line; properly a direction downward.—2. An oblique direction in general; a direction forming an angle with a perpendicular or other right line.—3.

A declivity; any ground whose surface forms an angle with the plane of the horizon; also, an acclivity, as every declivity must be also an acclivity.

**SLOPE**, *v. t.* To form with a slope; to form to declivity or obliquity; to direct obliquely; to incline; as, to *slope* the ground in a garden; to *slope* a piece of cloth in cutting a garment.

**SLOPE**, *v. i.* To take an oblique direction; to be declivous or inclined.

**SLOPENESS**, *n.* Declivity; obliquity. [*Not much used.*]

**SLOPEWISE**, *adv.* Obliquely.

**SLOPING**, *ppr.* Taking an inclined direction.—2. *a.* Oblique; declivous; inclining or inclined from a horizontal or other right line.

**SLOPINGLY**, *adv.* Obliquely; with a slope.

**SLOPPINESS**, *n.* [from *sloppy*.] Wetness of the earth; muddiness.

**SLOPPY**, *a.* [from *slop*.] Wet, as the ground; muddy; plashy.

**SLOPS**, *n.* [*See Slop*.] A name given to all kinds of wearing apparel, bedding, &c., which are supplied to his [her] majesty's ships in commission, by the naval store-keeper, for the outfit of the seamen, and for which they must pay a certain fixed price.—2. Articles of the same kind, sold in furnishing shops of maritime towns.

**SLOPSELLER**, *n.* One who sells ready made clothes.

**SLOP'SHOP**, *n.* A shop where ready made clothes are sold.

**SLOSH**. *See SLUSH.*

**SLO'SHY**, *a.* *See SLUSHY* and *SLUDGY*.

**SLOT**, *v. t.* [*D. sluiten*, to shut; *G. schliessen*; *Dan. slutter*; *Sw. sluta*; from the root of *L. claudo*.] To shut with violence; to slam, that is, to drive. [*Not in use or local.*]

**SLOT**, *n.* [*Teut. slot*; *Belgic, sluyt*, a bar or bolt.] A bar; a bolt. *Slots of a harrow*, the cross-spars which pass through what are termed the *bulls*, and keep them fast.—*Slots of a cart*, the upright bars which constitute the frame-work to which the boards are nailed. [*Scotch.*] In *mech.*, a term used in the modern practice of engineering, synonymous with the word mortise in carpentry. [*See MORTISE.*]

In its more restricted sense, it is employed to signify a rectangular recess or depression, cut partially into the thickness of any piece of metal for the reception of another piece of similar form, as a key-seat in the eye of a wheel or pulley; but it is also frequently used to denote any oblong hole or aperture formed throughout the entire thickness of a piece of metal, as for the reception of an adjusting bolt.

**SLOT**, *n.* [The Saxon has *slatinge*, tracks.] The track of a deer.—2. [*Ice. sladr.*] A hollow. *The slot of a hill* is a hollow in the hill, or between two ridges.—*Slot of the breast*, the pit of the stomach. [*Scotch.*]

**SLOTH**, *n.* [*Sax. slæweth*, from *slaw*, slow. *See SLOW.*] 1. Slowness; tardiness.

I abhor

This dilatory *sloth* and tricks of Rome.

*Shak.*

2. Disinclination to action or labour; sluggishness; laziness; idleness.

They change their course to pleasure, ease, and *sloth*.

*Milton.*

*Sloth*, like rust, consumes faster than labour wears.

*Franklin.*

3. The popular name of a genus (*Bradypus*) of tardigrade edentate

mammals,—a genus which comprises only two species, viz. *Bradypus tridactylus* or *At*, about the size of a common cat, and *Bradypus didactylus* or *Unau*, about half the size of the former,

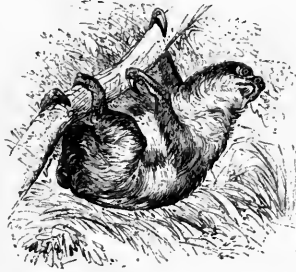

Two-toed Sloth (*Bradypus didactylus*).

both of South America. These animals are so called from the slowness of their motions on the ground, which is the necessary consequence of their disproportioned structure. They live on trees, and never remove from the one they are on until they have stripped it of every leaf. The sloths are exceedingly helpless when on the ground, and move with great difficulty; and hence the accounts of their slowness have been greatly exaggerated. They seem at home only when upon trees, resting or moving suspended beneath their branches, and are sometimes observed to travel from tree to tree, and along branches, with considerable celerity. The female produces but a single young one at a birth; which she carries on her back.

**SLOTH**, *† v. i.* To be idle.

**SLOTHFUL**, *a.* Inactive; sluggish; lazy; indolent; idle.

He that is *slothful* in his work, is brother to him that is a great waster; *Prov. xviii.*

**SLOTHFULLY**, *adv.* Lazily; sluggishly; idly.

**SLOTHFULNESS**, *n.* The indulgence of sloth; inactivity; the habit of idleness; laziness.

*Slothfulness* casteth into a deep sleep; *Prov. xix.*

**SLOTTED**, *a.* Shut with violence. [*Local.*]

**SLOTTERY**, *a.* [*G. schlotterig*, negligent; *schlottern*, to hang loosely, to wobble. *See SLUR.*] 1.† Squalid; dirty; sluttish; untrimmed.—2.† Foul; wet.

**SLOT'TING**, *ppr.* Shutting with violence; slamming. [*Local.*]

**SLOT'TING**, *n.* The operation of making slots.

**SLOT'TING MACHINE**, *n.* In *mech.*, a species of self-acting tool or implement employed in the formation of recesses or *slots* in any piece of machinery. It is simply a planing machine, acting vertically, in which the work is stationary, and the cutting tool movable. Its use was originally confined to such descriptions of work as the cutting of key-seats in wheels, pulleys, cranks, &c.; but more recently it has been extended to dressing and adjusting the exterior surfaces of such objects; in which cases it is sometimes also called a *paring machine*.

**SLOUCH**, *n.* [This word probably belongs to the root of *lag*, *slug*.] 1. A hanging down; a depression of the head or of some other part of the body;

an ungainly, clownish gait.—2. An awkward, heavy, clownish fellow.

**SLOUCH**, *v. i.* To hang down; to have a downcast clownish look, gait, or manner.

**SLOUCH**, *v. t.* To depress; to cause to hang down; as, to *slouch* the hat.

**SLOUCH'ED**, *pp.* Made to hang down; depressed.

**SLOUCH'ING**, *ppr.* Causing to hang down.—2. *a.* Hanging down; walking heavily and awkwardly.

**SLOUGH**, *n.* (*slou*.) [*Sax. slog*; *W. yslug*, a gutter or slough, from *llug*, a lake.] 1. A place of deep mud or mire; a hole full of mire.—2. [*pron. stuff*.] The skin or cast skin of a serpent. [Its use for the skin in general, in Shakspeare, is not authorized.]—3. [*pron. stuff*.] In *sur.*, the dead part which separates from the living in mortification, or the part that separates from a foul sore.

**SLOUGH**, *v. i.* (*stuff*.) To separate from the sound flesh; to come off; as the matter formed over a sore; *a term in surgery*.—To *slough off*, to separate from the living parts, as the dead part in mortification.

**SLOUGH'Y**, *a.* (*slou'y*.) Full of sloughs; miry.

**SLOUGH'Y**, *a.* (*sluffy*.) Foul; mortified; suppurated.

**SLOVEN**, *n.* [*D. slof*, careless; *slaffen*, to neglect; *W. yslabi*, from *yslab*, extended; *Ir. slapaire*.] A man careless of his dress, or negligent of cleanliness; a man habitually negligent of neatness and order. [*See SLUR.*]

**SLOVENLINESS**, *n.* [from *sloven*.] Negligence of dress; habitual want of cleanliness.—2. Neglect of order and neatness.

**SLOVENLY**, *a.* Negligent of dress or neatness; as, a *slovenly* man.—2. Loose; disorderly; not neat; as, a *slovenly* dress.

**SLOVENLY**, *adv.* In a careless, inelegant manner.

**SLOVENRY**, *† n.* Negligence of order or neatness; dirtiness.

**SLOW**, *a.* [*Sax. slaw*, for *slag*; *Dan. sløv*, dull, blunt; contracted from the root of *slach*, *sluggard*, *lag*.] 1. Moving a small distance in a long time; not swift; not quick in motion; not rapid; as, a *slow* stream; a *slow* motion.—2. Late; not happening in a short time.

These changes in the heavens, though *slow*, produc'd

Like change on sea and land, sidereal blast.

*Milton.*

3. Not ready; not prompt or quick; as, *slow* of speech, and *slow* of tongue; *Exod. iv.*—4. Dull; inactive; tardy.

The Trojans are not *slow* To guard their shore from an expected foe.

*Dryden.*

5. Not hasty; not precipitate; acting with deliberation.

The Lord is merciful, *slow* to anger.

*Com. Prayer.*

He that is *slow* to wrath, is of great understanding; *Prov. xiv.*

6. Dull; heavy in wit.—7. Behind in time; indicating a time later than the true time; as, the clock or watch is *slow*.—8. Not advancing, growing, or improving rapidly; as, the *slow* growth of arts and sciences.

**SLOW**, is used in composition to modify other words; as, a *slow-paced* horse.

**SLOW**, *† n.* [*Sax. sliv*.] A moth.

**SLOW**, † *v. t.* To delay.

I would like to know why it should be *slowed*. *Shak.*

2. To slacken in speed; as, to *slow* a locomotive or steamer.

**SLOW**, *v. i.* To slacken in speed; as the locomotive began to *slow*.

**SLOWBACK**, *n.* A lubber; an idle fellow; a loiterer.

**SLOW-LEMUR**, or **SLOW-PACED LEMUR**, *n.* A species of lemur, the *L. tardigradus* of Linn., and *Loris stenops* of Illiger; also called the sloth

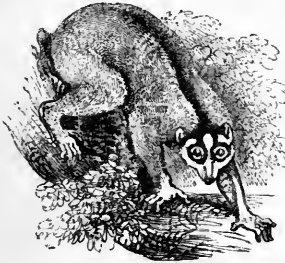

Slow-paced Lemur (*Loris tardigradus*).

of Bengal. It is an animal of small size, scarcely equal to that of a cat, and has been so named from the slowness of its gait.

**SLOWLY**, *adv.* With moderate motion; not rapidly; not with velocity or celerity; as, to walk *slowly*.—2. Not soon; not early; not in a little time; not with hasty advance; as, a country that rises *slowly* into importance.—3. Not hastily; not rashly; not with precipitation; as, he determines *slowly*.—4. Not promptly; not readily; as, he learns *slowly*.—5. Tardily; with slow progress. The building proceeds *slowly*.

**SLOWNESS**, *n.* Moderate motion; want of speed or velocity.

Swiftness and *slowness* are relative ideas.

*Watts.*

2. Tardy advance; moderate progression; as, the *slowness* of an operation; *slowness* of growth or improvement.—3. Dulness to admit conviction or affection; as, *slowness* of heart.—4. Want of readiness or promptness; dulness of intellect.—5. Deliberation; coolness; caution in deciding.—6. Dilatoriness; tardiness.

**SLOW-PACED**, *a.* Having tardy movements; as, a *slow-paced* horse.

**SLOW-SIGHTED**, *a.* Slow to discern.

**SLOW-TRAIN**, *n.* A railway train that goes at slow speed, carrying goods or passengers at reduced rates, or both.

**SLOW-WINGED**, *a.* Flying slowly.

**SLOW-WORM**, } *n.* An insect found on

**SLOE-WORM**, } the leaves of the sloe-tree, which often changes its skin and assumes different colours. It changes into a four-winged fly.

**SLOW-WORM**, *n.* [Sax. *slaw-wyrm*.] One of the English names for the blind worm, the *Anguis fragilis*, Linn. [See **BLIND-WORM**.]

**SLUB**, *n.* A roll of wool drawn out and slightly twisted; a rove.

**SLUB**, *v. a.* To form into slubs.

**SLUBBER**, *n.* One who manages the slubbing-machine.

**SLUBBEL**, *v. t.* To do lazily, imperfectly or coarsely; to daub; to stain; to cover carelessly. [Little used and vulgar.]

**SLUBBERDEGULLION**, *n.* A dirty mean wretch. [A cant word.]

**SLUBBERINGLY**, *adv.* In a slovenly manner. [Not used and vulgar.]

**SLUB'BING-BILLY**, } *n.* A ma-

**SLUB'BING-MACHINE**, } chine for making slubs.

**SLUDGE**, *n.* [D. *sluk*, Sax. *slog*, a slough.] Mud; mire; soft mud.

**SLUDG'ER**, *n.* An iron instrument for boring in quicksand.

**SLUD'GY**, *a.* Miry.

**SLUDS**, *n.* Among miners, half-roasted ore. [See **SLUGS**.]

**SLUE**, *v. t.* In seamen's lan., to turn anything conical or cylindrical, &c., about its axis, without removing it from its place; to turn. The term is chiefly applied to the turning about of a mast, boom, or spar in its cap or boom-iron.

**SLUED**, *pp.* Turned about on its axis, without removing it.

**SLUG**, *n.* [allied to *slach*, *slugard*; W. *llag*; D. *slah*, *slah*, a snail.] 1. A drone; a slow, heavy, lazy fellow.—2. A hinderance; obstruction.—3. The popular name of a genus (*Limax*, Linn.) or family of air-breathing, gastropodous molluscs, so injurious to the agriculturist and horticulturist. Several species inhabit Britain, all of which subsist on leaves, roots, and vegetables. The most common is the *Limax agrestis*, or common slug, of which there are several varieties, which devour the young shoots of turnips, wheat, and indeed all kinds of grain and vegetables, frequently to a ruinous extent.

4. [Qu. Sax. *sloca*, a mouthful; D. *sloh*, a swallow; or Sax. *slecg*, a sledge.] A cylindrical, cubical, or irregularly shaped piece of metal, used for the charge of a gun.

**SLUG**, † *v. i.* To move slowly; to lie idle.

**SLUG**, † *v. t.* To make sluggish.

**SLUG'ABED**, † *n.* One who indulges in lying abed.

**SLUG'GARD**, *n.* [from *slug* and *ard*, slow kind.] A person habitually lazy, idle, and inactive; a drone.

**SLUG'GARD**, *a.* Sluggish; lazy.

**SLUG'GARDIZE**, *v. t.* To make lazy. [Little used.]

**SLUG'GISH**, *a.* Habitually idle and lazy; slothful; dull; inactive; as, a *sluggish* man.—2. Slow; having little motion; as, a *sluggish* river or stream.—3. Inert; inactive; having no power to move itself.

Matter is *sluggish* and inactive.

*Woodward.*

**SLUG'GISHLY**, *adv.* Lazily; slothfully; drowsily; idly; slowly.

**SLUG'GISHNESS**, *n.* Natural or habitual indolence or laziness; sloth; dullness; applied to persons.—2. Inertness; want of power to move; applied to inanimate matter.—3. Slowness; as, the *sluggishness* of a stream.

**SLUG'GY**, † *a.* Sluggish.

**SLUGS**, *n.* Among miners, half-roasted ore. [See **SLUDS**.]

**SLUICE**, *n.* [D. *sluis*, a sluice, a lock; G. *schleuse*, a floodgate, and *schloss*, a lock, from *schliessen*, to shut; Fr. *echuse*; It. *chiusa*, an inclosure.] 1. In a limited sense, this term is almost confined to the sliding gates commonly used in mill-streams, ponds, sewers, &c., to retain the water when necessary, or to allow it to escape in any required quantity, such gates being usually raised and lowered by means of a rack and pinion attached to the upper parts of the frame in which they slide. In a more extended application

of the term, it embraces all kinds of floodgates, flaps, and other apparatus, used to stop, collect, or to retain water, and to let it off as occasion requires. According to this use of the word, a canal-lock may be considered as a double sluice. Sluices are extensively used in most hydraulic works, and exhibit great variety in their construction, according to the purposes which they are intended to serve. In mill-streams, they serve to keep back the water when the mill is at rest, and to regulate the supply, when the mill is going. They also act as wastes to allow the surplus water of a pond or reservoir to escape. Various self-acting sluices have been contrived for mill-streams, &c., to avoid the inconvenience and danger which might result from neglect, as well as to save the expense of a sluice-keeper.—2. An opening; a source of supply; that through which anything flows.

Each *sluice* of affluent fortune open'd soon. *Harte.*

**SLUICE**, *v. t.* To emit by flood gates. [Little used.]

**SLUICY**, *a.* Falling in streams, as from a sluice.

And oft whole sheets descend of *sluicy* rain. *Dryden.*

**SLU'ING**, *ppr.* Turning on its axis.

**SLUMBER**, *v. i.* [Sax. *slumertian*; G. *schlummern*; Dan. *slummer*, *slummer*.] 1. To sleep lightly; to doze.

He that keepeth Israel shall neither *slumber* nor sleep; Ps. cxxi.

2. To sleep. *Slumber* is used as synonymous with *sleep*, particularly in the poetic and eloquent style.—3. To be in a state of negligence, sloth, supineness or inactivity.

Why *slumbers* Pope? *Young.*

**SLUMBER**, *v. t.* To lay to sleep.—2. To stun; to stupefy. [Little used and hardly legitimate.]

**SLUMBER**, *n.* Light sleep; sleep not deep or sound.

From carelessness it shall settle into *slumber*, and from *slumber* it shall settle into a deep and long sleep. *South.*

2. Sleep; repose.

Rest to my soul, and *slumber* to my eyes. *Dryden.*

**SLUMBERED**, *pp.* Laid to sleep.

**SLUMBERER**, *n.* One that slumbers.

**SLUMBERING**, *ppr.* Dozing; sleeping.

**SLUMBERINGLY**, *adv.* In a slumbering manner.

**SLUMBEROUS**, } *a.* Inviting or caus-

**SLUMBERY**, } ing sleep; soporiferous.

While pensive in the *slumberous* shade. *Pope.*

2. Sleepy; not waking.

**SLUMP**, *v. i.* [G. *schlump*, Dan. and Sw. *slump*, a hap or chance, accident, that is, a fall.] In *New England*, to fall or sink suddenly into water or mud, when walking on a hard surface, as on ice or frozen ground, not strong enough to bear the person.

**SLUMP**, *n.* The gross amount; as, to take things in the *slump*. [Familiar.]

**SLUMP**, *v. a.* To take, or give, or pay, or do things in the gross; as, to *slump* the work, or charges. [Familiar.]

**SLUNG**, *pret.* and *pp.* of *Sling*.

**SLUNK**, *pret.* and *pp.* of *Slink*.

**SLUR**, *v. t.* [D. *stordig*, sluttish.] 1. To soil; to sully; to contaminate; to disgrace.—2. To pass lightly; to conceal; to abate; to render obscure.—3. To cheat; to trick. [Unusual.] 4. In

*music*, to sing or perform in a smooth gliding style; to run notes into each other.

**SLUR**, *n.* Properly, a black mark; hence, slight reproach or disgrace. Every violation of moral duty should be a *slur* to the reputation.—2. In *music*, a mark thus,  $\frown$ , connecting two or more notes not on the same degree, indicating to the performer that they are to be united as much as possible, or played, or sung in a smooth blending manner.

**SLUR'ED**, *pp.* Contaminated; soiled.—2. *a.* See the noun, No. 2.

**SLUSH**, or **SLOSH**,  $\dagger$  *n.* Sludge, or wtery mire; soft mud. In *Scotland*, snow in a state of liquefaction.

**SLUSH**, *v. a.* In *marine lan.*, to grease, as a mast.—2. To lave roughly; as, to *slush* a floor with water. [*Familiar.*]

**SLUSHY**, *a.* Consisting of soft mud, or of snow and water.

**SLUT**, *n.* [*D. slet*, a slut, a rag; *G. schlotterig*, negligent, slovenly; *schlottern*, to hang loosely, to wobble or waddle.] 1. A woman who is negligent of cleanliness, and who suffers her person, clothes, furniture, &c., to be dirty or in disorder.—2. A name of slight contempt for a woman. [*See SLOVEN.*]

—3. In the *U. States*, a female dog; a bitch.

**SLUTCH**, *n.* Sludge; mire. [*Provincial.*]

**SLUT'TERY**, *n.* The qualities of a slut; more generally, the practice of a slut; neglect of cleanliness and order; dirtiness of clothes, rooms, furniture, or provisions.

**SLUT'TISH**, *a.* Not neat or cleanly; dirty; careless of dress and neatness; disorderly; as, a *sluttish* woman.—2. Disorderly; dirty; as, a *sluttish* dress.—3. Meretricious. [*Little used.*]

**SLUT'TISHLY**, *adv.* In a sluttish manner; negligently; dirtily.

**SLUT'TISHNESS**, *n.* The qualities or practice of a slut; negligence of dress; dirtiness of dress, furniture, and in domestic affairs generally.

**SLY**, *a.* [*G. schlau*; *Dan. stue*.] 1. Artfully dextrous in performing things secretly, and escaping observation or detection; usually implying some degree of meanness; artfully cunning; *applied to persons*; as, a *sly* man or boy.—2. Done with artful and dextrous secrecy; as, a *sly* trick.—3. Marked with artful secrecy; as, *sly* circumsppection.—4. Secret; concealed.

**SLY'-BOOTS**, *n.* A sly, cunning, or waggish person. [*Low.*]

**SLY'LY**, *adv.* In a sly manner; insidiously. [*See SLEWY.*]

**SLY'NESS**, *n.* The quality of being sly; dexterous artifice to conceal anything; artful secrecy; cunning; craftiness.

**SLYPE**,  $\dagger$  *n.* [*Qu. Belg. sloop*, an alley.] A passage between two walls.

**SMACK**, *v. i.* [*W. ysmac*, a stroke; *Sax. smaccan*, to taste; *G. schmecken*, *schmatzen*; *D. smah*, a cast or throw.] 1. To kiss with a close compression of the lips, so as to make a sound when they separate; to kiss with violence.—2. To make a noise by the separation of the lips after tasting anything.—3. To have a taste; to be tingured with any particular taste.—4. To have a tincture or quality infused, often followed by *of*.

All sects, all ages *smack* of this vice.

*Shak.*

**SMACK**, *v. t.* To kiss with a sharp noise.—2. To make a sharp noise with the lips.—3. To make a sharp noise by

striking; to crack; as, to *smack* a whip; to *smack* the face.

**SMACK**, *n.* A loud kiss.—2. A quick sharp noise; as after a relished taste or in a hearty kiss; a similar noise made by any instrument, as a whip.—3. Taste; savour; tincture.—4. Pleasing taste.—5. A quick smart blow; as, with the flat of the hand.—6. A small quantity; a taste.—7. [*D. smahschip*.] Lye supposes it to be the *Sax. smacca*, from *snaca*, snake, and so named from its form. [*Qu.*] A small vessel with one mast, commonly rigged as a sloop, and used in the coasting trade, or as a tender in the king's service.

**SMACK'ER**, *n.* One who smacks.—2. A smack, or loud kiss. [*Both senses familiar.*]

**SMACK'ING**, *ppr.* Kissing with a sharp noise; making a sharp noise with the lips or by striking.

**SMALL**, *a.* [*Sax. smæl*, *smal*, thin, slender, little; *G. schmal*, *D. smal*, narrow; *Dan. smal*, narrow, strait; *smaler*, to narrow, to diminish; *Sw. smal*; *Russ. malo*, small, little, few; *Malay* and *umahayu*, to diminish; *Slav.* to abase; *W. mal*, small, trivial, light, vain, like, similar.] 1. Slender; thin; fine; of little diameter; hence in general, little in size or quantity; not great; as, a *small* house; a *small* horse; a *small* farm; a *small* body; *small* particles.—2. Minute; slender; fine; as, a *small* voice.—3. Little in degree; as, *small* improvement; *small* acquirements; the trouble is *small*.

There arose no *small* stir about that way; Acts ix.

4. Being of little moment, weight, or importance; as, it is a *small* matter or thing; a *small* subject.—5. Of little genius or ability; petty; as, a *small* poet or musician.—6. Short; containing little; as, a *small* essay.—7. Little in amount; as, a *small* sum; a *small* price.—8. Containing little of the principal quality, or little strength; weak; as, *small* beer.—9. Gentle; soft; not loud; 1 Kings xix.—10. Mean; base; unworthy. [*Colloquial.*]

**SMALL**, *n.* The small or slender part of a thing; as, the *small* of the leg or of the back.—*Small of an anchor*, that part of the shank immediately under the square.

**SMALL**,  $\dagger$  *v. t.* To make little or less.

**SMALL**, *adv.* Communitely; as, sugar pounded *small*.—2. Timidly; as to sing *small*; that is, speak humbly from fear. [*Trivial.*]

**SMALL'AGE**, *n.* A plant of the genus *Apium*, the *A. graveolens*, a sort of parsley.

**SMALL'-ARMS**, *n. plur.* A general name of muskets, carbines, pistols, &c.

**SMALL'-BEER**, *n.* [*small and beer.*]

A species of weak beer.

**SMALL'-CLOTHES**, *n.* The male nether garment; as, breeches, or trowsers.

**SMALL'-COAL**, *n.* [*small and coal.*] Little wood coals that used to be sold to light fires. At present it generally means coals not in lumps, or large pieces.

**SMALL'-CRAFT**, *n.* [*small and craft.*]

A vessel, or vessels in general, of a small size, or below the size of ships and brigs intended for foreign trade.

**SMALL'DEBT COURT**, *n.* A court for the recovery of small debts. [*See SMALL DEBTS.*]

**SMALL'DEBTORS**, *n.* In *Eng. law*,

such persons as are liable for debts or damages, not exceeding the sum of £20, exclusive of costs. [*See SMALL DEBTS.*]

**SMALL'DEBTS**, *n. pl.* In *Eng. law*, such debts as are usually sued for in courts of summary jurisdiction; as in the county courts, &c. The *small debts bill* came into operation Aug. 2, 1845, by which a creditor who has obtained a judgment, or an order for payment, from a competent court, for sums not exceeding £20, can expeditiously and cheaply summon defaulters to the court of bankruptcy or the court of requests, which have power to imprison for not more than forty days. In *Scotland*, debts sued for, in summary form, in the sheriff or justice of peace courts. The latter have cognizance of claims not exceeding £5, the former of claims under £100 Scots, or £8 6s. 8d. By the 5 and 6 Will. IV. cap. 70, it is unlawful to imprison any person on account of a civil debt not exceeding £8 6s. 8d., exclusive of interest and expenses.

**SMALL-GRAINED**, *a.* Having small grains.

**SMALL'ISH**, *a.* Somewhat small. [*Obsolete or trivial.*]

**SMALL'NESS**, *n.* Littleness of size or extent; littleness of quantity; as, the *smallness* of a fly or of a horse; the *smallness* of a hill.—2. Littleness in degree; as, the *smallness* of trouble or pain.—3. Littleness in force or strength; weakness; as, *smallness* of mind or intellectual powers.—4. Fineness; softness; melodiousness; as, the *smallness* of a female voice.—5. Littleness in amount or value; as, the *smallness* of the sum.—6. Littleness of importance; inconsiderableness; as, the *smallness* of an affair.

**SMALL'-POX'**, *n.* [*small and pox, pochs.*]

An exanthematic disease, consisting of a constitutional febrile affection, and a cutaneous eruption. The cutaneous eruption is first a papule, the top of which becomes a vesicle, and then a pustule, and finally forms a thick crust, which sloughs after a certain time, often leaving a pit or scar. This disease is propagated exclusively by contagion or infection, and is very dangerous when it occurs casually. It is called technically, *Variola*. It is distinguished into the *distinct* and *confluent*, implying that, in the former, the pustules are perfectly separate from each other; and that, in the latter, they run much into one another. Small-pox attacks people of all ages, but the young of both sexes are most liable to it; and it may prevail at all seasons of the year, but is most prevalent in the spring and summer. [*See Cow-Pox, VACCINATION.*]

**SMALL'-REED**, *n.* A *British* plant of the genus *arundo*, the *A. calamagrostis*, which grows in marshes and moist woods and hedges.

**SMALL'STIPENDS**, *n.* In *Scotland*, the minimum stipend allowed to ministers having a right to stipend from the teinds of their parishes, is £150 per annum, with £8 6s. 8d. for communion elements, and where there is not a sufficient amount of teinds in the parish, the sum is made up by a payment from the Exchequer. In addition to their stipend, these ministers are entitled to a manse and glebe, or a provision of £50 per annum, in lieu of both.

**SMALL WARES, n.** The name given to textile articles of the tape kind, narrow bindings of cotton, linen, silk, or woollen fabric; plaited sash cord, braid, &c.

**SMALLY, adv.** (small'ly.) In a little quantity or degree; with minuteness. [*Little used.*]

**SMALT, n.** [D. *smelten*, Dan. *smelter*, to melt; G. *schmelz*, from *schmelzen*, to melt, to smelt; a word formed on *melt*.] Common glass tinged of a fine deep blue by the protoxide of cobalt. When reduced to an impalpable powder it is employed in painting, and printing upon earthenware, and to give a blue tint to writing paper and linen. Common smalts are prepared by mixing zaffre, sand, and pearl ash.

**SMALTINE, n.** Gray cobalt; tin-white cobalt; consisting of arsenic and cobalt.

**SMARAGD, } n.** [Gr. *σμεραγδος*.]  
**SMARAG'DUS, }** The emerald. This name was given by the ancients to various other precious stones; as fluor spar, green jasper, and green glass.

**SMARAG'DINE, a.** [L. *smaragdinus*, from the Greek.] Pertaining to emerald; consisting of emerald, or resembling it; of an emerald green.

**SMARAG'DITE, n.** A mineral; called also green diallage.

**SMART, n.** [D. *smert*; G. *schmerz*. This word is probably formed on the root of L. *amarus*, bitter, that is, sharp, like Fr. *piquant*. See the root *מר*, *merar*, Ar. *marra*.] 1. Quick, pungent, lively pain; a pricking local pain, as the pain from puncture by nettles; as, the *smart* of bodily punishment.—2. Severe pungent pain of mind; pungent grief; as, the *smart* of affliction.

**SMART, v. t.** [Sax. *smeorstan*; G. *schmerzen*.] 1. To feel a lively pungent pain, particularly a pungent local pain from some piercing or irritating application. Thus Cayenne pepper applied to the tongue makes it *smart*.—2. To feel a pungent pain of mind; to feel sharp pain; as, to *smart* under sufferings.—3. To be punished; to bear penalties or the evil consequences of any thing.

He that is surety for a stranger shall *smart* for it; Prov. xi.

**SMART, a.** Pungent; pricking; causing a keen local pain; as, a *smart* lash or stroke; a *smart* quality or taste.—2. Keen; severe; poignant; as, *smart* pain or sufferings.—3. Quick; vigorous; sharp; severe; as, a *smart* skirmish.—4. Brisk; fresh; as, a *smart* breeze.—5. Acute and pertinent; witty; as, a *smart* reply; a *smart* saying.—6. Brisk; vivacious; as, a *smart* rhetorician.

Who, for the poor renown of being *smart*, Would leave a sting within a brother's heart? Young.

7. Dressed in a showy manner; shining and spruce in apparel.

**SMART, † n.** A cant word for a fellow that affects briskness and vivacity.

**SMÄRTER, † v. t.** To make smart.

**SMÄRTER, a.** More smart. [*Comp. of Smart*]

**SMÄRTEST, a.** Most smart. [*Sup. of Smart*.]

**SMÄRTELE, † v. i.** To waste away.

**SMÄRTLY, adv.** With keen pain; as, to ache *smartly*.—2. Briskly; sharply; wittily.—3. Vigorously; actively.—4. Showily; in a showy manner; as, *smartly* dressed.

**SMART-MONEY, n.** Money used in the recruiting service. Formerly,

money paid for redemption from military service.

**SMARTNESS, n.** The quality of being *smart* or pungent; poignancy; as, the *smartness* of pain.—2. Quickness; vigour; as, the *smartness* of a blow.—3. Liveliness; briskness; vivacity; wittiness; as, the *smartness* of a reply or of a phrase.

**SMART-TICKET, n.** A certificate granted to a seaman when hurt, maimed, or disabled in the service, to the end that he may receive the benefit of the *chest* at Greenwich.

**SMART-WEED, n.** A name given to the arse-smart, or *Polygonum punctatum*, on account of its acrimony, which produces smarting if applied where the skin is tender.

**SMASH, v. t.** [probably *marsh*, with a prefix.] To break in pieces by violence; to dash to pieces; to crush. [*Colloq.*]

Here every thing is broken and *smashed* to pieces. Burke.

**SMASH, n.** A breaking to pieces. [*Colloq.*]

**SMASH'ED, pp.** Dashed to pieces.

**SMASH'ER, n.** He or that which smashes or breaks.—2. One who passes bad money. [*Vulgar.*]

**SMASH'ING, ppr.** and *n.* Dashing to pieces.—2. Passing bad money. [*Vulgar.*]

**SMASH'ING, n.** State of being smashed, or broken.

**SMATCH, n.** [corrupted from *Smack*.] 1. Taste; tincture. [*Not in use or vulgar.*].—2. A bird.

**SMAT'TER, v. i.** [Qu. Dan. *smatter*, to smack, to make a noise in chewing; Sw. *smattra*, to crackle; Ice. *smædr*. It contains the elements of *mutter*.] 1. To talk superficially or ignorantly.

Of state affairs you cannot *smatter*. Swift. 2. To have a slight taste, or a slight superficial knowledge.

**SMAT'TER, n.** Slight superficial knowledge.

**SMAT'TERER, n.** One who has only a slight superficial knowledge.

**SMAT'TERING, n.** A slight superficial knowledge. [*This is the word commonly used.*]

**SMĒAR, v. t.** [Sax. *smieran*, *smirian*; G. *schmierien*; Ir. *smearan*; G. *schmier*, grease, tallow; Ir. *smear*, id.; Sw. and Dan. *smör*, butter. Qu. its alliance with *marrow*, *marl*, *mire*, from its softness.] 1. To overspread with any thing unctuous, viscous, or adhesive; to besmear; to daub; as, to *smear* sheep with oil, butter, pitch, &c.—2. To soil; to contaminate; to pollute; as, *smear*d with infamy.

**SMĒAR, n.** A fat oily substance; ointment; a besmearing. [*Little used.*]

**SMĒARED, pp.** Overspread with soft or oily matter; soiled.

**SMĒARING, ppr.** Overspreading with any thing soft and oleaginous; soiling. **SMĒARY, a.** That smears or soils; adhesive. [*Little used.*]

**SMĒATH, n.** A sea fowl.

**SMĒE'TITE, n.** [Gr. *σμεματις*, deterring.] An argillaceous earth; so called from its property of taking grease out of cloth, &c.

**SMĒED'DUM, n.** [Sax. *smedema*, pollen, meal, fine flour.] The powder or finest part of ground malt; powder of whatever kind; sagacity, quickness of apprehension; spirit; mettle; liveliness. [*Scotch.*]

**SMĒETH, † v. t.** To smoke.

**SMEGMATIC, a.** [Gr. *σμηγματις*, soap.]

Being of the nature of soap; soapy; cleansing; detersive.

**SMELL, v. t.** pret. and pp. *Smelled*, *Smelt*. [*Etymol.* uncertain.] To perceive by the nose, or by the olfactory nerves; to have a sensation excited in certain organs of the nose by particular qualities of a body, which are transmitted in fine particles, often from a distance; as, to *smell* a rose; to *smell* perfumes. To *smell out*, is a low phrase signifying to find out by sagacity. To *smell a rat*, is a low phrase signifying to suspect strongly.

**SMELL, v. i.** To affect the olfactory nerves; to have an odour or particular scent; followed by *of*; as, to *smell of* smoke; to *smell of* musk.—2. To have a particular tincture or smack of any quality; as, a report *smells of* calumny. [*Not elegant.*].—3. To practise smelling; Exod. xxx.—4. To exercise sagacity.

**SMELL, n.** The sense or faculty by which certain qualities of bodies are perceived through the instrumentality of the olfactory nerves; or the faculty of perceiving by the organs of the nose; one of the five senses. The essential part of the organ of smell consists of the expansion of the olfactory nerves, the first or most anterior of the nerves from the brain, whose minutest branches are distributed just beneath the mucous part of the nose. The air, passing through the nose, brings the effluvia or odoriferous particles of bodies into contact with the olfactory nerves, the nerves transmit the impression to the brain, by means of which it is perceived by the mind. The human organ of smell is less developed than that of other mammalia, or even of birds. In different animals the sense of smell is adapted chiefly to that class of substances on which they feed. In the choice of food, which is the main object of the sense of smell, man generally, though almost unconsciously, and animals always, exercise the precaution of smelling, and they instinctively form a judgment according to the impression received. In eating also, much of that which is commonly attributed to the sense of taste, depends upon the odour of the food carried from the mouth to the nose. In some species of beasts, the *smell* is remarkably acute, particularly in the canine species.—2. Scent; odour; the quality of bodies which affects the olfactory organs; as, the *smell of* mint; the *smell of* geranium.

The sweetest *smell* in the air is that of the white double violet. Bacon.

**SMELL'ED, }**

**SMELT, }** pret. and pp. of *Smell*.

**SMELLER, n.** One that smells, or gives out a smell.—2. The nose. [*Vulgar.*]

**SMELL'FEAST, n.** [*smell and feast*.] One that is apt to find and frequent good tables; an epicure; a parasite.

**SMELL'ING, ppr.** Perceiving by the olfactory nerves.

**SMELL'ING, n.** The sense by which odours are perceived.—2. The act of one who smells.

**SMELL'ING-BOTTLE, n.** A bottle containing some agreeable or pungent scent, either to please or stimulate the sense of smell.

**SMELT.** See *SMELLED*.

**SMELT, n.** [Sax.] A small but delicious European fish of the genus *Osmerus*, the *O. eperlanus*, allied to the salmon, inhabiting the salt water about the



months of rivers. The American smelt is the *Osmerus viridescens*, which inhabits the coasts of New England.



Smelt (*Osmerus eperlanus*).

**SMELT**, *v. t.* [*D. smelten*; *G. schmetzen*; *Sw. smälta*, to melt. This is *melt*, with *s* prefixed.] To melt, or fuse, as ore, for the purpose of separating the metal from extraneous substances.

**SMELT'ED**, *pp.* Melted for the extraction of the metal.

**SMELT'ER**, *n.* One that melts ore.

**SMELT'ERY**, *n.* A house or place for smelting ores.

**SMELT'ING**, *ppr.* Melting, as ore.

**SMELT'ING**, *n.* The operation by which the ores of iron, copper, lead, &c., are reduced to the metallic state by fusion. This operation requires to be conducted differently according to the different metallic ores. In regard to iron, the ore, after having been roasted or calcined in a kiln, in order to drive off the water, sulphur, and arsenic, with which it is more or less combined in its native state, is subjected to the heat of a blast furnace, along with certain proportions of coke and limestone, which latter serves as a flux. The furnace is charged with the materials from the top, and these being set fire to at the bottom, are allowed to burn, the combustion being afterwards accelerated by a blast from a blowing machine, the blast pipes of which are made to enter near the bottom of the furnace. The ore, coke, and limestone in the body of the furnace are acted upon by the heat, just as they would be in a close vessel, the oxygen of the ore combining with the carbon of the coke, and forming carbonic oxide, and thus gradually reducing the ore to the metallic state. The liquid metal, as it is thus formed, falls down to that part of the bottom of the furnace called the hearth, where there is an opening in the wall, at the mouth of which a stone is placed called the *dam stone*. Beyond this, an opening is made in the side of the outer wall, in order to run off the metal, when collected in sufficient quantity. On opening this hole, the metal is allowed to run off into a channel made in a kind of sand. From this channel, called the *sow*, numerous side channels are led, called *pigs*, and as the melted metal flows along the *sow*, it is frequently checked by the workmen, and made to flow into the side channels, and thus the masses of iron called *pig iron* are formed, the masses formed in the main channel being termed *sow iron*.

**SMERK**. See **SMIRK**.

**SMER'KY**, *† a.* Nice; smart; janty.

**SMEW**, *n.* A small species of the Merganserine family, *Mergus Albellus*, intermediate between the *duck* tribe, and the fish-eating divers. It is otherwise called the white nun. The hooded smew (*Mergus cucullatus*) is a beautiful species peculiar to America, and is usually found along the lakes and fresh

water rivers, rather than near the sea. It is only accidentally found in Europe.

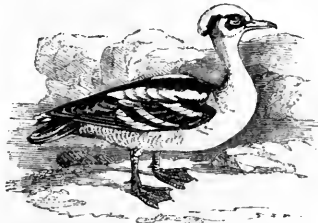

Smew (*Mergus albellus*).

**SMICK'ER**, *v. i.* [*Sw. smickra*, to flatter, *Dan. smigrer*.] To smirk; to look amorously or wantonly.

**SMICK'ERING**, *ppr.* Smirking; smiling affectedly.

**SMICK'ERING**, *n.* An affected smile or amorous look.

**SMICK'ET**, *† n.* dim. of *Smock*.

**SMID'DY**, *n.* [*Sax. smiththa*.] A smithy or smith's workshop. [*Scotch*.] **SMIFT**, *n.* In *mining*, a match of paper, or other light combustible substance, for firing a charge of powder, as in a mine; a fuse.

**SMIGHT**, for *Smite*, in Spenser.

**SMILA'CEÆ**, *n.* [From *Smilax* one of the genera.] A small nat. order of plants, belonging to Lindley's retose group of monocotyledons. Lindley has placed two genera in this order, *Smilax* and *Ripogonum*. They are mostly herbaceous plants, with a woody stem and a tendency to climb. They are found in small quantities in most parts of the world, especially in Asia and North America, and are best known for the diuretic and demulcent powers of *Smilax sarsaparilla*, which also exist in other species of the same genus. Their leaves are usually reticulated in venation, thus differing from those of monocotyledons in general. The vascular bundles in the root are arranged in wedges, whereas those of the stem are arranged as in other endogens.

**SMIL'ACINE**, *n.* [*Gr. σμιλαξ*; *L. smilax*, the modern name of a genus of plants.] A white crystallizable compound, considered to be the active principle of the official species of *smilax*, or *sarsaparilla*. It is tasteless when solid, but bitter in solution. It is now ascertained to be an acid, and is called *parillinic acid*.

**SMIL'AX**, *n.* A genus of plants, type of the nat. order *Smilacæ*. The species form evergreen climbing shrubs, of which a few are found in temperate, but the majority in warm and tropical regions of both hemispheres. Though the original species (*S. aspera*), is an inhabitant of the South of Europe, those now most celebrated for yielding the different kinds of *sarsaparilla* are natives of South America. But *S. aspera* still continues to be employed for medicinal purposes in the South of Europe, where it is called *Sarsaparilla Italica*. [See **SARSAPARILLA**.]

**SMILE**, *v. i.* [*Sw. smila*; *Dan. smiler*.]

1. To contract the features of the face in such a manner as to express pleasure, moderate joy, or love and kindness, the contrary to *frown*. The smiling infant in his hand shall take The crested basilisk and speckled snake.

*Pope.*

She smiled to see the doughty hero slain.

*Pope.*

2. To express slight contempt by a smiling look, implying sarcasm or pity; to sneer.

'Twas what I said to Craggs and Child,  
Who prais'd my modesty and smiled. *Pope.*

3. To look gay and joyous; or to have an appearance to excite joy; as, *smiling* spring; *smiling* plenty.

The desert smiled,

And paradise was open'd in the wild.

*Pope.*

4. To be propitious or favourable; to favour; to countenance. May heaven smile on our labours.

**SMILE**, *v. t.* To awe with a contemptuous smile.

**SMILE**, *n.* A peculiar contraction of the features of the face, which naturally expresses pleasure, moderate joy, approbation, or kindness; opposed to *frown*.

Sweet intercourse of looks and smiles.

*Milton.*

2. Gay or joyous appearance; as, the smiles of spring.—3. Favour; countenance; propitiousness; as, the smiles of Providence.—4. An expression of countenance resembling a smile, but indicative of opposite feelings, as, contempt, scorn, &c.; as, a scornful or derisive smile.

**SMILE'FUL**, *a.* Full of smiles; smiling.

**SMILELESS**, *a.* Not having a smile.

**SMILER**, *n.* One who smiles.

**SMILING**, *ppr.* Having a smile on the countenance; looking joyous or gay; looking propitious.

**SMILINGLY**, *adv.* With a look of pleasure.

**SMILINGNESS**, *n.* State of being smiling.

**SMILT**, *†* for *Smelt*.

**SMIRCH**, *v. t.* (*smersh*.) [from *murk, murky*.] To cloud; to dusk; to soil; as, to *smirch* the face. [*Low*.]

**SMIRK**, *v. i.* (*smerk*.) [*Sax. smercian*.] To smile affectedly or wantonly.—2. To look affectedly soft or kind; as, a *smirking* countenance; a *smirking* grace.

**SMIRK**, *n.* An affected smile.

**SMIRK**, *a.* Nice; smart; janty.

So *smirk*, so smooth hee prick'd his ears.

*Spenser.*

**SMIT**, sometimes used for *Smitten*. [See **SMITE**.]

**SMITE**, *v. t.* pret. *Smote*; *pp. Smitten*, *Smit*. [*Sax. smitan*, to strike; *smitan ofer* or *on*, to put or place, that is, to throw; *D. smyten*, to smite, to cast, or throw; *G. schmeissen*, to smite, to fling, to kick, to cast or throw, to fall down, that is, to throw one's self down; *Sw. smida*, to hammer or forge; *Dan. smider*, to forge, to strike, to coin, to invent, devise, counterfeit; *D. smeeden*, to forge; *G. schmieden*, to coin, forge, invent, fabricate. The latter verb seems to be formed on the noun *schmied*, a smith, or *schmiede*, a forge, which is from the root of *smite*. This verb is the *L. mitto*, *Fr. mettre*, with *s* prefixed. It is no longer in common use, though not entirely obsolete.] 1. To strike; to throw, drive or force against, as the fist or hand, a stone or a weapon; to reach with a blow or a weapon; as, to *smite* one with the fist; to *smite* with a rod or with a stone.

Whoever shall *smite* thee on the right cheek, turn to him the other also; *Matth. v. 2.* To kill; to destroy the life of by beating or by weapons of any kind; as, to *smite* one with the sword, or with an arrow or other engine. *David smote Goliath* with a sling and a stone.

The Philistines were often *smitten* with great slaughter. [This word, like *slay*, usually or always carries with it something of its original signification, that of *beating*, *striking*, the primitive mode of killing. We never apply it to the destruction of life by poison, by accident, or by legal execution.]—3. To blast; to destroy life; as by a stroke or by something sent.

The flax and the barley were *smitten*; Exod. ix.

4. To afflict; to chasten; to punish.

Let us not mistake God's goodness, nor imagine, because he *smiles* us, that we are forsaken by him. *Wake.*

5. To strike or affect with passion. See what the charms that *smite* the simple heart. *Pope.*

*Smit* with the love of sister arts we came. *Pope.*

To *smite* with the tongue, to reproach or upbraid. [Jer. xviii.]

SMITE, v. i. To strike; to collide.

The heart melteth, and the knees *smite* together; Nah. ii.

SMITE, n. A blow. [*Local.*]

SMITER, n. One who smites or strikes.

I gave my back to the *smiters*; Is. i.

SMITH, n. [Sax. *smith*; Dan. and Sw. *smed*; D. *smit*; G. *schmied*; from *smithing*.] 1. Literally, the striker, the beater; hence, one who forges with the hammer; one who works in metals; as, an iron-*smith*; gold-*smith*; silver-*smith*, &c.

Nor yet the *smith* hath learn'd to form a sword. *Tate.*

2. He that makes or effects any thing. Hence the name *Smith*, which from the number of workmen employed in working metals in early ages, is supposed to be more common than any other.

SMITH,† v. t. [Sax. *smithian*, to fabricate out of metal by hammering.] To beat into shape; to forge.

SMITH-CRAFT, n. [*smith* and *craft*.] The art or occupation of a smith. [*Little used.*]

SMITHERY, n. The workshop of a smith. 2. Work done by a smith.—3. The art of uniting several lumps of iron into one lump or mass, and forming such masses into any desired shape. The operations necessary for this purpose are primarily performed in the forge, and on the anvil with the hammer, but for finishing many other implements and tools are necessary.

SMITHING, n. The act or art of working a mass of iron into the intended shape.

SMITH'S WORK, n. Work performed by a smith.

SMITHY, n. [Sax. *smiththa*.] The shop of a smith.

SMITING, *ppr.* Striking; killing; afflicting; punishing.

SMITT, n. The finest of the clayey ore made up into balls, used for marking sheep.

SMITTEN, *pp.* of *Smite*. (*smit'n*.) Struck; killed.—2. Affected with some passion; excited by beauty or something impressive.

SMOCK, n. [Sax. *smoc*.] 1. A shift; a chemise; a woman's under garment.—2. In *composition*, it is used for female, or what relates to women; as, *smock-treason*; *smock-loyalty*, &c.

SMOCK-FACED, a. [*smock* and *face*.] Pale faced; maidenly; having a feminine countenance or complexion.

SMOCK-FROCK, n. [*smock* and *frock*.]

A gaberdine, or round frock worn by field-labourers.

SMOCK'LESS, a. Wanting a smock.

SMOCK'-MILL, n. A wind-mill whose top is the only part that turns to meet the wind.

SMOK'ABLE, n. Capable of being smoked. [*Trivial.*]

SMOKE, n. [Sax. *smoca*, *smec*, *smic*; G. *schmauch*; W. *ysmwig*, from *wig*, smoke; Ir. *much*; allied to *muggy*, and possibly allied to the Gr. *σμούχος*, to consume slowly, to waste.] 1. The exhalation, visible vapour, or substance that escapes or is expelled in combustion from the substance burning. It is particularly applied to the volatile matter expelled from vegetable matter, or wood, coal, peat, &c. The matter expelled from metallic substances is more generally called *fume*, *fumes*. In its more extended sense, the word smoke is applied to all the volatile products of combustion, which consist of gaseous exhalations charged with minute portions of carbonaceous matter, or soot; but, as often used in reference to what are called smoke-consuming furnaces, the term is frequently employed to express merely the carbonaceous matter which is held in suspension by the gases. Various methods have been devised for the removal of smoke or for the cure of smoky chimneys, and also for the consumption and purification of smoke. The methods employed for the latter purpose all merge into one common principle; namely, that of mixing air with the combustible vapours and gases generated by the action of heat on pit coal, so that they may be made to burn with flame, and become entirely converted into incombustible and transparent invisible vapours and gases.—2. Vapour; watery exhalations.

SMOKE, v. i. [Sax. *smocian*, *smecan*, *smican*; G. *schmauchen*.] 1. To emit smoke; to throw off volatile matter in the form of vapour or exhalation. Wood and other fuel *smokes* when burning; and *smokes* most when there is the least flame.—2. To burn; to be kindled; to rage; in Scripture.

The anger of the Lord and his jealousy shall *smoke* against that man; Deut. xxix.

3. To raise a dust or smoke by rapid motion.

Proud of his steeds, he *smokes* along the field. *Dryden.*

4. [Gr. *σμούχω*.] To sneer at; to quiz; to ridicule to the face. [*Triv. and obs.*]

—5. To smell or hunt out; to suspect. I began to *smoke* that they were a parcel of mummers. [*Little used.*] *Addison.*

6. To emit fumes of burning tobacco from a pipe or cigar.—7. To suffer; to be punished.

Some of you shall *smoke* for it in Rome. *Shak.*

SMOKE, v. t. To apply smoke to; to foul by smoke; to hang in smoke; to scent; to expel by smoke; medicate or dry by smoke; as, to *smoke* infected clothing; to *smoke* beef or hams for preservation.—2. To smell out; to find out. [*Little used.*]

SMOKE-BOARD, n. A board hung in front of a fire-place, to keep the smoke from emerging into the apartment.

SMOKE-CONSUMING, a. Consuming smoke.

SMOKED, *pp.* Cured, cleansed, or dried in smoke.

SMOKE-DRIED, a. Dried in smoke.

SMOKE-DRY, v. t. To dry by smoke.

SMOKE-JACK, n. A machine for turning a roasting spit by means of a fly-

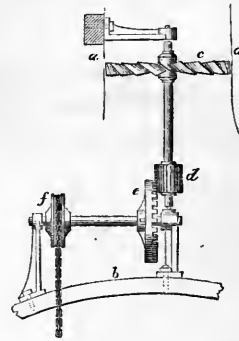

Smoke-Jack.

a, a, The chimney, contracted in a circular form; b, Strong bar placed over the fire-place, to support the jack; c, Wheel with vanes radiating from its centre, set in motion by the ascent of the heated air, and communicated, by the pinion d and the crown-wheel e, with the pulley f, from which motion is transmitted to the spit by the chain passing over it.

wheel or wheels, set in motion by the current of ascending air in a chimney. SMOKELESS, a. Having no smoke; as, *smokeless* towers.

SMOKER, n. One that dries by smoke —2. One that uses tobacco by burning it in a pipe or in the form of a cigar.

SMOKE-SAIL, n. A small sail hoisted against the fore-mast when a ship rides head to wind, to give the smoke



Smoke-Sail.

of the galley an opportunity of rising, and to prevent its being blown aft on to the quarter deck.

SMOKILY, *adv.* So as to be full of smoke.

SMOKINESS, n. The state of being smoky.

SMOKING, *ppr.* Emitting smoke, as fuel, &c.—2. Applying smoke for cleansing, drying, &c.—3. Using tobacco in a pipe or cigar.

SMOKING, n. The act of emitting smoke.—2. The act of applying smoke to.—3. The act or practice of inhaling tobacco smoke from a pipe or cigar.

SMOKY, a. Emitting smoke; fumed; as, *smoky* fires.—2. Having the appearance or nature of smoke; as, a *smoky* fog.—3. Filled with smoke, or with a vapour resembling it; thick; dark; obscure.—4. Subject to be filled with smoke from the chimneys or fire-places; as, a *smoky* house.—5. Tarnished with smoke; noisome with smoke; as, *smoky* rafters; *smoky* cells.

SMOOR, } †*v. l.* [Sax. *smoran.*] To suf-  
SMORE, } focate or smother. [Scotch.]  
SMOOTH, *a.* [Sax. *smethe, smoth;*  
*W. esmwyth, from mwyth; allied to L.*  
*mitis, fr. myth, maoth, soft, tender.*]  
1. Having an even surface, or a surface  
so even that no roughness or points are  
perceptible to the touch; not rough;  
as, *smooth glass; smooth porcelain.*

The outlines must be *smooth*, impercep-  
tible to the touch. *Dryden.*

2. Evenly spread; glossy; as, a *smooth*  
haired horse.—3. Gently flowing;  
moving equably; not ruffled or undu-  
lating; as, a *smooth stream; smooth*  
Adonis.—4. That is uttered without  
stops, obstruction, or hesitation; volu-  
ble; even; not harsh; as, *smooth*  
verse; *smooth eloquence.*

When sage Minerva rose,  
From her sweet lips *smooth* elocution flows.  
*Gay.*

5. Bland; mild; soothing; flattering.  
This *smooth* discourse and mild behaviour  
oft

Conceal a traitor. *Addison.*

6. In *bot.*, glabrous; having a slippery  
surface void of roughness, or without  
hairs.

SMOOTH, *n.* That which is smooth;  
the smooth part of anything; as, the  
*smooth* of the neck; Gen. xxvii.

SMOOTH, *v. t.* [Sax. *smethian.*] 1. To  
make smooth; to make even on the  
surface by any means; as, to *smooth*  
a board with a plane; to *smooth* cloth  
with an iron.

And *smooth'd* the rifled sea. *Dryden.*  
2. To free from obstruction; to make  
easy.

Thou, Abelard, the last sad office pay,  
And *smooth* my passage to the realms of  
day. *Pope.*

3. To free from harshness; to make  
flowing.

In their motions harmony divine  
So *smooths* her charming tones. *Milton.*

4. To palliate; to soften; as, to *smooth*  
a fault.—5. To calm; to mollify; to  
allay.

Each perturbation *smooth'd* with outward  
calm. *Milton.*

6. To ease.

The difficulty *smooth'd*. *Dryden.*

7. To flatter; to soften with blandish-  
ments.

Because I cannot flatter and look fair,  
Smile in men's faces, *smooth*, deceive and  
coy. *Shak.*

SMOOTH-CHINNED, *a.* Beardless.

SMOOTH'ED, *pp.* Made smooth.

SMOOTH ELM, *n.* A species of elm,  
the *Ulmus glabra*, which is very com-  
mon in several parts of Hertfordshire,  
Essex, and other north-east counties  
of England, where it grows to a large  
tree, and is much esteemed.

SMOOTHER, *n.* One who smooths.

SMOOTHER, *a. comp.* of *Smooth.*

SMOOTH-FACED, *a.* Having a mild,  
soft look; as, *smooth-faced* woers.

SMOOTH'ING, *ppr.* Making smooth.

SMOOTH'ING-IRON, *n.* A well  
known utensil for smoothing linens,  
&c., after being washed. There are  
several kinds of smoothing-irons; as,  
the *box-iron*, the flat or *sod-iron*, the  
*Italian-iron*, &c.

SMOOTH'ING-PLANE, *n.* See PLANE.

SMOOTH'LY, *adv.* Evenly; not roughly  
or harshly.—2. With even flow or mo-  
tion; as, to flow or glide *smoothly*.—  
3. Without obstruction or difficulty;  
readily; easily.—4. With soft, bland,  
insinuating language.

SMOOTH'NESS, *n.* Evenness of sur-  
II.

face; freedom from roughness or as-  
perity; as, the *smoothness* of a floor or  
wall; *smoothness* of the skin; *smooth-*  
*ness* of the palate.—2. Softness or mild-  
ness to the palate; as, the *smoothness*  
of wine.—3. Softness and sweetness of  
numbers; easy flow of words.

Virgil, though smooth where *smoothness*  
is required, is far from affecting it. *Dryden.*  
4. Mildness or gentleness of speech;  
blandness of address.

SMOOTH-PACED, *a.* Having a smooth  
pace.

SMOOTH-TONGUED, *a.* Soft of  
speech; plausible; flattering; cozening.  
SMORZA'TO. [It. *extinguished.*] In  
*music*, a term denoting that the violin  
bow is to be drawn to its full extent,  
but gradually lighter till the sound is  
nearly lost.

SMOTE, *pret.* of *Smite.*

SMOTHER, *v. t.* [allied perhaps to Ir.  
*smuid, smoke; Sax. methgian, to*  
*smoke.*] 1. To suffocate or extinguish  
life by causing smoke or dust to enter  
the lungs; to stifle.—2. To suffocate  
or extinguish by closely covering, and  
by the exclusion of air; as, to *smother*  
a child in bed.—3. To suppress; to  
stifle; as, to *smother* the light of the  
understanding.

SMOTHER, *v. i.* To be suffocated.—2.  
To be suppressed or concealed.—3. To  
smoke without vent.

SMOTHER, *n.* Smoke; thick dust;  
confusion as from dust.—2. † A state  
of suppression.

SMOTHERED, *pp.* Suffocated; stifled;  
suppressed.

SMOTHERINESS, *n.* State of being  
smothery.

SMOTHERING, *ppr.* Suffocating; sup-  
pressing.

SMOTHERING, *n.* Act of smothering.

SMOUCH, † *v. t.* To salute.

SMOULDER, *v. i.* [See SMOULDERING.]  
To burn and smoke without vent; to  
burn and smoke without flame.

SMOULDERING, *a.* [Sax. *smoran, to*  
*SMOULDRY,* } smoor, or smore,  
to smother.] Burning and smoking  
without vent, or flame; as, *smoulder-*  
*ing* ashes.

SMUDGE, *v. t.* [from *smut.*] To smear  
or stain with dirt or filth; to blacken  
with smoke.

SMUG, † *a.* [Dan. *smuk, neat, fine; G.*  
*smuch; Sax. smicere.*] Nice; neat;  
affectedly nice in dress.—2. † Affectedly  
smart; as, a *smug* saying.

SMUG, † *v. t.* To make spruce; to dress  
with affected neatness.

SMUG'GLE, *v. t.* [Sw. *smygga; D.*  
*smokhelen*, which seems to be allied to  
*smug*, under hand; *smuigen*, to eat in  
secret; G. *schmuggeln; Dan. smug,*  
clandestinely. We probably have the  
root *smug*, in *hugger mugger.*] 1. To  
import or export secretly goods which  
are forbidden by the government to  
be imported or exported; or secretly  
to import or export dutiable goods  
without paying the duties imposed by  
law; to run.—2. To convey clandes-  
tinely.

SMUG'GLED, *pp.* Imported or ex-  
ported clandestinely and contrary to  
law.

SMUG'GLER, *n.* One that imports or  
exports goods privately and contrary  
to law, either contraband goods or  
dutiable goods, without paying the  
customs.—2. A vessel employed in  
running goods.

SMUG'GLING, *ppr.* Importing or ex-  
porting goods contrary to law.

SMUG'GLING, *n.* The offence of im-  
porting or exporting prohibited goods,  
or other goods without paying the cus-  
toms. The offence of defrauding the  
revenue, by the clandestine introduc-  
tion of articles into consumption,  
without paying the duties chargeable  
upon them. It may be committed in-  
differently upon the excise, or customs  
revenue. The practice of smuggling  
owes its existence to the high duties  
imposed upon foreign or home articles  
of commerce.

SMUG'LY, † *adv.* Neatly; sprucely.  
SMUG'NESS, † *n.* Neatness; spruce-  
ness without elegance.

SMU'LY, † *a.* Looking smoothly demure  
SMUT, *n.* [Dan. *smuds; Sax. smitta;*  
*D. smet, a spot or stain; Sw. smitta,*  
*to taint; D. smoddig, dirty; smodderen,*  
*to smut; G. schmutz.*] 1. A spot made  
with soot or coal; or the foul matter  
itself.—2. A disease also called *dust-*  
*brand*, incidental to cultivated corn,  
by which the farina of the grain, to-  
gether with its proper integuments,  
and even part of the husk, is converted  
into a black soot-like powder. This  
disease does not affect the whole body  
of the crop, but the smutted ears are  
sometimes very numerous dispersed  
throughout it. Some attribute the  
smut to the richness of the soil, and  
others consider it as a hereditary dis-  
ease, transmitted by one generation  
to another through the seed. Willde-  
now and Mirbel regard it as a small  
fungus, the *Uredo segetum*; but Bauer  
believes it to be a proper disease, in-  
dicated by a morbid swelling of the  
ear. Various schemes have been tried  
for the prevention of smut, but the  
safest mode for the farmer to pursue,  
is never to sow grain from a field in  
which the smut has prevailed.—*Smut*  
*balls*, or *Pepper brand*, a disease ana-  
logous to smut. It consists of a black  
powdery matter, having a disagreeable  
odour, occupying the interior of the  
grain of wheat. This powdery matter  
consists of minute balls filled with  
sporules, and is caused by the attack  
of *Uredo caries* or *fetida*.—3. Obscene  
language.

SMUT, *v. t.* To stain or mark with  
smut; to blacken with coal, soot, or  
other dirty substance.—2. To taint with  
mildew.—3. To blacken; to tarnish.

SMUT, *v. i.* To gather smut; to be  
converted into smut.

SMUTCH, *v. t.* [from *smoke; Dan.*  
*smöger. Qu.*] To blacken with smoke,  
soot, or coal.

SMUTCH'ED, *a.* Blackened with smoke,  
or other foul matter.

SMUT'MILL, *n.* A machine for cleaus-  
ing grain from smut or mildew.

SMUT'TILY, *adv.* Blackly; smokily;  
foully.—2. With obscene language.

SMUT'TINESS, *n.* Soil from smoke,  
soot, coal, or smut.—2. Obsceneness  
of language.

SMUT'TY, *a.* Soiled with smut, coal,  
soot, or the like.—2. Tainted with mil-  
dew; as, *smutty* corn.—3. Obscene; not  
modest or pure; as, *smutty* language.

SMYR'NIUM, *n.* A genus of plants,  
nat. order Umbelliferae. The species  
are upright smooth biennials, with  
fleshy roots, various leaves, terminal  
umbels, and variable involucre. The  
flowers are yellow or yellowish green,  
and are frequently polygamous.—*S.*  
*olusatrum*, or common Alexanders, is  
found in Britain, and is observed most  
frequently near the coast. It was

formerly much eaten in Europe, both as a salad and potherb. *S. perfoliatum*, or perfoliate Alexanders, is a native of Greece, Spain, Italy, and Dalmatia.

**SMYTT'ERIE**, *n.* A numerous collection of small individuals. [*Scotch.*]

**SNACK**, *n.* 1. A share. It is now chiefly or wholly used in the phrase, to go *snacks* with one, that is, to have a share.—2. A slight hasty repast.

**SNACK'ET**, } *n.* The hasp of a case-  
**SNECK'ET**, } *ment.* [*Local.*]

**SNAF'FLE**, *n.* [*D. sneb, snavel, bill, beak, snout; G. Dan. and Sw. snabel;* from the root of *nib, neb.*] A bridle consisting of a slender bit-mouth with a single rein, and without a curb.

**SNAF'FLE**, *v. t.* To bridle; to hold or manage with a bridle.

**SNAG**, *n.* A short branch, or a sharp or rough branch; a shoot; a knot; the stumpy base of a branch left in pruning.—*Snag-pruning*, pruning or cutting off branches, so as to leave snags.

The coat of arms

Now on a naked *snag* in triumph borne.

*Dryden.*

2. A tooth, in contempt; or a tooth projecting beyond the rest.—3. In the western rivers of the *United States*, the trunk of a large tree firmly fixed to the bottom at one end, and rising nearly or quite to the surface at the other end, by which steamboats, &c., are often pierced and sunk.

**SNAG**, *v. t.* To run against the branches of a sunken tree, as in American rivers.

**SNAG'GED**, *pp.* Run against a snag, or branch of a sunken tree.

**SNAG'GED**, } *a.* Full of snags; full of  
**SNAG'GY**, } short rough branches or sharp points; abounding with knots; as, a *snaggy* tree; a *snaggy* stick; a *snaggy* oak.

**SNAIL**, *n.* [*Sax. snægel, snegel; G. schnecke;* dim. from the root of *snake, sneak.*] 1. The English name for those slimy, slow-crawling molluscs, also called slugs (*Limax*, Linn.), and shell-snails (*Helix*, Linn.). The shell-snails have a shell composed of carbonate of lime, combined with coagulated albumen, secreted by the skin of the insect, the mouth of the shell being extended by layers of the substance to the margin. The head is furnished with four horns or tentacula; and on the superior pair, at the extremity, the eyes are placed. Both the upper and lower tentacula are retractile, and can be completely inverted so as to be drawn into the interior of the body. Some snails are terrestrial, others are aquatic, but are compelled to visit the surface of the water from time to time for the purpose of respiring. Cuvier arranges snails under *Pulmonea*, his first order of gastropodous molluscs. [*See SLUG.*]—2. A drone; a slow-moving person.

**SNAIL-CLOVER**, } *n.* A plant of the  
**SNAIL-TREFOIL**, } genus *Medicago*, the *M. scutellata*, Linn.

**SNAIL-FLOWER**, *n.* A plant of the genus *Phaseolus*, the *P. caracalla*, Linn.

**SNAIL-LIKE**, *a.* Resembling a snail; moving very slowly.

**SNAIL-LIKE**, *adv.* In the manner of a snail; slowly.

**SNAKE**, *n.* [*Sax. snaca; G. schneke; Sans. naga. Qu.*] In *G. schnecke*, *Dan. snekke*, is a snail, from the root of *Dan. smiger, Ir. snaighim, Sax. suican*, to creep, to *sneak.*] A name

commonly given to any serpent, but more particularly used to designate the common snake, the *Natrix torquata*

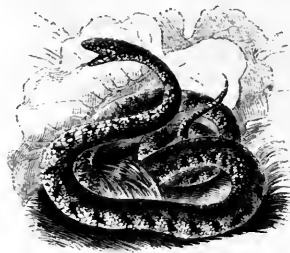

Common Snake (*Natrix torquata*).

of Ray, and the *Coluber natrix* of Linn. It is destitute of poison-fangs, and its food consists of lizards, young birds, bird's eggs, mice, and more particularly frogs. It inhabits Europe from Scotland, and the corresponding latitude on the continent, to Italy and Sicily.

**SNAKE**, *v. t.* In *seamen's lan.*, to wind a small rope round a large one spirally, the small ropes lying in the spaces between the strands of the large one. This is called also *worming*.

**SNAKEISH**, *a.* Having the qualities of a snake.

**SNAKEROOT**, *n.* [*snake and root.*]

The popular name of a plant of the genus *Aristolochia*, the *A. serpentaria*, nat. order *Aristolochiaceae*, of which it is the type. It is a native of Virginia, and is widely diffused throughout the United States. It has a fibrous, aromatic, and bitterish root, which was formerly extolled as a cure for the bite of the rattle-snake and other serpents. The infusion is occasionally used as a tonic and diaphoretic. In typhoid fevers, it is a good adjunct to Peruvian bark and to quinia. The Virginian snake-root is the *Polygala senega*,—*which see.* The number of plants called by the name of *snake-root*, in America, is far too great for enumeration in this place.

**SNAKE'S-HEAD**, *n.* In the *U. States*, a trivial name for a rail bar loosened from its hold-fasts, and rising up at one end, to the great danger of travellers.

**SNAKE'S HEAD**, *n.* The English name of a species of *Fritillaria*, the *F. meleagris*. [*See FRITILLARY.*]

**SNAKE'S-HEAD IRIS**, *n.* A plant, *Iris tuberosa*. It has long, narrow, four cornered leaves, and a dark purple flower, which appears in April. It is a native of the Levant, and also grows wild in England. [*See IRIS.*]

**SNAKE-STONES**, *n.* A popular name of those fossils, otherwise called *Ammonites*.

**SNAKEWEED**, *n.* [*snake and weed.*] A plant, bistort, of the genus *Polygonum*, the *P. bistorta*, a British plant which grows in pastures. [*See POLYGONUM.*]

**SNAKE-WOOD**, *n.* [*snake and wood.*] The wood of the *Strychnos colubrina*, a tree growing in the isle of Timor and other parts of the East, having a bitter taste, and supposed to be a certain remedy for the bite of the hooded serpent. [*See STRYCHNOS.*] This name is also applied to the *Demerara* letter wood, *Piratinera guianensis*.

**SNÄKING**, *ppr.* Winding small ropes spirally round a large one.

**SNÄK'ISH**, *a.* Having a snake-like form; habits, or qualities.

**SNÄKY**, *a.* Pertaining to a snake or to snakes; resembling a snake; serpentine; winding.—2. Sly; cunning; insinuating; deceitful.

So to the coast of Jordan he directs  
His easy steps, girded with *snaky* wiles.  
*Milton.*

3. Having serpents; as, a *snaky* rod or wand.

That *snaky* headed gorgon shield.

*Milton.*

**SNAP**, *v. t.* [*D. snappen, snaawen; G. schnappen*, to snap, to snatch, to gasp or catch for breath; from the root of *hnap* and *D. knippen.*] 1. To break at once; to break short; as, substances that are brittle.

Breaks the doors open, *snaps* the locks.

*Prior.*

2. To strike with a sharp sound.—3. To bite or seize suddenly with the teeth.—4. To break upon suddenly with sharp, angry words.—5. To crack; as, to *snap* a whip.—To *snap off*; to break suddenly.—2. To bite off suddenly.—To *snap one up*, to *snap one up short*, to treat with sharp words. [*Familiar.*]

**SNAP**, *v. i.* To break short; to part asunder suddenly; as, a mast or spar *snaps*; a needle *snaps*.

If steel is too hard, that is, too brittle, with the least bending it will *snap*.

*Moxon.*

2. To make an effort to bite; to aim to seize with the teeth; as, a dog *snaps* at a passenger; a fish *snaps* at the bait.—3. To utter sharp, harsh, angry words.

**SNAP**, *n.* A sudden breaking or rupture of any substance.—2. A sudden, eager bite; a sudden seizing or effort to seize with the teeth.—3. A crack of a whip.—4. A greedy follow.—5. A catch; a theft.—6. A catch or small lock.

**SNAP'DRAGON**, *n.* Antirrhinum, a genus of plants of the class *Didymamia*, and order *angiosperma*, Linn.; nat. order *Scrophulariaceae*. The great snap-dragon (*A. majus*), and small snap-dragon (*A. orontium*), are British species, the first grows on old walls, and the second in dry sandy fields.—2. A play in which raisins are snatched from burning brandy, and put into the mouth.—3. The thing eaten at snap-dragon.

**SNAPHANCE**, *n.* A kind of firelock.

**SNAP'PED**, *pp.* Broken abruptly; seized or bitten suddenly; cracked, as a whip.

**SNAP'PER**, *n.* One that snaps.

**SNAP'PISH**, *a.* Eager to bite; apt to snap; as, a *snappish* cur.—2. Peevish; sharp in reply; apt to speak angrily or tartly.

**SNAP'PISHLY**, *adv.* Peevishly; angrily; tartly.

**SNAP'PISHNESS**, *n.* The quality of being snappish; peevishness; tartness.

**SNAP'SACK**, *n.* A knapsack. [*Vulgar.*]

**SNAPT.** *See SNAPPED.*

**SNÄR**, } *v. i.* To snarl.

**SNÄRE**, *n.* [*Dan. snare; Dan. snøre*, a string or cord; *Sw. snüre*, a line; *snöra*, to lace.] 1. Any thing set to catch an animal; a gin; a net; a noose.—2. Any thing by which one is entangled, entrapped, or inveigled and brought into trouble; 1 Cor. vii.

A fool's lips are the *snare* of his soul; Prov. xviii.

**SNARE**, *v. t.* [*Dan. snarer.*] To catch with a snare; to catch or take by guile; to seduce; to inveigle; to surround or entangle by treachery or guile, by allurements, or enticements; to bring into unexpected evil, perplexity, or danger.

The wicked is *snared* in the work of his own hands; Ps. ix.

**SNARED**, *pp.* Entangled; unexpectedly involved in difficulty.

**SNARER**, *n.* One who lays snares or entangles.

**SNARING**, *ppr.* Entangling; ensnaring. **SNARL**, *v. i.* [*G. schnarren*, to snarl, to speak in the throat; *D. snar*, snappish. This word seems to be allied to *gnarl*, and to proceed from some root signifying to twist, bind, or fasten, or to involve, entangle, and thus to be allied to *snare*.] 1. To growl, as an angry or surly dog; to gnarl; to utter grumbling sounds; but it expresses more violence than *grumble*.

That I should *snarl* and bite and play the dog. *Shak.*

2. To speak roughly; to talk in rude, murmuring terms.

It is malicious and unmanly to *snarl* at the little lapses of a pen, from which Virgil himself stands not exempted. *Dryden.*

**SNARL**, *† v. t.* To entangle; to complicate; to involve in knots; as, to *snarl* the hair; to *snarl* a skein of thread.—2. *†* To embarrass.

**SNARL**, *† n.* Entanglement; a knot or complication of hair, thread, &c., which it is difficult to disentangle.

**SNARLER**, *n.* One who snarls; a surly, growling animal; a grumbling, quarrelsome fellow.

**SNARLING**, *ppr.* Growling; grumbling angrily.—2. *†* Entangling.

**SNARLING**, *n.* A mode of raising hollow works in sheet metal, such as narrow vases, by repercussion, where the hammer, from the narrowness of the vessel, cannot be applied directly. **SNARLING-IRON**, *n.* An iron tool used in the operation of snarling. It consists of a straight arm with an up-turned end. This is introduced into the vessel to be operated on with the end bearing upon the part to be raised or expanded, and blows struck on the end which is without the vessel cause the other end to act on it by repercussion.

**SNARY**, *a.* [*from snare.*] Entangling; insidious.

Spiders in the vault their *snary* webs have spread. *Dryden.*

**SNASH**, *v. i.* To talk saucily; to bandy insolent language. As a noun, it signifies abuse; pert or snarling language. [*Scotch.*]

**SNAST**, *† n.* [*G. schnautze*, a snout.] The snuff of a candle.

**SNATCH**, *v. t.* pret. and *pp.* *Snatched* or *Snatcht*. [*D. snakken*, to grasp, to catch for breath.] 1. To seize hastily or abruptly.

When half our knowledge we must *snatch*, not take. *Pope.*

2. To seize without permission or ceremony; as, to *snatch* a kiss.—3. To seize and transport away; as, *snatch* me to heaven.

**SNATCH**, *v. i.* To catch at; to attempt to seize suddenly.

Nay, the ladies too will be *snatching*. *Shak.*  
He shall *snatch* on the right hand, and be hungry; Is. ix.

**SNATCH**, *n.* A hasty catch or seizing.—2. A catching at or attempt to seize suddenly.—3. A short fit of vigorous

action; as, a *snatch* at weeding after a shower.—4. A broken or interrupted action; a short fit or turn.

They move by fits and *snatches*. *Wilkins.*  
We have often little *snatches* of sunshine. *Spectator.*

5. A shuffling answer. [*Little used.*]

**SNATCH-BLOCK**, *n.* A particular kind of block used in ships, having an opening in one side to receive the bight of a rope. It is chiefly used for heavy purchases, where a warp or hawser is brought to the capstan. It is also called a *rouse-about-block*.



Snatch-Block.

**SNATCH'ED**, *pp.* Seized suddenly and violently.

**SNATCH'ER**, *n.* One that snatches or takes abruptly.

**SNATCH'ING**, *ppr.* Seizing hastily or abruptly; catching at.

**SNATCH'INGLY**, *adv.* By snatching; hastily; abruptly.

**SNATH**, or **SNATH**, *n.* [*Sax. snæd*; *Eng. snathe*, *snath*.] The handle of a scythe. [*Obsolete or local.*]

**SNATHE**, *† v. t.* [*Sax. snidan*, *smithan*.] To lop; to prune.

**SNAT'TOCK**, *n.* [*supra.*] A chip; a slice. [*Local.*]

**SNEAD**, *n.* A ligament; a line or string.—2. A handle for a scythe. [*Both local. See SNATH, SNEED.*]

**SNEAK**, *v. i.* [*Sax. snican*; *Dan. sniger*, to creep or move softly. *See SNAKE.*]

1. To creep or steal away privately; to withdraw meanly, as a person afraid or ashamed to be seen; as, to *sneak* away from company; to *sneak* into a corner or behind a screen.

You skulk'd behind the fence, and *sneaked* away. *Dryden.*

2. To behave with meanness and servility; to crouch; to truckle.

Will *sneaks* a scriv'ner, an exceeding knave. *Pope.*

**SNEAK**, *† v. t.* To hide.

**SNEAK**, *n.* A mean fellow.

**SNEAKER**, *n.* A small vessel of drink. [*Local.*]

**SNEAKING**, *ppr.* Creeping away slyly; stealing away.—2. *a.* Mean; servile; crouching.—3. Meanly parsimonious; covetous; niggardly.

**SNEAKINGLY**, *adv.* In a sneaking manner; meanly.

**SNEAKINGNESS**, *n.* Meanness; niggardliness.

**SNEAK'SBY**, *n.* A paltry fellow. [*Familiar.*]

**SNEAK-UP**, *† n.* A sneaking, cowardly, insidious fellow.

**SNEAP**, *v. t.* [*Dan. snibbe*, reproach, reprimand; *snip*, the end or point of a thing; *D. snip*, a snipe, from its bill; *snippen*, to snip or nip; *G. schneppe*, a peak; from the root of *neb*, *nib*, *nip*, with the sense of shooting out, thrusting like a sharp point.] 1. *†* To check; to reprove abruptly; to reprimand.—2. *†* To nip.

**SNEB**, *v. t.* To check; to reprimand. [*The same as Sneap.*]

**SNECK**, or **SNICK**, *n.* The latch of a door. [*Scotch.*]

**SNEED**, **SNEAD**, or **SNEED**, *n.* The handle of a scythe. [*Obsolete or local in England, but used in Scotland.*]

**SNEER**, *v. i.* [*from the root of L. naris*, nose; to turn up the nose.] 1. To show contempt by turning up the nose, or by a particular cast of countenance;

"naso suspendere aduncum"—2. To insinuate contempt by a covert expression.

I could be content to be a little *sneered* at. *Pope.*

3. To utter with grimace.—4. To show mirth awkwardly.

**SNEER**, *v. t.* To treat with sneers; to treat with a sort of contempt.

**SNEER**, *n.* A look of contempt, or a turning up of the nose to manifest contempt; a look of disdain, derision, or ridicule.—2. An expression of ludicrous scorn.

**SNEERER**, *n.* One that sneers.

**SNEERFUL**, *† a.* Given to sneering.

**SNEERING**, *ppr.* Manifesting contempt or scorn by turning up the nose, or by some grimace or significant look.

**SNEERINGLY**, *adv.* With a look of contempt or scorn.

**SNEESH'IN**, *n.* [*from sneezing.*] Snuff. [*Scotch.*]

**SNEEZE**, *v. i.* [*Sax. niesan*; *G. niesen*; *Sw. nysa*; from the root of *nose*, *G. nase*, *L. nasus*; the primary sense of which is to project.] To emit air through the nose audibly and violently, by a kind of involuntary convulsive force, occasioned by irritation of the inner membrane of the nose. Thus snuff, or any thing that tickles the nose, makes one *sneeze*.

**SNEEZE**, *n.* A sudden and violent ejection of air through the nose with an audible sound.

**SNEEZE-WÖRT**, *n.* A plant of the genus *Achillea*, the *A. ptarmica*, called also goose-tongue. [*See MILFOIL.*] It is so called because the dried flowers and roots, when powdered and applied to the nose, cause sneezing.

**SNEEZING**, *ppr.* Emitting air from the nose audibly.

**SNEEZING**, *n.* The act of ejecting air violently and audibly through the nose; sternutation.

**SNEEZING**, *n.* A convulsive action of the respiratory organs, brought on commonly by irritation of the nostrils. It is preceded by a deep inspiration, which fills the lungs, and then forces the air violently through the nose. Sneezing, produced in the ordinary way, is a natural and healthy action, intended to throw off instinctively from the delicate membrane of the nostrils whatever irritable or offensive material may chance to be lodged there. When it becomes violent, recourse must be had to soothing the nasal membrane by the application of warm milk and water, or decoction of poppies.

**SNEEL**, *† a.* [*Sax. snel.*] Active; brisk; nimble; keen; piercing; as, *sneel* blows the wintry wind. [*Scotch.*]

**SNET**, *n.* The fat of a deer. [*Local among sportsmen.*]

**SNEW**, *† old pret. of Snow.*

**SNIB**, to nip or reprimand, is only a different spelling of *Sneb*, *Sneap*.

**SNICK**, *† n.* A small cut or mark; a latch.—*Snick* and *snee*, a combat with knives. [*Snee* is a Dutch contraction of *snijden*, to cut.]

**SNICK'ER**, or **SNIG'GER**, *v. i.* To laugh in a half-suppressed manner; to laugh with audible catches of voice; as when one attempts to suppress loud laughter. [*Vulgar and local.*]

**SNIFF**, *v. i.* To draw air audibly up the nose. [*See SNUFF.*]

**SNIFF**, *† v. t.* To draw in with the breath through the nose.

**SNIFF**, *† n.* Perception by the nose.

**SNIFT**, *† v. i.* To snort.

**SNIFTING-VALVE, n.** A valve in the cylinder of a steam-engine, for the escape of air; so called from the peculiar noise it makes.

**SNIG, n.** [See SNAKE.] A kind of eel. [Local.]

**SNIG'GLE, v. i.** [supra.] To fish for eels, by thrusting the bait into their holes. [Local.]

**SNIG'GLE, v. t.** To snare; to catch.

**SNIP, v. t.** [D. *snippen*; to nip; *knippen*, to clip. See SNEAP.] To clip; to cut off the nib or neb, or to cut off at once with shears or scissors.

**SNIP, n.** A clip; a single cut with shears or scissors.—2. A small shred.—3. Share; a snack. [A low word.]—4. A cant name for a tailor.

**SNIPE, n.** [D. *snip*; G. *schnepfe*; from *neb*, *nib*; so named from its bill.] 1. The English name for those gullatorial birds which form the genus *Gallinago* of Stephens. The common snipe (*Scolopax gallinago*, Linn.) is plentiful in



Common Snipe (*Scolopax gallinago*).

most parts of Britain, and frequents marshes, moist meadows, and in frosty weather the edges of rushy hills. It feeds on worms, insects, and small molluscs. It is remarkable for the length of its bill, its peculiar cry, and the drumming-like noise it makes in summer.—2. A fool; a blockhead.

**SNIPE'S-BILL PLANE, n.** In *joinery*, a plane with a sharp aris for forming the quirks of mouldings.

**SNIPPER, or SNIP, n.** One that snips or clips; a tailor. [Trivial.]

**SNIP PET, † n.** A small part or share.

**SNIP'PING, ppr.** Clipping; cutting off with shears or scissors.

**SNIP'SNAP, a cant word** formed by repeating *snap*, and signifying a tart dialogue with quick replies.

**SNITE, † n.** [Sax.] A snipe.

**SNITE, v. t.** [Sax. *snytan*.] To blow the nose. In *Scot.*, *suite* the candle; to snuff it.

**SNIVEL, n.** (sniv'l.) [Sax. *snofel*, *snyfling*. Qu. *neb*, *nib*, *snuff*.] Snout; mucus running from the nose.

**SNIVEL, v. i.** To run at the nose.—2. To cry as children, with snuffling or snivelling.

**SNIVELLER, n.** One that cries with snivelling.—2. One that weeps for slight causes, or manifests weakness, by weeping.

**SNIVELLING, n.** A crying or speaking as through the nose.

**SNIVELLY, a.** Running at the nose; pitiful; whining.

**SNOB, n.** A trivial name for a shoemaker.—2. A term of contempt, used by some English collegians, for a townsman; and, by recent extension, popularly applied to a vulgar pretending man.

**SNOB'BISH, a.** Belonging to or re-

sembling a snob; or being vulgarly ostentatious.

**SNOD, n.** [Sax.] A fillet; a head band; called in Scotland a *snood*.

**SNOD, a.** Trimmed; smooth. [Scotch.]

**SNOOK, † v. t.** [Sw. *snoka*. Qu. *nook*.] To lurk; to lie in ambush.

**SNOOL, v. t.** [Qu. from *Scot. snell*, as signifying severe.] To subjugate or govern by authority; to keep under by tyrannical means. As a *verb intransitive*, to submit tamely; and as a *noun*, one who meanly subjects himself to the authority of another. [Scotch.]

**SNOOZE, n.** A nap or short sleep. [Familiar.]

**SNORE, v. i.** [Sax. *snora*, a snoring; D. *snorhen*; G. *schnarchen*; Sw. *snarka*; from the root of *L. naris*, the nose or nostrils.] To breathe with a rough hoarse noise in sleep; to breathe hard through the nose.

**SNORE, n.** A breathing with a harsh noise in sleep.

**SNORES, n.** One that snores.

**SNORING, ppr.** Respiring with a harsh noise.

**SNOORT, v. i.** [G. *schnarchen*. See SNORE.] 1. To force the air with violence through the nose, so as to make a noise, as high-spirited horses in prancing and play.—2. To snore. [Not common.]

**SNOORT, v. t.** To turn up, in anger, scorn, or derision, as the nose. [Unusual.]

**SNOORTER, n.** One that snorts; a snorer.

**SNOORTING, ppr.** Forcing the air violently through the nose.

**SNOORTING, n.** The act of forcing the air through the nose with violence and noise; Jer. viii.—2. Act of snoring. [Unusual.]

**SNOT, n.** [Sax. *snote*; D. *snot*; Dan. *id.*] Mucus discharged from the nose. [Vulgar.]

**SNOT, v. t.** [Sax. *snytan*.] To blow the nose.

**SNOTTER, v. i.** To snivel; to sob. [Local.]

**SNOTTER, n.** Among *seamen*, a short rope spliced together at the ends, and served with spun-yarn or covered with

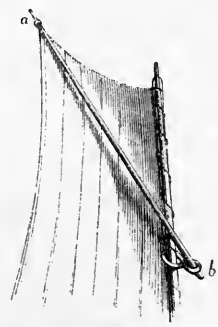

Sprit-aail.

a, Sprit reeving through the Snotter b.

hide. It is seized to the size of the mast, leaving a bight to fit the lower end of the sprit, which it confines to the mast.

**SNOTTY, a.** Foul with snot.—2. Mean; dirty. [Vulgar.]

**SNOUT, n.** [W. *ysnid*; D. *snuit*; G. *schnautze*, snout; *schmützen*, to snuff, to blow the nose, Sax. *snytan*; Sw. *snyte*, Dan. *snude*, snout; *snyder*, to

snuff.] 1. The long projecting nose of a beast, as that of swine.—2. The nose of a man; in contempt.—3. The nozzle or end of a hollow pipe.

**SNOUT, v. t.** To furnish with a nozzle or point.

**SNOUT'ED, a.** Having a snout.

**SNOUTY, a.** Resembling a beast's snout.

**SNOW, n.** [a contracted word; Sax-*snaw*; Goth. *snaiws*; G. *snee*; Ir-*sneacht*; Fr. *neige*; L. *nix*, *nivis*. The Latin *nivis*, is contracted from *nigis*, like Eng. *bove*, from Sax. *bugon*. The prefix *s* is common in the other languages.] 1. Frozen vapour; watery particles congealed into white crystals in the air, and falling to the earth. Snow is formed in the air, when the temperature of the atmosphere sinks below the freezing point. The particles of moisture contained in the atmosphere are then frozen, and form flakes, which descend to the earth. These have great diversities of density, and display innumerable varieties of the most beautiful forms. Generally speaking, when examined by the microscope, they present modifications of stelliform and hexagonal crystals; and frequently they consist of a star of six rays, formed of prisms united at angles of 60°, from which other prisms shoot

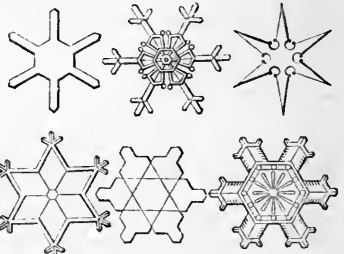

Crystals of Snow.

at similar angles, giving the whole an appearance of exquisite beauty and great regularity. Sometimes, however, snow presents no traces of crystallization, but falls in a fine powder; and in this case it is supposed to have been formed near the surface of the earth. The bulk of new-fallen snow is about ten or twelve times greater than that of the water obtained by melting it. Snow answers many valuable purposes in the economy of nature. Accumulated upon high regions, it serves to feed, by its gradual melting, streams of running water, which a sudden increase of water, in the form of rain, would convert into destructive torrents or standing pools; and in many countries it tempers the burning heats of summer by cooling the breezes which pass over it. In severer climates it serves as a defence against the rigours of winter, by protecting vegetation from the frost, and by affording a shelter to animals which bury themselves under it. Even in more temperate climates it is found that vegetation suffers more from an open winter than when the fields, during that season, lie hid beneath a snowy covering; for as snow is a slow conductor of heat, a coating of it prevents the earth from parting quickly with its warmth, and at the same time protects it from the cold of the atmosphere.—Red

*snow*, snow of a red tint, which appears to be met with in all parts of the world. The colouring matter of this substance is not clearly ascertained, some considering it to proceed from a species of red alga, *Protococcus nivalis*, and others referring it to the presence of an animalcule, *Philodina roseola*, and others again refer it to both of these causes. [See HAIL.]—2. A vessel equipped with two masts, resembling



SNOW.

the main and fore masts of a ship, and a third small mast just abaft the main-mast, carrying a try-sail.

**SNOW**, *v. i.* [Sax. *snawan*.] To fall in snow; as, it *snows*; it *snowed* yesterday.

**SNOW**, *v. t.* To scatter like snow.

**SNOW-BALL**, *n.* [*snow* and *ball*.] A round mass of snow, pressed or rolled together.

**SNOW-BALL TREE**, *n.* A flowering shrub of the genus *Viburnum*, the *V. opulus*, or *quelder rose*. [See GUELDER ROSE, *VIBURNUM*.]

**SNOW-BIRD**, } *n.* Popular names  
**SNOW-BUNTING**, } of *Emberiza nivalis*, or *Plectrophanes nivalis*, a gregarious bird which is a native of the arctic regions. In winter it visits Britain and other temperate regions, and is supposed to be the harbinger of severe weather. On its first arrival in this country it is very lean, but quickly grows fat, and is then excellent eating. It sings very sweetly, sitting on the ground; and does not perch, but runs about like the lark. Several other birds which make their appearance in winter are popularly called *snow-birds*; as, the *Fringilla nivalis* of Europe and the *Fringilla hiemalis* of America.

**SNOW-BROTH**, *n.* [*snow* and *broth*.]

Snow and water mixed; very cold liquor.

**SNOW-CAPPED**, or **SNOW-CAPT**, *a.* Capped or crowned with snow.

**SNOW-CROWNED**, *a.* [*snow* and *crown*.] Crowned or having the top covered with snow.

**SNOW-DEEP**, *n.* [*snow* and *deep*.] A plant.

**SNOW-DRIFT**, *n.* [*snow* and *drift*.] A bank of snow driven together by the wind.

**SNOW-DROP**, *n.* [*snow* and *drop*.] A well-known garden plant of the genus *Galanthus*, the *G. nivalis*, nat. order Amaryllidaceæ. It bears solitary, drooping, and elegant flowers, which appear in February. It is a native of Britain, and found in woods, orchards, meadows, pastures, &c.

**SNOW-FED**, *a.* Originated or augmented by melted snow; as, a *snow-fed* stream.

**SNOW-FLAKE**, *n.* A small mass of falling snow.

**SNOW-FLAKE**, *n.* A British plant, of the genus *Lencojun*, the *L. æstivum*, with a bulbous root, and white drooping flowers, which appear in May. It grows in moist meadows. [See *LEUCOCJUM*.]

**SNOW-FLECK**, *n.* The snow-hunting.

**SNOW-FLOOD**, *n.* A flood from melted snow.

**SNOWLESS**, *a.* Destitute of snow.

**SNOWLIKE**, *a.* Resembling snow.

**SNOW-LINE**, *n.* The limit of perpetual snow, or the elevation at which mountains are covered with perpetual snow. As the temperature of the atmosphere continually diminishes, as we ascend, from the lower into the higher strata, there must be in every latitude a certain limit of elevation at which the temperature of the air is reduced to the freezing point. This limit is called the snow line, or line of perpetual congelation, and the mountains which rise above it are always covered with snow. The *snow line* varies according to latitude, being highest near the equator and lowest near the poles. Local circumstances also affect it, as the configuration of the country, the quantity of snow falling annually, &c. From these circumstances, the snow line is at different heights in the same latitude, and the fact of a mountain being perpetually covered with snow is no sure indication of its height.

**SNOW-PLOUGH**, *n.* A simple machine, operating like a plough, but upon a much larger scale, for clearing away the snow from roads. It usually consists of boards framed together, so as to form an acute angle in front, and spread out behind to any required distance. The angular point or edge is made to enter the snow, and the machine being propelled by horses harnessed to the centre framework, the snow is thrown off by the boards to the sides of the road, and thus a free passage is opened up for wheel-carriages, &c. The same name is given to an instrument or machine to be driven before a locomotive, for throwing snow from a railway and clearing the rails.

**SNOW-SHOE**, *n.* [*snow* and *shoe*.] A shoe or racket worn by men travelling



Snow-Shoe.

on snow, to prevent their feet from sinking into the snow.

**SNOW-SLIP**, *n.* [*snow* and *slip*.] A large mass of snow which slips down the side of a mountain, and sometimes buries houses.

**SNOW-STORM**, *n.* A storm with falling snow.

**SNOW-WATER**, *n.* Water produced from the melting of snow. It is found to contain more oxygen than rain or river water; and, hence, it causes iron to rust more rapidly.

**SNOW-WHITE**, *a.* [*snow* and *white*.] White as snow; very white.

**SNOW-WREATH**, *n.* A deposit of snow.

**SNOWY**, *a.* White like snow.—2. Abounding with snow; covered with snow.

The *snowy* top of cold Olympus. *Milton*. 3. White; pure; unblemished.

**SNUB**, *† n.* [D. *sneb*; a different orthography of *snip*, *sneap*, *neb*, *nib*, *nip*.] A knot or protuberance in wood; a snag. **SNUB**, *v. t.* [*supra*.] To nip; to clip or break off the end. Hence,—2. To check; to reprimand; to check, stop, or rebuke with a tart sarcastic reply or remark. [This is the same word radically as *sneap*, *sneb*, and is the word chiefly used.]

**SNUB**, *v. t.* To snub a cable or rope, in *sea lan*, is to check it suddenly in running out.

**SNUB**, *† v. i.* [G. *schnauben*, to snub, to snort, to pant for, to puff.] To sob with convulsions.

**SNUB'BING**, *n.* Among *seamen*, a term used to denote the method of checking the sudden jerk of the cable or hawser, after the anchor is let go, or otherwise.

**SNUB-NOSE**, *n.* A short or flat nose.

**SNUB-NOSED**, *a.* Having a short, flat nose.

**SNUDGE**, *v. i.* [Dan. *sniger*. See *SNUG*.] To lie close; to snug. [Not in use or vulgar.]

**SNUDGE**, *† n.* A miser, or a sneaking fellow.

**SNUFF**, *n.* [D. *snuff*, whence *snuffen*, to snuff, to scent; G. *schnuppe*; allied to *snub*, *neb*, *nib*.] 1. The burning part of a candle wick, or that which has been charred by the flame, whether burning or not.—2. A candle almost burnt out.—3. Pulverized tobacco and various other powders, taken or prepared to be taken into the nose. Tobacco is the usual basis of snuff; but small quantities of other articles are frequently added to it, to vary its pungency, flavour, scent, &c. In fact the varieties and names of snuff are innumerable and are perpetually changing. There are, however, three principal sorts, the first, granulated; the second, an impalpable powder; and the third, the bran or coarse part remaining after sifting the second sort. *Snuff* for medicinal purposes, constituting a sternutatory, has been made from *Asarum Europæum*.—4. Resentment; huff; expressed by a snuffing of the nose.—To take a thing in snuff, is to be angry at it.

**SNUFF**, *v. t.* [D. *snuffen*; G. *schnuffen*, to take snuff; *schnuppen*, to snuff a candle.] 1. To draw in with the breath; to inhale; as, to *snuff* the wind.—2. To scent; to smell; to perceive by the nose.—3. To crop the snuff, as of a candle; to take off the end of the snuff.

**SNUFF**, *v. i.* To snort; to inhale air with violence or with noise; as dogs and horses.—2. To turn up the nose and inhale air in contempt; *Mal. ii.*—3. To take offence.

**SNUFF-BOX**, *n.* A box for carrying snuff about the person. Snuff boxes are made of every variety of pattern, and of an endless variety of materials.

**SNUFF'ER**, *n.* One that snuffs. [Un-usual.]

**SNUFF'ERS**, *n. plur.* An instrument for cropping the snuff of a candle.

**SNUFF'ING**, *ppr.* Drawing in with the breath; scenting.—2. Cropping the snuff, as of a candle.

**SNUFF'ING**, *n.* The act of snuffing.

**SNUFFLE**, *v. i.* [*D. snuffelen*; *G. nuffeln* and *schnuffeln*; *Dan. snüveler*, to snuffle, to give a crabbed answer, to snub.] To speak through the nose; to breathe hard through the nose when obstructed.

Some senseless Phyllis, in a broken note,  
Snuffling at nose. *Dryden.*

**SNUFFLER**, *n.* One that snuffles or speaks through the nose when obstructed.

**SNUFFLES**, *n.* Obstruction of the nose by mucus.—2. A malady of dogs.

**SNUFFLING**, *n.* A speaking through the nose.

**SNUFF-TAKER**, *n.* One that takes snuff, or inhales it into the nose.

**SNUFF-TAKING**, *n.* The act of taking or inhaling powdered tobacco.

**SNUFFY**, *a.* Soiled with snuff. [*Familiar.*]

**SNUG**, *v. i.* [*Dan. sniger*, to sneak; *Sax. snican*, to creep; probably allied to *nigh*, close. See **SNAKE**.] To lie close; as, a child *snugs* to its mother or nurse.

**SNUG**, *a.* [*Sw. snygg*, neat.] 1. Lying close; closely pressed; as, an infant lies *snug*.—2. Close; concealed; not exposed to notice.

At Will's

Lie *snug*, and hear what critics say. *Swift.*

3. Being in good order; all convenient; neat; as, a *snug* little farm.—4. Close; neat; convenient; as, a *snug* house.—5. Silly or insidiously close.

When you lay *snug*, to snap young Damon's goat. *Dryden.*

**SNUGGERY**, *n.* A snug, warm habitation. [*Familiar.*]

**SNUGGLE**, *v. i.* [from *snug*.] To move one way and the other to get a close place; to lie close for convenience or warmth.

**SNUGLY**, *adv.* Closely; safely.

**SNUGNESS**, *n.* Closeness; the state of being neat or convenient.

**SNYING**, *n.* Among *ship-carpenters*, a term for a circular plank, placed edgewise, to work in the bows of a ship.

**SO**, *v. t.* Stand still; a word used in the imperative only, by milkmaids. [See *the next word*.]

**SO**, *adv.* [*Goth. swa*; *Sax. swa*; *G. so*; perhaps *L. sic*, contracted, or *Heb. שוה, shawah*, to compose, to set. In *Ir. so* is this or that. It is the same in *Scots*. It is from some root signifying to set, to still, and this sense is retained in the use of the word by milkmaids, who say to cows, *so, so*, that is, stand still, remain as you are; and in this use the word may be the original verb.] 1. In like manner, answering to *as*, and noting comparison or resemblance; *as* with the people, *so* with the priest.—2. In such a degree; to that degree.

Why is his chariot *so* long in coming? *Judges v.*

3. In such a manner; sometimes repeated *so* and *so*; as, certain colours, mingled *so* and *so*.—4. It is followed by *as*.

There is something equivalent in France and Scotland; *so as* it is a hard calumny upon our soil to affirm that so excellent a fruit will not grow here. *Temple.*

But in like phrases, we now use *that*; "*so that* it is a hard calumny;" and this may be considered as the established usage.—5. In the same manner.

Use your tutor with great respect, and cause all your family to do *so* too.

6. Thus; in this manner; as, New

York, *so* called from the Duke of York. I know not why it is, but *so* it is.

It concerns every man, with the greatest seriousness, to inquire whether these things are *so* or not. *Tillotson.*

7. Therefore; thus; for this reason; in consequence of this or that.

It leaves instruction, and *so* instructors, to the sobriety of the settled articles of the church. *Holyday.*

God makes him in his own image an intellectual creature, and *so* capable of dominion. *Locke.*

This statute made the clipping of coin high treason, which it was not at common law; *so* that this was an enlarging statute. *Blackstone.*

8. On these terms, noting a conditional petition.

Here then exchange we mutually forgiveness, *So* may the guilt of all my broken vows, *My* perjuries to thee be all forgotten. *Rowe.* *So* here might be expressed by *thus*, that is, in this manner, by this mutual forgiveness.—9. Provided that; on condition that. [*L. modo*.]

*So* the doctrine be but wholesome and edifying...though there should be a want of exactness in the manner of speaking and reasoning, it may be overlooked. *Atterbury.*

I care not who furnishes the means, *so* they are furnished. *Anon.*

10. In like manner, noting the concession of one proposition or fact and the assumption of another; answering to *as*.

*As* a war should be undertaken upon a just motive, *so* a prince ought to consider the condition he is in when he enters on it. *Swift.*

11. *So* often expresses the sense of a word or sentence going before. In this case it prevents a repetition, and may be considered as a substitute for the word or phrase. "France is highly cultivated, but England is more *so*," that is, *more highly cultivated*. To make men happy, and to keep them *so*. *Creech.*

12. Thus; thus it is; this is the state. How sorrow shakes him!

*So* now the tempest tears him up by the roots, *Dryden.*

13. Well; the fact being such. And *so* the work is done, is it?—14. It is sometimes used to express a certain degree, implying comparison, and yet without the corresponding word *as*, to render the degree definite.

An astringent is not quite *so* proper, where relaxing the urinary passages is necessary. *Arbutnot.*

That is, not perfectly proper, or not so proper as something else not specified.

—15. It is sometimes equivalent to *be it so, let it be so, let it be as it is, or in that manner*.

There is Percy; if your father will do me any honour, *so*; if not, let him kill the next Percy himself. *Shak.*

16. It expresses a wish, desire, or petition.

Ready are the appellant and defendant... *So* please your highness, to behold the fight. *Shak.*

17. *So much as*, however much. Instead of *so*, we now generally use *as*; *as much as*, that much; whatever the quantity may be.—18. *So so*, or *so* repeated, used as a kind of exclamation; equivalent to well, well; or it is so, the thing is done.

*So, so*, it works; now, mistress, sit you fast. *Dryden.*

19. *So so*, much as it was; indifferently; not well nor much amiss.

His leg is but *so so*. *Shak.*

20. *So then*, thus then it is; therefore; the consequence is.

*So then* the Volscians stand; but as at first Ready, when time shall prompt them, to make road

Upon's again. *Shak.*

21. *So forth*, more of the like kind; as, he complained much of the pressure of the times, the difficulty he had of procuring a subsistence, and *so forth*.

*Note*.—*So*, when it signifies, in like manner; in such manner; in this way; therefore; for this reason; provided that, is usually classed by grammarians among conjunctions.

**SOAK**, *v. t.* [*Sax. socian*; *W. swgaw*, to soak, and *sugaw*, to suck. To *soak* is to *suck* in; *G. saugen*, *Ar. sakai*, to imbibe, that is, to draw; *Ir. sughthach*, soaking. *Heb. Ch. and Syr. טָפַס, shakah.*] 1. To steep; to cause or suffer to lie in a fluid till the substance has imbibed what it can contain; to macerate in water or other fluid; as, to *soak* cloth; to *soak* bread.—2. To drench; to wet thoroughly. The earth is *soaked* with heavy rains.

Their land shall be *soaked* with blood; *Is. xxxiv.*

3. To draw in by the pores; as the skin.—4. To drain. [*Not authorized*.]

**SOAK**, *v. i.* To lie steeped in water or other fluid. Let the cloth lie and *soak*.

2. To enter into pores or interstices. Water *soaks* into the earth or other porous matter.—3. To drink intemperately or gluttonously; to drench; as, a *soaking* club. [*Low*.]

**SOAKED**, *pp.* Steeped or macerated in a fluid; drenched.

**SOAKER**, *n.* One that soaks or macerates in a liquid.—2. A hard drinker. [*Low*.]

**SOAKING**, *ppr.* Steeping; macerating; drenching; imbibing.—2. *a.* That wets thoroughly; as, a *soaking* rain.

**SOAKY**, or **SOCKY**, *a.* Moist on the surface; steeped in water; soggy.

**SOAL**, of a shoe. [See **SOLE**.]

**SOAP**, *n.* [*Sax. sape*; *G. seife*; *Fr. savon*; *L. sapo*; *Gr. σαπων*; *W. sebon*; *Hindo. sabon*, *savin*; *Pers. sabun*; *Ar. sabunon*.] A compound of fatty substances or of one or more of the *oil-acids*, more especially with the metallic alkalies *potassa* or *soda*, but also with some other salifiable bases. The most common *soaps* are either *margarates* or *oleates* of *potassa* or *soda*, made by boiling some common oil with the ley of wood-ashes; used in washing and cleansing, in medicine, &c. There are many different kinds of soaps, but those commonly employed may be divided into three classes; 1. Fine white soaps, scented soaps, &c.; 2. Coarse household soaps; 3. Soft soaps. White soaps are generally combinations of olive oil and carbonate of soda. Perfumes are occasionally added; or various colouring matters stirred in while the soap is semifluid. Common household soaps are made chiefly of soda and tallow. Yellow soap is composed of tallow, resin, and soda, to which some palm oil is occasionally added. Soft soaps are generally made with potash instead of soda, and fish-oil with the addition of a little tallow. Excellent soaps are made from palm-oil and soda. Soap is soluble in pure water and in alcohol; the latter solution jellies when concentrated; and is known in medicine under the name of *opodeldoc*, and when evaporated to dryness, it forms what is called trans-



parent soap. The earths and common metallic oxides form insoluble soaps, which possess no detergent power.

SOAP, *v. t.* [Sax. *sapan*; *G. seifen*.] To rub or wash over with soap.

SOAPBERRY-TREE, *n.* A tree of the genus *Sapindus*, the *S. saponaria*. [See *SAPINDUS*.]

SOAP-BOILER, *n.* [soap and boiler.] One whose occupation is to make soap.

SOAP-BOLL'ING, *n.* The business of boiling or manufacturing soap.

SOAPED, *pp.* Rubbed or washed with soap.

SOAPING, *ppr.* Rubbing or washing with soap.

SOAPSTONE, *n.* Steatite; a magnesian mineral, usually gray, white, or yellow; the *Lapis ollaris*.

SOAP-SUDS, *n.* Suds; water well impregnated with soap.

SOAPWORT, *n.* A plant of the genus *Saponaria*, the *S. officinalis*. [See *SAPONARIA*.]

SOAPY, *a.* Resembling soap; having the qualities of soap; soft and smooth. 2. Smeared with soap.

SOAK, *v. i.* [Fr. *essorer*, to soar; *essor*, flight; *It. sorare*; *Eth. sarar*, to fly, to be lofty.] 1. To fly aloft; to mount upon the wing; as an eagle. Hence, 2. To rise high; to mount; to tower in thought or imagination; to be sublime; as the poet or orator.—3. To rise high in ambition or heroism.

Valour soars above

What the world calls misfortune. *Addism.*

4. In general, to rise aloft; to be lofty.

SOAR, *n.* A towering flight; ascent.

SOARING, *ppr.* Mounting on the wing; rising aloft; towering in thought or mind. In *her.*, *soaring* or *soarant* signifies flying aloft.

SOARING, *n.* The act of mounting on the wing, or of towering in thought or mind; intellectual flight.

SOAVE, or SOAVEMEN'TE, [It. sweet, sweetly.] In *music*, a term signifying that the piece to which it is prefixed is to be executed with sweetness.

SOB, *v. i.* [Sax. *seobgend*, complaining. *Qu.*] To sigh with a sudden heaving of the breast, or a kind of convulsive motion; to sigh with deep sorrow or with tears.

She sigh'd, she sobb'd, and furious with despair,

She rent her garments, and she tore her hair. *Dryden.*

SOB, *n.* A convulsive sigh or catching of the breath in sorrow; a convulsive act of respiration obstructed by sorrow. Break heart, or choke with *sobs* my hated breath. *Dryden.*

SOB, *v. t.* To soak.

SOB'ING, *ppr.* Sighing with a heaving of the breast.

SOB'ING, *n.* Lamentation.

SOBER, *a.* [Fr. *sobre*; *L. sobrius*; *D. sober*, poor, mean, spare, sober; *Sax. sifer*, sober, pure, chaste. See *SOFT*.] 1. Temperate in the use of spirituous liquors; habitually temperate; particularly abstemious; as, a *sober* man.

Live a *sober*, righteous, and godly life.

*Com. Prayer.*

2. Not intoxicated or overpowered by spirituous liquors; not drunken. The sot may at times be *sober*.—3. Not mad or insane; not wild, visionary, or heated with passion; having the regular exercise of cool dispassionate reason.

There was not a *sober* person to be had; all was tempestuous and blustering.

*Dryden.*

No *sober* man would put himself in danger for the applause of escaping without breaking his neck. *Dryden.*

4. Regular; calm; not under the influence of passion; as, *sober* judgment; a man in his *sober* senses.—5. Serious; solemn; grave; as, the *sober* livery of autumn.

What parts gay France from *sober* Spain? *Prior.*

6. Consistent; devout; exemplary.

SOBER, *v. t.* To make sober; to cure of intoxication.

These shallow draughts intoxicate the brain,

And drinking largely *sobers* us again. *Pope.*

SOBERED, *pp.* Made sober.

SOBERIZE, *v. i.* To become sober.

SOBERIZE, *v. t.* To make sober.

SOBERLY, *adv.* Without intemperance.—2. Without enthusiasm.—3. Without intemperate passion; coolly; calmly; moderately.—4. Gravely; seriously.

SOBERMINDED, *a.* Having a disposition or temper habitually sober, calm, and temperate.

SOBERMINDEDNESS, *n.* Calmness; freedom from inordinate passions; habitual sobriety.

SOBERNESS, *n.* Freedom from intoxication; temperance.—2. Gravity; seriousness.—3. Freedom from heat and passion; calmness; coolness.

The *soberness* of Virgil might have shown him the difference. *Dryden.*

SOB'OLE, *n.* In *bot.*, a creeping stem, applied by De Candolle and Link to the *serculus* or sucker.

SOBOLIFEROUS, *a.* [Lat. *soboles*, a young shoot, and *fero*, to bear.] In *bot.*, producing young plants from a creeping stem or soboles underground.

SOBRIETY, *n.* [Fr. *sobriété*; *L. sobrietas*, from *sobrius*.] 1. Habitual sobriety or temperance in the use of spirituous liquors; as when we say, a man of *sobriety*.—2. Freedom from intoxication.

Public *sobriety* is a relative duty. *Blackstone.*

3. Habitual freedom from enthusiasm, inordinate passion, or overheated imagination; calmness; coolness; as, the *sobriety* of riper years; the *sobriety* of age.—4. Seriousness; gravity without sadness or melancholy.

Mirth makes them not mad, Nor *sobriety* sad. *Denham.*

SOBRIQUET', *n.* [Fr.] A nickname or a burlesque appellation for a by-name. [Often erroneously printed *soubriquet*.]

SOC, or SOKE, *n.* [Sax. *soc*, from *socan*, *secan*, to seek, to follow, *L. sequor*.] 1. Properly, the sequela, secta, or suit, or the body of suitors; hence, the power or privilege of holding a court in a district, as in a manor; jurisdiction of causes, and the limits of that jurisdiction.—2. Liberty or privilege of tenants exempted from customary burdens.—3. An exclusive privilege claimed by millers of grinding all the corn used within the manor in which the mill stands, or of being paid for the same as if actually ground. [Provincial.]

SOC'AGE, *n.* [from *soc*, supra, a privilege.] In *English law*, a tenure of lands and tenements by a certain or determinate service; a tenure distinct from chivalry or knight's service, in which the render was uncertain. The service must be certain, in order to be denominated *socage*; as to hold by fealty and twenty shillings rent. So-

cage is of two kinds; *free socage*, where the services are not only certain, but honourable; and *villain socage*, where the services, though certain, are of a baser nature.

SOC'AGER, *n.* A tenant by socage; a socman.

SO'-CALLED, *a.* So named.

SOC'COTRINE ALOES, *n.* The best kind of aloes, which are obtained from the leaves of the *aloe soccotrina*, Linn., a native of the Cape of Good Hope, and the Island of Soccotora, but now commonly cultivated in the West Indies. [See *ALOES*.]

SOCIABILITY; *n.* [Fr. *sociabilité*.] Sociableness; disposition to associate and converse with others; or the practice of familiar converse.

SO'CIABLE, *a.* [Fr. *sociable*; *L. sociabilis*, from *socius*, a companion, probably from *sequor*, to follow. See *SEEK*.] 1. That may be conjoined; fit to be united in one body or company; as, *sociable* parts united in one body.—2. Ready or disposed to unite in a general interest.

To make man mild, and *sociable* to man. *Addison.*

3. Ready and inclined to join in company or society; or frequently meeting for conversation; as, *sociable* neighbours.—4. Inclined to converse when in company; disposed to freedom in conversation; opposed to *reserved* and *taciturn*.—5. Free in conversation; conversing much or familiarly. The guests were very *sociable*.

SO'CIABLE, *n.* An open carriage with seats facing each other, and thus convenient for conversation; hence the name.

SO'CIABLENESS, *n.* Disposition to associate; inclination to company and converse; or actual frequent union in society or free converse. This word may signify either the disposition to associate, or the disposition to enter into familiar conversation, or the actual practice of associating and conversing.

SO'CIABLY, *adv.* In a sociable manner; with free intercourse; conversibly; familiarly; as a companion.

SOCIAL, *a.* [L. *socialis*, from *socius*, companion.] 1. Pertaining to society; relating to men living in society, or to the public as an aggregate body; as, *social* interests or concerns; *social* pleasures; *social* benefits; *social* happiness; *social* duties.

True self-love and *social* are the same. *Pope.*

2. Ready or disposed to mix in friendly converse; companionable.

Withers, adieu! yet not with thee remove Thy martial spirit or thy *social* love. *Pope.*

3. Friendly; consisting in union or mutual converse.—4. Disposed to unite in society. Man is a *social* being.—*Social statics*, that branch of sociology which treats of the conditions of the stability or equilibrium of the different parts of society, or the theory of the mutual action and reaction of contemporaneous social phenomena on each other, giving rise to what is called *social order*.—*Social dynamics*, that branch of sociology which treats of the conditions of the progress of society from one epoch to another. [See *SOCIOLOGY*.]

SO'CIALISM, *n.* A social state in which there is a community of property among all the individuals composing it, a state of things in which there are no individual or separate

rights in property. It is otherwise termed *agrarianism* and *communism*.

**SOC'IALIST, n.** One who advocates a community of property among all the citizens of a state. Some of this sect contend also for a community of females, or a promiscuous intercourse of the sexes; and they have likewise been accused of holding various other heterodox principles. They are also called Owenites from Robert Owen, one of the first promulgators of the social tenets in this country. In France, parties holding similar opinions are called Fourierists and St. Simonians, from Fourier and St. Simon, two noted socialist leaders. They are also called *communists*.

**SOCIALITY, n.** Socialness; the quality of being social.

**SOC'IALIZE, v. t.** To render social.—2. To form or regulate according to socialism.

**SOC'IALLY, adv.** In a social manner or way.

**SOC'IALNESS, n.** The quality of being social.

**SOC'CIATE, † v. i.** To associate.

**SOCIETY, n.** [Fr. *société*; L. *societas*, from *socius*, a companion. See **SOCIABLE**.] 1. The union of a number of rational beings; or a number of persons united, either for a temporary or permanent purpose. Thus the inhabitants of a state or of a city constitute a *society*, having common interests; and hence it is called a *community*. In a more enlarged sense, the whole race or family of man is a *society*, and called *human society*.

The true and natural foundations of *society*, are the wants and fears of individuals. *Blackstone*.

2. Any number of persons associated for a particular purpose, whether incorporated by law, or only united by articles of agreement; a fraternity. Thus we have bible *societies*, missionary *societies*, and charitable *societies* for various objects; *societies* of mechanics and learned *societies*; *societies* for encouraging arts, &c. Some kinds of societies are called *clubs*. [See **CLUB**, No. 4.]—3. Company; a temporary association of persons for profit or pleasure; for commercial purposes, for carrying on public enterprises, &c. In this sense, *company* is more generally used.—4. Company; fellowship. We frequent the *society* of those we love and esteem.—5. Partnership; fellowship; union on equal terms.

Among unequals what *society* can sort?

*Milton*.

Heaven's greatness no *society* can bear.

*Dryden*.

6. Persons living in the same neighbourhood, who frequently meet in company and have fellowship. Literary *society* renders a place interesting and agreeable.—7. In *Connecticut*, a number of families united and incorporated for the purpose of supporting public worship, is called an *ecclesiastical society*. In *Massachusetts*, such an incorporation is called a *parish*.

**SOCIN'IAN, a.** [from *Socinus*, a native of Sienna, in Tuscany, the founder of the sect of Socinians in the 16th century.] Pertaining to Socinus, or his religious creed.

**SOCIN'IAN, n.** One of the followers of Socinus. [See **UNITARIAN**.]

**SOCIN'IANISM, n.** The tenets or doctrines of Socinus, who held Christ to

have been a mere man inspired, denied his divinity and atonement, and the doctrine of original depravity.

**SOCIN'IANIZE, v. t.** To conform or adapt to Socinianism.

**SOCIOLOG'Y, n.** [L. *socius*, a companion, and Gr. *logos*, discourse.] Social science, or the science of society, according to the Positive Philosophy of M. Comte. It treats of the general structure of human society, the laws of its development, and the progress of actual civilization. Sociology is the most complex of all the sciences, and consists of derivative truths, verified by experience from psychology and the laws of ethology, or the science of the formation of character. The laws of social phenomena are nothing but the laws of the thoughts, feelings, and actions of men united together in the social state; and these laws are approximate generalizations obtained from the past history and present observation of all stages of civilization. And as men's thoughts, feelings, and actions are subject to fixed laws, that is, uniform sequences, so must also the phenomena of society, that is, of aggregates of men. The fundamental problem of society is to discover the laws by which any state of society produces the state which follows it, and takes its place, and to show by deduction that these laws are derivative from those of human nature. The subject matter of the sciences of man, and of society, is peculiar in varying from age to age, and in being progressive. The laws of human nature, and of the external circumstances in which men are placed, form their characters, and men themselves in turn mould and shape circumstances for themselves and their posterity. The institutions of a people are the results of their ideas, and as society advances, mental qualities tend more and more to prevail over bodily, and aggregates of men over individuals. The elements of permanent social union are education through life, which is always a restraining discipline, the feeling of allegiance or loyalty to something fixed and permanent, and a strong and active principle of nationality or union for common interest. Such are some of the leading principles of sociology; but to understand the science aright, it is necessary to have recourse to M. Comte's great work entitled "*Cours de Philosophie Positive*," and the last book of Mill's *System of Logic*.

**SOC'CIUS ERIMINIS, [L.]** A term in *Scots law*, signifying an accomplice or associate in the commission of a crime.

**SOCK, n.** [Sax. *socc*; L. *soccus*; G. *socke*; Fr. *socque*. Qu. L. *siccio*, to dry, Gr. *σακκος*, a bag.] 1. The shoe of the ancient actors of comedy. Hence the word is used for comedy, and opposed to *bushin* or tragedy.

Great Fletcher never trends in buskin here,  
Nor greater Jonson dares in *socks* appear.

*Dryden*.

2. A garment for the foot, like the foot of a stocking; a short stocking.—3. A ploughshare.

**SOCKET, n.** [Ir. *soicead*.] 1. The little hollow tube or place in which a candle is fixed in the candlestick.

And in the *sockets* oily bubbles dance.

*Dryden*.

2. Any hollow thing or place which receives and holds something else; as,

the *sockets* of the teeth or of the eyes.

His eyeballs in their hollow *sockets* sink.

*Dryden*.

Gomphosis is the connection of a tooth to its *socket*.

*Wiseman*.

**SOCKET-CHISEL, n.** A chisel made with a socket; a stronger sort of chisel, used by carpenters for mortising, and worked with a mallet.

**SOCK'LESS, a.** Destitute of socks or shoes.

**SOC'CLE, n.** [See **SOCK**.] In *arch.*, a flat square member of less height than its horizontal dimension, serving to raise pedestals, or to support vases, or other ornaments. It differs from a pedestal in being without base or pedestal. A *continued socle* is one continued round a building.

**SOC'MAN, n.** [See **SOCAGE**.] One who holds lands or tenements by socage.

**SOC'MANRY, † n.** Tenure by socage.

**SOC'OME, † n.** A custom of tenants to grind corn at the lord's mill.

**SOC'OTRINE, a.** *Socotrine aloes*, a kind of aloes from Socotra, an isle in the Indian ocean. [See **SOCOTRINE**.]

**SOERATIC, } a.** Pertaining to SOERATICALLY, } *Socrates*, the Grecian sage, or to his language or manner of teaching and philosophizing. The *Socratic* method of reasoning and instruction was by interrogatories. Instead of laying down a proposition authoritatively, this method led the antagonist or disciple to acknowledge it himself by dint of a series of questions put to him. It was not the object of Socrates to establish any perfectly evolved system of doctrine, so much as to awaken by his discourses a new and more comprehensive pursuit of science, which should direct itself to all that is knowable. To him is ascribed two of the very first principles of science, namely, the inductive method and the definition of ideas.

**SOERATICALLY, adv.** In the Socratic method.

**SOERATISM, n.** The doctrines or philosophy of Socrates.

**SOERATIST, n.** A disciple of Socrates.

**SOD, n.** [D. *zood*; G. *sode*; W. *sodi*, to set.] Turf; sward; that stratum of earth on the surface which is filled with the roots of grass, or any portion of that surface. It differs from *clod*, which may be a compact mass of earth without roots; but *sod* is formed by earth held together with roots.

**SOD, a.** Made or consisting of sod.

**SOD, v. t.** To cover with sod; to turf.

**SOD, pret. of Seethe;** also the passive participle. [See **SODDEN**.]

**SODA, n** [G. *soda*; Sp. *soda* or *sosa*, glasswort, barilla.] 1. The protoxide of the metal sodium, formerly called, though not appropriately, mineral alkali. It has likewise been called a fixed alkali, in contradistinction from ammonia, which is a volatile alkali. Soda, or protoxide of sodium, is formed when sodium is burned in dry air or oxygen. It is a white powder, which attracts moisture and carbonic acid from the air. It consists of one equivalent of sodium, and one of oxygen. When this protoxide is dissolved in water, there is formed the true alkali, or hydrate of soda, called also caustic alkali. It is a white brittle mass of a fibrous texture, having a specific gravity of 1.536. It has a most corrosive taste and action upon animal substances, dissolving readily both in water and

alcohol, attracting carbonic acid from the atmosphere, and falling thereby into an efflorescent carbonate. It forms soaps with tallow, oils, wax, rosin; dissolves wool, hair, silk, horn, alumina, silica, sulphur, and some metallic sulphurets. It consists of 77.66 soda and 22.34 water. With acids, soda forms salts which are soluble in water, and many of which crystallize. The carbonate of soda is the soda of commerce in various states, either crystallized, in lumps, or in a crude powder called soda-ash. The soda of commerce is supplied chiefly from two sources, the burning of marine vegetables, such as common seaweed, and the *salsola soda*, which furnish the impure alkalies called *help* and *barilla*; and the decomposition of common salt, or rather, perhaps, the sulphate of soda, obtained by the decomposition of salt, by sulphuric acid. The chief uses of soda are in the manufacture of glass, and of hard soap. The carbonate of soda is used in washing, and is a powerful detergent, although milder than carbonate of potash. It is also used in medicine. Sulphate of soda is glauber salts. [See SODIUM.]

SO'DA-ASH, *n.* Impure carbonate of soda.

SO'DALITE, *n.* A mineral; so called from the large portion of mineral alkali which enters into its composition. It is of a bluish green colour, and found crystallized or in masses.

SODALITY, *n.* [L. *sodalitas*, from *sodalis*, a companion.] A fellowship or fraternity.

SO'DA POWDERS, *n.* A substitute for soda-water. They are usually put up in blue and white papers, the former containing half a drachm of carbonate of soda and the latter 25 grains of tartaric acid. These are separately dissolved in water, and the solutions mixed and drunk while effervescing. The mixture, however, forms a tartrate of soda, and not a carbonate, as in the case of soda-water.

SO'DA-WATER, *n.* A refreshing drink formed by dissolving carbonate of soda in water, and supersaturating it with carbonic acid under pressure. It is useful in cases of debility of the stomach, accompanied with acidity.

SOD'DED, *pp.* Covered with sod; turfed.

SOD'DEN, *pp.* of *Seethe*. Boiled; seethed.

SOD'DY, *a.* [from *sod*.] Turfy; consisting of sod; covered with sod.

SO'DIUM, *n.* The metallic base of soda, discovered by Davy in 1807. He obtained it by a process exactly similar to that by which he procured potassium, which it strongly resembles in many properties. Gay-Lussac and Thénard soon afterwards procured it in greater quantity by decomposing soda by means of iron. Sodium is a silver-white metal, having a very high lustre. It has not the bluish tinge of potassium, but, if any, rather a very slight yellowish tint, so that it resembles silver, while potassium resembles mercury. Its specific gravity is 0.9348; it melts at 200°, being rather less fusible than potassium, but it is on the other hand somewhat more volatile. It rapidly attracts oxygen from the air, and must therefore be kept under naphtha. It decomposes water instantly, but does not spontaneously

take fire when thrown on water, as potassium does. When heated in air or oxygen it takes fire and burns with a very pure and intense yellow flame. It is perhaps more abundant in our globe than any other metal, for it constitutes  $\frac{3}{4}$  of all the sea salt existing in sea-water, in the water of springs, rivers, and lakes, in almost all soils, and in the form of rock-salt. Sea-salt is a compound of chlorine with sodium. Sodium also occurs as oxide of sodium or soda, in a good many minerals; and more especially in the form of carbonate, nitrate, and borate of soda. Soda is contained in sea plants, and in land plants growing near the sea. It occurs also in most animal fluids. The only important oxide of sodium is the protoxide. [See SODA.]

SOD'OMITE, *n.* An inhabitant of Sodom.—2. One guilty of sodomy.

SODOMIT'ICAL, *a.* Relating to sodomy.

SOD'OMY, *n.* A crime against nature.

SÖE, *n.* [Fr. *seau*.] A large wooden vessel for holding water; a cowl. [Local.]

SOE'FUL, *n.* As much as a soe will hold.

SOE'VER, so and ever, found in compounds, as in *whosoever*, *whatsoever*, *wheresoever*. See these words. It is sometimes used separate from the pronoun; as, in what things *soever* you undertake, use diligence and fidelity.

SO'FA, *n.* [probably an Oriental word. Qu. Sw. *söfva*, to lull to sleep.] An elegant long seat, usually with a stuffed bottom, and raised stuffed back and ends. Sofas are variously made. The sofa of the Orientals is a kind of alcove raised half a foot above the floor, where visitors of distinction are received. It is also a seat by the side of the room covered with a carpet.

SO'FETT, *n.* A small sofa.

SO'FIT, *n.* [Fr. *soffite*; It. *soffitta*.] In *arch.*, the under side of an opening; the lower surface of a vault or arch. It also denotes the under horizontal surface of an architrave between columns, and the under surface of the corona of a cornice.

SO'EL, *n.* A Persian word employed to designate religious persons, otherwise termed dervishes.

SO'FISM, or SU'FISM, *n.* The mystical doctrines of the class of Mahometan religionists called *sofis*.

SOFT, *a.* [Sax. *softe*, *softa*. The D. has *zagt*, Sw. *sachta*, D. *sagte*, and the G. *sanft*, in a like sense, but whether allied to *soft*, may be questioned.]

1. Easily yielding to pressure; the contrary of *hard*, as, a *soft* bed; a *soft* peach; *soft* earth.—2. Not hard; easily separated by an edged instrument; as, *soft* wood. The chestnut is a *soft* wood, but more durable than hickory, which is a very hard wood. So we say, a *soft* stone, when it breaks or is heaved with ease.—3. Easily worked; malleable; as, *soft* iron.—4. Not rough, rugged, or harsh; smooth to the touch; delicate; as, *soft* silk; *soft* raiment; a *soft* skin.—5. Delicate; feminine; as, the *softer* sex.—6. Easily yielding to persuasion or motives; flexible; susceptible of influence or passion. In both these senses, *soft* is applied to females, and sometimes to males; as, a divine of a *soft* and servile temper. One king is *too soft* and easy. *L'Étrange*.

7. Tender; timorous. However *soft* within themselves they are, To you they will be valiant by despair.

*Dryden*

8. Mild; gentle; kind; not severe or unfeeling; as, a person of a *soft* nature.—9. Civil; complaisant; courteous; as, a person of *soft* manners. He has a *soft* way of asking favours.—10. Placid; still; easy.

On her *soft* axle while she paces even, She bears thee *soft* with the smooth air along.

*Milton*

11. Effeminate; viciously nice.

An idle *soft* course of life is the source of criminal pleasures.

*Broome*

12. Delicate; elegantly tender.

Her form more *soft* and feminine.

*Milton*

13. Weak; impressive.

The deceiver soon found this *soft* place of Adam's. [Not elegant.]

*Glennville*

14. Gentle; smooth or melodious to the ear; not loud, rough, or harsh; as, a *soft* voice or not; a *soft* sound; *soft* accents; *soft* whispers.—15. Smooth; flowing; not rough or vehement.

The solemn nightingale tun'd her *soft* lays.

*Milton*

*Soft* were my numbers, who could take offence?

*Pope*

16. Easy; quiet; undisturbed; as, *soft* slumbers.—17. Mild to the eye; not strong or glaring; as, *soft* colours; the *soft* colouring of a picture.

The sun shining on the upper part of the clouds, made the *softest* light imaginable.

*Brown*

18. Mild; warm; pleasant to the feelings; as, *soft* air.—19. Not tinged with an acid; not hard; not astringent; as, *soft* water is the best for washing.—20. Mild; gentle; not rough, rude, or irritating.

A *soft* answer turneth away wrath; Prov. xv.

21. Weak; foolish. [Familiar.]

SOFT, *adv.* Softly; gently; quietly.

SOFT, *exclam.* for *be soft*, hold; stop; not so fast.

But, *soft*, my muse, the world is wide.

*Suckling*

SOFTEN, *v. t.* (sof' n.) To make soft or more soft; to make less hard.

Their arrows' point they *soften* in the flame.

*Gay*

2. To mollify; to make less fierce or intractable; to make more susceptible of humane or fine feelings; as, to *soften* a hard heart; to *soften* savage natures. The heart is *softened* by pity.

Diffidence conciliates the proud and *softens* the severe.

*Rambler*

3. To make less harsh or severe; as, to *soften* an expression.—4. To palliate; to represent as less enormous; as, to *soften* a fault.—5. To make easy; to compose; to mitigate; to alleviate. Music can *soften* pain to ease.

*Pope*

6. To make calm and placid.

Bid her be all that cheers or *softens* life.

*Pope*

7. To make less harsh, less rude, less offensive or violent.

But sweetly temper'd awe, and *soften'd* all he spoke.

*Dryden*

8. To make less glaring; as, to *soften* the colouring of a picture.—9. To make tender; to make effeminate; to enervate; as, troops *softened* by luxury.—10. To make less harsh or grating; as, to *soften* the voice.

SOFTEN, *v. i.* (sof' n.) To become less hard; to become more pliable and yielding to pressure; as, iron or wax *softens* in heat; fruits *soften* as they

ripen.—2. To become less rude, harsh, or cruel; as, savage natures *soften* by civilization.—3. To become less obstinate or obdurate; to become more susceptible of humane feelings and tenderness; to relent. The heart *softens* at the sight of woe.—4. To become more mild; as, the air *softens*.—5. To become less harsh, severe, or rigorous.

**SOFTENED**, *pp.* Made less hard or less harsh; made less obdurate or cruel, or less glaring.

**SOFTENER**, *n.* He or that which softens or palliates.—2. One that palliates; also written *softner*.

**SOFTENING**, *ppr.* Making more soft; making less rough or cruel, &c.

**SOFTENING**, *n.* The act of making less hard, less cruel or obdurate, less violent, less glaring, &c.—In *painting*, the blending of colours into each other.

**SOFT-GRASS**, *n.* The common name of two British species of plants of the genus *Holcus*, *H. mollis* and *H. lanatus*. [See **HOLCUS**.]

**SOFT-HEADED**, *a.* Of weak intellect. [Familiar.]

**SOFT-HEARTED**, *a.* Having tenderness of heart; susceptible of pity or other kindly affection; gentle; meek.

**SOFTISH**, *a.* Somewhat soft.

**SOFTLING**, *† n.* A sybarite.

**SOFTLY**, *adv.* Without hardness.—2. Not with force or violence; gently; as, he *softly* pressed my hand.—3. Not loudly; without noise; as, speak *softly*; walk *softly*.

In this dark silence *softly* leave the town. *Dryden*.

4. Gently; placidly.

She *softly* lays him on a flowery bed. *Dryden*.

5. Mildly; tenderly.

The king must die;  
Though pity *softly* pleads within my soul. *Dryden*.

**SOFT'NER**. See **SOFTENER**.

**SOFTNESS**, *n.* The quality of bodies which renders them capable of yielding to pressure, or of easily receiving impressions from other bodies; opposed to *hardness*.—2. Susceptibility of feeling or passion; as, the *softness* of the heart or of our natures.—3. Mildness; kindness; as, *softness* of words or expressions.—4. Mildness; civility; gentleness; as, *softness* of manners.—5. Effeminacy; vicious delicacy.

He was not delighted with the *softness* of the court. *Clarendon*.

6. Timorousness; pusillanimity; excessive susceptibility of fear or alarm.

This virtue could not proceed out of fear or *softness*. *Bacon*.

7. Smoothness to the ear; as, the *softness* of sound, which is distinct from *exility* or *fineness*.—8. Facility; gentleness; candour; easiness to be affected; as, *softness* of spirit.—9. Gentleness, as contrary to *vehemence*.

With strength and *softness*, energy and ease. *Harte*.

10. Mildness of temper; meekness. For contemplation he and valour form'd, For *softness* sbe, and sweet attractive grace. *Milton*.

11. Weakness; simplicity.—12. Mild temperature; as, the *softness* of a climate.

**SOFT'-STEM**, *n.* In *bot.*, a stem which is unable to support itself in an erect position, and falls to the ground.

**SOFT'-VOICED**, *a.* Having a soft voice.

**SOG'GY**, *a.* [allied probably to *soak*,—which see; *W. soeg*, and *soegi*, to

steep.] 1. Wet; filled with water; soft with moisture; as, *soggy* land. Timber that has imbibed water is said to be *soggy*.—2. Steaming with damp. **SO'HO**, *exclam.* A word used in calling from a distant place; a sportsman's halloo.

*Soi disant*, (*swa desaun*.) [Fr.] Calling himself; self-styled; pretended; would be.

**SOIL**, *v. t.* [*Sax. selan, sylvian*; Fr. *salir, souiller*; Ir. *salaighim*.] 1. To make dirty on the surface; to foul; to dirt; to stain; to defile; to tarnish; to sully; as, to soil a garment with dust. Our wonted ornaments now *soil'd* and stain'd. *Milton*.

2. To cover or tinge with any thing extraneous; as, to *soil* the earth with blood.—3. To dung; to manure.—*To soil a horse*, is to purge him by giving him fresh grass.—*To soil cattle*, in husbandry, is to feed them with grass daily mowed for them, instead of pasturing them.

**SOIL**, *n.* [*G. sile*. See the **VERB**.]

1. Dirt; any foul matter upon another substance; foulness; spot.—2. Stain; tarnish.

A lady's honour...will not bear a *soil*. *Dryden*.

3. [*Lat. solum, W. swl*.] The upper stratum of the earth; the mould, or that compound substance which furnishes nutriment to plants, or which is particularly adapted to support and nourish them. Wherever the surface of the earth is not covered with water, or is not naked rock, there is a layer of earth more or less mixed with the remains of animal and vegetable substances in a state of decomposition, which is commonly called the *soil*. Soils may generally be distinguished from mere masses of earth by their friable nature and dark colour, and by the presence of some vegetable fibre or carbonaceous matter. In uncultivated grounds, soils generally occupy only a few inches in depth on the surface; and in cultivated grounds their depth is generally the same as that to which the implements used in cultivation have penetrated. The stratum which lies immediately under the soil is called the subsoil, which is comparatively without organized matter. Soil is composed of certain mixtures or combinations of the following substances: The earths, silex, alumina, lime, magnesia; the alkalis, potassa, soda, and ammonia, oxide of iron and small portions of other metallic oxides, a considerable proportion of aqueous moisture, and several gases, as oxygen, hydrogen, carbonic acid. Besides these every soil contains vegetable and animal matters, either partially or wholly decomposed. The analyzing of soils, in order to ascertain their component parts, and qualities, and their adaptation to the growth of various vegetable productions, as well as the methods of improving them by means of chemical manures, form the subject of agricultural chemistry. [See **NUTRITION**.]—4 Land; country. We love our native *soil*.—5. Dung; compost.

Improve land by dung and other sort of *soils*. *Mortimer*.

*To take soil*, to run into the water, as a deer when pursued.

**SOILED**, *pp.* Fouled; stained; tarnished; manured; fed with grass.

**SOIL'INESS**, *n.* Stain; foulness. [*Little used*.]

**SOILING**, *ppr.* Defiling; fouling; tarnishing; feeding with fresh grass; manuring.

**SOILING**, *n.* The act or practice of feeding cattle or horses in the stable or yards, with food brought to them as it is cut in the meadows or fields. The great advantage of soiling horses and cattle is the increase of manure of the best quality, which is thereby produced.

**SOIL'LESS**, *a.* Destitute of soil.

**SOILS**, *n.* Among *builders*, a provincial term for the principal rafters of a roof.

**SOIL'URE**, *† n.* [*Fr. souillure*.] Stain; pollution.

**SOIREE**, *n.* (*swar'ai*.) [Fr.] Originally an evening party held for the sake of conversation only; but the word has since been introduced into all the languages of modern Europe, and is now applied to designate most descriptions of evening parties, in which ladies and gentlemen are intermixed, whatever be the amusements introduced. In this country it is frequently applied to the public meetings of certain societies, held for the advancement of their respective objects, at which tea, coffee, and other refreshments are introduced during the intervals of business.

**SO'JA HISPIDA**, *n.* The *Dolichos soja*, Linn., a leguminous plant, native of Japan and the Moluccas, and abundant in the peninsula of India. The seeds resemble those of the French or kidney bean, and are used by the Chinese to form a favourite dish called *ten-hu*, or *tau-hu*.

**SOJOURN**, *v. i.* (*so'jurn*.) [Fr. *séjourner*; It. *soggiornare*, which seems to be formed from the noun *soggiorno*; *sub* and *giorno*, a day. *Sojourn*, in all its forms, is antiquated.] To dwell for a time; to dwell or live in a place as a temporary resident, or as a stranger, not considering the place as his permanent habitation. So Abram *sojourned* in Egypt; Gen. xii.

The soldiers assembled at Newcastle, and there *sojourned* three days. *Hayward*.

**SO'JOURN**, *n.* A temporary residence, as that of a traveller in a foreign land.

**SO'JOURNER**, *n.* A temporary resident; a stranger or traveller who dwells in a place for a time.

We are strangers before thee and *sojourners*, as all our fathers were; 1 Chron. xxix.

**SO'JOURNING**, *ppr.* Dwelling for a time.

**SO'JOURNING**, *n.* The act of dwelling in a place for a time; also, the time of abode; Exod. xii.

**SOJOURNMENT**, *n.* Temporary residence, as that of a stranger or traveller.

**SOKE**, *n.* A district in which a particular privilege or power is exercised. [See **SOC**, **SOCAGE**.]

**SOKE'MAN**, *n.* In *old Eng. law*, one who held land (says Blackstone) by no servile tenure, but paid rent as a soke, or sign of freedom.

**SOKE'MANRY**, *n.* The tenure of socage.

**SÖKE'-REEVE**, *n.* A rent-gatherer in a lord's soke.

**SOL**, *n.* [*Lat.*] The sun. In *her.*, a term implying or or gold, in blazoning the arms of emperors, kings, and princes by planet, instead of metal and colour.

**SOL**, *n.* [*Norm. souldz, soulds, souz*, from *L. solidus*.] 1. In France, a small copper coin; a halfpenny; usually *sol*

or *sous*.—2. A copper coin and money of account in Switzerland.

**SOL**, *n.* [It.] The name of a note in music, the fifth of the scale, called *G* by the Germans and English.

**SOLA** or **SHOLA**, *n.* A plant of the genus *Æschynomene*; the *Æ. lagenaria*, common in moist places, and in the rainy season, in many parts of the plains of India. These plants seem to be composed almost entirely of pith, and the stems are applied to a variety of uses, as for making some kinds of toys, floats of fishermen's nets, hats, &c. They have also been employed for lining drawers of natural history.

**SOLACE**, *v. t.* [It. *sollazzure*, from *L. solatium*; *solor*, to comfort, assuage, relieve. See **CONSOLE**.] 1. To cheer in grief or under calamity; to comfort; to relieve in affliction; to console; *applied to persons*; as, to *solace* one's self with the hope of future reward.—2. To allay; to assuage; as, to *solace* grief.

**SOLACE**, *v. i.* To take comfort; to be cheered or relieved in grief.

**SOLACE**, *n.* [It. *sollazzo*; *L. solatium*.] Comfort in grief; alleviation of grief or anxiety; also, that which relieves in distress; recreation.

The proper *solaces* of age are not music and compliments, but wisdom and devotion.

**SOLACED**, *pp.* Comforted; cheered in affliction. *Rambler.*

**SOLACEMENT**, *n.* Act of comforting; state of being solaced.

**SOLACING**, *ppr.* Relieving grief; cheering in affliction.

**SOLA'CIOUS**, *† a.* Affording comfort or amusement.

**SOLAND'ER**, *n.* [Fr. *soulandres*.] A disease in horses.

**SOLAN-GOOSE**, *n.* The gannet, (*Pelecanus bassanus*) an aquatic fowl of the family *Pelecanidae* or pelicans. It is nearly of the size of the domestic goose. The colour is chiefly white, with the tips of the wings black, and it feeds on various small fishes, especially different species of herring. Great numbers of these birds frequent the Hebrides, St. Kilda, the Craig of Ailsa, and the Bass Rock. Many of the old birds are annually taken in St. Kilda as well as the Bass Rock, on account of the feathers and down, and the young for the flesh, which was formerly much esteemed when roasted. It also occurs on the eastern coasts of North America and Labrador.

**SOLANA'CEÆ**, *n.* A nat. order of monopetalous exogenous plants, composed of herbs or shrubs, rarely of arborescent plants. The species are natives of most parts of the world, without the arctic and antarctic circles, and especially within the tropics. The night-shade, potato, capsicum, tomato, egg-plant, and tobacco, are all found in this order. The general property of the order is narcotic. This prevails to a greater or less degree in all the plants of the order, although certain parts of the plants, when cultivated, are used for food.

**SOLAN'IA**, *n.* The active principle of *solanum dulcamara*, or deadly nightshade. [See the next word.]

**SOLAN'INA**, *n.* [*L. solanum*, night-SOL'ANINE, } shade. A vegetable alkaloid, obtained from various species of *Solanum*, as *S. dulcamara*, *S. nigrum*, *S. tuberosum*, &c. It forms a crystalline powder, very bitter and acid, and highly poisonous. It is insoluble in

water, but soluble in alcohol. With acids it forms salts, which are uncrystallizable.

**SOLA'NO**, *n.* A hot S. E. wind in Spain which produces inflammatory effects on men. It is a modification of the sirocco.

**SOLA'NUM**, *n.* [*L.*] A genus of plants, nat. order *Solanaceæ*, of which it is the type. It is one of the most extensive genera of plants, upwards of 400 species having been enumerated as belonging to it, many of them possessing apparently very opposite properties. The most important species are, the *S. tuberosum*, which produces the common potato, a native of America; [See **POTATO**]; *S. nigrum*, or common nightshade; *S. dulcamara*, woody nightshade or bitter-sweet; *S. melongena*, egg-



Egg Plant (*Solanum melongena*).

plant, mad-apple or Jew's apple; *S. sodomum*, Sodom egg-plant, or apple of Sodom; *S. sanctum*, or Palestine egg-plant; *S. Æthiopicum*, or Æthiopian nightshade; *S. pseudo-quina*, or false quina nightshade; *S. verbascifolium*, or mullein-leaved nightshade; *S. Lycopersicum*, common love-apple or tomato.

**SOLAR**, *a.* [Fr. *solaire*; *L. solaris*, from *sol*, the sun.] 1. Pertaining to the sun; as, the *solar* system; or proceeding from it; as, *solar* light; *solar* rays; *solar* influence.—2. † Belonging to the sun; as, *solar* herbs.—3. † In *astrol.*, born under the predominant influence of the sun; as, a *solar* people.—4. Measured by the progress of the sun, or by its revolution; as, the *solar* year.—*Solar cycle*, a period of 28 years. [See **CYCLE**.] *Solar-day*. [See **DAY**.]—*Solar month*. [See **MONTH**.]—*Solar microscope*; a microscope in which the object is illuminated by the light of the sun concentrated upon it. [See **MICROSCOPE**.]—*Solar flowers* are those which open and shut daily, at certain determinate hours.—*Solar spots*, dark spots that appear on the sun's disk, usually visible only by the telescope, but sometimes so large as to be seen by the naked eye. They adhere to the body of the sun; indicate its revolutions on its axis; are very changeable in their figure and dimensions; and vary in size from mere points to spaces of 50,000 miles in diameter.—*Solar spectrum*. [See **SPECTRUM**.]—*Solar system*, in *astron.*, that system which consists of the sun, and all those heavenly bodies whose motions are controlled by its gravitation; viz., the planets, satellites, and comets. [See **SYSTEM**.]—*Solar time*. [See **TIME**.]—*Solar year*. [See **YEAR**.]

**SOLAR**, *n.* In *arch.*, a *sollar*; a loft, or upper chamber.

**SOLA'RIUM**, *n.* [*L.*] Among the Romans, a place on the tops of houses, exposed to the sun, where the inhabitants used to take air and exercise.—2. A genus of marine univalve shells belonging to the family *Turbinacea*. They are littoral shells, and belong to tropical seas.

**SOLARY**, *a.* *Solar*. [Little used.]

**SOLA'TIUM**, *n.* [*L.* consolation; *sollace*.] In *Scots law*, a sum of money paid over and above actual damages, to an injured party, by the person who inflicted the injury, as a *solace* for wounded feelings. This *solutium* for wounded feelings is allowed in cases of breach of promise of marriage, or where a father, husband, or near relative is killed through negligence. This principle is not recognized in the law of England.

**SOLD**, *pret.* and *pp.* of *Sell*.

**SOLD**, *† n.* [from the root of *soldier*; Norm. *soude*.] Salary; military pay.

**SOLDAN**, for *Sultan*, not in use.

**SOLDANELL**, } *n.* 1. A genus of **SOLDANELL'IA**, } plants, nat. order *Primulaceæ*. There is but a single species, the *S. alpina*, a native of Europe.—2. A species of *convolvulus*, the *C. soldanella*.

**SOLD'ER**, *v. t.* [*W. sawd*, juncture; *sawdriac*, to join, to solder; Fr. *souder*; Arm. *souda* or *soudta*; It. *sodare*, to make firm.] To unite and make solid, as metallic substances; to join separate things or parts of the same thing by a metallic substance in a state of fusion, which hardens in cooling, and renders the joint solid.

**SOLD'ER**, *n.* Metallic cement; a metal or metallic composition used in uniting other metallic substances, by being fused between them. [See **SOLDERING**.]

**SOLD'ERED**, *pp.* United by a metallic cement.

**SOLD'ERING**, *ppr.* Uniting and making solid by means of a metallic substance in a state of fusion.

**SOLD'ERING**, *n.* The process of uniting the surfaces of metals, by the intervention of a more fusible metal, which being melted upon each surface, serves, partly by chemical attraction, and partly by cohesive force, to bind them together. The alloy used as a solder must not only be more fusible than the metal or metals to be united, but must also have a strong affinity for them. The solder usually contains a large proportion of the metal to which it is to be applied, in combination with some more easily fusible metal. The surfaces to be united must be made perfectly clean and free from oxide. This is commonly effected by scraping the surfaces; and in order that the formation of any oxide may be prevented during the process, borax, sal ammoniac, or resin is used, either mixed with the solder or applied to the surfaces. A new process of soldering, the invention of a French gentleman, has recently been introduced under the name of *autogenous soldering*. It consists in the union of two pieces of metal without the intervention of any solder, by fusing them at the point of junction, by jets of flame from a gas blowpipe.

**SOLDIER**, *n.* (söljur.) [Fr. *soldat*; Norm. *soudeyer*, *soudiers*; from *L. soldus*, a piece of money; the pay of a soldier; Norm. *soud*, contracted from *sould*, pay, wages; *soudeyer*, to keep in pay; Sw. *besolda*, to count out money to, to pay; Dan. *besolder*, to

give a salary or wages.] 1. A man engaged in military service; one whose occupation is military; a man enlisted for service in an army; a private, or one in the ranks.

There ought to be some time for sober reflection between the life of a *soldier* and his death. *Rambler*.

2. A man enrolled for service, when on duty or embodied for military discipline; a private; as, a militia *soldier*.—3. *Emphatically*, a brave warrior; a man of military experience and skill, or a man of distinguished valour. In this sense, an officer of any grade may be denominated a *soldier*.

**SOLDIER-CRAB, n.** A crustaceous animal.

**SOLDIERESS, † n.** A female soldier. **SOLDIERLIKE, } a.** Like or becoming **SOLDIERLY, } a.** real soldier; brave; martial; heroic; honourable.

**SOLDIERSHIP, n.** Military qualities; military character or state; martial skill; behaviour becoming a soldier.

**SOLDIERY, n. (sôljury.)** Soldiers collectively; the body of military men.

I charge not the *soldiers* with ignorance and contempt of learning, without exception. *Swift*.

2. † Soldiership; military service.

**SOLE, n. (Sax. sol; G. sohle; It. suolo, soil and sole; Sp. suela, the sole of the foot, and suolo, soil; L. solea, solum; that which sets or is set or laid. The radical sense coincides with that of still.)**

1. The bottom of the foot; and by a figure, the foot itself.—2. The bottom of a shoe; or the piece of leather which constitutes the bottom.

The caliga was a military shoe with a very thick sole, tied above the instep. *Arbutnot*.

3. The part of any thing that forms the bottom, and on which it stands upon the ground.

Elm is proper for mills, *soles* of wheels and pipes. *Mortimer*.

4. A marine fish of the genus *Pleuronectes*, the *P. solea*, Linn., the *solea vulgaris*, Cuvier, so called probably



Sole (*Pleuronectes soiea*.)

because it keeps on or near the bottom of the sea. These fish abound on the British coast, and hence the name of *sole bank*, to the southward of Ireland. They furnish a wholesome and delicious article of food. The sole sometimes grows to the weight of six or seven pounds.—5. In *shipbuilding*, a sort of lining, used to prevent the wearing of any thing.—*Sole of a gun port*, the lower part of it; more properly called the *port-sail*.—*Sole of the rudder*, a piece of timber attached to the lower part of it, to render it nearly level with the false keel.—6. A sort of horn under a horse's hoof.

**SOLE, v. t.** To furnish with a sole; as, to *sole* a shoe.

**SOLE, a. [L. solus; Fr. seul; probably from separating; Ar. zaula.]** 1. Single; being or acting without another; individual; only. God is the sole creator and sovereign of the world.—2. In *law*, single; unmarried; as, a *femme sole*.

**SO'LEA, n. [L. a slipper.]** In *mammalogy*, the under surface of the foot or hoofs; the sole.—2. The sole; a genus of malacopterygious fishes, separated by Cuvier from the *Pleuronectes*, Linn. They are distinguished from the other species of *pleuronectes* by their more elongated form, and by the blunt and rounded shape of the muzzle. The eyes and the colouring are on the right side. *S. vulgaris* is the common sole. [See **SOLE**, No. 4.]

**SOL'ECISM, n. [Gr. σολοικισμος, said to be derived from Soli, a people of Attica, who being transplanted to Cilicia, lost the purity of their language.]** 1. Impropriety in language, or a gross deviation from the rules of syntax; incongruity of words; want of correspondence or consistency. A barbarism may be in one word; a *solecism* must be of more. *Johnson*, from *Cicero*.

2. Any unfitness, absurdity, or impropriety. *Cesar*, by dismissing his guards and retaining his power, committed a dangerous *solecism* in politics. *Middleton*.

3. Among *modern grammarians*, any word or expression which does not agree with the established usage of writing or speaking. As customs change, that which may be regarded as a *solecism* at one time, may at another be considered as correct language. Hence a *solecism* differs from a barbarism, which consists in the use of a word or expression altogether contrary to the spirit of the language.

**SOL'ECIST, n. [Gr. σολοικιστες.]** One who is guilty of impropriety in language.

**SOLECISTIC, } a.** Incorrect; in-

**SOLECISTICAL, } congruous.**

**SOLECISTICALLY, adv.** In a *solecistic* manner.

**SOL'ECIZE, v. i. [Gr. σολοικίζω.]** To commit *solecisms*.

**SOLE, pp.** Furnished with a sole.

**SOLE-LEATHER, n.** Thick strong leather used for the soles of shoes.

**SOLELY, adv.** Singly; alone; only; without another; as, to rest a cause *solely* on one argument; to rely *solely* on one's own strength.

**SOLEMN, a. (sol'em.) [Fr. solennel; L. solennis, from soleo, to be accustomed, to use, that is, to hold on or continue, as we have *wont*, from G. *wohnen*, to dwell.]** 1. † Anniversary; observed once a year with religious ceremonies.

The worship of this image was advanced and a *solemn* supplication observed every year. *Stillingfleet*.

2. Religiously grave; awful; formal; marked with pomp and sanctity; attended with religious rites.

His holy rites and *solemn* feasts profan'd. *Milton*.

3. Religiously serious; piously grave; devout; marked by reverence to God; as, *solemn* prayer; the *solemn* duties of the sanctuary.—4. Affecting with seriousness; impressing or adapted to impress seriousness, gravity, or reverence; sober; serious.

There reign'd a *solemn* silence over all. *Spenser*.

To 'swage with *solemn* touches troubled thoughts. *Milton*.

5. Grave; serious; or affectedly grave; as, a *solemn* face.—6. Sacred; enjoined by religion; or attended with a serious appeal to God; as, a *solemn* oath.—7. Marked with solemnities; as, a *solemn* day.

**SOL'EMN-BREATHING, a.** Diffusing or inspiring solemnity.

**SOL'EMNESS, n.** The state or quality of being solemn; reverential manner; gravity; as, the *solemnness* of public worship.—2. Solemnity; gravity of manner.

**SOLEMN'NITY, n. [Fr. solennité.]** 1. A rite or ceremony annually performed with religious reverence [*Rarely used.*]

—2. A religious ceremony; a ritual performance attended with religious reverence; as, the *solemnity* of a funeral or of a sacrament.—3. A ceremony adapted to impress awe; as, the *solemnities* of the last day.—4. Manner of acting awfully serious.

With horrible *solemnity* he caused every thing to be prepared for his triumph of victory. *Sidney*.

5. Gravity; grave stateliness; steady seriousness; as, the *solemnity* of the Spanish language.—6. Affected gravity.

*Solemnity's* a cover for a sot. *Young*.

**SOLEMN'NIZATE, † v. t.** To solemnize.

**SOLEMNIZA'TION, n.** The act of solemnizing; celebration; as, the *solemnization* of a marriage.

**SOL'EMNIZE, v. t. [Fr. solenniser; It. solennizzare.]** 1. To dignify or honour by ceremonies; to celebrate; as, to *solemnize* the birth of Christ.

Their choice nobility and flow'r Met from all parts to *solemnize* this feast. *Milton*.

2. To perform with ritual ceremonies and respect, or according to legal forms; as, to *solemnize* a marriage.—3. † To perform religiously once a year.

4. To make grave, serious, and reverential; as, to *solemnize* the mind for the duties of the sanctuary.

**SOL'EMNIZED, pp.** Celebrated religiously; made grave.

**SOL'EMNIZER, n.** One who performs a solemn rite.

**SOL'EMNIZING, ppr.** Honouring with sacred rites.

**SOL'EMNLY, adv.** With gravity and religious reverence. Let us *solemnly* address the throne of grace.—2. With official formalities and by due authority. This question of law has been *solemnly* decided in the highest court.—3. With formal state.—4. With formal gravity and stateliness, or with affected gravity. There in deaf murmurs *solemnly* are wise. *Dryden*.

5. With religious seriousness; as, I *solemnly* declare myself innocent.

I do *solemnly* assure the reader. *Swift*.

**SO'LEN, n. [Gr. σωλην, a tube.]** A genus of marine bivalves, forming the type of the family *Solenacea*, and known by the common name of razor-shell. The species are found on sandy beaches or shoals, where they burrow vertically, and lie concealed at a depth of about six inches, when the tide leaves the beach dry. They are distinguished by the great length of the respiratory tubes; hence, perhaps, the name, although it may also apply to the shell, which resembles a tube.

**SOL'EN, n.** In *sur.*, a machine in which a broken leg is placed.

**SOLENA'CEA, } n.** A family of **SOLENA'CEANS, } bivalve molluscs, including the genus Solen and several others.**

**SOLENA'CEOUS, a.** Relating to the *Solenaceans*.

**SOLENESS, n. [from sole.]** Singleness; a state of being unconnected with others.

**SO'LENITE, n.** Petrified solen, a genus

of shells. Fragments of solenites are found in the Essex cliffs.

**SOLE'N'ODON**, *n.* A genus of insectivorous mammals.

**SOLENOID**, *n.* [Gr. *σολήν*, a tube, and *ιδος*, appearance.] In *electro-dynamics*, a name given by Ampère to a system of small electrical currents, equal and equi-distant, and returning into themselves, the planes of which are normals to any given line, whether straight or curved, in which their centres are situated, and which forms the axis of the solenoid.

**SOL'ERT**, *† a.* [Lat. *solers*.] Crafty; subtle.

**SOL-FA'**, *v. i.* In *music*, to exercise the voice on the gamut. [See **SOLFEGGIO**.]

**SOL-FA-ING**, *n.* Solmization, — *which see*.

**SOLFANARIA**, *n.* [It.] A sulphur mine.

**SOLFATARA**, *n.* [It.] A volcanic vent emitting sulphureous, muriatic, and acid vapours or gases. The word is derived from *solfa terra*, a celebrated mountain of Naples.

**SOLFATARITE**, *n.* In *min.*, a substance found in the *solfataras* of Italy.

**SOLF-EGGIA'RE**, *v. i.* [Ital.] To sol-fa.

**SOLFEG'GIO**, *n.* [Ital.] In *music*, the system of arranging the scale by the names *ut, re, mi, fa, sol, la*.

**SOL'IL**, in *music*, *plur.* of *Solo*.

**SOLICIT**, *v. t.* [L. *solicito*; Fr. *soliciter*.] 1. To ask with some degree of earnestness; to make petition to; to apply to for obtaining something. This word implies earnestness in seeking, but less earnestness than *beg, implore, entreat, and importune*, and more than *ask or request*; as when we say, a man *solicits* the minister for an office; he *solicits* his father for a favour.

Did I *solicit* thee

From darkness to promote me? *Milton.*

2. To ask for with some degree of earnestness; to seek by petition; as, to *solicit* an office; to *solicit* a favour.

—3. To awake or excite to action; to summon; to invite.

That fruit *solicited* her longing eye.

*Milton.*

Sounds and some tangible qualities *solicit* their proper senses, and force an entrance to the mind.

*Locke.*

4. To attempt; to try to obtain.

I view my crime, but kindly at the view,  
Repeat old pleasures and *solicit* new. *Pope.*

5. To disturb; to disquiet; a Latinism rarely used.

But anxious fears *solicit* my weak breast.

*Dryden.*

**SOLICIT**, *v. i.* To make solicitation for some one, or for a thing. [Thus used by *Addison*.]

**SOLICITANT**, *n.* One who solicits.

**SOLICITATION**, *n.* Earnest request; a seeking to obtain something from another with some degree of zeal and earnestness; sometimes, perhaps, importunity. He obtained a grant by repeated *solicitations*.—2. Excitement; invitation; as, the *solicitation* of the senses.

**SOLICITED**, *pp.* Earnestly requested. **SOLICITING**, *ppr.* Requesting with earnestness; asking for; attempting to obtain.

This way and that *soliciting* the dart.

*Dryden.*

**SOLICITOR**, *n.* [Fr. *soliciteur*.] 1. One who asks with earnestness; one that asks for another.—2. A person

admitted to practise in the court of chancery in the conduct of suits, &c., who is styled attorney in the courts of common law.—*Solicitor-General*, an officer of the crown, next in rank to the attorney-general, with whom he is in fact associated in the management of the legal business of the crown, and public offices. On him generally devolves the maintenance of the rights of the crown in revenue cases, patent causes, &c. The solicitor-general of Scotland is one of the crown counsel, next in dignity and importance to the lord advocate, to whom he gives his aid in protecting the interests of the crown, in conducting prosecutions, &c. In *Scotland*, the term solicitor or solicitor at law is synonymous with attorney in England. The solicitors at law form a society of law agents in Edinburgh, and are entitled to practise before the sheriff court of Edinburgh and other inferior courts. There is also, in Edinburgh, a society of solicitors who practise before the supreme court, and are members of the college of justice.

**SOLICITOUS**, *a.* [L. *solicitus*.] 1. Careful; anxious; very desirous, as to obtain something. Men are often more *solicitous* to obtain the favour of their king or of the people, than of their Maker.—2. Careful; anxious; concerned; as respecting an unknown but interesting event; followed usually by *about* or *for*. We say, a man is *solicitous about* the fate of his petition, or *about* the result of the negotiation. He is *solicitous for* the safety of his ship.—3. Anxious; concerned; followed by *for*, as when something is to be obtained. Be not *solicitous for* the future.

**SOLICITOUSLY**, *adv.* Anxiously; with care and concern. Errors in religion or in science are to be *solicitously* avoided. A wise prince *solicitously* promotes the prosperity of his subjects.

**SOLICITOUSNESS**, *n.* Solicitude.

**SOLICITRESS**, *n.* A female who solicits or petitions.

**SOLICITUDE**, *n.* [L. *solicitudo*.] Carefulness; concern; anxiety; uneasiness of mind occasioned by the fear of evil or the desire of good. A man feels *solicitude* when his friend is sick. We feel *solicitude* for the success of an enterprise. With what *solicitude* should men seek to secure future happiness!

**SOL'ID**, *a.* [L. *solidus*; Fr. *solide*; from the sense of *setting* or *pressure*, and hence allied to L. *solum*, Eng. *sill*.] 1. Hard; firm; compact, not fluid; not superficial; having its constituent particles so connected together that their relative positions cannot be altered without the application of sensible force. The force which resists the alteration of the relative positions of the parts, is termed the force of cohesion. Hence solid bodies are distinguished from fluids, whose parts yield, and alter their relative positions on the application of the slightest force or impression. [See the noun.] *Solid* is opposed to *fluid* and *liquid*.—2. Not hollow; full of matter; as, a *solid* globe or cone, as distinguished from a *hollow* one.—3. Having all the geometrical dimensions; having length, breadth, and thickness; *cubic*; as, a *solid* foot contains 1728 *solid* inches. [In this sense, *cubic* is now generally

used.]—4. Firm; compact; strong; as, a *solid* pier; a *solid* pile; a *solid* wall.—5. Sound; not weakly; as, a *solid* constitution of body. [Sound is more generally used.]—6. Real; sound; valid; true; just; not empty or fallacious. Wise men seek *solid* reasons for their opinions.—7. Grave; profound; not light, trifling, or superficial.

These wanting wit, affect gravity and go by the name of *solid* men. *Dryden.*

8. In *bot.*, of a fleshy, uniform, undivided substance, as a bulb or root; not spungy or hollow within, as a stem.—*Solid angle*, an angle formed by three or more plane angles meeting in a point; but which are not in the same plane; as the angle of a die, the point of a diamond, &c. [See **ANGLE**.]—*Solid square*, in *military lan.*, is a square body of troops; a body in which the ranks and files are equal.—*Solid problem*, a problem which cannot be constructed geometrically, that is, by the intersections of straight lines and circles, but requires the introduction of some curves of a higher order; as, the ellipse, parabola, and hyperbola; which being the sections of solids, give rise to the term *solid problem*. The algebraic solution of a *solid* problem leads to a cubic or biquadratic equation.—*Solid of least resistance*. [See **RESISTANCE**.]

**SOL'ID**, *n.* A firm compact body, a body the cohesion of whose particles is so strong that they move in a combined mass, and retain their relative positions. A *solid* is thus distinguished from a liquid, whose parts or particles yield to the slightest impression, and are easily made to move amongst each other. In solids, the attractive forces of the particles are greater than the repulsive, and the particles consequently adhere with greater or less force; in liquids, the attractive and repulsive forces are balanced; and in gases the repulsive forces prevail.—2. In *geom.*, a body or magnitude which has three dimensions; length, breadth, and thickness, being thus distinguished from a surface which has but two dimensions, and from a line, which has but one. The boundaries of solids are surfaces.—*Regular solids* are those which are bounded by equal and regular planes. [See **BODY**.] All other solids are called *irregular*. In anatomy and medical science, the bones, flesh, and vessels of animal bodies are called *solids*, in distinction from the blood, chyle, and other fluids.

**SOLIDA'GO**, *n.* A genus of composite plants, chiefly natives of North America. [See **GOLDEN ROD**.]

**SOLIDARE**, *† n.* A small piece of money.

**SOLIDATE**, *v. t.* [L. *solido*.] To make solid or firm. [Little used.]

**SOLIDIFICATION**, *n.* The act of making solid.

**SOLIDIFIED**, *pp.* Made solid.

**SOLIDIFY**, *v. t.* [L. *solidus*, solid, and *facio*, to make.] To make solid or compact.

**SOLIDIFYING**, *ppr.* Making solid.

**SOLIDISM**, *n.* In *med.*, the doctrine that refers all diseases to alterations of the *solid parts* of the body.

**SOLIDITY**, *n.* [Fr. *solidité*; L. *soliditas*.] 1. Firmness; hardness; density; compactness; that property of bodies by which the particles cohere with greater or less force, and cannot be

made to alter their relative positions without the application of sensible force. It is opposed to *fluidity*.

That which hinders the approach of two bodies moving one toward another, I call *solidity*. *Locke*.

2. Fulness of matter; opposed to *hollowness*.—3. Moral firmness; soundness; strength; validity; truth; certainty; as opposed to *weakness* or *fallaciousness*; as, the *solidity* of arguments or reasoning; the *solidity* of principles, truths, or opinions.—4. In *geom.*, the quantity of space contained or occupied by a solid body; called also its *solid content* or *contents*. The *solidity* of a body is estimated by the number of cubic inches, feet, yards, &c., which it contains. The method of ascertaining the *solidity* or *solid content* of different solids, forms a branch of measurement.—5. In *physical science*, that property of matter by which it excludes all other bodies from the space which itself occupies. In this sense, the word is synonymous with *impenetrability*.

**SOLIDLY**, *adv.* Firmly; densely; compactly; as, the parts of a pier *solidly* united.—2. Firmly; truly; on firm grounds.

A complete brave man ought to know *solidly* the main end of his being in the world. *Digby*.

**SOLIDNESS**, *n.* The quality of being firm, dense, or compact; firmness; compactness; *solidity*; as, of material bodies.—2. Soundness; strength; truth; validity; as, of arguments, reasons, principles, &c.

**SOLIDUM**, *n.* [L.] In *arch.*, the die of the pedestal—*To be bound in solidum*, in *Scots law*, is to be bound for the whole debt, although only one of several obligants. Where several debtors are bound each for his own share, they are said to be bound *pro rata*.

**SOLIDUNGULATES**, or **SOLIDUNGULA**, *n.* [See the adj.] A tribe of mammals, including those which have the hoofs whole or undivided; as the horse, ass, &c.

**SOLIDUNGULOUS**, *a.* [L. *solidus*, solid, and *ungula*, hoof.] Having hoofs that are whole or not cloven. A horse is a *solidungulous* animal.

**SOLIFIDIAN**, *n.* [L. *solus*, alone, and *fides*, faith.] One who maintains that faith alone, without works, is necessary to justification.

**SOLIFIDIAN**, *a.* Holding the tenets of Solifidians.

**SOLIFIDIANISM**, *n.* The tenets of Solifidians.

**SOLILOQUIZE**, *v. i.* To utter a soliloquy.

**SOLILOQUIZING**, *ppr.* Uttering a soliloquy.

**SOLILOQUY**, *n.* [Fr. *soliloque*; L. *solus*, alone, and *loquor*, to speak.] 1. A talking to one's self; a monologue; a talking or discourse of a person alone, or not addressed to another person, even when others are present.

Lovers are always allowed the comfort of *soliloquy*. *Spectator*.

2. A written composition, reciting what it is supposed a person speaks to himself. The whole poem is a *soliloquy*. *Prior*.

**SOLIPED**, *n.* [L. *solus*, alone, or *solidus* and *pes*, foot. But the word is ill formed.] An animal whose hoof is not cloven. The *solipeds* constitute a group of quadrupeds with undivided hoofs, as for example, the Linnaean genus *Equus*.

**SOLIP'EDOUS**, *a.* Having hoofs which are not cloven.

**SOLITAIRE**, *n.* [Fr. *solitaire*, from L. *solitarius*. See **SOLITARY**.] 1. A person who lives in solitude; a recluse; a hermit.—2. An ornament for the neck; a diamond set alone, without other stones round it.—3. A game which one person can play alone.—4. A name given to a bird allied to the Dodo.

**SOLITARIAN**, *n.* A hermit.

**SOLITAR'ETY**, *n.* State of being solitary.

**SOLITARILY**, *adv.* [from *solitary*.] In solitude; alone; without company.

Feed thy people with thy rod, the flock of thy heritage, that dwell *solitarily* in the wood; *Mic. xvi*.

**SOLITARINESS**, *n.* The state of being alone; forbearance of company; retirement, or habitual retirement. At home, in wholesome *solitariness*. *Donne*. 2. Solitude; loneliness; destitution of company or of animated beings; *applied to place*; as, the *solitariness* of the country or of a wood.

**SOLITARY**, *a.* [Fr. *solitaire*; L. *solitarius*, from *solus*, alone.] 1. Living alone; not having company. Some of the more ferocious animals are *solitary*, seldom or never being found in flocks or herds. Thus the lion is called a *solitary* animal.

Those rare and *solitary*, these in flocks. *Milton*.

2. Retired; remote from society; not having company, or not much frequented; as, a *solitary* residence or place.—3. Lonely; destitute of company; as, a *solitary* life.—4. Gloomy; still; dismal.

Let that night be *solitary*, let no joyful voice come therein; *Job iii*.

5. Single; as, a *solitary* instance of vengeance; a *solitary* example.—6. In *bot.*, separate; one only in a place; as, a *solitary* stipule. A *solitary flower* is when there is only one to each peduncle; a *solitary seed*, when there is only one in a pericarp.

**SOLITARY**, *n.* One that lives alone or in solitude; a hermit; a recluse.

**SOLITUDE**, *n.* [Fr. from L. *solitudo*; from *solus*, alone.] 1. Loneliness; a state of being alone; a lonely life.

Whoever is delighted with *solitude*, is either a wild beast or a god. *Bacon*.

2. Loneliness; remoteness from society; destitution of company; *applied to place*; as, the *solitude* of a wood or a valley; the *solitude* of the country.

The *solitude* of his little parish is become matter of great comfort to him. *Law*.

3. A lonely place; a desert.

In these deep *solitudes* and awful cells, Where heavenly pensive contemplation dwells. *Pope*.

**SOLIVAGANT**, *a.* [L. *solivagus*; *solus*, alone, and *vagor*, to wander.] Wandering alone.

**SOLIVE**, *n.* [Fr.] A joist, rafter, or piece of wood, either slit or sawed, with which builders lay their ceilings. Rarely used in the English language.

**SOL'LAR**, *n.* [Low L. *solarium*.] Originally an open gallery or balcony at the top of a house, exposed to the sun; but latterly used to signify any upper room, loft, or garret.

**SOLLE'CITO**. [It. *afflicted*.] In *music*, a term denoting that the movement to which it is affixed is to be performed in a mournful style. It is also used to signify that the music is to be performed with care.

**SOL'LERET**, *n.* In *ancient armour*, *sollerets* were the overlapping plates



Right Jamb and Solleret, 15th century

that formed the mailed shoe of an armed knight.

**SOLMIZA'TION**, or **SOLMISA'TION**, *n.* [from *sol, mi*, musical notes.] In *singing*, a *solfa*, or the art of applying to the seven notes of the scale certain syllables having no meaning in themselves, but containing the five first vowels, according to the French method, and the four first according to the system adopted by the Italians and English. The syllables used in the French system are *ut, re, mi, fa, sol, la, si*. Those used by the Italians and English are *do, re, mi, fa, sol, la, si, do*, which correspond to the letters *C, D, E, F, G, A, B, C*.

**SOL'LO**, *n.* [It. from L. *solus*, alone.] A tune, air, or strain to be played by a single instrument, or sung by a single voice.

**SOL'OMON'S LEAF**, *n.* A plant.

**SOL'OMON'S SEAL**, *n.* The common name of several British perennial plants, of the genus *convallaria*, which grow in woods. [See **CONVALLARIA**.]

**SOLSTICE**, *n.* [Fr. from L. *solstitium*; *sol*, the sun, and *sto*, to stand; It. *solstizio*; Sp. *solsticio*.] In *astron.*, the point in the ecliptic at the greatest distance from the equator, at which the sun stops or ceases to recede from the equator, either north in summer, or south in winter; a tropic or tropical point. There are two solstices; the summer solstice, the first degree of Cancer, which the sun enters on the 21st of June, and the winter solstice, the first degree of Capricorn, which the sun enters on the 22d of December.—2. The time at which the sun is at its greatest distance from the equator, and when its diurnal motion in declination ceases, which happens at midsummer and midwinter.

**SOLSTY'IAL**, *a.* Pertaining to a solstice; as, a *solstitial* point. The *solstitial points*, those two points in the ecliptic which are farthest from the equator, and at which the sun arrives at the time of the solstices. They are diametrically opposite to each other, and the distance of each from the equator is equal to the obliquity of the ecliptic. *Solstitial Colure*. [See **COLURE**.]—2. Happening at a solstice; usually with us, at the summer solstice or midsummer; as, *solstitial* heat.

**SOLUBIL'ITY**, *n.* [from *soluble*.] The quality of a body which renders it susceptible of solution; susceptibility of being dissolved in a fluid. The *solubility* of resins is chiefly confined to spirits or alcohol.

**SOL'UBLE**, *a.* [L. *solubilis*, from *solvo*, to melt.] Susceptible of being dissolved in a fluid; capable of solution. Sugar is *soluble* in water; salt is *soluble* only to a certain extent, that is, till the water is saturated.

**SOL'UBLENESS**, *n.* Solubility.



**SOLUS**, *a.* [Lat.] Alone. *Sola* is the feminine form; and is to be used, in dramatic directions, when a female is in question.

**SOLUTE**, *a.* [L. *solutus, solvo*.] 1. † In a general sense, loose; free; as, a *solute* interpretation.—2. In *bot.*, loose; not adhering; opposed to *adnate*; as, a *solute* stipule.

**SOLUTE**, † *v. t.* To dissolve.

**SOLUTION**, *n.* [Fr.; from L. *solutio*, from *solvo*, to loosen, melt, dissolve. See **SOLVE**.] 1. The act of separating the parts of any body; disruption; breach.—2. The reduction of any solid body to a liquid state by means of some solvent.—3. A feeble combination, in which, with a mere mechanical change of properties, and without regard to definite proportions, one or more solids are equally diffused through some liquid. This mode of combination is so weak, that the liquid may be evaporated from the solid or solids, leaving them unchanged, except in texture or aggregation. There is usually, and probably always, a limit to the quantity of the solid or solids which can be dissolved by a given liquid, and this is called *saturation*. The liquid in which the solution is effected is called the *solvent* or *menstruum*.

*Note*.—This word is not used in chemistry or mineralogy for the melting of bodies by the heat of fire. The term *solution* is applied to a very extensive class of phenomena. When a solid disappears in a liquid, if the compound exhibits perfect transparency, we have an example of *solution*. The word is applied both to the act of combination and to the result of the process. Thus common salt disappears in water, that is, its solution takes place, and the liquid obtained is called a *solution of salt in water*. Solution is the result of attraction or affinity between the fluid and the solid. This affinity continues to operate to a certain point, where it is overbalanced by the cohesion of the solid; it then ceases, the fluid is said to be *saturated*, the point where the operation ceases is called *saturation*, and the fluid is called a *saturated solution*.—*Solution* is a true chemical union. *Mixture* is a mere mechanical union of bodies.—4. Resolution; explanation; the act of explaining or removing difficulty or doubt; as, the *solution* of a difficult question in morality; the *solution* of a doubt in casuistry.—5. Release; deliverance; discharge.—6. In *math.*, the method of resolving a problem, whether algebraical or geometrical, or of finding that which the problem requires to be found; but the word is frequently understood to apply to the answer, or result of the operation itself.—*Solution of continuity*, the separation of connection or connected substances or parts; applied, in surgery, to a fracture, laceration, &c.

**SOLUTIVE**, *a.* Tending to dissolve; loosening; laxative.—2. That can be dissolved or loosened.

**SOLVABILITY**, *n.* Ability to pay all just debts.

**SOLVABLE**, *a.* That may be solved, resolved, or explained.—2. That can be paid.

**SOLVABLENESS**, *n.* Solvability.

**SOLVE**, *v. t.* (solv.) [L. *solvo*; Fr. *soudre*.] 1. Properly, to loosen or separate the parts of any thing; hence,

to explain; to resolve; to eclaireise; to unfold; to clear up; as what is obscure or difficult to be understood; as, to *solve* questions; to *solve* difficulties or a problem.

When God shall *solve* the dark decrees of fate. *Tickell*

2. To remove; to dissipate; as, to *solve* doubts.

**SOLVED**, *pp.* Explained; resolved.

**SOLVENCY**, *n.* [L. *solvens*.] Ability to pay all debts or just claims; as, the *solvency* of a merchant is undoubted. The credit of a nation's notes depends on a favourable opinion of its *solvency*.

**SOLVEND'**, *n.* A substance to be dissolved.

**SOLVENT**, *a.* Having the power of dissolving; as, a *solvent* body.—2. Able to pay all just debts. The merchant is *solvent*.—3. Sufficient to pay all just debts. The estate is *solvent*.

**SOLVENT**, *n.* Any fluid or substance that dissolves, or renders liquid, other bodies, is called the *solvent*, or *menstruum*. Water is of all *solvents* the most universal and useful. The *solvent* of resinous bodies is alcohol, and of some other similarly constituted substances. Naphtha, oil of turpentine, and ether, are *solvents* of caoutchouc; chlorine, and aqua regia, or nitro-muriatic acid, are *solvents* of gold. In most cases, heat increases the solvent powers of bodies.

**SOLVER**, *n.* One who solves or explains.

**SOLVIBLE**, *a.* Solvable,—which see.

**SOMATIC**, } † *a.* [Gr. *σωματικος*,  
**SOMATICAL**, } from *σωμα*, body.]  
Corporeal; pertaining to a body.

**SOMATIST**, *n.* [supra.] One who admits the existence of corporeal or material beings only; one who denies the existence of spiritual substances.

**SOMATOL'OGY**, *n.* [Gr. *σωμα*, body, and *λογος*, discourse.] The doctrine of bodies or material substances.—2. That branch of physics which treats of matter and its properties.

**SOMBRE**, *a.* [Fr. *sombre*, from Sp. *sombra*, a shade.] Dull; dusky; cloudy; gloomy.

**SOM'BRENESS**, *n.* Darkness; gloominess.

**SOM'BROUS**, *a.* Gloomy.

**SOM'BROUSLY**, *adv.* Gloomily.

**SOM'BROUSNESS**, *n.* State of being sombrous.

**SOME**, *a.* (sum.) [Sax. *sum*, *sume*; D. *somme*; Sw. and Dan. *sum*, who.]

1. Noting a certain quantity of a thing, but indeterminate; a portion greater or less. Give me *some* bread; drink *some* wine; bring *some* water.—2. Noting a number of persons or things, greater or less, but indeterminate.

*Some* theoretical writers allege that there was a time when there was no such thing as society. *Blackstone*

3. Noting a person or thing, but not known, or not specific and definite. *Some* person, I know not who, gave me the information. Enter the city, and *some* man will direct you to the house.

Most gentlemen of property, at some period or other of their lives, are ambitious of representing their county in parliament. *Blackstone*

4. Noting indeterminately that a thing is not very great; moderate; as, the censure was, to *some* extent, just.—5. It sometimes precedes a word of num-

ber or quantity, with the sense of *about* or *near*, noting want of certainty as to the specific number or amount, but something near it; as, a village of *some* eighty houses; *some* two or three persons; *some* seventy miles distant; an object at *some* good distance.—6. *Some* is often opposed to *others*. *Some* men believe one thing, and *others* another.—7. *Some* is often used without a noun, and then, like other adjectives, is a substitute for a noun or a pronoun. We consumed *some* of our provisions, and the rest was given to the poor.

*Some* to the shores do fly,

*Some* to the woods. *Daniel*

Your edicts *some* reclaim from sins,

But most your life and blest example wins. *Dryden*

8. *Some* is used as a termination of certain adjectives, as in *handsome*, *mettlesome*, *blithesome*, *fulsome*, *lonesome*, *gladsome*, *gamesome*. In these words, *some* has primarily the sense of little, or a certain degree; a little *blithe* or *glad*. But in usage, it rather indicates a considerable degree of the thing or quantity; as, *mettlesome*, full of mettle or spirit; *gladsome*, very glad or joyous.

**SOMEBODY**, *n.* [*some* and *body*.] A person unknown or uncertain; a person indeterminate.

Jesus said, *Somebody* hath touched me; Luke viii.

We must draw in *somebody* that may stand 'Twixt us and danger. *Denham*

2. A person of consideration.

Before these days rose up Theudas, boasting himself to be *somebody*; Acts v.

**SOMEDEAL**, † *adv.* [*some* and *deal*.] In some degree.

**SOMEHOW**, *adv.* [*some* and *how*] One way or other; in some way not yet known. The thing must have happened *somehow* or other.

**SOMERSAULT**, } *n.* (Old Fr. *soubresaut*,  
**SOMERSET**, } *sault*; Sp. *sobresaltar*,  
to exceed in height, to leap over;  
*sobresaltar*, to surprise; It. *soprasalire*,  
to attack unexpectedly; *soprasalto*,  
an overleap; L. *super* and *salio*,  
to leap.) A leap by which a person jumps from a height, turns over his head, and falls upon his feet.

**SOMETHING**, *n.* [*some* and *thing*.] An indeterminate or unknown event.

*Something* must have happened to prevent the arrival of our friends at the time fixed. I shall call at two o'clock, unless *something* should prevent. [*See THING*.]—2. A substance or material thing, unknown, indeterminate, or not specified. A machine stops because *something* obstructs its motion. There must be *something* to support a wall or an arch.—3. A part; a portion more or less; a thing meriting consideration.

*Something* yet of doubt remains. *Milton*

Still from his little he could *something* spare,

To feed the hungry and to clothe the bare. *Hayte*

*Something* of it arises from our infant state. *Watts*

4. A little; an indefinite quantity or degree. The man asked me a crown, but I gave him *something* more.—5. Distance not great.

It must be done to-night, and *something* from the palace. *Shak*

6. *Something* is used adverbially for in some degree; as, he was *something* discouraged; but the use is not elegant.

**SOMETIME**, *adv.* [*some and time.*] Once; formerly.

That fair and warlike form,  
In which the majesty of buried Denmark  
Did *some* time march. *Shak.*

2. At one time or other hereafter. [*Sometime* is really a compound noun, and *at* is understood before it; *at some time.*]

**SOMETIMES**, *adv.* [*some and times.*] At times; at intervals; not always; now and then. We are *sometimes* indisposed, *sometimes* occupied, *sometimes* at leisure; that is, *at some times.*

It is good that we be *sometimes* contradicted. *Taylor.*

2. At one time; opposed to *another time.*

**SOMEWHAT**, *n.* [*some and what.*] Something, though uncertain what.—2. More or less; a certain quantity or degree, indeterminate.

These salts have *somewhat* of a nitrous taste. *Greiv.*

3. A part, greater or less.

*Somewhat* of his good sense will suffer in this transfusion, and much of the beauty of his thoughts will be lost. *Dryden.*

**SOMEWHAT**, *adv.* In some degree or quantity. This is *somewhat* more or less than was expected; he is *somewhat* aged; he is *somewhat* disappointed; *somewhat* disturbed.

**SOMEWHERE**, *adv.* [*some and where.*] In some place, unknown or not specified; in one place or another. He lives *somewhere* in obscurity. *Dryden* *somewhere* says, peace to the manes of the dead.

**SOMEWHILE**, *adv.* [*some and while.*] Once; for a time.

**SOMEWHITHER**, *adv.* To some indeterminate place.

**SOMMERING**. See **SUMMERING**.

**SOM'MITE**, *n.* Nepheline; a mineral which occurs in small crystals and crystalline grains in the lava of Mount Somma, on Vesuvius.

**SOMNAMBULATION**, *n.* [*L. somnus, sleep, and ambulo, to walk.*] The act of walking in sleep.

**SOMNAMBULE**, *n.* A sleep-walker.

**SOMNAMBULIC**, *a.* Walking in sleep; pertaining to somnambulism.

**SOMNAMBULISM**, *n.* [*supra.*] The act or practice of walking in sleep. The term, however, is generally used in a more extended sense, to comprehend all the phenomena that take place when a person, apparently insensible to external objects, acts as if he were in a state of consciousness. The phenomena of sleep-walking are very singular, the person affected performing many voluntary actions implying to all appearance a certain degree of perception of the presence of external objects. The somnambulist gets out of bed, often dresses himself, goes out of doors, and walks frequently over very dangerous places in safety. On awaking in the morning, he is either utterly unconscious of having stirred during the night, or remembers it as a mere dream. Sometimes the transactions of the somnambulist are carried much farther; he will mount his horse and ride, or go to his usual occupation. In some cases, somnambulists are capable of holding conversation. The term Somnambulism is also used to denote a certain state of a person under the influence of animal magnetism, in which the patient is said to recover his internal consciousness, while his outward senses are

still asleep, and is enabled to see and hear with the pit of his stomach, the ends of his fingers, &c. &c. [*See MESMERISM.*]

**SOMNAMBULIST**, *n.* A person who walks in his sleep.

**SOM'NER**, *†* for *Summoner*.

**SOMNIFEROUS**, *a.* [*L. somnifer; somnus, sleep, and fero, to bring; Fr. somnifère.*] Causing or inducing sleep; soporific; as, a *somniferous* potion.

**SOMNIFIC**, *a.* [*L. somnus, sleep, and facio, to make.*] Causing sleep; tending to induce sleep.

**SOMNIF'OUENCE**, *n.* The act or custom of talking in sleep.

**SOMNIF'OUISM**, *n.* Somnifouence, or sleep-talking.

**SOMNIF'QUIST**, *n.* One who talks in his sleep.

**SOMNIF'QUOUS**, *a.* Apt to talk in sleep.

**SOMNIF'QUY**, *n.* The talking of one in a state of somniphathy.

**SOMNIF'QUY**, } *n.* [*L. somnus and SOMNIF'QUISM,* } *loquor.*] A talking or speaking in sleep.

**SOMNIP'ATHIST**, *n.* A person in a state of somniphathy.

**SOMNIP'ATHY**, *n.* [*L. somnus, sleep; and Gr. πάθος, suffering.*] Sleep from sympathy, or by the process of mesmerism.

**SOM'NIUM**, *n.* [*L.*] A dream; a combination of ideas or images that present themselves to the mind during sleep.

**SOM'NOLENCE**, } *n.* [*Low L. somno-  
**SOM'NOLENCY**, } *lentia; from som-*  
*nus, sleep.*] Sleepiness; drowsiness; inclination to sleep.*

**SOM'NOLENT**, *a.* Sleepy; drowsy; inclined to sleep.

**SOM'NOLENTLY**, *adv.* Drowsily.

**SOM'NUS**, *n.* In *classical mythology*, the god of sleep, the son of Erebus and Nox, or of Nox alone.

**SÓN**, *n.* [*Sax. sunu; G. sohn; Dan. søn; Sans. sunu.*] 1. A male child; the male issue of a parent, father, or mother. Jacob had twelve *sons*. Ishmael was the *son* of Hagar by Abraham.—2. A male descendant, however distant; hence in the plural, *sons* signifies descendants in general, a sense much used in the Scriptures. The whole human race are styled *sons of Adam*.—3. The compellation of an old man to a young one, or of a confessor to his penitent; or of a priest or teacher to his disciple; a term of affection. Eli called Samuel his *son*. Be plain, good *son*, and homely in thy drift. *Shak.*

4. A native or inhabitant of a country; as, the *sons* of Britain. Let our country never be ashamed of her *sons*.—5. The produce of any thing.

Earth's tall *sons*, the cedar, oak, and pine. *Blackmore.*

*Note.*—The primary sense of *child* is produce, issue; a shoot.—6. One adopted into a family.

Moses was the *son* of Pharaoh's daughter; Exod. ii.

7. One who is converted by another's instrumentality, is called his *son*; also, one educated by another; as, the *sons* of the prophets.—8. Christ is called the *Son* of God, as being conceived by the power of the Holy Spirit, or in consequence of his relation to the Father.—9. *Son* of pride, *sons* of light, *son* of Belial. These are Hebraisms, which denote that persons possess the qualities of pride, of light, or of Belial,

as children inherit the qualities of their ancestors.

**SON'ATA**, *n.* [*It. See SOUND.*] A tune intended for an instrument only, as *cantata* is for the voice. It is generally a free composition for exhibiting the composer's powers, without confining him within the rigid rules of counterpoint or measure.

**SON'EHUS**, *n.* A genus of plants, nat. order Compositæ, sub-order Cichoraceæ. The species are inhabitants of Europe, Asia, Africa, and America, and four are natives of Great Britain, where they are known by the name of sow-thistle. The most common species is *S. oleraceus*, the common sow-thistle. It has downy sunbellate flower-stalks; small yellow flowers, and a conical involucre when in seed, and is greedily fed upon by many animals. It grows in waste places, the borders of fields, and hedges.

**SON'DERBUND**. [*Ger.*] A league of the following seven Roman Catholic Cantons of Switzerland, namely, Lucerne, Friburg, Uri, Schwytz, Unterwalden, Zug, and Valais, which was formed in 1846, and was crushed in 1847, by the united power of the fifteen cantons; the sonderbund being an infraction of the federative constitution, as amended in 1845.

**SONG**, *n.* [*Sax. sang; G. sang, gesang. See SING.*] 1. In general, that which is sung or uttered with musical modulations of the voice, whether of the human voice or that of a bird.—2. A little poem to be sung, or uttered with musical modulations; a ballad. The term is applied to either a short poetical or musical composition, but most frequently to both in union. As a poetical composition it may be largely defined a short poem divided into portions of returning measure, and turning upon some single thought or feeling. As a union of poetry and music, it may be defined a very brief lyrical poem, founded commonly upon agreeable subjects, to which is added a melody for the purpose of singing it. As denoting a musical composition, *song* is used to signify a vocal melody of any length or character, and not confined to a single movement; but as regards performance, it is confined to an air for a single voice. [*See AIR, BALLAD, CANZONET.*] The songs of a country are characteristic of its manners. Every country has its love *songs*, its war *songs*, and its patriotic *songs*.—3. A hymn; a sacred poem or hymn to be sung either in joy or thanksgiving, as that sung by Moses and the Israelites after escaping the dangers of the Red Sea and Pharaoh's wrath; or of lamentation, as that of David over the death of Saul and Jonathan. *Songs* of joy are represented as constituting a part of heavenly felicity.—4. A lay; a strain; a poem.

The bard that first adorn'd our native tongue,  
Tun'd to his British lyre this ancient *song*. *Dryden.*

5. Poetry; poesy; verse.

The subject for heroic *song* *Milton.*

6. Notes of birds. [*See DEF. 1.*]

7. A mere trifle.

The soldier's pay is a *song*. *Silliman.*  
*Old song*, a trifle.

I do not intend to be thus put off with an *old song*. *More.*

**SONG-BIRD**, *n.* A bird that sings.

The nightingale is generally considered the sweetest of *song-birds*.

**SONG-ENNOBLED**, *a.* Ennobled in song.

**SONG'ISH**, *a.* Consisting of songs. [*Low and not in use.*]

**SONG'STER**, *n.* [*song* and Sax. *steora*, one that steers.] 1. One that sings; one skilled in singing; not often applied to human beings, or only in slight contempt.—2. A bird that sings; as, the little *songster* in his cage. [*In this use, the word is elegant.*]

**SONG'STRESS**, *n.* A female singer.

**SONIF'EROUS**, *a.* [*L. sonus*, sound, and *fero*, to bear.] Sounding; producing sound.

**SON-IN-LAW**, *n.* A man married to one's daughter.

**SON'NET**, *n.* [*Fr.* from *It. sonetta*; *Sp. soneta*. See **SOUND**.] 1. A short poem of fourteen lines, two stanzas of four verses each and two of three each, the rhymes being adjusted by a particular rule. The sonnet is a form of poetry much used by the Italian and Spanish poets; but not much in Britain, Germany, or France. The proper sonnet consists of two quatrains, with four lines and two rhymes each, and two tercines, each with three lines and a single rhyme. The last six lines, however, are susceptible of various arrangements; the one usually adopted in English is the rhyming of the fifth and sixth lines together, frequently after a full pause, so that the sonnet ends with a point, as in an epigram. The sonnet generally consists of one principal idea, pursued through the various antitheses of the different strophes. The lightness and richness of the Italian and Spanish languages enable their poets to express every feeling or fancy in the sonnet; but with us it has been found most suitable to grave, dignified, and contemplative subjects. Our best writers of sonnets are Milton and Wordsworth.—2. A short poem. Have a *sonnet* that will serve the turn. *Shak.*

**SON'NET**, *v. i.* To compose sonnets.

**SONNETEER**, *n.* [*Fr. sonnetier*.] A composer of sonnets or small poems; a small poet; usually in contempt.

**SONNETER**, *v. i.* or **SON'NETIST**, *v. i.* A sonneteer.

**SONNETIZE**, *v. i.* To compose sonnets.

**SONOMETER**, *n.* [*L. sonus*, sound, and *Gr. μετρον*, to measure.] An instrument for measuring sounds or the intervals of sounds.

**SONORIF'IC**, *a.* [*L. sonus*, sound, and *facio*, to make.] Producing sound; as, the *sonorific* quality of a body.

**SONOROUS**, *a.* [*L. sonorus*, from *sonus*, sound.] 1. Giving sound when struck. Metals are *sonorous* bodies.—2. Loud sounding; giving a clear or loud sound; as, a *sonorous* voice.—3. Yielding sound; as, the vowels are *sonorous*.—4. High sounding; magnificent of sound.

The Italian opera, amidst all the meanness and familiarity of the thoughts, has something beautiful and *sonorous* in the expression. *Addison*.

**SONOROUSLY**, *adv.* With sound; with a high sound.

**SONOROUSNESS**, *n.* The quality of yielding sound when struck, or coming in collision with another body; as, the *sonorousness* of metals.—2. Having or giving a loud or clear sound; as, the *sonorousness* of a voice or an instrument.—3. Magnificence of sound.

**SONSHIP**, *n.* [from *son*.] The state of being a son, or of having the relation of a son.—2. Filiation; the character of a son.

**SON'SY**, **SON'SIE**, *a.* Lucky; fortunate; happy; good humoured; well conditioned; plump; thriving; having sweet engaging looks. [*Scotch.*]

**SOO'DRA**, **SU'DRA**, or **SOOD'ER**, *n.* The fourth caste into which the Hindoos are divided. It comprehends the artizans and labourers. [*See CASTE.*]

**SOO'FEE**, *n.* Among Mohammedans, an infidel.

**SOO'FEEISM**, *n.* Mohammedan infidelity.

**SOO'JA**, *n.* A Japanese sauce prepared from seeds of *Dolichos soja*, or *Soja hispida*. It is known in this country by the name of soy. The same name is also applied to the Chinese sauce called kitjop.

**SOON**, *adv.* [*Sax. sona*; *Goth. suns*.] 1. In a short time; shortly after any time specified or supposed; as, *soon* after sunrise; *soon* after dinner; I shall *soon* return; we shall *soon* have clear weather.—2. Early; without the usual delay; before any time supposed.

How is it that ye have come so *soon* to-day? *Exod. ii.*

3. Readily; willingly. But in this sense it accompanies *would*, or some other word expressing *will*.

I *would* as *soon* see a river winding among woods or in meadows, as when it is tossed up in so many whimsical figures at Versailles. *Addison*.

As *soon* as, so *soon* as, immediately at or after another event. As *soon* as the mail arrives, I will inform you.

As *soon* as Moses came nigh to the camp, he saw the calf and the dancing; *Exod. xxxiii.*

**SOON**, *v. i.* Speedy; quick.

**SOON'DRY-TREE**, } *n.* The *Heritiera*  
**SUN'DER-TREE**, } *robusta*, a native of India. This tree gives name to the *Sonderbunds*, or great forest of *soondry trees*; a woody tract of country, 180 miles long, on the bay of Bengal, forming the delta of the Ganges.

**SOO'NEE**, *n.* One of a Mohammedan sect. Such sectaries are also called *sonnites* and *sunnies*.

**SOON'LY**, *adv.* Quickly; speedily.

**SOO'PE MATI**, *n.* In the *East Indies*, a native carbonate of soda, or mineral alkali.

**SOOSHONG'**, *n.* A kind of black tea. [*See SOUCHONG.*]

**SOO'SOO**, *n.* Among the Bengalese, the name of a cetaceous mammal, the *Soosoo Gangeticus* of Lesson.

**SOOT**, *n.* [*Sax. sot*; *Ir. suth*; *W. sota*, soot, that which is volatile or sudden. But *qu.* for the word is from the *Ar. sauda*, to be black.] A black substance formed by combustion, or disengaged from fuel in the process of combustion, rising in fine particles and adhering to the sides of the chimney or pipe conveying the smoke. The soot of coal and that of wood differ very materially in their composition; the former does not indeed appear to have been accurately analyzed, but it evidently contains more carbonaceous matter than the latter. Coal soot contains substances usually derived from animal matter; also sulphate and hydrochlorite of ammonia; and has been used for the preparation of the carbonate. It contains likewise an empyreumatic oil; but its chief basis is charcoal, in a state in which it is capa-

ble of being rendered soluble by the action of oxygen and moisture; and hence, combined with the action of the ammoniacal salts, it is used as a manure, and acts very powerfully as such. The soot of wood has been minutely analysed, and found to consist of fifteen different substances, of which ulmin, azotized matter, carbonate of lime, water, acetate and sulphate of lime, acetate of potash, carbonaceous matter insoluble in alkalies, are the principal. The soot of burned pine forms lampblack.

**SOOT**, *v. t.* To cover or foul with soot.

**SOOTE**, *v. i.* or **SOTE**, *v. i.* Sweet.

**SOOTED**, *pp.* Covered or soiled with soot.

**SOOT'ERKIN**, *n.* A kind of false birth, fabled to be produced by the Dutch women from sitting over their stoves.

**SOOTH**, *v. i.* [*Sax. soth*; *Ir. sooth*.]

1. Truth; reality.—2. † Prognostication.—3. † Sweetness; kindness.

**SOOTH**, *v. i.* Pleasing; delightful.—2. † True; faithful.

**SOOTHE**, *v. t.* [*Sax. gesothian*, to flatter. There seems to be a connection between this verb and the preceding *sooth*. The sense of *setting*, *allay*, or softening, would give that of *truth*, and of *sweet*, that is, *smooth*.] 1. To flatter; to please with blandishments or soft words.

Can I *soothe* tyranny? *Dryden*.  
I've tried the force of every reason on him,  
*Sooth'd* and caress'd, been angry, *sooth'd*  
again. *Addison*.

2. To soften; to assuage; to mollify; to calm; as, to *soothe* one in pain or passion; or to *soothe* pain. It is applied both to persons and things.—3. To gratify; to please.

*Sooth'd* with his future fame. *Dryden*.

**SOOTH'ED**, *pp.* Flattered; softened; calmed; pleased.

**SOOTH'ER**, *n.* A flatterer; he or that which softens or assuages.

**SOOTH'ING**, *pp. or a.* Flattering; softening; assuaging.

**SOOTH'INGLY**, *adv.* With flattery or soft words.

**SOOTH'LY**, *adv.* In truth; really.

**SOOTH'SAY**, *v. i.* [*sooth* and *say*.] To foretell; to predict; Acts xvi. [*Little used.*]

**SOOTH'SAYER**, *n.* A foreteller; a prognosticator; one who undertakes to foretell future events without inspiration.

**SOOTH'SAYING**, *n.* The foretelling of future events by persons without divine aid or authority, and thus distinguished from *prophecy*.—2. † A true saying; truth.

**SOOT'INESS**, *n.* [from *sooty*.] The quality of being sooty or foul with soot; fuliginousness.

**SOOT'ISH**, *a.* Partaking of soot; like soot.

**SOOT'Y**, *a.* [*Sax. sotig*.] 1. Producing soot; as, *sooty* coal.—2. Consisting of soot; fuliginous; as, *sooty* matter.—3. Foul with soot.—4. Black like soot; dusky; dark; as, the *sooty* flag of Acheron.

**SOOT'Y**, *v. t.* To black or foul with soot. [*Not authorized.*]

**SOP**, *n.* [*D. sop*; *Sax. sop*; *G. suppe*, soup; *Fr. soupe*. *Qu. soap*.] 1. Any thing steeped or dipped and softened in liquor, but chiefly something thus dipped in broth or liquid food, and intended to be eaten.

*Sops* in wine, quantity for quantity, inebriate more than wine itself. *Bacon*.

2. Any thing given to pacify; so called from the sop given to Cerberus, in mythology. Hence the phrase, to give a *sop* to Cerberus.—*Sop*-*in wine*, a kind of pink.

SOP, *v. t.* To steep or dip in liquor.

SOPE. See SOAP.

SOPH, *n.* [L. *sophista*.] A certain distinction or title which under graduates in the university of Oxford assume, previous to their examination for a degree. It took its rise from the exercises which students formerly had to go through, but which are now out of use. [See SOPHISTER.]

SOPHI, *n.* A title of the king of Persia.

SOPHICAL, *† a.* [Gr. *σοφία*, wise; *σοφία*, wisdom.] Teaching wisdom.

SOPHISM, *n.* [Fr. *sophisme*; L. *sophisma*; Gr. *σοφισμα*.] A specious proposition; a specious but fallacious argument; a subtilty in reasoning; an argument that is not supported by sound reasoning, or in which the inference is not justly deduced from the premises. According to Aristotle, a sophism is the use of some word in a different sense in the premises from that in the conclusion. The following, called the "*lying sophism*," was a famous problem among the ancient sophists: "When a man says, I lie, does he lie, or does he not lie? If he lies, he speaks truth, and if he speaks the truth, he lies." *Ignoratio elenchi*, or a mistake of the question; *Petitio principii*, or a supposition of what is not granted, and reasoning in a circle, are species of sophisms.

When a false argument puts on the appearance of a true one, then it is properly called a *sophism* or fallacy.

SOPHIST, *n.* [L. *sophista*; Fr. *sophiste*; It. *safista*.] 1. A professor of philosophy; as, the *sophists* of Greece. This name was first given to philosophers and those who were eminent for their wisdom and accomplishments. It was afterwards restricted to a bad sense, and applied to a class of men who rose in Greece in the fifth century before Christ, and who went about discoursing and debating, and taught the youth in the principal cities various arts and acquirements for hire. It thence came to be applied generally to all those who spent their time in verbal niceties, verbal quibbles, and philosophical enigmas.—2. A captious or fallacious reasoner.

SOPHISTER, *† n.* [Gr. *σοφιστης*.] The same as *sophist*,—*which see*.—2. In *Cambridge university*, the title of students who are advanced beyond the first year of their residence. The term is also used at Oxford and Dublin, and in some American colleges. In the latter, *sophomore* is the term occasionally used.—2. *†* A professor of philosophy; a *sophist*.

SOPHISTER, *† v. t.* To maintain by a fallacious argument.

SOPHISTIC, *† a.* [Fr. *sophistique*; SOPHISTIC, *†* It. *safistico*.] Fallaciously subtle; not sound; as, *sophistical* reasoning or argument.

SOPHISTICALNESS, *n.* Quality of being *sophistical*.

SOPHISTICALLY, *adv.* With fallacious subtilty.

SOPHISTICATE, *v. t.* [Fr. *sophistiquer*; Sp. *safisticar*.] 1. To adulterate; to corrupt by something spurious or foreign; to pervert; as, to *sophisticate* nature, philosophy, or the understanding.—2. To adulterate; to

render spurious; as, merchandise; as, to *sophisticate* wares or liquors.

They purchase but *sophisticated* ware.

*Dryden.*

SOPHISTICATE, *† a.* Adulterated; SOPHISTICATED, *†* not pure; not genuine.

So truth, when only one supplied the state, Grew scarce and dear, and yet *sophisticated*.

*Dryden.*

SOPHISTICATED, *pp.* Adulterated; corrupted by something spurious or foreign.

SOPHISTICATING, *ppr.* Corrupting; adulterating.

SOPHISTICATION, *n.* The act of adulterating; a counterfeiting or debasing the purity of something by a foreign admixture; adulteration.

SOPHISTICATOR, *n.* One that adulterates; one who injures the purity and genuineness of anything by foreign admixture.

SOPHISTRY, *n.* Fallacious reasoning; reasoning sound in appearance only.

These men have obscured and confounded the nature of things by their false principles and wretched *sophistry*.

*South.*

SOPHOMORE, *n.* In *American colleges*, a *soph* or *sophister*,—*which see*.

SOPHORA, *n.* A genus of plants, nat. order Leguminosae. The species are ornamental shrubs and trees, found in central and tropical Asia, also in the warm parts of North America, and the equinoctial and subtropical parts of South America. The species best known in England are *S. japonica* and *S. chinensis*.

SOPITE, *† v. t.* To lay asleep.

SOPITION, *† n.* [L. *sopio*, to lay asleep.] Sleep.

SOPOR, *n.* [L.] Sleep; a profound sleep.

SOPORATE, *† v. t.* [L. *soporare*.] To lay asleep.

SOPORIFEROUS, *a.* [L. *soporifer*; *sopor*, sleep, and *fero*, to bring; from *sopio*, to lull to sleep; Sans. *sucapa*, sleep. *Sopio* agrees in elements with *sorber*.] Causing sleep, or tending to produce it; somniferous. The poppy possesses *soporiferous* qualities.

SOPORIFEROUSNESS, *n.* The quality of causing sleep.

SOPORIFIC, *a.* [L. *sopor*, sleep, and *facio*, to make.] Causing sleep; tending to cause sleep; as, the *soporific* virtues of opium.

SOPORIFIC, *n.* A medicine, drug, plant, or other thing that has the quality of inducing sleep.

SOPOROUS, or SOPOROSE, *a.* [L. *soporosus*, from *sopor*, sleep.] Causing sleep; sleepy.

SOPPED, *pp.* [from *sop*.] Dipped in liquid food.

SOPPER, *n.* [from *sop*.] One that sops or dips in liquor something to be eaten.

SOPPING, *ppr.* Steeping in liquid food.

SOPRA, [It. above or upper.] In *music*, a term sometimes used to denote the upper or higher part; as *nella parte di sopra*, in the upper part; *di sopra*, above.

SOPRANIST, *n.* A treble singer.

SOPRANO, *n. plur. Soprani.* In *music*, the treble; the highest female voice. The soprano or treble is sung by boys, women, and *castrates*, who are thence called *sopranos* or *sopranists*.

SORB, *n.* [Fr. *sorbe*; It. *sorba*, *sorbo*; L. *sorbum*, *sorbus*.] The service tree or its fruit.

SORB APPLE, *n.* The fruit of the service tree.

SORBATE, *n.* A compound of malic or sorbic acid with a base.

SORBECIENT, *n.* [L. *sorbeo*, to absorb, and *facio*, to make.] In *med.*, that which produces absorption.

SORBECIENT, *a.* In *med.*, producing absorption.

SORBENT. See ABSORBENT.

SORBIC, *a.* Pertaining to the sorbus or service tree; as, *sorbic* acid. *Sorbic acid* is only another name for the malic acid, or a name not at all in use.

SORBILE, *† a.* [L. *sorbeo*.] That may be drank or sipped.

SORBITION, *† n.* [L. *sorbitio*.] The act of drinking or sipping.

SORBONICAL, *a.* Belonging to a sorbonist.

SORBONIST, *n.* A doctor of the Sorbonne in the university of Paris.

SORBONNE, *n.* A celebrated college which existed in Paris for several centuries. It was founded by Robert de Sorbonne, an ecclesiastic of the 13th century, and intended for the education of secular priests in theology. The college of the Sorbonne was one of the four constituent parts of the faculty of theology in the university of Paris; and though the least numerous part, yet from the number of eminent men belonging to it, this college frequently gave name to the whole faculty; and graduates of the university of Paris, though not connected with this college, frequently styled themselves doctors or bachelors of the Sorbonne. The college of the Sorbonne exercised a high influence in ecclesiastical affairs, and on the public mind, especially in the 16th and 17th centuries.

SORBUS, *n.* A Linnæan genus of plants, comprising the mountain ash, rowan tree, and service tree. It is now made a subgenus of *Pyrus*. [See *PYRUS*, MOUNTAIN ASH.]

SORCERER, *n.* [Fr. *sortier*; Arm. *sorca*; supposed to be from L. *sors*, lot.] A conjuror; an enchanter; a magician.

The Egyptian *sozcerers* contended with Moses.

*Watts.*

SORCERESS, *n.* A female magician or enchantress.

SORCEROUS, *a.* Containing enchantments.

SORCERY, *n.* Magic; enchantment; witchcraft; divination by the assistance or supposed assistance of evil spirits, or the power of commanding evil spirits.

Adder's wisdom I have learn'd,  
To fence my ears against thy *sozceries*.

*Milton.*

SORD, for *Sward*. [Vulgar.]

SORDAWALITE, *n.* A mineral so named from Sordawald, in Wibourg. It is nearly black, rarely gray or green; and contains silica, alumina, magnesia, and peroxide of iron.

SORDES, *n.* [L.] Foul matter; excretions; dregs; filthy, useless, or rejected matter of any kind.

SORDET, *n.* [Fr. *sourdine*; It. *sorsordine*,] *dina*; from Fr. *sourd*, L. *surdus*, deaf.] A little pipe in the mouth of a trumpet to make it sound lower or shriller.

SORDID, *a.* [Fr. *sordide*; It. *sordido*; L. *sordidus*, from *sordes*, filth.] 1. Filthy; foul; dirty; gross.

There Charon stands

A *sordid* god.

*Dryden.*

[This literal sense is nearly obsolete.]—2. Vile; base; mean; as, vulgar, *sordid*

mortals.—3. Meantly avaricious; covetous; niggardly.

He may be old  
And yet not *sordid*, who refuses gold.

*Deuham.*

**SOR'DIDLY**, *adv.* Meantly; basely; covetously.

**SOR'DIDNESS**, *n.* Filthiness; dirtiness.—2. Meanness; baseness; as, the execrable *sordidness* of the delights of Tiberius.—3. Niggardliness.

**SORE**, *n.* [Dan. *saar*, a sore, a wound, or an ulcer; *G. geschwur*. See the next word.] 1. A place in an animal body where the skin and flesh are ruptured or bruised, so as to be pained with the slightest pressure.—2. An ulcer; a boil.—3. In *Scripture*, grief; affliction; 2 Chron. vi.

**SORE**, *a.* [Sax. *sar*, pain, also grievous, painful; *G. sehr*; also Sax. *swær*, *swar*, or *swær*, heavy, grievous; *G. schuer*. This seems to be radically the same word as the former. See *Sorrow*.]

1. Tender and susceptible of pain from pressure; as, a boil, ulcer, or abscess is very *sore*; a wounded place is *sore*; inflammation renders a part *sore*.—2. Tender, as the mind; easily pained, grieved, or vexed; very susceptible of irritation from any thing that crosses the inclination.

Malice and hatred are very fretting, and apt to make our minds *sore* and uneasy.

*Tulston.*

3. Affected with inflammation; as, *sore eyes*.—4. Violent with pain; severe; afflictive; distressing; as, a *sore disease*; *sore evil* or calamity; a *sore night*.—5. Severe; violent; as, a *sore conflict*.—6. † Criminal; evil.

**SORE**, *adv.* With painful violence; intensely; severely; grievously.

Thy hand presseth me *sore*.

*Com. Prayer.*

2. Greatly; violently; deeply. He was *sore* afflicted at the loss of his son.

*Sore* sigh'd the knight, who this long sermon heard.

*Dryden.*

**SORE**, † *v. t.* To wound; to make *sore*.

**SORE**, *n.* [Fr. *sor-fucon*.] 1. A hawk of the first year.—2. [Fr. *saur*.] A buck of the fourth year.

**SORECIDÆ**, or **SORICIDÆ**, *n.* A family of insectivorous quadrupeds, comprehending the shrews or shrewmice, *Sorex*, Linn.

**SORE'DIA**, *n. plur.* [from *Gr. sauros*, a heap.] In *bot.*, heaps of pulverulent bodies scattered over the surface of the *thallus*, in lichens. These, along with the *apothecia*, form the reproductive organs of lichens.

**SOREHON**, *n.* [Irish and Scottish.]

**SORN**, } A kind of servile tenure which subjected the tenant to maintain his chieftain gratuitously, whenever he wished to indulge himself in a debauch. So that when a person obtrudes himself on another for bed and board, he is said to *sorn*, or be a *sorner*.

**SOR'EL**, *n.* [*dim. of sore*.] A buck of the third year.

**SOR'EL**, *a.* Of a brownish colour, approaching to red. [See *SORREL*.]

**SORELY**, *adv.* [from *sore*.] With violent pain and distress; grievously; greatly; as, to be *sorely* pained or afflicted.—2. Greatly; violently; severely; as, to be *sorely* pressed with want; to be *sorely* wounded.

**SORENESS**, *n.* [from *sore*.] The tenderness of any part of an animal body, which renders it extremely susceptible of pain from pressure; as, the *soreness* of a boil, an abscess, or wound.—

2. Figuratively, tenderness of mind, or susceptibility of mental pain.

**SOR'EX**, *n.* A Linnæan genus of animals of the order *Bæstia*, now forming an extensive tribe of insectivorous ferines (*Carnassiers*) in the system of Cuvier, and subdivided into different genera. The original generic term was confined to the shrews or shrewmice, which form the type of the family *Soricida*.

**SORGHUM**, *n.* A genus of grasses, the species of which have been sometimes referred to the genus *Holcus*, and sometimes to *Andropogon*, and known by the general name millet. They form tall grasses with succulent stems, and are found in the tropical parts of Asia, whence they have spread to the warmer parts of Europe. *S. vulgare* is the largest of the small cereal grains, and is called in America guinea corn, and in some works the great or Indian millet. The different kinds are called jowary in India, where many of the inhabitants live upon these small dry grains, as upon rice. It has been introduced into the south of Europe, where it is chiefly used for feeding cattle and poultry, but it is also made into cakes.

**SOR'GO**, *n.* A plant of the genus *Sorghum*,—*which see*.

**SOR'L**, *n. plur. sing. Sorus.* [Gr. *σωρος*, a heap.] In *bot.*, a term applied to the

collections of the *theca* or capsules which are found on the edges or the under surface of the fronds of ferns. These are of various forms, and variously arranged. In most instances the *sori* are covered with a peculiar projecting portion of the epidermis, which is called the *indusium*, and forms an important characteristic in the systematic arrangement of these plants.

**SORITES**, *n.* [L. from *Gr. σωρος*, a heap.] In *logic*, an imperfect syllogism, or an abridged form of stating a series of syllogisms; or it is a species of reasoning in which a series of propositions are so linked together, that the predicate of the one becomes continually the next in succession, till a conclusion is formed by bringing together the subject of the first proposition and the predicate of the last. Thus, all men of revenge have their souls often uneasy. Uneasy souls are a plague to themselves. Now to be one's own plague is folly in the extreme. Therefore all men of revenge are extreme fools. A *sorites* has as many middle terms as there are intermediate propositions between the first and the last; and, consequently, it may be drawn out into as many syllogisms.

**SORN'ED**, *pp.* Obtruded upon a friend for bed and board.

**SORN'ER**, *n.* One who obtrudes himself on another for bed and board.—In *Scots law*, one who takes meat and drink from others by force or menaces, without paying for it. This offence was formerly so prevalent in Scotland, that the severest penalties were enacted against it, and at one period it was punishable with death.

**SORORICIDE**, *n.* [L. *soror*, sister, and *cedo*, to strike, to kill.] The murder or murderer of a sister. [Little used.]

and obviously because the crime is very unrequited.]

**SOR'OSIS**, *n.* [Gr. *σωσις*.] A name applied to a fleshy fruit composed of many flowers, seed-vessels, and receptacles consolidated so as to form an anthocarpus, or compound fruit, as pineapple, bread-fruit, mulberry.

**SOR'TAGE**, † *n.* The blades of green wheat or barley.

**SOR'RANCE**, *n.* In *farriery*, any disease or sore in horses.

**SOR'REL**, *a.* [Fr. *saure*, yellowish brown; *saurer*, to dry in the smoke; *It. sauro*.] Of a reddish colour; as, a *sorrel horse*.

**SOR'REL**, *n.* A reddish colour; a faint red.

**SOR'REL**, *n.* [Sax. *sur*, son; Dan. *syre*, sorrel; W. *suran*.] The popular name of certain species of *Rumex*, as *Rumex acetosa*, *Rumex acetosella*, &c., so named from its acid taste. [See *RUMEX*.] The *wood sorrel* is of the genus *Oxalis*. The *mountain sorrel* is of the genus *Oxyria*. The *Indian red* and *Indian white sorrels* are of the genus *Hibiscus*.—*Sorrel tree*, a North American tree of the genus *Andromeda*, the *A. arborea*, which sometimes attains the height of 50 feet. It is well adapted for an ornamental plant.—*Salt of sorrel*, binoxalate of potash.

**SOR'RILY**, *adv.* [from *sorry*.] Meantly; despicably; pitifully; in a wretched manner.

Thy pipe, O Pan, shall help, though I sing *sorri*ly.

*Sidney.*

**SOR'RINESS**, *n.* Meanness; poorness; despicableness.

**SOR'RÖW**, *n.* [Sax. *sorg*; Goth. *saurga*; Sw. and Dan. *sorg*, care, solicitude, sorrow; D. *zorg*; G. *sorge*, care, concern, uneasiness; from the same root as *sore*, heavy.] The uneasiness or pain of mind which is produced by the loss of any good, real or supposed, or by disappointment in the expectation of good; grief; regret; sadness; mourning. The loss of a friend we love occasions *sorrow*; the loss of property, of health, or any source of happiness, causes *sorrow*. We feel *sorrow* for ourselves in misfortunes; we feel *sorrow* for the calamities of our friends and our country.

A world of woe and *sorrow*.

*Milton.*

The safe and general antidote against *sorrow* is employment

*Rambler.*

**SOR'RÖW**, *v. i.* [Sax. *sarian*, *sargian*, *sorgian*, Goth. *saurgan*, to be anxious, to sorrow.] To feel pain of mind in consequence of the actual loss of good, or of frustrated hopes of good, or of expected loss of happiness; to grieve; to be sad.

I rejoice not that ye were made sorry, but that ye *sorrowed* to repentance; 1 Cor. vi.

I desire no man to *sorrow* for me.

*Hayward.*

*Sorrowing* most of all for the words which he spoke, that they should see his face no more; Acts xx.

**SOR'RÖW-BLIGHTED**, *a.* Blighted with sorrow.

**SOR'RÖWFUL**, † *pp.* Accompanied with sorrow.

**SOR'RÖWFÜL**, *a.* Sad; grieving for the loss of some good, or on account of some expected evil.—2. Deeply serious; depressed; dejected; 1 Sam. i.—3. Producing sorrow; exciting grief; mournful; as, a *sorrowful* accident.—4. Expressing grief; accompanied with grief; as, *sorrowful* meat; Job vi.

**SOR'RÖWFÜL**, *adv.* In a sorrow-



Leaf of *Trichopteris excelsa* with *Sori*.

ful manner; in a manner to produce grief.

**SORROWFULNESS**, *n.* State of being sorrowful; grief.

**SORROWING**, *ppr.* or *a.* Feeling sorrow, grief, or regret.

**SORROWING**, *n.* Expression of sorrow.

**SORROWLESS**, *a.* Without sorrow.

**SORROW-STRICKEN**, *n.* A. Struck with sorrow; depressed.

**SORRY**, *a.* [Sax. *sarig, sari*, from *sar*, sore.] 1. Grieved for the loss of some good; pained for some evil that has happened to one's self or friends or country. It does not ordinarily imply severe grief, but rather slight or transient regret. It may be, however, and often is used to express deep grief. We are *sorry* to lose the company of those we love; we are *sorry* to lose friends or property; we are *sorry* for the misfortunes of our friends or of our country.

And the king was *sorry*; Matt. xiv.

2. Melancholy; dismal.—3. Poor; mean; vile; worthless; as, a *sorry* slave; a *sorry* excuse.

Coarse complexions,

And cheeks of *sorry* grain. Milton.

**SORT**, *n.* [Fr. *sorte*; G. *id.*; L. *sors*, lot, chance, state, way, *sort*. This word is from the root of Fr. *sortir*, L. *sortior*; the radical sense of which is to start or shoot, to throw or to fall, to come suddenly. Hence *sors* is lot, chance, that which comes or falls. The sense of *sort* is probably derivative, signifying that which is thrown out, separated, or selected.] 1. A species; a rank subordinate to a kind; any number or collection of individual persons or things characterized by the same or like qualities; as, a *sort* of men; a *sort* of horses; a *sort* of trees; a *sort* of poems or writings. *Sort* is not a technical word, and therefore is used with less precision or more latitude than *genus* or *species* in the sciences.—2. Manner; form of being or acting.

Flowers, in such *sort* worn, can neither be smelt nor seen well by those that wear them. Hooker.

To Adam in what *sort* shall I appear?

Milton.

3. Class or order; as men of the wiser *sort*, or the better *sort*; all *sorts* of people. [See Def. 1.]—4. † Rank; condition above the vulgar.—5. † A company or knot of people.—6. Degree of any quality.

I shall not be wholly without praise, if in some *sort* I have copied his style. Dryden.

7. † Lot.—8. A pair; a set; a suit.—*Out of sorts*, out of order; hence, unwell. [Familiar.]

**SORT**, *v. t.* To separate, as things having like qualities from other things, and place them in distinct classes or divisions; as, to *sort* cloths according to their colours; to *sort* wool or thread according to its fineness.

Shell fish have been, by some of the ancients, compared and *sorted* with insects.

Bacon.

Rays which differ in refrangibility, may be parted and *sorted* from one another.

Newton.

2. To reduce to order from a state of confusion. [See *supra*.]—3. To conjoin; to put together in distribution.

The swain perceiving by her words ill *sorted*, That she was wholly from herself transported. Brown.

4. To cull; to choose from a number; to select.

That he may *sort* her out a worthy spouse. Chapman.

**SORT**, *v. i.* To be joined with others of the same species.

Nor do metals only *sort* with metals in the earth, and minerals with minerals.

Woodward.

2. To consort; to associate.

The illiberality of parents toward children, makes them base, and *sort* with any company. Bacon.

3. To suit; to fit.

They are happy whose natures *sort* with their vocations. Bacon.

4. † To terminate; to issue; to have success. [Fr. *sortir*.]—5. † To fall out.

**SORTABLE**, *a.* That may be sorted.—2. Suitable; befitting.

**SORTABLY**, *adv.* Suitably; fitly.

**SORTAL**, † *a.* Pertaining to or designating a sort.

**SORTANCE**, † *n.* Suitableness; agreement.

**SORTED**, *pp.* Separated and reduced to order from a state of confusion.

**SORTER**, *n.* One who separates and arranges; as, a letter-*sorter*; a wool-*sorter*.

**SORTES HOMERICÆ** and **VIRGILIANÆ**. [L.] Homeric and Virgilian lots, a species of divination practised by the Romans, which consisted in opening the books of Homer or of Virgil, and forming conjectures from the first line or passage which happened to cast up. In Christian times the *sortes sanctorum*, or sacred lots, came into fashion. They were obtained by consulting the sacred writings in the manner above stated.

**SORTIE**, *n.* [Fr. from *sortir*, to issue.] A sally; the issuing of a body of troops from a besieged place to attack the besiegers.

**SORTILEGE**, *n.* [Fr. from L. *sortilegium*; *sors*, lot, and *lego*, to select.] The act or practice of drawing lots; divination by lots; a very ancient mode of exploring future events. [*Sortilegy* is not used.]

**SORTILEGIUS**, *a.* Pertaining to sortilege.

**SORTING**, *ppr.* Separating, as things having like qualities from other things, and reducing to order.

**SORTITION**, *n.* [L. *sortitio*.] Selection or appointment by lot.

**SORTMENT**, *n.* The act of sorting; distribution into classes or kinds.—2. A parcel sorted. [This word is superseded by *Assortment*,—*which see*.]

**SORRUS**, *n. plur. Sori*. [Gr.] In bot., small clusters of minute capsules on the back of the fronds of ferns. [See *SORI*.]

**SORRY**, *n.* The ancient name of sulphate of iron.

**SOSPITO**, *n.* [It. a sigh.] In music, a word expressive of silence, and synonymous with *rest*,—*which see*.

**SOSS**, † *v. i.* [G. *sausen*. See *SOUSE*.] To fall at once into a chair or seat; to sit lazily.

**SOSS**, *n.* A lazy fellow.—2. A heavy fall. [Familiar.]

**SOSTENU'TO**. [It. sustained.] In music, a term implying that the notes of the movement or passage or note over which it is placed, is to be held out its full length in an equal and steady manner.

**SOT**, *n.* [Fr. *sot*; Arm. *sodt*.] The sense is, stupid; Ch. *ꞑꞑꞑ, shatei*.] 1. A stupid person; a blockhead; a dull fellow; a

dolt.—2. A person stupefied by excessive drinking; an habitual drunkard.

What can ennoble *sots*? Pope.

**SOT**, *v. t.* To stupefy; to infatuate; to besot.

I hate to see a brave bold fellow *sotted*.

Dryden.

[Not much used. See *BESOT*.]

**SOT**, *v. i.* To tittle to stupidity. [Lit. us.] **SOTERIOLOGY**, *n.* [Gr. *σωτηριολογία*, salubrions, and *λογία*, discourse.] A discourse on health, or the science of promoting and preserving health.

**SOTHIAE**, or **SOTHIC YEAR**. The ancient Egyptian year of 365 days without any intercalation. It was divided into twelve months of thirty days each, with five days added at the end. The period of 1460 Julian years was the Sothic period.

**SOTTISH**, *a.* Dull; stupid; senseless; doltish; very foolish.

How ignorant are *sottish* pretenders to astrology! Swift.

2. Dull with intemperance.

**SOTTISHLY**, *adv.* Stupidly; senselessly; without reason.

**SOTTISHNESS**, *n.* Dullness in the exercise of reason; stupidity.

Few consider into what degree of *sottishness* and confirmed ignorance men may sink themselves. South.

2. Stupidity from intoxication.

**SOTTO**. [It. below.] In music, a term signifying below, or inferior; as, *sotto il soggetto*, below the subject; but *sotto voce* is used to signify with a restrained voice or moderate tone.

**SŪU**, *n. plur. Sous*. [Fr.] An old French copper coin, 24 of which made a livre, or shilling. The present 5-centime pieces, 20 of which make a franc, are still popularly called *sous*; but all regular money accounts, in France, are made out in francs and centimes.

**SŪUBAH**, *n.* In India, a province or viceroyship.

**SŪUBAH DAR**, *n.* In India, a viceroy or governor of a large province. Also the title of a native sepoy officer below an ensign.

**SŪUBRE'TTE**, *n.* [Fr.] A waiting-maid.

**SŪUCHONG**, *n.* A kind of black tea.

**SOUGH**, *n.* (snf.) [Qu. the root of *suck*, to draw.] A subterraneous drain; a sewer; a box drain. [Not in use or local.] In Scotch it is written *seuch, sheuch, or sheugh*, and retains the guttural sound.

**SOUGH**, *v. i.* (sŏf.) [Sax. *swegan*, to sound.] To emit a rushing or whistling sound, like that of the wind.

[*Obsol. or local in England, but current in Scotland, where it also signifies to breathe long, as one does in sleep.*]

**SOUGH**, *n.* (sŏf.) [Sax. *swæg*, a sound.]

A murmuring sound, a rushing or whistling sound, like that of the wind. [*Obsol. or local in England, but much used in Scotland, where it also signifies the sound emitted by one during sleep; a deep sigh; any rumour that engages general attention; a whining mode of speaking, especially in preaching and praying. Both the verb and the noun retain the guttural sound in Scotch, which renders the words much more expressive than the English pronunciation.*]

November chill blows loud wi' angry *sough*. Burns.

**SOUGHT**, *pret.* and *pp.* of *Seeh*, pronounced *savt*.

I am found of them who *sought* me not; Is. lxxv.

**SOUK'AR, n.** The Arabic name for saccharum or sugar.

**SOUL, n.** [Sax. *sawel, sawl* or *saul*; G. *seele*.] 1. The spiritual, rational, and immortal substance in man, which distinguishes him from brutes; that part of man which enables him to think and reason, and which renders him a subject of moral government. The immortality of the *soul* is a fundamental article of the Christian system.

Such is the nature of the human *soul* that it must have a God, an object of supreme affection. *J. Edwards.*

2. The understanding; the intellectual principle.

The eyes of our *souls* then only begin to see, when our bodily eyes are closing. *Lav.*

3. Vital principle.  
Thou sun, of this great world both eye and *soul.* *Milton.*

4. Spirit; essence; chief part; as, charity, the *soul* of all the virtues. Emotion is the *soul* of eloquence.

5. Life; animating principle or part; as, an able commander is the *soul* of an army.—6. Internal power.  
There is some *soul* of goodness in things evil. *Shak.*

7. A human being; a person. There was not a *soul* present. In Paris there are more than a million of *souls*; London, Westminster, Southwark and the suburbs, more than eighteen hundred thousand *souls*.—8. Animal life.

To deliver their *soul* from death, and to keep them alive in famine; Ps. xxxiii.; vii. 9. Active power.  
And heaven would fly before the driving *soul.* *Dryden.*

10. Spirit; courage; fire; grandeur of mind.  
That he wants caution he must needs confess, But not a *soul* to give our arms success. *Young.*

11. Generosity; nobleness of mind; a colloquial use.—12. An intelligent being. Every *soul* in heaven shall bend the knee. *Milton.*

13. Heart; affection.  
The *soul* of Jonathan was knit with the *soul* of David; 1 Sam. xviii.

14. In *scrip.*, appetite; as, the full *soul*; the hungry *soul*; Prov. xxvii.; Job xxxiii.—15. A familiar compellation of a person, but often expressing some qualities of the mind; as, alas, poor *soul*; he was a good *soul*.

**SOUL, † v. t.** To endure with a *soul*.  
**SOUL, † v. i.** [Sax. *sufel, sufel*, broth, pottage.] To afford suitable sustenance.

**SOUL-BELL, † n.** The passing bell.  
**SOUL-BETRAYING, a.** Tending to betray the *soul*.

**SOUL-CALMING, a.** Tranquillizing the *soul*.

**SOUL-CONFIRMING, a.** Giving confidence.

**SOUL-DESTROYING, a.** Pernicious to the *soul*. Procrastination of repentance and faith is a *soul-destroying* evil.

**SOUL-DISEASED, † a.** Diseased in *soul* or mind.

**SOUL-DISSOLVING, a.** Melting or tending to soften the *soul*.

**SOULED, a.** Furnished with a *soul* or mind; as, Grecian chiefs largely *souled*. [Little used.]

**SOUL-ENTRANCING, a.** Enrapturing the *soul*.

**SOUL-FELT, a.** Deeply felt.

**SOUL-HARDENED, a.** Having an obdurate heart.

**SOULESS, a.** Without a *soul*, or with-

out greatness or nobleness of mind; mean; spiritless.

Slave, *soulless* villain. *Shak.*

**SOUL-REFRESHING, a.** Comforting the *soul*.

**SOUL-SCOT, } n.** [*soul* and *scot*.] A **SOUL-SHOT, }** funeral duty, or money paid by the Romanists in former times for a requiem for the *soul*.

**SOUL-SEARCHING, a.** Searching the *soul* or heart.

**SOUL-SELLING, a.** [*soul* and *sell*.] Selling persons; dealing in the purchase and sale of human beings.

**SOUL-SICK, a.** [*soul* and *sick*.] Diseased in mind or *soul*; morally diseased.

**SOUL-STIRRING, a.** Exciting the *soul*.

**SOUL-SUBDU'ING, a.** Subduing the *soul*.

**SOUL-VEXED, a.** Grieved at heart.

**SOUND, a.** [Sax. *sund*; G. *gesund*; L. *sanus*; Fr. *sain*; Ch. and Syr. ܣܘܢܐ, *chasan*.] It is from driving, or straining, stretching.] 1. Entire; unbroken; not shaky, split, or defective; as, *sound* timber.—2. Undecayed; whole; perfect, or not defective; as, *sound* fruit; a *sound* apple or melon.—3. Unbroken; not bruised or defective; not lacerated or decayed; as, a *sound* limb.—4. Not carious; not decaying; as, a *sound* tooth.—5. Not broken or decayed; not defective; as, a *sound* ship.—6. Whole; entire; unhurt; unutilated; as, a *sound* body.—7. Healthy; not diseased; not being in a morbid state; having all the organs complete and in perfect action; as, a *sound* body; *sound* health; a *sound* constitution; a *sound* man; a *sound* horse.—8. Founded in truth; firm; strong; valid; solid; that cannot be overthrown or refuted; as, *sound* reasoning; a *sound* argument; a *sound* objection; *sound* doctrine; *sound* principles.—9. Right; correct; well founded; free from error; orthodox; 2 Tim. i.

Let my heart be *sound* in thy statutes; Ps. exix.

10. Heavy; laid on with force; as, *sound* strokes; a *sound* beating.—11. Founded in right and law; legal; valid; not defective; that cannot be overthrown; as, a *sound* title to land; *sound* justice.—12. Fast; profound; unbroken; undisturbed; as, *sound* sleep.—13. Perfect, as intellect; not broken or defective; not enfeebled by age or accident; not wild or wandering; not deranged; as, a *sound* mind; a *sound* understanding or reason.—

*Sound* currency, in *com.*, a currency whose actual value is the same as its nominal value, and if in bank notes or other substitute for silver and gold, a currency which is so sustained by funds, that it is at any time convertible into gold and silver, and of course of equal value.

**SOUND, adv.** Soundly; heartily.  
So *sound* he slept that naught might him awake. *Spenser.*

**SOUND, n.** The air-bladder of a fish.—2. A name given to the cuttle-fish.

**SOUND, n.** [Sax. *sund*, a narrow sea or strait, a swimming; Pers. *shana*, a swimming, L. *natio*.] Qu. can this name be given to a narrow sea because wild beasts were accustomed to pass it by swimming, like *Bosporus*; or is the word from the root of *sound*, whole, denoting a stretch, or narrowness, from stretching, like *straight*; or, from its sounding? A narrow passage of water, or a strait between

the main land and an isle; or a strait connecting two seas, or connecting a sea or lake with the ocean; as, the *sound* which connects the Baltic with the ocean, between Denmark and Sweden.

**SOUND, n.** [Fr. *sonde*; Sp. *sonda*. See the following verb.] An instrument which surgeons introduce into the bladder, in order to discover whether there is a stone in that viscus or not.

**SOUND, v. t.** [Sp. *sondar* or *sondear*; Fr. *sonder*.] This word is probably connected with the L. *sonus*, Eng. *sound*, the primary sense of which is to stretch or reach.] 1. To try, as the depth of water and the quality of the ground, by sinking a plummet or lead, attached to a line on which are marked the number of fathoms. The lower end of the lead is covered with tallow, by means of which some portion of the earth, sand, gravel, shells, &c. of the bottom, adhere to it and are drawn up. By these means, and the depth of water and the nature of the bottom, which are carefully marked on good charts, seamen may know how far a ship is from land in the night or in thick weather, and in many cases when the land is too remote to be visible. [See SOUNDING.]—2. To introduce a *sound* into the bladder of a patient, in order to ascertain whether a stone is there or not.

When a patient is to be *sounded*. Cooper. 3. To try; to examine; to discover or endeavour to discover that which lies concealed in another's breast; to search out the intention, opinion, will, or desires.

I was in jest, And by that offer meant to *sound* your breast. *Dryden.*

I've *sounded* my Numidians man by man. *Addison*

**SOUND, v. i.** To use the line and lead in searching the depth of water.

The shipmen *sounded*, and found it twenty fathoms; Acts xxvii.

**SOUND, n.** [Sax. *son*; W. *swen*; Ir. *soin*; Fr. *son*; L. *sonus*, from *sono*, to sound, sing, rattle, beat, &c. This may be a dialectical variation of L. *tonus, tono*, which seems to be allied to Gr. *τῆνος*, to stretch or strain, L. *teneo*.] 1. Noise; report; the object of hearing; that which strikes the ear; or more philosophically, an impression, or the effect of an impression, made on the organs of hearing by the vibrations of the air or other medium with which these organs are in contact, which vibrations are caused by the vibrations or tremulous motions of the sounding body; as, the *sound* of a trumpet or drum. the *sound* of the human voice; a horrid *sound*; a charming *sound*; a sharp *sound*; a high *sound*; a loud *sound*; a low *sound*; an acute *sound*; a grave *sound*. No body can emit a *sound* unless it be put into a tremulous or vibratory motion; and hence, *sound* considered with respect to the sounding body, consists of a motion of vibration impressed on the parts of the body; this motion is communicated to the air which surrounds the body, and produces in it corresponding undulations, by which the ear being affected, the sensation of *sound* is produced. The propagation of *sound* is not instantaneous; that is to say, the sensation is not produced at the same instant as the motion in the sonorous body which causes it;

for if a gun or a piece of ordnance be discharged at a considerable distance, the flash will be first seen, and after some seconds have elapsed, the report will be heard. In like manner, lightning always precedes thunder, and if the thunder cloud be at a considerable distance, several seconds will elapse before the thunder is heard. It has been ascertained that the atmosphere, in its ordinary state, conducts sound at the rate of 1130 feet per second. The velocity is subject to some slight variation, owing to the change of temperature, the moisture suspended in the air, and other causes; but 1130 feet per second may be taken as an average rate. If, however, there be a wind, its velocity must be added to 1130 feet, when it blows from the sounding body; and subtracted when it blows in a contrary direction. From these data, we are enabled to determine distances with considerable accuracy. For example, when a ship at sea fires a gun, by multiplying 1130 feet, the mean velocity of sound per second, by the number of seconds that elapse between the flash and the report, we obtain the distance of the ship in feet. In the same way we may ascertain the distance of a thunder cloud. Sound is propagated or radiates from the sounding body, in all directions, and in straight lines, and diminishes in intensity as it recedes from the sounding body; so that at different distances from the body, it is inversely as the squares of those distances. When sound is arrested in its progress by a smooth, hard, or elastic surface, as a rock, the wall of a house, of a cavern, or of a vault, it is thrown back or reflected, and thus forms what is called an *echo*, the law of the reflection being that the angle of reflection is always equal to the angle of incidence. Sounds are as various as the means that concur in producing them. Noise and discordant sounds arise from a want of isochronism in the vibrations of the sounding body; and loudness of sound depends on the greater extent of the vibrations. When the vibrations of a sonorous body are isochronous, the sound is always musical, and the quicker the vibrations, the more acute is the tone. The determination of the laws according to which sound is produced and transmitted to our organs, forms the object of that branch of physical science termed *acoustics*.—2. A vibration of air caused by a collision of bodies or other means, sufficient to affect the auditory nerves when perfect. Some persons are so entirely deaf that they cannot hear the loudest sounds. *Audible sounds* are such as are perceptible by the organs of hearing. *Sounds* not audible to men, may be audible to animals of more sensible organs.—3. Noise without signification; empty noise; noise and nothing else.

It is the sense and not the *sound*, that must be the principle.

Locke.

*Sound dues*, the sea-toll levied on all vessels passing the *sound* between Denmark and Sweden, collected at Elsinour.

**SOUND**, *v. i.* To make a noise; to utter a voice; to make an impulse of the air that shall strike the organs of hearing with a particular effect. We say, an instrument *sounds* well or ill; it *sounds* shrill; the voice *sounds* harsh.

And first taught speaking trumpets how to *sound*.

Dryden.

2. To exhibit by sound or likeness of sound. This relation *sounds* rather like a fiction than a truth.—3. To be conveyed in sound; to be spread or published.

From you *sounded* out the word of the Lord; 1 Thess. i.

**SOUND'ABLE**, *a.* Not unfathomable; as, a *soundable* sea.

**SOUND'-BOARD**, } *n.* The principal part of an organ, and that which makes the whole machine play. It is a reservoir into which the wind, drawn in by the bellows, is conducted by a port vent, and thence distributed into the pipes, placed over the holes of its upper part. It is also a thin board that propagates the sound in a violin, piano, harp, &c.

To many a row of pipes the *sound-board* breathes.

Milton.

**SOUND'-BOARDING**, *n.* In *arch.*, the sound boarding of floors consists of short boards, which are disposed transversely between the joists, and supported by fillets fixed to the sides of the joists, for holding the substance called pugging, intended to prevent sound from being transmitted from one story to another. [See **PUGGING**.] In *Scotland*, sound-boarding is termed deafening-boarding.

**SOUND'ED**, *pp.* Caused to make a noise; uttered audibly.—2. Explored; examined.

**SOUND'ER**, *n.* An instrument for sounding.

**SOUND'-HEADED**, *a.* Having sound principles.

**SOUND'-HEARTED**, *a.* Having a sound heart or affections.

**SOUND'ING**, *ppr.* Causing to sound; uttering audibly.—2. Trying the depth of water by the plummet; examining the intention or will.—3. *a.* Sonorous; making a noise.—4. Having a magnificent sound; as, words more *sounding* or significant.

**SOUND'ING**, *n.* The act of uttering noise; the act of endeavouring to discover the opinion or desires; the operation of trying the depth of the sea, and the nature of its bottom, by means of a plummet sunk from a ship to the bottom. [See **SOUNDINGS**.]—2. In *sur.*, the operation of introducing the sound into the bladder; called *searching* for the stone.

**SOUND'ING-BOARD**, or **SOUND'-BOARD**, *n.* A board or structure placed over a pulpit or other place occupied by a public speaker, to reflect the sound of his voice, and thereby render it more audible. Sounding boards are generally flat, and placed horizontally over the head of the speaker; but concave parabolic sounding boards have been tried, and found to answer better.—2. In *musical instruments*, the thin board placed under the strings, as in a violin.

**SOUND'ING-LINE**, *n.* A line for trying the depth of water.

**SOUND'ING-POST**, *n.* A small post in a violin and violoncello, set under the bridge for a support, and for propagating the sounds to the back of the instrument.

**SOUND'ING-ROD**, *n.* A rod or piece of iron used to ascertain the depth of water in a ship's hold. It is let down in a groove by a pump.

**SOUND'INGS**, *n.* The depths of water in rivers, harbours, along shores, and

even in the open seas, which are ascertained by the operation of *sounding*. The term is also used to signify any place or part of the ocean, where a deep sounding line will reach the bottom; also, the kind of ground or bottom where the lead reaches. There are two plummet used in sounding, one called the *hand lead*, the other the *deep-sea lead*; both are shaped like the frustum of a cone. [See **LEAD**.] Sounding with the hand-lead, called by seamen *heaving the lead*, is generally performed by a single person, who stands in the main chains to windward, and throws the lead forward while the ship is in motion; so that by the lead sinking while the ship advances, the line may be almost perpendicular when it reaches the bottom. In using the *deep sea lead* at sea, or in deep water, it is usual previously to bring-to the ship, in order to retard her course; the lead is then thrown as far as possible from the ship, on the line of her drift, so that, as it sinks, the ship drives more perpendicularly over it. The bottom of the lead being well rubbed over with tallow, retains the distinguishing marks of the bottom; as, shells, ooze, gravel, &c. The depth of the water, and the nature of the ground, are carefully marked in the log book. *In soundings*, implies the being so near the land that a deep sea lead will attain the bottom, which is seldom practicable in the ocean.

**SOUND'LESS**, *a.* That cannot be fathomed; having no sound.

**SOUND'LY**, *adv.* [from *sound*, entire.] Healthily; heartily.—2. Severely; lustily; with heavy blows; smartly; as, to beat one *soundly*.—3. Truly; without fallacy or error; as, to judge or reason *soundly*.—4. Firmly; as, a doctrine *soundly* settled.—5. Fast; closely; so as not to be easily awakened; as, to sleep *soundly*.

**SOUND'NESS**, *n.* Wholeness; entireness; an unbroken, unimpaired, or undecayed state; as, the *soundness* of timber, of fruit, of the teeth, of a limb, &c. [See **SOUND**.]—2. An unimpaired state of an animal or vegetable body; a state in which the organs are entire and regularly perform their functions. We say, the *soundness* of the body, the *soundness* of the constitution, the *soundness* of health.—3. Firmness; strength; solidity; truth; as, *soundness* of reasoning or argument, of doctrine or principles.—4. Truth; rectitude; firmness; freedom from error or fallacy; orthodoxy; as, *soundness* of faith.

**SOUND-POST**, *n.* A prop withinside a violin, &c. [See **SOUNDING-POST**.]

**SÖUP**, *n.* [Fr. *soupe*; G. *suppe*. See **SUP** and **SOP**.] The substance of meat infused in water by boiling, with various other ingredients. *Soups* are of many different kinds; as, brown *soup*; white *soup*; hare *soup*; turtle *soup*; pease *soup*, &c.—*Portable soup*, a sort of cake formed of concentrated broth, freed from fat, and by long-continued boiling, from all the putrescent parts, and thereby reduced to the consistence of glue; which, in reality, it is. It will keep sound for many years, and in long voyages it has been found to be a valuable article of food. It is made into soup by pouring boiling water upon it with a little salt, and stirring till it dissolves.

**SÖUP**, *v. t.* To sup; to breathe out.



SŪP, † *v. t.* To sweep. [See SWEEP and SWOOP.]

SŪP-LA'DLE, *n.* A large spoon for lading soup or broth.

SOUR, *a.* [Sax. *sur, surig*; G. *sauer*; W. *sür*; Fr. *sur, sure*; Heb. *sur, sur*, to depart, to decline, to turn, as liquors, to become sour.] 1. Acid; having a pungent taste; sharp to the taste; tart; as, vinegar is *sour*; *sour* cider; *sour* beer.—2. Acid and austere or astringent; as, sun-ripe fruits are often *sour*.—3. Harsh of temper; crabbed; peevish; austere; morose; as, a man of a *sour* temper.—4. † Afflictive; as, *sour* adversities.—5. Expressing discontent or peevishness. He never uttered a *sour* word.

The lord treasurer often looked on me with a *sour* countenance. *Swift.*

6. Harsh to the feelings; cold and damp; as, *sour* weather.—7. Rancid; musty.—8. Turned, as milk; coagulated.

SOUR, *n.* A sour or acid substance.

SOUR, *v. t.* To make acid; to cause to have a sharp taste.

So the sun's heat, with different pow'rs,  
Ripens the grape, the liquor *sours*.

*Swift.*

2. To make harsh, cold, or unkindly.  
Tufts of grass *sour* land. *Mortimer.*

3. To make harsh in temper; to make cross, crabbed, peevish, or discontented. Misfortunes often *sour* the temper. Pride had not *sour'd*, nor wrath debas'd my heart. *Harte.*

4. To make uneasy or less agreeable.  
Hail, great king!

To *sour* your happiness I must report  
The queen is dead. *Shak.*

5. In *rural economy*, to macerate, as lime, and render fit for plaster or mortar.

SOUR, *v. i.* To become acid; to acquire the quality of tartness or pungency to the taste. Cider *sours* rapidly in the rays of the sun. When food *sours* in the stomach, it is evidence of imperfect digestion.—2. To become peevish or crabbed.

They hinder the hatred of vice from *souring* into severity. *Addison.*

SOURCE, *n.* [Fr. *source*; Arm. *sourcenn*; either from *soudre* or *sourtir*, or the L. *surgo*. The Italian *sorgente* is from *surgo*.] 1. Properly, the spring or fountain from which a stream of water proceeds, or any collection of water within the earth or upon its surface, in which a stream originates. This is called also the *head* of the stream. We call the water of a spring, where it issues from the earth, the *source* of the stream or rivulet proceeding from it. We say also that springs have their *sources* in subterranean ponds, lakes, or collections of water. We say also that a large river has its *source* in a lake. For example, the St. Lawrence has its *source* in the great lakes of America.—2. First cause; original; that which gives rise to anything. Thus ambition, the love of power and of fame, have been the *sources* of half the calamities of nations. Intemperance is the *source* of innumerable evils to individuals.—3. The first producer; he or that which originates; as, Greece, the *source* of arts.

SOUR'-CROUT, or SOUR'-KROUT, *n.* [G. *sauer-kraut*, i. e. *sour-cabbage*.] Cabbage cut fine, pressed into a cask, and suffered to ferment till it becomes sour, and then cooked.

SOUR'DET, *n.* [Fr. *sourdine*, from *sourd*, deaf.] The little pipe of a trumpet.

SOUR'-DOCK, *n.* Sorrel, so called.

SOUR'ED, *pp.* Made sour; made peevish.

SOUR-EYED, † *a.* Having a cross look.

SOUR'-GŪRD, *n.* A plant of the genus *Adansonia*, the *A. digitata*, Linn.

SOUR'ING, *ppr.* Making acid; becoming sour; making peevish.

SOUR'ING, *n.* That which makes acid.

SOUR'ISH, *a.* Somewhat sour; moderately acid; as, *sourish* fruit; a *sourish* taste.

SOUR'LY, *adv.* With acidity.—2. With peevishness; with acrimony.

The stern Athenian prince  
Then *sowly* smil'd. *Dryden.*

3. Discontentedly.

SOUR'NESS, *n.* Acidity; sharpness to the taste; tartness; as, the *sourness* of vinegar or of fruit.

*Sourness* being one of those simple ideas which one cannot describe. *Arbuthnot.*

2. Asperity; harshness of temper.

Take care that no *sourness* and moroseness mingle with our seriousness of mind.

*Nelson.*

SOUR'-SOP, *n.* A plant, the *Anona muricata*. The custard apple.

SŪS, *pl.* of *Sou*, which see. [Some English writers have erroneously used *sous* with a singular meaning.]

SŪSE, *n.* [Fr. *sousgeach*, watery.] 1. Pickle made with salt.—2. Something kept or steeped in pickle; any thing boiled in a salt pickle.—3. The ears, feet, &c., of swine pickled.—4. A violent attack, as of a bird striking its prey.

SŪSE, *v. t.* To steep in pickle.

But *souse* the cabbage with a bounteous heart *Pope.*

2. To plunge into-water.

They *soused* me into the Thames, with as little remorse as they drown blind puppies. *Shak.*

SŪSE, *v. i.* [Ger. *sausen*, to rush.] To fall suddenly on; to rush with speed; as a hawk on its prey.

Job's bird will *souse* upon the tim'rons hare. *Dryden.*

SŪSE, *v. t.* To strike with sudden violence.

SŪSE, *adv.* With sudden violence. [Familiar.]

SŪSE or SOURCE, *n.* [Fr. *sous*, under, below.] In *arch.*, a support, or underprop.

SŪS'ED, *pp.* Steeped in pickle.—2. Plunged into water.

SŪS'TENU or SŪ'TENU, [Fr.] In *her.*, a term applied when a chief is, as it were, supported by a small part of the escutcheon beneath it, of a different colour or metal from the chief, and reaching, as the chief does, from side to side, being, as it were, a small part of the chief of another colour, and supporting the real chief.

SŪTER, *n.* [Sax. *sutere*; L. *sutor*.] A shoemaker; a cobbler. [Scotch.]

SŪTERLY, *adv.* Like a cobbler; low, vulgar. [Scotch.]

SŪTERRAIN, *n.* [Fr.; that is, *sub-terrain*, under ground.] A grotto or cavern under ground. [Not English.]

SŪTH, *n.* [Sax. *suth*; G. *sud*; Fr. *sud*.]

1. One of the four cardinal points of the compass. The north and south are opposite points in the horizon; each ninety degrees or the quarter of a great circle distant from the east and west. A man standing with his face toward the east or rising sun, has the

*south* on his right hand. The meridian of every place is a great circle passing through the north and south points. Strictly, *south* is the horizontal point in the meridian of a place, on the right hand of a person standing with his face toward the east. But the words applied to any point in the meridian, between the horizon and the zenith.—2. In a less exact sense, any point or place on the earth or in the heavens, which is near the meridian toward the right hand as one faces the east.—3. A southern region, country, or place; as, the queen of the *south*, in Scripture. So in Europe, the people of Spain and Italy are spoken of as living in the *south*.—4. † The wind that blows from the south.

SOUTH, *a.* In any place north of the *tropic of Cancer*, pertaining to or lying in the meridian toward the sun; as, a *south* wind.—2. Being in a southern direction; as, the *south* sea.

SOUTH, *adv.* Toward the south, from the south. A ship sails *south*; the wind blows *south*.

SOUTHCOTTIANS, *n.* The followers of Joanna Southcott, a religious fanatic, who was born at Gittisham, in Devonshire, in 1750. She first pretended to a divine mission, and held herself out as the woman spoken of in the book of Revelation. After she had attained her grand climacteric, in 1814, she announced herself as the mother of the promised Shiloh, whose speedy advent she predicted. Her death, in December of that year, did not undeceive her disciples, and the sect continued to exist for many years, nor are we aware that it is yet altogether extinct. Many of her followers wore long beards and a peculiar costume.

SOUTHEAST, *n.* The point of the compass equally distant from the south and east.

SOUTHEAST, *a.* In the direction of southeast, or coming from the southeast; as, a *southeast* wind.

SOUTHEASTERN, *a.* Toward the southeast.

SOUTHERLY, *a.* Lying at the south, or in a direction nearly south; as, a *southerly* point.—2. Coming from the south or a point nearly south; as, a *southerly* wind.

SOUTHERN, *a.* [Sax. *suth* and *ern*, place.] 1. Belonging to the south; meridional, lying on the south side of the equator; as, the *southern* hemisphere; *southern* latitudes, *southern* signs, &c.—2. Lying toward the south; as, a *southern* country or climate.—3. Coming from the south; as, a *southern* breeze.

SOUTHERNER, *n.* In *America*, an inhabitant or native of the south or southern states.

SOUTH'ERNLINESS, *n.* State of being southerly.

SOUTHERNLY, *adv.* Toward the south.

SOUTHERNMŌST, *a.* Farthest toward the south.

SOUTHERNWOOD, *n.* (*suth'ern-wood*.) A plant nearly allied to the wormwood. The southernwood is the *Artemisia abrotanum*, a congener of the wormwood. It is found in almost every cottage garden, and was formerly employed in medicine as a stomachic and stimulant. [See ARTEMISIA.]

SOUTH'ING, *a.* Going toward the south; as, the *southing* sun.

**SOUTH'ING**, *n.* Tendency or motion to the south.—2. The *southing* of the moon, the time at which the moon passes the meridian.—3. In *navigation*, the difference of latitude made by a ship in sailing to the southward.

**SOUTH'MOST**, *a.* Furthest toward the south.

**SOUTH'RON**, *n.* In *ancient Scotland*, the name of a native of South Britain; an Englishman. Applied also by the Highlanders to the Lowlanders of Scotland.

**SOUTH'SAY**, } See **SOOTHSAV**.

**SOUTH'SAYER**, }

**SOUTHWARD**, *adv.* Toward the south; as, to go *southward*.

**SOUTHWARD**, *n.* The southern regions or countries.

**SOUTHWEST'**, *n.* [*south* and *west*.] The point of the compass equally distant from the south and west.

**SOUTHWEST'**, *a.* Lying in the direction of the southwest; as, a *southwest* country.—2. Coming from the southwest; as, a *southwest* wind.

**SOUTH-WEST'ER**, *n.* A strong southwest wind.

**SOUTHWEST'ERLY**, *a.* In the direction of southwest, or nearly so.—2. Coming from the southwest, or a point near it; as, a *southwesterly* wind.

**SOUTHWEST'ERN**, *a.* In the direction of southwest, or nearly so; as, to sail a *southwestern* course.

*Note.*—*Southerly*, *southern*, *southerly*, *southernmost*, *southward*, often receive the technical sea pronunciation, *Suth'eryly*, *suth'ern*, *suth'ernly*, *suth'ernmost*, *suth'ard*. *Southwest*, *southwester*, and *southwestern*, are, for the same reason, often contracted into *sow'west*, *sow-west'er*, and *sowwest'ern*.

**SOUVENANCE**, † *n.* [Fr.] Remembrance.

**SÖUVENIR**, *n.* [Fr.] A remembrance.

**SOVEREIGN**, *a.* (suv'eran.) [We retain this barbarous orthography from the Norman *souverain*, which doubtless was adopted through a mistake of its origin. The true spelling would be *suveran*, from the L. *supernus*, *superus*; Fr. *souverain*.] 1. Supreme in power; possessing supreme dominion; as, a *sovereign* prince. God is the *sovereign* ruler of the universe.—2. Supreme; superior to all others; chief. God is the *sovereign* good of all who love and obey him.—3. Supremely; efficaciously; superior to all others; predominant; effectual; as, a *sovereign* remedy.—4. Supreme; pertaining to the first magistrate of a nation; as, *sovereign* authority.

**SOVEREIGN**, *n.* (suv'eran.) A supreme lord or ruler; one who possesses the highest authority without control, a person or body of persons in whom the legislative authority rests in every state. Some earthly princes, kings, and emperors are *sovereigns* in their dominions.—2. A supreme magistrate; a king or queen regnant.—3. A gold coin of the value of 20s. sterling, and weighing 123.374 grains troy.—4. A gold coin current at 22s. 6d. in the reign of Henry VIII. and which was in use till the time of James I.

**SÖVEREIGNIZE**, † *v. i.* (suv'eranize.) To exercise supreme authority.

**SÖVEREIGNLY**, *adv.* (suv'eranly.) Supremely; in the highest degree.

He was *sovereignly* lovely in himself. [Little used.] Boyle.

**SÖVEREIGNTY**, *n.* (suv'eranty.) Supreme power; supremacy; the posses-

sion of the highest power, or of uncontrollable power. Absolute *sovereignty* belongs to God only.

**SOW**, *n.* [Sax. *suga*; G. *saw*.] 1. The female of the hog kind or of swine.—2. An oblong piece of lead.—3. An insect; a millepede.—4. The name given by the workmen to the main channel in the floor of a smelting furnace, into which the liquid metal is first made to enter. The side channels which branch off from the *sow*, are termed *pigs*, while the metal which fills the *sow* is called *sow-metal*, and that which fills the *pigs*, *pig-metal*. [See **SMEETING**.]—5. A military engine anciently used in sieges. It appears to have resembled the *testudo* of the Romans, and was employed to cover and protect men who were employed in sapping and mining operations.

**SOW'BANE**, *n.* A plant; goosefoot. It is also called *hogbane*.

**SOW'-BREAD**, *n.* A plant of the genus *Cyclamen*, the *C. Europæum*, so named from its roots being the principal food of the wild boars of Sicily.

**SOW'-BUG**, *n.* An isopodous crustaceous animal; a millepede.

**SOW'-THISTLE**, *n.* The common name of several British species of plants of the genus *Sonchus*. [See **SONCHUS**.] The *downy sow-thistle* is of the genus *Andryala*.

**SÖW**, *v. t.* pret. *Sowed*; pp. *Sowed* or *Soven*. [Sax. *savaen*; G. *säen*; perhaps L. *sevi*. This word is probably contracted.] 1. To scatter on ground, for the purpose of growth and the production of a crop; as, to *sow* good seed; to *sow* a bushel of wheat or rye to the acre; to *sow* oats, clover, or barley; to *sow* seed in drills, or to *sow* it broad-cast. Oats and flax should be *sown* early in the spring.—2. To scatter seed over for growth; as, to *sow* ground or land; to *sow* ten or a hundred acres in a year.—3. To spread or to originate; to propagate; as, to *sow* discord.

Born to afflict my Marcia's family,  
And *sow* dissension in the hearts of brothers. Addison.

4. To supply or stock with seed, to impregnate.

The intellectual faculty is a goodly field,  
and it is the worst husbandry in the world  
to *sow* it with trifles. Hale.

5. To scatter over; to besprinkle.  
He *sow'd* with stars the heaven. Milton.

Morn now *sow'd* the earth with orient pearl. Milton.

**SÖW**, *v. i.* To scatter seed for growth and the production of a crop.

They that *sow* in tears, shall reap in joy; Ps. cxxvi.

**SÖW**, † for *Sew*. See **SEW**.

**SÖWCE**, for *Souse*. See **SOUSE**.

**SÖWED**, *pp.* Scattered on ground, as seed; sprinkled with seed, as ground. We say, seed is *sowed*; or land is *sowed*.

**SÖWENS**, } *n.* [Scottish.] A nutritious  
**SÖWINS**, } article of food made from  
**SÖW'ANS**, } the husk of the oat, by a process not unlike that by which common starch is made. The husk of the oat, (called in Scotland *seeds*.) after being separated from the oatmeal by the sieve, still retains a considerable portion of farinaceous matter. It is steeped in water till the farinaceous matter is dissolved, and till the liquid has become sour. The whole is then made to pass through a sieve, which allows the milky liquid to pass through, but retains the husks. The liquid thus

obtained is loaded with starchy matter which subsides to the bottom. The sour liquor is decanted off, and about an equal quantity of fresh water added. This mixture, when boiled, forms *sowens*, a very wholesome and nutritious article of food, which is much used in Scotland. It is eaten with milk or beer. In England it is called *flummary*.  
**SÖWER**, *n.* He that scatters seed for propagation.

Behold, a *sower* went forth to sow; Matth. xiii.

2. One who scatters or spreads; as, a *sower* of words.—3. A breeder; a promoter; as, a *sower* of suits.

**SÖWING**, *pp.* Scattering, as seed; sprinkling with seed, as ground; stocking with seed.

**SÖWING**, *n.* The act of scattering seed for propagation. The operation of depositing seed in the soil for the purpose of producing plants or crops. This operation is generally performed in spring, as being the proper season for germination.

**SÖWING MACHINE**, *n.* A machine for depositing seeds in the soil, either equally over its surface, or in rows. Various machines of this kind have been contrived.

**SÖWL**, † *v. t.* To pull by the ears.

**SÖWMING**, } In *Scots law*, two old

**ROWMING**, } terms now applied to the action whereby the number of cattle to be brought upon a common by the persons respectively, having a servitude of pasturage, may be ascertained. The criterion is the number of cattle which each of the dominant proprietors is able to fodder during winter. A *sowm* of land is as much as will pasture one cow or ten sheep, or in some places one cow and five sheep; and, strictly speaking, to *sowm* the common is to ascertain the several *sowms* it may hold; and to *rowm* it is to portion it out amongst the dominant proprietors.

**SÖWN**, *pp.* Scattered, as seed; sprinkled with seed, as ground.

**SÖY**, *n.* A kind of sance prepared in China and Japan, from a small bean, the fruit of the *Soja-hispida*. It is eaten with fish, cold meat, &c. There are two or three qualities of soy, but the Japan soy is reckoned the best. [See **SOJA-HISPIDA**.]

**SÖYA** or **SÖWA**, *n.* An umbelliferous plant cultivated in India. It is the *Anethum sowa* of Roxburgh, the aromatic seed of which is much used by the natives in cookery, as well as for medicinal purposes.

**SÖYMI'DA**, *n.* A genus of plants, nat. order Cedrelaceae. The bark of *S. febrifuga*, the *rohuna* of Hindostan, is a useful tonic in India in intermittent fevers.

**SÖA**, *n.* A general name for a mineral spring. It is derived from a place, (Spa or spaa) in Belgium, celebrated for its mineral springs. It is situate about twenty miles from Aix-la-chapelle.

**SÖAAD**, *n.* A kind of mineral; spar. [Sp. *espato*.]

**SÖPACE**, *n.* [Fr. *espace*; L. *spatium*, space; *spatior*, to wander. This word is probably formed on the root of *pateo*.] 1. Room; extension in all directions. Space, in the abstract, is mere extension. Space is a simple idea, of which the modes are distance, capacity, extension, duration, &c. Space, considered with regard to length only,

is the same idea as that which we have of distance. If it be considered in regard to length, breadth, and thickness, it is the same as capacity. When considered between the extremities or boundaries of matter, which fills the capacity of space with something solid, tangible, and movable, it is called extension. Space may be conceived as existing without matter, for although the whole matter of the universe were annihilated, space would still remain. Space is usually divided into *absolute* and *relative*. *Absolute space* is that which is considered in its own nature, without regard to any thing external, which always remains the same; and is unbounded and immovable. *Relative space* is any portion of absolute space. It is capable of measurement, and is considered in regard to material objects. The ideas of space and of time enter into all our speculations on physical phenomena, and they are both necessarily involved in the idea of motion.

Pure space is capable neither of resistance nor motion. *Locke.*

2. Any quantity of extension. In relation to bodies, *space* is the interval between any two or more objects; as, the *space* between two stars or two hills. The quantity of *space* or extent between bodies, constitutes their distance from each other.—3. In *geom.*, the surface of any figure, or that which fills the interval or distance between the lines that terminate or bound the figure.—4. In *mech.*, the line which a moving body considered as a point, is conceived to describe by its motion. In uniform motion a body passes over equal *spaces* in equal times.—5. The distance or interval between lines; as, in books.—Among *printers*, a kind of blank type, with a shorter shank than the letter types, for separating words.—In *music*, the void between the lines in a staff. The spaces are four in number, and the lines five. The *spaces* in music are named as well as the lines.—6. Quantity of time; also, the interval between two points of time.

Nine times the *space* that measures day and night. *Milton.*

God may defer his judgments for a time, and give a people a longer *space* for repentance. *Tillotson.*

7. A short time; a while. To stay your deadly strife a *space*. *Spenser.* [*This sense is nearly obsolete.*]

SPACE, † v. i. To rove; to expatiate.

SPACE, v. t. Among *printers*, to make spaces or intervals between words.—To *space out*, to widen the intervals between words, or lines, in a page for printing.

SPACED, *pp.* Divided into wider intervals between lines.

SPACEFUL, † a. Wide; extensive.

SPACE/LESS, a. Destitute of space.

SPACING, *ppr.* Making wider intervals between words.

SPACIOUS, a. [*Fr. spacieux; L. spatiosus.*] 1. Wide; roomy; having large or ample room; not narrow; as, a *spacious* church; a *spacious* hall or drawing room.—2. Extensive; vast in extent; as, the *spacious* earth; the *spacious* ocean.

SPACIOUSLY, *adv.* Widely; extensively.

SPACIOUSNESS, n. Wideness; largeness of extent; roominess; as, the *spaciousness* of the rooms in a building.—2. Extensiveness; vastness of extent; as, the *spaciousness* of the ocean.

SPAD'DLE, n. [*dim. of Spade.*] A little spade.

SPADE, n. [*Sax. spad, spala; G. spatien;* probably from *breadth*, extension, coinciding with *L. spatula*, from the root of *pateo*.] 1. An instrument for digging, provided with a broad blade of wrought iron, steeled at its lower or cutting edge, and having a stout handle, adapted to be used with both hands.—2. A suit of cards.—3. A deer three years old; written also *spaid*.—4. A gelded beast. [*L. spado.*]

SPADE, v. t. To dig with a spade; or to pare off the sward of land with a spade.

SPADE-BONE, n. The shoulder-blade.

SPADEFUL, n. As much as a spade will hold. [The correct plural is *spadefuls*.]

SPADY'CEOUS, a. [*L. spadicus*, from *spadix*, a light red colour.] 1. Of a light red colour, usually denominated *bay*.—2. In *bot.*, a *spadiceous flower*, is a sort of aggregate flower, having a receptacle common to many florets, within a spathe, as in palms, dracuncium, arum, &c.

SPA'DICOSE, a. In *bot.*, growing on the spadix.

SPADILLE, n. (*spadil'*) [*Fr.*] The ace of spades at ombre.

SPADING, *ppr.* Digging with a spade.

SPADING, n. The operation of digging with a spade; the operation of paring off the surface or sward of grass land, by means of the paring spade, with an intent to burn it, and thus improve the land.

SPADIX, n. [*L.*] In *bot.*, a form of the inflorescence of plants, in which the flowers are closely arranged round a thick fleshy axis, and the whole surrounded by a large leaf or bract called a spathe; as in palms and arums.

SPAD'O, n. [*L.*] A gelding.

SPADROON, † n. A cut-and-thrust sword, lighter than a broadsword.

SPAE or SPAX, v. i.

and † [*Dan. spaer* to foretel.] To foretel; to divine; to forebode. Hence, a *spae man* signifies a prophet; a diviner; a soothsayer. [*Scotch.*]

SPAGYR'IC, † a. [*L. spagyricus.*] Chemical.

SPAGYR'IC, † n. A chemist.

SPAGYRIST, † n. A chemist.

SPA'HEE, } n. [*Turk. sipahi; Pers. SPA'HI,* } *sipahce.* See SEAPOY.] One of the Turkish cavalry. The *Spahis* were disbanded, along with the Janissaries, in 1826.

SPAIRGE, v. t. [*L. spargo, aspergo.*] To dash; as to *spairge* water; to bespatter by dashing any liquid; to sully by reproach. [*Scotch.*]

SPAKE, *pret. of Speak*; nearly obsolete. We now use *spoke*.

SPALL, *old n.* [*Fr. espaule; It. spalla.*] 1. The shoulder. [*Scotch.*]—2. † A chip.

SPALT, } n. A whitish scaly mineral, SPELT, } used to promote the fusion of metals.

SPAN, n. [*Sax. span; G. spanne; Dan. spana,* a span in measure; *Sw. span,* a span in measure, and a set of coach

horses; *G. gespann;* verbs, *Sax. spannan*, to span, to unite; *gespanian*, to join; *D. and G. spannen;* *Dan. spander*, to strain, stretch, bend, yoke. This word is formed on the root of *bend, L. pando*. The primary sense is to strain, stretch, extend, hence to join a team, *Dan. forspannd, D. gespan.*] 1. The space from the end of the thumb to the end of the little finger when extended; nine inches; the eighth of a fathom.—2. A short space of time.

Life's but a *span*: I'll every chin enjoy. *Farguhar.*

3. A *span of horses*, in *America*, consists of two of nearly the same colour, and otherwise nearly alike, which are usually harnessed side by side. The word signifies properly the same as *yoke*, when applied to horned cattle, from buckling or fastening together.—4. In *seamen's language*, a small line or cord, the middle of which is attached to a stay. Its use is to confine some rope which passes through the corresponding blocks, as also to increase the effort of the rope.—5. In *arch.*, an imaginary line across the opening of an arch or roof, by which its extent is estimated.

SPAN, v. t. To measure by the hand with the fingers extended, or with the fingers encompassing the object; as, to *span* a space or distance; to *span* a cylinder.—2. To measure or reach from one side of to the other; as, to *span* the heavens; a bridge *spans* the river. This suit doth *span* the world. *Herbert.*

3. In *marine language*, to confine with ropes; as to *span* the booms.—To *span in the rigging*, to draw the upper parts of the shrouds together by tackles.—To *span the runners*, to take several turns with small rope round both runners, abaft the mast, and to frap the turns.

SPAN, *pret. of Spin.*

SPAN CEL, n. A rope to tie a cow or a horse's hind legs. [*Local.*]

SPAN'CEL, v. t. To tie the legs of a horse or cow with a rope.

SPAN'CELLED, *pp.* In *her.*, an epithet for a horse that has the fore and hind leg of the near side fettered by means of fetter-locks fastened to the ends of a stick.

SPAN'CELLING, *ppr.* Tying a cow or a horse's hind legs.

SPAN'COUNTER, or SPAN'FARTHING,

n. A play at which money is thrown within a span or circuit marked.

SPAN'DREL, n. [*It. spandere*, to spread.] In *arch.*, the irregular triangular space comprehended between the outer curve or extrados of an arch,



a, Spathe, and b, Spadix of Arum maculatum.



Spancelled.



s, s, Spandrels.

a horizontal line drawn from its apex, and a perpendicular line from its springing. In *Gothic arch*, the spandrels are usually ornamented with tracery, foliage, &c.—*Spandrel brach-*

eting, a cradling of brackets which is placed between curves, each of which is in a vertical plane, and in the circumference of a circle whose plane is horizontal.—*Spandrel wall*, a wall built on the back of an arch filling in the spandrels.

SPANÉ, *v. t.* [*D. speenen.*] To wean. [*Scotch.*]

SPANG, *† n.* [*D. spange*, a spangle; *Gr. σπινγος.*] A spangle or shining ornament; a thin piece of metal or other shining material.—2. In *Scotland*, a span.

SPAN'GLE, *n.* [*supra.*] A small plate or boss of shining metal; something brilliant used as an ornament.—2. Any little thing sparkling and brilliant, like pieces of metal; as crystals of ice.

For the rich *spangles* that adorn the sky.  
*Waller.*

SPAN'GLE, *v. t.* To set or sprinkle with spangles; to adorn with small distinct brilliant bodies; as, a *spangled* breast-plate.

What stars do *spangle* heaven with such beauty.  
*Shak.*

SPAN'GLED, *pp.* Set with spangles.

SPAN'GLER, *n.* One that spangles.

SPAN'GLING, *ppr.* Adorning with spangles.

SPAN'IARD, *n.* A native of Spain.

SPAN'IEL, *n.* [*Fr. epagneul*; said to be from *Hispaniola*, now *Hayti.*] 1. A species of dog, the *Canis extrarius*, Linn. It has the hair very



Spaniel (*Canis extrarius*).

long in parts; it is generally white, with large brown, liver-coloured, or black spots, of irregular shape and size; the nose is sometimes cleft, the ears are very long and pendulous and covered with long hair. The setter is sometimes called the English spaniel. The smaller spaniel, or King Charles's dog (*Canis brevipilis*, Linn.), is a small variety of the spaniel, used as a lap-dog. The Maltese dog, and the lion dog (*Canis leoninus*, Linn.), are also small species of spaniel. The great water-spaniel (*C. aquaticus*, Linn.), is said to be the offspring of the great water-dog and the little spaniel. The spaniel is a valuable dog in sports of the field. He possesses a great share of intelligence, affection, and obedience, which qualities, combined with much beauty, make him highly prized as a companion.—2. A mean, cringing, fawning person.

SPAN'IEL, *a.* Like a spaniel; mean; fawning.

SPAN'IEL, *v. i.* To fawn; to cringe; to be obsequious.

SPAN'IEL, *v. t.* To follow like a spaniel.

SPAN'ILLING, *ppr.* Following like a spaniel.

SPANIOLIT'MINE, *n.* According to Kane, a solid compound contained in litmus. It consists of 18 atoms of carbon, 7 of hydrogen, and 16 of oxygen.

SPAN'ISH, *a.* Pertaining to Spain.

SPAN'ISH, *n.* The language of Spain.

SPAN'ISH-BROOM, *n.* A plant of the genus *Spartium*, the *S. junceum*, Linn.

SPAN'ISH-BROWN, *n.* A species of earth used in paints. Its colour depends upon the sesquioxide of iron.

SPAN'ISH-FLY, *n.* A coleopterous insect, the *Cantharis vesicatoria*, used in vesicatories, or compositions for raising blisters.

SPAN'ISH-NUT, *n.* A plant, the *Moræa Sisyrinchium* of the south of Europe.

SPAN'ISH-WHITE, *n.* A white earth from Spain, used in paints.

SPANK, *v. t.* [*W. pange*, a blow; allied perhaps to the vulgar *bang*, and found in the Persic.] To strike on the back with the open hand; to slap.

SPANK'ER, *† n.* A small copper coin.—2. In *seamen's lan.*, a ship's driver; a large

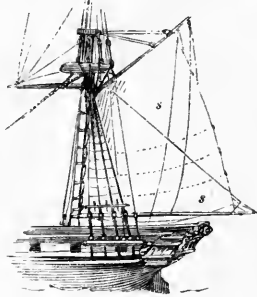

4, 5, Sparker.

sail occasionally set upon the mizzen-yard or gaff, the foot being extended by a boom.—*Spanker boom*, a boom projecting from the mizzen-mast beyond the taffrail.—3. One that takes long strides in walking; also, a tall person; any thing larger than common. [*Local or vulgar.*]

SPANK'ING, *ppr.* Striking with the open hand; moving with a quick lively pace.—2. *a.* Large; stout.

SPAN'-LONG, *a.* Of the length of a span.

SPAN'NED, *pp.* Measured with the hand.

SPAN'NER, *n.* One that spans.—2. The lock of a fusee or carbine; or the fusee itself.—3. A screw-key; an iron instrument used in the manner of a lever, for tightening up the nuts upon screws.—4. A cross brace.

SPAN'-NEW, *a.* [*G. spannen*; allied perhaps to *spangle.*] Quite new; probably *bright-new*.

SPAN'NING, *ppr.* Measuring with the hand; encompassing with the fingers.

SPAN'-PIECE, *n.* In *arch.*, a name given in some places to the collar-beam of a roof.

SPAN'-ROOF, *n.* In *arch.*, a name sometimes given to the most common roofing, which is formed by two inclined planes or sides, in contradistinction to a *shed* or *lean-to*.

SPAN'-SHACKLE, *n.* In *ships*, a large bolt driven through the fore-castle, and forelocked under the fore-castle beam, both under and upon the upper-deck beam.

SPAN'-WORM, *n.* A species of destructive caterpillar; canker-worm.

SPAR, *n.* [*D. spar*, a rafter, a shingle; *G. sparren*, a spar, a rafter; *Dan. spar*, a spar, a small beam, the bar of a gate; *Sw. sparre*, a rafter; *Fr. barre*; *It. sbarra*, a bar; *Sp. esparr*, a fossil; *espar*, a drug. If this word is connected with *spare*, the primary sense is probably *thin*. The sense of *bar* and *spar*, is however more generally de-

rived from thrusting, shooting in length; so *spear* likewise. See *BAR.*] 1. In *mineral.*, a term synonymous with the German *spath*, and employed to include a great number of crystallized, earthy, and some metallic substances, which easily break into rhomboidal, cubical, or laminated fragments, with polished surfaces; but without regard to the ingredients of which they are composed. Hence, a *specific* epithet must be employed to express the constituent parts as well as the figure; as, for instance, *calcareous spar*, *fluor spar*, *gypseous spar*, *adamantine spar*, *cubic spar*, *brown spar*, &c. Among *miners*, the term *spar* is frequently used alone, to express any bright crystalline substance; but in *mineralogy*, strictly speaking, it is never so employed.—2. A small beam or rafter.

In *arch.*, spars are the common rafters of a roof, as distinguished from the principal rafters. The same name is usually given to the round pieces of timber used for the yards and top-masts of ships.—3. *†* The bar of a gate. SPAR, *† v. t.* [*Sax. sparran*; *G. sperren*; from *spar.*] To bar; to shut, close, or fasten with a bar.

SPAR, *v. i.* [*Sax. spirian*, to argue or dispute, to *aspire*; *Russ. sporyu*, to dispute, to contend; *Ir. sparnam*. The Saxon word signifies to dispute, also to investigate, to inquire, or explore, to follow after. This is another form of the *L. spiro*, *Gr. σπρωω, σπρωγω*. The primary sense is to urge, drive, throw, propel.] 1. To dispute; to quarrel in words; to wrangle. [*Colloq.*]—2. To fight with prelusive strokes; to fight in show, as a pugilist.

SPAR'ABLE, *n.* [*sparrow-bill*, from the shape.] A kind of nail driven into the soles of shoes and boots.

SPARADRAP, *n.* [*Fr.*] a cere-cloth. [*Not English.*]

SPAR'AGE, [*Vulgar.*] See ASPAR'AGUS, RAGUS.

SPAR'-DECK, *n.* In *mar. lan.*, an upper deck of a ship, &c., where spars are laid up.

SPARE, *v. t.* [*Sax. spartian*; *G. sparen*; *Fr. épargner*. It seems to be from the same root as *L. parco*; *It. sparagnare.*] 1. To use frugally; not to be profuse; not to waste. Thou thy Father's thunder didst not *spare*.  
*Milton.*

2. To save or withhold from any particular use or occupation. He has no bread to *spare*, that is, to withhold from his necessary uses.

All the time he could *spare* from the necessary cares of his weighty charge, he bestowed on prayer and serving of God.  
*Knolles.*

3. To part with without much inconvenience; to do without.

I could have better *spared* a better man.  
*Shak.*

Nor can we *spare* you long.  
*Dryden.*

4. To omit; to forbear. We might have *spared* this toil and expense. Be pleased your politics to *spare*.  
*Dryden.*

5. To use tenderly; to treat with pity and forbearance; to forbear to afflict, punish, or destroy.

*Spare* us, good Lord.  
*Com. Prayer.*

Dim sadness did nor *spare* Celestial visages.  
*Milton.*

But man alone can whom he conquers *spare*.  
*Waller.*

6. Not to take when in one's power; to forbear to destroy; as, to *spare* the

life of a prisoner.—7. To grant; to allow; to indulge.

Where angry Jove did never spare  
One breath of kind and temperate air.

*Roscommon.*

8. To forbear to inflict or impose.

*Spare* my sight the pain

Of seeing what a world of tears it cost you.

*Dryden.*

SPARE, *v. i.* To live frugally; to be parsimonious.

Who at some times spend, at others spare,  
Divided between carelessness and care.

*Pope*

2. To forbear; to be scrupulous.

To pluck and eat my fill I spared not.

*Milton.*

3. To be frugal; not to be profuse.—4. To use mercy or forbearance; to forgive; to be tender.

The king... was sparing and compassionate toward his subjects.

*Bacon.*

SPARE, *a.* [Sax. *spær.*] 1. Scanty; parsimonious; not abundant; as, a spare diet.

He was spare but discreet of speech.

*Carew.*

[We more generally use, in the latter application, *sparing*; as, he was *sparing* of words.]—2. That can be dispensed with; not wanted; superfluous. I have no spare time on my hands.

If that no spare clothes he had to give.

*Svenser.*

3. Lean; wanting flesh; meagre; thin. O give me your spare men, and spare me the great ones.

*Shak.*

4. † Slow.—5. Among seamen, an epithet applied to any part of a ship's equipage or furniture, that lies in reserve, to supply the place of such as may be lost or rendered incapable of service; as, spare tiller; spare topmasts; spare sails; spare rigging, &c.

SPARE, † *n.* Parsimony; frugal use.

SPARE, *pp.* Dispensed with; saved; forborne.

SPARELY, *adv.* Sparingly.

SPARENESS, *n.* State of being lean or thin; leanness.

SPARET, *n.* One that avoids unnecessary expense.

SPARERIB, *n.* [D. *spier*, a muscle, and *rib*.] The piece of a hog taken from the side, consisting of the ribs with little flesh on them.

SPARGANIUM, *n.* A genus of plants, which, with the genus *Typha*, constitute the nat. order Typhaceæ. The species are monœcious, and the flowers are arranged in dense spherical heads. These plants are found commonly in ditches and marshes of the northern hemisphere. Three of them are common in Great Britain, where they are known by the name of *bur-reed*.

SPARGEFACT'ION, † *n.* [L. *spargo*, to sprinkle.] The act of sprinkling.

SPAR-HUNG, *a.* Hung with spar, as a cave.

SPARIDÆ, or SPAROYDES, *n.* A

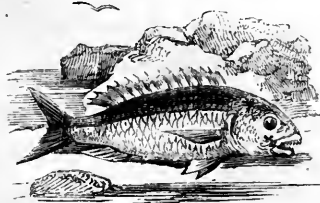

Gilt head (*Sparus aurata*).

family of fishes belonging to the section Acanthopterygii, of which the genus

*Sparus* is the type. The body is usually of an ovate form, and covered with large scales. The mouth is not protractile. The genera *sparus*, *sargus*, *pagnrus*, *chrysophrys*, *pagellus*, *dentex*, *pentapus*, &c., are comprehended in this family. The species feed chiefly upon small molluscs, crustacea, &c., for crushing which their strong teeth are admirably adapted.

SPARING, *ppr.* Using frugally; forbearing; omitting to punish or destroy.—2. *a.* Scarce; little.

Of this there is with you *sparing* memory, or none.

*Bacon.*

3. Scanty; not plentiful; not abundant; as, a *sparing* diet.—4. Saving; parsimonious.

Virgil being so very *sparing* of his words, and leaving so much to be imagined by the reader, can never be translated as he ought in any modern tongue.

*Dryden*

SPARINGLY, *adv.* Not abundantly.—2. Frugally; parsimoniously; not lavishly.

High titles of honour were in the king's minority *sparingly* granted, because dignity then waited on desert.

*Hoyward.*

Commend but *sparingly* whom thou dost love.

*Denham.*

3. Abstintently; moderately. Christians are obliged to taste even the innocent pleasures of life but *sparingly*.

*Atterbury.*

4. Seldom; not frequently.

The morality of a grave sentence, affected by Lucan, is more *sparingly* used by Virgil.

*Dryden.*

5. Cautiously; tenderly.

SPARINGNESS, *n.* Parsimony; want of liberality.—2. Caution.

SPÄRK, *n.* [Sax. *spærc*; D. *spartelen*, to flutter, to sparkle; Dan. *sparker*, to wince or kick. The sense is that which shoots, darts off, or scatters; probably allied to L. *spargo* and Russ. *sverkayu*.] 1. A small particle of fire or ignited substance, which is emitted from bodies in combustion, and which either ascends with the smoke, or is darted in another direction.—2. A small shining body or transient light.

We have here and there a little clear light, and some sparks of bright knowledge.

*Locke.*

3. A small portion of any thing active. If any spark of life is yet remaining.—4. A very small portion. If you have a spark of generosity.—5. † A brisk, showy, gay man.

The finest sparks and cleanest beaux.

*Prior.*

6. A lover.

SPÄRK, † *v. i.* To emit particles of fire; to sparkle.

SPÄRKFUL, *a.* Lively; brisk; gay.

SPÄRKISH, *a.* Airy; gay.—2. Snowy; well dressed; fine.

SPÄRKLE, *n.* A spark.—2. A luminous particle.—3. Any thing luminous; lustre.

SPÄRKLE, *v. i.* [D. *spartelen*.] 1. To emit sparks; to send off small ignited particles; as burning fuel, &c.—2. To glitter; to glisten; as, a brilliant sparkles; sparkling colours.—3. To twinkle; to glitter; as, sparkling stars.—4. To glisten; to exhibit an appearance of animation; as, the eyes sparkle with joy.—5. To emit little bubbles, as spirituous liquors; as, sparkling wine.

SPÄRKLE, † *v. t.* To throw about; to scatter.

SPÄRKLER, *n.* He or that which sparkles; one whose eyes sparkle.

SPÄRKLET, *n.* A small spark.

811

SPÄRKLINNESS, † *n.* Vivacity.

SPÄRKLING, *ppr.* or *a.* Emitting sparks; glittering; brilliant; lively; as, sparkling wines; sparkling eyes.

SPÄRKLINGLY, *adv.* With twinkling or vivid brilliancy.

SPÄRKLINGNESS, *n.* Vivid and twinkling lustre.

SPÄRLING, *n.* A smelt.

SPÄROID, *a.* [L. *sparus*, and Gr. *oides*.] Like the gilt head; belonging to that family of spinous-finned fishes named *sparidæ*.

SPÄRRING, *n.* Prelusive contention, as among boxers.—2. Dispute; slight debate. [Collog.]

SPÄR'ROW, *n.* [Sax. *spæra*; Goth. *sparwa*; G. and Dan. *sperling*; Sw. *sparf*; probably allied to *spear* or *spare*, and so named from its smallness.] A small bird of the genus *Fringilla* (*F. domestica*, Linn.) and order of Passeres. This well-known bird is the constant attendant on man wherever it is found. It inhabits Denmark, Norway, Sweden, the whole of the British Islands, France, Spain, Portugal, and other countries. The habits of the common sparrows, their amazing fecundity, their strong attachment to their young, the truculent battles in which they will occasionally engage in troops when excited upon some difference of opinion, arising out of questions of love or nest-property, their familiarity, not to say impudence, and their voracity, are familiar to all. They often do great injury to the corn fields, but they also do great service to the farmer in destroying grubs, caterpillars, &c., in spring and in the early part of summer.

SPÄR'ROW-BILL, *n.* See SPARABLE.

SPÄR'ROW-GRASS, a corruption of *Asparagus*.

SPÄR'ROW-HAWK, † *n.* [Sax. *spærr-hawk*,] *hófoc*, spear-hawk.] A small species of short-winged hawk. A popular name of all those falcons whose tarsi are high and scutellated. The *Falco nisus*



Sparrow-Hawk (*Falco nisus*).

of Linn., *Accipiter fringillarius* of others, is called *sparrow-hawk* by way of eminence. It is coloured like the goshawk, but its legs are longer, and it is a third less in size. The American sparrow-hawk is the *Falco sparverius*, Linn.

SPÄRRY, *a.* [from *spar*.] Resembling spar, or consisting of spar, having a confused crystalline structure; spathose.

SPÄRRY IRON, or SPÄRRY IRON ORE. Steel ore; a carbonate of iron. It is of a yellow, grey, brown, or black colour, and is found in metalliferous veins, as well as in common veins, in primary, transition, and secondary rocks.

It consists principally of protoxide or iron, and carbonic acid. It is a valuable iron ore, from the facility with which it can be converted into steel.

**SPARSE**, *a.* (spars.) [*L. sparsus*, scattered, from *spargo*.] 1. Thinly scattered; set or planted here and there; as, a *sparse* population.—2. In *bot.*, not opposite, nor alternate, nor in any apparent regular order; applied to branches, leaves, peduncles, &c.

**SPARSE**, *v. t.* (spars.) To disperse.

**SPARSE**D, *a.* Scattered.

**SPARSE**DLY, *adv.* In a scattered manner.

**SPARSELY**, *adv.* In a scattered or sparse manner; thinly.

**SPARSE**NESS, *n.* Thinness; scattered state; as, *sparse*ness of population.

**SPARTAN**, *a.* Pertaining to ancient Sparta; hence, hardy; undaunted; as, *Spartan* souls; *Spartan* bravery.

**SPARTI**NA, *n.* A genus of grasses, of the class and order Triandria digynia, Linn. Two species, *S. stricta* and *S. alternifolia*, are British plants, known by the name of cord-grass. The first is a remarkably stiff and rigid plant, growing in muddy salt marshes on the east and south-east coasts of England.

**SPARUS**, *n.* A genus of Acanthopterygion fishes, belonging to the family Sparidae. The species are chiefly known in England by the name of gilthead, though that name should properly be restricted to the *Sparus acorata*, a fish found plentifully in the Mediterranean, and which at times visits the coasts of Great Britain.

**SPASM**, *n.* [*L. spasmus*; Gr. *σπασμος*, from *σπασω*, to draw.] An abnormal, sudden, and more or less violent but brief contraction of one or more muscles, or muscular fibres. *Spasm* is either *clonic* or *tonic*. In *clonic spasm*, the muscles or muscular fibres contract and relax alternately in very quick succession, producing the appearance of agitation, as in *epilepsy*. In *tonic spasm*, the muscles or muscular fibres contract in a steady and uniform manner, and remain contracted for a comparatively long time, as in *tetanus*. Some cases of *spasm* appear to be intermediate between these two varieties.

**SPASMATICAL**, *a.* Spasmodical.

**SPASMODIC**, *a.* [Gr. *σπασμικός*, *spasm*, and *αίμα*, likeness; implying something which is like *spasm*, without being such; Fr. *spasmodique*; It. *spasmodico*.] Relating to *spasm*; consisting in *spasm*; convulsion; as, a *spasmodic* affection; *spasmodic* asthma; *spasmodic* cholera.

**SPASMODIC**, *n.* A medicine good for removing *spasm*; but the word generally employed is *anti-spasmodic*.

**SPASMODICAL**, *a.* Relating to *spasm*.

**SPASMODIC**, *n.* [Gr. *σπασμικός*, and *λογος*, discourse.] A treatise on convulsions or spasms.

**SPAS**TIC, *a.* [Gr. *σπαστικός*.] Relating to *spasm*. [A term preferable to *spasmodic*.]

**SPASTIC**ITY, *n.* A state of *spasm*.—2. The tendency to or capability of suffering *spasm*.

**SPAT**, *pret.* of *Spit*; as, he *spat*.

**SPAT**, *n.* [from the root of *spit*, that which is ejected.] The spawn of shell fish.

**SPATAN**GUS, *n.* A genus of Echinidae or sea-urchins, characterized by the bilabiated mouth being in the third region of the axis of the base, and the anus in the side of the truncated ex-

tremitry. The species are numerous.

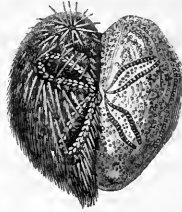

Violet Spatangus (*S. purpureus*).

One half shown with its spines removed.

They are generally of an oval or cordate form, with very slender spines.

**SPATCH**-COCK, *n.* A fowl killed, and immediately broiled, for some sudden occasion. [Possibly, at first, kitchen English for a despatched fowl.]

**SPATE**, or **SPAIT**, *n.* A flood; an inundation; a great torrent of rain. [Scotch.]

**SPATHA**, } *n.* [*L. spatha*, a slice.] In

**SPATHE**, } *bot.*, a large membranaceous bract, situated at the base of a spadix, which it encloses as a sheath.

It is seen in the greatest perfection in the palms and arums, and is supposed to perform the office of the ordinary floral envelopes. It is also applied to the calyx of some flowers that have no spadix; as the narcissus, crocus, iris, &c.

**SPATHA**'CEOUS, *a.* Having that sort of calyx called a spathe.

**SPATHIC**, *a.* [G. *spathic*.] Foliated or lamellar. *Spathic* iron is carbonated of iron; an ore of iron of a foliated structure, and a yellowish or brownish colour.

**SPATHIFORM**, *a.* [*spath* and *form*.] Resembling *spar* in form; as, the ochreous, *spathiform*, and mineralized forms of uranite.

**SPATHOSE**, *a.* In *bot.*, relating to, or formed like a spathe; spathaceous.—2. In *mineral*, sparry; of the nature of *spar*.

**SPATHOUS**, *a.* In *bot.*, spathose.

**SPATHULATE**. See **SPATULATE**.

**SPATIATE**, *v. i.* [*L. spatior*.] To rove; to ramble.

**SPAT**TER, *v. t.* [This root is a derivative of the family of *spit*, or *L. pateo*. See **SPUTTER**.] 1. To scatter a liquid substance on; to sprinkle with water or any fluid, or with any moist and dirty matter; as, to *spatter* a coat; to *spatter* the floor; to *spatter* the boots with mud. [This word is applied always to fluid or moist substances. We say, to *spatter* with water, mud, blood, or gravy; but never to *spatter* with dust or meal.]—2. Figuratively, to asperse; to defame. [In this sense, *asperse* is generally used.]—3. *†* To throw out any thing offensive; as, to *spatter* foul speeches.—4. To scatter about; as, to *spatter* water here and there.

**SPAT**'TER, *v. i.* To throw out of the mouth in a scattered manner; to *spatter*. [See **SPUTTER**.]

**SPAT**'TERDASHES, *n. plur.* [*spatter* and *dash*.] Coverings for the legs, to keep them clean from water and mud. [Since boots are generally worn,

these things and their name are little used.]

**SPAT**TERED, *pp.* Sprinkled or fouled by some liquid or dirty substance.—2. Aspersed.

**SPAT**TERING, *ppr.* Sprinkling with moist or foul matter.—2. Aspersing.

**SPAT**'TLE, *† n.* Spittle.—2. A spatula.

**SPAT**'TLING-POPPY, *n.* A plant, *Silene inflata*. It may be used as a substitute for asparagus, or green pease, the young shoots having the flavour of both.

**SPAT**'ULA, *n.* [*L. spathula*, *spatha*, a slice; *W. yspodol*; from the root of *L. pateo*; so named from its breadth, or from its use in spreading things.] A slice; an apothecary's instrument for spreading plasters, salves, &c.

**SPAT**'ULATE, *a.* [from *L. spathula*.]

In *bot.*, a spatulate leaf is one shaped,



Spatulate Leaf.

like a spatula or battle-dore, being roundish, with a long, narrow, linear base; as in *Cistus incanus*.—2. In *conchol.*, applied to shells which are rounded and broad at the top, and become narrower below.—3. In *cutom.*, applied to the figure of insects, when commencing with a narrow base, gradually widening by the lateral margins sloping out, and terminating at the extremity by a sudden straight line.

**SPAVIN**, *n.* [It. *spavenio*, *spavano*, *spavin*, a cramp; Fr. *eparvin*; Sp. *esparavan*; Port. *esparavam*.] A tumour or excrescence that forms on the inside of a horse's hough, not far from the elbow; at first like gristle, but afterward hard and bony.

**SPAVIN**ED, *a.* Affected with *spavin*.

**SPAW**L, *v. i.* [G. *speichel*, *spawl*; *speien*, to spawl, to spew. *Spew* is a contracted word.] 1. To throw saliva from the mouth in a scattering form; to disperse spittle in a careless, dirty manner.

Why must he sputter, *spawl*, and slaver it? *Swift*.

2. A fragment of stone.

**SPAW**L, *n.* Saliva or spittle thrown out carelessly.

**SPAW**LING, *ppr.* Throwing spittle carelessly from the mouth.

**SPAW**LING, *n.* Saliva thrown out carelessly.

**SPAWN**, *n.* It has no plural. [If this word is not contracted, it belongs to the root of *L. pono*, Fr. *pondre*, to lay eggs. If contracted, it probably belongs to the root of *spew* or *spawl*. The radical sense is, that which is ejected or thrown out.] 1. The eggs or ova of fishes and frogs when deposited, from which a new progeny arises, that continues the species. In the oviparous fishes, with distinct sexes, the eggs are impregnated externally and arrive at maturity without the aid of the mother. The spawn being deposited by the female, the male then pours upon it the impregnating fluid. In the ovoviviparous fishes, sexual intercourse takes place, and the eggs are hatched in the uterus. In the oviparous fishes, which are hermaphrodite, the spawn is impregnated previous to deposition by the same individual which deposits the eggs. Fishes exhibit a great variety in regard to the number of their eggs. In some the number is small, while in others it is prodigiously great. In the

spawn of a cod-fish, for example, no fewer than 3,686,760 eggs have been found. In general, before spawning, fish forsake the deep water and approach the shore, and some fish leave the salt water and ascend the rivers before spawning, and then return again.—2. Any product or offspring; *an expression of contempt*.—3. In gardening, the buds or branches which are produced from underground stems. Also, the white fibrous matter, which shooting through earth, dung, decaying vegetable matter, &c., is the matrix from which mushrooms and other fungi are produced.

**SPAWN**, *v. t.* To produce or deposit, as fishes do their eggs.—2. To bring forth; to generate; *in contempt*.

**SPAWN**, *v. i.* To deposit eggs, as fish or frogs.—2. To issue, as offspring; *in contempt*.

**SPAWN'ED**, *pp.* Produced or deposited, as the eggs of fish or frogs.

**SPAWN'ER**, *n.* The female fish.  
The *spawner* and the melter of the barbel cover their spawn with sand. *Waltou.*

**SPAY**, *v. t.* [*W. yspazu*, to exhaust; *dyspazu*, to geld; *Arm. spaza* or *spachin*, to geld; *L. spado*, a gelding; *Gr. σπασω*, to draw out.] To extirpate the ovaries of a female animal; to incapacitate a female animal for producing young. The operation of *spaying* is performed on the females of several kinds of animals to prevent conception, and promote their fattening. It is usually performed when the animal is young.

**SPAY'ADE**, *n.* In *her.*, a young stag in his third year.

**SPAY'ED**, *pp.* Having the ovaries extirpated.

**SPAYING**, *ppr.* Extirpating the ovaries.  
**SPEAK**, *v. i.* pret. *Spoke*, [*Spahe*, nearly obs.].] *pp.* *Spoke*, *Spoken*. [*Sax. spaccan*, *speacan*; *It. spiccar le parole*, to speak distinctly; *spicare*, to shine, that is, to shoot or thrust forth; *Eth. sabak*, to preach, to teach, to proclaim. The Sw. has *spa*, Dan. *spær*, to foretell. It is easy to see that the root of this word is allied to that of *beak*, *peak*, *pick*.] 1. To utter words or articulate sounds, as human beings; to express thoughts by words. Children learn to *speak* at an early age. The organs may be so obstructed that a man may not be able to *speak*.

*Speak*, Lord, for thy servant heareth; 1 Sam. iii.

2. To utter a speech, discourse, or harangue; to utter thoughts in a public assembly. A man may be well informed on a subject, and yet too diffident to *speak* in public.

Many of the nobility made themselves popular by *speaking* in parliament against those things which were most grateful to his majesty. *Cutrendon.*

3. To talk; to express opinions; to dispute.

An honest man, Sir, is able to *speak* for himself, when the knave is not. *Shak.*

4. To discourse; to make mention of.  
Lucan *speaks* of a part of Caesar's army that came to him from the Lemn lake. *Addison.*

The Scripture *speaks* only of those to whom it speaks. *Hammond.*

5. To give sound.  
Make all your trumpets *speak*. *Shak.*

To *speak with*, to converse with. Let me *speak with* my son.—To *speak with a vessel*, to communicate with those who are on board, either in person or by means of a speaking trumpet.

**SPEAK**, *v. t.* To utter with the mouth; to pronounce; to utter articulately; as human beings.

They sat down with him on the ground seven days and seven nights, and none *spoke* a word to him; Job ii.

*Speak* the word, and my son shall be healed; Matt. viii.

2. To declare; to proclaim; to celebrate.

It is my father's music  
To *speak* your deeds. *Shak.*

3. To talk or converse in; to utter or pronounce, as in conversation. A man may know how to read and to understand a language which he cannot *speak*.—4. To address; to accost.  
He will smile upon thee, put thee in hope, and *speak* thee fair. *Ecclus.*

5. To exhibit; to make known.

Let heaven's wide circuit *speak*  
The Maker's high magnificence. *Milton.*

6. To express silently or by signs. The lady's looks or eyes *speak* the meaning or wishes of her heart.—7. To communicate; as, to *speak* peace to the soul.—To *speak* a ship, to hail and speak to her captain or commander.

*Note*.—We say, to *speak* a word or syllable, to *speak* a sentence, an oration, piece, composition, or a dialogue, to *speak* a man's praise, &c.; but we never say, to *speak* an argument, a sermon, or a story.

**SPEAKABLE**, *a.* That can be spoken.—2. Having the power of speech.

**SPEAKER**, *n.* One that speaks in whatever manner.—2. One that proclaims or celebrates.

No other *speaker* of my living actions. *Shak.*

3. One that utters or pronounces a discourse; usually, one that utters a speech in public. We say, a man is a good *speaker*, or a bad *speaker*.—4. The presiding officer in each house of parliament. The speaker of the house of commons is a member of the house, elected by a majority of votes, to act as chairman or president, in putting questions, reading bills, keeping order, controlling the debates of the house, issuing warrants to the clerk of the crown to make out new writs for the election of members, when seats are vacant, and carrying into execution the resolutions of the house. The speaker chosen must be approved of by the crown. He is not to deliver his sentiments upon any question, or give his vote, except in a committee or in case of an equality of votes, when he has the privilege of giving a casting vote. It is also the duty of the speaker to interrupt a member whose language is indecorous, or who wanders from the subject of debate; he may also stop a debate, to remind the house of any standing order or established mode of proceeding, which he sees about to be violated. He, however, submits every thing to the decision of the house. The speaker of the house of lords is *ex-officio* the lord chancellor, keeper of the great seal, or other person holding the king's commission. He can speak and vote on any question. The same name is given to the president of other legislative bodies besides the British parliament, as in the American congress, &c.

**SPEAK'ERSHIP**, *n.* The office of speaker.

**SPEAKING**, *ppr.* Uttering words; discoursing; talking.

**SPEAKING**, *n.* The act of uttering

words; discourse.—2. In *colleges*, public declamation.

**SPEAKING**, *a.* Animated; as, a *speaking* portrait.

**SPEAKING-TRUMPET**, *n.* A trumpet by which the sound of the human voice may be propagated to a great distance. [*See TRUMPET*.]

**SPEAR**, *n.* [*Sax. speare*, *spere*; *D. and G. speer*; *W. yspar*, from *pdr*, a spear. So *W. ber* is a spear, and a spit, that which shoots to a point.] 1. A long pointed weapon used in war and hunting, by thrusting or throwing; a lance.

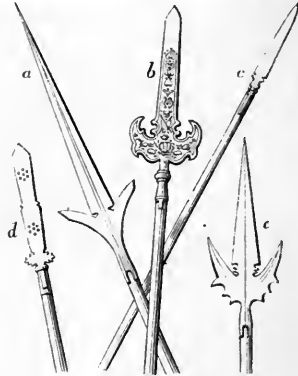

Ancient Spears.

- a. Spetum, time of Edward IV.  
b. Partisan, time of James I.  
c. Pike, time of Cromwell.  
d. Voulge or Bouge, time of Henry VII.  
e. Banseur, time of Henry VIII.

Also, the long piece of wood which is fixed to the body or beam of a cheval de frise.—2. A sharp pointed instrument with barbs; used for stabbing fish and other animals.—3. A shoot, as of grass; usually *spire*.—4. The feather of a horse, called also the streak of the spear. It is a mark in the neck, or near the shoulder of some barbs, which is reckoned a sure sign of a good horse.

**SPEAR**, *v. t.* To pierce with a spear; to kill with a spear; as to *spear* a fish.

**SPEAR**, *v. i.* To shoot into a long stem. [*See SPIRE*.]

**SPEAR'ED**, *pp.* Pierced or killed with a spear.

**SPEAR'ER**, *n.* A spearman.

**SPEAR-FOOT**, *n.* [*spear* and *foot*.] The far foot behind; used of a horse.

**SPEAR-GRASS**, *n.* [*spear* and *grass*] A long, stiff grass, a species of *Poa*, the *P. rigida*, Linn.

**SPEAR-HAND**, *n.* In the *manege*, a horseman's right hand.—2. A lancer's right hand.

**SPEARING**, *ppr.* Piercing or killing with a spear.—2. Shooting into a long stem.

**SPEARMAN**, *n.* [*spear* and *man*.] One who is armed with a spear; Ps. lxxviii.

**SPEARMINT**, *n.* [*spear* and *mint*.] A plant of the genus *Mentha*, the *M. viridis*. [*See MINT*.]

**SPEAR-THISTLE**, *n.* A plant of the genus *Cnicus*, the *C. lanceolatus*, Willd.; called also spear plume-thistle. It grows on way sides and in pastures. The leaves are downy beneath, and their points long and very sharp.

**SPEAR-WORT**, *n.* A plant of the genus *Ranunculus*. The great spear-wort is the *R. lingua*, Linn., and the lesser spear-wort is the *R. flammula*, Linn. Both are British plants. [*See RANUNCULUS*.]

SPEAT. See SPATE.

SPECHT, } n. A woodpecker. [Not  
SPEIGHT, } in use or local.]

SPE'CIAL, a. [Fr.; It. *speciale*; from L. *specialis*, from *species*, form, figure, sort, from *specio*, to see. Hence *species*, primarily, is appearance, that which is presented to the eye. This word and *especial* are the same.] 1. Designating a species or sort.

A special idea is called by the schools a species. *Watts.*

2. Particular; peculiar; noting something more than ordinary. She smiles with a special grace.

Our Saviour is represented everywhere in Scripture as the special patron of the poor and afflicted. *Atterbury.*

3. Appropriate; designed for a particular purpose. A private grant is made by a special act of parliament.—

4. Confined to some particular class of subjects; *ex. gr.* a special dictionary, as one of medicine or law. [Technical.]—5. Extraordinary; uncommon. Our charities should be universal, but chiefly exercised on special opportunities.—6. Chief in excellence.

The king hath drawn

The special head of all the land together. *Shak.*

Special administration, in law, is one in which the power of an administrator is limited to the administration of certain specific effects, and not the effects in general of the deceased.—

Special bail, consists of actual sureties recognised to answer for the appearance of a person in court; as distinguished from common bail, which is nominal.—

Special bailiff, is a bailiff appointed by the sheriff, for making arrests and serving processes.—Special case. In *Scots law*, in civil jury causes, a special case differs from a special verdict only in this, that the special verdict is returned by the jury; whereas the special case is adjusted by the parties themselves, or by their counsel, and sets forth the special facts on which they are agreed, without the evidence.—Special charge. In *Scots law*, letters of special charge, are letters passing under the signet, charging the heir of one who has died infert in lands, to enter heir to him, under certification that if no entry takes place, the complainer shall have the same execution against the lands as if the heir had entered.—Special constable, a person sworn to aid the constituted authorities, military or civil, in maintaining the public peace, on occasions of exigency; as, to quell a riot. Sometimes the epithet stands for the positive term; as, many *speculists* were in attendance.—Special contract. [See SPECIALTY.]—Special demurrer, is one in which the cause of demurrer is particularly stated.—Special grace, in *theol.*, according to Edwards, is "the renewing and sanctifying influences of the Holy Spirit, as distinguished from common grace, which only awakens and convicts."—Special imparlance, is one in which there is a saving of all exceptions to the writ or count, or of all exceptions whatsoever.—Special jury, is a jury of a superior class or supposed experience regarding the matter at issue. It may be called upon motion of either party, when the cause is supposed to require it.—Special jury book, in *Scots law*, a book kept by the sheriff, and prepared by copying from the general jury book the names of those qualified to serve as special jurors, that

is, persons possessed of heritable property yielding £100 of yearly rent, or personal property to the amount of £1000.—Special matter in evidence the particular facts in the case on which the defendant relies.—Special plea, in bar, is a plea which sets forth the particular facts or reasons why the plaintiff's demand should be barred, as a release, accord, &c.—Special pleading, the allegation of special or new matter, as distinguished from a direct denial of the matter alleged on the opposite side.—Special property, a qualified or limited property, as the property which a man acquires in wild animals, by reclaiming them.—Special service, in *Scots law*, that form of service by which an heir is served to his ancestor, in a special fental subject, and under a special character.—Special session of a court, an extraordinary session; a session beyond the regular stated sessions; or in corporations and counties in England, a petty session held by a few justices for despatching small business.—Special statute, is a private act of the legislature, such as respects a private person or individual.—Special tuit, is where a gift is restrained to certain heirs of the donee's body, and does not descend to the heirs in general.—Special verdict, is a verdict in which the jury find the facts and state them as proved, but leave the law arising from the facts to be determined by the court. Another method of finding a special verdict, is when the jury find a verdict generally for the plaintiff, but subject to the opinion of the court on a special case stated by the counsel on both sides, with regard to a matter of law.—Special verdict, in *Scots law*, in a criminal trial, a return of certain facts or circumstances as proved, without any general conclusion from them as to the pannel's guilt, the conclusion being left to be made by the judge, according to his opinion of the lawful construction of the facts so laid before him. In civil causes tried by jury, a special verdict must be confined to specific findings of fact, with no detail of the evidence on which the verdict rests.—Special warrant, a warrant to take a person and bring him before a particular justice who granted the warrant.

SPE'CIAL, † n. A particular.

SPE'CIALIST, n. A man of technicalities; a merely practical person.

SPECIAL'ITY, n. A particular or peculiar case; a particularity. [See SPECIALTY.]

SPE'CIALIZE, † v. t. To mention specially.

SPE'CIALLY, adv. Particularly; in a manner beyond what is common, or out of the ordinary course. Every signal deliverance from danger ought to be specially noticed as a divine interposition.—2. For a particular purpose. A meeting of the legislature is specially summoned.—3. Chiefly; especially.

SPE'CIALTY, n. Particularity.

Specialty of rule hath been neglected. *Shak.*

2. A particular or peculiar case.

Note. This word is now little used in the senses above. Its common acceptance is,

3. A special contract; an obligation or bond; the evidence of a debt by deed or instrument under seal. Such a debt is called a debt by specialty, in distinction from simple contract.

SPECIE, n. (spe'shiz.) Gold and silver

coin, in contradistinction to paper money. [See SPECIES.]

SPECIES, n. (spe'shiz.) *sing.* and *plur.*

[L. from *specio*, to see. See SPECIAL.]

1. In *zool.* and *bot.*, a species is usually defined a collection of individuals that are precisely alike in every character not capable of change by any accidental circumstances, and capable of uniform, invariable, and permanent continuance by natural propagation. All changes produced by accidental causes, in individuals of a species, and which are not capable of uniform, invariable, and permanent continuance by natural propagation, indicate and mark what are called varieties.

There are as many species as there are different invariable forms or structures of vegetables. *Martyn.*

2. In *mineral.*, a collection of minerals which are composed of the same ingredients, and combined in the same proportions.—3. In *logic*, a special idea, corresponding to the specific distinctions of things in nature, or it is a predicable which is considered as expressing the whole essence of the individuals of which it is affirmed. The genus and difference together make up, in logical language, the species. For example, a "biped" is compounded of the genus "animal," and the difference, "having two legs." The difference which, together with the genus, makes up the species, is termed the specific difference. [See PREDICABLE.]—4. Sort; kind; in a loose sense; as, a species of low cunning in the world; a species of generosity; a species of cloth.—5. Appearance to the senses; visible or sensible representation.

An apparent diversity between the species visible and audible, is that the visible doth not mingle in the medium, but the audible doth. *Bacon.*

The species of letters illuminated with indigo and violet. [Little used.] *Newton.*

6. Representation to the mind.

Wit...the faculty of imagination in the writer, which searches over all the memory for the species or ideas of those things which it designs to represent. [Little used.] *Dryden.*

7. Show; visible exhibition.

Shows and species serve best with the common people. † *Bacon.*

8. Coin, or coined silver and gold, used as a circulating medium; as, the current species of Europe. In modern practice, this word is contracted into specie. What quantity of specie has the bank in its vault? What is the amount of all the current specie in the country? What is the value, in specie, of a bill of exchange? We receive payment for goods in specie, not in bank notes.—9. In *phar.*, a simple; a component part of a compound medicine.—10. The old pharmaceutical term for powders.—11. In *alge.*, the letters, symbols, marks, or characters, which represent the quantities in any operation or equation.—In *geom.*, figures of the same species, are those which have the same form, whatever be their size.—In *spherical trigonometry*, the sides and angles of spherical triangles, are said to be of the same species, when by comparing any two sides, any two angles, or an angle and a side together, each is found to be greater or less than, or equal to, a quadrant or a right angle. But when by comparing a side with a side, an angle with an angle, or a side with an angle, one is found to be less, and an-



other greater than a quadrant or a right angle, such sides and angles are said to be of *different species*. The word *affection* is often used in spherical trigonometry in the same sense as species.—12. In *optics*, the image painted on the retina by the rays of light reflected from the several points of the surface of an object, received by the pupil, and collected in their passage through the crystalline lens, &c.

**SPECIFIC**, } *a.* [Fr. *specifique*; It. SPECIFIC, } *specifico.*] 1. That makes a thing of the species of which it is; designating the peculiar property or properties of a thing, which constitute its species, and distinguish it from other things. Thus we say, the *specific* form of an animal or a plant; the *specific* form of a cube or square; the *specific* qualities of a plant or a drug; the *specific* difference between an acid and an alkali; the *specific* distinction between virtue and vice.

*Specific* difference is that primary attribute which distinguishes each species from one another.

*Watts.* 2. In *med.*, acting upon some particular organ more than upon others; possessed of peculiar efficacy in the cure of a particular disease. [See the noun.]—*Specific character*, in *bot.*, a circumstance or circumstances distinguishing one species from every other species of the same genus.—*Specific gravity*, in *nat. philosophy*, the weight of any body under a given bulk or volume, or it is the weight of any particular kind of matter as compared with the weight of the same bulk of some other body, of which the weight is supposed to be familiarly known, and is therefore taken as the standard of comparison. Pure distilled water, at the temperature of 60° of Fahrenheit, is the substance usually employed for the purpose of comparing together the weights of all substances, except the gases. A cubic foot of distilled water at the temperature of 60° is found to weigh exactly 1000 ounces avoirdupois; consequently, assuming this as the specific gravity of distilled water, and comparing all other bodies with this, the same numbers that express their specific gravities, will at the same time express the weight of a cubic foot of each in avoirdupois ounces, which affords great facility to numerical computations. Or if the specific gravity of water be expressed by 1, the specific gravity of other substances will be expressed by a thousandth part of the former numbers. This only requires that three decimal places should be taken. Thus, a cubic foot of gold weighs 19,250 ounces; hence, taking 1000 for the specific gravity of water, 19,250 will express the specific gravity of gold; or, if 1 be the specific gravity of water, the thousandth part of 19,250, which is 19.250, will be the specific gravity of gold. In bodies of equal magnitudes, the weights are directly as the specific gravities; in bodies of the same specific gravities, the weights are directly as the magnitudes; in bodies of equal weights the specific gravities are inversely as the magnitudes; and the weights of different bodies are to each other in the compound ratio of their magnitudes and specific gravities. A body when immersed in a fluid loses a portion of its weight which is exactly equal to the weight of an equal bulk of the fluid; hence, if a body be weighed in air (or

rather in vacuo), and then in water, the difference between the two weights will give the weight of a quantity of water equal to the bulk of the solid. From this we can easily determine the specific gravity of any solid body; for, since in equal magnitudes the weights are as the specific gravities, the weight of the water equal in volume to the body, is to the actual weight of the body, as the specific gravity of water = 1, to the specific gravity of the body. [See GRAVITY and HYDROMETER.]—*Specific heat*. [See HEAT.]—*Specific name*, in *bot.*, is now used for the name which, appended to the name of the genus, constitutes the distinctive name of the species; but it was originally applied by Linnæus to the essential character of the species, or the *essential difference*. The present specific name he at first called the *trivial name*.

**SPECIFIC**, *n.* In *philosophy*, that which is peculiar to any thing, and distinguishes it from all others.—2. A medicine which acts upon some particular organ more than upon others: thus, ipecacuanha appears to have a *specific* action on the respiratory mucous membrane.—3. A medicine which is more uniform in its effects than any other, in any particular disorder: thus, cinchona is called a *specific* in certain forms of intermittent fever, and mercury in syphilis, &c. No such thing as an infallible specific is known.

**SPECIFICALLY**, *adv.* In such a manner as to constitute a species; according to the nature of the species. A body is *specifically* lighter than another, when it has less weight in the same bulk than the other.

Human reason...differs *specifically* from the fantastic reason of brutes. *Greiv.*

...Those several virtues that are *specifically* requisite to a due performance of duty. *South*

**SPECIFICICALNESS**, *n.* State of being specific.

**SPECIFICATE**, *v. t.* [L. *species*, form, and *facio*, to make.] To show, mark, or designate the species, or the distinguishing particulars of a thing; to specify.

**SPECIFICATION**, *n.* The act of determining by a mark or limit; notation of limits.

This *specification* or limitation of the question hinders the disputers from wandering away from the precise point of inquiry. *Watts.*

2. The act of specifying; designation of particulars; particular mention; as, the *specification* of a charge against a military or naval officer.—3. Among *architects, engineers, builders, or artists*, a statement of particulars, describing the dimensions, details, peculiarities, &c., of any work about to be undertaken. It is a condition in patents that the inventor should give a *specification* of his invention, in which the nature of the invention must be particularly described and ascertained.—4. Article or thing specified.—5. In *Scots law*, the formation of a new property from materials belonging to another.

**SPECIFICNESS**, *n.* Particular mark of distinction.

**SPECIFIED**, *pp.* Particularized; specially named.

**SPECIFY**, *v. t.* [Fr. *specifier*; It. *specificare*.] To mention or name, as a particular thing; to designate in words, so as to distinguish a thing from every

other; as, to *specify* the uses of a plant; to *specify* the articles one wants to purchase.

He has there given us an exact geography of Greece, where the countries and the uses of their soils are *specified*. *Pope.*

**SPECIFYING**, *ppr.* Naming or designating particularly.

**SPECIMEN**, *n.* [L. from *species*, with the termination *men*, which corresponds in sense to the English *hood* or *ness*.] A sample; a part or small portion of anything, intended to exhibit the kind and quality of the whole, or of something not exhibited; as, a *specimen* of a man's hand-writing; a *specimen* of painting or composition; a *specimen* of one's art or skill.

**SPECIOUS**, *a.* [Fr. *specieux*; L. *speciosus*.] 1. Showy; pleasing to the view.

The rest, far greater part,

Will deem in outward rites and *specious* forms

Religion satisfied. *Milton.*

2. Apparently right; superficially fair, just, or correct; plausible; appearing well at first view; as, *specious* reasoning; a *specious* argument; a *specious* objection; *specious* deeds. Temptation is of greater danger, because it is covered with the *specious* names of good nature, good manners, nobleness of mind, &c.

**SPECIOUSLY**, *adv.* With a fair appearance; with show of right; as, to reason *speciously*.

**SPECIOUSNESS**, *n.* Plausible appearance; fair external show; as, the *speciousness* of an argument.

**SPECK**, *n.* [Sax. *specca*; D. *spikkel*. In Sp. *peca* is a freckle or spot raised in the skin by the sun. This word may be formed from *peck*, for *pecked* has been used for *specked*, spotted as though pecked. Qu. Ar. *bahaa*, to be spotted.] 1. A spot; a stain; a small place in anything that is discoloured by foreign matter, or is of a colour different from that of the main substance; as, a *speck* on paper or cloth. 2. A very small thing.—3. The sole of a shoe.—4. The sole-fish.

**SPECK**, *v. t.* To spot; to stain in spots or drops.—2. To put a sole upon a shoe.

**SPECKLE**, *n.* A little spot in anything, of a different substance or colour from that of the thing itself.

**SPECKLE**, *v. t.* To mark with small spots of a different colour; used chiefly in the participle passive, — *which see*.

**SPECKLED**, *pp.* or *a.* Marked with specks; variegated with spots of a different colour from the ground or surface of the object; as, the *speckled* breast of a bird; a *speckled* serpent.—2. In *her.*, spotted over with another tincture.—*Speckled bird*, a denomination given to a person of doubtful character or principles. [Familiar.]

**SPECKLEDNESS**, *n.* The state of being speckled.

**SPECKLING**, *ppr.* Marking with small spots.

**SPECKT**, *n.* A woodpecker. [See SFEIGHT.]

**SPECTACLE**, *n.* [Fr. from L. *spectaculum*, from *specto*, to behold; *specto*, to see.] 1. A show; a gazing-stock; something exhibited to view; usually, something presented to view as extraordinary, or something that is beheld as unusual and worthy of special notice. Thus we call things exhibited for amusement, public *spectacles*, as

the combats of gladiators in ancient Rome.

We are made a *spectacle* to the world, and to angels, and to men; 1 Cor. iv.

2. Anything seen; a sight. A drunkard is a shocking *spectacle*.—3. Figuratively, something that aids the intellectual sight.

Shakespeare...needed not the *spectacles* of books to read nature. *Dryden*.

**SPECTACLE-BESTRID**, *a.* Bearing spectacles; as, with nose *spectacle*-*bestrid*.

**SPECTACLED**, *a.* Furnished with spectacles.

**SPECTACLE-MAKER**, *n.* One whose trade is spectacle-making.

**SPECTACLES**, *n. plur.* [*L. spectaculum. See SPECTACLE.*] A well known and invaluable optical instrument used to assist or correct some defect in the organs of vision. Common spectacles consist of two lenses, either convex or concave, set in a frame so constructed as to adhere to the nose and temples, and keep the lenses in the proper position. The earlier kinds were merely fixed on the nose. Spectacles with convex lenses are used to aid the sight of the aged, or those who are termed long or far sighted; and spectacles with concave lenses are used to assist the vision of those who are near sighted. In long sighted persons the refractive powers of the eye are too feeble, or the cornea is too much flattened; hence, the rays of light coming from an object after entering the eye, do not converge sufficiently soon to be brought to a focus, and form a perfect image of the object on the retina. The convex lens counteracts this defect by increasing the convergence of the rays, and causing them to meet at the retina. Short-sightedness is a defect the very reverse of that which has been stated, and hence, must be corrected by opposite means, namely, by concave lenses. In both cases the value of spectacles depends upon their being accurately adapted to the state of the eye. There is a kind of spectacles, commonly called *preserves* or *sight preservers*, the glasses of which are usually plane, and sometimes coloured; their utility is, however, dubious. Another kind of spectacles, called *goggles*, limit the field of view, and are used for correcting obliquity of vision. Another kind, called *periscope* spectacles, has been contrived in order to allow considerable latitude of motion to the eyes without fatigue. The lenses employed in this case are either of a meniscus or concavo-convex form, the concave side being turned to the eye. An invention of recent origin, called *railway spectacles*, with wire-cloth sights, is useful for keeping sand, ashes, &c., out of the eyes. We know not when or by whom spectacles were invented. Some assign their origin to the 12th, others to the 13th century. Spectacles, as they form an instrument of binocular power, are usually designated a *pair of spectacles*.

**SPECTACULAR**, *a.* Pertaining to shows.

**SPECTANT**, *ppr.* [*L. specto, to behold.*] In *her.*, a term applied to an animal at *gaze*, or looking forward; sometimes termed in *full aspect*. The term is likewise applied to any animal looking upwards with the nose bend-

**SPECTION**, *n.* [*L. spectatio.*] Regard; respect. [*Little used.*]

**SPECTATOR**, *n.* [*L. whence Fr. spectateur; It. spettatore.*] 1. One that looks on; one that sees or beholds; a beholder; as, the *spectators* of a show.—2. One personally present. The *spectators* were numerous.

**SPECTATORIAL**, *a.* Pertaining to the spectator.

**SPECTATORSHIP**, *n.* The act of beholding.—2. The office or quality of a spectator.

**SPECTRESS**, *n.* [*L. spectatrix.*]

**SPECTRIX**, *n.* A female beholder or looker on.

**SPECTRA**, *n. plur.* [*L. spectrum, from specio, to behold. See SPECTRUM.*] Images presented to the eyes after removing them from a bright or coloured object, or closing them. If, for example, we look intently with one eye upon any coloured object, such as a wafer placed on a sheet of white paper, and immediately afterwards, turn the same eye to another part of the paper, we shall see a similar spot, but of a different colour. Thus, if the wafer be red, the seeming spot will be green; if black, it will be changed into white. These images are also termed *ocular spectra* and *accidental colours*.

**SPECTRAL**, *a.* Pertaining to a spectre; ghostlike; ghostly.

**SPECTRAL**, *a.* Pertaining to ocular spectra; pertaining to the solar or prismatic spectrum; as *spectral* colours.

**SPECTRE**, *n.* [*Fr. spectre; from L. spectrum, from specio, to behold.*] 1. An apparition; the appearance of a person who is dead; a ghost.

The ghosts of traitors from the bridge descended.

With bold fanatic *spectres* to rejoice. *Dryden*.  
2. Something made preternaturally visible.

**SPECTRE-PEOPLED**, *a.* Peopled with ghosts.

**SPECTRES**, *n.* A family of orthopterous insects, comprehending such as have a linear and attenuated body, like the ghost of an insect.

**SPECTRUM**, *n. plur. Spectra*, [*L.*] A visible form; an image of something seen, continuing after the eyes are closed, covered or turned away. This is called an *ocular spectrum*. [*See SPECTRA.*]—2. In *optics*, the name given to an elongated image of the sun, formed on a wall or screen, by a beam of solar light passing through a small hole in a window-shutter into a dark room, and refracted by a triangular glass prism. The ray, on passing through the prism, is decomposed, and separated into seven rays of different colours, such as are observable in the rainbow. These are exhibited in the elongated image or *spectrum*, in the following order; namely, *red, orange, yellow, green, blue, indigo, and violet*; the red being lowermost. As the spectrum is produced by solar light, it is frequently called the *solar spectrum*, and because it is formed by means of a prism, it is further termed the *prismatic spectrum*, and the colours composing it the *prismatic colours*. A spectrum may be formed by any other luminous body as well as the sun.

**SPECTULAR**, *a.* [*L. specularis, from speculum, a mirror, from specio, to see.*] 1. Having the qualities of a mirror or looking-glass; having a smooth reflecting surface; as, a *specular* metal; a *specular* surface.—2. Assisting sight.

[*Improper and not used.*]—3. Affording view.

**SPECULATE**, *v. i.* [*L. speculor, to view, to contemplate, from specio, to see; Fr. speculer.*] 1. To meditate; to contemplate; to consider a subject by turning it in the mind and viewing it in its different aspects and relations; as, to *speculate* on political events; to *speculate* on the probable results of a discovery.—2. In *com.*, to purchase goods, stock, or other things, with the expectation of an advance in price, and of selling the articles with a profit by means of such advance; as, to *speculate* in coffee, or in sugar, or in six per cent. stock, or in bank stock.

**SPECULATE**, *v. t.* To consider attentively; as, to *speculate* the nature of a thing.

**SPECULATION**, *n.* Examination by the eye; view. [*Little used.*]—2. Mental view of anything in its various aspects and relations; contemplation; intellectual examination. The events of the day afford matter of serious *speculation* to the friends of Christianity.

Thenceforth to *speculations* high or deep  
I turn'd my thoughts. *Milton*.

3. Train of thoughts formed by meditation.

From him Socrates derived the principles of morality and most part of his natural *speculations*. *Temple*.

4. Mental scheme; theory; views of a subject not verified by fact or practice. This globe, which was formerly round only in *speculation*, has been circumnavigated. The application of steam to navigation is no longer a matter of mere *speculation*.

*Speculations* which originate in guilt, must end in ruin. *R. Hall*.

5. Power of sight.  
Thou hast no *speculation* in those eyes.†  
*Shak.*

6. In *com.*, the act or practice of buying articles of merchandize, or any purchasable commodities whatever, in expectation of a rise of price and of selling them at an advance, as distinguished from a regular trade, in which the profit expected is the difference between the retail and wholesale prices, or the difference of price in the place where the goods are purchased, and the place to which they are to be carried for market. Speculation on a large scale, on the principle of monopolizing, or that kind of speculation which consists in the purchase and sale of shares in public companies, as well as "dabbling in the stocks," and a variety of other hazardous transactions, may be considered as different species of gambling, and are often no less ruinous. A few men have been enriched, but many have been ruined by *speculation*.

**SPECULATIST**, *n.* One who speculates or forms theories; a speculator.

**SPECULATIVE**, *a.* [*Fr. speculatif; It. speculativo.*] 1. Given to speculation; contemplative; *applied to persons*.  
The mind of man being by nature *speculative*. *Hooker*.

2. Formed by speculation; theoretical; ideal; not verified by fact, experiment, or practice; as, a scheme merely *speculative*.

—3. Pertaining to view; also, prying.—

4. Pertaining to speculation in land, goods, &c.—5. Capable of being turned to account by improvement, or favourable representations, true or false; as, an ill conditioned but *speculative* picture. [*A dealer's term.*]

**SPECULATIVELY**, *adv.* In contem-

plation; with meditation.—2. Ideally; theoretically; in theory only, not in practice. Propositions seem often to be *speculatively* true, which experience does not verify.—3. In the way of speculation in lands, goods, &c.

**SPECU'LATIVENESS, n.** The state of being speculative, or of consisting in speculation only.

**SPECU'LATOR, n.** One who speculates or forms theories.—2. An observer; a contemplator.—3. A spy; a watcher.—4. In *com.*, one who buys goods, or other things, with the expectation of a rise of price, and of deriving profit from such advance.

**SPECU'LATORY, a.** Exercising speculation.—2. Intended or adapted for viewing or espying.

**SPECU'LUM, n.** [*L.*; *G.* and *D.* *spiegel*.] 1. A mirror or looking glass.—2. A glass that reflects the images of objects. In *optics*, the term *speculum* is usually applied to reflectors formed of polished metal, while the term *mirror* is used to signify a reflector of glass.—3. A metallic reflector used in catadioptric or reflecting telescopes, instead of the object glass in refracting telescopes.—4. In *sur.*, an instrument for dilating and keeping open certain parts of the body, in order to examine them attentively.

**SPECU'LUM-METAL, n.** Metal used for making the specula of reflecting telescopes. It is an alloy of two parts of copper and one of tin; its whiteness being improved by the addition of a little arsenic.

**SPEED, pret. and pp. of Speed.**

**SPEECH, n.** [*Sax. spec.* See **SPEAK.**] 1. The faculty of uttering articulate sounds or words, as in human beings; the faculty of expressing thoughts by words or articulate sounds. *Speech* was given to man by his Creator for the noblest purposes.—2. Language; words as expressing ideas.

The acts of God to human ears Cannot without process of *speech* be told.

*Milton.*

3. A particular language, as distinct from others; *Ps.* xix.—4. That which is spoken; words uttered in connection and expressing thoughts. You smile at my *speech*.—5. Talk; mention; common saying.

The duke did of me demand, What was the *speech* among the Londoners Concerning the French journey.

*Shak.*

6. Formal discourse in public; oration; harangue. The member has made his first *speech* in parliament.—7. Any declaration of thoughts.

I, with leave of *speech* inplor'd, replied.

*Milton.*

**SPEECH, † v. i.** To make a speech; to harangue. We now use *speechify*.

**SPEECH-CRIER, n.** One who hawks about a printed account of the execution, and confessions, when any are made, of criminals.

**SPEECHIFIED, pp.** Harangued.

**SPEECHIFY, v. i.** To make a speech; to harangue.

**SPEECHIFYING, ppr.** Haranguing.

**SPEECHING, n.** The act of making a speech.

**SPEECHLESS, a.** Destitute or deprived of the faculty of speech. More generally.—2. Mute; silent; not speaking for a time.

*Speechless* with wonder, and half dead with fear.

*Addison.*

**SPEECHLESSNESS, n.** The state of being speechless; muteness.

**SPEECH-MAKER, n.** One who makes speeches; one who speaks much in a public assembly.

**SPEED, v. i.** pret. and pp. *Sped, Speeded.* [*Sax. spedian, spadan;* *G. spediren,* to send; *Gr. εσπεδο.* The *L. expedito* may be from the same root, which signifies to drive, to hurry, of the family of *L. peto.*] 1. To make haste; to move with celerity.—2. To have success; to prosper; to succeed; that is, to advance in one's enterprise.

He that's once deni'd will hardly *speed.*

*Shak.*

Those that profaned and abused the second temple, *speed* no better.

*South.*

3. To have any condition, good or ill; to fare.

Ships heretofore in seas like fishes *sped,*  
The mightiest still upon the smallest fed.

*Waller.*

**SPEED, v. t.** To despatch; to send away in haste.

He *sped* him thence home to his habitation.

*Fairfax.*

2. To hasten; to hurry; to put in quick motion.

But *sped* his steps along the hoarse resounding shore.

*Dryden.*

3. To hasten to a conclusion; to execute; to despatch; as, to *speed* judicial acts.—4. To assist; to help forward; to hasten.

With rising gales that *sped* their happy flight.

*Dryden.*

5. To prosper; to cause to succeed. May heaven *speed* this undertaking.—6. To furnish in haste.—7. To despatch; to kill; to ruin; to destroy.

With a *speeding* thrust his heart he found.

*Dryden.*

A dire dilemma! either way I'm *sped!*  
If foes, they write, if friends, they read me dead.

*Pope.*

*Note.*—In the phrase, "God speed," there is probably a gross mistake in considering it as equivalent to "may God give you success." The true phrase is probably "good speed," good in Saxon, being written *god.* I bid you or wish you *good speed*, that is, good success.

**SPEED, n.** Swiftmess; quickness; celerity; *applied to animals.* We say, a man or a horse runs or travels with *speed*; a fowl flies with *speed.* We speak of the *speed* of a fish in the water, but we do not speak of the *speed* of a river, or of wind, or of a falling body. I think, however, I have seen the word applied to the lapse of time and the motion of lightning, but in poetry only.

—2. Haste; despatch; as, to perform a journey with *speed*; to execute an order with *speed.*—3. Rapid pace; as, a horse of *speed.* We say also, high *speed,* full *speed.*—4. Success; prosperity in an undertaking; favourable issue; that is, advance to the desired end.

O Lord God of my master Abraham, I pray thee, send me good *speed* this day;

*Gen.* xxiv.

This use is retained in the proverb, "to make more haste than good *speed,*" and in the Scriptural phrase, "to bid one good *speed,*" [not *God speed,* as erroneously written.]

**SPEEDFUL, a.** Full of speed; hasty.

**SPEEDILY, adv.** Quickly; with haste; in a short time.

Send *speedily* to Bertram.

*Dryden.*

**SPEEDINESS, n.** The quality of being speedy; quickness; celerity; haste; despatch.

**SPEED'LESS, a.** Having no speed.

817

**SPEEDWELL, n.** *Veronica,* a genus of plants, class and order *Diandria monogynia*, *Linn.*; nat. order *Scrophulariaceae*. The species consist of herbs, undershrubs, or shrubs, with opposite, alternate, or verticillate leaves. The flowers are of a blue, white, or red colour, and are arranged in spikes or racemes. The species are exceedingly numerous, and are distributed over all parts of the world, and are especially abundant in temperate climates. The Flora of Great Britain contains about twenty species.—*V. officinalis*, or common speedwell, was once extensively used as a substitute for tea, and also as a tonic and diuretic. *V. teuricium*, or Germander-leaved speedwell, has much the same properties as common speedwell, and at one time entered into the composition of several esteemed diet-drinks.—*V. chamaedrys*, or Germander speedwell, is a very general favourite, on account of its being among the very first that opens its flowers in the early spring. It is sometimes known by the name of bird's-eye, and is often mistaken for the Forget-me-not.

**SPEEDY, a.** Quick; swift; nimble; hasty; rapid in motion; as, a *speedy* flight; on *speedy* foot.—2. Quick in performance; not dilatory or slow; as, a *speedy* despatch of business.

**SPEEL, or SPELL, v. n.** To climb; to clamber. [*Scotch.*]

**SPEET, † v. t.** [*G. speeten;* from the root of *spit.*] To stab.

**SPEIGHT, n.** A woodpecker. [*Not in use or local.*]

**SPEL'FUL, a.** Having spells or charms.

**SPEIR, or SPERE, v. n.** [*Sax. spyrian,* to search out by the track or trace.] To trace or search out, to investigate; to make diligent inquiry; to ask; to inquire. Followed by *out, at, after, for, about.* [*Scotch.*]

**SPEISS, or SPEISE, n.** [*Ger.*] An artificial arseniuret of nickel; a metallurgic production obtained in forming smalt from the roasted ores of cobalt.

**SPELK, n.** [*Sax. spelc.*] A splinter; a small stick or rod used in thatching. [*Local.*]

**SPELL, n.** [*Sax. spel* or *spell,* a story, narration, fable, speech, saying, fame, report, sudden rumour, a magic charm or song. Hence *gospel,* *Sax. god-spell.* In *G. spiel* is play, sport; *spielen,* to play. But this is a different application of the same action. The verb primarily signifies to throw or drive, and is probably formed on the root of *L. pello,* *Gr. βαλλω.* See **PEAL** and **APPEAL.** In some of the applications of *spell,* we observe the sense of *turn.* We observe the same in *throw, warp, cant,* &c.] 1. † A story; a tale.—2. A charm consisting of some words of occult power; any form of words, whether written or spoken, supposed to be endowed with magical virtues. A superstition peculiarly prevalent among the ancients.

Start not; her actions shall be holy;  
You hear my *spell* is lawful.

*Shak.*

Begin, begin, the mystic *spell* prepare.

*Milton.*

3. Among workmen, a turn of work; relief; turn of duty.

Their toil is so extreme, that they cannot endure it above four hours in a day, but are succeeded by *spells.*

*Carew.*

4. In *seamen's lan.*, the period during which one or more sailors are employed in a particular exercise, from

which they are relieved, as soon as the limited time expires; such are the *spells* to the hand-lead in sounding; to the pump; to look out on the mast-head, &c.

**SPELL**, *v. t.* pret. and pp. *Spelled* or *Spelt*. [Sax. *spellian*, *spelligan*, to tell, to narrate, to discourse, which gives our sense of *spell* in reading letters; *spellian*, *spelligan*, to take another's turn in labour; D. *spellen*, to spell, as words; old Fr. *espeler*.] 1. To tell or name the letters of a word, with a proper division of syllables, for the purpose of learning the pronunciation. In this manner children learn to read by first *spelling* the words.—2. To write or print with the proper letters; to form words by correct orthography.

The word *satire* ought to be *spelled* with *i*, and not with *y*.

*Dryden*.  
3. Among *seamen*, to take a turn; to relieve; to fall in at any work by way of relief; as, to *spell* the pump; to *spell* the lead, &c.—To *spell* the mizzen, to let go the sheet and peak it up.—4. To charm; as, *spelled* with words of power.—5. To read; to discover by characters or marks; with out; as, to *spell* out the sense of an author.

We are not left to *spell* out a God in the works of creation.

*South*.  
6. † To tell; to relate; to teach.  
**SPELL**, *v. i.* To form words with the proper letters, either in reading or writing. He knows not how to *spell*. Our orthography is so irregular that most persons never learn to *spell*.—2. To read; to read unskillfully.

**SPELL**-BOUND, *a.* Bound as by a spell or charm.

**SPELL**'ED, } pret. and pp. of *Spell*.  
**SPELT**, }

**SPELL**'ER, *n.* One that spells; one skilled in spelling.—2. In *her.*, *spellers* are the small branches shooting out from the flat-part of a buck's horn, at the top.

**SPELL**'ING, *ppr.* Naming the letters of a word, or writing them; forming words with their proper letters.

**SPELL**'ING, *n.* The act of naming the letters of a word, or the act of writing or printing words with their proper letters.—2. Orthography; the manner of forming words with letters. Bad *spelling* is disreputable to a gentleman.

—3. That part of orthography which teaches the true manner of resolving words into syllables.

**SPELL**'ING-BOOK, *n.* A book for teaching children to spell and read.

**SPELT**, *n.* [Sax. *spelte*; G. *speltz*.] A species of grain, the *Triticum spelta*; called also German wheat.

**SPELT**, † *v. t.* [G. *spalten*; Dan. *spilder*.] To split; to break.

**SPELT**'ER, *n.* [G. and D. *spiauter*.] Natural impure zinc, which contains a portion of lead, copper, iron, a little arsenic, manganese, and plumbago.

**SPENCE**, † *n.* [Spens.] [Old Fr. *dispenſe*.] A buttery; a larder; a place where provisions are kept. In *Scotland*, it also signifies the interior apartment of a country house, or the place where the family sit and eat.

**SPENCER**, † *n.* One who has the care of the spence or buttery.—2. An outer coat or jacket, without skirts, named from the late Earl Spencer.—3. In *mar. lan.*, a fore-and-aft sail set abaft the fore and main masts; a trysail.

**SPEND**, *v. t.* pret. and pp. *Spent*. [Sax. *spendan*; L. *expendo*, from the participle of which is Fr. *depenser*; from

the root of L. *pando*, *pendeo*, the primary sense of which is to strain, to open or spread; allied to *span*, *pane*, &c., and probably to Gr. *σπῆλαι*, to pour out.] 1. To lay out; to dispose of; to part with; as, to *spend* money for clothing.

Why do ye *spend* money for that which is not bread? Is. lv.

2. To consume; to waste; to squander; as, to *spend* an estate in gaming or other vices.—3. To consume; to exhaust. The provisions were *spent*, and the troops were in want.—4. To bestow for any purpose; often with *on* or *upon*. It is folly to *spend* words in debate on trifles. 5. To effuse. [Little used.]—6. To pass, as time; to suffer to pass away.

They *spend* their days in wealth, and in a moment go down to the grave; Job xiii.

7. To lay out; to exert or to waste; as, to *spend* one's strength.—8. To exhaust of force; to waste; to wear away; as, a ball had *spent* its force. The violence of the waves was *spent*. Heaps of *spent* arrows fall and strew the ground.

*Dryden*.

9. To exhaust of strength; to harass; to fatigue.

Their bodies *spent* with long labour and thirst.

*Knolles*.  
To *spend* a mast, to break a mast in foul weather.

**SPEND**, *v. i.* To make expense; to make disposition of money. He *spends* like a prudent man.—2. To be lost or wasted; to vanish; to be dissipated.

The sound *spendeth* and is dissipated in the open air.

*Bacon*.  
3. To prove in the use.

Butter *spent* as if it came from the richer soil.

*Temple*.  
4. To be consumed. Candles *spend* fast in a current of air. Our provisions *spend* rapidly.—5. To be employed to any use.

The vines they use for wine are so often cut, that their sap *spendeth* into the grapes.

[Unusual.] *Bacon*.

**SPEND**'ER, *n.* One that spends; also, a prodigal; a lavisher.

**SPEND**'ING, *ppr.* Laying out; consuming; wasting; exhausting.

**SPEND**'ING, *n.* The act of laying out, expending, consuming, or wasting.

**SPEND**'THRIFT, *n.* [*spend* and *thrift*.] One who spends money profusely or imprudently; a prodigal; one who lavishes his estate.

**SPENT**, *pp.* from *Spent*. Wasted; consumed; gone; passed; decayed; worn out. A *spent* ball is a cannon or musket ball, which reaches its object without sufficient force to pass through it, or otherwise wound, than by a contusion.

**SPEP**, or **SPERR**, † *v. t.* To shut in; support.

**SPEP**'ABLE, † *a.* [L. *sperabilis*, from *spero*, to hope.] That may be hoped.

**SPEP**'ATE, † *a.* [L. *speratus*.] Hoped for.

**SPEP**'E, *v. t.* To ask; to inquire. [Scotch.]

**SPEP**'E, *n.* In *arch.*, an old term for the screen across the lower end of a dining hall, to shelter the entrance.

**SPEP**'ED, *pp.* Asked; inquired. [Scotch.]

**SPEP**'GULA, *n.* A genus of plants, nat. order Caryophyllaceæ. The species are found in fields and cultivated ground, especially on sandy soils, all over the world. The genus is divided into two sections, one of which possesses stipules; the other is without these organs. Four species are found in Britain, known by the name of spurrey. *S. arvensis*, corn-spurrey or

yarr, is a well known plant, growing in corn-fields. In some parts of the Continent, it is sown as fodder for animals. Cattle and sheep are fond of it; and hens also eat it, and are said to lay a greater number of eggs in consequence.

**SPEP**'M, *n.* [Fr. *sperme*; L. *sperma*; Gr. *σπῆμα*.] 1. Animal seed; that by which the species is propagated.—2. The head matter of a certain species of whale, called *cachalot*. [See **SPEP**-**MACE**'TI].—3. Spawn of fishes or frogs.

**SPEP**-**MACE**'TI, *n.* [L. *sperma*, sperm, and *cetus*, a whale. It is pronounced as it is written.] Adipocere, a fatty material obtained from the *Physeter macrocephalus*, a species of whale



Spermaceti Whale (*Physeter macrocephalus*).

generally met with in the South Seas, but occasionally also on the coasts of Greenland. This animal, called the *cachalot* or white whale, is of immense size, frequently sixty or more feet in length, of which the head constitutes one third. The head is the chief reservoir of the spermaceti, which, however, is found in several other parts of the body mixed with the sperm oil. During the life of the animal, the spermaceti is in a fluid state, and on the head being opened, has the appearance of an oily white liquid. On exposure to the air, the spermaceti concretes, and deposits from the oil. They are then separated, and put into different barrels. Some of the larger whales have been known to yield 24 barrels of spermaceti, and from 70 to 100 barrels of oil. After being brought to England, the spermaceti is purified. It then concretes into a white, crystallized, brittle, semitransparent unctuous substance, nearly inodorous and insipid. It dissolves in boiling alcohol, and as the solution cools, it is deposited in perfectly pure lamellated crystals. It is then called cetine. A hundred parts of spermaceti consist of 60 parts of margaric and oleic acids, 40 parts of ethal, and 0.9 parts of a yellow extractiform substance. It is bland and demulcent, with considerable nutritive qualities when taken internally. It is chiefly employed externally as an ingredient in ointments and cerates. It is also largely used to form candles.

**SPEP**-**MACE**'S'E, } *n.* Button-weed, a **SPEP**-**MACE**'S'E, } genus of plants, belonging to the nat. order Rubiaceæ. The species are abundant in tropical parts of the world. The roots of *S. poaya* and *fernyguinea* form substitutes for ipecacuanha.

**SPEP**-**MACE**'PHORE, *n.* [Gr. *σπῆμα*, seed, and *φορεω*, to bear.] In *bot.*, that part of the ovary, from which the ovules arise. It is synonymous with placenta. **SPEP**-**MACE**'TIC, *a.* Consisting of seed; seminal.—2. Pertaining to the semen, or conveying it; as, *spermatic* vessels, *spermatic* artery, cord, and veins. **SPEP**-**MACE**'TICAL, *a.* Spermatic. [Not much used.]

SPERMATIZE, † *v. i.* To yield seed.  
SPERMATOCELE, *n.* [Gr. *σπέρμα*, seed, and *κύημα*, tumour.] A swelling of the spermatie vessels, or vessels of the testicles.

SPERMATOZOA, *n. pl.* [Gr. *σπέρμα*, and *ζωον*.] Minute particles in the spermatie fluid of animals, resembling certain infusoria.

SPERMIDIUM, *n.* [from Gr. *σπέρμα*, a seed.] In *bot.*, a kind of small seed-vessel resembling a seed, and more commonly called an *achenium*. [See *ACHENIUM*.]

SPERMODERM, † *n.* [Gr. *σπέρμα* and *δερμα*.] In *bot.*, the whole integuments of a seed in the aggregate.

SPERM OIL, } *n.* The oil of  
SPERMACE'TI OIL, } the spermaceti  
whale, which is separated from the spermaceti. This kind of oil is much purer than train oil, and burns away witout leaving any charcoal on the wicks of lamps. In composition it differs but slightly from common whale oil.

SPERMOL'OGIST, *n.* One who treats of seeds.

SPERMO'PHAGA, *n.* Swainson's name for a subgenus of Fringillidæ.

SPERMO'PHILA, *n.* Swainson's name for a subgenus of Fringillidæ.

SPERMO'PHILUS, *n.* Cuvier's name for a genus of marmots that have cheek pouches. The superior lightness of their structure has caused them to be called *ground-squirrels*. Eastern Europe produces one species, *M. citillus*, called also the souslik or zizel. Several species are found in North America.

SPERSE, † *v. t.* To disperse.

SPER'VEIL, *n.* In *arch.*, an old term for the wooden frame at the top of a bed or canopy. Sometimes the term includes the *tester*, or head picce. It signified originally a tent.

SPET, † *v. t.* To spit; to throw out.

SPET, † *n.* Spit, or a flow.

SPEW, *v. t.* [Sax. *spwian*; D. *spuwen*, *spuigen*; G. *speien*, contracted from *speichen*; L. *spuo*.] 1. To vomit; to puke; to eject from the stomach.—2. To eject; to cast forth.—3. To cast out with abhorrence; Lev. xviii.

SPEW, *r. i.* To vomit; to discharge the contents of the stomach.

SPEW'ED, *pp.* Vomited; ejected.

SPEW'ER, *n.* One who spews.

SPEW'ING, *ppr.* Vomiting; ejecting from the stomach.

SPEW'ING, *n.* The act of vomiting.

SPEW'Y, *a.* Wet; foggy. [Local.]

SPHA'CEL, *n.* Gangrene. [See *SPHACELUS*.]

SPHAC'ELATE, *v. i.* [See *SPHACELUS*.] To mortify; to become gangrenous; as flesh.—2. To decay or become carious, as a bone.

SPHAC'ELATE, *v. t.* To affect with gangrene.

SPHAC'ELATE, *a.* In *bot.*, decayed, withered, or dead.

SPHAC'ELATED, *pp.* Affected with gangrene; mortified.

SPHACELA'TION, *n.* The process of becoming or making gangrenous; mortification.

SPHAC'ELISM, *n.* A gangrene; an inflammation of the brain.

SPHAC'ELUS, *n.* [Gr. *σφακίλος*, from *σφαζω*, to kill.] 1. In *med. and sur.*, gangrene; mortification of the flesh of a living animal.—2. Death of a bone.

SPHÆRALCE'A, *n.* A genus of plants, nat. order Malvaceæ. The species are trees or shrubs with toothed or 3-5-

lobed leaves, and flowers of a reddish or flesh colour. With the exception of one which is a native of the Cape of Good Hope, they are all natives of South America. They are all of them elegant flowers, and will thrive well in gardens in this country. *S. cisplatina* is used medicinally in Brazil in the same manner as marsh-mallows are in Europe.

SPHÆRAN'THUS, *n.* A genus of plants, nat. order Compositæ. The species are small herbs, common in tropical parts of the Old World. Some of them are bitter and aromatic.

SPHÆ'RIA, *n.* A genus of plants, nat. order Fungi. It is well known by possessing a rounded external receptacle, which opens at the top with a minute orifice. The species are generally found upon decaying vegetable matter, as on the bark of the stem and branches of decayed trees, and also on decaying leaves, on the stems of grasses, and on the surface of decaying wood. Upwards of 200 species have been recorded as British.

SPHERISTE'RUM, *n.* [Gr. *σφαίρα*, a sphere or ball.] In *ancient arch.* a building for the exercise of the ball; a tennis-court.

SPHÆ'RULITE. See *SPHERULITE*.  
SPHAG'NOUS, *a.* [*sphagnum*, bog-moss. *Linnaeus*.] Pertaining to bog-moss; mossy.

SPHAG'NUM, *n.* A genus of plants, nat. order Musci or mosses. The plants of this genus are widely diffused over the surface of the earth. They are aquatic plants, and constitute the great mass of our bogs, in swampy and moory districts. The formation of peat in such situations is often owing, in a great measure, to these plants. All the species used to be included under the name of *sphagnum palustre*, but later botanists have multiplied the species to fourteen, four of which are British.  
SPHÆ'CIDÆ, *n.* Leach's name for a family of hymenopterous insects of the section Fossores. Several species are found in England; they usually make burrows in the sand for nidification.

SPHENE, *n.* [Gr. *σφην*, a wedge.] A mineral composed of silicic acid, titanic acid, and lime. Its colours are dull yellow, green, gray, brown, and black. It is found unmorphous and in crystals. The primary form of its crystal is an oblique rhombic prism.

SPHENOID', } *a.* [Gr. *σφην*, a wedge,  
SPHENOID'AL, } and *ὄστρον*, form.] Resembling a wedge. The *sphenoid bone* is the pterygoid bone of the basis of the skull, so named because it is wedged in amidst the other bones of the head.

—*Sphenoidal suture*, the sphenoidal and ethmoidal sutures are those which surround the many irregular processes of the sphenoid and ethmoidal bones, and join them to each other and to the rest.

SPHENO-MAXILLARY, *a.* Relating to the sphenoid and maxillary bones.

SPHENO-PALATINATE, *a.* Relating to the sphenoid and palate bones.

SPHENO-PARIETAL, *a.* Relating to the sphenoid and parietal bones.

SPHENOPTEKIS, *n.* A genus of fossil ferns, remarkable for the wedge-shaped divisions of their fronds.

SPHENO-TEMPORAL, *a.* Relating to the sphenoid and temporal bones.

SPHÈRE, *n.* [Fr. from L. *sphæra*, Gr. *σφαίρα*, whence G. *sphère*.] 1. In *geom.*, a solid body contained under a single surface, which in every part is equally

distant from a point called its centre, and hence all its radii are equal. It may be conceived to be generated by the revolution of a semicircle about its diameter, which remains fixed, and which is hence called the *axis* of the sphere. A section of a sphere made by a plane passing through its centre, is called a *great circle* of the sphere; and when the cutting plane does not pass through the centre, the section is called a *small circle* of the sphere. A sphere is two-thirds of its circumscribing cylinder. Spheres are to one another as the cubes of their diameters. The surface of a sphere is equal to four times the area of one of its great circles, and the solidity is found by multiplying the cube of the diameter by  $\frac{5236}{3}$  or  $\frac{1}{3}$  of 7854; or by multiplying the area of a great circle by  $\frac{2}{3}$  of the diameter.—2. An orb or globe of the mundane system, as, the sun, the earth, the stars, or planets.

First the sun, a mighty sphere, he fram'd.

Milton.

Then mortal ears

Had heard the music of the spheres.

Dryden.

3. An orbicular body, or a circular figure representing the earth or apparent heavens.—4. Circuit of motion; revolution; orbit; as, the diurnal sphere.

—5. In *astron.* the concave expanse of the heavens, which appears to the eye as the interior surface of a hollow sphere enclosing the earth, which is placed at its centre. In this sphere all the heavenly bodies appear to be fixed, and at equal distances from the eye. It is also called the *celestial sphere*. The equator, ecliptic, meridians, &c., are circles of the celestial sphere.—6. In *geography*, a representation of the earth on the surface of a globe, which has also represented on it an assemblage of circles, showing the positions of the equator, ecliptic, meridians, &c.—7. Circuit of action, knowledge, or influence; compass; province; employment. Every man has his particular sphere of action, in which it should be his ambition to excel. Events of this kind have repeatedly fallen within the sphere of my knowledge. This man treats of matters not within his sphere.—8. Rank; order of society. Persons moving in a higher sphere claim more deference.—*Sphere of activity* of a body, the whole space through which the influence of a body, as a magnet, &c., extends.—*A right sphere*, that aspect of the heavens in which the circles of daily motion of the heavenly bodies are perpendicular to the horizon. A spectator at the equator views a *right sphere*.—*A parallel sphere*, that in which the circles of daily motion are parallel to the horizon. A spectator at either of the poles would view a *parallel sphere*.—*An oblique sphere*, that in which the circles of daily motion are oblique to the horizon, as is the case to a spectator at any point between the equator and either pole.—*Armillary sphere*, an artificial representation of the circles of the sphere, by means of brass rings. [See *ARMILLARY*.]—*Doctrine of the sphere*, the doctrine of the properties of the sphere considered as a geometrical body, particularly the several circles described on its surface, with the method of projecting these on a plane, and likewise the application of these geometrical properties, and no-

tions to geography and astronomy.—*Projection of the sphere.* [See PROJECTION.]—*Terrestrial sphere,* the earth, or any representation of it. SPHERE, *v. t.* To place in a sphere.

The glorious planet Sol

In noble eminence enthron'd, and *sphered* Amidst the rest. [Unusual.] *Shak.*  
2. To form into roundness; as, light *sphered* in a radiant cloud.

SPHERE-BORN, *a.* Born among the spheres.

SPHERED, *pp.* Placed in a sphere.

SPHERE-DSCEND'ED, *a.* Descended from the spheres.

SPHERE-MEL'ODY, *n.* Melody of the spheres.

SPHERE-MUSIC, *n.* The music or harmony of the spheres.

SPHER'IC, } *a.* [It. *sferico*; Fr. SPHER'ICAL, } *spherique*; L. *sphæricus*.]

1. Globular; orbicular; having a surface in every part equally distant from the centre; as, a *spherical* body. Drops of water take a *spherical* form.—2. Planetary; relating to the orbs of the planets.

We make guilty of our disasters the sun, the moon and the stars, as if we were villains by *spherical* predominance. *Shak.*

3. Relating to a sphere.

*Spherical geometry*, that branch of geometry which treats of spherical magnitudes, as, *spherical* triangles, arches, and angles.—*Spherical angle*, an angle formed on the surface of a sphere, by the intersection of two great circles, and is the same with the inclination of the planes of these circles.—*Spherical triangle*, a triangle formed on the surface of a sphere by the mutual intersection of three great circles. Spherical triangles are divided into *right-angled*, *oblique-angled*, *equilateral*, *isosceles*, &c., as plane triangles are.—*Spherical trigonometry*, that branch of trigonometry which teaches to compute the sides and angles of spherical triangles. [See TRIGONOMETRY.]—*Spherical excess*, the excess of the sum of the three angles of a spherical triangle above two right angles or 180°, the three angles of every spherical triangle being greater than two right angles.—*Spherical aberration.* [See ABBERRATION.]

SPHER'ICAL BRACKETING, *n.* In *arch.*, brackets so formed that the surface of the lath-and-plaster work which they support forms a spherical surface.

SPHER'ICALLY, *adv.* In the form of a sphere.

SPHER'ICALNESS, } *n.* The state or SPHERIC'ITY, } quality of being orbicular or spherical; roundness; as, the *sphericity* of a drop of water.

SPHER'ICLE, *n.* A small sphere.

SPHER'ICS, *n.* In *geom.*, the doctrine of the properties of the sphere considered as a geometrical body; and in particular of the different circles described on its surface, with the method of projecting the same on a plane.

SPHE'ROID, *n.* [Gr. *σφαῖρα*, a sphere, and *ειδής*, form.] A body or figure approaching to a sphere, but not perfectly spherical. In *geom.*, a spheroid is a solid, generated by the revolution of an ellipse about one of its axes. When the generating ellipse revolves about its longer or major axis, the spheroid is *oblong* or *prolate*; when about its less or minor axis, the spheroid is *oblate*. The earth is an oblate spheroid, that is, flattened at the poles, so that its polar diameter is shorter than

its equatorial diameter. [See EARTH.] The same figure is assumed by the other planets; hence, the properties of the oblate spheroid are of great importance in geodesy and astronomy.

SPHEROID'AL, } *a.* Having the SPHEROID'IC, } form of a spheroid.—2. In *crystallography*, bounded by several convex faces.

SPHEROID'AL BRACKETING, *n.* In *arch.*, bracketing which has a spheroidal surface.

SPHEROID'ITY, *n.* The state or quality of being spheroidal.

SPHEROMETER, *n.* [Gr. *σφαῖρα* and *μετρον*, measure.] An instrument for measuring the thickness of small bodies, when great accuracy is required; the curvature of optical glasses, &c.

SPHEROSID'ERITE, *n.* A substance found in the basaltic compact lava of Steinheim; called also glass lava or hyatite.

SPHER'ULE, *n.* [L. *sphærule*.] A little sphere or spherical body. Mercury or quicksilver, when poured upon a plane, divides itself into a great number of minute *spherules*.

SPHER'ULITE, *n.* A variety of obsidian or pearl-stone, found in rounded grains.

SPHERY, *a.* Belonging to the spheres.—2. Round; spherical.

SPHIGMO'METER, } *n.* [Gr. *σφίγμις*, SPHYGMO'METER, } the pulse, and *μετρον*, measure.] An instrument for counting the arterial pulsations, and one which renders the action of the pulse visible to the eye, and indicates its strength.

SPHIN'XTER, *n.* [from Gr. *σφίγγω*, to constrain, to draw close.] In *anat.*, a name applied generally to a kind of circular muscles, or muscles in rings, which serve to close the external orifices of organs; as the *sphincter* of the mouth, of the eyes, &c.; and more particularly to those among them which, like the *sphincter ani*, have the peculiarity of being in a state of permanent contraction, independently of the will, and of relaxing only when it is required, that the contents of the organs which they close should be evacuated.

SPIIN'GIDÆ, *n.* A family of lepidopterous insects, section Crepuscularia. The insects belonging to this division generally fly in the evening or early in the morning, but there are many which fly in the day-time. This family embraces some of the largest European lepidoptera; as, the death's head hawk-moth, the *sphinx atropos*, Linn; the privet hawk-moth, (*sphinx ligustri*.)

SPHINX, *n. pl.* *Sphinxes*. The classic plur. *sphinxes* is sometimes used. [Gr. *σφίγξ*; L. *sphinx*.] 1. A famous monster in Egypt, having the body of



Sphinx guarding a cinerary urn.

a lion and the face of a young woman, or the head of a ram. In some cases the head is covered with a kind of cap, which also covers part of the neck.

The Egyptian sphinxes were generally placed at the entrance of temples, where they often formed a long avenue leading to the temple. The Greek sphinxes are represented with wings, but those of Egypt were without wings. Sphinxes are also found in India as ornaments of temples, but they are always represented with the head of a man.—2. In *entom.*, the hawk-moth, a genus of lepidopterous insects, section Crepuscularia. They are so named from the attitude of several of the caterpillars, which resembles that of the fabled monster so called. [See SPHINGIDÆ.]

SPHRAG'ID, *n.* A species of ochreous clay, which falls to pieces in water with the emission of many bubbles; called also earth of Lemnos.

SPHRAGIS'TIES, *n.* [Gr. *σφραγίς*, a seal.] The science of seals, their history, peculiarities, and distinctions. The chief object of this science is to ascertain the age and genuineness of the documents to which seals are affixed.

SPHYGMOMETER. See SPHIGMO-METER.

SPI'AL,† *n.* A spy; a scout.

SPI'GATE, *a.* [L. *spicatus*, from *spica*, a spike.] Having a spike or ear, eared like corn.

SPI'GA VIRGINIS, *n.* A star of the first magnitude in the constellation Virgo.

SPICCA'TO, [It. divided.] In *music*, a term which indicates that every note is to have its *distinct sound*; and in regard to instruments played with a bow, it denotes that every note is to have a distinct bow.

SPICE, *n.* [Fr. *epice*; It. *spezie*; Sp. *especia*.] 1. A vegetable production, fragrant or aromatic to the smell, and pungent to the taste; such as pepper, nutmeg, ginger, cinnamon, and cloves, used in sauces and in cookery.—2. A small quantity, giving a seasoning to a greater; something that enriches or alters the quality of a thing in a small degree, as spice alters the taste of a thing.—3. A sample. [Fr. *espèce*.]

SPICE, *v. t.* To season with spice; to season; to mix aromatic substances with; as, to *spice* wine.—2. To tincture; as, the *spiced* Indian air.—3. To render nice; to season with scruples.

SPICED, *pp.* Seasoned with spice.

SPICER, *n.* One that seasons with spice.—2. One who deals in spice.

SPICERY, *n.* [Fr. *epicerie*.] 1. Spices in general; fragrant and aromatic vegetable substances used in seasoning.—2. A repository of spices.

SPICE-WOOD, *n.* The *Laurus benzoin*, an American shrub, the wild-allspice, or benjamin tree.

SPI'GINESS, *n.* Quality of being spicely.

SPICING, *pp.* Seasoning with spice.

SPICK and SPAN, bright; shining; as, a garment *spick and span* new, or *spannew*. *Spick* is from the root of the It. *spicco*, brightness; *spicare*, to shine; *spiccar le parole*, to *speak* distinctly; *spicciare*, to rush out, the radical sense of which is to shoot or dart. *Span* is probably from the root of *spangle*, Gr. *σπίγγα*, G. *spiegel*, a mirror.

SPICK'NEL. See SPIGNEL.

SPI'COSTY,† *n.* [L. *spica*.] The state of having or being full of ears, like corn.

SPI'CLULAR, *a.* [L. *spiculum*, a dart.] Resembling a dart; having sharp points.

**SPIGULATE**, *v. t.* [*L. spiculo*, to sharpen, from *spiculum*, a dart, from *spica*, or its root. *See SPIKE*.] To sharpen to a point.

**SPIGULE**, *n.* [*L. spicula*.] In *bot.*, a spikelet.

**SPI'CY**, *a.* [from *spice*.] Producing spicy; abounding with spices; as, the *spicy* shore of Arabia.—2. Having the qualities of spice; fragrant; aromatic; as, *spicy* plants.

Led by new stars and borne by *spicy* gales.  
Pope.

3. Showy; handsome; neat; as, a *spicy* garment. [*Vulgar*.]

**SPIDER**, *n.* [*D. spinne*; *Ger. spume*; *Sw. spindel*; *Dan.* and *Ger. spinner*; *Sw. spinna*; *Sax. spinnan*, to spin.] 1. The common name of the animals of the family Araneides, of the class Arachnida, some of which are remarkable for spinning webs for taking their prey and forming a convenient habitation, and for the deposit of their food. The abdomen of the spider is furnished with from four to six cylindrical or conical, articulated mammilla, with fleshy extremities, which are perforated with numberless small orifices for the passage of silky filaments of extreme tenuity, with which they form their webs, and which proceed from internal reservoirs. Their mandibles are terminated by a movable hook, flexed inferiorly, underneath which, and near its extremity, which is always pointed, is a little opening, that allows a passage to a venomous fluid contained in a gland of the preceding joint. After wounding their prey with their hooked mandibles, they inject this poison into the wound, which suddenly destroys the victim. A very great diversity exists in the modes in which spiders construct their webs, and in the situations in which they are placed. Some spiders are sedentary, and catch their prey by entangling them in their webs; others roam abroad in search of their prey.

The *spider's* touch, how exquisitely fine!

Pope.

2. A kitchen utensil, somewhat resembling a spider.—3. A trevet to support vessels over a fire.

**SPIDERLIKE**, *a.* Resembling a spider.  
**SPIDER ORCHIS**, *n.* The common name of two British species of Ophrys, the *O. arachnites*, late spider orchis, and *O. aranifera*, early spider orchis. [*See OPHRYS*.]

**SPIDERWORT**, *n.* A British perennial plant of the genus Anthericum, the *A. serotinum*, mountain spiderwort. It grows on some of the highest Welsh mountains.

**SPIGE'LIA**, *n.* Worm-seed, a genus of plants, nat. order Spigeliaceae. It consists of annual and perennial herbs and under shrubs, with opposite leaves and rose-coloured or purple flowers. They are natives of North and South America. The root of *S. marylandica*, is used in America as a vermifuge; and if administered in large doses, it acts powerfully as a cathartic. *S. anthelmia* possesses powerful narcotic properties, and is used in the same manner as the last.

**SPIGELIA'CEÆ**, *n.* A nat. order of plants belonging to the monopetalous subclass of Exogens. There are only two genera, Spigelia and Canala, both natives of America.

**SPIG'NEL**, *n.* A British plant of the

genus *meum*, the *M. athamanticum*. [*See MEUM*.]

**SPIG'OT**, *n.* [*W. yspigawd*, from *yspig*, *Eng. spike*; from *pig*, *Eng. piike*; *Dan. spiger*; a nail. *See SPIKE* and *PIKE*.] A pin or peg used to stop a faucet, or to stop a small hole in a cask of liquor.

**SPIKE**, *n.* [*W. yspig*, *supra*; *D. spyh*, *spyher*; *G. speiche*; *Dan. spiger*, *Sv. spik*, a nail; *L. spica*, an ear of corn. It signifies a shoot or point. *See PIKE*.] 1. A large nail or pin, generally of iron, but sometimes of wood; a piece of pointed iron like a long nail, inserted with the point outwards, as on the top of walls, gates, &c., to prevent people from passing over them; a nail or instrument, with which the vents of cannon are filled up.—2. An ear of corn or grain.—3. A shoot.—4. [*L. spica*.] In *bot.*, a species of inflorescence, in which sessile flowers are alternate on a common simple peduncle, as in wheat, rye, lavender, &c.

**SPIKE**, *n.* A species of lavender, *Lavandula spica*.

**SPIKE**, *v. t.* To fasten with spikes or long and large nails; as, to *spike* down the planks of a floor or bridge.—2. To set with spikes.

A youth leaping over the *spiked* pales .. was caught by the spikes. [*Unusual*.]

Wiseman.

3. To stop the vent with spikes.—*To spike a gun or cannon*, is to fill up the touch-hole by driving a nail or spike forcibly into it, in order to render it unserviceable.—*To spike up the ordnance*, is a sea phrase for fastening a quin with spikes to the deck, close to the breech of a gun carriage, so that the gun may keep firmly and closely to the sides of the ship, when she rolls.

**SPIKED**, *pp.* Furnished with spikes, as corn; spicate; fastened with spikes; stopped with spikes.

**SPIKELET**, *n.* In *bot.*, a small spike making a part of a large one; or a subdivision of a spike, as, the *spikelets* of grasses.

**SPIKENARD**, *n.* (*spik'nard*.) [*L. spica nardi*.] 1. A highly aromatic plant growing in the East Indies, the *Nardostachys jatamansi* of Decandolle, nat. order Valerianaceae. The fruit has a strong smell and a sharp bitterish taste. This is the true spikenard of the ancients, and it has enjoyed celebrity from the earliest period, on account of the valuable extract or perfume obtained from its roots, which was used at the ancient baths and at feasts. It is called *jatamansi* or *balchar* by the Hindoos, and *sunbul* by the Arabians. Differences of opinion exist respecting the nature of the fragrance of the *jatamansi*. It is, however, highly esteemed in the East as a perfume, and is used to scent oils and unguents. [*See NARD*.] The name spikenard is applied to various other plants; as to *valeriana celtica*; *andropogon nardus*, *lavendula spica*, *asarum Europaeum*, &c. In the United States, it is applied to *araliaracemosa*.—2. A name of various fragrant essential oils.

**SPIKE-RUSH**, *n.* The common name of several British plants of the genus *Eleocharis*. [*See ELEOCHARIS*.]

**SPIKING**, *ppr.* Fastening with spikes; stopping with large nails.

**SPIKE**, *a.* Having a sharp point.

**SPILL**, *n.* [*Dan. spil*, a pivot, a spindle; *G. spille*; *Ir. spile*; *Scot. spyle*.] 1. A small shiver of wood, or a small peg or pin for stopping a cask; as, a vent hole

stopped with a *spill*.—2. A little bar or pin of iron.—3.† A little sum of money.

**SPILL**, *v. t.* *pret.* *Spilled* or *Spilt*; *pp. id.* [*Sax. spellan*; *D.* and *G. spillen*.] 1. To suffer to fall or run out of a vessel; to lose or suffer to be scattered; applied only to fluids and to substances whose particles are small and loose. Thus we *spill* water from a pail; we *spill* spirit or oil from a bottle; we *spill* quicksilver or powders from a vessel or a paper; we *spill* sand or flour. *Spill* differs from *pour* in expressing accidental loss; a loss or waste not designed, or contrary to purpose.—2. To suffer to be shed; as, a man *spills* his own blood.—3. To cause to flow out or lose; to shed; as, a man *spills* another's blood. [This is applied to cases of murder or other homicide, but not to venesection. In the latter case we say, to *let* or *take* blood.]

And to revenge his blood so justly *spilt*.  
Dryden.

4. To injure; to destroy; as, to *spill* the mind or soul; to *spill* glory; to *spill* forms, &c. [*This application is obsolete and now improper*.]—5. To throw away.—6. In *seamen's* lan., to discharge the wind out of the cavity or belly of a sail, in order to furl or reef it.

**SPILL**, *† v. i.* To waste; to be prodigal.—2. To be shed; to be suffered to fall, be lost, or wasted.

He was so topfull of himself, that he let it *spill* on all the company. *Watts*.

**SPILLED**, *pp.* Suffered to fall, as liquids; shed.

**SPILLER**, *n.* One that spills or sheds.—2. A kind of fishing-line.

**SPILLING**, *ppr.* Suffering to fall or run out, as liquids; shedding.—*Spilling-lines*, in a *ship*, are certain ropes, fixed occasionally to the main and fore-sails of a ship, in tempestuous weather, for reefing or furling them more conveniently.

**SPILL'WATER**, *n.* An excavation made outside the embankment of a river, to receive the water that overflows when the river is flooded, and prevent it from flooding the adjacent grounds.

**SPLIT**, *pret.* and *pp.* of *Spill*.

**SPLITTH**, *† n.* [from *spill*.] Any thing split.

**SPIN**, *v. t.* *pret.* and *pp.* *Spun*. *Spin* is not used. [*Sax. spinnan*; *D.* and *G. spinnen*. If the sense is to draw out or extend, this coincides in origin with *span*.] 1. To draw out and twist into threads, either by the hand or machinery; as, to *spin* wool, cotton, or flax; to *spin* goats' hair.

All the yarn which Penelope *spun* in Ulysses' absence, did but fill Ithaca with moths. *Shak*.

2. To draw out tediously; to form by a slow process or by degrees; with *out*; as, to *spin out* large volumes on a subject.—3. To extend to a great length; as, to *spin out* a subject.—4. To draw out; to protract; to spend by delays; as, to *spin out* the day in idleness.

By one delay after another, they *spin out* their whole lives. *L'Estrange*.

5. To whirl with a thread; to turn or cause to whirl; as, to *spin* a top.—6. To draw out from the stomach in a filament; as, a spider *spins* a web.—*To spin hay*, in *milit. lan.*, is to twist it into ropes for convenient carriage on an expedition.

**SPIN**, *v. i.* To practice spinning; to work at drawing and twisting threads; as, the woman knows how to *spin*. They neither know to *spin* nor care to toil.

*Prior.*

2. To perform the act of drawing and twisting threads; as, a machine or mule *spins* with great exactness.—

3. To move round rapidly; to whirl; as a top or a spindle.—4. † To stream or issue in a thread or small current; as, blood *spins* from a vein.

**SPINA**, *n. plur.* *Spinæ*, [L.] A thorn; a prickle; a spine.

**SPINA'CEOUS**, *a.* Relating to spinach, or the class of plants to which it belongs.

**SPIN'ACH**, } *n.* [L. *spinacia*; It. *spin*  
**SPIN'AGE**, } *naces*; Fr. *épinards*; G.  
*spinat*; Pers. *spanach*.] Spinacia, a genus of plants, nat. order Chenopodiaceæ. There are only two species, one of which, *S. oleracea*, or common spinach, is well known on account of its use in the kitchen. It is eaten sometimes in salads, but more frequently cooked in various ways. It is a wholesome and agreeable aliment, but contains little nutriment. There are two principal varieties cultivated in gardens, the prickly-fruited and the smooth-fruited.

**SPINAL**, *a.* [See **SPINE**.] Pertaining to the spine or back bone of an animal; as, the *spinal* cord; *spinal* muscles; *spinal* arteries. The spinal cord, or spinal marrow, is a continuation of the *medulla oblongata*. It begins directly behind the origin of the ninth pair of nerves, and obtains its name from being contained in the osseous canal of the spine. It gives rise on each side to a number of nerves, being the origin of most of the nerves of the trunk of the body. The arteries of the spinal cord consist of anterior and posterior spinal arteries, and of many additional branches communicating with others from the adjacent vessels.

**SPINDLE**, *n.* [from *spin*; Sax. and Dan. *spindel*.] 1. The pin used in spinning wheels for twisting the thread, and on which the thread, when twisted, is wound.—2. Any slender pointed rod or pin which turns round, or on which any thing turns; as, the *spindle* of a vane.—3. The fusee of a watch.—4. A long slender stalk.—5. In *geom.*, a solid body generated by the revolution of some curve about its base or double ordinate, in opposition to a conoid, which is generated by the rotation of the curve about its axis, or abscissa, perpendicular to its ordinate. The spindle is denominated *circular*, *elliptic*, *hyperbolic*, or *parabolic*, according to the figure of its generating curve.—6. In *mech.*, a term synonymous with axis. In machinery, where several axes occur, it is usual to denominate the subordinate or smaller axes spindles.—7. In *mast-making*, the upper main piece of a made mast.—*Spindle of a capstan*, the smallest part of a ship's capstan, which is between the two decks.—*Spindle of a vane*, a sort of iron pin tapering at the upper end to a point. It is fixed into the upper end of the top-gallant-mast, so as to carry a vane, which, by turning on it, indicates the direction of the wind.

**SPINDLE**, *v. i.* To shoot or grow in a long slender stalk or body.

**SPINDLE**, *n.* In *manufactures*, a quantity of thread, yarn, or silk, put up

together after it is taken off the reel. It contains 18 hanks of 7 skeins each. The skein contains 80 threads of 54 inches. [The Scotch word is *spynle*.]

**SPINDLE-LEGS**, } *n.* A tall slen-  
**SPINDLE-SHANKS**, } der person;  
*in contempt.*

**SPINDLE-SHANK'ED**, *a.* Having long slender legs.

**SPINDLE-SHAP'ED**, *a.* Having the shape of a spindle; fusiform.

**SPINDLE-TREE**, *n.* A plant of the genus *Euonymus*, the *E. Europæus*. [See **EUONYMUS**.]

**SPINDLE-WORM**, *n.* The caterpillar of a lepidopterous insect, which injures maize plants. [American.]

**SPIND'LING**, *ppr.* or *a.* Tall and slender; shooting into a thin tall stalk.

**SPINE**, *n.* [L. and It. *spina*; Fr. *épine*; W. *yspin*, from *pin*.] 1. The back bone of a vertebrated animal, so called from the thorn-like processes of the vertebrae. In reference to man, it is the articulated bony column, reaching from the head down the back to the

*os sacrum*, being the series or assemblage of vertebrae which sustains the rest of the body, contains the spinal marrow, and to which the ribs are connected. [See **VERTEBRÆ**.]—2. The shin of the leg.—3. A thorn; a sharp process from the woody part of a plant. It differs from a prickle, which proceeds from the bark. A *spine* sometimes terminates a branch, and sometimes is axillary, growing at the angle formed by the branch or leaf with the stem. The wild apple and pear are armed with *spines*; the rose, bramble, gooseberry, &c., are armed with prickles.—4. In *zool.*, a thin, pointed spike, as in fishes.—5. Sometimes a *ridge*.

**SPINEL**, } *n.* [It. *spinella*.] A sub-  
**SPINELLE'**, } species of corundum, which occurs in regular crystals, and sometimes in rounded grains. Its colours are red, black, blue, green, brown, yellow, and white. Its colouring matter is sometimes oxide of chromium, but generally oxide of iron. It usually contains from 80 to 84 per cent. of alumina, and from 8 to 10 of magnesia. It is also termed *spinel ruby*, *balas ruby*, and *ceylanite*. It is found in the beds of rivers, in Ceylon and Siam, and imbedded in carbonate of lime in North America and Sweden.

**SPINEL'ANE**, *n.* A mineral occurring in small crystalline masses and in minute crystals. It is a dodecahedral variety of Zeolite, of a bluish or brownish colour, found near Andernach, on the Rhine.

**SPINES'CENT**, *a.* [from *spine*.] Becoming hard and thorny.

**SPIN'ET**, *n.* [It. *spinetta*; Fr. *épinette*; Sp. *espineta*.] An instrument of music resembling a harpsichord, but smaller; a virginal; a clavichord. It is now entirely superseded by the piano-forte.

**SPIN'ET**, † *n.* [L. *spinetum*.] A small wood or place where briars and thorns grow.

**SPINIF'EROUS**, *a.* [L. *spina*, spine, and *fero*, to bear.] Producing spines; bearing thorns.

**SPIN'IFORM**, *a.* [L. *spina*, and *forma*, form.] Having the form of a spine, or thorn.

**SPINK**, *n.* A trivial name given to the chaffinch.

**SPINNER**, *n.* One that spins; one skilled in spinning.—2. A spider; especially the garden spider with long jointed legs.

**SPIN'NERS**, or **SPIN'NERETS**, *n.*

The organs with which insects form their silk or webs; as the silk-worm and spider.

**SPIN'NERY**, *n.* A place where fibrous substances, or other staples, are spun; as, a flax, silk, or cotton *spinnery*.

**SPIN'NING**, *ppr.* Drawing out and twisting into threads; drawing out; delaying.

**SPIN'NING**, *n.* The act, practice, or art of drawing out and twisting into threads, as wool, flax, cotton, &c.

When the fibres of cotton, wool, flax, &c., are intended to be woven, they are reduced to threads of uniform size, more or less fine, by the well-known process of spinning. The primitive modes of spinning by the spindle and distaff, and by the spinning wheel, only enable the spinner to produce a single thread, or at the utmost, two threads, at once; but with the almost automatic spinning machinery, which in modern times has been called into existence by the cotton manufacture, one individual may produce nearly two thousand threads at the same time.—2. The act or practice of forming webs, as spiders.

**SPIN'NING-JENNY**, *n.* An engine or complicated machine for spinning wool or cotton, in the manufacture of cloth, in which many spindles are turned by a horizontal wheel. It was invented about 1767 by James Hargreaves, a weaver in Lancashire. It was long ago superseded by the *mule*, a machine which combines the principles of the jenny and water-frame.

**SPIN'NING-WHEEL**, *n.* A wheel for spinning wool, cotton, or flax into threads by the hand. Before the introduction of machinery for spinning, there were two kinds of spinning wheels in common use; the *large wheel*, for spinning wool and cotton, and the *small* or *Saxon wheel*, for spinning flax.

**SPIN'NOSE**, *a.* Spinous.

**SPINOS'ITY**, *n.* The state of being spiny or thorny; crabbedness.

**SPIN'NOUS**, *a.* [L. *spinosus*, from *spina*.] Full of spines; armed with thorns; thorny, as a plant. *Spinous leaf*, a leaf having its margin beset with spines, as in thistles.—2. In *anat.*, applied to certain processes of bones.

**SPIN'NOZISM**, *n.* The peculiar atheism, or rather pantheism, of Benedict Spinoza, a Dutch Jew; who maintained that God is not only the *maker*, but also the *matter* of the universe; so that creation was only a development of himself by the Deity.

**SPIN'NOZIST**, *n.* A believer in the doctrines of Spinoza.

**SPIN'STER**, *n.* [from *ster*.] A woman who spins, or whose occupation is to spin. Hence,—2. In *law*, the common title by which an unmarried woman, without rank or distinction, is designated in England.

If a gentlewoman is termed a *spinster*, she may abate the writ. *Coke.*

**SPIN'STRY**, *n.* The business of spinning.

**SPIN'THERE**, *n.* A mineral of a greenish grey colour; it is a variety of *sphene*.

**SPIN'ULE**, *n.* A minute spine.

**SPINULES'CENT**, *a.* In *bot.*, having a tendency to produce small spines.

**SPIN'ULOSE**, *a.* In *bot.*, covered with small spines.

**SPIN'Y**, *a.* [from *spine*.] Full of spines;



thorny; as, a *spiny tree*.—2. Perplexed; difficult; troublesome.

**SPIRACLE**, *n.* [L. *spiraculum*, from *spiro*, to breathe.] 1. In *entom.*, spiracles are the breathing pores, or external orifices of the air tubes of insects; also called *stigmata*.—2. Any small external breathing hole or vent, in animals or plants.

**SPIRÆA**, *n.* A genus of plants, nat. order Rosaceæ. The species which are diffused through the temperate parts of the northern hemisphere, consist of small unarmed shrubs or perennial herbs, with white or reddish flowers. Three species are British, and are known by the name of meadow-sweet,—*which see*.

**SPIRAL**, *a.* [It. *spirale*; Fr. *spirale*; from L. *spira*, a spire.] Winding round a fixed point or centre, and continually receding from it, like a watch-spring. [See the noun.]—2. In *common lan.*, winding round a cylinder or other round body and at the same time rising or advancing forward, like a cork-screw. The column in the Place Vendôme, at Paris, is divided by a *spiral* line into compartments. A whirlwind is so named from the *spiral* motion of the air.—3. In *arch. and sculp.*, applied to a curve that ascends winding about a cone or spire, so that every point of it continually approaches the axis. It is thus distinguished from the helix or screw, which winds in the same manner round a cylinder.

**SPIRAL**, *n.* In *geom.*, the name given to a class of curves, distinguished by this property, that they continually recede from a centre or pole, while they continue to revolve about it. The main-spring of a watch gives an idea of this kind of curve. Spirals receive different names from the properties by which they are characterized, or from their inventors; as, the *spiral* of Archimedes; the *logarithmic spiral*; the *loxodromic spiral*; the *parabolic spiral*, &c.—2. In *common lan.*, a helix or curve which winds round a cylinder like a screw.

**SPIRAL-COATED**, *a.* Coated spirally.

**SPIRALLY**, *adv.* In a spiral form or direction; in the manner of a screw.

**SPIRAL-PUMP**, *n.* The Archimedes' water-screw. [See ARCHIMEDES' SCREW.]

**SPIRAL-VESSELS**, *n.* In *plants*, fine transparent membranous tubes, with one or more spiral fibres coiled up in their interior. They are generally present among the other vessels of plants, and in trees are found chiefly in the medullary sheath surrounding the pith. The fibre coils either from right to left, or the reverse, somewhat in the manner of a cork-screw. The fibre may be single or double, or it may be composed of numerous threads up to 25. These vessels are extremely delicate, their diameter averaging the 1000th of an inch. Their function is that of the conveyance of air. They are very seldom found in the root or bark of wood, but are frequently abundant in the other parts, especially in the leaves and flowers. They are easily discovered on breaking asunder the leaves and stalks of many plants, when the fibres may be unrolled, and present themselves as delicate filaments, like those of spiders.

**SPIRAL-WHEELS**, *n.* In *mill work*, a species of gearing much used in the

textile manufactures. Spiral wheels serve the same purpose as bevel wheels, and are better adapted for light machinery. The teeth are formed upon the circumference of cylinders of the required diameter, at an angle of 45° with their respective axes, when the direction of the motion is to be changed from the horizontal to the vertical. By this construction the teeth become in fact small portions of screws or spirals winding round the cylinders, whence the name.

**SPIRATION**, *† n.* [L. *spiratio*.] A breathing.

**SPIRE**, *n.* [L. *spira*; Gr. *σπιρα*: Sp. *espira*; from the root of L. *spiro*, to breathe. The primary sense of the root is to throw, to drive, to send, but it implies a winding motion, like *throw*, *warp*, and many others.] 1. A winding line like the threads of a screw; a spiral; any thing wreathed or contorted; a curl; a twist; a wreath.

His neck erect amidst his circling spires. *Milton.*

A dragon's fiery form belled the god;  
Sublime on radiant spires he rode.

*Dryden.*

2. A body that shoots up to a point; a tapering body; a conical or pyramidal body; the tapering portion of a steeple rising above the tower; a steeple.

With glist'ring spires and pinnacles adorn'd. *Milton.*

In *arch.*, the pyramidal or conical termination of a tower or turret. The earliest spires were merely pyramidal or conical roofs, specimens of which still exist in Norman buildings, as that of the tower of Than church in Normandy. These roofs, becoming gradually elongated, and more and more acute, resulted at length in the elegant tapering spire; among the many existing examples of which, probably, that of Salisbury is the finest. The spires of mediæval architecture, to which alone they are appropriate, are generally square, octagonal, or circular in plan; they are sometimes solid, more frequently hollow, and are variously ornamented with bands encircling them, with panels more or less enriched, and with spire lights, which are of infinite variety. Their angles are sometimes crocketed, and they are almost invariably terminated by a finial. In the later styles the general pyramidal outline is obtained by diminishing the diameter of the building in successive stages, and this has been imitated in modern spires, in which the forms and details of classic architecture have been applied to structures essentially mediæval. The term spire is sometimes restricted to signify such tapering buildings, crowning towers or turrets, as have parapets at their base. When the spire rises from the exterior of the wall of the tower without the intervention of a parapet, it is called a *broach*.—3. A stalk or blade of grass or other plant. How humble ought man to be, who cannot make a single spire of grass!—4. The top or uppermost point of a thing.

**SPIRE**, *v. i.* To shoot; to shoot up

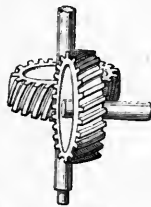

Spiral Wheels.

pyramidically.—2.† To breathe.—3. To sprout, as grain in malting.

**SPIRED**, *a.* Having a spire.

**SPIRE-LIGHTS**, *n.* The windows of a spire.

**SPIRIFER**, *n.* [L. *spira*, a spire, and *fero*, to bear.] The name of an extinct genus of molluscs, having a shell with two internal, calcareous, spiral appendages.

**SPIRIT**, *n.* [Fr. *esprit*; L. *spiritus*, from *spiro*, to breathe, to blow. The primary sense is to rush or drive.] 1. Primarily, wind; air in motion; hence, breath.

All bodies have spirits and pneumatical parts within them. *Bacon.*

[This sense is now unusual.]—2. Animal excitement, or the effect of it; life; ardour; fire; courage; elevation or vehemence of mind. The troops attacked the enemy with great spirit. The young man has the spirit of youth. He speaks or acts with spirit. *Spirits*, in the plural, is used in nearly a like sense. The troops began to recover their spirits.—3. Vigour of intellect; genius.

His wit, his beauty, and his spirit. *Butler.*

The noblest spirit or genius cannot deserve enough of mankind to pretend to the esteem of heroic virtue. *Temple.*

4. Temper; disposition of mind, habitual or temporary; as, a man of a generous spirit, or of a revengeful spirit; the ornament of a meek and quiet spirit.

Let us go to the house of God in the spirit of prayer. *Bickersteth.*

5. The soul of man; the intelligent, immaterial, and immortal part of human beings. [See SOUL.]

The spirit shall return to God that gave it; Eccles. xii.

6. An immaterial intelligent substance. Spirit is a substance in which thinking, knowing, doubting, and a power of moving do subsist. *Locke.*

Hence,—7. An immaterial intelligent being.

By which he went and preached to the spirits in prison; 1 Pet. iii.

God is a spirit; John iv.

8. Turn of mind; temper; occasional state of the mind.

A perfect judge will read each work of wit, With the same spirit that its author writ. *Pope.*

9. Powers of mind distinct from the body.

In spirit perhaps he also saw

Rich Mexico, the seat of Montezum. *Milton.*

10. Sentiment; perception. Your spirit is too true, your fears too certain. *Shak.*

11. Eager desire; disposition of mind excited and directed to a particular object.

God has made a spirit of building succeed a spirit of pulling down. *South.*

12. A person of activity; a man of life, vigour, or enterprise.

The watery kingdom is no bar To stop the foreign spirits, but they come. *Shak.*

13. Persons distinguished by qualities of the mind.

Such spirits as he desired to please, such would I choose for my judges. *Dryden.*

14. Excitement of mind; animation; cheerfulness; usually in the plural. We found our friend in very good spirits. He has a great flow of spirits.

To sing thy praise, would heaven my breath prolong,

Infusing spirits worthy such a song. *Dryden.*

15. Life or strength of resemblance; essential qualities; as, to set off the face in its true *spirit*. The copy has not the *spirit* of the original.—16. Something eminently pure and refined.

Nor doth the eye itself,

That most pure *spirit* of sense, behold  
itself. *Shak.*

17. Among the older chemists, a name given to most substances capable of being vaporized, and condensed by distillation, and to some not obtained by distillation. Three principal kinds were distinguished; *inflammable* or *ardent spirits*, *acid spirits*, and *alkaline spirits*. Modern chemists, however, confine the word, especially when employed by itself, almost exclusively to the spirit of wine or alcohol.—18. In *commercial lan.*, a strong, pungent liquor, usually obtained by distillation, as rum, brandy, gin, whisky. [See SPIRITS.]—19. An apparition; a ghost.—20. The renewed nature of man; *Matt. xxvi.*; *Gal. v.*—21. The influences of the Holy Spirit; *Matt. xxii.*—*Holy Spirit*, the third person in the Trinity. SPIR'IT, *v. t.* To animate; to actuate; as a spirit.

So talk'd the *spirited* sly snake. [*Little used.*]  
*Milton.*

2. To animate with vigour; to excite; to encourage; as, civil dissensions *spirit* the ambition of private men. It is sometimes followed by *up*; as, to *spirit up*.—3. To kidnap.—*To spirit away*, to entice or seduce.

SPIR'ITALLY, *adv.* By means of the breath.

SPIR'ITED, *pp.* Animated; encouraged; incited.—2. *a.* Animated; full of life; lively; full of spirit or fire; as, a *spirited* address or oration; a *spirited* answer. It is used in composition, noting the state of the mind; as, in high-*spirited* low-*spirited*, mean-*spirited*.

SPIR'ITEDLY, *adv.* In a lively manner; with spirit; with strength; with animation.

SPIR'ITEDNESS, *n.* Life; animation; —2. Disposition or make of mind. Used in compounds; as high-*spiritedness*, low-*spiritedness*, mean-*spiritedness*, narrow-*spiritedness*.

SPIR'ITFUL, *adj.* Lively; full of spirit. SPIR'ITFULLY, *adv.* In a lively manner.

SPIR'ITFULNESS, *n.* Liveliness; sprightliness.

SPIR'ITING, *ppr.* Animating; actuating.

SPIR'IT-LAMP, *n.* A lamp in which alcohol is used instead of oil.

SPIR'ITLESS, *a.* Destitute of spirits; wanting animation; wanting cheerfulness; dejected; depressed.—2. Destitute of vigour; wanting life, courage, or fire; as, a *spiritless* slave.

A man so faint, so *spiritless*,

So dull, so dead in look. *Shak.*

3. Having no breath; extinct; dead. SPIR'ITLESSLY, *adv.* Without spirit; without exertion.

SPIR'ITLESSNESS, *n.* Dulness; want of life or vigour.

SPIR'IT-LEVEL, *n.* An instrument employed for determining a line or plane parallel to the horizon, and also the relative heights of ground at two or more stations. It consists of a tube of glass nearly filled with spirit of wine or distilled water, and hermetically sealed at both ends; so that when held with its axis in a horizontal position, the bubble of air which occupies

the part not filled with the liquid rises to the upper surface and stands exactly in the middle of the tube. The tube is placed within a brass or wooden case, having a long opening on the side which is to be uppermost, so that the position of the air-bubble may be readily seen. When the instrument thus prepared is laid on a horizontal surface, the air-bubble stands in the very middle of the tube; when the surface slopes, the bubble rises to the higher end. It is used by carpenters and joiners for ascertaining whether the upper surface of any work be horizontal. When employed in surveying, it is attached to a telescope, the telescope and tube being fitted to a frame or cradle of brass, which is supported on three legs.

SPIR'IT OF SALT. An old name for hydrochloric acid.

SPIR'IT OF WINE. Alcohol,—*which see.*

SPIR'ITO'SO, or CON SPIR'ITO. [It. with spirit.] In *music*, a term denoting that the movement to which it is prefixed is to be performed in a spirited manner.

SPIR'ITOUS, *a.* Like spirit; refined; defecated; pure.

More refined, more *spiritous* and pure.

*Milton.*

2. Fine; ardent; active.

SPIR'ITOUSNESS, *n.* A refined state; fineness and activity of parts; as, the thinness and *spiritousness* of liquor.

SPIR'IT-PIERCING, *a.* Piercing the spirit.

SPIR'ITS, *n.* In *commercial lan.*, all inflammable liquors obtained by distillation, as brandy, rum, geneva, whisky, gin, &c. The spirits chiefly manufactured in Britain are gin and whisky. The manufacture of spirits is placed under the supervision of the excise, and a very large revenue is obtained from it. The quantity of spirits consumed yearly in the United Kingdom may be estimated at from 25 to 30 millions of gallons.

SPIR'IT-SEARCHING, *a.* Searching the spirit.

SPIR'IT-STIRRING, } *a.* Exciting the  
SPIR'IT-ROUSING, } spirit.

SPIR'ITUAL, *a.* [Fr. *spirituel*; L. *spiritualis*.] 1. Consisting of spirit; not material; existing imperceptibly to the organs of sense; incorporeal; as, a *spiritual* substance or being. The soul of man is *spiritual*.—2. Mental; intellectual; as, *spiritual* armour.—3. Not gross; refined from external things; not sensual; relating to mind only; as, a *spiritual* and refined religion.—4. Not lay or temporal; relating to sacred things; ecclesiastical; as, the *spiritual* functions of the clergy; the lords *spiritual* and temporal; a *spiritual* corporation.—5. Pertaining to spirit or to the affections; pure; holy.

God's law is *spiritual*; it is a transcript of the divine nature, and extends its authority to the acts of the soul of man. *Brown.*

6. Pertaining to the renewed nature of man; as, *spiritual* life.—7. Not fleshly; not material; as, *spiritual* sacrifices; 1 Pet. ii.—8. Pertaining to divine things; as, *spiritual* songs; Eph. v.—*Spiritual courts*, courts having jurisdiction over matters appertaining or annexed to ecclesiastical affairs; such as the *probate of wills*; *suits for braulding or smiting in a church or churchyard*; *slander imputing in-*

*continnce*, as well as the offence itself; *the validity of marriages*; *the restitution of conjugal rights*; *subtraction of tithes*; and some others which are termed *spiritual causes*, though not strictly so.

SPIR'ITUALISM, *n.* The doctrine of the existence of spirits, as distinct from matter. *Spiritualism*, as distinguished from *materialism*, is that system according to which all that is real is spirit, soul, or self; that which is called matter, or the external world, being either a succession of notions impressed on the mind, by the Deity, or else a mere notion of the mind itself.—2. State of being spiritual.

SPIR'ITUALIST, *n.* One who professes a regard for spiritual things only; one whose employment is spiritual.—2. One who admits the reality of an intelligent being, distinct from the perceptible universe; one who maintains that all which is real is spirit. [See SPIRITUALISM.]

SPIR'ITUALITY, *n.* Essence distinct from matter; immateriality.

If this light be not spiritual, it approacheth nearest to *spirituality*. *Raleigh.*

2. Intellectual nature; as, the *spirituality* of the soul.—3. Spiritual nature; the quality which respects the spirit or affections of the heart only, and the essence of true religion; as, the *spirituality* of God's law.—4. Spiritual exercises and holy affections.

Much of our *spirituality* and comfort in public worship depend on the state of mind in which we come. *Bickersteth.*

5. That which belongs to the church, or to a person as an ecclesiastic, or to religion; as distinct from temporalities.

During the vacancy of a see, the archbishop is guardian of the *spiritualities* thereof. *Blackstone.*

6. *an ecclesiastical body.*

SPIR'ITUALIZATION, *n.* The act of spiritualizing. Among the older chemists, the operation of extracting spirit from natural bodies.

SPIR'ITUALIZE, *v. i.* [Fr. *spiritualiser*, to extract spirit from mixed bodies.] 1. To refine the intellect; to purify from the feculences of the world; as, to *spiritualize* the soul.—2. Among the older chemists, to extract spirit from natural bodies, to raise by distillation.—3. To convert to a spiritual meaning.

SPIR'ITUALIZER, *n.* One who spiritualizes.

SPIR'ITUALLY, *adv.* Without corporeal grossness or sensuality; in a manner conformed to the spirit of true religion; with purity of spirit or heart. *Spiritually minded*, under the influence of the Holy Spirit or of holy principles; having the affections refined and elevated above sensual objects, and placed on God and his law; Rom. viii.—*Spiritually discerned*, known, not by carnal reason, but by the peculiar illumination of the Holy Spirit; 1 Cor. ii.

SPIR'ITUAL MIND'EDNESS, *n.* The state of having spiritual exercises and holy affections; spirituality.

SPIR'ITUALITY, *n.* Ecclesiastics.

SPIR'ITUOSITY, *n.* Spirituousness.

SPIR'ITUOSO, in *music*, with spirit.

SPIR'ITUOUS, *a.* [Fr. *spiritueux*.] 1. Containing spirit; consisting of refined spirit; ardent; as, *spirituous* liquors. [This might well be written *spiritous*.]—2. Having the quality of spirit; fine; pure; active; as, the *spirituous* part of a plant.—3. *adv.* Lively; gay; vivid; airy.

**SPIRITUOUSNESS**, *n.* The quality of being spirituous; ardent; heat; stimulating quality; as, the *spirituousness* of liquors.—2. Life; tenacity; activity.

**SPIRICK'ETING**, *n.* In *ship-building*, the strake wrought on the ends of the beams; or where there are ports, it is the two strakes worked up to the portsills.

**SPIROR'IBIS**, *n.* A genus of shells belonging to the family of the Serpulacea. This little white shell is coiled round into a spiral disc-like form, and is common on the shell of lobsters.

**SPIRT**, *v. t.* [Sw. *spruta*; Dan. *spruder* and *sproyter*, to spout, to squirt, to syringe. The English word has suffered a transposition of letters. It is from the root of *sprout*,—*which see.*] To throw out, as a liquid in a stream; to drive or force out with violence, as a liquid from a pipe or small orifice; as, to *spirt* water from the mouth, or other liquid from a tube.

**SPIRT**, *v. i.* To gush or issue out in a stream, as liquor from a cask; to rush from a confined place in a small stream. Thus the small jet, which hasty hands unlock,

*Spirts* in the gard'ner's eyes who turns the cock, Pope.

**SPIRT**, *n.* A sudden or violent ejection or gushing of a liquid substance from a tube, orifice, or other confined place; a jet.—2. A sudden or short occasion or exigency; sudden effort. [Vulgar.]

**SPIR'TLE**, *v. t.* To spirt in a scattering manner.

**SPIR'TLED**, *pp.* Spirted scatteringly.

**SPIRU'LIDÆ**, *n.* A family of polythalamous, decapodous, dibranchiate cephalopods, of which the genus *Spirula* is the type. Some of the species



1. *Spirula Australis*. 2. The shell shown separately.

of *Spirula* inhabit tropical seas, where they float on the surface of the ocean; others are only found fossil.

**SPIR'ULITE**, *n.* A fossil *Spirula*.

**SPIRY**, *a.* [from *spire*.] Of a spiral form; wreathed; curled; as, the *spiry* volutes of a serpent.—2. Having the form of a pyramid; pyramidal; as, *spiry* turrets.

**SPISS**, *† a.* [L. *spissus*.] Thick; close; dense.

**SPISS'ATED**, *a.* Thickened; rendered close or dense.

**SPISS'ITUDE**, *n.* [supra.] Thickness of soft substances; the denseness or compactness which belongs to substances not perfectly liquid nor perfectly solid; as, the *spissitude* of coagulated blood or of any coagulum.

**SPIIT**, *n.* [Sax. *spitu*; D. *spit*; G. *spies*; Ice. *spiet*, a spear. It is from thrusting, shooting.] 1. An iron prong or bar pointed, on which meat is roasted.—2. Such a depth of earth as is pierced by the spade at once. [D. *spit*, a spade.]—3. In *America*, a small point of land running into the sea, or a long narrow shoal extending from the shore into the sea; as, a *spit* of sand.

**SPIIT**, *v. t.* [from the noun.] To thrust a spit through; to put upon a spit; as, to *spit* a loin of veal.—2. To thrust

through; to pierce.—3. To spade; to dig.

**SPIIT**, *v. t.* pret. and pp. *Spit*. *Spit* is obsolete, and also *spitten*. [Sax. *spit-tan*; G. *spitzen*. The sense is to throw or drive.] 1. To eject from the mouth; to thrust out, as saliva or other matter from the mouth.—2. To eject or throw out with violence.

**SPIIT**, *v. i.* To throw out saliva from the mouth. It is a dirty trick to *spit* on the floor or carpet.

**SPIIT**, *n.* [Dan. *spyt*.] What is ejected from the mouth; saliva.

**SPIIT'AL**, } *† n.* [corrupted from *hos-*  
**SPIIT'ALE**, } *pital*.] A charitable foundation; a place for the reception and entertainment of strangers; for the care of the poor and needy; and for the care and cure of the sick and diseased. [See HOSPITAL.]

**SPIIT'AL-HOUSE**, *† n.* An hospital.

**SPIIT'BOX**, *n.* A vessel to receive discharges of spittle.

**SPIIT'COCK**, *v. t.* To split an eel lengthwise and broil it.

**SPIIT'COCK**, *n.* An eel split and broiled.

**SPIITE**, *n.* [D. *spyt*, spite, vexation; Ir. *spid*. The Fr. has *depit*, Norm. *despite*. The It. *dispetto*, and Sp. *despecho*, seem to be from the L. *despectus*; but *spite* seems to be from a different root.] Hatred; rancour; malice; malignity; malevolence.—*Spite*, however, is not always synonymous with these words. It often denotes a less deliberate and fixed hatred than malice and malignity, and is often a sudden fit of ill will excited by temporary vexation. It is the effect of extreme irritation, and is accompanied with a desire of revenge, or at least a desire to vex the object of ill will.

Be gone, ye critics, and restrain your *spite*, Codrus writes on, and will for ever write.

Pope.

In *spite* of, in opposition to all efforts; in defiance or contempt of. Sometimes *spite* of is used without *in*, but not elegantly. It is often used without expressing any malignity of meaning.

Whom God made use of to speak a word in season, and saved me *in spite* of the world, the devil, and myself. South.

In *spite* of all applications, the patient grew worse every day. Arbuthnot.

To owe one a *spite*, to entertain a temporary hatred for something.

**SPIITE**, *v. t.* To be angry or vexed at. 2. To harm; to vex; to treat maliciously; to thwart.—3. To fill with *spite* or vexation; to offend; to vex.

Darius spited at the Magi, endeavoured to abolish not only their learning but their language.† Temple.

**SPIITED**, *pp.* Hated; vexed.

**SPIITEFUL**, *a.* Filled with *spite*; having a desire to vex, annoy, or injure; malignant; malicious.

A wayward son,

*Spiteful* and wrathful. Shak.

**SPIITEFULLY**, *adv.* With a desire to vex, annoy, or injure; malignantly; maliciously.

**SPIITEFULNESS**, *n.* The desire to vex, annoy, or do mischief, proceeding from irritation; malice; malignity.

It looks more like *spitefulness* and ill nature, than a diligent search after truth. Keil.

**SPIIT'FIRE**, *n.* A violent or passionate and vulgar person. [Familiar.]

**SPIIT'-FULL**, *n.* A spadeful.

**SPIIT'-RACK**, *n.* A rack to hang spits upon.

**SPIIT'ED**, *pp.* [from *spit*.] Put upon a spit.—2. Shot out into length.

**SPIIT'ER**, *n.* One that puts meat on a spit.—2. One who ejects saliva from his mouth.—3. A young deer whose horns begin to shoot or become sharp; a brocket or pricket.

**SPIIT'ING**, *ppr.* Putting on a spit.—2. Ejecting saliva from the mouth.

**SPIIT'LE**, *n.* [from *spit*.] Saliva; the thick moist matter which is secreted by the salivary glands and ejected from the mouth.—2. A small sort of spade. [spaddle.]

**SPIIT'LE**. See SPITAL.

**SPIITTOON**, *n.* A spit-box.

**SPIIT'VENOM**, *n.* [*spit* and *venom*.] Poison ejected from the mouth.

**SPLACH'NUM**, *n.* A genus of cryptogamic plants, nat. order Mosses. The species are generally annual plants, and remarkable amongst their tribe for their size and beauty, as well as singularity. Seven of the species are British. The most common in England is the *S. ampullaceum*, purple gland-moss, found growing chiefly on rotten cow-dung.

**SPLANCH'NIC**, *a.* Belonging to the entrails, as the *splanchnic* nerve.

**SPLANCHNOLOGY**, *n.* [Gr. *σπλάνχνα*, bowels, and *λογία*, discourse.] 1. The doctrine of the viscera; or a treatise or description of the viscera.—2. The doctrine of diseases of the internal parts of the body.

**SPLASH**, *v. t.* [formed on *plash*.] To spatter with water, or with water and mud; to dash a liquid upon or over, especially muddy water or mud.

**SPLASH**, *v. i.* To strike and dash about water, or something liquid.

**SPLASH**, *n.* Water, or water and dirt, thrown upon any thing, or thrown from a puddle and the like.—2. A noise or effect; as from water or mud thrown up or dashed about.

**SPLASH'-BOARD**, *n.* A guard in front of a wheeled vehicle, to prevent its being splashed by mud from the horses' heels.

**SPLASH'ED**, *pp.* Spattered with water or mud.

**SPLASH'ING**, *ppr.* Spattering with water or mud.—2. Striking and dashing about water.

**SPLASHY**, *a.* Full of dirty water; wet; wet and muddy.

**SPLAT'TER**, *v. i.* To make a noise; as, in water.

**SPLAT'TER DASH**, *n.* An uproar; a sputter. [Familiar and local.]

**SPLAY**, *v. t.* [See DISPLAY.] To dislocate or break a horse's shoulder bone.—2. To spread. [Little used.]—3. In *arch.*, to slope; to form with an oblique angle, as the jambs or sides of a window.

**SPLAY**, *n.* In *arch.*, a sloped surface, or a surface which makes an oblique

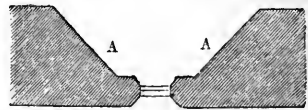

Plan section of Gothic Window.

A, A, the internal Splay.

angle with another; as, when the opening through a wall for a door, window, &c., widens inwards. A large chamfer is called a *splay*.

**SPLAY**, *a.* Displayed; spread; turned outward.

**SPLAYED**, *pp.* Dislocated, as a horse's

shoulder-bone.—2. In *arch.*, a term applied to whatever has one side or surface making an oblique angle with another. Thus the jambs or sides of a window are frequently *splayed*.

**SPLAYFOOT**, } *a.* Having the foot

**SPLAYFOOTED**, } turned outward; having a wide foot.

**SPLAYMOUTH**, *n.* A wide mouth; a mouth stretched by design.

**SPLEEN**, *n.* [*L.* *splen*; *Gr.* *σπλην*.] 1. The milt; a spongy viscus situated in the left hypochondrium, near the fundus of the stomach, between the eleventh and twelfth false ribs. It has an oval figure. Its use is not known. The ancients supposed this to be the seat of melancholy, anger, or vexation, and sometimes of perverse mirth. Hence,—2. Anger; latent spite; ill humour. Thus we say to vent one's *spleen*.

In noble minds some dregs remain,  
Not yet purged off, of *spleen* and sour disdain. *Pope.*

3. A fit of anger.—4. † A fit; a sudden motion.—5. Melancholy; hypochondriacal affections. A fashionable name for what was, in the time of Pope and Addison, also called *vapours*, and which is now by various phrases attributed to the nerves.

Bodies changed to *spleen* forms by *spleen*. *Pope.*

6. † Immoderate merriment.

**SPLÉENED**, *a.* Deprived of the spleen.

**SPLÉENFUL**, } *a.* Angry; peevish;

**SPLÉENISH**, } fretful.

Myself have calmd' thy *spleenful* mutiny. *Shak.*

2. Melancholy; hypochondriacal.

**SPLÉENISH**, *a.* Spleeny; affected with spleen.

**SPLÉENISHLY**, *adv.* In a spleenish manner.

**SPLÉENISHNESS**, *n.* State of being spleenish.

**SPLÉENLESS**, } *a.* Kind; gentle; mild.

**SPLÉENWÖRT**, *n.* [*L.* *splenium*.] The common name of various British cryptogamic plants, genus *Asplenium*, nat. order Polypodiaceæ. These plants were so named because they were supposed to remove disorders of the spleen. They grow upon rocks and old walls.

**SPLÉENY**, *a.* Angry; peevish; fretful. A *spleeny* Lutheran, and not wholesome to our cause. *Shak.*

2. Melancholy; affected with nervous complaints.

**SPLÉG'ET**, *n.* A wet cloth for washing a sore.

**SPLÉNAL'GY**, *n.* [*Gr.* *σπλην*, the spleen, and *αλγος*, pain.] A pain in the spleen or its region.

**SPLÉNDENT**, *a.* [*L.* *splendens*, *splendo*, to shine.] 1. Shining; glossy; beaming with light; as, *splendent* planets; *splendent* metals.—2. Very conspicuous; illustrious.—3. A term applied to minerals as regards their degree of lustre. A mineral is *splendent*, when perceptible in full daylight at a great distance; as, polished metals are.

**SPLÉNDID**, *a.* [*L.* *splendidus*, from *splendo*, to shine; *Fr.* *splendide*; *W.* *ysplan*, from *plan*, clear. See **PLAIN**.] 1. Properly, shining; very bright; as, a *splendid* sun. Hence,—2. Showy; magnificent; sumptuous; pompous; as, a *splendid* palace; a *splendid* procession; a *splendid* equipage; a *splendid* feast or entertainment.—3. Illustrious; heroic; brilliant; as, a *splendid* victory.—4. Illustrious; famous; cele-

brated; as, a *splendid* reputation. [Few words are more abused, in our day, by the vulgar, than this high-sounding epithet. Every thing that is good in its way, is now called *splendid*. We have even heard of "*splendid small beer*!"]

**SPLÉNDIDLY**, *adv.* With great brightness or brilliant light.—2. Magnificently; sumptuously; richly; as, a house *splendidly* furnished.—3. With great pomp or show. The king was *splendidly* attended.

**SPLÉNDID'NESS**, *n.* The quality of being splendid.

**SPLÉNDOUR**, } *n.* [*L.* from the Celtic;

**SPLÉNDOR**, } *W.* *ysplander*, from *pleiniaw*, *dyspleiniaw*, to cast rays, from *plan*, a ray, a scion or shoot, a *plune*; whence *plant*. See **PLANT** and **PLANET**.] 1. Great brightness; brilliant lustre; as, the *splendour* of the sun.—2. Great show of richness and elegance; magnificence; as, the *splendour* of equipage or of royal robes.—3. Pomp; parade; as, the *splendour* of a procession or of ceremonies.—4. Brilliance; eminence; as, the *splendour* of a victory.

**SPLÉNDROUS**, } † *a.* Having splen-

**SPLÉN'DOROUS**, } *dour*.

**SPLÉN'ETIC**, *a.* [*L.* *spleneticus*.] Affected with spleen; peevish; fretful.

You humour me when I am sick;  
Why not when I am *splenetic*? *Pope.*

**SPLÉN'ETIC**, *n.* A person affected with spleen.

**SPLÉN'ETICAL**, *a.* Affected with spleen. [*Little used.*]

**SPLÉN'É**, *a.* [*Fr.* *splenique*.] Belonging to the spleen; as, the *splenic* vein.

**SPLÉN'ISH**, *a.* Affected with spleen; peevish; fretful.

**SPLÉNITIS**, *n.* Inflammation of the spleen.

**SPLÉNITIVE**, } *a.* Hot; fiery; pas-

**SPLÉNITIVE**, } sionate; irritable.

I am not *splenitive* and rash. *Shak.*

**SPLÉN'IUS**, *n.* A flat muscle, situated between the back of the ear and posterior part of the neck.

**SPLÉN'OCELE**, *n.* A hernia of the spleen.

**SPLÉNT**, *n.* A callous substance or insensible swelling of the shank-bone of a horse.—2. A splint. [See **SPLINT**.]

**SPLÉNT COAL**, *n.* An inferior kind of cannel coal found in Scotland.

**SPLÉUGH'AN**, } *n.* [*Gael.*] A tobacco

**SPLÉUGH'AN**, } pouch. [*Scotch.*]

**SPLICE**, *v. t.* [*Sw.* *splissa*; *D.* *splissen*; *G.* *splissen*; *Dan.* *splidsjer*; from *splider*, *splitter*, to split, to divide.] To separate the strands of the two ends of a rope, and unite them by a particular manner of interweaving them; or to unite the

person on board an extra glass of grog, in cases of cold, wet, &c.

**SPLICE**, *n.* The union of ropes by interweaving the strands.

**SPLICED**, *pp.* United, as a rope, by a particular manner of interweaving the two ends. In sailor phrase, to *get spliced*, is to get married. [The term is also used as a cant word by the vulgar.]

**SPLICING**, *ppr.* Separating the strands of two ends of a rope, and uniting them by interweaving.

**SPLICING**, *n.* The process of joining the ends of a rope together, or of uniting the end of a rope to any part thereof by interweaving the strands in a regular manner. The particular kind of splicing depends on the purpose which it is intended to serve. This term is also much used among various classes of artizans, as a general expression for joining or making good any defective work.

**SPLINT**, } *n.* [*D.* *splinter*; *G.* *splint*

**SPLINT'ER**, } or *splitter*; *Dan.* *splint*.  
Qu. is *n* radical? ] 1. A piece of wood split off; a thin piece (in proportion to its thickness,) of wood or other solid substance, rent from the main body; as, *splinters* of a ship's side or mast, rent off by a shot.—2. In *sur.*, a thin piece of wood or other substance, used to hold or confine a broken bone when set, or to maintain any part of the body in a fixed position.—3. A piece of bone rent off in a fracture.—4. Splint; in *vet. surg.*, a hard excrescence growing on the shank-bones of horses; sometimes written *splent*.

**SPLINT**, } *v. t.* To split or rend

**SPLINT'ER**, } into long thin pieces;

**SPLINT'ER**, } to shiver; as, the lightning *splinters* a tree.—2. To confine with splinters, as a broken limb.

**SPLINT'ARMOUR**, *n.* A name given to that kind of armour which is made of several overlapping plates. The French named suits of mail of this kind *ecrevisses*, from their resemblance to the lobster. This kind of armour never came into very general use,

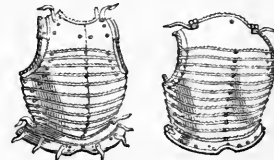

Splint Armour.

because the convexity of the breast-plate would not allow the body to bend, unless the plates were made to overlap upwards, and this rendered them liable to be struck into, and drawn off by the *martel-de-fer* of an antagonist. Mention of splint armour first occurs about the reign of Henry VIII.

**SPLINT'-BONE**, *n.* A name for the *fibula*.

**SPLINT'ER**, *v. i.* To be split or rent into long pieces.

**SPLINT'ER-BAR**, *n.* A cross-bar in a coach which supports the springs.

**SPLINT'ERED**, *pp.* Split into splinters; secured by splints.

**SPLINT'ERING**, *ppr.* Splitting into splinters; securing by splints.

**SPLINT'ER-NETTING**, *n.* Rope-yarn made into nets and nailed upon the inner part of a ship's sides, to lessen the effect of the splinters knocked off by the shot in an engagement.

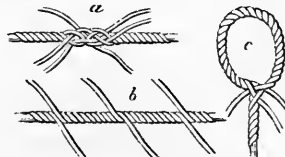

Splices of Ropes.

a, Short Splice; b, Long Splice; c, Eye Splice.

end of a rope to any part of another by a like interweaving of the strands. There are different modes of splicing, as the short splice, long splice, eye splice, &c.—To *splice the main brace*, in seamen's phrase, is to give each

**SPLINT'ERY**, *a.* Consisting of splinters, or resembling splinters.—2. In *mineral*, a term applied to a particular fracture of minerals. The fracture is said to be *splintery*, when the surface produced by breaking a mineral is nearly even, but exhibits little splinters or scales, somewhat thicker at one extremity than the other, and still adhering to the surface by their thicker extremities.

**SPLIT**, *v. t.* pret. and pp. *Split*. [*D. splitten*; *G. splittern* or *spleissen*; *Eth. fult*, to separate, to divide, the same verb which in other Shemitic languages, *Heb. Ch.* and *Syr. פלט, phalat*, signifies to escape. See *SPLIT*.] 1. To divide longitudinally or lengthwise; to separate a thing from end to end by force; to rive; to cleave; as, to *split* a piece of timber; to *split* a board. It differs from *crack*. To *crack* is to open or partially separate; to *split* is to separate entirely.—2. To rend; to tear asunder by violence; to burst; as, to *split* a rock or a sail.

Cold winter *splits* the rocks in twain.

*Dryden.*

3. To divide; to part; as, to *split* a hair. The phrases, to *split* the heart, to *split* a ray of light, are now inelegant and obsolete, especially the former. The phrase, to *split* the earth, is not strictly correct.—4. To dash and break on a rock; as, a ship stranded and *split*.—5. To divide; to break into discord; as, a people *split* into parties.—6. To strain and pain with laughter; as, to *split* the sides.—To *split* a vote. In parliamentary and municipal elections, when a voter divides his vote among the number of candidates to be elected, he is said to *split his vote*; on the other hand, when he gives his vote to one candidate only, he is said to *plump his vote*.—To *split* a sail, to rend it asunder.

**SPLIT**, *v. i.* To burst; to part asunder; to suffer disruption; as, vessels *split* by the freezing of water in them. Glass vessels often *split* when heated too suddenly.—2. To burst with laughter. Each had a gravity would make you *split*.

*Pope.*

3. To be broken; to be dashed to pieces. We were driven upon a rock, and the ship immediately *split*.—To *split* on a rock, to fail; to err fatally; to have the hopes and designs frustrated.—To *split*, in *felons' English*, is to inform against one's accomplices.

**SPLIT-CLOTH**, *n.* In *sur.*, a bandage which consists of a central portion and six or eight tails. It is chiefly used for the head.

**SPLITTER**, *n.* One who splits.

**SPLITTING**, *ppr.* Bursting; riving; rending.

**SPLITTING**, *n.* The act of bursting, rending, or dividing.—*Splitting of votes*, in *electioneering phrase*, the act of dividing votes by the electors, among the number of candidates, when more than one are to be elected.

**SPLORE**, *n.* A frolic; a noise; a riot. [*Scotch.*]

**SPLUTTER**, *n.* A bustle; a stir. [*Familiar.*]

**SPLUTTER**, *v. i.* To speak hastily and confusedly. [*Low.*]

**SPLUTTERER**, *n.* One who splutters.

**SPODUMENE**, *n.* [*Gr. σποδων*, to reduce to ashes.] A mineral, hard, brittle, and translucent, called by *Häuy triphane*. It occurs in laminated masses, easily divisible into prisms with

rhombohedral bases; the lateral faces smooth, shining and pearly; the cross fracture uneven and splintery. Before the blowpipe it exfoliates into little yellowish or grayish scales; whence its name. It is found at Uto in Sweden, in the Tyrol, in Ireland, and North America. It consists of silica and alumina, with 8 to 10 per cent. of lithia, and a little protoxide of iron.

**SPOIL**, *v. t.* [*Fr. spolier*; *L. spolio*; *W. yspeliaw*. The sense is probably to pull asunder, to tear, to strip; coinciding with *L. vello*, or with *peel*, or with both.] 1. To plunder; to strip by violence; to rob; with *of*; as to *spoil* one of his goods or possessions. My sons their old unhappy sire despise, *Spoil'd* of his kingdom, and depriv'd of eyes.

*Pope.*

2. To seize by violence; to take by force; as, to *spoil* one's goods.

This mount

With all his verdure *spoil'd*. *Milton.*

3. [*Sax. spillan*.] To corrupt; to cause to decay and perish. Heat and moisture will soon *spoil* vegetable and animal substances.—4. To corrupt; to viciate; to mar.

Spiritual pride *spoils* many graces.

*Taylor.*

5. To ruin; to destroy. Our crops are sometimes *spoiled* by insects.—6. To render useless by injury; as, to *spoil* paper by wetting it.—7. To injure fatally; as, to *spoil* the eyes by reading.

**SPOIL**, *v. i.* To practise plunder or robbery.

Outlaws, which, lurking in woods, used to break forth to rob and *spoil*. *Spenser.*

2. To decay; to lose the valuable qualities; to be corrupted; as, fruit will soon *spoil* in warm weather. Grain will *spoil*, if gathered when wet or moist.

**SPOIL**, *n.* [*L. spoliium*.] 1. That which is taken from others by violence; particularly in war, the plunder taken from an enemy; pillage; booty.—2. That which is gained by strength or effort.

Each science and each art his *spoil*.

*Bentley.*

3. That which is taken from another without license.

Gentle gales

Fanning their odiferous wings, dispense Native perfumes, and whisper whence they stole

Their balmy *spoils*. *Milton.*

4. The act or practice of plundering; robbery; waste.

The man that hath not music in himself, Nor is not mov'd with concord of sweet sounds,

Is fit for treason, stratagems, and *spoils*.

*Shak.*

5. Corruption; cause of corruption. Villanous company hath been the *spoil* of me.

*Shak.*

6. The slough or cast skin of a serpent or other animal.

**SPOIL'ABLE**, *a.* That may be spoiled. **SPOIL'BANK**, or **SPOIL**, *n.* The surplus excavated material which is laid down by the side of a line of railway, canal, or other work, to save the expense of removal. This occurs in cases where the amount of cutting upon the line exceeds the amount of embanking.

**SPOILED**, *pp.* Plundered; pillaged; corrupted; rendered useless.

**SPOIL'ER**, *n.* A plunderer; a pillager; a robber.—2. One that corrupts, mars, or renders useless. **SPOIL'FUL**, *a.* Wasteful; rapacious. [*Little used.*]

**SPOIL'ING**, *ppr.* Plundering; pillaging; corrupting; rendering useless.—2. Wasting; decaying.

**SPOIL'ING**, *n.* Plunder; waste.—2. In *mastmaking*, the act of taking the greatest distance of the inequalities between any two pieces of timber to be fayed.

**SPOKE**, *pret.* of *Speak*.

**SPOKE**, *n.* [*Sax. spaca*; *G. speiche*. This word, whose radical sense is to shoot or thrust, coincides with *spike*, *spigot*, *pike*, and *G. speien*, contracted from *speichen*, to *spew*.] 1. The radius or ray of a wheel; one of the small bars which are inserted in the hub or nave, and which serve to support the rim or felly.

**SPOKEN**, *pp.* of *Speak*; *pron* spo'kn.

**SPOKE-SHAVE**, *n.* A sort of small plane used for dressing the spokes of wheels, and other curved work, where the common plane cannot be applied.

**SPOKESMAN**, *n.* [*Speak*, *spoke*, and *man*.] One who speaks for another. He shall be thy *spokesman* to the people; *Exod. iv.*

**SPO'LYA OPYMA**, *n. plur.* [*L.*] Spoil taken from an enemy; booty; any prey or pillage. [*Used by English writers in a sportive or burlesque sense.*]

**SPO'LIATE**, *v. t.* [*L. spolio*.] To plunder; to pillage.

**SPO'LIATE**, *v. i.* To practise plunder; to commit robbery. In time of war, rapacious men are let loose to *spoliates* on commerce.

**SPO'LIATED**, *pp.* Plundered; robbed.

**SPO'LIATION**, *n.* The act of plundering, particularly of plundering an enemy in time of war.—2. The act or practice of plundering neutrals at sea under authority.—3. In *eccl'es. affairs*, the act of an incumbent in taking the fruits of his benefice without right, but under a pretended title.—*Writ of spoliation*, a writ obtained by one of the parties to a suit in the ecclesiastical courts, suggesting that his adversary has wasted the fruits of a benefice, or received them to his prejudice.

**SPO'LIATOR**, *n.* One who commits spoliation.

**SPO'LIATORY**, *a.* Causing spoliation; destructive.

**SPONDA'IC**, } *a.* [*See SPONDEE.*]

**SPONDA'ICAL**, } Pertaining to a spondee; denoting two long feet in poetry.—*Spondaic verse*, an hexameter line in which the two last feet are spondees; instead of the usual termination, a dactyl and a spondee.

**SPON'DEE**, *n.* [*Fr. spondée*; *L. spondaeus*.] A poetic foot of two long syllables, used in Greek and Latin poetry.

**SPON'DYL**, } *n.* [*L. spondylus*; *Gr. σπονδυλος*.] A joint of the back bone; a vertebra.

**SPON'DYLUS**, *n.* A genus of rough, inequivalved marine bivalves, with unequal beaks; the hinge with two recurved teeth, separated by a small hollow. *Spondyli* are found only in the ocean, attached to rocks, corals, &c. They are remarkable for their spines, and the richness of colouring of the shells. The spring oysters, water-clam, &c., belong to this genus. It is made the type of a nat. family, *Spondyliæ*, of marine conchifers.

**SPONGE**, *n.* (spünj.) [*L. sponsgia*; *Gr. σπογγια*; *Fr. eponge*; *It. spugna*; *Sp. esponja*; *Sax. spongea*; *D. spons*.] 1. A porous marine substance, found adhering to rocks, shells, &c. under water, and on rocks about the shore at low water,

particularly in the Mediterranean sea, about the islands of the Archipelago, and in the Red Sea. It was formerly supposed to be a vegetable production, but it is now generally classed among the zoophytes, and it consists of a fibrous reticulated substance, covered by a soft gelatinous matter, but in which no polypes have hitherto been observed. The only symptom of vitality is that the gelatinous matter appears to be susceptible of a slight contraction or trembling on being touched. [See SPONGIA.] Sponge is very soft, light, and porous, easily compressible, readily imbibing fluids, and thereby distending, and as readily giving them out again upon compression. Sponges assume a great variety of shapes, resembling shrubs, globes, tubes, fans, vases, &c. Sponge is used in surgery, and for a variety of purposes in the arts. The sponges of commerce are usually prepared before they come into the market, by being beaten and soaked in dilute muriatic acid, with a view to bleach them and dissolve any adherent portions of carbonate of lime. Three kinds are commonly sold, and known as the Turkey; the variety of the same which is very rare; and the West Indian. The finer sorts are brought from Nicaria, an island in the Mediterranean, and from Constantinople.—*Burnt sponge*, sponge burnt until it becomes black, when it is reduced to a fine powder. This preparation is administered with bark in the cure of serofulous complaints, and forms the basis of a lozenge which has been known to cure the bronchocele. Burnt sponge is now superseded by iodine.—2. In *gunnery*, an instrument for cleaning cannon after a discharge. It consists of a cylinder of wood, covered with lamb skin. For small guns, it is commonly fixed to one end of the handle of the rammer.—3. In the *manege*, the extremity or point of a horse-shoe, answering to the heel.—*Pyrotechnical sponge* is made of mushrooms or fungi, growing on old oaks, ash, fir, &c., which are boiled in water, dried, and beaten, then put in a strong lye prepared with saltpetre, and again dried in an oven. This makes the black match or tinder brought from Germany. SPONGE, *v. i.* (spūnj.) To wipe with a wet sponge; as, to *sponge* a slate.—2. To wipe out with a sponge, as letters or writing.—3. To cleanse with a sponge; as, to *sponge* a cannon.—4. To wipe out completely; to extinguish or destroy. SPONGE, *v. i.* (spūnj.) To suck in or imbibe, as a sponge.—2. To gain by mean arts, by intrusion or hanging on; as, an idler who *sponges* on his neighbour. SPONGE-CAKE, *n.* A sweet cake: so called from its light make. SPONG'ED, *pp.* Wiped with a sponge; wiped out; extinguished. SPONGELET, *n.* A spongiote,—*which see.* SPONG'EOUS, *a.* Of the nature of sponge; full of small pores. SPONG'ER, *n.* One who uses a sponge; a hanger on. SPONGE TENT, *n.* In *sur.*, a preparation of sponges. It is formed by dipping sponge into hot melted wax plaster, and pressing it till cold between two iron plates. It is then cut into pieces, and was formerly used for dilating wounds, fistulous cancers, &c. SPONG'IA, *n.* A genus of Zoophytes,

belonging to the order Coralliferi, and family Corticati of Cuvier. The species yield the sponges of commerce. *S. officinalis* is the common sponge. The true nature of sponges, however, is doubtful, and some refer them to the vegetable kingdom.

SPONG'IFORM, *a.* [*sponge* and *form.*] Resembling a sponge: soft and porous; porous.—*Spongiform quartz*, float-stone,—*which see.*

SPONG'INESS, *n.* The quality or state of being spongy, or porous, like sponge. SPONG'ING-HOUSE, *n.* A bailiff's house to put debtors in.

SPONGIOLE, *n.* [See SPONGE.] In *bot.*, *spongiotes* are the little spongy organs situated at the extremities of roots. It is by the spongiotes thus situated, that plants are enabled to absorb fluids. They are constructed of cellular spongy tissue, and they imbibe the fluids that are in contact with them, partly by capillary action, and partly by hygroscopic power. They are sometimes called *spongelets*.

SPONG'IOUS, or SPONG'EOUS, *a.* Full of small cavities, like a sponge; as, *spongiuous bones*.

SPONG'Y, *a.* Soft and full of cavities; of an open, loose, pliable texture; as, a *spongy* excrescence; *spongy* earth; *spongy* cake; the *spongy* substance of the lungs.—2. Full of small cavities; as, *spongy bones*.—3. Wet; drenched; soaked and soft, like sponge.—4. Having the quality of imbibing fluids.—*Spongy stem*, in *bot.*, a stem internally composed of elastic cellular tissue.

SPONK, *n.* [a word probably formed on *punk.*] Touchwood. [See SPUNK.] SPONS'AL, *a.* [L. *sponsalis*, from *spondeo*, to betroth.] Relating to marriage or to a spouse.

SPONS'ION, *n.* [L. *sponsio*, from *spondeo*, to engage.] The act of becoming surety for another. *Sponsions*, in international law, are acts and engagements made on behalf of states by agents not specially authorized. Such conventions must be confirmed by express or tacit ratification.

SPONS'OR, *n.* [L. *supra.*] A surety; one who binds himself to answer for another, and is responsible for his default. In the Roman Catholic, Greek, and Lutheran churches, in the Calvinistic churches on the Continent, and in the Church of England, the *sponsors* in baptism are sureties for the education of the child baptized. In the Presbyterian church baptism is administered without *sponsors*.

SPONSORIAL, *a.* Pertaining to a sponsor.

SPONSORSHIP, *n.* State of being a sponsor.

SPONTANEITY, *n.* [Fr. *spontanité*; L. *sponte*, of free will.] Voluntariness; the quality of being of free will or accord.

SPONTA'NEOUS, *a.* [L. *spontaneus*, from *sponte*, of free will.] 1. Voluntary; proceeding from one's own will, without other cause; *applied to persons*; as, a *spontaneous* gift or proposition.—2. Acting by its own impulse, energy, or natural law, without external force, as *spontaneous* motion; *spontaneous* growth; *spontaneous* combustion.—3. Produced without being planted, or without human labour; as, a *spontaneous* growth of wood.—*Spontaneous combustion*, a taking fire of itself. Thus, oiled canvas, oiled wool, and many other combustible substances,

when suffered to remain for some time in a confined state, suddenly take fire, or undergo *spontaneous combustion*. [See COMBUSTION.]—*Spontaneous rotation*. [See ROTATION.] SPONTA'NEOUSLY, *adv.* Voluntarily; of his own will or accord; *used of animals*; as, he acts *spontaneously*.—2. By its own force or energy; without the impulse of a foreign cause; *used of things*.

They turns *spontaneously* acid.

Arbuthnot.

SPONTA'NEOUSNESS, *n.* Voluntariness; freedom of will; accord unconstrained; *applied to animals*.—2. Freedom of acting without a foreign cause; *applied to things*.

SPONTOON, *n.* [Fr. and Sp. *esponton*; It. *spontaneo*.] A kind of half pike; a military weapon formerly borne by officers of infantry.

SPOOL, *n.* [G. *spule*; D. *spool*; Dan. and Sw. *spole*.] A piece of cane or reed, or a hollow cylinder of wood with a ridge at each end; used by weavers to wind their yarn upon in order to slae it and wind it on the beam. The spool is larger than the quill on which yarn is wound for the shuttle. But in manufactories the word may be differently applied.

SPOOL, *v. t.* To wind on spools.

SPOOLED, *pp.* Wound on a spool.

SPOOLER, *n.* One who uses a spool.

SPOOLING, *ppr.* Winding on spools.

SPOOL-STAND, *n.* An article holding spools of fine thread, turning on pins, used by ladies at their work.

SPOOM, *v. i.* To be driven swiftly; probably a mistake for *spoon*. [See SPOON, the verb.]

SPOON, *n.* [Ir. *spoonog*.] 1. A small domestic utensil, with a bowl or concave part and a handle, used at table for taking up and conveying to the mouth liquids and liquid food; as, a *tea-spoon*; a *table-spoon*. Spoons, when made of silver or plated metal, are generally formed by stamping with dies, with more or less of ornamenting and finishing by hand. Spoons of Britannia metal, and similar fusible alloys, are formed by casting in brass moulds.

—*Medical spoon*, a spoon for administering liquid medicines to patients, especially to those in a recumbent position, and to such as are disposed to resist the taking of medicine. It has a hollow handle with a small aperture at the end, and when the bowl, which is covered, except a small opening at the end, is filled with the medicine, the thumb is placed on the aperture at the end of the handle, by which means the medicine is prevented from running out until the spoon is secured in the patient's mouth. On removing the thumb the medicine immediately flows out, and is swallowed with very little annoyance from its disagreeable taste.—2. An instrument, consisting of a bowl or hollow iron and a long handle, used for taking earth out of holes dug for setting posts.

SPOON,† *v. i.* To put before the wind in a gale.

SPOON-BILL, *n.* [*spoon* and *bill*.] A fowl of the grallie order, and genus *Platalea*, so named from the shape of its bill, which is somewhat like a spoon or spatula. The spoon-bills belong to the tribe of herons; they live in society in wooded marshes, generally not far from the mouths of rivers, and are rarely seen on the sea-shore. The

white spoon-bill inhabits Europe generally; but as winter approaches it migrates to more southern regions, till the milder weather recalls it. The best known species are the common white spoon-bill, *Platalea leucorodia*, Linn.,

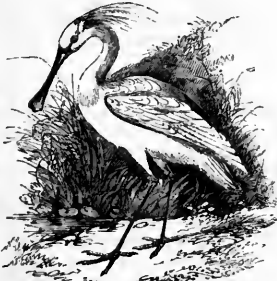

European Spoonbill (*Platalea leucorodia*).

and the roseate spoon-bill, *P. ajaja*; the latter is an inhabitant of Guiana, Mexico, &c.

**SPOON-BIT**, *n.* In carpentry, a hollow bit with a taper-point for boring wood. **SPOON-DRIET**, *n.* In seamen's lan., a showery sprinkling of sea water, swept from the surface in a tempest. **SPOONFUL**, *n.* [*spoon and full*.] As much as a spoon contains or is able to contain; as, a tea-spoonful; plur., tea-spoonfuls.—**2.** In med., half an ounce. **SPOON-MEAT**, *n.* [*spoon and meat*.] Food that is or must be taken with a spoon; liquid food.

Diet most upon spoon-meats. *Hurney.* **SPOON-WORT**, *n.* A plant of the genus *Cochlearia*; scurvy-grass.

**SPOOR**, *n.* [Dutch, *het spoor van beesten*; Ger. *spur*, a track.] In Cape Colony, the track of a wild animal or animals.

**SPORADIAL**, *a.* Scattered; sporadic. **SPORAD'IC**, } *a.* [Fr. *sporadique*; **SPORAD'ICAL**, } Gr. *σποραδικός*, separate, scattered; whence certain isles of Greece were called *Sporades*.] Separate; single; scattered; used only in reference to diseases. A *sporadic* disease is one which occurs in single and scattered cases, in distinction from an epidemic and endemic, which affect many persons at the same time.

**SPORAN'GIOLUM**, *n.* In bot., the name given to the case which contains the spore of cryptogamic plants, when it is so small as to be microscopic.

**SPORAN'GIUM**, *n.* [Gr. *σπορῆ*, a sowing seed, and *αγγος*, a vessel.] In bot., the case in which the sporules or reproductive germs of ferns, mosses, and many other cryptogamic plants is enclosed. It is used, in cryptogamic plants, synonymously with *theca*, *capsule*, *folliculum*, *sporocarpium*.

**SPORE**, } *n.* See **SPORULES**. **SPORULE**, }

**SPORIDES**, or **SPORIDIA**, *n.* [Gr. *σπορα*, seed, and *ιδος*, form.] In bot., a name given to the granules which resemble sporules in Algae and Characeae, but which are of a doubtful nature. The same name is given to the immediate covering of the sporules in fungi. **SPORIDIO'IA**, *n.* In bot., the sporules or reproductive organs of fungi.

**SPOROCARP'IMUM**, *n.* [Gr. *σπορον*, a seed, and *καρπος*, fruit.] In bot., a term used almost synonymously with *sporangium*,—*which see*. It is generally adopted by German cryptogamic botanists to express a combination of *sporangia*, when placed near together, and more especially when any number of sporangia are enclosed in a common membrane.

**SPORAN**, *n.* [Gael. *sporan*, *sparan*.] The leathern pouch or large purse worn by Highlanders in full dress. It

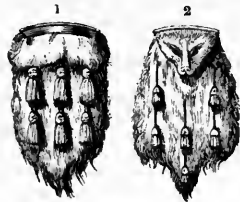

Fig. 1. Fancy dress Sporrans. Fig. 2. Sporrans as worn by the 93d Regiment.

is worn in front of the philibeg. The word properly signifies a purse, and is sometimes used in that general sense.

**SPORT**, *n.* [D. *boert*, jest; *boerten*, to jest; *boertig*, merry, facetious, jocular.]

**1.** That which diverts and makes merry; play; game; diversion; also, mirth. The word signifies both the cause and the effect; that which produces mirth, and the mirth or merriment produced.

Her sports were such as carried riches of knowledge upon the stream of delight. *Sidney.* Here the word denotes the cause of amusement.

They called for Samson out of the prison-house; and he made them sport; *Judges xvi.* Here sport is the effect. The national sports, amusements, and pastimes of a people form an important feature in the national character. They take their tone from the manners, habits, and condition of the age or country in which they prevail.—**2.** Mock; mockery; contemptuous mirth.

Then make sport at me, then let me be your jest. *Shak.* They made a sport of his prophets. *Esdra.*

**3.** That with which one plays, or which is driven about. To fitting leaves, the sport of every wind. *Dryden.*

Never does man appear to greater disadvantage than when he is the sport of his own ungoverned passions. *J. Clarke.*

**4.** Play; idle jingle. An author who should introduce such a sport of words upon our stage, would meet with small applause. *Broome.*

**5.** Diversion of the field, as fowling, hunting, fishing.—In sport, to do a thing in sport, is to do it in jest, for play or diversion.

So is the man that deceiveth his neighbour, and saith, Am not I in sport? *Prov. xxvi.*

**SPORT**, *v. t.* To divert; to make merry; used with the reciprocal pronoun.

Against whom do ye sport yourselves? *Is. lvii.* To represent by any kind of play. Now sporting on thy lyre the love of youth. *Dryden.*

**3.** To exhibit, or bring out in public; as, to sport a new equipage. [*Familiar.*]

**SPORT**, *v. i.* To play; to frolic; to wanton. See the brisk lambs that sport along the mead. *Anon.*

**2.** To trifle. The man that laughs at religion sports with his own salvation.

**—3.** To practise the diversions of the field.

**SPORTABIL'ITY**, *n.* Frolicsomeness.

**SPORTER**, *n.* One who sports.

**SPORTFUL**, *a.* Merry; frolicsome; full of jesting; indulging in mirth or play; as, a sportful companion.

Down he alights among the sportful herd. *Milton.*

**2.** Ludicrous; done in jest or for mere play. These are no sportful productions of the soil. *Bentley.*

**SPORTFULLY**, *adv.* In mirth; in jest; for the sake of diversion; playfully.

**SPORTFULNESS**, *n.* Play; merriment; frolic; a playful disposition; playfulness; as, the sportfulness of kids and lambs.

**SPORTING**, *ppr.* Diverting; making merry; playing; wantoning.—**2.** *a.* Addicted to the diversions of the field; as, a sporting character.

**SPORTING**, *n.* The act of engaging in sports, diversions of the field, &c. **SPORTIVE**, *a.* Gay; merry; wanton; frolicsome.

Is it I That drive thee from the sportive court? *Shak.*

**2.** Inclined to mirth; playful; as, a sportive humour.

**SPORTIVELY**, *n.* In a playful manner. **SPORTIVENESS**, *n.* Playfulness; mirth; merriment.—**2.** Disposition to mirth.

**SPORTLESS**, } *a.* Without sport or mirth; joyless. **SPORT'LING**, *n.* A puny sportsman.

**SPORTSMAN**, *n.* [*sport and man*.] One who pursues the sports of the field; one who hunts, fishes, and fowls.—**2.** One skilled in the sports of the field.

**SPORTSMANSHIP**, } *n.* The practice of sportsman-  
**SPORTSMANSHIP**, } ship. **SPORTULARY**, *a.* [from *L. sportula*, a basket, an alms basket.] Subsisting on alms or charitable contributions. [*Little used.*]

**SPORTULE**, } *n.* [*L. sportula*, a little basket.] An alms; a dole; a charitable gift or contribution.

**SPORULES**, or **SPORES**, *n.* [Gr. *σπορα*, a seed.] In bot., the minute organs in cryptogamic or flowerless plants, contained in the sporangia, from which new plants are produced, answering to the seeds in the phanerogamic or flowering plants. They differ from seeds in not being generated by impregnation, and in having no definite and predetermined points of growth, but springing forth into young plants from any part of their surface.

**SPORULIF'EROUS**, *a.* [*Sporule*, and *L. fero*, to produce.] Bearing sporules; as cryptogamic plants.

**SPOT**, *n.* [D. *spat*, a spot, spavin, a popgun; *spatten*, to spot, to spatter; Dan. *spette*, a spot and *spet*, a pecker; *svart spet*, a woodpecker. We see this word is of the family of *spatter*, and that the radical sense is to throw or thrust. A spot is made by spattering or sprinkling.] **1.** A mark on a substance made by foreign matter; a speck; a blot; a place discoloured. The least spot is visible on white paper.—**2.** A stain on character or reputation; something that soils purity; disgrace; reproach; fault; blemish. [*See 1 Pet. i. 17; Eph. v. 27.*] Yet Chloe sure was form'd without a spot. *Pope.*

**3.** A small extent of space; a place; any particular place.

The spot to which I point is paradise. *Milton.* Fix'd to one spot. *Ottway.*

So we say, a *spot* of ground, a *spot* of grass or flowers; meaning a place of small extent.—4. A place of a different colour from the ground; as, the *spots* of a leopard.—5. A variety of the common domestic pigeon, so called from a spot on its head just above its beak.—6. A dark place on the disc or face of the sun or of a planet. [See SOLAR, SUN.]—7. A lucid place in the heavens.—Upon the *spot*, immediately; before moving; without changing place. [So the French say, *sur le champ*.]

It was determined upon the *spot*. *Swift*.  
SPOT, *v. t.* To make a visible mark with some foreign matter; to discolour; to stain; as, to *spot* a garment; to *spot* paper.—2. To patch by way of ornament.—3. To stain; to blemish; to taint; to disgrace; to tarnish; as reputation.  
My virgin life no *spotted* thoughts shall stain.

*Sidney.*

To *spot* timber, is to cut or chip it, in preparation for hewing.

SPOT'LESS, *a.* Free from spots, foul matter, or discoloration.—2. Free from reproach or impurity; pure; untainted; innocent; as, a *spotless* mind; *spotless* behaviour.

A *spotless* virgin and a faultless wife. *Waller*.  
SPOT'LESSNESS, *n.* Freedom from spot or stain; freedom from reproach.

SPOT'TED, *pp.* Marked with spots or places of a different colour from the ground; as, a *spotted* beast or garment.

SPOT'TED FEVER, *n.* The name given to an epidemic disease which prevailed extensively in various parts of the United States of America, at different times between the years 1806 and 1815. It was generally in the severe form of the fever that the spots or *petechiæ* appeared, which gave the name of *spotted* fever to the epidemic. It caused a very great mortality.

SPOT'TEDNESS, *n.* The state or quality of being spotted.

SPOT'TER, *n.* One that makes spots.

SPOT'TINESS, *n.* The state or quality of being spotty.

SPOT'TING, *ppr.* Marking with spots; staining.

SPOT'TY, *a.* Full of spots; marked with discoloured places.

SPOUS'AGE,† *n.* [See SPOUSE.] The act of espousing.

SPOUS'AL, *a.* [From *spouse*.] Pertaining to marriage; nuptial; matrimonial; conjugal; connubial; bridal; as, *spousal* rites; *spousal* ornaments.

SPOUS'AL, *n.* [Fr. *epousailles*; L. *sponsalia*. See SPOUSE.] Marriage; nuptials. It is now generally used in the plural; as, the *spousals* of Hippolita.

SPOUSE, *n.* (spouz.) [Fr. *epouse*; L. *sponsus, sponsa*, from *spondeo*, to engage; Ir. *posam*, id. It appears that *n* in *spondeo*, is not radical, or that it has been lost in other languages. The sense of the root is to put together, to bind. In Sp. *esposos* signifies manacles.] One engaged or joined in wedlock; a married person, husband or wife. We say of a man, that he is the *spouse* of such a woman; or of a woman, she is the *spouse* of such a man.

SPOUSE, *v. t.* (spouz.) To wed; to espouse. [Little used. See ESPOUSE.]

SPOUSE'-BREACH, *n.* In law, adultery.

SPOUS'ED, *pp.* Wedded; joined in marriage; married; but seldom used. The word used in lieu of it is *espoused*.

SPOUSELESS, *a.* (spouz'less.) Destitute of a husband or of a wife; as, a *spouseless* king or queen.

SPOUT, *n.* [D. *spuit*, a spout, *spuiten*, to spout. In G. *spitzen* is to spit, and *spotten* is to mock, banter, sport. These are of one family; *spout* retaining nearly the primary and literal meaning. See BUD and POUR.] 1. A pipe, or a projecting mouth of a vessel, useful in directing the stream of a liquid poured out; as, the *spout* of a pitcher, of a tea pot or water pot.—2. A pipe conducting water from another pipe, or from a trough on a house.—3. A violent discharge of water raised in a column at sea, like a whirlwind, or by a whirlwind. [See WATER-SPOUT.]  
SPOUT, *v. t.* To throw out, as liquids through a narrow orifice or pipe; as, an elephant *spouts* water from his trunk.

Next on his belly floats the mighty whale...  
He *spouts* the tide. *Creech*.

2. To throw out words with affected gravity; to mouth; to utter or deliver speeches by way of practice, or for effect, in the manner of a mouthing actor, or orator.

SPOUT, *v. i.* To issue with violence, as, a liquid through a narrow orifice, or from a spout; as, water *spouts* from a cask or a spring; blood *spouts* from a vein.

All the glittering hill

Is bright with *spouting* rills. *Thomson*.  
SPOUT'ED, *pp.* Thrown in a stream from a pipe or narrow orifice.

SPOUT'ER, *n.* One who spouts speeches; a mean actor.

SPOUT'-FISH, *n.* A name given to several species of bivalve mollusca, especially *Mya arenaria*, *M. truncata*, and *Solen siliqua*, because, on retiring into their holes, they squirt out water.  
SPOUT'-HOLE, *n.* An orifice for the discharge of water.

SPOUT'ING, *ppr.* Throwing in a stream from a pipe or narrow opening; pouring out words violently or affectedly.

SPOUT'ING, *n.* The act of throwing out, as a liquid from a narrow opening; a violent or affected speech; a harangue.

SPOUT'LESS, *a.* Having no spout.  
S. P. Q. R. Among the *ancient Romans*, an abbreviation of the words "*Senatus Populusque Romanus*," the Senate and Roman People.

SPRACKLE, *v. i.* To clamber. [Scotch.]  
SPRAG, or SPRACK, *a.* Vigorous; sprightly. [Local.]

SPRAG, *n.* A young salmon. [Local.]

SPRACH, *n.* A cry; a shriek; the noise made by a child when weeping; the cry of a fowl.—To *sprach*, to cry; to shriek. [Scotch.]

SPRAIN, *v. t.* [probably Sw. *spranga*, to break or loosen; Dan. *sprenger*, to spring, to burst or crack; or from the same root.] To weaken the motive power of a part by sudden and excessive exertion; to overstrain the muscles or ligaments of a joint; to stretch the muscles or ligaments so as to injure them, but without luxation or dislocation.

SPRAIN, *n.* The weakening of the motive power of a part, by sudden and excessive exertion; an excessive strain of the muscles or ligaments of a joint, without dislocation. The ordinary consequence of a sprain, is to produce some degree of swelling and inflammation in the injured part. Hence it becomes necessary to apply leeches and

cold lotions, or hot fomentations, as circumstances require, to remove the inflammation. When this is effected, stimulating liniments should be applied.

SPRAINED, *pp.* Injured by excessive straining.

SPRAINING, *ppr.* Injuring by excessive extension.

SPRAINTS, *n.* The dung of an otter.

SPRANG, *pret.* of *Sprung*; but *sprung* is more generally used.

SPRAT, *n.* [D. *sprot*; G. *sprotte*; Ir. *sproth*.] A small fish, the Clupea Sprattus. It is hardly distinguishable at first sight from the herring, but it is smaller and more slender. It is found in the North Atlantic and Mediterranean. It is also found on the British coasts, and in the Frith of Forth. It is generally considered as a delicious, well flavoured, and wholesome fish. It is also known by the name of *Garvie herring*.

SPRAT, *n.* In Scotland, the name given to a coarse reedy kind of grass, which grows on marshy ground. It is the *Juncus articulatus* of Smith, or sharp-flowered *jointed-rush*. It is used for fodder and for thatch.

SPRAT'TLE, *v. i.* To scramble. [Scotch.]

SPRAWL, *v. i.* [The origin and affinities of this word are uncertain. It may be a contracted word.] 1. To spread and stretch the body carelessly in a horizontal position; to lie with the limbs stretched out or struggling. We say, a person lies *sprawling*; or he *sprawls* on the bed or on the ground.—2. To move, when lying down, with awkward extension and motions of the limbs; to scramble in creeping.

The birds were not fledged; but in *sprawling* and struggling to get clear of the flame, down they tumbled. *L'Estrange*.

3. To widen or open irregularly, as a body of horse.

SPRAWLING, *ppr.* Lying with the limbs awkwardly stretched; creeping with awkward motions; struggling with contortion of the limbs.—2. Widening or opening irregularly, as cavalry.

SPRAY, *n.* [probably allied to *sprig*. The radical sense is a shoot.] 1. A small shoot or branch; or the extremity of a branch. Hence, spray-faggots are bundles of small branches, used as fuel.—2. Among *seamen*, the water that is driven from the top of a wave in a storm, which spreads and flies in small particles. It differs from *spoon-drift*, as *spray* is only occasional, whereas *spoon-drift* flies continually along the surface of the sea.

SPRAY DRAIN, *n.* In agriculture, a drain formed by burying the spray of trees in the earth, which serves to keep open a channel. Drains of this sort are much in use in grass lands.

SPREAD, *v. t.* pret. and pp. *Spread*. [Sax. *spreadan*, *spreadan*; G. *spreiten*. This is probably formed on the root of *broad*, G. *breit*; *breiten*, to spread.] 1. To extend in length and breadth, or in breadth only; to stretch or expand to a broader surface; as, to *spread* a carpet or a table cloth; to *spread* a sheet on the ground.—2. To extend; to form into a plate; as, to *spread* silver; Jer. x.—3. To set; to place; to pitch; as, to *spread* a tent; Gen. xxxiii.—4. To cover by extending something; to reach every part.

And an unusual paleness *spreads* her face.  
*Granville*.

5. To extend; to shoot to a greater



length in every direction, so as to fill or cover a wider space.  
The stately trees fast *spread* their branches.

*Milton.*  
6. To divulge; to propagate; to publish; as news or fame; to cause to be more extensively known; as, to *spread* a report. In this use, the word is often accompanied with *abroad*.

They, when they had departed, *spread* abroad his fame in all that country; *Matt. ix.*

7. To propagate; to cause to affect greater numbers; as, to *spread* a disease.—8. To emit; to diffuse; as, emanations or effluvia; as, odoriferous plants *spread* their fragrance.—9. To disperse; to scatter over a larger surface; as, to *spread* manure; to *spread* plaster or lime on the ground.—10. To prepare; to set and furnish with provisions; as, to *spread* a table. God *spread* a table for the Israelites in the wilderness.—11. To open; to unfold; to unfurl; to stretch; as, to *spread* the sails of a ship.

**SPREAD, v. i.** To extend itself in length and breadth, in all directions, or in breadth only; to be extended or stretched. The larger elms *spread* over a space of forty or fifty yards in diameter; or the shade of the larger elms *spreads* over that space. The larger lakes in America *spread* over more than fifteen hundred square miles.

Plants, if they *spread* much, are seldom tall. *Bacon.*

2. To be extended by drawing or beating; as, a metal *spreads* with difficulty.—3. To be propagated or made known more extensively. Ill reports sometimes *spread* with wonderful rapidity.—4. To be propagated from one to another; as, a disease *spreads* into all parts of a city.

**SPREAD, n.** Extent; compass. I have a fine *spread* of improvable land. *Addison.*

2. Expansion of parts. No flower has that *spread* of the wood-bird. *Bacon.*

3. A feast; a meal. [*Familiar, and used in contempt.*]  
**SPREAD EAGLE, n.** In *her.*, the same as an eagle displayed, or having the wings and legs extended on each side of the body.



Spread Eagle.

**SPREADER, n.** One that spreads, extends, expands, or propagates; as, a *spreader* of disease.—2. One that divulges; one that causes to be more generally known; a publisher; as, a *spreader* of news or reports.

**SPREADING, ppr.** Extending; expanding; propagating; divulging; dispersing; diffusing.—2. a. Extending or extended over a large space; wide; as, the *spreading* oak.—*Spreading branches, in bot.*, those which come off at a right angle, or at an angle approaching to a right angle.—*Spreading leaves, those* which form a moderately acute angle with the stem.—*Spreading stamens, those* which spread out at right angles to the axis of the flower.

**SPREADING, n.** The act of extending, dispersing, or propagating.

**SPREE, n.** Innocent merriment; sport; a frolic; a drunken frolic; an uproar. [*Scotch.*]

**SPRENT, † pp.** Sprinkled. [*See SPRIKLE.*]

**SPREW, n.** [*D. spreuw or spreuw, the disease called thrush.*] In *America*, the name given to a disease of the mucous membrane, consisting in a specific inflammation of the muciparous glands, with an elevation of the epithelium in round, oval, or irregular, whitish or ash-coloured vesicles. It is confined to the mouth and alimentary canal, and terminates in curd-like sloughs.

**SPRIG, n.** [*W. ysbrig; ys, a prefix, and brig, top, summit; that is, a shoot, or shooting to a point.*] 1. A small shoot or twig of a tree or other plant; a spry; as, a *sprig* of laurel or of parsley.—2. A brad or nail without a head. [*Local.*].—3. The representation of a small branch in embroidery.—4. An offshoot; a relative; as, a *sprig* of nobility. [*Used contemptuously.*]

**SPRIG, v. t.** To mark or adorn with the representation of small branches; to work with sprigs; as, to *sprig* muslin.

**SPRIG-BOLT, n.** *See* RAG-BOLT.

**SPRIG'-CRYSTAL, n.** Crystal found in the form of a hexangular column, adhering to the stone, and terminating at the other end in a point.

**SPRIG'GED, pp.** Wrought with representations of small twigs.

**SPRIG'GING, ppr.** Working with sprigs.

**SPRIG'GY, a.** Full of sprigs or small branches.

**SPRIGHTE, n.** [*G. spriet, spirit. It should be written Sprite.*]  
**SPRITE, } 1. A spirit; a shade; a soul; an incorporeal agent.**

*Forth he call'd, out of deep darkness dread, Legions of spirits, Spenser.*  
And gaping graves receiv'd the guilty *sprite.* *Dryden.*

2. A walking spirit; an apparition.—3. Power which gives cheerfulness or courage.

Hold thou my heart, establish thou my *sprights.* [*Not in use.*] *Sidney.*

4. † An arrow.

**SPRIGHTE, † v. t.** To haunt, as a spright.

**SPRIGHTEFUL, a.** [*This word seems to be formed on the root of sprag, a local word. It belongs to the family of spring and sprig.*] Lively; brisk; nimble; vigorous; gay. *Spoke like a sprightful noble gentleman.* *Shak.*

*Steeds sprightful as the light.* *Cowley.*

**SPRIGHTEFULLY, adv.** Briskly; vigorously.

**SPRIGHTEFULNESS, n.** Briskness; liveliness; vivacity.

**SPRIGHTELESS, a.** Destitute of life; dull; sluggish; as, virtue's *sprightless* cold.

**SPRIGHTLINESS, n.** [*from sprightly.*] Liveliness; life; briskness; vigour; activity; gayety; vivacity.

*In dreams, with what sprightliness and alacrity does the soul exert herself!* *Addison.*

**SPRIGHTLY, a.** Lively; brisk; animated; vigorous; airy; gay; as, a *sprightly* youth; a *sprightly* air; a *sprightly* dance. *The sprightly Sylvia trips along the green.* *Pope.*

*And sprightly wit and love inspires.* *Dryden.*

**SPRING, v. i. pret. Sprung, [sprang, not wholly obsolete;] pp. Sprung.**

[*Sax. springan; D. and G. springen.* The primary sense is to leap, to shoot.]  
1. To vegetate and rise out of the ground; to begin to appear; as vegetables.

To satisfy the desolate ground and cause the bud of the tender herb to *spring* forth; *Job xxxviii.*

In this sense, *spring* is often or usually followed by *up, forth, or out.*—2. To begin to grow.

The teeth of the young not *sprung*. *Riv.*

3. To proceed, as from the seed or cause. Much more good of sin shall *spring*. *Milton.*

4. To arise; to appear; to begin to appear or exist. When the day began to *spring*, they let her go; *Judges xxi.*

Do not blast my *springing* hopes. *Rowe.*

5. To break forth; to issue into sight or notice. O *spring* to light; auspicious babe, be born. *Pope.*

6. To issue or proceed, as from ancestors or from a country. Aaron and Moses *sprung* from Levi.—7. To proceed, as from a cause, reason, principle, or other original. The noblest title *springs* from virtue. They found new hope to *spring* out of despair. *Milton.*

8. To grow; to thrive. What makes all this but Jupiter the king, At whose command we perish and we *spring*. *Dryden.*

9. To proceed or issue, as from a fountain or source. Water *springs* from reservoirs in the earth. Rivers *spring* from lakes or ponds.—10. To leap; to bound; to jump. The mountain stag that *springs* from height to height, and bounds along the plains. *Philips.*

11. To fly back; to start; as, a bow, when bent, *springs* back by its elastic power.—12. To start or rise suddenly from a covert. Watchful as fowlers when their game will *spring*. *Ottway.*

13. To shoot; to issue with speed and violence. And sudden light *sprung* through the vaulted roof. *Dryden.*

*To spring at, to leap toward; to attempt to reach by a leap.—To spring in, to rush in; to enter with a leap or in haste.—To spring forth, to leap out; to rush out.—To spring on or upon, to leap on; to rush on with haste or violence; to assault.*

**SPRING, v. t.** To start or rouse, as game; to cause to rise from the earth or from a covert; as, to *spring* a pheasant.—2. To produce quickly or unexpectedly. The nurse, surprised with fright, Starts-up and leaves her bed, and *springs* a light. *Dryden.*

3. To start; to contrive, or to produce, or propose on a sudden; to produce unexpectedly. The friends to the cause *sprang* a new project. *Swift.*

In this sense *start* is now generally used.—4. To cause to explode; as, to *spring* a mine.—5. To burst; to cause to open; as, to *spring* a leak. When it is said, a vessel has *sprung* a leak, the meaning is, the leak has then commenced.—6. To crack; as, to *spring* a mast or a yard.—7. To cause to close suddenly, as the parts of a trap; as, to *spring* a trap.—*To spring a butt, in*

*seamen's lan.*, to loosen the end of a plank in a ship's bottom.—*To spring a leak*, to commence leaking; to begin to leak.—*To spring the luff*, when a vessel yields to the helm, and sails nearer to the wind than before.—*To spring a fence*, to leap a fence.—*To spring an arch*, to set off, begin, or commence an arch from an abutment or pier.—*To spring a rattle*, to give the alarm, as is done by a night policeman, or watchman.

**SPRING**, *n.* A leap; a bound; a violent effort; a sudden struggle; a jump; as of an animal.

The prisoner with a *spring* from prison broke. *Dryden.*

2. A flying back; the resilience of a body recovering its former state by its elasticity; as, the spring of a bow.—3. Elastic power or force. The soul or the mind requires relaxation, that it may recover its natural *spring*.

Heaven! what a *spring* was in his arm. *Dryden.*

4. In *mech.*, an elastic plate, rod, or wire of steel or other substance, which, when bent or forced from its natural state, has the power of recovering it again in virtue of its elasticity. Springs are employed as moving powers, as the main-spring of a watch; as regulators of the motions of wheel-work, as in watches; also to ascertain the weights of bodies, to diminish the effects of concussion, as in wheel-carriages, and for various other purposes. The spring is not only a very useful auxiliary, but an indispensable requisite in many pieces of mechanism.—5. Any active power; that by which action or motion is produced or propagated.

Like nature letting down the *springs* of life. *Dryden.*

Our author shuns by vulgar *springs* to move

The hero's glory. *Pope.*

6. A fountain of water; an issue of water from the earth, or the basin of water at the place of its issue. The rain which falls from the atmosphere is absorbed in three different ways. One part of it collects in rills on the surface of the ground; these unite in streams or rivulets, which, flowing into one another, form rivers, and thus it is conveyed to the ocean. A second part is taken up in giving humidity to the soil, from which it is returned to the atmosphere by evaporation. A third portion descends into the earth through soils of a spongy or porous nature, or through crevices and interstices in the strata, but being obstructed by other strata, forms subterraneous reservoirs, at various depths. When confined in this manner, it is subject to the pressure of the water which fills the channels through which it has descended, and when this pressure is sufficient to overcome the resistance of the superincumbent mass of earth, the water breaks through the superficial strata, and gushes forth in a spring. In descending downwards, and rising upwards through various mineral masses, the water of springs becomes impregnated with gaseous, saline, earthy, or metallic admixtures, as carbonic acid gas, sulphuretted hydrogen gas, nitrogen, muriate of soda, sulphate of lime, carbonate of lime, silica, carbonate of iron, &c. Warm and hot springs are common, especially in volcanic countries, where they are sometimes distinguished by violent

ebullitions. Springs are most common on the sides and at the bottoms of mountains, as the copious rains which fall on the mountains, descending through the crevices and fissures, easily find a passage out at the bottom. As a general rule, springs are permanent in proportion to the depth to which the water which supplies them has descended from the surface. The temperature of deep seated springs is generally the same with the mean temperature of the atmosphere. Some springs run for a time and then stop altogether, and after a time, run again, and again stop; these are called *intermitting springs*. [*See under INTERMITTING.*] Others do not cease to flow, but only discharge a much smaller quantity of water for a certain time, and then give out a greater quantity; these are called *variable* or *reciprocating springs*. Lakes and ponds are usually fed by *springs*.—7. The place where water usually issues from the earth, though no water is there. Thus we say, a *spring* is dry.—8. A source; that from which supplies are drawn. The real Christian has in his own breast a perpetual and inexhaustible *spring* of joy.

The sacred *spring* whence right and honour stream. *Davies.*

9. Rise; original; as, the *spring* of the day; 1 Sam. ix.—10. Cause; original. The *springs* of great events are often concealed from common observation.

—11. In *astron.*, one of the four seasons of the year; the season in which plants begin to vegetate and rise; the vernal season. For the northern hemisphere, the spring season commences when the sun enters Aries, or about the 21st of March, and ends at the time of the summer solstice, or about the 22d of June. In *common lan.*, spring commences in February and ends in April.—12. In *seamen's lan.*, a crack in a mast or yard, running obliquely or transversely. [In this sense of *leak*, we believe, it is not used.]

—13. A rope passed out of a ship's stern, and attached to a cable proceeding from her bow, when she is at anchor. It is intended to bring her broadside to bear upon some object. A spring is also a rope extending diagonally from the stern of one ship to the head of another, to make one ship sheer off to a greater distance.—14. † A plant; a shoot; a young tree.—15. † A youth.

16. † A hand; a shoulder of pork.—*Spring bevel* of a rail, in *arch.*, the angle which the top of the plank makes with a vertical plane which has its termination in the concave side, and touches the ends of the rail-piece.

**SPRING**, *n.* A quick and cheerful tune on a musical instrument. [*Scotch.*]

**SPRING'AL**, † *n.* A youth.

**SPRING'ALD**, *n.* An ancient warlike engine, used for shooting large arrows, pieces of iron, &c. It is supposed to have resembled the cross-bow in its construction. The word is evidently derived from Fr. *espringalle*, an ancient war engine for throwing stones, great arrows, &c.

**SPRING'-BACK**, *n.* In *book-binding*, the cover of a book which is not made fast to the back, but which springs back when the book is opened.

**SPRING'-BALANCE**, *n.* A contrivance for determining the weight of any article by observing the amount of deflection or compression which it pro-

duces upon a helical steel spring properly adjusted and fitted with an index working against a graduated scale. The spring-balance is much used for regulating the pressure upon the safety-valves of locomotive engines, as on account of the jolts and oscillations to which they are liable, weights are altogether inapplicable.

**SPRING'-BOK**, *n.* [D. *spring* and *boh*, a buck or he goat.] A ruminant mammal of the caprid tribe, the *Antelope*



Spring-bok (*Antelope euchores*).

*euchores*, or *Springer Antelope*, which inhabits the plains of South Africa.

**SPRING'-BOX**, *n.* The box which contains the main-spring of a watch. The axis about which the spring is wound is called the *spring-arbor*.

**SPRING'-CAR'RIAGE**, *n.* A wheel carriage mounted upon springs. The chief use of springs in carriages is to diminish the effects of concussions arising from the motion of the wheels over prominences and inequalities on the surface of roads.

**SPRING'E**, *n.* (*spring*.) [from *spring*.] A gin; a noose of horse-hair or fine wire to catch birds, rabbits, game, &c.

**SPRING'E**, *v. t.* To catch in a springe; to ensnare.

**SPRING'ER**, *n.* One who springs; one that rouses game.—2. A name given to the grampus.—3. In *arch.*, the impost or place where the vertical support to an arch terminates, and the curve of the arch begins. The term is sometimes applied to the rib of a groined roof or vault. [*See IMPOST.*]

**SPRING'-FEED**, *n.* In *agriculture*, herbage produced in the spring.

**SPRING'-GRASS**, *n.* A British grass, of the genus *Anthoxanthum*, the *A. odoratum*, which grows in pastures and meadows. It is one of the most early grasses, flowering early in April; hence the name. The sweet scent of new-made hay is in a great measure owing to this plant. It is one of the sweetest as well as one of the most useful of our pasture grasses.

**SPRING'-GUN**, *n.* A gun which is discharged by means of a spring attached to the lock. *Spring guns* may be set in dwelling-houses at night to ward off the attacks of robbers, &c., but it is illegal to set them anywhere else.

**SPRING'-HALT**, *n.* [*spring* and *halt*.] A kind of lameness in which a horse suddenly latches up his legs.

**SPRING'-HEAD**, *n.* A fountain or source; an originating source where several springs unite to form a stream.

**SPRING'INESS**, *n.* Elasticity; also, the power of springing.—2. The state of abounding with springs; wetness; sponginess; as of land.

**SPRING'ING**, *ppr.* Arising; shooting up; leaping; proceeding; rousing. In *her.*, a term applicable to beasts of chase in the same sense as *salient* to beasts of prey. It is also applied to

fish when placed in bend.—*Springing use, in law*, a contingent use; a use which may arise upon a contingency.

**SPRING'ING**, *n.* The act or process of leaping, arising, issuing, or proceeding.—2. Growth; increase; Ps. lxx.—3. In *arch.*, the point from which an arch springs or rises.—*Springing course*, the horizontal course of stones from which an arch springs or rises.—In *carpentry*, in *boarding a roof*, the setting the boards together with bevel joints for the purpose of keeping out the rain.

**SPRING' LATCH**, *n.* A latch with a spring for fastening a gate.

**SPRING'GLE**, † *n.* A springe; a noose.

**SPRING' RYE**, *n.* Rye that is sown in the spring.

**SPRING' TIDE**, *n.* [*spring and tide.*] The tide which happens at or soon after the new and full moon, which rises higher than common tides. At these times the sun and moon are in a straight line with the earth, and their combined influence in raising the waters of the ocean is the greatest; consequently, the tides thus produced are the highest. [See **TIDE.**]

**SPRING' TIME**, *n.* The spring.

**SPRING' WATER**, *n.* Water issuing from a natural source; in contradistinction to river water, rain water, &c.

**SPRING' WHEAT**, *n.* [*spring and wheat.*] A species of wheat to be sown in the spring; so called in distinction from *winter wheat*.

**SPRING'Y**, *a.* [from *spring.*] Elastic; possessing the power of recovering itself when bent or twisted.—2. Having great elastic power.—3. Having the power to leap; able to leap far.—4. Abounding with springs or fountains; wet; spongy; as, *springy land*.

**SPRINK'LE**, *v. t.* [Sax. *sprengan*; D. *sprengelen*, *sprengen*; G. *sprengen*; Ir. *spreighim.* The *L. spargo* may be the same word with the letters transposed, *n* being casual.] 1. To scatter; to disperse; as a liquid or a dry substance composed of fine separable particles; as, Moses *sprinkled* handfuls of ashes toward heaven; Ex. ix.—2. To scatter on; to disperse on in small drops or particles; to wet or besprinkle; as, to *sprinkle* the earth with water; to *sprinkle* a floor with sand; to *sprinkle* paper with iron filings.—3. To wash; to cleanse; to purify.

Having our hearts *sprinkled* from an evil conscience; Heb. x.

**SPRINK'LE**, *v. i.* To perform the act of scattering a liquid or any fine substance, so that it may fall in small particles.

The priest shall *sprinkle* of the oil with his fingers; Lev. xiv.

Baptism may well enough be performed by *sprinkling* or effusion of water. *Ayiffe.*

2. To rain moderately; as, it *sprinkles*.

**SPRINK'LE**, *n.* A small quantity scattered; also, an utensil for sprinkling.

**SPRINK'LED**, *pp.* Dispersed in small particles, as a liquid or as dust.—2. Having a liquid or a fine substance scattered over.

**SPRINK'LER**, *n.* One that sprinkles.

**SPRINK'LING**, *pp.* Dispersing, as a liquid or as dust.—2. Scattering on, in fine drops or particles.

**SPRINK'LING**, *n.* The act of scattering in small drops or parcels.—2. A small quantity falling in distinct drops or parts, or coming moderately; as, a *sprinkling* of rain or snow.

**SPRIT**, † *v. t.* [Sax. *spryttan*, to sprout;

G. *sprissen*; Dan. *spruder*, *sproyter*, to spirit; Sw. *spritta*, to start. It is of the same family as *sprout.*] To throw out with force from a narrow orifice; to eject; to spirit. [See **SPIRR.**] **SPRIT**, *v. i.* To sprout; to bud; to germinate; as barley steeped for malt. **SPRIT**, *n.* A shoot; a sprout.—2. [D. *spriet.*] A small boom, pole, or spar which crosses the sail of a boat diagonally from the mast to the upper

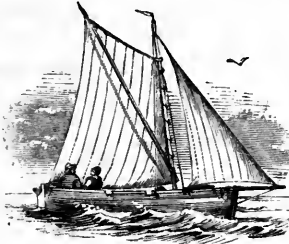

Sprit-sail rigged boat.

aftmost corner, which it is used to extend and elevate. The lower end of the sprit rests in a sort of wreath, called the *snotter*, which encircles the mast at that place.

**SPRITE**, *n.* [If from G. *spriet*, this is the more correct orthography. The Welsh has *sprid*, a spirit.] A spirit.

**SPRITEFUL**. See **SPRITFUL**.

**SPRITEFULLY**. See **SPRITFULLY**.

**SPRITELINESS**. See **SPRITLINESS**.

**SPRITELY**. See **SPRITELY**.

**SPRIT' SAIL**, *n.* [*sprit and sail.*] The sail extended by a sprit, chiefly used in small boats.—2. A sail, now disused, attached to a yard which hangs under the bowsprit of large vessels. It is furnished with a large hole at each of

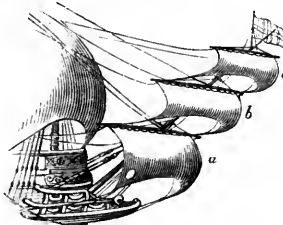

Spritsails.

a, Spritsail; b, Spritsail topsail; c, Spritsail top-gallant sail.

its lower corners, to evacuate the water with which the cavity or belly of it is frequently filled by the surges of the sea, when the ship pitches.—*Sprit-sail, topsails, and sprit-sail top-gallant sails* were also formerly used, but not now.

**SPROD**, *n.* A salmon in its second year. **SPRONG**, † *oldpret. of Spring.* [Dutch.] **SPROUT**, *v. i.* [D. *spruiten*; G. *sprossen*; Sax. *spryttan*; Sp. *brotar*, the same word without *s.* See **SPRIT.**] 1. To shoot, as the seed of a plant; to germinate; to push out new shoots. A grain that *sprouts* in ordinary temperature in ten days, may, by an augmentation of heat, be made to *sprout* in forty-eight hours. The stumps of trees often *sprout*, and produce a new forest.—2. To shoot into ramifications.

Vitriol is apt to *sprout* with moisture.

*Bacon.*

3. To grow, like shoots of plants. And on the ashes *sprouting* plumes appear. *Ticket.*

**SPROUT**, *n.* The shoot of a plant; a shoot from the seed or from the stump or from the root of a plant or tree. The *sprouts* of the cane, in Jamaica, are called *ratoons*.—2. A shoot from the end of a branch. The young shoots of shrubs are called *sprouts*, and in the forest often furnish browse for cattle.

**SPROUT'ING**, *pp.* Shooting in vegetation; germinating.

**SPROUTS**, *n. plur.* Young coleworts.

**SPRUCE**, *a.* Nice; trim; neat without elegance or dignity; formerly applied to things with a serious meaning; now applied to persons only.

He is so *spruce*, that he never can be genteel. *Taller.*

**SPRUCE**, *v. t.* To trim; to dress with great neatness.

**SPRUCE**, *v. i.* To dress one's self with affected neatness.

**SPRUCE**, or **SPRUCE FIR**, *n.* The name given to several species of trees of the genus *Abies*. The Norway spruce fir is the *A. excelsa*, or *Pinus abies*,



Norway Spruce (*Abies excelsa*).

Linn., which yields the valuable timber known under the name of white or Christiania deal. The white spruce is the *A. alba*, which grows in the colder regions of North America. The black or red spruce fir is the *A. nigra*, which is a native of the most inclement regions of North America, and attains the height of 70 or 80 feet, with a diameter of from 15 to 20 inches. Its timber is of great value on account of its strength, lightness, and elasticity. It is employed for the yards of ships, and from the young branches is extracted the *essence of spruce*, so well known as a useful antiscorbutic in long voyages. The red spruce is thought by some to be a distinct species (*A. rubra*), but the researches of Michaux show that it is merely a variety of the black spruce. The hemlock spruce fir is the *A. canadensis*, a noble species, rising to the height of 70 or 80 feet, and measuring from 2 to 3 feet in diameter. It grows abundantly near Quebec, in Nova Scotia, New Brunswick, Vermont, and the upper parts of New Hampshire. The wood is employed for laths, and for coarse in-door work. The bark is exceedingly valuable for tanning.

**SPRUCE-BEER**, *n.* A fermented liquor made from the leaves and small branches

of the spruce fir (*Abies excelsa*, *Abies nigra*, or red spruce), with sugar, molasses, or treacle. There are two kinds, the brown and the white, of which the latter is considered the best, as being made from white sugar instead of molasses. Spruce beer forms an agreeable and wholesome beverage, and is useful as an antiscorbutic.

**SPRÜCE LEATHER, n.** A corruption of Prussian leather.

**SPRÜCELŸ, adv.** With extreme or affected neatness.

**SPRÜCENESS, n.** Neatness without taste or elegance; trimness; fineness; quaintness.

**SPRUNG, † v. t.** To make smart.

**SPRUNG, pret. and pp. of Spring.** The man sprung over the ditch; the mast is sprung; a hero sprung from a race of kings.

**SPRUNT, † v. i.** To spring up; to germinate; to spring forward.

**SPRUNT, † n.** Any thing short and not easily bent.—2. † A leap; a spring.—3. A steep ascent in a road. [*Local.*]

**SPRUNT, † a.** Active; vigorous; strong; becoming strong.

**SPRUNTLY, † adv.** Vigorously; youthfully; like a young man.

**SPRY, a.** In the United States, having great power of leaping or running; nimble; active; vigorous. [This word is in common use in New England, and is doubtless a contraction of *sprig*. See *SPRIGHTLY.*]

**SPUD, n.** [*Dan. spyd*, a spear; *Ice. spioot*. It coincides with *spit*.] 1. A short knife. [*Little used.*]—2. Any short thing; in contempt.—3. An implement somewhat like a chisel, with a long handle, used by farmers for destroying weeds.

**SPUKE, n.** A spirit or spectre.

**SPUL'LER, n.** One employed to inspect yarn, to see that it is well spun, and fit for the loom. [*Local.*]

**SPUL'ZIE, } n. [*L. spoliare.*] Spoil;**  
**SPUL'ZIE, } booty. [*Scotch.*] In**  
**SPUL'YIE, } Scots law, the taking**  
away of movable goods in the possession of another, against the declared will of the person, or without the order of law.

**SPUME, n.** [*L. and It. spuma*; *Sp. espuma.*] 1. Froth; foam; scum; frothy matter raised on liquors or fluid substances by boiling, effervescence, or agitation.

**SPUME, v. i.** To froth; to foam.

**SPUMES' CENCE, n.** Frothiness; the state of foaming.

**SPUMIF'EROUS, a.** Producing foam.

**SPUM'INESS, n.** Quality of being spumy.

**SPÜMOUS, } a. [*L. spumeus.*] Con-**  
**SPÜMY, } sisting of froth or scum;**  
foamy.

The *spumy waves* proclaim the wat'ry war.  
*Dryden.*

The *spumous* and florid state of the blood.  
*Arbuhnot.*

**SPUN, pret. and pp. of Spin.**

**SPUNGE.** See *SPONGE.*

**SPUNG'ING-HOUSE, } n. In England,**  
**SPONG'ING-HOUSE, } a victualling**  
house or tavern where persons arrested for debt are kept, according to law, by a bailiff, for twenty-four hours, before lodging them in prison. Spunging-houses are usually taverns kept by the bailiff, and are so named from the extortions practised in them upon the prisoners.

**SPUN-HAY, n.** Hay twisted into ropes for convenient carriage on a military expedition.

**SPUNK, n.** [probably from *punk*.] Touchwood; wood that readily takes fire. Hence,—2. *Colloquially*, an inflammable temper; mettle; spirit; as, a man of *spunk*. Ill natured observations touched his *spunk*. In this signification *spunk* is used in the Scottish dialect, in which it is used to signify also a spark of fire or a small portion of ignited matter; a very small fire; a match; a small portion of any principle of action or intelligence.

**SPUNK'IE, n.** A name given to the *ignis fatuus*, or Will with a wisp. [*Scotch.*]

**SPUNK'Y, a.** Spirited; fiery; irritable; brisk. [*Local, and familiar.*]

**SPUN-YÄRN, n.** Among seamen, a line or cord formed of two, three, or more rope yarns twisted together. The yarns are usually drawn out of the strands of old cables, and knotted together. Spun yarn is used for various purposes, as serving ropes, weaving mats, &c.

**SPUR, n.** [*Sax. spur*; *G. sporn*; *Ir. spor*; *W. yspardun*; *Fr. eperon*; coinciding in elements with *spear*.] 1. An instrument having a rowel or little wheel with sharp points, worn on horsemen's

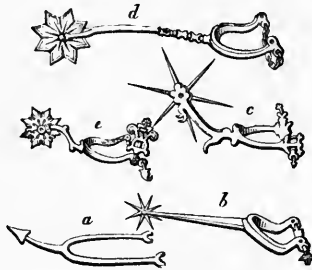

Ancient Spurs.

- a. Frankish Spur, of the tenth century.
- b. Brass Spur, of the reign of Henry IV.
- c. Long-spined rowel Spur, of the reign of Edw. IV.
- d. Steel-necked brass Spur, of the reign of Henry VII.
- e. Long Spur, early part of the reign of Henry VIII.

heels, to prick the horses for hastening their pace.

Girth with rusty sword and spur. *Hudibras.*

Hence, to set spurs to a horse, is to prick him and put him upon a run.—

2. Incitement; instigation. The love of glory is the spur to heroic deeds.—

3. The largest or principal root of a tree; hence, perhaps, the short wooden buttress of a post; [that is, in both cases, a shoot].—4. The hard pointed projection on a cock's leg, which serves as an instrument of defence and annoyance.—

5. Something that projects; a snag.—6. In geography, a divergent mountain or hill; a branch or subordinate range of mountains or hills, that shoots out angularly from a larger range.—

7. That which excites. We say, upon the spur of the occasion; that is, the circumstances or emergency which calls for immediate action.—

8.—A sea swallow.—9. The hinder part of the nectary in certain flowers, shaped like a cock's spur.—

10. The ergot of rye. [*See ERGOT.*]—

11. In old fortifications, a wall that crosses a part of the rampart and joins to the town wall.—

12. In ships, spurs are pieces of timber fixed on the bulwarks to secure them.—

13. In carpentry, a term used synonymous with *strut*.

**SPUR, v. t.** [*Ir. sporam.*] 1. To prick with spurs; to incite to a more hasty pace; as, to spur a horse.—2. To incite; to instigate; to urge or encourage

to action, or to a more vigorous pursuit of an object. Some men are spurred to action by the love of glory, others by the love of power. Let affection spur us to social and domestic duties.—3. To impel; to drive.

Love will not be *spurr'd* to what it loathes.  
*Shak.*

4. To put spurs on.—*Spurs of the beams*, in a ship, are curving timbers, serving as half beams to support the deck where whole beams cannot be used.

**SPUR, v. i.** To travel with great expedition.

The Parthians shall be there,  
And spurring from the fight, confess their fear. [*Unusual.*] *Dryden*

2. To press forward.

Some bold men...by spurring on, refine themselves.  
*Grev.*

**SPUR'GLAD, a.** Wearing spurs.

**SPUR'GALL, v. t.** [*spur and gall.*] To gall or wound with a spur.

**SPUR'GALL, n.** A place galled or excoriated by much using of the spur.

**SPUR'GALLED, pp.** Galled or hurt by a spur; as, a *spurgalled hackney*.

**SPURGE, n.** [*Fr. epurge*; *It. spurgo*, a purge; from *L. purgo, expurgo.*] The common name of the different species of British plants of the genus *Euphorbia*. They abound with an acrid milky juice. [*See EUPHORBIA.*]

**SPUR'-GEAR, } n.** Another name for  
**SPUR'-GEER, } spur-wheels,—which**  
see.

**SPURGE'-FLAX, n.** A plant, *Daphne gnidium*, a native of Spain.

**SPURGE'-LAUREL, n.** The *Daphne laureola*, a shrub, a native of Britain, possessing acrid properties. [*See DAPHNE.*]

**SPURGE'-OLIVE, n.** A shrub, the *Daphne oleoidea*, inhabiting Britain. It possesses very acrid properties. [*See DAPHNE.*]

**SPURGE'-WÖRT, n.** A name applied to the Spurges, plants of the genus *Euphorbia*.

**SPUR'ING, †** for *Purging*.

**SPUR'IOUS, a.** [*L. spuriosus.*] 1. Not genuine; not proceeding from the true source, or from the source pretended; counterfeit; false; adulterate. *Spurious* writings are such as are not composed by the authors to whom they are ascribed. *Spurious* drugs are common. The reformed churches reject *spurious* ceremonies and traditions.—

2. Not legitimate; bastard; as, *spurious* issue. By the laws of England, one begotten and born out of lawful matrimony, is a *spurious* child.—

*Spurious disease*, a disease commonly mistaken for, and called by the name of something which it is not; as *spurious pleurisy*, i. e. *rheumatism* of the intercostal muscles.

**SPUR'IOUSLY, adv.** Counterfeitly; falsely.

**SPUR'IOUSNESS, n.** The state or quality of being counterfeit, false, or not genuine; as, the *spuriousness* of drugs, of coin, or of writings.—

2. Illegitimacy; the state of being bastard, or not of legitimate birth; as, the *spuriousness* of issue.

**SPUR'LESS, a.** Having no spurs.

**SPUR'LING-LINE, n.** Among seamen, the line which forms the communication between the wheel and the tell-tale.

**SPURN, v. t.** [*Sax. spurnan*; *Ir. sporam*; *L. sperno*; *asperno*; from the root of *spur*, or from kicking.] 1. To kick; to drive back or away, as with

the foot.—2. To reject with disdain; to scorn to receive or accept. What multitudes of rational beings *spurn* the offers of eternal happiness!—3. To treat with contempt.

**SPURN**, *v. i.* To manifest disdain in rejecting any thing; and, to *spurn* at the gracious offers of pardon.—2. To make contemptuous opposition; to manifest disdain in resistance. Nay more, to *spurn* at your most royal image. *Shak.*

3. To kick or toss up the heels. The drunken chairman in the kennel *spurns*. *Gay.*

**SPURN**, *n.* Disdainful rejection; contemptuous treatment.

The insolence of office, and the *spurns* That patient merit of the unworthy takes. *Shak.*

**SPURN'ED**, *pp.* Rejected with disdain; treated with contempt.

**SPURN'ER**, *n.* One who spurns.

**SPURN'ING**, *ppr.* Rejecting with contempt.

**SPURN-WATER**, *n.* In *ships*, a channel at the end of a deck to restrain the water.

**SPURRE**, *n.* A name of the sea swallow. **SPURRED**, *pp.* Furnished with spurs.—2. Incited; instigated.—3. *a.* Wearing spurs, or having shoots like spurs.

—*Spurred corolla*, a corolla which has at its base a hollow prolongation like a horn; as in antirrhinum.—*Spurred rye*, rye affected with ergot. [See ERGOT.]

**SPUR'ER**, *n.* One who uses spurs.

**SPUR'EY**, *n.* The common name of several British plants of the genus *Spergula*. [See SPERGULA.]

**SPUR'IER**, *n.* One whose occupation is to make spurs.

**SPUR'ING**, *ppr.* Pricking with spurs; inciting; urging.

**SPUR-ROYAL**, *n.* A gold coin, first made in the reign of Edward IV. In the reign of James I. its value was fifteen shillings. Sometimes written *spur-rial* or *ryal*.

**SPURT**. See SPIRT.

**SPUR'WAY**, *n.* [*spur* and *way*.] A horse path; a narrow way; a bridle road; a way for a single beast.

**SPUR'-WHEELS**, *n.* In *machinery*, wheels in which the teeth are perpendicular to the axis, and in the direction of radii. Such wheels are also called *Spur-gear*.

**SPUR'-WING**, *n.* The English name for a species of wading birds of the genus *Jacana* or *Parra*, having the wing armed with a bony spur. They inhabit Africa, and South America.

**SPUR'-WORT**, *n.* A British plant of the genus *Sherardia*, the *S. arvensis*, called also field madder. [See FIELD MADDER.]

**SPUTA'TION**, *† n.* [*L. sputo*, to spit.] The act of spitting.

**SPUTATIVE**, *† a.* [*supra*.] Spitting much; inclined to spit.

**SPUT'ER**, *v. i.* [*D. spuiten*, to spout; *L. sputo*, to spit. It belongs to the root of *spout* and *spit*; of the latter it seems to be a diminutive.] 1. To spit, or to emit saliva from the mouth in small or scattered portions, as in rapid speaking.—2. To throw out moisture

in small detached parts; as, green wood *sputtering* in the flame.—3. To fly off in small particles with some crackling or noise.

When sparkling lamps their *sputtering* lights advance. *Dryden.*

4. To utter words hastily and indistinctly; literally, to *spout small*; to speak so rapidly as to emit saliva.

They could neither of them speak their rage, and so they fell a *sputtering* at one another, like two roasting apples. *Congreve.*

**SPUT'ER**, *v. t.* To throw out with haste and noise; to utter with indistinctness.

In the midst of caresses...to *sputter* out the basest accusations. *Swift.*

**SPUT'ER**, *n.* Moist matter thrown out in small particles.

**SPUT'ERED**, *pp.* Thrown out in small portions, as liquids; uttered with haste and indistinctness, as words.

**SPUT'ERER**, *n.* One that sputters.

**SPUT'ERING**, *ppr.* Emitting in small particles; uttering rapidly and indistinctly; speaking hastily; spouting.

**SPUT'UM**, *n.* [*L.*] Spittle; salival discharges from the mouth.—2. In *med.*, that which is expectorated, or ejected from the lungs.

**SPY**, *n.* [*It. spia*; *Fr. espion*; *G. späher*; *W. yspeitaw*, to spy, to explore; *yspeithaw*, to look about; *yspaitb*, that is, open, visible; *paith*, an opening, a prospect, a glance.] 1. A person sent into an enemy's camp to inspect their works, ascertain their strength and their intentions, to watch their movements, and secretly communicate intelligence to the proper officer. By the laws of war among all civilized nations, a *spy* is subjected to capital punishment.—2. A person deputed or hired to watch the actions, motions, conduct, &c., of another or others.—3. One who watches the conduct of others. These wretched *spies* of wit. *Dryden.*

**SPY**, *v. t.* To see; to gain sight of; to discover at a distance, or in a state of concealment. It is the same as *espy*; as, to *spy* land from the mast-head of a ship. As tiger *spied* two gentle fawns. *Milton.*

One, in reading, skipped over all sentences where he *spied* a note of admiration. *Swift.*

2. To gain a knowledge of by artifice; to discover by close search or examination; as, a lawyer in examining the pleadings in a case, *spies* a defect.—3. To explore; to view, inspect and examine secretly, as a country; usually with *out*.

Moses sent to *spy* out Jaazer, and they took the villages thereof; Num. xxi.

**SPY**, *v. i.* To search narrowly; to scrutinize.

It is my nature's plague To *spy* into abuse. *Shak.*

**SPY'-BOAT**, *n.* [*spy* and *boat*.] A boat sent to make discoveries and bring intelligence.

**SPY'-GLASS**, *n.* The popular name of a small telescope, useful in viewing distant objects.

**SPY'ISM**, *n.* The act or business of spying.

**SQUAB**, *a.* [*In G. quappe* is a quab, an eelpout; *quabbelig*, plump, sleek; *quabbeln*, to be plump or sleek, and to vibrate, Eng. to wabble; Dan. *quabbe*, an eelpout; *quopped*, fat, plump, jolly, our vulgar *whopping*; *quopper*, to shake.] 1. Fat; thick; plump; bulky. Nor the *squab* daughter, nor the wife, were nice. *Betterton.*

2. Unfledged; unfeathered; as, a *squab* pigeon.

**SQUAB**, *n.* A young pigeon or dove.

2. A kind of sofa or couch; a stuffed cushion.

**SQUAB**, *adv.* Striking at once; with a heavy fall; plump. The eagle dropped the tortoise *squab* upon a rock. [*Low and not used.*] *L'Estrange.*

**SQUAB**, *† v. i.* To fall plump; to strike at one dash, or with a heavy stroke.

**SQUAB'BISH**, } *a.* Thick; fat; heavy. **SQUAB'BY**, }

**SQUAB'BLE**, *v. i.* [We know not the origin of this word, but it seems to be from the root of *wabble*; *G. quabbeln*, to vibrate, to quake, to be sleek. See SQUAB.] 1. To contend for superiority; to scuffle; to struggle; as, two persons *squabble* in sport.—2. To contend; to wrangle; to quarrel.—3. To debate peevishly; to dispute. If there must be disputes, it is less criminal to *squabble* than to murder.—4. In *typography*, to disarrange types that have been set up; and a page is said to be *squabbled* when the letters stand much awry, and require painstaking readjustment.

**SQUAB'BLE**, *n.* A scuffle; a wrangle; a brawl; a petty quarrel.

**SQUAB'BLER**, *n.* A contentious person; a brawler.

**SQUAB'BLING**, *ppr.* Scuffling; contending; wrangling.

**SQUAB'-PIE**, *n.* [*squab* and *pie*.] A pie made of squabs or young pigeons.

**SQUAC'CO**, *n.* A species of heron.

**SQUAD**, *n.* [*Fr. escouade*.] 1. In a *military sense*, a division of a company. Companies are generally divided into three or four squads, each having a serjeant and corporal.—2. Any small party; a set of people. [*Colloq.*]

**SQUAD'RON**, *n.* [*Fr. escadron*; *It. squadra*, a squadron, a square; from *L. quadratus*, square; *quadro*, to square; allied to *quatuor*, four.] 1. In its *primary sense*, a square or square form; and hence, a square body of troops; a body drawn up in a square. So Milton has used the word. Those half rounding guards Just met, and closing stood in *squadron* joint'd. [This sense is probably obsolete, unless in poetry.]—2. The principal division of a regiment of cavalry. The number forming a squadron has varied at different times, but at present it consists of 160 men, of whom about one-sixth are not under arms. A squadron is divided into two troops, each of which is commanded by its captain, who has under him a lieutenant, and a cornet. Each regiment of cavalry consists of three or four squadrons.—3. A division of a fleet; a detachment of ships of war, employed on a particular expedition; or one third part of a naval armament.

**SQUAD'RONED**, *a.* Formed into squadrons or squares.

**SQUAL'ID**, *a.* [*L. squalidus*, from *squalo*, to be foul. Qu. *W. qual*, vile.] Foul; filthy; extremely dirty. Uncomb'd his locks, and *squalid* his attire. *Dryden.*

**SQUAL'IDÆ**, *n.* A family of chondropterygious fishes, which includes the various species of sharks. The type of this family is the genus *squalus*, Linn., or true sharks. [See SHARK.]

**SQUALIDITY**, } *n.* Foulness; filthy-SQUAL'IDNESS, } ness.

**SQUAL'IDLY**, *adv.* In a squalid, filthy manner.

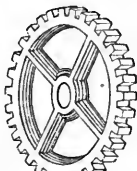

Spur-Wheel.

**SQUALL**, *v. i.* [*Sw. squåla*; *Dan. squaldrer*, to prate. These words are probably of one family; but *squall*, like *squal*, is probably from the root of *Sax. gyllan*, to creak, or *Heb. שָׁקַק*, *kol*, *D. gillen*, to yell; or is formed from *wail*.] To cry out; to scream or cry violently; as a woman frightened, or a child in anger or distress; as, the infant *squaled*.

**SQUALL**, *n.* A loud scream; a harsh cry.—2. [*Sw. squal*.] The sea term for a gust of wind; or for a short temporary increase in the force of the wind.—*A black squall*, one attended with a dark cloud, diminishing the usual quantity of light.—*A white squall*, one which produces no diminution of light.—*A thick squall*, one accompanied with hail, sleet, &c.

**SQUALLER**, *n.* A screamer; one that cries loud.

**SQUALLING**, *ppr.* Crying out harshly; screaming.

**SQUALLY**, *a.* Abounding with squalls; disturbed often with sudden and violent gusts of wind; as, *squally* weather.

**SQUALOID**, *a.* [*L. squalus*, a shark, and *Gr. ὄμορ*, likeness.] Like a shark, or resembling a shark. The squaloid division of fossil fishes, or those which resemble sharks, are found in the tertiary strata.

**SQUALOR**, *n.* [*L.*] Foulness; filthiness; coarseness.

**SQUALUS**, *n.* The name given by Linn., to the genus of fishes, commonly called sharks, as the white shark, the basking shark, spotted shark, &c. [*See SHARK.*]

**SQUAMA**, *n. plur. Squamæ.* [*L. a scale.*] In *bot.*, the bractæe of an amentum or catkin. The term is applied to parts which are arranged upon a plant, in the same manner as the scales of fishes and other animals; as the undeveloped external leaves of the buds of most plants.—2. In *anat.*, an opaque and thickened lamina of the cuticle.

**SQUAMIFORM**, *a.* [*L. squama*, a scale, and *form.*] Having the form or shape of scales.

**SQUAMIGEROUS**, *a.* [*L. squamiger*; *squama*, a scale, and *gero*, to bear.] Bearing or having scales.

**SQUAMPENNES**, *n.* [*L. squama*, a scale, and *penna*, a wing or fin.] A family of acanthopterygious fishes, so named on account of their fins being covered with scales, not only on the parts which have soft rays, but frequently also on those that have spinous ones. They were all included by Linnæus in the genus *Chætodon*. They are chiefly small fishes, abundant in the seas of hot climates, and of the most beautiful colours. They frequent rocky shores, and their flesh is, generally speaking, very wholesome and palatable.

**SQUAMOUS**, or **SQUAMOSE**, *a.* [*L. squamosus.*] Scaly; covered with scales; as, the *squamous* cones of the pine. *Squamous bulb*, a bulb in which the outer scales are distinct, fleshy, and imbricated, like the inner scales; as, in the white and orange lilies.—*Squamous bones*, in *anat.*, the bones of the skull behind the ear, so called because they lie over each other like scales.—*Squamous suture*, the suture which connects the squamose portion of the temporal bone with the parietal.

**SQUAMULÆ**, *n.* [*L. diminutive of squama.*] In *bot.*, the minute scales in the flower of a grass.

**SQUANDER**, *v. t.* [*G. verschwenden*,

probably from *wenden*, to turn.] 1. To spend lavishly or profusely; to spend prodigally; to dissipate; to waste without economy or judgment; as, to *squander* an estate.

They often *squandered*, but they never gave.

The crime of *squandering* health is equal to the folly. *Savage.*  
*Rambler.*

2. To scatter; to disperse. Our *squandered* troops he rallies. *Dryden.* [*In this application not now used.*]

**SQUANDERED**, *pp.* Spent lavishly and without necessity or use; wasted; dissipated, as property.

**SQUANDERER**, *n.* One who spends his money prodigally, without necessity or use; a spendthrift; a prodigal; a waster; a lavisher.

**SQUANDERING**, *ppr.* Spending lavishly; wasting.

**SQUANDERINGLY**, *adv.* By squandering.

**SQUARE**, *a.* [*W. cwâr*; *Fr. carré*, *quarré*; perhaps *Gr. τετραγωνος*, contracted from *τετραγωνος*. This is probably not a contraction of *L. quadratus*.] 1. Having four equal sides and four right angles; as, a *square* room; a *square* figure.—2. Forming a right angle; as, an instrument for striking lines *square*.—3. Parallel; exactly suitable; true.

She's a most triumphant lady, if report be *square* to her. [*Unusual.*] *Shak.*

4. Having a straight front; or a frame formed with straight lines; not curving; as, a man of a *square* frame; a *square* built man.—5. That does equal justice; exact; fair; honest; as, *square* dealing.—6. Even; leaving no balance. Let us make or leave the accounts *square*.—*Three square*, *five square*, having three or five equal sides, &c.; an abusive use of *square*.—*Square measures*, the squares of lineal measures, as a *square* inch; a *square* foot, a *square* yard, &c.—*Square number*, the product of a number multiplied into itself. Thus the squares of the natural numbers, 1, 2, 3, 4, 5, &c. are respectively, 1, 4, 9, 16, 25, &c.—*Square root*. In *arith.* and *alge.*, the square root of a number or quantity, is that which being multiplied into itself produces the given number or quantity. Thus 8 is the square root of 64, for  $8 \times 8 = 64$ ;  $\frac{2}{3}$  is the square root of  $\frac{4}{9}$ , for  $\frac{2}{3} \times \frac{2}{3} = \frac{4}{9}$ . Also  $x^2$  is the square root of  $x^4$ , for  $x^2 \times x^2 = x^4$ ;  $a + x$  is the square root of  $a^2 + 2ax + x^2$ , for  $(a + x) \times (a + x) = a^2 + 2ax + x^2$ . When a given number or quantity is not an exact square, its square root can only be found by approximation. Thus the square root of 2 is 1.41421, &c.—In *seamen's language*, the yards are square, when they are arranged at right angles with the mast or the keel. When the yards hang at right angles to the masts, they are said to be *square* by the lifts; when they hang perpendicularly to the ship's length, they are said to be *square* by the braces; but when they lie in a direction perpendicular to the plane of the keel, they are said to be *square* by the lifts and braces. The yards are said to be *very square*, when they are of extraordinary length, and the same epithet is then applied to their sails with respect to their breadth.

*Square shoot*, in *arch.*, a wooden trough for discharging water from a building. *Square staff*, a piece of wood placed at the external angle of a projection in a room to secure the angle, which if of plaster, would be liable to be broken,

and at the same time to allow a good finish for the papering.—*Square stem*, in *bot.*, a stem with four sides, as in peppermint.

**SQUARE**, *n.* In *geom.*, a four-sided plane rectilinear figure, having all its sides equal, and all its angles right angles.—2. In *arch.*, a mass of buildings in the form of a square, or the area enclosed by them.—3. The content of the side of a figure squared.—4. Among *carpenters, joiners, &c.*, an instrument consisting of two rules or branches fastened perpendicularly at one end of their extremities so as to form a right angle. It is used for measuring and describing right angles and perpendiculars, and also for trying up wood. When one ruler joins the other in the middle in the form of a T, it is called a *T square*.—5. In *arith.* and *alge.*, the number or quantity produced by multiplying a number or quantity by itself. Thus 64 is the square of 8, for  $8 \times 8 = 64$ .—6. Rule; regularity; exact proportion; justness of workmanship and conduct.

They of Galatia much more out of *square*.

*Hooker.*

I have not kept my *square*. [*Not in use.*]

*Shak.*

7. In *military tactics*, a body of infantry formed into a square. This is done on critical occasions, particularly to resist the charge of cavalry. The square is either *solid*, *hollow*, or *oblong*.—8. † A quaternion; four.—9. Level; equality. We live not on the *square* with such as these. *Dryden.*

10. † In *astrol.*, quartile, the position of planets distant ninety degrees from each other.—11. Rule; conformity; accord. I shall break no *squares* with another for a trifle.—*Geometrical square*, a quadrant,—*which see.*—*Magic square*. [*See MAGIC.*]—*Square of an anchor*, the upper part of the shank of an anchor.—*Square of flooring*, a measure of 100 superficial feet.—*Squares go*. Let us see how the *squares go*, that is, how the game proceeds; a phrase taken from the game of chess, the chess board being formed with squares.

**SQUARE**, *v. t.* [*Fr. equarrir* and *carrer.*]

1. To form with four equal sides and four right angles.—2. To reduce to a square; to form to right angles; as, to *square* masons' or carpenters' work.—3. To reduce to any given measure or standard.—4. To adjust; to regulate; to mould; to shape; as, to *square* our actions by the opinions of others; to *square* our lives by the precepts of the gospel.—5. To accommodate; to fit; as, *square* my trial to my strength.—6. To respect in quartile.—7. To make even, so as to leave no difference or balance; as, to *square* accounts; a *popular phrase*.—8. In *arith.*, to multiply a number by itself; as, to *square* the number.—9. In *seamen's language*, to *square the yards*, is to place them at right angles with the mast or keel.

**SQUARE**, *v. i.* To suit; to fit; to quadrate; to accord or agree. His opinions do not *square* with the doctrines of philosophers.—2. To quarrel; to go to opposite sides; to take an attitude of offence or defence.

Are you such fools

To *square* for this? *Shak.*

3. To take the attitudes of a boxer.

**SQUARED**, *pp.* or *a.* Made in the form of a square, or with right angles; adjusted; regulated; multiplied by itself.

**SQUAREFRAMED.** In *joinery*, a work is said to be square framed, or framed square, when the framing has all the angles of its styles, rails, and mountings square without being moulded.

**SQUARELY.** *adv.* In a square form.

**SQUARENESS.** *n.* The state of being square; as, an instrument to try the squareness of work.

**SQUARER.** *† n.* A hot headed contentious fellow.

Is there no young squarer now. *Shak.*

2. One who squares his elbows for fighting; a sparrer. [*Scotch.*]

**SQUARE-RIGGED.** *a.* In *seamen's language*, a vessel is square-rigged when her principal sails are extended by yards suspended by the middle, and not by stays, gaffs, booms, and lateen yards. Thus a ship and a brig are square-rigged vessels.

**SQUARE-SAIL.** *n.* Any sail extended to a yard suspended by the middle, and hanging parallel to the horizon, as distinguished from other sails which are extended obliquely. *Square sail*, is also the name of a sloop's or cutter's sail, which hauls out to the lower yard, called the square-sail-yard, square-sail-boom, a boom lashed across the deck of a vessel with one mast, and used to spread the foot of the square sail.

**SQUARING.** *n.* The act of forming a square; the act of reducing to a square or forming to right angles; the act of adjusting, regulating, &c.—*Squaring a handrail*, in *arch.*, the method of cutting a plank for a rail to a staircase, so that all the vertical sections may be rectangular.—*Squaring a piece of stuff*, the act of trying by the square in order to make the angles right angles.—*Squaring the circle*. [See **QUADRATURE**.]

**SQUARING.** *ppr.* or *n.* Making in the form of a square, or with right angles; adjusting; regulating; multiplying by itself.

**SQUARROUS.** *a.* [*Qu.* Gr. *σκαρρος*, *SCUARR*, *ROSE*,] scurf.] In *bot.*, ragged, or full of loose scales; rough; jagged. A squarrous calyx consists of scales very widely divaricating; a squarrous leaf is divided into shreds or jags, raised above the plane of the leaf, and not parallel to it.—2. In *conchology*, consisting of scales spreading every way, or standing upright, or at right angles to the surface.

**SQUASH.** *v. i.* [from the root of *quash*, *L. quasso*, *Fr. casser*.] To crush; to beat or press into pulp or a flat mass.

**SQUASH.** *n.* Something soft and easily crushed.—2. [*Qu.* Gr. *κισκου*.] A plant of the genus *Cucurbita*, the *C. melopepo*, and its fruit; cultivated in America as an article of food. [See **GOUBD**.]—3. Something unripe or soft; in contempt.

This squash, this gentleman. *Shak.*

4. A sudden fall of a heavy soft body.

—5. A shock of soft bodies.

My fall was stopp'd by a terrible squash. [*Vulgar.*] *Swift*

**SQUASHY.** *adv.* Like a squash; also muddy.

**SQUAT.** *v. i.* [*W. yswatiaw*, from *yswad*, a falling or throw; *It. quatto*, squat, close; *quattare*, to squat, to cower, to lurk. It may perhaps be allied to *It. guattare*, to watch, *Fr. guetter*, to wait, to watch.] 1. To sit down upon the hams or heels; as a human being.—2. To sit close to the ground; to cower; as an animal.—3. In the *United States*, to settle on another's land without

pretence of title; a practice very common in the wilderness.—4. To stoop or lie close to escape observation, as a partridge or rabbit.

**SQUAT.** *† v. i.* To bruise or make flat by a fall.

**SQUAT.** *a.* Sitting on the hams or heels; sitting close to the ground; cowering.

Him there they found,

Squat like a toad, close at the ear of Eve. *Milton.*

2. Short and thick, like the figure of an animal squatting.

The head of the squill insect is broad and squat. *Grew.*

**SQUAT.** *n.* The posture of one that sits on his hams, or close to the ground.—2. *†* A sudden or crushing fall.—3. A sort of mineral, which consists of tin ore and spar.

**SQUATT.** *n.* Among *miners*, a bed of **SQUAT.** } ore extending but a little distance.

**SQUATTER.** *n.* One that squats or sits close.—2. In *America*, one that settles on new land without a title.

**SQUAW.** *n.* Among some tribes of *American Indians*, a female or wife.

**SQUEAK.** *v. i.* [*Sw. sqvika*, to cry like a frog; *G. quieken*; *W. gwiqian*, to squeak. This word probably belongs to the family of *quack*.] 1. To utter a sharp, shrill cry, usually of short duration; to cry with an acute tone, as an animal; or to make a sharp noise, as a pipe or reed, a wheel, a door and the like. Wheels squeak only when the axle-tree is dry.

Who can endure to hear one of the rough old Romans squeaking through the mouth of an eunuch? *Addison.*

Zoilus calls the companions of Ulysses the squeaking pigs of Homer. *Pope.*

2. To break silence or secrecy for fear or pain; to speak.

**SQUEAK.** *n.* A sharp shrill sound suddenly uttered, either of the human voice or of any animal or instrument, such as a child utters in acute pain, or as pigs utter, or as is made by carriage wheels when dry, or by a pipe or reed.

**SQUEAKER.** *n.* One that utters a sharp shrill sound.—2. A pigeon under six months of age.

**SQUEAKING.** *ppr.* Crying with a sharp voice; making a sharp sound; as, a squeaking wheel.

**SQUEAL.** *v. i.* [This is only a different orthography of *squall*; *Ir. sgal*, a squealing. See **SQUALL**.] To cry with a sharp shrill voice. It is used of animals only, and chiefly of swine. It agrees in sense with *squeak*, except that *squeal* denotes a more continued cry than *squeak*, which is not limited to animals. We say, a squealing hog or pig, a squealing child; but more generally a *squalling* child.

**SQUEALING.** *ppr.* Uttering a sharp, shrill sound or voice; as, a squealing pig.

**SQUEAMISH.** *a.* [probably from the root of *wamble*.] Literally, having a stomach that is easily turned, or that readily nauseates any thing; hence, nice to excess in taste; fastidious; easily disgusted; apt to be offended at trifling improprieties; scrupulous.

Quoth he, that honour's very squeamish That takes a basting for a biemish. *Hudibras.*

His muse is rustic, and perhaps too plain The men of squeamish taste to entertain. *Southern.*

**SQUEAMISHLY.** *adv.* In a fastidious manner; with too much niceness.

**SQUEAMISHNESS.** *n.* Excessive niceness; vicious delicacy of taste; fastidiousness; excessive scrupulousness.

The thorough-paced politician must presently laugh at the squeamishness of his conscience. *South.*

**SQUEASINESS.** *† n.* Nausea. [See **QUEASINESS**.]

**SQUEASY.** *† a.* Queasy; nice; squeamish; scrupulous. [See **QUEASY**.]

**SQUEEZ'ABLE.** *a.* That may be squeezed.—2. In a figurative sense, that may be constrained; as a squeezeable government. [*Colloquial*.]

**SQUEEZE.** *v. i.* [*Arm. quasqu*, *goasca*; *W. gwasygu*.] 1. To press between two bodies; to press closely; as, to squeeze an orange with the fingers or with an instrument; to squeeze the hand in friendship.—2. To oppress with hardships, burdens, and taxes; to harass; to crush.

In a civil war, people must expect to be squeezed with the burden. *L'Estrange.*

3. To hug; to embrace closely.—4. To force between close bodies; to compel or cause to pass; as, to squeeze water through felt.—To squeeze out, to force out by pressure, as a liquid.

**SQUEEZE.** *v. i.* To press; to urge one's way; to pass by pressing; as, to squeeze hard to get through a crowd.—2. To crowd.—To squeeze through, to pass through by pressing and urging forward.

**SQUEEZE.** *n.* Pressure; compression between bodies.—2. A close hug or embrace.

**SQUEEZED.** *pp.* Pressed between bodies; compressed; oppressed.

**SQUEEZERS.** *n.* In the *iron manufacture*, a machine sometimes employed for shingling, or expressing the scoriae from the puddled balls. Its action resembles that of a huge pair of pliers worked by the machinery of the mill.

**SQUEEZING.** *ppr.* Pressing; compressing; crowding; oppressing.

**SQUEEZING.** *n.* The act of pressing; compression; oppression.—2. That which is forced out by pressure; dregs.

The dregs and squeezings of the brain. *Pope.*

**SQUELCH.** *† v. i.* To crush; to destroy. **SQUELCH.** *† n.* A flat heavy fall.

**SQUIB.** *n.* [This word probably belongs to the family of *whip*; denoting that which is thrown.] 1. A little pipe or hollow cylinder of paper, filled with powder or combustible matter and sent into the air, burning and bursting with a crack; a cracker. Lampons, like squibs, may make a present blaze. *Waller.*

The making and selling of squibs is punishable. *Blackstone.*

2. A sarcastic speech or little censorious writing published; a petty lampoon.—3. *†* A pretty fellow.

The squibs, in the common phrase, are called libellers. *Tatler.*

**SQUIB.** *v. i.* To throw squibs; to utter sarcastic or severe reflections; to contend in petty dispute; as, two members of a society squib a little in debate. [*Colloquial*.]

**SQUID.** *n.* A name given by sailors especially to cuttle-fishes.

**SQUILL.** *n.* [*Fr. squille*, *L. squilla*, a squill, a lobster or prawn; *It. squilla*, a squill, a sea-onion, a little bell; *squillare*, to ring; *Sp. esquila*, a small bell, a shrimp.] 1. Scilla, a genus of plants, nat. order Liliacæ; but the term squill

is more particularly applied to the *Scilla maritima*, or sea-onion, which



Squill (*Scilla maritima*).

has a large acrid bulbous root like an onion. It is common on the sandy shores of the Mediterranean, Portugal, and the Levant. The bulb has been known as a medicine from the earliest ages; it is still held in great estimation, and is of very frequent use. It acts as an emetic, purgative, expectorant, or diuretic, in proportion to the dose in which it is given. [See *SCILLA*.]—2. A stomapodous crustaceous animal, of the genus *Squilla*. [See *SQUILLA*.]—3. An insect, called squill insect from its resemblance to the preceding, having a long body covered with a crust, the head broad and squat. **SQUILLA**, *n.* A genus of crustaceous animals, order Stomapoda, and a division of the genus Cancer, having the body long and semi-cylindric, somewhat resembling that of a lobster. The shell consists of a single shield of an elongated quadrilateral form, covering the head, the antennæ and eyes excepted, which are placed on a common anterior articulation. The eyes are placed on very short footstalks. The species are chiefly inhabitants of the seas of warm climates.

**SQUIN'ANCY**, † *n.* [It *squinanzia*; Fr. *squinancie*; L. *cynanche*; Gr. *κυνανχη*.] The quinsy,—which see.

**SQUIN'ANCY**, *n.* A British plant of the genus *Asperula*, the *A. cynanchica*, called also squinancy wort, and small woodruff. It is a perennial plant with white flowers in terminal panicles, and grows on dry banks. [See *WOODRUFF*.]

**SQUINCH**, or **SCONCE**, *n.* [See *SCONCE*.] In *arch.*, the small penden-

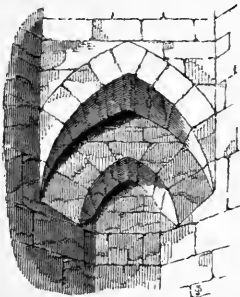

Squinch, Maxstoke Priory, Warwickshire.

tive arch formed across the angle of a square tower to support the side of a

superimposed octagon. The application of the term to these pendentives may have been suggested by their resemblance to a corner cupboard, which was also called a squinch or sconce. **SQUINT**, *a.* [D. *schuin*, oblique, sloping; *schuinte*, a slope; W. *ysgeiniaw*, to spread, to sprinkle, to squint, from *ysgain* to spread, to sprinkle. We see the sense is to deviate from a direct line, to wander or shoot off.] 1. Looking obliquely.—2. Optic axes of both eyes not coinciding; occasioned by a permanent shortening of one of the lateral straight muscles, and a permanent elongation of its antagonist.—3. Looking with suspicion.

**SQUINT**, *v. i.* To see obliquely; to look with the eyes differently directed.

Some can *squint* when they will. *Bacon*.

2. To have the axes of the eyes not coincident.—3. To slope; to deviate from a true line; to run obliquely.

**SQUINT**, *v. t.* To turn the eye to an oblique position; as, to *squint* an eye. 2. To look with non-coincident optic axes.

He gives the web and the pin, *squint*'s the eye, and makes the hare-lip. *Shak.*

**SQUINT**, *n.* An oblique look; an affection of the eyes in which the optic axes do not coincide; the act or habit of squinting; as, one that has a *squint*.— In *arch.*, a name given to oblique openings in the walls of a church; in mediæval architecture, they were generally so placed as to afford a view of the high altar from the transept or aisles.

**SQUINT-EYE**, *n.* An eye that squints. **SQUINT-EYED**, *a.* Having eyes that squint; having eyes with non-coincident axes.—2. Oblique; indirect; malignant; as, *squint-eyed* praise.—3. Looking obliquely or by side glances; as, *squint-eyed* jealousy or envy.

**SQUINTIF'GO**, *n.* Squinting. **SQUINTIF'BUS**, *n.* One who squints. [Cant words, and not to be used.]

**SQUINT'ING**, *ppr.* Seeing or looking with non-coincident axes of the eyes; looking by side glances.

**SQUINT'ING**, *n.* The act or habit of looking squint; strabismus,—which see.

**SQUINT'INGLY**, *adv.* With squint look; by side glances.

**SQUINT QUOIN**, *n.* In *arch.*, an external oblique angle.

**SQUIN'Y**, *v. i.* To look squint. [A cant word, not to be used.]

**SQUIR**, or **SQUIRR**, † *v. t.* [Sax. *seyran*, to cut, to divide.] To throw; to thrust; to drive; to cut along; to cause to cut along; to move, as any thing cutting through the air.

**SQUIRE**, *n.* [a popular contraction of *esquire*. See *ESQUIRE*.] 1. The title of a gentleman, next in rank to a knight.—2. An attendant on a noble warrior.—3. † An attendant at court.

—4. In the *United States*, the title of magistrates and lawyers.—In *New England*, it is particularly given to justices of the peace and judges; and in *Pennsylvania*, to justices of the peace only.—5. The title customarily given to country gentlemen.—6. A familiar name for a male companion; as, do not deprive her of her *squire*.

**SQUIRE**, *v. t.* To attend as a squire.—2. In *collog. lan.*, to attend as a beau or gallant for aid and protection; as, to *squire* a lady to the gardens.

**SQUIREARCHY**, *n.* A contemptuous term for the domination or political

influence exercised by squires considered as a body.

**SQUIREHOOD**, } *n.* The rank and state

**SQUIRESHIP**, } of a squire.

**SQUIRELY**, *a.* Becoming a squire.

**SQUIRESHIP**, *n.* Office of a squire.

**SQUIRM**, *v. t. or i.* (squirm.) To move like a worm or eel, with writhing or contortions. [Local.]

**SQUIRM**. See *SWARM*.

**SQUIR'REL**, *n.* (squirrel.) [Fr. *écureuil*; L. *sciurus*; Gr. *σκίουρος*, a compound of *σκια*, shade, and *ουρα*, tail.]

A small rodent mammal. The squirrels are formed into a family, *Sciuridae*, the type of which is the genus *Sciurus*, Linn., or true squirrels. This family comprehends three groups; the true squirrels (*Sciurus*), the ground squirrels (*Tamias*), and the flying squirrels (*Pteromys*). The true squirrels are distinguished by their strongly compressed inferior incisors, and by their long bushy tail. They have four toes before, and five behind. The thumb of the fore foot is sometimes marked



Common Squirrel (*Sciurus vulgaris*).

by a tubercle. They have in all four grinders, variously tuberculated, and a very small additional one above in front, that very soon falls. The head is large, and the eyes projecting and lively. Several species are enumerated, as the common squirrel, which inhabits Europe and the north of Asia; the cat-squirrel, and grey squirrel, both American species. These animals are remarkably nimble, running up trees and leaping from branch to branch with surprising agility. They subsist on nuts, of which they lay up a store for winter, some of them in hollow trees, others in the earth. Their flesh is delicate food.

**SQUIR'REL-FISH**, *n.* A sort of perch. **SQUIR'REL-HUNT**, *n.* In *America*, the hunting and shooting of squirrels by a company of men.

**SQUIRT**, *v. t.* (squirt.) [from *squir*,—which see.] To eject or drive out of a narrow pipe or orifice, in a stream; as, to *squirt* water.

**SQUIRT**; † *v. t.* To throw out words; to let fly.

**SQUIRT**, *n.* An instrument with which a liquid is ejected in a stream with force; a syringe.—2. A small quick stream.

**SQUIRT'ER**, *n.* One that squirts. [This word, in all its forms, is vulgar.]

**SQUIRT'ING CUCUMBER**, one of the popular names of the fruit of *Ecballium Elaterium*, which, when nearly ripe, separates suddenly from its peduncle, at the same time ejecting its juices and seeds.

**SRAD'HA**, or **SHRADDA**, *n.* In *East Indies*, obsequies paid by the Hindoos



to the manes of deceased ancestors, to effect, by means of oblations, the re-embodiment of the soul of the deceased after burning his corpse, and to raise his shade from this world up to heaven, and then deify him, as it were, among the manes of departed ancestors.

**STAB, v. t.** [This word contains the elements and is probably from the primary sense of the *L. stabilitis, stabilio, stipo*, D. *stippen*, to point or prick, Eng. *stiff*, and a multitude of others in many languages. The radical sense is to thrust; but we know not to what Oriental roots they are allied, unless to the Heb. *צָבַר, yatzab*, Ar. *watataba*.]  
1. To pierce with a pointed weapon; as, to be *stabbed* by a dagger or spear; to *stab* fish or eels.—2. To wound mischievously or mortally; to kill by the thrust of a pointed instrument.—3. To injure secretly or by malicious falsehood or slander; as, to *stab* reputation.  
**STAB, v. i.** To give a wound with a pointed weapon.

None shall dare

With shorten'd sword to *stab* in closer war.  
*Dryden.*

2. To give a mortal wound.  
He speaks poniards, and every word *stabs*.  
*Shak.*

To *stab* at, to offer a stab; to thrust a pointed weapon at.

**STAB, n.** The thrust of a pointed weapon.—2. A wound with a sharp pointed weapon; as, to fall by the *stab* of an assassin.—3. An injury given in the dark; a sly mischief; as, a *stab* given to character.

**STABAT MA'TER DOLOROSA.** The first words of a celebrated hymn of the Roman Catholic church, which has been set to music by nearly all the greatest composers. The *stabat mater* is performed in the ecclesiastical services of the Roman Catholic church during Holy week.

**STAB'BED, pp.** Pierced with a pointed weapon; killed with a spear or other pointed instrument.

**STAB'BER, n.** One that stabs; a privy murderer.—2. In *sail-making*, an instrument similar to a pricker, only it is triangular instead of square.

**STAB'BING, ppr.** Piercing with a pointed weapon; killing with a pointed instrument by piercing the body.

**STAB'BING, n.** Piercing with a pointed weapon; wounding or killing with a pointed instrument.

This statute was made on account of the frequent quarrels and *stabblings* with short daggers.  
*Blackstone.*

**STAB'BINGLY, adv.** With intent to do a secret act maliciously.

**STABIL'IMENT, n.** [*L. stabilimentum*, from *stabilio*, to make firm. See **STAB.**] Act of making firm; firm support.

They serve for *stabiliment*, propagation, and shade.  
*Derham.*

**STABIL'ITATE, v. t.** To make stable; to establish.

**STABIL'ITY, n.** [*L. stabilitas*, from *stabilis*. See **STAB.**] 1. Steadiness; stability; firmness; strength to stand without being moved or overthrown; as, the *stability* of a throne; the *stability* of a constitution of government; the *stability* of an edifice or other erection; the *stability* of a system. [See **STABLE.**]—2. Steadiness or firmness of character; firmness of resolution or purpose; the qualities opposite to *fickleness, irresolution, or inconstancy*. We say, a man of little *stability*, or

of unusual *stability*.—3.† Fixedness; as opposed to *fluidity*.

Since fluidness and *stability* are contrary qualities.  
*Boyle.*

**STAB'LE, a.** [*L. stabilis*; Fr. *stable*; It. *stabile*. The primary sense is set, fixed. See **STAB.**] 1. Fixed; firmly established; not to be easily moved, shaken, or overthrown; as, a *stable* government; a *stable* body. In *physics*, a system, whether nominally in a state of rest or motion, is said to be *stable*, when any disturbance in the state of any of its parts would produce only oscillations, or temporary alterations, in the condition of the system, without permanently affecting its normal or uniform character.—*Stable and unstable equilibrium.* [See **EQUILIBRIUM.**]—2. Steady in purpose; constant; firm in resolution; not easily diverted from a purpose; not fickle or wavering; as, a *stable* man; a *stable* character.—3. Fixed; steady; firm; not easily surrendered or abandoned; as, a man of *stable* principles.—4. Durable; not subject to be overthrown or changed.

In this region of chance and vanity, where nothing is *stable*.  
*Rogers.*

**STAB'LE, v. t.** To fix; to establish.

**STAB'LE, n.** [*L. stabulum*, that is, a stand, a fixed place, like *stall*. See the latter. These words do not primarily imply a *covering* for horses or cattle.] A building constructed for horses to lodge and feed in, and furnished with stalls, and proper contrivances to contain their food, and necessary equipments. Houses for cattle are also sometimes called *stables*.

If your husband have *stables* enough, you'll look he shall lack no barns.  
*Shak.*

**STAB'LE, v. t.** To put or keep in a stable.

**STAB'LE, v. i.** To dwell or lodge in a stable; to dwell in an enclosed place; to kennel.

**STAB'LE-BOY, } n.** A boy or man  
**STAB'LE-MAN, }** who attends at a stable.

**STAB'LED, pp.** Put or kept in a stable.  
**STAB'LE-KEEPER, n.** One who stables horses. [The term *livery stable-keeper*, is more in use than the preceding.]

**STAB'LENESS, n.** Fixedness; firmness of position or establishment; strength to stand; stability; as, the *stability* of a throne or of a system of laws.—2. Steadiness; constancy; firmness of purpose; stability; as, *stability* of character, of mind, of principles, or opinions.

**STAB'LER, n.** A stable-keeper; one who stables horses. [*Local.*]

**STAB'LE-ROOM, n.** Room in a stable; room for stables.

**STAB'LE-STAND, n.** [*stable* and *stand*.] In *old English law*, when a man is found at his standing in the forest with a cross bow bent, ready to shoot at a deer, or with a long bow; or standing close by a tree with greyhounds in a leash ready to slip. This is one of the four presumptions that a man intends stealing the king's deer.

**STAB'LING, ppr.** Putting or keeping in a stable.

**STAB'LING, n.** The act or practice of keeping in a stable.—2. A house for keeping horses.

**STAB'LISH, v. t.** [*L. stabilio*; Fr. *établir*. See **STAB.**] To fix; to settle in a state for permanence; to make firm. [In lieu of this, *establish* is now always used.]

**STA'BLY, adv.** Firmly; fixedly; steadily; as, a government *stably* settled.

**STABULATION, n.** Act of housing beasts.

**STACCA'TO.** In *music*, a term denoting that the notes to which it is affixed, are to be performed in a distinct or detached manner.

**STA'CHYS, n.** A genus of plants belonging to the nat. order Labiatae or Lamiaceae. The species are very numerous. They are herbs or undershrubs, with their flowers arranged in whorls. The majority of them are European plants; of which six species belong to Britain, known under the name of wound-wort. The most beautiful species of the genus is *S. coccinea*, a native of Chili and Peru. It has large dark scarlet flowers an inch in length.

**STACK, n.** [*W. ystae*, a stack; *ystaca*, a standard, from *tāp*, a state of being stuffed; Dan. *stak*, a pile of hay; Sw. *stack*; Ir. *stacadh*. It signifies that which is set, and coincides with Sax. *stac*, D. *staak*, a stake. *Stock, stag, stage*, are of the same family, or at least have the same radical sense.] 1.

Corn in the sheaf, hay, peas, straw, &c., piled up in a circular or rectangular form coming to a point or ridge at the top, and thatched to protect it from the influence of the weather. This word is sometimes applied to a pile of wood containing 108 cubic feet, and also to a pile of poles.

Against every pillar was a *stack* of billets above a man's height.  
*Bacon.*

2. A number of funnels or chimneys standing together. We say, a *stack* of chimneys; but we also call the whole *stack* a chimney. Thus we say, the *chimney* rises ten feet above the roof.

**STACK, v. t.** To lay in a conical or other pile; to make into a large pile; as, to *stack* hay or grain.—2. To pile wood, poles, &c.—In *milit. lan.*, to *stack arms*, is to set up muskets together, with the bayonets crossing each other, and forming a sort of conical pile.

**STACK-BORER, n.** An instrument for piercing stacks of hay, to admit air, where the hay has acquired a dangerous degree of heat.

**STACK-COVER, n.** A cloth or canvas covering for suspending over stacks, during the time of their being built, to protect them from rain.

**STACK'ED, pp.** Piled in a large conical heap.

**STACK'ET, n.** A stockade.

**STACK-FUNNEL, n.** A pyramidal open frame of wood in the centre of a stack. Its object is to allow the air to circulate through the stack, and prevent the heating of the grain.

**STACK-GUARD, n.** A canvas covering for a hay or other stack.

**STACK'ING, ppr.** Laying in a large conical heap.

**STACK'ING, n.** The operation of building or piling up unthreshed corn, hay, straw, or other dried crops in convenient forms, and so as to admit of their being thatched, as a defence from the weather. [See **STACK.**]

**STACK'ING-BAND, } n.** A band or  
**STACK'ING-BELT, }** rope used in binding thatch or straw upon a stack.

**STACK'ING-STAGE, n.** A stage used in building stacks.

**STACK-STAND, or CORN-STAND, n.** A basement of timber or masonry, sometimes of iron, raised on props and placed in a stack-yard, on which to build the stack. Its object is to keep

the lower part of the stack dry, and exclude vermin.

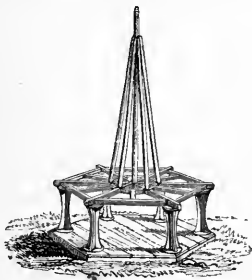

Stack-Stand with Stack-Funnel.

**STACK'-YÄRD, n.** A yard or enclosure for stacks of hay or grain.

**STAC'TE, n.** [*stacte*; Gr. *στακτιν*.] A fatty resinous liquid matter, of the nature of liquid myrrh, very odoriferous and highly valued. But it is said we have none but what is adulterated, and what is so called is liquid storax.

**STAD'DLE, n.** [D. *stutzel*, from *stut*, a prop; *stutten*, to prop; Eng. *stud*; G. *stütze*. It belongs to the root of *stead*, *steady*.] 1. Any thing which serves for support; a staff; a crutch; the frame or support of a stack of hay or grain.—2. A young tree left uncut, when others are cut down.—3. In *hay-making*, when the cocks are shaken out into separate plots in order to their drying, these plots are called *staddles*.

**STAD'DLE, v. t.** To leave staddles when a wood is cut; to form into staddles, as hay.

**STAD'DLE-ROOF, n.** The roof or covering of a stack.

**STAD'DLING, zpp.** Leaving staddles when a wood is cut.

**STAD'DIUM, n.** [L.; Gr. *σταδιον*.] A Greek measure of 125 geometrical paces; or 625 Roman feet, equal to 606 feet, 9 inches, English; consequently the Greek stadium corresponded nearly to our furlong. It was the principal Greek measure of length.—2. In *ancient arch.*, an open space in which the athletes or wrestlers, exercised running, and engaged in other gymnastic contests. It signified also the place where the public games were celebrated.

**STAD'T'HÖLDER, n.** [D. *stadt*, a city, and *houder*, holder.] Formerly, the chief magistrate of the United Provinces of Holland; or the governor or lieutenant governor of a province.

**STAD'T'HÖLDERATE, } n.** The office  
**STAD'T'HÖLDERSHIP, }** of a stadtholder.

**STÄFF, n. plur.** *Staves*, and sometimes *Staffs*. [Sax. *staf*, a stick or club, a pole, a crook, a prop or support, a letter, an epistle; *stafn*, *stefn*, the voice; D. *staf*, a staff, sceptre, or crook; *staaf*, a bar; G. *stab*, a staff, a bar, a rod; Dan. *stab*, *stav*, id., *stavn*, *stævn*, the prow of a ship, that is, a projection, that which shoots out; Fr. *douve*. The primary sense is to thrust, to shoot. See *STAB*.] 1. A stick carried in the hand for support or defence by a person walking; hence, a support; that which props or upholds. Bread is proverbially called the *staff of life*.

The boy was the very *stuff of my age*.

*Shak.*

Thy rod and thy *staff*, they comfort me;  
Ps. xxiii.

2. A stick or club used as a weapon. With forks and *staffs* the felon they pursue.

*Dryden.*

3. A long piece of wood; a stick; the long handle of an instrument; a pole or stick, used for many purposes.—4. The five parallel lines, and the four

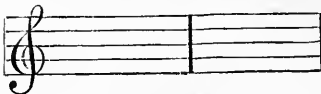

Treble Staff.

spaces between them, on which notes and other musical characters are placed.

—5. An ensign of authority; a badge of office; as, a constable's *staff*. In *Scots law*, *staff and baton* are the usual symbols of resignation, when the vassal resigns his feu into the hands of his superior.—6. The round of a ladder.—7. A light pole erected in different parts of a ship, on which to hoist and display the colours; as, the *ensign staff* for displaying the ensign; the *flag-staff* for displaying the flag, and the *jack-staff* for extending the jack. In *mast-making*, *stoffs* are short pieces by which the sets are made.—8. [Fr. *estafette*, a courier or express; It. *staffetta*, an express; *staffiere*, a groom or servant; *staffu*, a stirrup; Sp. *estafeta*, a courier, a general post-office; *estafero*, a foot-boy, a stable-boy, an errand-boy; Port. *estafeta*, an express. This word seems to be formed from It. *staffa*, a stirrup, whence *staffiere*, a stirrup-holder or groom, whence a servant or horseman sent express.] In *milit. affairs*, an establishment of officers in various departments, attached to an army, or to the commander of an army, to assist him in carrying his plans into execution. The *general-staff*, besides the commander-in-chief, his military secretaries and aides-de-camp, consists of a quarter-master general, adjutant-general, with their respective deputies, assistants, and deputy-assistants; the director-general of the medical department; and the chaplain-in-general of the forces. The staff of the ordnance department consists of the master-general, and lieutenant-general, with their deputies and assistants; the inspector of fortifications, and the director of the engineers. The staff of a regiment consists of the adjutant, quarter-master, paymaster, chaplain, and surgeon. The *staff* is the medium of communication from the commander-in-chief to every department of an army.—9. [Ice. *stef*.] A stanza; a series of verses so disposed that when it is concluded, the same order begins again.

Cowley found out that no kind of *staff* is proper for a heroic poem, as being all too lyrical. *Dryden.*

10. In *sur.*, a grooved steel instrument having a curvature, and which is introduced through the urethra into the bladder, to guide the knife or gorget in the operation of lithotomy.—11. The name of several instruments formerly used in taking the sun's altitude at sea; as the *fore-staff*, *back-staff*, *cross-staff*, &c. [See these terms.]—*Bishop's-staff*, a crosier.—*Pope's-staff*, a staff with three crosses, called also a *treble cross-staff*.—*Cardinal's-staff*, a staff with a double cross.

**STAFF'-AN'GLE, n.** In *arch.*, a square

rod of wood, standing flush with the wall on each of its sides, at the external angles of plastering, to prevent their being damaged.

**STAFF-BEAD, n.** In *arch.*, see *Angle-Bead* under *ANGLE*.

**STAFFYER, † n.** An attendant bearing a staff.

**STÄFFISH, † a.** Stiff; harsh.

**STÄFF-TREE, n.** *Celastrus*, a genus of plants, nat. order *Celastraceæ*. The species are evergreen shrubs and climbers, chiefly natives of the Cape of Good Hope. The climbing staff-tree is a native of Canada.

**STAG, n.** [This word belongs to the root of *stich*, *stage*, *stock*. The primary sense is to thrust, hence, to fix, to stay, &c.] The male red deer; the male of the hind, the *Cervus elephas*, Linn. In *stock exchange phrase*, a *stag* is a ruined speculator in railway shares. [Trivial.]

**STAG'-BEETLE, n.** The *Lucanus cervus*, a large coleopterous insect, the largest of British beetles, distinguished by the enormous size of the horny and toothed mandibles in the males, and by the rather long elbowed antennæ,

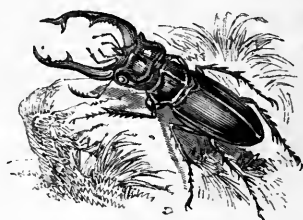

Stag-beetle (*Lucanus cervus*).

which are terminated by a perfoliated club, and are composed of ten joints, the first being very long. The stag-beetle is common in some localities in the neighbourhood of London, and is often two inches long, of a black colour. It flies at night in the heat of summer.

**STAGE, n.** [Fr. *etage*, a story, a degree; Sax. *stigan*, to go, to ascend; Dan. *stiger*, to step up, to ascend; Sw. *stiga*, to step; *steg*, a step; *stega*, a ladder; D. *stijgen*, to mount, G. *steigen*.] Properly, one step or degree of elevation, and what the French call *etage*, we call a *story*. Hence, 1. A floor or platform of any kind elevated above the ground or common surface, as for an exhibition of something to public view; as, a *stage* for a mountebank; a *stage* for speakers in public; a *stage* for mechanics. Seamen use floating *stages*, and *stages* suspended by the side of a ship, for caulking and repairing.—2. The floor on which theatrical performances are exhibited, as distinct from the *pit*, &c. Hence,—3. The theatre; the place of scenic entertainments.

Knights, squires and steeds must enter on the *stage*. *Pope*.

4. Theatrical representations. It is contended that the *stage* is a school of morality. Let it be inquired, where is the person whom the *stage* has reformed?—5. A place where anything is publicly exhibited.

When we are born, we cry that we are come To this great *stage of fools*. *Shak.*

6. Place of action or performance; as, the *stage of life*.—7. A place of rest on a journey, or where a relay of horses is taken, or where a stage coach

changes horses. When we arrive at the next stage, we will take some refreshment. Hence,—8. The distance between two places of rest on a road; as, a stage of fifteen miles.—9. A single step; degree of advance; degree of progression, either in increase or decrease, in rising or falling, or in any change of state; as, the several stages of a war; the stages of civilization or improvement; stages of growth in an animal or plant; stages of a disease, of decline or recovery; the several stages of human life.—10. [instead of stage-coach, or stage-waggon.] A coach or other carriage running regularly from one place to another for the conveyance of passengers.

I went in the six-penny stage. *Swift.*  
A parcel sent by the stage. *Cowper.*  
11. In *arch.*, the part between one spliced projection and another, in a Gothic buttress. Also the horizontal division of a window separated by transoms. Sometimes the term is used to signify a floor, a story.

STAGE, † *v. t.* To exhibit publicly.

STAGE-CARRIAGE, *n.* A carriage of any construction for conveying passengers for hire, to or from any place.

STAGE-COACH, *n.* [*stage and coach.*] A coach that runs by stages; or a coach that runs regularly every day or on stated days, for the conveyance of passengers.

STAGE-COACHMAN, *n.* A driver of a stage-coach.

STAGELY, *a.* Pertaining to a stage; becoming the theatre. [*Little used.*]

STAGE-PLAY, *n.* [*stage and play.*] Theatrical entertainment.

STAGE-PLAYER, *n.* An actor on the stage; one whose occupation is to represent characters on the stage. Garrick was a celebrated stage-player.

STA'GER, *n.* A player. [*Little used.*]  
2. One that has long acted on the stage of life; a practitioner; a person of cunning; as, an old cunning stager; an experienced stager; a stager of the wiser sort. [*Obs. or trivial.*]

STA'GERY, † *n.* Exhibition on the stage.

STAGE-WAGGON, *n.* A waggon for conveying goods and passengers, by stages, at regularly appointed times.—2. † A stage-coach.

STAG'EVLIL, *n.* A disease in horses, tetanus or locked-jaw.

STAG'GARD, *n.* [from *stag.*] A stag four years old.

STAG'GER, *v. i.* [*D. staggeren.*] 1. To reel; to vacillate; to move to one side and the other in standing or walking; not to stand or walk with steadiness. Deep was the wound; he stagger'd with the blow. *Dryden.*

2. To fail; to cease to stand firm; to begin to give way.

The enemy staggers. *Addison.*  
3. To hesitate; to begin to doubt and waver in purpose; to become less confident or determined.

Abraham staggered not at the promise of God through unbelief; Rom. iv.

STAG'GER, *v. t.* To cause to reel.—2. To cause to doubt and waver; to make to hesitate; to make less steady or confident; to shock.

Whoever will read the story of this war, will find himself much staggered. *Howell.*

When a prince fails in honour and justice, it is enough to stagger his people in their allegiance. *L'Etrange.*

STAGGER-BUSH, *n.* An American shrub.

11.

STAG'GERED, *pp.* Made to reel; made to doubt and waver.

STAG'GERING, *ppr.* or *n.* Causing to reel; to waver or to doubt; reeling; vacillating.

STAG'GERING, *n.* The act of reeling.

—2. The cause of staggering.

STAG'GERINGLY, *adv.* In a reeling manner.—2. With hesitation or doubt.

STAG'GERS, *n. plur.* A disease of horses and cattle, attended with reeling or giddiness; also, a disease of sheep, which inclines them to turn about suddenly. This disease proceeds from inflammation of the brain. In the horse it appears in two forms, a violent frantic one, and a sleepy lethargic one.—2. † Madness; wild irregular conduct.

STAG'GER-WÖRT, *n.* See RAGWORT.

STAG'-HOUND, *n.* A hound used in hunting the stag or deer.

STÄGING, *n.* A structure of posts and boards for support, as for building.

—2. The management of, or the act of travelling in, stage coaches.

STAG'MA, *n.* [Gr. *στανμα*, droppings.] In *chem.*, any distilled liquor.

STAGMÁRIA, *n.* A genus of plants, nat. order Terebinthaceæ.—*S. verniciflua* is a tree, a native of the Eastern islands, full of acrid resinous juice, which causes excoriations and blisters, if applied to the skin. The valuable black hard varnish called *Japan lacquer* is obtained from it.

STAG'NANCY, *n.* [See STAGNANT.] The state of being without motion, flow, or circulation, as in a fluid.

STAG'NANT, *a.* [*L. stagnans*, from *stagnare*, to be without a flowing motion, *It. stagnare*. Qu. *W. lagu*, to stop.]

1. Not flowing; not running in a current or stream; as, a stagnant lake or pond; stagnant blood in the veins.—2. Motionless; still; not agitated; as, water quiet and stagnant. The gloomy slumber of the stagnant soul. *Johnson.*

3. Not active; dull; not brisk; as, business is stagnant.

STAG'NANTLY, *adv.* In a still, motionless, inactive manner.

STAG'NATE, *v. i.* [*L. stagno*, *stagnum*; *It. stagnare*.] 1. To cease to flow; to be motionless; as, blood stagnates in the veins of an animal; air stagnates in a close room.—2. To cease to move; not to be agitated. Water that stagnates in a pond or reservoir soon becomes foul.—3. To cease to be brisk or active; to become dull; as, commerce stagnates; business stagnates.

STAGNA'TION, *n.* The cessation of flowing or circulation of a fluid; or the state of being without flow or circulation; the state of being motionless; as, the stagnation of the blood; the stagnation of water or air; the stagnation of vapours.—2. The cessation of action or of brisk action; the state of being dull; as, the stagnation of business.

STAG'-WÖRM, *n.* An insect that is troublesome to deer.

STAG'YRITE, or STAG'IRITE, *n.* An appellation given to Aristotle from the place of his birth, *Stagira*, in Macedonia.

STÄID, *pret.* and *pp.* of *Stay*; so written for *stayed*.—2. *a.* [from *stay*, to stop.] Sober; grave; steady; composed; regular; not wild, volatile, flighty or fanciful; as, staid wisdom.

To ride out with staid guides. *Milton.*

STÄIDNESS, *n.* Sobriety; gravity;

841

steadiness; regularity; the opposite of *wildness*.

If he sometimes appears too gay, yet a secret gracefulness of youth accompanies his writings, though the staidness and sobriety of age be wanting. *Dryden.*

STÄIN, *v. t.* [*W. ystaeniaw*, to spread over, to stain; *ystaenu*, to cover with tin; *ystaen*, that is spread out, or that is sprinkled, a *stain*, *tin*, *L. stannum*; *taen*, a spread, a sprinkle, a layer; *taenu*, to spread, expand, sprinkle, or be scattered. This coincides in elements with Gr. *σταίνω*. The French *teindre*, Sp. *teñir*, *It. tingere*, Port. *tingir*, to stain, are from the *L. tingo*, Gr. *τιγγω*, Sax. *deagan*, Eng. *dye*; a word formed by different elements. *Stain* seems to be from the Welsh, and if *taen* is not a contracted word, it has no connection with the Fr. *teindre*.]

1. To discolour by the application of foreign matter; to make foul; to spot; as, to stain the hand with dye; to stain clothes with vegetable juice; to stain paper; armour stained with blood.—

2. To dye; to tinge with a different colour; as, to stain cloth.—3. To impress with figures, in colours different from the ground; as, to stain paper for hangings.—4. To blot; to soil; to spot with guilt or infamy; to tarnish; to bring reproach on; as, to stain the character. Of honour void, of innocence, of faith, of purity,

Our wonted ornaments now soil'd and stain'd. *Milton.*

STÄIN, *n.* A spot; discoloration from foreign matter; as, a stain on a garment or cloth.—2. A natural spot of a colour different from the ground.

Swift trouts, diversified with crimson stain. *Pope.*

3. Taint of guilt; tarnish; disgrace; reproach; as, the stain of sin.

Nor death itself can wholly wash their stains. *Dryden.*

Our opinion is, I hope, without any blemish or stain of heresy. *Hooker.*

4. Cause of reproach; shame.

Hereby I will lead her that is the praise and yet the stain of all womankind. *Sidney.*

STÄINED, *pp.* or *a.* Discoloured; spotted; dyed; blotted; tarnished.—*Stained glass*, glass on which pictures have been painted with metallic oxides or chlorides, ground up with proper fluxes, and fused into its surface, at a moderate heat. Stained glass is employed in ornamenting the windows of churches, as well as of other public and private buildings. The colours produced are all transparent, and therefore can be viewed only by transmitted light.

STÄINER, *n.* One who stains, blots, or tarnishes.—2. A dyer.

STÄINING, *ppr.* Discolouring; spotting; tarnishing; dyeing.

STÄINLESS, *a.* Free from stains or spots.—2. Free from the reproach of guilt; free from sin.

STÄIR, *n.* [*D. steigen*; Sax. *stager*; from Sax. *stigan*, D. and G. *steigen*, Goth. *steigan*, to step, to go; Dan. *stiger*, to rise, to step up; Sw. *steg*, a step; Ir. *staighre*. See STAGE.] A step, but generally used in the plural to signify a succession of steps arranged as a way between two points at different heights in a building, &c. A succession of steps in a continuous line is called a flight of stairs; the termination of the flight is called a landing. Stairs are further distinguished by the various epithets, doglegged, newelled, open new-

50

elled, &c.—2. *One pair of stairs*, an expression signifying the first story or floor above the ground floor.

**STAIR-CARPET**, *n.* A carpet for covering stairs.

**STAIRCASE**, *n.* [*stair* and *case*.] The part of a building which contains the stairs. Staircases are straight or winding. The straight are called *fliers*, or direct fliers.

**STAIR-ROD**, *n.* A metallic rod for holding a stair-carpet to its place.

**STAIR**, *n.* The line of rails forming the extremity of a railway, and generally occurring near rivers, being laid down upon high platforms, for the purpose of discharging coals, &c., into the holds of ships, or receptacles prepared for them.

**STAKE**, *n.* [*Sax. stac*; *Sw. stake*; *Ir. stac*; *It. stecone*, a stake; *stecca*, a stick; *steccare*, to fence with stakes; *Sp. estaca*, a stake, a stick. This coincides with *stick*, noun and verb, with *stock, stage*, &c. The primary sense is to shoot, to thrust; hence, to set, or fix.] 1. A small piece of wood or timber, sharpened at one end and set in the ground, or prepared for setting, as a support to something. Thus *stakes* are used to support vines, to support fences, hedges, and the like. A *stake* is not to be confounded with a *post*, which is a larger piece of timber.—2. A piece of long rough wood.

A sharpen'd *stake* strong Dryas found.

Dryden.

3. A palisade, or something resembling it.—4. The piece of timber to which a martyr is fastened when he is to be burnt. Hence, to *perish at the stake*, is to die a martyr, or to die in torment. Hence,—5. Figuratively, martyrdom. The *stake* was prepared for those who were convicted of heresy.—6. That which is pledged or wagered; that which is *set, thrown down*, or *laid*, to abide the issue of a contest, to be gained by victory or lost by defeat.—

7. The state of being laid or pledged as a wager. His honour is *at stake*.—8. A small anvil to straighten cold work, or to cut and punch upon.—

*Stake-net*, in *Scotland*, a machine for the capture of salmon. It consists of a sheet of net-work, stretched upon stakes fixed into the ground, generally in rivers or friths, where the sea ebbs and flows, with contrivances for entangling and securing the fish.—*Stake and rice*, a fence composed of stakes driven into the ground, and interwoven with branches of trees retaining their spray, or with rods without their spray. The latter is frequently called a *wattled fence*.

**STAKE**, *v. t.* To fasten, support, or defend with stakes; as, to *stake* vines or plants.—2. To mark the limits by stakes; with *out*; as, to *stake out* land; to *stake out* a new road, or the ground for a canal.—3. To wager; to pledge; to put hazard upon the issue of competition, or upon a future contingency. I'll *stake* you lamb that near the fountain plays.

Pope.

4. To point or sharpen stakes.—5. To pierce with a stake.

**STAKED**, *pp.* Fastened or supported by stakes; set or marked with stakes; wagered; put to hazard.

**STAKE-HEAD**, *n.* In *rope-making*, a stake with wooden pins in the upper side to keep the strands apart.

**STAKE-HOLDER**, *n.* One with whom the bets are deposited when a wager

is laid, or when a prize-fight, &c., takes place.

**STAKING**, *ppr.* Supporting with stakes; marking with stakes; wagering; putting to hazard.—2. Sharpening; pointing.

**STALACTITE**, } *a.* [from *stalactite*.]  
**STALACTICAL**, } Pertaining to stalactite; resembling an icicle.

**STALACTIFORM**, } *a.* Like stalactite; resembling an icicle.  
**STALACTITIFORM**, } lactite; resembling an icicle.

**STALACTITE**, *n. plur. Stalac'tites*, originally *Stalact'ites*. [*Gr. σταλακτις*, *σταλακτι*, from *σταλαζω*, to drop, from *σταλαω*, *L. stillo*.] A subvariety of carbonate of lime, usually in a conical or cylindrical form, pendent from the

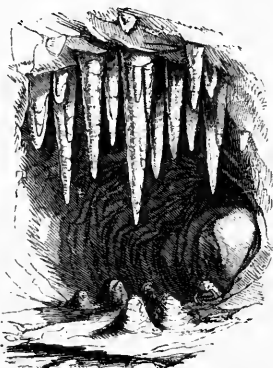

Cave with Stalactites and Stalagmites.

roofs and sides of caverns like an icicle; produced by the filtration of water containing calcareous particles, through fissures and pores of rocks.

**STALACTITIC**, or **STALACTITICAL**, *a.* In the form of stalactite, or pendent substances like icicles.

**STALAGMITE**, *n.* [*L. stalagmium*, a drop; *Gr. σταλαγμος*, supra.] Stalactical formations of carbonate of lime found upon the floors of calcareous caverns. It originates from the same cause as stalactite, but is formed upon the floor of the cavern by the dropping of the lime water from the roof, which, under these circumstances, is usually covered with stalactites.

**STALAGMITES**, *n.* A genus of plants, nat. order Guttifera. The species are trees natives of the East Indies and Ceylon, and belong to the family which produces the gamboge of commerce.—*S. ovifolia*, a native of Ceylon, is said to yield a true gamboge, which is employed in commerce.

**STALAGMITIC**, or **STALAGMITICAL**, *a.* Having the form of stalagmite.

**STALAGMITICALLY**, *adv.* In the form or manner of stalagmite.

**STALDER**, } *n.* A wooden frame to set casks on.

**STALE**, *a.* [Probably from the root of *still*, *G. stellen*, to set, and equivalent to *stagnant*.] 1. Vapid or tasteless from age; having lost its life, spirit, and flavour from being long kept; as, *stale* beer. It is sometimes used in a favourable sense; as, *stale* (that is, old) beer or ale. *Stale* bread is that which has been baked at least twenty-four hours before.—2. Having lost the life or graces of youth; worn out; decayed; as, a *stale* virgin.—3. Worn out by use; trite; common; having lost its novelty and power of pleasing; as, a *stale* remark.

**STALE**, *n.* [Probably that which is set; *G. stellen*. See *STALL*.] 1. Something set or offered to view as an allurement to draw others to any place or purpose; a decoy; a stool-fowl.

As still as he went, he crafty *stales* did lay.

Spenser.

A pretence of kindness is the universal *stale* to all base projects. *Gov. of the Tongue*. [*In this sense obsolete*.]—2. † A prostitute.—3. † Old vapid beer. [See the *adj.*, No. 1.]—4. Old wine; urine, as of horses and cattle.—5. A long handle; as, the *stale* of a rake. [*Sax. stel, stete*; *G. stiel*.]—6. A word applied to the king in chess when *stalled* or set; that is, when so situated that he cannot be moved without going into check, by which the game is ended.

**STALE**, *v. t.* To make vapid or useless; to destroy the life, beauty, or use of; to wear out.

Age cannot wither her, nor custom *stale*

Her infinite variety. *Shak.*

**STALE**, *v. i.* [*G. stallen*; *Dan. staller*; *Sw. stalla*.] To make water; to discharge urine; as horses and cattle.

**STALELY**, } *adv.* Of old; of a long time.  
**STALE-MATE**, *n.* *At chess*, the position of the king, when, though not in check, he cannot move without being placed in check.

**STALENESS**, *n.* The state of being stale; vapidness; the state of having lost the life or flavour; oldness; as, the *staleness* of beer or other liquors; the *staleness* of provisions.—2. The state of being worn out; triteness; commonness; as, the *staleness* of an observation.

**STALK**, *n.* (*stauk*.) [*Sw. stielh*; *G. stiel*, a handle, and a stalk or stem; *Sax. staly*, a column; *Gr. στελεος*: from the root of *stall* and *G. stellen*, to set.] 1. The stem or main axis of a plant; that part of a plant which rises immediately from the root, and which usually supports the leaves, flowers, and fruit. [See *STEM*.] Thus we speak of a *stalk* of wheat, rye, or oats, the *stalks* of hemp. The *stalk* denotes that which is set, the fixed part of a plant, its support; or it is a shoot.—2. The pedicle of a flower, or the peduncle that supports the fructification of a plant, called the flower-stalk.—3. The stem of a quill; any thing resembling the stalk or stem of a plant; as, the *stalk* of a spoon; the *stalk* of a tobacco pipe, &c.—4. In *arch.*, an ornament in the Corinthian capital which resembles the stalk of a plant, and which is sometimes fluted; from it the volutes and helices spring.

**STALK**, *v. i.* [*Sax. stælcān*.] 1. To walk with high and proud steps; usually implying the affectation of dignity, and hence the word usually expresses dislike. The poets, however, use the word to express dignity of step.

With manly mien he *stalk'd* along the ground. *Dryden*.

Then *stalking* through the deep

He fords the ocean. *Addison*.

2. It is used with some insinuation of contempt or abhorrence.

Bertran

*Stalks* close behind her like a witch's fiend, Pressing to be employed. *Dryden*.

'Tis not to *stalk* about and draw fresh air From time to time. *Addison*.

3. To walk behind a stalking horse or behind a cover.

The king crept under the shoulder of his led horse, and said, I must *stalk*. *Bacon*.

**STALK**, *n.* A high, proud, stately step or walk.

**STALK'ED**, *a.* Having a stalk.—*Stalked glands*, in *bot.*, glands elevated upon a stalk.

**STALK'ER**, *n.* One who walks with a proud step; also, a kind of fishing net.

**STALK'ING**, *ppr.* Walking with proud or lofty steps.

**STALK'ING**, *n.* Among *sportsmen*, the act of going gently step by step under cover of a horse, a screen, &c., till the sportsman gets within shot of the game; as, *deer-stalking*.

**STALK'ING-HORSE**, *n.* A horse, real or factitious, behind which a fowler conceals himself from the sight of the game which he is aiming to kill; hence, a mask; a pretence.

Hypocrisy is the devil's *stalking-horse*, under an affectation of simplicity and religion. *L' Etrange.*

**STALK'LESS**, *a.* Having no stalk.

**STALK'Y**, *a.* Hard as a stalk; resembling a stalk.

**STALL**, *n.* [*Sax. stal, stal, stall*, a place, a seat, or station, a stable, state, condition; *G. stall*, a stable, a sty; *Fr. stalle* and *etal*; *W. ystal*, from the root of *G. stellen*, to set, that is, to throw down, to thrust down; *Sans. stala*, a place. See *STILL*.] 1. Primarily, a stand; a station; a fixed spot; hence, the stand or place where a horse or an ox is kept and fed; the division of a stable, or the apartment for one horse. The stable contains eight or ten stalls.—2. A stable; a place for cattle.

At last he found a *stall* where oxen stood. *Dryden.*

3. In 1 Kings iv. 26, stall is used for *horse*. "Solomon had forty thousand stalls of horses for his chariots." In 2 Chron. ix. 25, stall means *stable*. "Solomon had four thousand stalls for horses and chariots." These passages are reconciled by the definition given above; Solomon had four thousand stables, each containing ten stalls; forty thousand stalls.—4. A bench, form, or frame of shelves in the open air, where any thing is exposed to sale. It is curious to observe the stalls of books in the boulevards and other public places in Paris.—5. A small house or shed in which an occupation is carried on; as, a butcher's *stall*.—6. In *arch.*, an elevated seat in the choir

to some dignitary of such churches. In Roman Catholic times they were appropriated to the canons or prebendaries in a secular, and to the monks in a regular community. At St. George's chapel, Windsor, a stall is appropriated to every knight of the garter, after his election and installation.

**STALL**, *v. t.* To put into a stall or stable, or to keep in a stall; as, to *stall* an ox. Where King Latinus then his oxen *stall'd*. *Dryden.*

2. To install; to place in an office with the customary formalities. [For this, *install* is now used.]

**STALL**, *v. i.* To dwell; to inhabit. We could not *stall* together in the world. *Shuk.*

2. To kennel.—3. To be tired of eating, as cattle.

**STALL'AGE**, *n.* The right of erecting stalls in fairs; or rent paid for a stall.—2. In *old books*, laystall; dung; compost.

**STALLA'TION**, *n.* Installation.

**STALL'ED**, *pp.* Put or kept in a stable.

**STALL'-FED**, *pp.* Fed on dry fodder, or fattened in a stall or stable. [See *STALL-FEED*.]

**STALL'-FEED**, *v. t.* [*stall* and *feed*.] To feed and fatten in a stall or stable, or on dry fodder; as, to *stall-feed* an ox. [This word is used to distinguish this mode of feeding from *grass-feeding*.]

**STALL'-FEEDING**, *ppr.* Feeding and fattening in the stall.

**STALL'-FEEDING**, *n.* The practice of keeping cattle in houses, tying them up separately, and bringing their food to them for the purpose of fattening them, in distinction from the mode of feeding cattle by grazing, or of feeding them by putting them two or three together into small yards, with a shed at one end for shelter. In stall-feeding much less food is wasted, and a much greater quantity of manure is produced than by grazing; but, on the other hand, more manual labour is required, and the flesh of the animals is not considered so wholesome or high-flavoured as that of cattle which have pastured at large, or which have been fed in yards.

**STALL'INGER**, *n.* One who keeps a stall. [*Local*.]

**STALL'ION**, *n.* (stal'yunn.) [*G. hengst*; *Dan. staldhingst*; *Fr. etalon*; *It. stallone*; from *stall*, or its root, as we now use *stud horse*, from the root of *stud*, *stead*; *W. ystal*, a stall, stock, produce; *ystalu*, to form a stock; *ystalwyn*, a stallion.] A stone horse; a seed horse; or any male horse not castrated, whether kept for mares or not. According to the Welsh, the word signifies a stock horse, a horse intended for raising stock.

**STALL'-WORN**, in *Shakespeare*, Johnson thinks a mistake for *stalwart*, stout. His *stall-worn* steed the champion stout bestrode. *Shak.*

**STAL'WART**, } *a.* [*Scot. stalwart*; *STAL'WORTH*.] *Sax. stal-worth*, worth taking.] Brave; bold; strong; redoubted; daring; vehement; violent.

**STAMEN**, *n.* plur. *Stamens* or *Stamina*. [L. This word belongs to the root of *sto, stabilis*, or of *stige*.] 1. In a general sense, usually in the plural, the fixed, firm part of a body, which supports it or gives it its strength and solidity. Thus we say, the bones are the *stamina* of animal bodies; the ligneous parts of trees are the *stamina* which constitute their strength. Hence, —2. Whatever constitutes the princi-

pal strength or support of any thing; as, the *stamina* of a constitution or of life; the *stamina* of a state.—3. In *bot.*, the male organ of fructification in plants, formed principally of cellular tissue. It is situated immediately within the petals, and is composed, in most cases, of three parts, the filament, the anther, and the pollen, of which the two latter are essential, the other not. The stamens and pistils constitute the sexual or reproductive organs of plants. Generally they both exist in the same flower, which is thus said to be *hermaphrodite* or *perfect*. The number of stamens varies in different plants, from one to a hundred or more. With respect to their directions they are named, *erect*, *inflexed*, *reflexed*, *spreading*, *pendulous*, *ascending*, *declinate*; and their insertions with regard to the ovary are said to be *hypogynous*, *epigynous*, or *perigynous*. [See these terms.] It was on the number of stamens, and their arrangements and relations, that Linnæus founded the classes of his sexual system of plants.



Stamen.

**STAMENED**, *a.* Furnished with stamens.

**STAM'IN**, *n.* A slight woollen stuff.

**STAM'INA**, *n.* plur. of *Stamen*. The materials or principle of strength. [See *STAMEN*, No. 2.]

**STAM'INAL**, *a.* Pertaining to stamens or stamina; consisting in stamens or stamina.

**STAM'INATE**, *a.* Furnished with stamens.

**STAM'INATE**, *v. t.* To endue with stamina.

**STAMIN'EOUS**, *a.* [*L. stamineus*.] 1. Consisting of stamens.—2. Possessing stamens. *Stamineous* flowers have no corol; they want the coloured leaves called petals, and consist only of the style and stamina. Linnæus calls them *apetalous*; others, imperfect or incomplete.—3. Pertaining to the stamen, or attached to it; as, a *stamineous* nectary.

**STAMINID'IUM**, *n.* plur. *Staminidia*. An organ in cryptogamic plants considered as equivalent to a stamen. Also a rudimentary stamen, or a process occupying the place of a stamen, as the so-called fifth stamen in *scrophularia*.

**STAMINIF'EROUS**, *a.* [*L. stamen* and *fero*, to bear.] A *staminiferous* flower is one which has stamens without a pistil. A *staminiferous* nectary is one that has stamens growing on it.

**STAM'MEL**, *n.* A species of red cloth. —2. A kind of woollen cloth. [See *STAMIN*.]

**STAM'MER**, *v. i.* [*Sax. stamer*, one who stammers; *Goth. stammis*, stammering; *G. stammeln*; *Dan. stammer*; from the root *stam* or *stem*. The primary sense is to stop, to set, to fix. So *stutter* is from the root of *stead*, *stud*.] Literally, to stop in uttering syllables or words; to stutter; to hesitate or falter in speaking; and hence, to speak with stops and difficulty. Demosthenes is said to have *stammered* in speaking, and to have overcome the difficulty by persevering efforts.

**STAM'MER**, *v. t.* To utter or pronounce with hesitation or imperfectly.

**STAM'MER**, *n.* The terms *stammer*

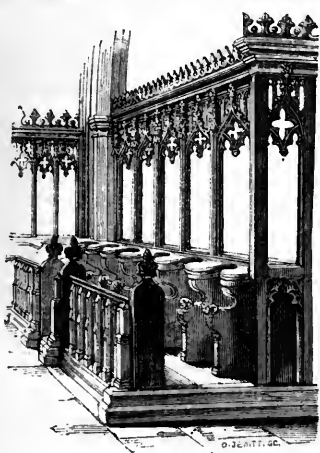

Stalls, Higham Ferrers Church, Northamptonshire.

or chancel of a cathedral, collegiate church, &c., and mostly appropriated

and *stutter* are used synonymously to denote that involuntary interruption of utterance arising from difficulty, and often total inability to pronounce certain syllables, the organs of speech being frequently affected with spasm in the effort to speak. Stammer in some cases is curable, in others it is incurable. [See STUTTERING.]

**STAMMERER**, *n.* One that stutters or hesitates in speaking.

**STAMMERING**, *ppr.* Stopping or hesitating in the uttering of syllables and words; stuttering.—2. *a.* Apt to stammer.

**STAMMERING**, *n.* The act of stopping or hesitating in speaking; impediment in speech; articulation disturbed by irregular intermissions or snatches.

**STAMMERING**, *a.* That stammers; hesitating in speech.

**STAMMERINGLY**, *adv.* With stops or hesitation in speaking.

**STAMP**, *v. t.* [D. *stampen*; G. *stampfen*; Fr. *estamper*. We know not which is the radical letter, *m* or *p*.] In a general sense, to strike; to beat; to press. Hence, 1. To strike or beat forcibly with the bottom of the foot, or by thrusting the foot downward; as, to *stamp* the ground.

He frets, he fumes, he stares, he stamps the ground. *Dryden*.

2. To impress with some mark or figure; as, to *stamp* a plate with arms or initials.—3. To impress; to imprint; to fix deeply; as, to *stamp* virtuous principles on the heart. [See ENSTAMP.]—4. To fix a mark by impressing it; as, a notion of the Deity *stamped* on the mind.

God has *stamped* no original characters on our minds, wherein we may read his being. *Locke*.

5. To make by impressing a mark; as, to *stamp* pieces of silver.—6. To coin; to mint; to form.—7. To set a mark upon; as, to *stamp* cloth; to *stamp* a newspaper.—8. To cut into various forms with a stamp.—9. To crush by the downward action of a kind of pestle, as ore in a stamping-mill.—10. To put post-marks on letters.

**STAMP**, *v. i.* To strike the foot forcibly downward.

But starts, exclaims, and stamps, and raves, and dies. *Dennis*.

**STAMP**, *n.* Any instrument for making impressions on other bodies.

'Tis gold so pure,  
It cannot bear the stamp without alloy. *Dryden*.

2. A mark imprinted; an impression. That sacred name gives ornament and grace, And, like his stamp, makes basest metals pass. *Dryden*.

3. That which is marked; a thing stamped.

Hanging a golden stamp about their necks *Shak.*

4. † A picture cut in wood or metal, or made by impression; a cut; a plate. At Venice they put out very curious stamps of the several edifices which are most famous for their beauty and magnificence. *Addison*.

5. An impression of a public mark or seal made upon paper or parchment by the government, or its officers, for the purposes of revenue; as, the *stamp* upon a bond or indenture; the *stamp* on a newspaper. Stamps always denote the price of the particular stamp; or, in other words, the tax levied upon a particular instrument stamped, and

sometimes they denote the nature of the instrument itself. If the instrument is written upon paper, the stamp is impressed upon the paper itself; but to a parchment instrument, the stamp is attached by paste and a small piece of lead, which itself forms part of the impression.—6. An instrument for cutting out materials (as paper, leather, &c.) into various forms by a downward pressure.—7. A character of reputation, good or bad, fixed on any thing. These persons have the *stamp* of impiety. The Scriptures bear the *stamp* of a divine origin.—8. Authority; current value derived from suffrage or attestation.

Of the same *stamp* is that which is obtruded on us, that an adamant suspends the attraction of the loadstone. *Brown*.

9. Make; cast; form; character; as, a man of the same *stamp*, or of a different *stamp*.—10. In *metallurgy*, a kind of pestle raised by a water-wheel, for beating ores to powder; any thing like a pestle used for pounding or beating.—11. A kind of receipt ticket, sold by the post-office authorities, for attaching to letters, as an evidence of prepayment. Penny stamps are printed in red, and twopenny stamps in blue.

**STAMP-ACT**, *n.* An act of the British parliament, imposing a duty on all paper, vellum, and parchment used in her American colonies, and declaring all writings on unstamped materials to be null and void. This act roused a general opposition in the colonies, and was one cause of the revolution.

**STAMP-DUTIES**, *n.* Duties imposed on pieces of parchment or paper, on which many species of legal instruments are written; on newspapers, advertisements, cards, dice, &c. Stamp-duties on legal instruments, such as conveyances, deeds, legacies, &c., are chiefly secured by prohibiting the reception of them in evidence unless they bear the stamp required by the law.

**STAMP'ED**, *pp.* Impressed with a mark or figure; coined; imprinted; deeply fixed.

**STAMP'ER**, *n.* An instrument for pounding or stamping.—2. One who applies a stamp, or a post-mark; as, in the Glasgow post-office there are four stampers.

**STAMP'ING**, *ppr.* or *n.* Impressing with a mark or figure; coining; imprinting. In the stamp-office there are two kinds of *stamping* used; the *wet* and *dry*. In the former the stamp is printed in red, on newspapers, &c.; the latter is the impression of the bare stamp on bills, receipts, &c.

**STAMPING-MACHINE**, *n.* A machine for manufacturing metal spoons, forks, and other articles, by means of dies and a heavy hammer; and so constructed that the spoon, ladle, or fork is made perfect at one blow.

**STAMPING-MILL**, *n.* An engine by which ores are pounded by means of a stamp.

**STAMP'-LAWS**, *n.* Laws enacted with a view to provide a revenue to the crown, by requiring that all contracts, bills of exchange, bonds, deeds, and many other writings of a similar nature, should be written upon stamped paper, a duty being payable to the crown on every stamp. The stamp-laws are carried into effect by the board of stamps and taxes, consisting of commissioners appointed by the crown, during pleasure.

**STAMP'-OFFICE**, *n.* An office where stamps are issued, and stamp duties, and also taxes are received.

**STAN**, as a termination, is said to have expressed the superlative degree; as in *Athelstan*, most noble; *Dunstan*, the highest. But qu. *Stan*, in Saxon, is *stone*.

**STANCE**, *n.* [from *L. sto*, *stare*, to stand.] A site; a station; an area for building. [*Scotch.*]

**STANCH**, *v. t.* [Fr. *étancher*; Arm. *stangoa*; Sp. and Port. *estancar*, to stop, to stanch, to be overtired; It. *stancare*, to weary; Sp. and Port. *estancia*, a stay or dwelling for a time, an abode, and a *stanza*; Sp. *estanco*, a stop; hence, Fr. *étang*, a pond, and Eng. *tank*.] In a general sense, to stop; to set or fix; but applied only to the blood; to stop the flowing of blood. Cold applications to the neck will often *stanch* the bleeding of the nose.

**STANCH**, *v. i.* To stop, as blood; to cease to flow.

Immediately the issue of her blood stanch'd; Luke viii.

**STANCH**, *a.* [This is the same word as the foregoing, the primary sense of which is to *set*; hence the sense of firmness.] 1. Sound; firm; strong and tight; as, a *stanch* ship.—2. Firm in principle; steady; constant and zealous; hearty; as, a *stanch* churchman; a *stanch* republican; a *stanch* friend or adherent.

In politics I hear you're *stanch*. *Prior*.  
3. Strong; not to be broken.—4. Firm; close.

This is to be kept *stanch*. *Locke*.  
A *stanch* hound is one that follows the scent closely without error or remissness.

**STANCH'ED**, *pp.* Stopped or restrained from flowing.

**STANCH'EL**, *n.* In *arch.*, a stanchion. **STANCH'ER**, *n.* He or that which stops the flowing of blood.

**STANCH'ING**, *ppr.* Stopping the flowing of blood.

**STANCH'ION**, *n.* [Fr. *étangon*; Arm. *stangonu* and *stancconi*, to prop. See STANCH.] A prop or support; a piece of timber in the form of a stake or post, used for a support. In *ship-building*, stanchions of wood or iron are of different forms, and are used to support the deck, the quarter-rails, the nettings, awnings, and the like. Also a name given to the upright pieces of timber in a bulk-head, breast-work, &c., of a ship.—2. In *arch.*, a prop or piece of timber giving support to one of the main parts of a roof; also one of the upright bars, wood or iron, of a window, screen, railing, &c.

**STANCH'LESS**, *a.* That cannot be stanch'd or stopped.

**STANCH'NESS**, *n.* Soundness; firmness in principle; closeness of adherence.

**STAND**, *v. i.* pret. and pp. *Stood*. [Sax. *standan*; Goth. *standan*. This verb, if from the root of *G. stehen*, Dan. *staaer*, Sans. *sta*, *L. sto*, is a derivative from the noun, which is formed from the participle of the original verb. In this case, the noun should properly precede the verb. It may be here remarked that if *stan* is the radical word, *stand* and *L. sto*, cannot be from the same stock. But *stand* in the pret. is *stood*, and *sto* forms *steti*. This induces a suspicion that *stan* is not the root of *stand*, but that *n* is casual.

These words, after all, may be from different roots. The Russ. *stoyu*, to stand, is the L. *sto*, but it signifies also to be, to exist, being the substantive verb. So in It. *stare*, Sp. and Port. *estar*.] 1. To be upon the feet, as an animal; not to sit, kneel, or lie.

The absolute to be pronounced by the priest alone, *standing*. *Com. Prayer*.

And the king turned his face about and blessed all the congregation of Israel, and all the congregation of Israel stood; 1 Kings viii.

2. To be erect, supported by the roots, as a tree or other plant. Notwithstanding the violence of the wind, the tree yet stands.—3. To be on its foundation; not to be overthrown or demolished; as, an old castle is yet standing.—4. To be placed or situated; to have a certain position or location. Paris stands on the Seine. London stands on the Thames.—5. To remain upright, in a moral sense; not to fall.

To stand or fall,  
Free in thy own arbitrament it lies. *Milton*.

6. To become erect.  
Mute and amaz'd, my hair with horror stood. *Dryden*.

7. To stop; to halt; not to proceed.  
I charge thee, stand,  
And tell thy name. *Dryden*.

8. To stop; to be at a stationary point. Say, at what part of nature will they stand? *Pope*.

9. To be in a state of fixedness; hence, to continue; to endure. Our constitution has stood for ages. It is hoped it will stand for ages longer.

Commonwealths by virtue ever stood. *Dryden*.

10. To be fixed or steady; not to vacillate. His mind stands unmoved.—11. To be in or to maintain a posture of resistance or defence. Approach with charged bayonets; the enemy will not stand.

The king granted the Jews to stand for their life; *Esth. viii*.

12. To be placed with regard to order or rank. Note the letter that stands first in order. Wilberforce stood highest in public estimation. Christian charity stands first in the rank of gracious affections.—13. To be in any particular state; to be, emphatically expressed, that is, to be fixed or set; the primary sense of the substantive verb. How does the value of wheat stand? God stands in no need of our services, but we always stand in need of his aid and mercy.

Accomplish what your signs foreshow;  
I stand resign'd. *Dryden*.

14. To continue unchanged or valid; not to fail or become void. No conditions of our peace can stand. *Shak.*

My mercy will I keep for him, and my covenant shall stand fast with him; *Ps. lxxxix.*

15. To consist; to have its being and essence. Sacrifices .. which stood only in meats and drinks; *Heb. ix.*

16. To have a place. This excellent man, who stood not on the advantage-ground before, provoked men of all qualities. *Clarendon*.

17. To be in any state. Let us see how our matters stand. As things now stand with us. *Calamy*.

18. To be in a particular respect or relation; as, to stand godfather to one. We ought to act according to the relation we stand in toward each other.—19. To be, with regard to state of mind. Stand in awe, and sin not; *Ps. iv.*

20. To succeed; to maintain one's ground; not to fail; to be acquitted; to be safe.

Readers by whose judgment I would stand or fall. *Spectator*.

21. To hold a course at sea; as, to stand from the shore; to stand for the harbour.

From the same parts of heav'n his navy stands. *Dryden*.

22. To have a direction. The wand did not really stand to the metal, when placed under it. *Boyle*.

23. To offer one's self as a candidate. He stood to be elected one of the proctors of the university. *Saunderson*.

24. To place one's self; to be placed. I stood between the Lord and you at that time; *Deut. v.*

25. To stagnate; not to flow. Or the black water of Poptina stands. *Dryden*.

26. To be satisfied or convinced. Though Page be a secure fool, and stand so firmly on his wife's frailty. *Shak.*

27. To make delay. I cannot stand to examine every particular.—28. To persist; to persevere.

Never stand in a lie when thou art accused. *Taylor*.

29. To adhere; to abide. Despair would stand to the sword. *Daniel*.

30. To be permanent; to endure; not to vanish or fade; as, the colour will stand.—To stand by, to be near; to be a spectator; to be present. I stood by when the operation was performed. This phrase generally implies that the person is inactive, or takes no part in what is done. In *seamen's lan.*, to stand by is to attend and be ready. Stand by the halyards.—2. To be aside; to be placed aside with disregard.

In the mean time, we let the command's stand by neglected. *Decay of Piety*.

3. To maintain; to defend; to support; not to desert. I will stand by my friend to the last. Let us stand by our country. "To stand by the Arundelian marbles," in *Pope*, is to defend or support their genuineness.—4. To rest on for support; to be supported.

This reply standeth by conjecture. *Whitgift*.

To stand for, to offer one's self as a candidate. How many stand for consulships?—Three. *Shak.*

2. To side with; to support; to maintain, or to profess or attempt to maintain. We all stand for freedom, for our rights or claims.—3. To be in the place of; to be the substitute or representative of. A cipher at the left hand of a figure stands for nothing.

I will not trouble myself, whether these names stand for the same thing, or really include one another. *Locke*.

4. In *seamen's lan.*, to direct the course toward.—To stand from, to direct the course from.—To stand one, to cost. The coat stands him four pounds.—To stand in, or stand in for, in *seamen's lan.*, is to direct a course toward land or a harbour.—To stand it, to be able to support one's self in trials of strength or suffering.—To stand off, to keep at a distance.—2. Not to comply.—3. To keep at a distance in friendship or social intercourse; to forbear intimacy.

We stand off from an acquaintance with God. *Atterbury*.

4. To appear prominent; to have relief. Picture is best when it standeth off, as if it were carved. *Wotton*.

To stand off, or off from, in *seamen's*

*lan.*, is to direct the course from land.—To stand off and on is to sail toward land and then from it.—To stand out, to project; to be prominent.

Their eyes stand out with fatness; *Ps. lxxiii.*

2. To persist in opposition or resistance; not to yield or comply; not to give way or recede.

His spirit is come in. That so stood out against the holy church. *Shak.*

3. With *seamen*, to direct the course from land or a harbour.—To stand to, to ply; to urge efforts; to persevere. Stand to your tackles, mates, and stretch your oars. *Dryden*.

2. To remain fixed in a purpose or opinion. I will stand to it, that this is his sense. *Stillingfleet*.

3. To abide by; to adhere; as to a contract, assertion, promise, &c.; as, to stand to an award; to stand to one's word.—4. Not to yield; not to fly; to maintain the ground.

Their lives and fortunes were put in safety, whether they stood to it or ran away. *Bacon*.

To stand to sea, to direct the course from land.—To stand under, to undergo; to sustain.—To stand up, to rise from sitting; to be on the feet.—2. To arise in order to gain notice.

Against whom when the accusers stood up, they brought no accusation of such things as I supposed; *Acts xxv.*

3. To make a party. When we stood up about the corn. *Shak.*

To stand up for, to defend; to justify; to support, or attempt to support; as, to stand up for the administration.—To stand upon, to concern; to interest. Does it not stand upon them to examine the grounds of their opinion? This phrase is, we believe, obsolete; but we say, it stands us in hand, that is, it is our concern, it is for our interest.—2. To value; to pride.

We highly esteem and stand much upon our birth. *Roy*.

3. To insist; as, to stand upon security.—To stand with, to be consistent. The faithful servants of God will receive what they pray for, so far as stands with his purposes and glory.

It stands with reason that they should be rewarded liberally. *Davies*.

To stand together is used, but the last two phrases are not in very general use, and are perhaps growing obsolete.—To stand against, to oppose; to resist.—To stand fast, to be fixed; to be unshaken or immovable.—To stand in hand, to be important to one's interest; to be necessary or advantageous. It stands us in hand to be on good terms with our neighbours.—To stand fire, to receive the fire of an enemy without giving way.—It stands to reason, it is reasonable to suppose. [*Colloquialism in partial currency*.]

STAND, *v. t.* To endure; to sustain; to bear. I cannot stand the cold or the heat.—2. To endure; to resist without yielding or receding. He stood the furious foe. *Pope*.

3. To await; to suffer; to abide by. Bid him disband the legions... And stand the judgment of a Roman senate. *Addison*.

To stand one's ground, to keep the ground or station one has taken; to maintain one's position; in a literal or figurative sense; as, an army stands its ground, when it is not compelled

to retreat. A man *stands his ground* in an argument, when he is able to maintain it, or is not refuted.—*To stand it*, to bear; to be able to endure; or to maintain one's ground or state; a popular phrase.—*To stand fire*, to receive the fire of arms from an enemy without giving way.—*To stand trial*, is to sustain the trial or examination of a cause; not to give up without trial.

**STAND, n.** [Sans. *stana*, a place, a mansion, state, &c.] 1. A stop; a halt; as, to make a *stand*; to come to a *stand*, either in walking or in any progressive business.

The horse made a *stand*, when he charged them and routed them. *Clarendon.*

2. A station; a place or post where one stands; or a place convenient for persons to remain for any purpose. The sellers of fruit have their several *stands* in the market.

I took my *stand* upon an eminence.

*Spectator.*

3. Rank; post; station.

Father, since your fortune did attain

So high a *stand*, I mean not to descend.

*Daniel.*

[In lieu of this, *standing* is now used. He is a man of high *standing* in his own country.]—4. The act of opposing.

We have come off

Like Romans; neither foolish in our *stands*, Nor cowardly in retire. *Shak.*

5. The highest point; or the ultimate point of progression, where a stop is made, and regressive motion commences. The population of the world will not come to a *stand*, while the means of subsistence can be obtained. The prosperity of the Roman empire came to a *stand* in the reign of Augustus; after which it declined.

Vice is at *stand*, and at the highest flow.

*Dryden.*

6. A young tree, usually reserved when the other trees are cut.—7. A small table; as, a candle-*stand*; or any frame on which vessels and utensils may be laid.—8. In *com.*, a weight of from two hundred weight and a half to three hundred weight of pitch.—9. Something on which a thing rests or is laid; as, a hay-*stand*.—10. The place where a witness stands to testify in court.—*To put to a stand*, to put into difficulty, embarrassment, or perplexity.—*Stand of arms*, in *milit. affairs*, a musket with its usual appendages, as a bayonet, cartridge-box, &c.—*To be at a stand*, to stop on account of some doubt or difficulty; hence, to be perplexed; to be embarrassed; to hesitate what to determine, or what to do.—11. An erection, or raised station for spectators, at a horse-race.—*Stand still*, a standing without moving.

**STANDARD, a.** Having a permanent quality; fixed; settled; superior; as, a *standard* work; a *standard* measure; *standard* weight, &c.

**STANDARD, n.** [It. *standardo*; Fr. *etendard*; G. *standarte*; *stand* and *ard*, sort, kind] 1. An ensign of war; a staff with a flag or colours, borne as a signal for the joining together of several troops belonging to the same body. The troops repair to their *standard*. The standard is usually a piece of silk, one foot and a half square, on which are embroidered the arms, device, or cipher of the prince or colonel. It is carried in the centre of the first rank of a squadron of horse by the cornet. The standards borne by infantry are usually called *colours*. The royal *standard* of Great Britain

is a flag, in which the imperial ensigns of England, Scotland and Ireland are quartered with the armorial bearings of Hanover.

His armies, in the following day, On those fair plains their *standards* proud display. *Fairfax.*

In *her.*, a *standard* is an ensign, carried at the funerals of great personages. It is usually fifteen feet long, and split at the points; at the top is the arms of the union, then the crests and motto of the defunct.—2. In *com.*, the original weight, measure, or coin sanctioned by government, and committed to the keeping of a magistrate, or deposited in some public place, to regulate, adjust, and try weights and measures, used by particular persons in traffic.

Thus the imperial gallon is the *standard* measure of capacity in this country; the imperial yard is the *standard* of lineal measure; and the pound troy is the *standard* of weight. [See MEASURE, WEIGHT.] The *standards* of weights and measures, in England, were appointed by Magna Charta to be kept in the exchequer, by a special officer, called the clerk or controller of the market.—3. That which is established as a rule or model, by the authority of public opinion, or by respectable opinions, or by custom or general consent; as, writings which are admitted to be the *standard* of style and taste. Homer's *Iliad* is the *standard* of heroic poetry. Demosthenes and Cicero are the *standards* of oratory. Of modern eloquence, we have an excellent *standard* in the speeches of Lord Chatham. Addison's writings furnish a good *standard* of pure, chaste, and elegant English style. It is not an easy thing to erect a *standard* of taste.—4. In *coinage*, the proportion of weight of fine metal and alloy established by authority. The *standard* fineness of gold coins is at present 22 carats, that is, 22 parts of fine gold, and 2 of alloy. The pound troy of *standard* gold is coined into 46½ sovereigns, or into £46 14s. 6d. The mint or *standard* price of gold is therefore said to be £46 14s. 6d. per pound troy, or £3 17s. 10½d. an ounce. The *standard* fineness of silver coins is 11 ounces 2 dwts. of pure silver, and 18 dwts. of alloy, making together 1 pound troy, which is coined into 66 shillings.—5. A tree or shrub which stands singly, without being attached to any wall or support. In gardening and planting, they are distinguished into three kinds; the *full standard*, whose stem is suffered to grow up seven or eight feet, or more, before it is allowed to branch out; the *half standard*, which is allowed to run up three or four feet, and then permitted to branch out; and the *dwarf standard*, whose stem is only allowed to reach a height of one or two feet before it is permitted to branch.—6. In *ship-building*, an inverted knee placed upon the deck instead of beneath it, with its vertical branch turned upward from that which lies horizontally.—7. In *bot.*, the upper petal or banner of a papilionaceous corol.—8. In *joinery*, any upright in a framing, as the quarters of partitions, the frame of a door, and the like.—*Standard* is also an old term for a candlestick of large size, standing on the ground, with branches for several lights.—9. In *milit. affairs*, the measure of height for such as enlist into the army.

**STANDARD-BEARER, n.** [*standard* and *bear*.] An officer of an army, company, or troop, that bears a *standard*; an ensign of infantry or a cornet of horse.

**STAND'EL, † n.** A tree of long standing.

**STAND'ER, n.** One who stands.—2. † A tree that has stood long.

**STAND'ER, or STAND'ARD-GRASS, n.** Satyrion.

**STAND'ER-BY, n.** One that stands near; one that is present; a mere spectator. [We now more generally use *by-stander*.]

**STAND'ER-UP, n.** One who takes a side.

**STAND'ING, ppr.** Being on the feet; being erect. [See *STAND*.]—2. Moving in a certain direction to or from an object.—3. a. Settled; established, either by law or by custom, &c.; continually existing; permanent; not temporary; as, a *standing* army. Money is the *standing* measure of the value of all other commodities. Legislative bodies have certain *standing* rules of proceeding. Courts of law are or ought to be governed by *standing* rules. There are *standing* rules of pleading. The gospel furnishes us with *standing* rules of morality. The Jews, by their dispersion and their present condition, are a *standing* evidence of the truth of revelation and of the prediction of Moses. Many fashionable vices and follies ought to be the *standing* objects of ridicule.—*Standing orders*, the orders made by either house of parliament respecting the manner in which business shall be conducted in it.—4. Lasting; not transitory; not liable to fade or vanish; as, a *standing* colour.

—5. Stagnant; not flowing; as, *standing* water.—6. Fixed; not movable; as, a *standing* bed; distinguished from a *truckle* bed.—7. Remaining erect; not cut down; as, *standing* corn.—*Standing rigging*, of a ship. This consists of the cordage or ropes which sustain the masts and remain fixed in their position. Such are the shrouds and stays.—*Standing part of the sheet*, that part of it which is made fast to a ring at the ship's quarter.—*Standing part of a tackle*, the end of the rope where the block is fastened.—*Standing ropes*, those which do not run in any block, but are set taught, or let slack, as occasion serves; as the sheet-stays, back-stays, &c.

**STAND'ING, n.** Continuance; duration or existence; as, a custom of long *standing*.—2. Possession of an office, character, or place; as, a patron or officer of long *standing*.—3. Station; place to stand in.

I will provide you with a good *standing* to see his entry. *Bacon.*

4. Power to stand.

I sink in deep mire, where there is no *standing*; Ps. lxxix.

5. Rank; condition in society; as, a man of good *standing* or of high *standing* among his friends.—*Standing off*, sailing from the land.—*Standing on*, sailing to land.

**STAND'ISH, n.** [*stand* and *dish*.] A case for pen and ink.

I bequeath to Dean Swift my large silver *standish*. *Swift.*

**STAND'-PIPE, n.** A vertical pipe erected at a well or reservoir, into which water is forced by mechanical means, in order to obtain a head pressure sufficient to convey it to a distance. *Stand-cock*, the outlet of such a pipe.—2. Also a small pipe inserted into an opening in the water main in a street.



**STAND'-POINT**, *n.* [Ger. *standpunkt*.] A fixed point or station; a basis or fundamental principle; a position from which things are viewed.

**STANG**, *n.* [Sax. *stang*, *steng*, a pole or stick; G. *stange*; W. *ystang*, a pole or perch; allied to *sting* and *stanchion*; from shooting.] 1. † A pole, rod, or perch; a measure of land.—2. A long bar; a pole; a shaft.—*To ride the stang*, is to be carried on a pole on men's shoulders, in derision; a punishment inflicted in former times on such husbands as beat their wives. [Local.]

**STANG**, *v. i.* To shoot with pain. [Local.]

**STANHOPE**, *n.* A light two-wheeled carriage, without a top; so called from Lord Stanhope, for whom it was contrived.

**STANK**, † *v.* Weak; worn out.

**STANK**, † *v. i.* To sigh.

**STANK**, *old pret.* of *Stink*. *Stunk* is now used.

**STANK**, *n.* [W. *ystanc*. See **STANCH**.] A pool; a pond; a ditch. [Scotch.]

**STANNARY**, *a.* [from L. *stannum*, tin; Ir. *stan*; W. *ystaen*. See **TIN**.] Relating to the tin works; as, *stannary courts*. The stannary courts of Devon and Cornwall are courts of record for the administration of justice among the tinners. They are held before the lord warden and his substitutes.

**STANNARY**, *n.* A tin mine. Stannaries are the mines and works from which tin is dug and purified; but the term is used as including by one general designation the tin mines within a particular district, the tinners employed in working them, and the customs and privileges attached to the mines, and to those employed in digging and purifying tin. The great stannaries of England are those of Devon and Cornwall.

**STANNATE**, *n.* [L. *stannum*, tin.] A salt formed of stannic acid united with a base.

**STANNEL**, } *n.* The kestrel, a species  
**STANNYEL**, } of hawk; called also *stone-gall* and *wind-hover*.

**STANNIC**, *a.* [L. *stannum*, tin.] Pertaining to tin; procured from tin; as, the *stannic acid*.

**STANNIC ACID**, *n.* The peroxide of tin, which performs the functions of an acid, uniting with bases and forming salts called *stannates*.

**STANNIFEROUS**, *a.* [L. *stannum*, tin; and *fero*, I bear.] Containing or affording tin.

**STANNYEL**, † *n.* The common stone hawk.

**STANZA**, *n.* [It. *stanza*, an abode or lodging, a stanza, that is, a stop; Sp. and Port. *estancia*, from *estancar*, to stop; Fr. *stance*. See **STANCH**.] In poetry, a number of lines or verses connected with each other, and ending in a full point or pause; a part of a poem containing every variation of measure in that poem. A stanza may contain verses of a different length or number of syllables, and a different number of verses; or it may consist of verses of equal length. Stanzas are said to have been first introduced from the Italian into French poetry about the year 1580, and thence they were introduced into England. The principal Italian stanza is the *ottava rima*, which consists of six lines in alternate rhyme, ended by a couplet, the lines being decasyllabic, or rather hendecasyllabic. The Spenserian stanza consists of eight decasyllabic and an Alexandrian at the

end; the first and third verses forming the first rhyme; the second, fourth, fifth, and seventh, and the eighth and ninth a third rhyme. There is a great variety of stanzas in the poetry of modern languages, according to the rhythm and structure of the poem.

Horace confines himself to one sort of verse or *stanza* in every ode. Dryden.

2. In arch., an apartment or division in a building. [Ital.]

**STANZA'IC**, *a.* Consisting in stanzas.

**STAPE'LIA**, *n.* An extensive and curious genus of plants, nat. order Asclepiadaceæ. Most of the species are natives of the Cape of Good Hope. They are succulent plants without leaves, frequently covered over with dark tubercles, giving them a very



*Stapelia variegata.*

grotesque appearance. In most instances the flowers give off very unpleasant odours, inasmuch that the name of carrion-flower has been given to some of these plants. They are, nevertheless, cultivated on account of their singular and beautiful flowers.

**STAPES**, *n.* [L. a stirrup.] One of the bones of the internal ear, so called from its shape.

**STAPH'ISINE**, *n.* A substance found along with delphine in *Delphinium Staphysagria*. It is said to be composed of 23 equivalents of hydrogen, 32 of carbon, 4 of oxygen, and 1 of nitrogen. It is acrid and poisonous, but is probably only a compound of delphine.

**STAPHYLE'A**, *n.* Bladder-nut, a genus of plants, the type of the nat. order Staphyleaceæ. Six species have been enumerated, one a native of Europe, one of North America, one of Japan, two of Jamaica, one of Peru, and one of Himalaya. *S. pinnata*, or common bladder-nut, is a native of the middle and south of Europe, and occurs occasionally in hedges and thickets in Yorkshire. The wood is used for various kinds of turning. The seeds are edible, and act as a mild aperient.

**STAPHYLEA'CEÆ**, *n.* A small nat. order of plants belonging to the syncarpous group of polypetalous exogens. The species are shrubs, with opposite pinnate leaves, and both common and partial stipules. The flowers are arranged in terminal stalked racemes. There are only three genera belonging to the order, which inhabit the warmer and temperate parts of the earth. Only one species is found in Europe, the *Staphylea pinnata*. The seeds of all contain a mild oil, which may be expressed.

**STAPH'YLINÉ**, *a.* [Gr. *σταφυλή*, a bunch of grapes.] In mineral., having the form of a bunch of grapes; botryoidal.

**STAPHYLIN'IDÆ**, *n.* A family of coleopterous insects.

**STAPHYLO'MA**, or **STAPHYLO'SIS**, *n.* [Gr. *σταφυλή*, a grape.] A disease

of the eye-ball, in which the cornea loses its natural transparency, rises above the level of the eye, and successively even projects beyond the eyelids, in the form of an elongated, whitish, or pearl-coloured tumour, which is sometimes smooth, sometimes uneven, and is attended with a total loss of sight.

**STAPHYLO'RAPHY**, *n.* [Gr. *σταφυλή*, and *ραφή*, a suture, from *ραίνω*.] A surgical suture of the palate, for the purpose of uniting the edges of a fissure.

**STAPHYSINE**. See **STAPHISINE**.

**STAP'LE**, *n.* [Sax. *stapel*, *stapul*, a stake; D. *stapel*, a pile, stocks, staple; *stapelen*, to pile; G. *stapel*, a stake, a pile or heap, a staple, stocks, a mart; Sw. *stapel*; Dan. *stabel*, a staple; *stabler*, to pile; *stabe*, a block or log; *stab*, a staff. We see this word is from the root of *staff*. The primary sense of the root is to set, to fix. *Staple* is that which is fixed, or a fixed place, or it is a pile or store.] 1. A settled mart or market; an emporium. In England, formerly, the king's *staple* was established in certain ports or towns, and certain goods could not be exported, without being first brought to these ports to be rated and charged with the duty payable to the king or public. The principal commodities on which customs were levied, were *wool*, *skins*, and *leather*, and these were originally the *staple* commodities. Hence the words *staple* and *staple commodities*, came in time to signify the principal commodities grown or manufactured in a country or town, either for exportation or home consumption. Thus cotton is the *staple commodity* of several of the Southern States of America; the manufacture of cotton is the *staple trade* of Manchester; the manufacture of hardwares is the *staple* of Birmingham; the manufacture of shawls is the *staple* of Paisley; and the manufacture of muslin and other fabrics, and the production of iron, form the *staple* of Glasgow.—2. A city or town where merchants agree to carry certain commodities.—3. The thread or pile of wool, cotton, or flax. Thus we say, this is wool of a coarse *staple*, or a fine *staple*; this is cotton of a short *staple*, long *staple*, fine *staple*, &c.—4. [W. *ystiefwel*.] A loop of iron, or a bar or wire bent and formed with two points to be driven into wood, to hold a hook, pin, &c.—*Staple of land*, the particular nature and quality of land.

**STAP'LE**, *a.* Settled; established in commerce; as, a *staple trade*.—2. According to the laws of commerce; marketable; fit to be sold. [Not much used].—3. Chief; principal; regularly produced or made for market; as, *staple commodities*. [This is now the most general acceptance of the word.]

**STAP'LER**, *n.* A dealer; as, a wool *stapler*.

**STAR**, *n.* [Sax. *storra*; G. *stern*; D. *star*; Gr. *αστρα*; Sans. *tara*; W. *seren*.] 1. An apparently small luminous body in the heavens, that appears in the night, or when its light is not obscured by clouds or lost in the brighter effulgence of the sun. *Stars* are fixed or planetary. The fixed stars are known by their perpetual twinkling, and by their being always in the same position in relation to each other. The planets do not twinkle; they shine with a steady light; they revolve round the sun, and are continually changing their

positions with regard to the other heavenly bodies, their motions being sometimes direct, and sometimes retrograde. In *astron.*, the word *star* is chiefly applied to those luminous heavenly bodies which are situated beyond the solar system. The principal points which form the subjects of astronomical inquiries regarding the stars, are, their apparent and relative magnitudes, their distribution, their number, their distances, motions, and nature. In order to distinguish the stars one from another, the ancients divided the heavens into different spaces called constellations, which they supposed to be occupied by the figures of animals and other objects, as a lion, a bear, a man, a lyre, &c. Each of these figures was made to comprehend a group of stars, and to a few of the brightest stars they gave particular names. These ancient figures have been retained by the moderns, who, in order to distinguish the stars in the same constellation from each other, have either numbered or marked them with certain letters of the Greek and other alphabets. The stars are divided into different magnitudes, according to their apparent size, the largest being said to be of the first magnitude, the next largest of the second magnitude, and so on to the sixth or seventh magnitude, which last class comprehends the least stars that are visible to the naked eye. All the stars beyond the sixth or seventh magnitude are called *telescopic stars*, as they cannot be seen without the aid of the telescope. Those stars which lie in spaces between the constellations, and are therefore not included in them, are called *unformed stars*. The gradations of magnitude among the telescopic stars are continued by astronomers from the eighth down to the sixteenth. The stars are very irregularly distributed over the celestial sphere. In some regions scarcely a star is to be seen, while in others they seem crowded together, especially in the milky way, where they appear, when viewed through a powerful telescope, to be crowded almost beyond imagination. Of the stars visible to the naked eye at any one time, the number probably does not exceed a few thousands, but in the telescope their number is so great as to defy all calculation; and, besides, there is every reason to believe that there are countless hosts which lie beyond the reach of the most powerful telescopes. The distances of the fixed stars from the earth are so great, that if we except one or two instances, perhaps still doubtful, all the attempts of astronomers to determine these distances have hitherto been fruitless. The double star 61 Cygni, is reckoned the nearest of the fixed stars, and its distance is computed to be 592,000 times the mean radius of the earth's orbit. The stars are observed to have motions of their own, and it is concluded that their proper motions are performed in circular or elliptic orbits, round some very remote centre. Many stars have been observed whose light appears to undergo a regular periodic increase and diminution of brightness, amounting, in some instances, to a complete extinction and revival. These are called *variable* and *periodic stars*. It is found that some stars, formerly distinguished by their splendour, have entirely disap-

peared; others have shone forth with extraordinary brilliancy, and, after a longer or shorter period, have gradually died away and become extinct. These are called *temporary stars*. Many of the stars are found, when observed with telescopes of high magnifying powers, to be composed of two, and some of them of three or more stars in close juxtaposition. These are termed *double* and *multiple stars*. There are certain irregular spots of pale light, and ill-defined figure, which occur frequently in the heavens. These are termed *nebulae*. Some of these are, by the aid of the telescope, resolvable into clusters of small stars; but there are others which are not wholly resolvable into separate stars; and there are others again in which there is no appearance whatever of stars. The stars are considered by astronomers to be suns, each of them forming the centre of a system, round which planets revolve. Their immense numbers exhibit the astonishing extent of creation and of divine power.—2. The pole-star. [A particular application, not in use.]—3. In *astrol.*, a configuration of the planets, supposed to influence fortune. Hence the expression, "You may thank your stars for such and such an event."

A pair of *star-cross'd* lovers. *Shak.*  
4. The figure of a star; a radiated mark in writing or printing; an asterisk; thus \*; used as a reference to a note in the margin, or to fill a blank in writing or printing where letters are omitted.—5. In *Scripture*, Christ is called the *bright and morning star*, the star that ushers in the light of an eternal day to his people; Rev. xxii.—Ministers are also called *stars in Christ's right hand*, as, being supported and directed by Christ, they convey light and knowledge to the followers of Christ; Rev. i.—The twelve stars which form the crown of the church, are the twelve apostles; Rev. xii.—6. The figure of a star; a decoration worn by knights.—7. A person or thing shining above others. Specially, a distinguished and brilliant theatrical performer.—8. In *her.*, the *estolle*, a charge frequently borne on the shield, which differs only from the *mullet*, in having its rays or points waved instead of straight. It usually has six points; but when the number is greater, the points are waved and straight alternately.—9. In *pyrotechny*, a composition of combustible matter, which, exploding high in the air, presents the appearance of a real star.—*Shooting* or *falling stars*, luminous meteors which dart through the sky in the form of a star.—*Star-fort*, or *star*, in *fort.*, a small fort having

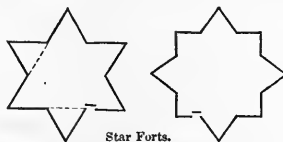

Star Forts.  
Hexagonal Star Fort. Octagonal Star Fort.

five or more points, or salient and entering angles flanking one another.

A *star-redoubt* is of the same form.—The *pole-star*, a bright star in the tail of *Ursa minor*, so called from its being very near the north pole.—*Star of Bethlehem*, the English name of three British plants of the genus *Ornithogalum*. They grow in pastures and woods. [See *ORNITHOGALUM*.] There is also the *star* of Alexandria, and of Naples, and of Constantinople, of the same genus.

STAR, *v. t.* To set or adorn with stars or bright radiating bodies; to bespangle; as, a robe *starred* with gems.

STAR-ANISE, *n.* The seeds of the *Illicium anisatum*, a plant inhabiting India, belonging to nat. order *Magnoliaceae*. They are considered in India to be powerfully stomachic and carminative. A very fragrant volatile oil is obtained from them. The Chinese burn them in their temples, and Europeans employ them to aromatize certain liquors, such as the Anisette de Bordeaux.

STAR-APPLE, *n.* The popular name of several species of *Chrysophyllum*, whose fruit is esculent. *Chrysophyllum Cainito* is the most important



Star Apple (*Chrysophyllum Cainito*).

species. It is a native of the West Indies. The fruit resembles a large apple, which in the inside is divided into ten cells, each containing a black seed, surrounded by a gelatinous pulp. It is eaten in the warm climates of America by way of dessert.

STAR-BLIND, *a.* Purlind; blinking.

STARBOARD, *n.* [Sax. *steor-board*; G. *steuerbord*, as if from *steuer*, the rudder or helm; D. *stuur-bord*, as if from *stuur*, helm; Sw. and Dan. *styr-bord*. But in Fr. *stribord*, Sp. *estribor*, Arm. *strybourz* or *stribourh*, are said to be contracted from *dexter-bord*, right-side. *Star-bord* is from *steer-bord*, the tiller being on the right hand of the steersman.] The right hand side of a ship or boat, when a spectator stands with his face toward the head, stem, or prow.

STARBOARD, *a.* Pertaining to the right hand side of a ship; being or lying on the right side; as, the *starboard* shrouds; *starboard* quarter; *starboard* tack. In *seamanship*, *starboard*, uttered by the master of a ship, is an order to the helmsman to put the helm to the starboard side. The term *larboard*, uttered in like manner, would imply an order to put the helm to the larboard side; but as the words *starboard* and *larboard* are apt to be mistaken, from their resemblance in sound,

it is usual to substitute the words *to part*, for *larboard*.

**STÄRCH**, *n.* [Sax. *stearc*, rigid, stiff; G. *stärke*, strength, starch, *stark*, strong. See **STARE** and **STERR**.] A proximate principle of plants, universally diffused in the vegetable kingdom, and of very great importance. It occurs in seeds, as in those of wheat and other cereal grains, and also in leguminous plants; in roots, as in the tubers of the potato; in the stem and pith of many plants, as in the sago plant; in some barks, as in that of cinnamon; and in pulpy fruits, such as the apple. Finally, it is contained in the expressed juice of most vegetables, such as the carrot, in a state of suspension, being deposited on standing. The starch of commerce is chiefly extracted from wheat flour. When pure, it is a snow-white powder, of a glistening appearance, which makes a crackling noise when pressed with the finger. It is composed of transparent rounded grains, the size of which varies in different plants; those of the potato being the largest, and those of wheat and rice the smallest. It is insoluble in cold water, alcohol, and ether; but when heated with water, it is converted into a kind of solution, which, on cooling, forms a stiff semi-opaque jelly. If dried up, this yields a translucent mass, which softens and swells into a jelly with water. The solution or mixture of starch and water strikes a deep blue colour with free iodine. Hence the solution of starch becomes an admirable test of the presence of iodine. Pure starch consists of 12 equivalents of carbon, 10 of hydrogen, and 10 of oxygen. It is employed for stiffening linen and other cloth. When roasted at a moderate heat in an oven, it is converted into a species of gum employed by calico printers; potato starch answers best for this purpose. Starch is convertible into sugar by dilute sulphuric acid. *Starch* forms the greatest portion of all farinaceous substances, particularly of wheat flour, and it is the chief ingredient of bread.—2. A stiff formal manner; starchiness.

**STÄRCH**, *a.* Stiff; precise; rigid.  
**STÄRCH**, *v. t.* To stiffen with starch.  
**STÄR-CHAMBER**, *n.* Formerly, a court of civil and criminal jurisdiction at Westminster, so named, it is said, from the roof of the apartment where it was held being ornamented with gilt stars. It was under the direction of the chancellor, and had jurisdiction of forgery, perjury, riots, maintenance, fraud, libel, and conspiracy, and, in general, of every misdemeanour, especially those of public importance, for which the law had provided no sufficient punishment. Its criminal jurisdiction (after its civil jurisdiction had gone into disuse) rendered it a powerful and odious auxiliary of a despotic administration. Its process was summary, and often iniquitous, and the punishment it inflicted often arbitrary and cruel. This court was abolished by statute 16 Charles I. **STÄRCHED**, *pp.* Stiffened with starch.—2. *a.* Stiff; precise; formal.

**STÄRCHEDNESS**, *n.* Stiffness in manners; formality.  
**STÄRCHER**, *n.* One who starches, or whose occupation is to starch. [*Little used*, except in the compound word *clear-starcher*,—which see.]

**STARCH-HYACINTH**, *n.* A plant, the *Muscari racemosum*, a native of Bri-

tain, and a garden plant in the United States.

**STÄRCHING**, *ppr.* Stiffening with starch.

**STÄRCHLY**, *adv.* With stiffness of manner; formally.

**STÄRCHNESS**, *n.* Stiffness of manner; preciseness.

**STÄRCHY**, *a.* Consisting of starch; resembling starch; stiff; precise.

**STÄR-CROWNED**, *a.* Crowned with stars.

**STÄRE**, *n.* [Sax. *stär*; G. *stahr*; Sw. *stare*.] A bird, the starling, or *Sturnus*.

**STÄRE**, *v. i.* [Sax. *starian*; G. *starren*. In Sw. *stirra ut fingren*, is to spread one's fingers. The sense then is to open or extend, and it seems to be closely allied to G. *starr*, stiff, and to *starch*, stern, which imply straining, tension.]

1. To gaze; to look with fixed eyes wide open; to fasten an earnest look on some object. *Staring* is produced by wonder, surprise, stupidity, horror, fright, and sometimes by eagerness to hear or learn something, sometimes by impudence. We say, he *stared* with astonishment.  
 Look not big, nor stare, nor fret. *Shak.*  
 2. To stand out; to be prominent.  
 Take off all the *staring* straws and jags in the hive.†  
*Mortimer.*  
 To stare in the face, to be before the eyes, or undeniably evident.  
 The law stares them in the face, while they are breaking it. *Locke.*

**STÄRE**, *n.* A fixed look with eyes wide open.

**STÄR-ENCIR'LED**, *a.* Encircled with stars.

**STÄRER**, *n.* One who stares or gazes.

**STÄR-FINCH**, *n.* A name given to the redstart.

**STÄR-FISH**, *n.* [*star* and *fish*.] A marine animal; the sea-star or Asterias, a genus of pedicellate echinoderms or zoophytes, so named because their body is divided into rays, generally five in number, in the centre of which and below is the mouth, which is the only orifice of the alimentary canal. They are covered with a coriaceous skin, armed with points or

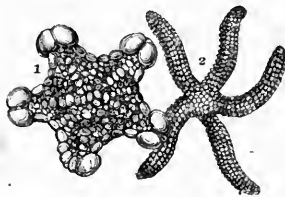

Star-Fish.

1. *Asterias cylindrica*. 2. *Asterias putchella*.

spines, and pierced with numerous small holes, arranged in regular series, through which pass membranaceous tentacula or feelers, terminated each by a little disc or cup, by means of which they execute their progressive motions.

**STÄR-FLOWER**, *n.* A plant of the genus *Ornithogalum*, the *O. umbellatum*, called also star of Bethlehem.

**STÄR-FORT**, *n.* See under **STAR**.

**STÄRGÄZER**, *n.* [*star* and *gazer*.] One who gazes at the stars; a term of contempt for an astrologer, sometimes used ludicrously for an astronomer.

**STÄRGÄZING**, *n.* The act or practice of observing the stars with attention; astrology.

**STÄR-GRÄSS**, *n.* [*star* and *grass*.] Starwort,—which see.

**STÄR-HYACINTH**, *n.* A plant of the genus *Scilla*, the *S. autumnalis*.

**STÄRING**, *ppr.* Gazing; looking with fixed eyes.

**STÄRINGLY**, *adv.* Gazingly.

**STÄR-JELLY**, *n.* A plant, a species of Tremella, one of the Fungi; also, starshoot, a gelatinous substance, which is also a Tremella.

**STÄRK**, *a.* [Sax. *sterc*, *stearc*; G. *stark*, stiff, strong; formed on the root of the G. *starr*, stiff, rigid, Eng. *stear*; from *straining*, *stretching*. See **STARCH** and **STERR**.] 1. Stiff; strong; rugged.

Many a nobleman lies stark and stiff, Under the hoofs of vaunting enemies. *Shak.*

The north is not so stark and cold.†  
*B. Jonson.*

2. Deep; full; profound; absolute.

Consider the stark security The commonwealth is in now.† *B. Jonson.*

3. Mere; gross; absolute.

He pronounces the citation stark nonsense. *Collier.*

**STÄRK**, *adv.* Wholly; entirely; absolutely; as, *stark* mad; *stark* blind; *stark* naked. These are the principal applications of this word now in use. The word is in popular use, but not an elegant word in any of its applications.

**STÄRKLY**,† *adv.* Stiffly; strongly.

**STÄR-LED**, *a.* Guided by the stars.

**STÄRLESS**, *a.* Having no stars visible or no starlight; as, a *starless* night.

**STÄRLIGHT**, *n.* [*star* and *light*.] The light proceeding from the stars.

Nor walk by moon Or glittering starlight, without thee is sweet. *Milton.*

**STÄRLIGHT**, *a.* Lighted by the stars, or by the stars only; as, a *startlight* evening.

**STÄRLIKE**, *a.* [*star* and *like*.] Resembling a star; stellated; radiated like a star; as, *starlike* flowers.—2. Bright; illustrious.

The having turned many to righteousness shall confer a *starlike* and immortal brightness. *Boyle.*

**STÄRLING**, *n.* [Sax. *stär*; Sw. *stare*.] *Sturnus*, a genus of insectorial birds, belonging to the conirostral family of Cuvier's great order Passeres. The common starling, *Sturnus vulgaris*, is



Starling (*Sturnus vulgaris*).

found in almost all parts of Europe; it is between eight and nine inches in length, and weighs about three ounces. The bill is nearly an inch and a half long; the colour is blackish, with blue, purplish, or cupreous reflections, and each feather is marked at the extremity with a whitish triangular speck, and these specks are the stars from which the name of the bird is derived.

The starlings are partly migratory and partly not. In the breeding season they are distributed in pairs, but in the winter season they assemble in flocks. They are often found on the tops of towers along with the pigeons; they nestle in holes of lonely walls, crannies of rocks, and openings in hollow trees. They are often kept in cages, and may be taught to whistle some tunes, and even to pronounce words and sentences.—*Starlings or sterlings, in arch.*, an assemblage of piles driven round the piers of a bridge to give it support. They are sometimes called *stillts*.

**STÄRLIT**, *a.* Lighted by stars.

**STÄR-MÖN''GER**, *n.* An astrologer; a quack.

**STÄR'ROST**, *n.* In *Poland*, a feudatory; one who holds a fief.

**STÄR'ROSTY**, *n.* A fief; an estate held by feudal service.

**STÄR-PAVED**, *a.* [*star* and *paved*.] Studded with stars.

The road of heaven *star-paved*. *Milton.*

**STÄR-PROOF**, *a.* [*star* and *proof*.] Impervious to the light of the stars; as, a *star-proof* elm.

**STÄR-READ**, † *n.* [*star* and *read*.] Doctrine of the stars; astronomy.

**STÄRED**, *pp.* or *a.* [*from star*.] Adorned or studded with stars; as, the *starred* queen of Ethiopia.—2. Influenced in fortune by the stars.

My third comfort,

*Starr'd* most unluckily. *Shak.*

3. Cracked, with many rays proceeding from a central point; as, a *starred* pane of glass or mirror.

**STÄR-REED**, *n.* A Peruvian plant of the genus *Aristolochia*, the *A. fragrantissima*, the root of which is highly esteemed in Peru, as a remedy against dysenteries, malignant inflammatory fevers, colds, rheumatic pains, &c.

**STÄRRING**, † *ppr.* or *a.* Adorning with stars.—2. Shining; bright; sparkling; as, *starring* comets.

**STÄRRING**, *n.* A cant term with actors, denoting the practice of a player of high name, who appears occasionally among actors of obscurer reputation, more especially in the provinces.

**STÄR-ROOF'ED**, *a.* Roofed with stars.

**STÄRRY**, *a.* [*from star*.] Abounding with stars; adorned with stars.

Above the clouds, above the *starry* sky. *Pope.*

2. Consisting of stars; stellar; stellary; proceeding from the stars; as, *starry* light; *starry* flame.—3. Shining like stars; resembling stars; as, *starry* eyes.

**STÄR-SHOOT**, *n.* [*star* and *shoot*.] A gelatinous substance often found in wet meadows, and formerly by some supposed to be the extinguished residuum of a shooting star. It is, however, not of meteoric, but of vegetable origin; being a fungus of the genus *Tremella*, the *T. nostoc*, Linn.

I have seen a good quantity of that jelly, by the vulgar called a *star-shoot*, as if it remained upon the extinction of a falling star. *Bacon.*

**STÄR-SPAN''GLED**, *a.* Spotted with stars; as, the *star-spangled* banner, or national flag, of the United States.

**STÄR-STONE**, *n.* A rare variety of sapphire. When cut, and viewed in a direction perpendicular to the axis, it presents a peculiar reflection of light in the form of a star.

**STÄRT**, *v. i.* [*D. storten*, to pour, to spill, to fall, to rush, to tumble; *Sv. storta*, to roll upon the head, to pitch

headlong; *qu. G. stürzen*. In Sax. *steert* is a tail, that is, a shoot or projection; hence the promontory so called in Devonshire. The word seems to be a derivative from the root of *star*, *steer*. The primary sense is to shoot, to dart suddenly, or to spring.] 1. To move suddenly, as if by a twitch; as, *to start* in sleep or by a sudden spasm.—2. To move suddenly, as by an involuntary shrinking from sudden fear or alarm.

I *start* as from some dreadful dream.

*Dryden.*

3. To move with sudden quickness, as with a spring or leap.

A spirit fit *to start* into an empire,

And look the world to law. *Dryden.*

4. To shrink; to wince.

But if he *start*,

It is the flesh of a corrupted heart. *Shak.*

5. To move suddenly aside; to deviate; generally with *from*, *out of*, or *aside*. Th' old drudging sun from his long beaten way

Shall at thy voice *start* and misguide the day. *Cowley.*

Keep your soul to the work when ready to *start aside*. *Watts.*

6. To set out; to commence a race, as from a barrier or goal. The horses *started* at the word, go.

At once they *start*, advancing in a line.

*Dryden.*

7. To set out; to commence a journey or enterprise. The public coaches *start* at six o'clock.

When *two start* into the world together.

*Collier.*

8. In *mar. lan.*, to punish by applying a rope's end to the back. [*See STARTING*.]—*To start up*, to rise suddenly, as from a seat or couch; or to come suddenly into notice or importance.

**STÄRT**, *v. t.* To alarm; to disturb suddenly; to startle; to rouse.

Upon malicious bravery dost thou come,

*To start* my quiet? *Shak.*

2. To rouse suddenly from concealment; to cause to flee or fly; as, *to start* a hare or a woodcock; *to start* game.—3. To bring into motion; to produce suddenly to view or notice.

Brutus will *start* a spirit as soon as Cesar.

*Shak.*

The present occasion has *started* the dispute among us.

*Leesley.*

So we say, *to start* a question, *to start* an objection; that is, to suggest or propose anew.—4. To invent or discover; to bring within pursuit.

Sensual men agree in the pursuit of every pleasure they can *start*. *Temple.*

5. To move suddenly from its place; to dislocate; as, *to start* a bone.

One *started* the end of the clavicle from the sternum. *Wiseman.*

6. In *mar. lan.*, to empty, as liquor from a cask; to pour out; as, *to start* wine into another cask.—*To start* a weight, or a heavy body, signifies to move it, as, *to start* the anchor.

**STÄRT**, *n.* A sudden motion of the body; a sudden twitch; a spastic affection; as, *a start* in sleep.—2. A sudden motion from alarm.

The fright awaken'd Arcite with *a start*.

*Dryden.*

3. A sudden rousing to action; a spring; excitement. Now fear I this will give it *start* again.

*Shak.*

4. Sally; sudden motion or effusion; a bursting forth; as, *starts* of fancy.

To check the *starts* and sallies of the soul.

*Addison.*

5. Sudden fit; sudden motion followed by intermission.

For she did speak in *starts* distractedly.

*Shak.*

Nature does nothing by *starts* and leaps, or in a hurry.

*L'Estrange.*

6. A quick spring; a darting; a shoot; a push; as, to give a *start*.

Both cause the string to give a quicker *start*.

*Bacon.*

7. First motion from a place; act of setting out; first motion in a race.

The *start* of first performance is all. *Bacon.*

You stand like greyhounds in the slips, Straining upon the *start*.

*Shak.*

*To get the start*, to begin before another; to gain the advantage in a similar undertaking.

*Get the start* of the majestic world. *Shak.*

She might have forsaken him, if he had not got the *start* of her.

*Dryden.*

**STÄRT**, *n.* A projection; a push; a horn; a tail. In the latter sense it occurs in the name of the bird *red-start*. Hence the *Start*, in Devonshire.

**STÄRT'ED**, *pp.* Suddenly roused or alarmed; poured out, as a liquid; discovered; proposed; produced to view.

**STÄRTER**, *n.* One that starts; one that shrinks from his purpose.—2. One that suddenly moves or suggests a question or an objection.—3. A dog that rouses game.

**STÄRTFUL**, *n.* Apt to start; skittish.

**STÄRTFULNESS**, *n.* Aptness to start.

**STÄR-THISTLE**, *n.* A plant of the genus *Centaurea*, the *C. calcitrapa*, which grows in gravelly, sandy, and waste places, in the middle and south of England, especially near the sea.—*Yellow star-thistle*, the *Centaurea solstitialis*, occasionally seen in fields and waste places, principally in the east and south of England, and near Dublin. It is also called *St. Barnaby's thistle*.—*Jersey star-thistle*, the *Centaurea isnerdi*, which grows in pastures in Jersey and Guernsey.

**STÄRTING**, *ppr.* Moving suddenly; shrinking; rousing; commencing, as a journey, &c.

**STÄRTING**, *n.* The act of moving suddenly.—2. A vulgar term for a summary mode of punishment, formerly inflicted on seamen, with a rope's end, for laziness, want of alacrity, &c.

**STÄRTING-HOLE**, *n.* A loophole; evasion.

**STÄRTINGLY**, *adv.* By sudden fits or starts.

**STÄRTING-PÖST**, *n.* [*start* and *post*.] A post, stake, barrier, or place from which competitors in a race start or begin the race.

**STÄRTISH**, *a.* Apt to start; skittish; shy.

**STÄRTLE**, *v. i.* [*dim. of Start*.] To shrink; to move suddenly or be excited on feeling a sudden alarm.

Why *shrinks* the soul

Back on herself, and *startles* at destruction? *Addison.*

**STÄRTLE**, *v. t.* To impress with fear; to excite by sudden alarm, surprise, or apprehension; to shock; to alarm; to fright. We were *startled* at the cry of distress. Any great and unexpected event is apt to *startle* us.

The supposition that angels assume bodies, need not *startle* us. *Locke.*

2. To deter; to cause to deviate. [*Lit. us.*] **STÄRTLE**, *n.* A sudden motion or shock occasioned by an unexpected

alarm, surprise, or apprehension of danger; sudden impression of terror.

After having recovered from my first *startle*, I was well pleased with the accident.

*Spectator.*

**STARTLED**, *pp.* Suddenly moved or shocked by an impression of fear or surprise.

**STARTLING**, *ppr.* Suddenly impressing with fear or surprise.

**STARTLINGLY**, *adv.* In a startling manner.

**STARTUP**, *† n.* [*start and up.*] One that comes suddenly into notice. [*We use upstart.*]—2. A kind of high shoe.

**STARTUP**, *† a.* Suddenly coming into notice.

**STARVA'TION**, *n.* The act of starving or state of being starved.

**STARVE**, *v. i.* [*Sax. stearfian*, to perish with hunger or cold; *G. sterben*, to die, either by disease or hunger, or by a wound; *D. sterven*, to die. *Qu.* is this from the root of *Dan. tarve*, *Sw. tarf*, necessity, want?] 1. *†* To perish; to be destroyed.—2. To perish or die with cold; as, to *starve* with cold.—3. To perish with hunger.—4. To suffer extreme hunger or want; to be very indigent. Sometimes virtue *starves*, while vice is fed.

*Pope.*

**STARVE**, *v. t.* To kill with hunger. Maliciously to *starve* a man is, in law, murder.—2. To distress or subdue by famine; as, to *starve* a garrison into a surrender.—3. To destroy by want; as, to *starve* plants by the want of nutriment.—4. To kill with cold.

From beds of raging fire to *starve* in ice  
Their soft ethereal warmth. *Milton.*

5. To deprive of force or vigour.

The powers of their minds are *starved* by disuse. [*Unusual.*]

*Locke.*

**STARVED**, *pp.* Killed with hunger; subdued by hunger; rendered poor by want.—2. Killed by cold.—3. In *her.*, a term used to denote a branch of a tree when stripped of all its leaves.

**STARVELING**, *a.* (*stärving.*) Hungry; lean; pining with want.

**STARVELING**, *n.* (*stärving.*) An animal or plant that is made thin, lean, and weak through want of nutriment. And thy poor *starveling* beautifully fed.

*Donne.*

**STARVING**, *ppr.* Perishing with hunger; killing with hunger; rendering lean and poor by want of nourishment.—2. Perishing with cold; killing with cold.

**STÄR-WÖRT**, *n.* The popular name of three British annual plants of the genus *Callitriche*; known also by the name of water star-wort. They are obscure floating plants, of no known use.—*Sea star-wort*, a British herbaceous plant of the genus *Aster*, the *A. tripolium*. It has large purple flowers with a yellow disk, and grows in salt-marshes.

**STÄTANT**, *ppr.* In *her.*, a term for beasts when borne in a standing position, with all four legs upon the ground; as, a lion *stätant*.



Statant.

**STÄTARY**, *† a.* [*from stät.*] Fixed; settled.

**STÄTE**, *n.* [*L. status*, from *sto*, to stand, to be fixed; *Fr. état*. Hence *G. stät*, fixed; *stätt*, place, abode, stence; *stätt*, state; *stätt*, a town or city; *D. stätt*, condition, state; *stätt*, a city, Sans.

*stidaha*, to stand. *State* is fixedness or standing.] 1. Condition; the circumstances of a being or thing at any given time. These circumstances may be internal, constitutional, or peculiar to the being, or they may have relation to other beings. We say, the body is in a sound *state*, or it is in a weak *state*; or it has just recovered from a feeble *state*. The *state* of his health is good. The *state* of his mind is favourable for study. So we say, the *state* of public affairs calls for the exercise of talents and wisdom. In regard to foreign nations, our affairs are in a good *state*. So we say, single *state*, and married *state*.

Declare the past and present *state* of things.

*Dryden.*

2. Modification of any thing.

Keep the *state* of the question in your eye.

*Boyle.*

3. Crisis; stationary point; height; point from which the next movement is regression.

Tumors have their several degrees and times, as beginning, augment, *state* and declination.†

*Wiseman.*

4. *†* Estate; possession. [*See ESTATE.*]

5. A political body, or body politic; the whole body of people united under one government, whatever may be the form of the government.

Municipal law is a rule of conduct prescribed by the supreme power in a *state*.

*Blackstone.*

More usually the word signifies a political body governed by representatives; a commonwealth; as, the *States* of Greece; the *States* of America. In this sense, *state* has sometimes more immediate reference to the government, sometimes to the people or community.

Thus when we say, the *state* has made provision for the paupers, the word has reference to the government or legislature; but when we say, the *state* is taxed to support paupers, the word refers to the whole people or community.—6. *State* or *estate*, any body of men united by profession, or constituting a community of a particular character, who partake either directly or by representation in the government of their country. In European governments the whole body politic is divided into states or estates. The number of these has varied in different countries.

In France and most other feudal kingdoms, there have been three estates, nobles, clergy, commonalty, the last of which is called *tiers état*, (third estate). In Sweden there are four estates, nobility, clergy, citizens, peasants. In modern monarchical constitutions, the English system of government, by king, lords, and commons, or analogous powers, has prevailed. *Church* and *state*, the ecclesiastical, and civil communities, as distinct from each other.

—7. Rank; condition; quality; as, the *state* of honour.—8. Pomp; appearance of greatness. In *state* the monarchs march'd. *Dryden.* Where least of *state*, there most of love is shown. *Dryden.*

9. Dignity; grandeur. She instructed him how he should keep *state*, yet with a modest sense of his misfortunes. *Bacon.*

10. A seat of dignity. This chair shall be my *state*. *Shak.*

11. A canopy; a covering of dignity. His high throne, under *state* Of richest texture spread. [*Unusual.*]

*Milton.*

12. *†* A person of high rank.—13. The principal persons in a government.

The bold design

Pleas'd highly those infernal *states*.

*Milton.*

14. The bodies that constitute the legislature of a country; as, the *states* general.—15. Joined with another word, it denotes public, or what belongs to the community or body politic; as, *state* affairs; *state* policy.

**STATE**, *v. t.* To set; to settle. [*See STATED.*]—2. To express the particulars of any thing in writing; to set down in detail or in gross; as, to *state* an account; to *state* debt and credit; to *state* the amount due.—3. To express the particulars of any thing verbally; to represent fully in words; to narrate, to recite. The witnesses *stated* all the circumstances of the transaction. They are enjoined to *state* all the particulars.

It is the business of the advocate to *state* the whole case. Let the question be fairly *stated*.

**STATE'-CRAFT**, *n.* Statesmanship. [*In contempt.*]

**STATE-CRIMINAL**, *n.* A political offender.

**STATED**, *pp.* Expressed or represented; told; recited.—2. *a.* Settled; established; regular; occurring at regular times; not occasional; as, *stated* hours of business.—3. Fixed; established; as, a *stated* salary.

**STATEDLY**, *adv.* Regularly; at certain times; not occasionally. It is one of the distinguishing marks of a good man, that he *statedly* attends public worship.

**STATELESS**, *a.* Without pomp.

**STATELIER**, *a.* More lofty or majestic.

**STATELINESS**, *n.* [*from stately.*] Grandeur; loftiness of mien or manner; majestic appearance; dignity.

For *stateliness* and majesty, what is comparable to a horse? *More.*

2. Appearance of pride; affected dignity.

**STATELY**, *a.* Lofty; dignified; majestic; as, *stately* manners; a *stately* gait.—2. Magnificent; grand; as, a *stately* edifice; a *stately* dome; a *stately* pyramid.—3. Elevated in sentiment.

**STATELY**, *adv.* Majestically; loftily.

**STATEMENT**, *n.* The act of stating, reciting, or presenting verbally or on paper.—2. A series of facts or particulars expressed on paper; as, a written *statement*.—3. A series of facts verbally recited; recital of the circumstances of a transaction; as, a verbal *statement*.

**STATE-MÖNGER**, *n.* [*state* and *monger*.] One versed in politics, or one that dabbles in state affairs.

**STATE-PÄPER**, *n.* A paper relating to the political interests or government of a state.

**STATE-PRIS'ON**, *n.* A jail for political offenders only.—A prison or penitentiary in one of the United States.

**STATE PRIS'ONER**, *n.* One confined for a political offence.

**STATER**, *n.* One who states.—2. Another name of the daric, an ancient silver coin, weighing about four Attic drachms, value three shillings sterling.

The Attic gold stater, which was in general circulation in the republican times of Greece, weighed two drachms, and its value was estimated at twenty silver drachms, or 16s. 3d. of our money, but the value of the stater varied greatly in different states. The term stater was also applied to weight,

meaning apparently, any standard of weight.

**STATE-ROOM**, *n.* [*state and room.*] A magnificent room in a palace or great house.—2. An apartment for lodging in a ship's cabin.

**STATES**, *n. plur.* Nobility. [*See STATE*]—*States General*, in French history, the assembly of the three orders of the kingdom, viz. the clergy, the nobility, and the third estate or commonalty. But the term is generally understood of the estates of the kingdom of the Netherlands, which at present consist of two chambers, and are called *States General* to distinguish them from the states of the several provinces.—*States of the Church*, the pope's dominions in Italy.

**STATESMAN**, *n.* [*state and man.*] A man versed in the arts of government; usually, one eminent for political abilities; a politician.—2. A small landholder. [*Local.*]—3. One employed in public affairs.

**STATESMANLIKE**, *a.* Having the manner or wisdom of statesmen.

**STATESMANSHIP**, *n.* The qualifications or employments of a statesman.

**STATESWOMAN**, *n.* A woman who meddles in public affairs. [*In contempt.*]

**STATE-TRIAL**, *n.* A trial of a person or persons for political offences.

**STATIC**, } *a.* [*See STATICS.*] **RE-**  
**STATICAL**, } lating to the science of weighing bodies; as, a *static balance* or engine.—2. Pertaining to statics, or the science of forces in equilibrium; as, *static pressure*.

**STATICE**, *n.* Thrift, a genus of plants of the class Pentandria, and order Pentagynia, Linn.; nat. order Plumbaginaceæ. The species are perennial herbs, mostly natives of the South of Europe. Five belong to Britain. *S. armeria*, (or *Armeria maritima*), common thrift, or sea gillyflower, grows on muddy sea shores, among rocks by the sea side, and upon tops of our highest mountains. It has heads of flowers of a rose colour. *S. limonium*, spreading-spiked thrift or sea lavender, grows on the muddy sea shores and salt marshes of England and Ireland; rare in Scotland. It has blue flowers, and is used as edgings to flower borders. Many of the statices are amongst the most lovely herbaceous plants known, and are therefore much prized as garden plants.

**STATICS**, *n.* [*Fr. statique; L. statice; Gr. staticon.*] 1. That branch of mechanics which considers bodies as acted on by forces which are in equilibrium, or which produce equilibrium; or it has for its object the investigation of the conditions under which several forces or pressures applied to a rigid body mutually destroy each other. It thus stands opposed to *dynamics*, in which the effects of forces producing motion are investigated. Statics is subdivided into the statics of rigid and of fluid bodies, the latter being called hydrostatics. The two great propositions in statics are that of the lever, and that of the composition of forces, but it also comprehends all the doctrines of the excitement and propagation of forces or pressures, through the parts of solid bodies by which the energies of machines are produced. It teaches us the intensities and directions of all such pressures; and how much remains at the working point of a machine unbalanced by resistance. It

comprehends every circumstance which influences the stability of heavy bodies; the investigation and properties of the centre of gravity; the theory of the construction of arches, vaults, and domes; the attitudes of animals. It also comprehends the strength of materials, and the principles of construction, so as to make the proper adjustment of strength and strain in every part of a machine, edifice, or structure of any kind.—2. The science which considers the weights of bodies.—3. In *med.*, a kind of epileptics, or persons seized with epilepsy.

**STATING**, *n.* An act of making a statement; a statement.

**STATION**, *n.* [*Fr. from L. statio, from sto, status; It. stazione; Sp. estacion.*] 1. The act of standing.

Their manner was to stand at prayer... on which their meetings for that purpose received the name of *stations*.† *Hooker*.  
2. A state of rest.

All progression is performed by drawing on or impelling forward what was before in *station* or at quiet. [*Rare.*] *Brown*.

3. The spot or place where one stands, particularly where a person habitually stands, or is appointed to remain for a time; as, the *station* of a sentinel. Each detachment of troops had its *station*.—4. Post assigned; office; the part or department of public duty which a person is appointed to perform. The chief magistrate occupies the first political *station* in a nation. Other officers fill subordinate *stations*. The office of bishop is an ecclesiastical *station* of great importance. It is the duty of the executive to fill all civil and military *stations* with men of worth.—5. Situation; position.

The fig and date, why love they to remain  
In middle *station*? *Prior*.

6. Employment; occupation; business. By spending the sabbath in retirement and religious exercises, we gain new strength and resolution to perform God's will in our several *stations* the week following. *Nelson*.

7. Character; state. The greater part have kept their *station*. *Milton*.

8. Rank; condition of life. He can be contented with a humble *station*.—9. In *practical geometry*, the place selected for planting the instrument with which an observation is to be made, an angle taken, or such like; as in surveying, levelling, measuring heights and distances, &c.—10. In *astron.*, a planet is said to be at its *station*, or to be *stationary*, when its motion in right ascension ceases, or its apparent place in the ecliptic remains for a few days unaltered. This happens when the planet changes from the direct to the retrograde motion, or the contrary.—*Naval station*, a safe and commodious shelter or harbour, for the warlike or commercial ships of a nation, where there is a dock yard, and every thing requisite for the repair of ships.—*Military station*, a place where troops are posted.—11. In *church history*, the fast of the fourth and sixth days of the week, Wednesday and Friday, in memory of the council which condemned Christ, and of his passion.—12. In the *church of Rome*, a church where indulgences are to be had on certain days.—In *Roman Catholic ceremonies*, the points at which processions stand when making the round of the interior of a church; as, at each

*station* they repeated a Paternoster and an Ave.—13. A halting-place, intermediate between the termini of a railway, where passengers are taken up and let down; also, though less appropriately, a railway terminus.

**STATION**, *v. t.* To place; to set; or to appoint to the occupation of a post; place, or office; as, to *station* troops on the right or left of an army; to *station* a sentinel on a rampart; to *station* ships on the coast of Africa or in the West Indies; to *station* a man at the head of the department of finance.

**STATIONAL**, *a.* Pertaining to a station.

**STATIONARINESS**, *n.* The quality of being stationary; fixity.

**STATIONARY**, *a.* Fixed; not moving; progressive or regressive; not appearing to move. The sun becomes *stationary* in Cancer, in its advance into the northern signs. The planets appear to be stationary, or to have no relative motion for a little time at the beginning and end of their retrogradation. [*See STATION.*] The court in England, which was formerly itinerary, is now *stationary*.—2. Not advancing, in a moral sense; not improving; not growing wiser, greater, or better; not becoming greater or more excellent.—3. Respecting place.

The same harmony and *stationary* constitution. *Brown*.

*Stationary engine*, in contradistinction to a *locomotive engine*, is a steam engine in a fixed position, which draws loads on a railway by means of a rope or other means of communication, extending from the *station* of the engine, along the line of road.—*Stationary fever*, a fever depending on peculiar seasons.

**STATION-BILL**, *n.* In *seamen's language*, a list containing the appointed posts of the ship's company, when *navigating* the ship.

**STATIONER**, *n.* [*from station, a state.*] A bookseller; one who sells books, paper, quills, inkstands, pencils, and other furniture for writing. The business of the bookseller and stationer is usually carried on by the same person. The term *stationer* is derived from the business of booksellers having been anciently carried on entirely in stalls or *stations*.

**STATIONERY**, *n.* The articles usually sold by stationers, as the various materials employed in writing, especially paper, ink, quills, &c. [Sometimes, but vulgarly, spelt *stationary*.]

**STATIONERY**, *a.* Belonging to a stationer.—*Stationery office*, an office in London which is the medium through which all government offices, both at home and abroad, are supplied with writing materials. It also contracts for the printing of all reports, and other matters laid before the house of commons.

**STATION-HOUSE**, *n.* A place of arrest, or temporary confinement.—2. A depot on a railway. [In the latter sense, *station* is more common.]

**STATION POINTER**, *n.* In *maritime surveying*, an instrument for expeditiously laying down on a chart the position of a place, from which the angles subtended by three distant objects, whose positions are known, have been measured.

**STATION-STAFF**, *n.* An instrument used by surveyors.

**STATISM**, *n.* Policy; art of government.

**STA'TIST, n.** [from *state*.] A statesman; a politician; one skilled in government.

*Statists* indeed,

And lovers of their country.† *Millen.*  
**STATIST'IC,** } *a.* [from *state* or  
**STATIST'ICAL,** } *statist.*] Pertaining to the state of society, the condition of the people, their economy, their property, and resources.

**STATISTI'CIAN, n.** One versed in statistics.

**STATISTICS, n.** That part of political science which is concerned in collecting and arranging facts illustrative of the condition and resources of a state or country, chiefly in relation to its extent, population, industry, wealth, and power. A *statistical* account of a country, signifies a work describing its extent and population; its natural and acquired capacities of production; the occupation of the different classes of its inhabitants, with their respective incomes; the progress of agriculture, of manufactures, and of internal and foreign trade; its institutions for government, improvement, defence, and maintenance of the population; the amount of taxation for the public service; the health and longevity of the inhabitants, the condition of the poor, the state of schools, and other public institutions of utility; with a variety of subsidiary statements and details. Statistics has many features in common with geography and politics. A correct and complete statistical account of a country, is obviously of vast utility to the government and legislature.

**STA'TIVE, a.** Pertaining to a fixed camp.

**STAT PRO RATIONE VOLUNTAS,** [L.] The will stands for reason.

**STAT'UARY, n.** [It. *statuaria*; from L. *statuarius*, from *statua*, a statue; *statuo*, to set.] 1. The art of carving images, as representatives of real persons or things; a branch of sculpture. [In this sense the word has no plural.—2. [It. *statuario*.] One that professes or practises the art of carving images or making statues.

On other occasions the *statuaries* took their subjects from the poets. *Addition.*

**STAT'UE, n.** [L. *statua*; *statuo*, to set; that which is set or fixed.] In *sculp.*, an image; a representation of a human figure or animal, in relief in some solid substance, as marble, bronze, iron, wood, &c., or in some apparently solid substance. Statues have been divided into four kinds: those smaller than nature; those of the same size as nature; those larger than nature; colossal statues; or those three or more times larger than nature.—*Equestrian statues*, those in which the figure is seated on a horse.

**STAT'UE, v. t.** To place, as a statue; to form a statue of.

**STATU'MINATE, † v. t.** [L. *statumino*.] to prop or support.

**STATU' QUO.** [L.] In the former state; as things were before.

**STAT'URE, n.** [L. and It. *statura*; Fr. *stature*; from L. *statuo*, to set.] The natural height of an animal body. It is more generally used of the human body.

Foreign men of mighty *stature* came. *Dryden.*

**STAT'URED, a.** Arrived at full stature. [Little used.]

**STA'TUS, n.** [L.] A standing; state, circumstance, rank, or condition.—*status quo*; the condition in which the

thing or things were at first; as, a treaty between belligerents, which leaves each party *in statu quo ante bellum*; that is, with the same possessions and rights they had before the war began.

**STAT'UTABLE, a.** [from *statute*.] Made or introduced by statute; proceeding from an act of the legislature; as, a *statutable* provision or remedy.—2. Made or being in conformity to statute; as, *statutable* measures.

**STAT'UTABLY, adv.** In a manner agreeable to statute.

**STAT'UTE, n.** [Fr. *statut*; L. *statutum*; from *statuo*, to set.] 1. An act of parliament made by the king by and with the advice of the lords and commons. Statutes are either public or private; but the term is usually restricted to public acts, of a general and permanent character. Statutes are said to be *declaratory* of the law as it stood before their passing; *remedial*, to correct defects in the common law, and *penal*, imposing prohibitions and penalties.—*Statutes of the realm*, a body of enactments contained in three volumes, preserved in the court of exchequer, and now in the custody of the master of the rolls. One volume contains the statutes passed before the beginning of the reign of Edward III.; and the other two, those from 1 Edward III. to 7 Henry VIII., all very fairly written.—*Statutes of limitation*, statutes for establishing the limitations of actions in the English law. *Statutes* are distinguished from *common law*. The latter owes its binding force to the principles of justice, to long use, and the consent of a nation. The former owe their binding force to a positive command or declaration of the supreme power. *Statute* is commonly applied to the acts of a legislative body consisting of representatives. In monarchies not having representative bodies, the laws of the sovereign are called *edicts, decrees, ordinances, rescripts, &c.*—2. A special act of the supreme power, of a private nature, or intended to operate only on an individual or company.—3. The act of a corporation or of its founder, intended as a permanent rule or law; as, the *statutes* of a university.—*Statute labour*, in *Scots law*, is the amount of work appointed by law to be furnished annually for the repair of highways not turnpike. The joint board of justices of peace and commissioners of supply, has full powers in determining the roads to be repaired, and in apportioning and commuting statute labour.

**STAT'UTE-BOOK, n.** A register of laws or legislative acts.

**STAT'UTE-FAIR, n.** A fair held by regular legal appointment, in contradistinction to one authorized only by use and wont.

**STAT'UTE-MERCHANT, n.** In *English law*, a bond of record pursuant to the Stat. 13 Edward I. acknowledged before one of the clerks of the statutes-merchant and the mayor or chief warden of London, or before certain persons appointed for the purpose; on which, if not paid at the day, an execution may be awarded against the body, lands, and goods of the obligor.

**STAT'UTE-STAPLE, n.** A bond of record acknowledged before the mayor of the staple, by virtue of which the creditor may forthwith have execution against the body, lands, and goods of the debtor, on non-payment.

**STAT'UTORY, a.** Enacted by statute; depending on statute for its authority; as, a *statutory* provision or remedy.

**STAUNCH.** See STANCH.

**STAUROLITE, n.** [Gr. *σταυρος*, a cross, and *λίθος*, stone.] A mineral called also *cross-stone* and *harmotome*. It is a silicate of baryta and alumina, with traces of lime and potash. [See CROSS-STONE.]

**STAUROTIDE, n.** [Gr. *σταυρος*, a cross, and *ίδος*, form.] The name given by Haüy and other mineralogists to prismatic garnet or grenatite. It occurs crystallized in four and six-sided prisms, sometimes intersecting each other at right angles. Its colours are reddish-brown to blackish-brown. Specific gravity from 3.3 to 3.9. Its fracture is uneven, or imperfectly conchoidal. It consists of silica, alumina, lime, and the oxides of iron and manganese. It occurs in primary rocks, and is distinguished from garnet by its form and difficult fusibility. It is often confounded with staurolite.

**STAUROTYPOUS, a.** [Gr. *σταυρος*, a cross, and *τυπος*, form.] In *mineral.*, having its macles or spots in the form of a cross.

**STAVE, n.** [from *staff*; Fr. *douve, douvain*.] It has the first sound of *a*, as in *save*. 1. A thin, narrow piece of timber, of which casks are made. *Staves* are imported, in considerable quantities, into Britain from America.—2. A staff; a metrical portion; a part of a psalm appointed to be sung in churches.—3. In *music*, the five horizontal and parallel lines on which the notes of tunes are written or printed; the *staff*, as it is now more generally written.—4. The small upright cylindrical spars, which form a rack to contain the hay in stables for feeding horses, are termed *staves*. Sometimes, also, they are called *rounds*.

**STAVE, v. t. pret. Stove or Staved;** pp. *id.* 1. To break a hole in; to break; to burst; primarily, to thrust through with a staff; as, to *stave* a cask.—2. To push, as with a staff; with *off*.

The condition of a servant *staves* him *off* to a distance.

3. To delay; as, to *stave off* the execution of a project.—4. To pour out; to suffer to be lost by breaking the cask.

All the wine in the city has been *staved*.

5. † To furnish with staves or rundles.

6. To make firm by compression. The term is applied to the compressing of lead by a hammer or a blunt chisel, after it has been run in to secure a joining, such as the socket joints of pipes.

**STAVE, † v. i.** To fight with staves.

**STAVESACRE, n.** A plant; larkspur.

**STAVESWOOD, n.** A tall West Indian tree; quassia.

**STAY, v. i. pret. Staid, for Stayed.** [Ir. *stadam*; Sp. *estay*, a stay of a ship; *estada*, stay, a remaining; *estiar*, to stop; Port. *estada*, abode; *estae*, stays of a ship; *estear*, to stay, to prop; W. *ystad*, state; *ystadu*, to stay or remain; Fr. *etai, etayer*. This word seems to be connected with *state*, and if so, is a derivative from the root of L. *sto*, to stand. But from the orthography of this word in the Irish, Spanish, and Portuguese, and of *steti*, the preterit of *sto*, in Latin, may be the elementary word *stad* or *stat*. The sense is to set, stop, or hold. It is to be observed further, that stay may be easily deduced from the G. and D. *stag*, a stay;

*stay-segel*, stay-sail; *W. tagu*, to stop.]  
 1. To remain; to continue in a place; to abide for any indefinite time. Do you *stay* here, while I go to the next house. *Stay* here a week. We *staid* at the Hotel Montmorenci in Paris. *Stay*, I command you; *stay* and hear me first. *Dryden*.  
 2. To continue in a state. The flames augment, and *stay* At their full height, then languish to decay. *Dryden*.  
 3. To wait; to attend; to forbear to act. I *stay* for Turnus. *Dryden*.  
 Would ye *stay* for them from having husbands? *Ruth*.  
 4. To stop; to stand still. She would command the hasty sun to *stay*. *Spenser*.

5. To dwell. I must *stay* a little on one action. *Dryden*.  
 6. To rest; to rely; to confide in; to trust. Because ye despise this word, and trust in oppression, and *stay* thereon; Is. xxx. **STAY**, *v. t. pret. and pp. Staid*, for *Stayed*. 1. To stop; to hold from proceeding; to withhold; to restrain.

All that may *stay* the mind from thinking that true which they heartily wish were false. *Hooker*.

To *stay* these sudden gusts of passion. *Rowe*.  
 2. To delay; to obstruct; to hinder from proceeding. Your ships are *staid* at Venice. *Shak*.  
 I was willing to *stay* my reader on an argument that appeared to me to be new. *Locke*.

3. To keep from departure; as, you might have *staid* me here.—4. To stop from motion or falling; to prop; to hold up; to support. Aaron and Hur *stayed* up his hands; Exod. xvii. *Salloos* and reeds for vineyards useful found To *stay* thy vines. *Dryden*.  
 5. To support from sinking; to sustain with strength; as, to take a luncheon to *stay* the stomach.—6. In *mar. lan.*, to tack; to arrange the sails and move the rudder so as to bring the ship's head to the direction of the wind.

**STAY**, *n.* Continuance in a place; abode for a time indefinite; as you make a short *stay* in the city. Embrace the hero, and his *stay* implore. *Waller*.  
 2. Stand; stop; cessation of motion or progression. Affairs of state seemed rather to stand at a *stay*. *Huyward*.  
 [But in this sense, we now use *stand*; to be at a *stand*.]—3. Stop; obstruction; hindrance from progress. Grieved with each step, tormented with each *stay*. *Fairfax*.  
 4. Restraint of passion; moderation; caution; steadiness; sobriety. With prudent *stay*, he long deferr'd The rough contention. *Philips*.  
 5. A fixed state. Alas, what *stay* is there in human state! *Dryden*.  
 6. Prop; support. Trees serve as so many *stays* for their vines. *Addison*.  
 My only strength and *stay*! *Milton*.  
 The Lord is my *stay*; Ps. xviii.  
 The *stay* and the *staff*, the means of supporting and preserving life; Is. liii.—7. In *arch.*, a piece performing the office of a brace, to prevent the swerving of the piece to which it is applied.  
 8. Steadiness of conduct.—9. *Stays*, in ships, are large ropes used to support masts, and leading from the head

of some mast down to some other mast, or to some part of the vessel.

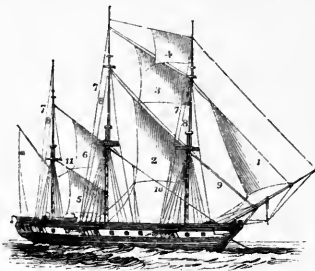

Stays and Stay Sails

- |                                |  |
|--------------------------------|--|
| 1. Fore top-mast stay sail.    | 7. 8. Fore, main, and mizzen top-mast and top-gallant mast back stays. |
| 2. Main top-mast stay sail.    |  |
| 3. Main top-gallant stay sail. |  |
| 4. Main royal stay sail.       | 9. Fore stay.  |
| 5. Mizzen stay sail.           | 10. Main stay.   |
| 6. Mizzen top-mast stay sail.  | 11. Mizzen stay.   |

Those which lead forward are called *lead-and-aft stays*; and those which lead down to the vessel's sides, *back-stays*.—*Spring stays*, a kind of assistant stays extending in a direction nearly parallel to the principal stays. They are only used to the lower-masts and top-masts.—*In stays*, or *hove in stays*, the situation of a vessel when she is *staying*, or going about from one tack to the other.—*To miss stays*, to fall in the attempt to tack about.

**STAYED**, *pp.* *Staid*; fixed; settled; sober. It is now written *staid*,—*which see*.

**STAYEDLY**, *adv.* Composedly; gravely; moderately; prudently; soberly.

**STAYEDNESS**, *n.* Moderation; gravity; sobriety; prudence. [See **STADINESS**.]—2. Solidity; weight. [Little used.]

**STAYER**, *n.* One that stops or restrains; one who upholds or supports; that which props.

**STAY-HOLES**, *n.* Holes made through stay-sails, at certain distances along the top, through which they are seized to the hanks of the stay.

**STAYLACE**, *n.* A lace for fastening the boddice in female dress.

**STAYLESS**, *a.* Without stop or delay. [Little used.]

**STAYMAKER**, *n.* One whose occupation is to make stays.

**STAYS**, *n. plur.* A boddice; a kind of waistcoat stiffened with whalebone or other material, worn by females.—2. *Stays*, of a ship. [See **STAY**.]—3. Station; fixed anchorage.—4. Any support; that which keeps another extended. Weavers, stretch your *stays* upon the web. *Dryden*.

**STAY-SAIL**, *n.* [*stay* and *sail*.] Any sail which hoists upon a stay.

**STAY-SAIL**, *n.* A fore-and-aft sail which is hoisted upon a stay.

**STAY-TACKLE**, *n.* [*stay* and *tackle*.] A large tackle attached to the mainstay by means of a pendant, and used to hoist heavy bodies, as boats, butts of water, and the like.

**STEAD**, *n.* [Goth. *stads*; Sax. and Dan. *sted*; G. *statt*; D. *stede*. See **STAY**.] 1. Place; in general. *Spenser*.  
 Fly this fearful *stead*.  
 2. Place or room which another had or might have, noting substitution, replacing or filling the place of another;

as, David died and Solomon reigned in his *stead*.

God hath appointed me another seed in *stead* of Abel, whom Cain slew; Gen. iv.  
 3. The frame on which a bed is laid. Swallow the feet, the borders, and the *stead*. *Dryden*.

[But we never use this word by itself in this sense. We always use *bedstead*.]—*To stand in stead*, to be of use or great advantage.

The smallest act of charity shall *stand* us in great *stead*. *Atterbury*.

**STEAD**, **STED**, in names of places distant from a river or the sea, signifies *place*, as above; but in names of places situated on a river or harbour, it is from Sax. *stathe*, border, bank, shore. Both words perhaps are from one root.

**STEAD**, *v. t. (sted)*. To help; to support; to assist; as, it nothing *steads* us.—2. To fill the place of another. **STEADFAST**, *a.* [*stead* and *fast*.]

**STEDFAST**, *a.* Fast fixed; firm; firmly fixed or established; as, the *steadfast* globe of earth.—2. Constant; firm; resolute; not fickle or wavering. Abide *steadfast* to thy neighbour in the time of his trouble. *Ecclus*.

Him resist, *steadfast* in the faith; 1 Pet. v.

3. Steady; as, *steadfast* sight.

**STEADFASTLY**, *adv.* Firmly; with constancy or steadiness of mind.

*Steadfastly* believe that whatever God has revealed is infallibly true. *Wake*.

**STEADFASTNESS**, *n.* Firmness of standing; fixedness in place.—2. Firmness of mind or purpose; fixedness in principle; constancy; resolution; as, the *steadfastness* of faith. He adhered to his opinions with *steadfastness*.

**STEADILY**, *adv.* With firmness of standing or position; without tottering, shaking, or leaning. He kept his arm *steadily* directed to the object.—2. Without wavering, inconstancy, or irregularity; without deviating. He *steadily* pursues his studies.

**STEADINESS**, *n.* Firmness of standing or position; a state of being not tottering or easily moved or shaken. A man stands with *steadiness*; he walks with *steadiness*.—2. Firmness of mind or purpose; constancy; resolution. We say, a man has *steadiness* of mind, *steadiness* in opinion, *steadiness* in the pursuit of objects.—3. Consistent uniform conduct.

*Steadiness* is a point of prudence as well as of courage. *L'Estrange*.

**STEADY**, *a.* [Sax. *stedig*.] 1. Firm in standing or position; fixed; not tottering or shaking; applicable to any object.—2. Constant in mind, purpose, or pursuit; not fickle, changeable, or wavering; not easily moved or persuaded to alter a purpose; as, a man *steady* in his principles, *steady* in his purpose, *steady* in the pursuit of an object, *steady* in his application to business.—3. Regular; constant; undeviating; uniform; as, the *steady* course of the sun. Steer the ship a *steady* course. A large river runs with a *steady* stream.—4. Regular; not fluctuating; as, a *steady* breeze of wind.—*Steady!* in sailing large, the command given to the helmsman, to keep the ship in her course without deviating to the right or left.

**STEADY**, *v. t.* To hold or keep from shaking, reeling, or falling; to support; to make or keep firm. *Steady* my hand.

**STEAK**, *n.* [Dan. *steeg*, *steg*, a piece of roast meat; *steger*, to roast or dress



by the fire, to broil, to fry; *Sw. stek*, a steak; *steka*, to roast or broil; *G. stück*, a piece.] A slice of beef, pork, venison, &c., broiled or cut for broiling.

**STEAL**, *v. t. pret. Stole*; *pp. Stolen, Stole*. [*Sax. stealan, stelan*; *G. stehlen*; *Ir. tiallam*; probably from the root of *L. tollo*, to take, to lift.] 1. To take and carry away feloniously, as the personal goods of another. To constitute stealing or theft, the taking must be felonious, that is, with an intent to take what belongs to another, and without his consent or knowledge. [See THEFT.]

Let him that stole, steal no more; *Eph. iv.*

2. To withdraw or convey without notice, or clandestinely.

They could insinuate and steal themselves under the same by submission.

3. To gain or win by address or gradual and imperceptible means.

Variety of objects has a tendency to steal away the mind from its steady pursuit of any subject.

So Absalom stole the hearts of the men of Israel; 2 Sam. xv.

**STEAL**, *v. i.* To withdraw or pass privately; to slip along or away unperceived.

Fixed of mind to fly all company, one night she stole away.

From whom you now must steal and take no leave.

A soft and solemn breathing sound  
Rose like a steam of rich distill'd perfumes,  
And stole upon the air.

2. To practise theft; to take feloniously. He steals for a livelihood.

Thou shalt not steal; *Exod. xx.*

**STEALER**, *n.* One that steals; a thief.

**STEALING**, *ppr.* Taking the goods of another feloniously; withdrawing imperceptibly; gaining gradually.

**STEALING**, *n.* The fraudulent taking away of another man's goods, with an intent to take them against the will or without the will or knowledge of him whose goods they are. Stealing in a dwelling house is a larceny, and punishable as such. Stealing in a dwelling house with menace or threat, some person therein being put in fear, is punishable with transportation for not exceeding fifteen years, nor less than ten years, or imprisonment for not exceeding three years. Stealing from the person, or robbery attended with personal violence, as well as an assault with that intent, the offender being armed with any offensive weapon or instrument, is a felony punishable by transportation for the offender's life, or for not less than fifteen years, or imprisonment for not less than three years. Simple robbery, or stealing from the person, is punishable at the discretion of the court, by transportation for not exceeding fifteen years, nor less than ten years, or imprisonment for not exceeding three years. [See THEFT.]

**STEALINGLY**, *adv.* Silly; privately, or by an invisible motion. [Lit. us.]

**STEALTH**, *n.* (stelth.) The act of stealing; theft.

The owner proveth the stealth to have been committed on him by such an outlaw.

2. † The thing stolen; as, cabins that are dens to cover stealth.—3. Secret act; clandestine practice; means unperceived employed to gain an object;

way or manner not perceived; used in a good or bad sense.

Do good by stealth, and blush to find it fame.

The monarch blinded with desire of wealth,  
With steel invades the brother's life by stealth.

**STEALTH'FUL**, *a.* Given to stealth.

**STEALTH'FULLY**, *adv.* In a stealthful manner.

**STEALTH'FULNESS**, *n.* State of being stealthful.

**STEALTH'ILY**, *adv.* By stealth.

**STEALTHY**, *a.* (stelth'y.) Done by stealth; clandestinely; unperceived.

Now wither'd murder with his stealthy pace  
Moves like a ghost.

**STEAM**, *n.* [*Sax. steam, stem*; *D. stoom*.] 1. The vapour of water; or the elastic aeriform fluid generated by heating water to the boiling point. When water in an open vessel is heated to the temperature of 212°, or to the boiling point, globules of steam are formed at the bottom, and rise to the surface; and the continued application of heat, even though increased indefinitely, will only cause a more copious and rapid formation of steam, and will finally evaporate the whole of the water, without raising the temperature of either. In this case, all the heat which enters into the water is solely employed in converting it into steam of the temperature of boiling water. But if the water be confined in a strong close vessel, both it and the steam which it produces may be brought to any temperature; and as steam at 212° occupies nearly 1700 times the space of the water from which it is generated, it follows that, when thus confined, it must exercise an enormous elastic or expansive force; which may also be shown to be proportional to its temperature. When the temperature is considerably above 212°, the steam formed under such circumstances is termed *high pressure steam*; at 212° it is termed *low pressure steam*, and its pressure is equal to that of the atmosphere, or 15 lbs. on the square inch. Steam in its perfect state is transparent, and constantly invisible; but when it has been deprived of part of its heat by coming into contact with cold air, it suddenly assumes a cloudy appearance, and is condensed into water. Hence appears another important property of steam, its condensibility; so that whenever cold is applied to it, it suddenly returns to the liquid state, and thus can be employed to produce a vacuum. From the properties above briefly adverted to, steam constitutes an invaluable agent for the production of mechanical force, as exemplified in the vast and multiplied uses of the steam-engine. Steam is also employed as an agent in distributing the heat used for warming buildings, in heating baths, evaporating solutions, distilling, brewing, drying, dyeing, and even for domestic cookery. It is also the means of extracting wholesome and nutritious food from most unpromising and unpalatable substances.—2. In popular usage, the visible moist vapour which rises from water, and from all moist and liquid bodies, when subjected to the action of heat; as, the steam of boiling water, of malt, of a tan-bed, &c. This is properly water in a minute

state of subdivision arising from the condensation of steam.

**STEAM**, *v. i.* To rise or pass off in vapour by means of heat; to fume.

Let the crude humours dance  
In heated brass, steaming with fire intense.

2. To send off visible vapour.  
Ye mists that rise from steaming lake.

3. To pass off in visible vapour.  
The dissolved amber...steamed away into the air.

**STEAM**, *v. t.* To exhale; to evaporate. [Not much used.]—2. To expose to steam; to apply steam to for softening, dressing, or preparing; as, to steam cloth; to steam potatoes instead of boiling them; to steam food for cattle.

**STEAM-BOAT**, } *n.* A vessel moved  
**STEAM-VESSEL**, } by the power of a steam-engine acting upon paddle wheels, a screw propeller, or other mechanism for propelling it through the water.

**STEAM-BOILER**, *n.* A vessel in which water is converted into steam for the purpose of supplying steam-engines, or for any of the other purposes for which steam is used in the arts, or in domestic economy. Steam-engine boilers are constructed of various forms, the most common being waggon-shaped, egg-shaped, cylindrical, and tubular. The best material for boilers is copper; but wrought-iron-plate is most commonly employed in this country on account of its cheapness.

**STEAM-CAR**, *n.* A locomotive car used on railroads.

**STEAM-CARRIAGE**, *n.* A name usually applied to a locomotive engine adapted to work on common roads.

**STEAM-CASING**, *n.* A vacuity surrounding any vessel into which steam may be admitted.

**STEAMED**, *pp. or a.* Exposed to steam; cooked or dressed by steam.

**STEAM-ENGINE**, *n.* An engine worked by steam; or an engine in which the mechanical force arising from the elasticity and expansive action of steam, or from its property of rapid condensation, or from the combination of these principles, is made available as a source of motive power in the arts and manufactures, and in locomotion. The invention of the steam-engine, which has exerted such a vast influence upon the state of society in modern times, by the impulse it has given to industry, and the facilities it has afforded for intercourse among men, whether by land or by sea, has been universally ascribed, by the English, to the Marquis of Worcester, who published an account of it about the middle of the 17th century. By the French, the invention has been ascribed to Papin, towards the close of the same century. There can be little doubt, however, that steam was employed as an impelling power, to some small extent, more than thirty years previous to the date of the Marquis of Worcester's invention. The first actual working steam-engine of which there is any record, was invented and constructed by Captain Savery, an Englishman; to whom a patent was granted for it in 1698. This engine was employed to raise water by the expansion and condensation of steam. The steam-engine received great improvements from the hands of Newcomen, Beighton, Blakey, and others. Still, however, it was im-

perfect and rude in its construction, and was chiefly applied to the draining of mines or the raising of water. The steam-engine was brought to its present high state of perfection by the celebrated James Watt, about the year 1782. The numerous and vital improvements introduced by him, both in the combination of its mechanism, and in the economy of its management, have rendered the steam-engine at once the most powerful, the most easily applied and regulated, and, generally speaking, the least expensive of all prime movers, for impelling machinery of every description. Steam-engines vary much in magnitude, form, and proportions, as well as in the details of the machinery by which the power of the steam is applied. In short, the form of the engine, the arrangement and construction of its parts, its power, &c., depend entirely on the purpose to which it is to be applied, and may be indefinitely diversified. The subjoined illustration represents a sectional elevation of a *Portable Condensing Steam-Engine*.

steam thus admitted is instantly deprived of its heat, and re-converted into its original form of water, thereby forming a vacuum. Thus it will be seen that, on the communication being opened up between the boiler and either side of the piston, the latter will ascend or descend in the cylinder unimpeded by the resistance of the atmosphere against the other side, and with a force proportional to the pressure of the steam; and as the motions of the steam valve *l* are regulated by the engine itself, the above action is kept up continuously. The alternating rectilinear motion thus generated within the cylinder is transmitted, by means of a rod attached to the piston, to a strong beam *f*, *f*, movable upon a central axis; a system of jointed rods *e*, *e*, called the *parallel motion*, being interposed for the purpose of neutralizing the disturbing action which the circular path of the beam would otherwise exert upon the piston. The reciprocating motion of the beam is now, through the intervention of the connecting rod *g*, and crank *h*, converted

but if we supposed the condensing apparatus removed, and the waste steam allowed to escape into the atmosphere, it will then be equally applicable to that kind called *high-pressure* engines, which employ the elastic action of the steam alone. The latter class, on account of their greater simplicity of parts and lightness, are exclusively employed for the purposes of locomotion on railways; while the former, from their superior economy and safety, are generally preferred in this country as *stationary* engines for driving machinery, and *marine* engines for propelling steam-boats. The form of the steam-engine is susceptible of an endless variety, according to the purposes to which it is to be applied; its mechanical energy is usually estimated in *horse power*, [see *HORSE POWER*] and is proportioned to the pressure of the steam, the area of the piston, and the velocity at which it moves. The stupendous effects which have resulted from the application of the power of steam in recent times, are striking attestations of the immense value of the invention. By the agency of steam, the seas are now navigated in defiance of wind and tide; the earth is made to yield up in lavish abundance its metals and minerals; vast marshes are drained, and land before barren rendered fruitful; communities are brought into closer connection with communities; fresh and inexhaustible sources of wealth and comfort are elicited; new combinations of human industry and ingenuity are brought into requisition; knowledge is widely scattered abroad; distance is lessened by velocity of locomotion; and time itself become more precious. Thus by infinitely enlarging the sphere of useful action to whatsoever was useful before, and by diffusing among millions what previously was attainable only by the few, this agent has wrought a change of aspect in kingdoms, in commerce, and in the individual relations of society, to an extent so wide, and in a time so brief, that the history of the world bears no parallel to it in influence.

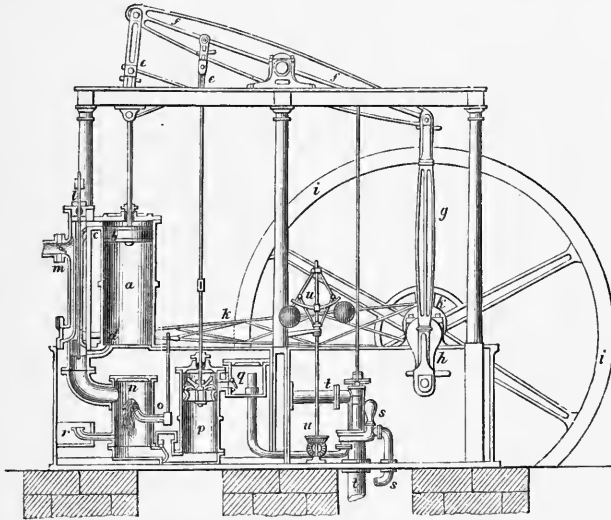

Portable Condensing Steam-Engine.

The steam cylinder; *h*, the piston; *c*, the upper steam port or passage; *d*, the lower steam port; *e*, *e*, the parallel motion; *f*, *f*, the beam; *g*, the connecting rod; *h*, the crank; *i*, *i*, the fly-wheel; *k*, *k*, the eccentric and its rod for working the steam valve; *l*, the steam valve and valve casing; *m*, the throttle valve; *n*, the condenser; *o*, the injection cock; *p*, the air-pump; *q*, the hot well; *r*, the snifting-valve, for creating a vacuum in the condenser, previous to starting the engine; *s*, the feed pump for supplying the boilers; *t*, the cold water pump for supplying the condenser cistern; *u*, the governor.

The construction and action of the steam-engine will be readily understood from the above sketch. The pipe which conveys the steam from the boiler opens into the part marked *l*, which incloses a movable valve by means of which the steam may be alternately admitted into the cylinder *a*, by the upper port, *c*, and lower, *d*; between these points the piston *b* works steam tight. The valve *l* is so contrived, that while it allows steam to pass into the cylinder through one of the ports, it shall at the same time open a communication between the opposite side of the piston and the condenser *n*, which is a hollow vessel kept constantly immersed in cold water, a portion of which is admitted into it by the injection cock, *o*; consequently the

into a circular or rotatory motion, which is rendered continuous and uniform by the fly-wheel *i*, to the axis of which the machinery to be impelled is connected. The air-pump *p*, for withdrawing the vapour and water from the condenser; the feed pump *s*, for supplying the boilers, and the cold water pump *t*, for supplying the condenser cistern, are all worked by rods from the beam; and the governor *u*, for maintaining uniformity of motion, is driven by a band from the crank shaft. The above description refers more immediately to that class of steam-engines called *low pressure*, or *condensing* engines, in which the power derived from the rapid condensation of the steam is made available in combination with that due to its elasticity;

**STEAMER**, *n*. A vessel propelled by steam; a steam-ship.—2. A vessel in which articles are subjected to the action of steam, as in washing or cookery.  
**STEAM-GAUGE**, *n*. An instrument for indicating the pressure within a



Steam-Gauge.

steam - boiler, by means of a bent tube partially filled with mercury, one end of which springs from the boiler, while the other is exposed to the air; so that the steam, by its pressure, raises the mercury in the straight limb of the tube to a height above the common level, proportioned to that pressure. An iron float and index are usually added for the convenience of observation, as shewn in the annexed figure.  
**STEAM-GOVERNOR**. See **GOVERNOR**.  
**STEAM-GUN**, *n*. A contrivance for projecting balls or other projectiles used in warlike operations, by means

of steam in place of gunpowder. It bears some analogy to the air-gun. The invention is due to Mr. Jacob Perkins, but it has never been submitted to the test of actual experience either in military or naval operations, and it requires too much extraneous apparatus to be conveniently movable.

**STEAMING**, *ppr.* Exposing to steam; cooking or dressing by steam; preparing for cattle by steam, as roots.

**STEAM-NAVIGATION**, *n.* The art of applying the power of steam to the propulsion of boats and vessels in general, both for inland communication by rivers and lakes, and for the general purposes of national commerce on the seas and oceans.

**STEAM-PACKET**, *n.* A packet or vessel propelled by steam.

**STEAM-PIPE**, *n.* Any pipe used for conveying steam from a boiler to a steam-engine, or through a workshop for the purpose of heating, or for any other purpose.

**STEAM-PLOUGH**, *n.* A plough worked by a steam-engine instead of horses. Steam-ploughs have been wrought with success upon bog land.

**STEAM-SHIP**, *n.* A ship propelled by steam.

**STEAM-TUG**, *n.* A steamer used in towing ships.

**STEAM-VESSEL**, *n.* A vessel propelled through the water by the force of steam. [See **STEAM-BOAT**.]

**STEAM-WHEEL**, *n.* Another name for a rotatory steam-engine.

**STEAM-WHISTLE**, *n.* A contrivance attached to locomotives for giving warning of the starting of the train, of its approach to a tunnel or station, &c. The annexed figure represents a section of a steam-whistle; *a, a*, is a tube fixed to the top of the boiler, and opening into its interior; it is commanded by a stop-cock, *e*; the tube is surmounted by a hollow piece *b*, perforated with holes, and surrounded by a thin brass cup *c, c*; the respective diameters of the piece *b*, and cup *c*, being so adjusted as to leave a very narrow orifice all round. Another thin brass cup *d*, is fixed in an inverted position at a short distance above the upper surface of the parts *b* and *c*, so as to present a sharp edge exactly opposite the orifice above mentioned. On opening the stop-cock, *e*, the steam, rushing with great violence through the circular orifice, encounters the edge of the cup, *c*, and thereby produces a loud and shrill sound which may be heard at the distance of several miles.

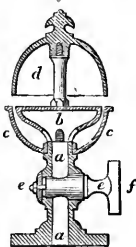

Steam-Whistle.

On opening the stop-cock, *e*, the steam, rushing with great violence through the circular orifice, encounters the edge of the cup, *c*, and thereby produces a loud and shrill sound which may be heard at the distance of several miles.

**STE'ARATE**, *n.* A compound formed by the union of stearic acid with a salifiable base. The neutral stearates of the alkalies are perfect soaps.

**STEARIC ACID**, *n.* A bibasic acid, perhaps the most important and most abundant of the fatty acids. It exists in combination with glycerine, as stearine, in beef and mutton fat, and in several vegetable fats, such as the butter of cacao. It is obtained from stearine by saponification, and also from mutton suet by a similar process. Stearic acid is in the form of brilliant

white scaly crystals; it is inodorous, tasteless, insoluble in water, but soluble in alcohol and ether. It burns like wax, and is used in the formation of improved candles. It is composed of 68 equivalents of carbon, 66 of hydrogen, and 5 of oxygen. It forms compounds with the alkalies, earths, and metallic oxides, which are called stearates.

**STE'ARINE**, *n.* [Gr. *στεαρ*, suet.] The chief ingredient of suet and tallow, or the harder ingredient of animal fats, oleine or elaine being the softer one. It is obtained from mutton suet, melted with ten times its weight of ether in a water-bath. It may also be obtained by pressing tallow between hot plates, and afterwards dissolving in hot ether, which on cooling deposits the stearine. It has a pearly lustre, is soft to the touch, but not greasy. It is insoluble in water, but soluble in hot alcohol and ether. It is separable into stearic acid and glycerine, and when boiled with alkalies, is saponified; that is, the stearic acid combines with the alkali, forming soap, and glycerine is separated. When melted it resembles wax.

**STE'ARONE**, *n.* A substance obtained by the partial decomposition of stearic acid. It is a volatile liquid, and seems to be stearic acid deprived of two equivalents of carbonic acid.

**STEAROPTENE**, *n.* A crystalline substance contained in many essential oils.

**STEA'TITE**, *n.* [Gr. *στιας*, *στιατος*, fat.] Soapstone; so called from its smooth or unctuous feel; a subspecies of rhomboidal mica. It is of two kinds, the common, and the pagodite or lardstone. It is sometimes confounded with talc, to which it is allied. It is a compact stone, white, green of all shades, gray, brown or marbled, and sometimes herborized by black dendrites. It is found in metalliferous veins, with the ores of copper, lead, zinc, silver, and tin. It is a hydrated silicate of magnesia and alumina. It is used in the manufacture of porcelain, in polishing marble, &c.; as the basis of cosmetic powders; in the composition of crayons, &c.

**STEA'TITIC**, *a.* Pertaining to soapstone; of the nature of steatite, or resembling it.

**STE'ATOCELE**, *n.* [Gr. *σταις*, fat, and *ωνη*, a tumour.] A tumour of the scrotum, containing fat.

**STEATO'MA**, *n.* [Gr.] A lupia or wen, *i. e.* an encysted tumour, containing matter like suet.

**STEATO'MATOUS**, *a.* Of the nature of a steatoma.

**STED, STED'FAST.** See **STEAD**.

**STEEL**, *n.* A ladder.

**STEDD**, *n.* [Sax. *stede*. Qu. *stud*, a stone-horse.] A horse, or a horse for state or war. [This word is not much used in common discourse. It is used in poetry and descriptive prose, and is elegant.]

Stout are our men, and warlike are our steeds. *Waller.*

**STEEK**, or **STEIK**, *v. t.* [Teut. *stecken*.] To close, to shut, to stop, or choke up. [Scotch.]

**STEEK**, or **STEIK**, *v. t.* [Sax. *stican*, or *stician*.] To pierce with a sharp pointed instrument; to stab; to stitch or sew with a needle; to fix; to fasten. As a noun, a stitch, or the act of stitching with a needle. [Scotch.]

**STEEKAN**, *n.* In *Holland*, a wine measure of about five gallons.

**STEEL**, *n.* [Sax. *style*; G. *stahl*; probably from setting, fixing, hardness; G. *stellen*.] 1. Iron combined with a small but definite portion of carbon. It is called, in chemistry, carburet of iron. The relative proportions of iron and carbon vary in steel of different qualities; but in that used for ordinary purposes, the carbon rarely exceeds two per cent., and is generally below it. The best steel is manufactured from Swedish and Russian bar-iron, by a process called *cementation*. Steel is less malleable than iron, but it is harder, more sonorous, and elastic, susceptible of a higher polish, and less liable to rust. When heated to redness, it can be hammered into various forms, and it can also be welded to another piece of steel or iron. Steel formed from bar-iron by cementation is called *blistered steel*, from its surface acquiring a *blistered* character in the process. When blistered steel is rolled or beaten down into bars, it is called *shear-steel*, and if it be melted, cast into ingots, and again rolled out into bars, it forms *cast-steel*, which, when well prepared, is superior to the other kinds of steel. — *Natural*, or *German-steel*, is an impure and variable kind of steel procured from cast-iron, or obtained at once from the ore. The natural steel yielded by cast-iron, manufactured in the refining houses, is known by the general name of *furnace-steel*, and that which has only been once treated with a refining furnace is particularly called *rough-steel*. The peculiarity of steel, upon which its high value in the arts in a great measure depends, is its property of becoming hard after being heated to redness, and then suddenly cooled by being plunged into cold water, and of being again softened down to any requisite degree, by the application of a certain temperature. This process is called *tempering*. It is found that the higher the temperature to which steel is raised, and the more sudden the cooling, the greater is the hardness; and hence, any degree of hardness can be given to steel which is required for the various purposes to which it is applied. According to the degree of hardness to which steel is tempered, it assumes various colours, and formerly these colours served as guides to the workman. Now, however, a thermometer, with a bath of mercury or oil, is employed, and the operation of tempering is performed with a much greater degree of certainty. The uses of steel in forming various kinds of instruments, edge-tools, springs, &c., are well known.—*Indian-steel*. [See **WOOLZ**.]—2. *Figuratively*, weapons; particularly offensive weapons, swords, spears, and the like.

Brave Macbeth with his brandish'd steel.

*Shak.*

While doubting thus he stood, Receiv'd the steel bath'd in his brother's blood.

*Dryden.*

3. Extreme hardness; as, heads or hearts of *steel*.—4. A kind of steel file for sharpening knives.

**STEEL**, *a.* Made of steel; as, a *steel* plate or buckle.

**STEEL**, *v. t.* To overlay, point, or edge with steel; as, to *steel* the point of a sword; to *steel* a razor; to *steel* an

axe.—2. To make hard or extremely hard.

O God of battles, *steel* my soldiers' hearts.

*Shak.*

Lies well *steel'd* with weighty arguments.

*Shak.*

3. To make hard; to make insensible or obdurate; as, to *steel* the heart against pity; to *steel* the mind or heart against reproof or admonition.

**STEEL-BOW GOODS, n.** In *Scots law*, goods consisting in corn, cattle, straw, implements of husbandry, delivered by the landlord to his tenant, by means of which the tenant is enabled to stock and labour the farm, and in consideration of which he becomes bound to return articles equal in quantity and quality, at the expiration of the lease. The origin of the term is uncertain.

**STEEL-CAP, n.** Armour for the head; a head-piece.

**STEEL-CLAD, a.** Clad or armed with steel.

**STEELED, pp.** Pointed or edged with steel; hardened; made insensible.

**STEEL ENGRAVING, n.** The art of engraving upon steel plates, for the purpose of producing prints or impressions in ink, upon paper and other substances.—2. The design engraved upon the steel plate.—3. *Collog.*, an impression or print taken from the engraved steel plate.

**STEELEER, n.** In *ship-building*, the foremost or aftmost plank in a strake, which is dropped short of the stem or stern-post.

**STEEL-GIRT, a.** Girded with steel.

**STEEL-HEARTED, a.** Having the heart hard as steel.

**STEEPLENESS, n.** [from *steely*.] Great hardness.

**STEEPLING, ppr.** Pointing or edging with steel; hardening; making insensible or unfeeling.

**STEEL-PEN, n.** A pen made of steel.

**STEEL-PLATED, a.** Plated with steel.

**STEEL-TRAP, n.** A trap, set in grounds to catch depredators.

**STEEPLY, a.** Made of steel; consisting of steel.

Broadch'd with the *steely* point of Clifford's lance.

*Shak.*

Around his shop the *steely* sparkles flew.

*Gay.*

2. Hard; firm.

That she would unarm her noble heart of that *steely* resistance against the sweet blows of love.

*Sydney.*

**STEELYARD, n.** [*steel* and *yard*.] The Roman balance; an instrument for weighing bodies, consisting of a rod or bar marked with notches, designating the number of pounds and ounces, and a weight which is movable along this bar, and which is made to balance the weight of the body by being removed at a proper distance from the fulcrum.

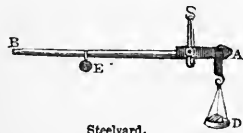

Steelyard.

The principle of the steelyard is that of the lever; where an equilibrium is produced, when the products of the weights on opposite sides into their respective distances from the fulcrum, are equal to one another. Hence a

less weight is made to indicate a greater, by being removed to a greater distance from the fulcrum. For weighing heavy loads, the steelyard is a convenient instrument, but for smaller weights it is less accurate than the common balance.

**STEEN, } † n.** A vessel of clay or  
**STEAN, }** stone.

**STEENING, or STEANING, n.** In *Arch.*, the brick or stone wall, or lining of a well or cess-pool, the use of which is to prevent the interruption of the surrounding soil.

**STEENKIRK, † n.** A kind of neckcloth.  
**STEEP, a.** [Sax. *steap*; allied to *stoop* and *dip*.] Making a large angle with the plane of the horizon; ascending or descending with great inclination; precipitous; as, a *steep* hill or mountain; a *steep* roof; a *steep* ascent; a *steep* declivity.

**STEEP, n.** A precipitous place, hill, mountain, rock, or ascent; any elevated object which slopes with a large angle to the plane of the horizon; a precipice.

We had on each side rocks and mountains broken into a thousand irregular *steeps* and precipices.

*Addison.*

**STEEP, v. t.** [probably formed on the root of *dip*.] To soak in a liquid; to macerate; to imbue; to keep anything in a liquid till it has thoroughly imbibed it, or till the liquor has extracted the essential qualities of the substance. Thus cloth is *steeped* in dye or other liquid in bleaching or dyeing. But plants and drugs are *steeped* in water, wine, and the like, for the purpose of tincturing the liquid with their qualities.

**STEEP, n.** A liquid for steeping grain or seeds; also, a runnet bag. [*Local*.]

**STEEPED, pp.** Soaked; macerated; imbed.

**STEPPER, n.** A vessel, vat, or cistern in which things are steeped.

**STEEPING, ppr.** Soaking; macerating.

**STEEPLE, n.** [Sax. *stepel*, *stypel*.] A lofty erection attached to a church and generally intended to contain its bells. *Steeple* is a general term applied to every appendage of this description, whether in the form of a tower or a spire; or, as is usual, a tower surmounted by a spire. Steeples are attached to other buildings besides churches, such as *town-halls*, &c. They, far from *steeples* and their sacred sound.

*Dryden.*

**STEEPLE-CHASE, n.** A fox hunt, in which the sportsmen agree to follow the fox directly over the country, regardless of all obstructions, as hedges, ditches, rivers, &c., or even steeples! —*Horse-races* are frequently got up on the same plan, and are also termed *steeples-chases*.

**STEEPLED, a.** Furnished with a steeple; adorned with steeples or towers.

**STEEPLE-HOUSE, † n.** A church; a term of contempt for an established church, used sometimes by dissenters.

**STEEPLY, adv.** With steepness; with precipitous declivity.

**STEEPNESS, n.** The state of being steep; precipitous declivity; as, the *steepness* of a hill, a bank, or a roof.

**STEEPLY, a.** Having a steep or precipitous declivity; as, *steeply* crags; a *poetical* word.

No more, my goats, shall I behold you climb

The *steeply* cliffs.

*Dryden.*

**STEER, n.** [Sax. *steor*, *styre*; D. *stier*.] A young male of the ox kind or common ox. [*See Ox*.]

With solemn pomp then sacrific'd a *steer*.

*Dryden.*

**STEER, v. t.** [Sax. *steoran*, to steer, to correct or chide, to discipline; G. *steuern*, to hinder, restrain, repress, to curb, to steer, to pilot, to aid, help, support. The verb is connected with or derived from *steuer*, a rudder, a helm, aid, help, subsidy, impost, tax, contribution. D. *stieren*, to steer, to send, and *stuur*, a helm; *stuuren*, to steer, to send; Dan. *styrer*, to govern, direct, manage, steer, restrain, moderate, curb, stem, hinder; *styre*, a helm, rudder, or tiller; *styr*, moderation, a tax or assessment; Sw. *styra*, to steer, to restrain; *styre*, a rudder or helm; Arm. *stur*, id.; Ir. *stiuram*. We see the radical sense is to *strain*, variously applied, and this coincides with the root of *starch* and *stark*; stiffness being from stretching.] 1. To direct; to govern; particularly, to direct and govern the course of a ship by the movements of the helm. Hence,—2. To direct; to guide; to show the way or course to.

That with a staff his feeble steps did *steer*.

*Spenser.*

**STEER, v. i.** To direct and govern a ship or other vessel in its course. Formerly seamen *steered* by the stars; they now *steer* by the compass.

A ship...where the wind  
Veers oft, as oft so *steers* and shifts her sail.

*Milton.*

2. To be directed and governed; as, a ship *steers* with ease.—3. To conduct one's *steers*; to take or pursue a course or way.

**STEER, † n.** A rudder or helm.

**STEER, v. t.** To stir; to touch; to meddle with so as to injure. [*Scotch*.]

**STEERAGE, n.** The act or practice of directing and governing in a course; as, the *steerage* of a ship. [*In this sense we believe the word is now little used*.] 2. In *seamen's lan.*, the effort of a helm, or its effect on the ship; or, the peculiar manner in which an individual ship is affected by the helm.—

3. In a *ship*, an apartment forward of the great cabin, from which it is separated by a bulk-head or partition, or an apartment in the fore part of a ship for passengers. In ships of war it serves as a hall or antechamber to the great cabin. In *steam vessels*, the great cabin and *steerage* are separated by the whole space occupied by the machinery, &c.—4. The part of a ship where the tiller traverses.—5. Direction; regulation.

He that hath the *steerage* of my course.

[*Little used*.]

*Shak.*

6. Regulation or management.

You raise the honour of the peerage,  
Proud to attend you at the *steerage*.

*Swift.*

7. That by which a course is directed.

Here he hung on high,

The *steerage* of his wings.

*Dryden.*

[*Steerage*, in the general sense of direction or management, is in popular use, but by no means an elegant word.]  
**STEERAGE-WAY, n.** In *seamen's lan.*, that degree of progressive movement of a ship, which renders her governable by the helm.

**STEERED, pp.** Directed and governed in a course; guided; conducted.

**STEERER, n.** One that steers; a pilot. [*Little used*.]

**STEEERING**, *ppr.* Directing and governing in a course, as a ship; guiding; conducting.

**STEEERING**, *n.* The act or art of directing and governing a ship or other vessel in her course, by the movements of the helm, or by applying its efforts to regulate her course as she advances; the act of guiding or managing.

**STEEERING-WHEEL**, *n.* The wheel by which the rudder of a ship is turned and the ship is steered.

**STEERLESS**, † *a.* Having no steer or rudder.

**STEERSMAN**, *n.* [*steer* and *man.*] One that steers; the helmsman of a ship. The steersman manages the helm by means of the steering-wheel, which is connected with the rudder.

**STEERSMATE**, † *n.* [*steer* and *mate.*] One who steers; a pilot.

**STEEVE**, *n.* In *seamen's lan.*, the angle which the bowsprit makes with the horizon.—2. A long heavy spar, with a place to fix a block at one end, and used in stowing certain kinds of cargo, which need to be driven in close.

**STEEVE**, *v. t.* In *ship-building*, to give the bowsprit a certain angle of elevation, which is generally from 26° to 30°.

**STEEVE**, *a.* [*Sax. stife*, stiff, inflexible.] Firm, compacted, not easily bent or broken. [*Scotch.*]

**STEEVING**, *n.* In *seamen's lan.*, the angle of elevation which a ship's bowsprit makes with the horizon.

**STEG**, *n.* [*Ice. stegge.*] A gander. [*Local.*]

**STEGANOGRAPHIST**, *n.* [*Gr. στεγανος*, secret, and *γραφω*, to write.] One who practises the art of writing in cipher.

**STEGANOGRAPHY**, *n.* [*supra.*] The art of writing in ciphers or characters which are not intelligible, except to the persons who correspond with each other.

**STEGANOPODS**, *n. plur.* [*Gr. στεγανος*, covered, and *πους*, foot.] A family of swimming birds with the four toes connected by the same web.

**STEGNOTIC**, *a.* [*Gr. στεγνωτικος.*] Tending to render costive; or to diminish excretions or discharges generally.

**STEGNOTIC**, *n.* A medicine which tends to produce costiveness; one that diminishes excretions or discharges generally.

**STEINHEILITE**, *n.* A mineral of a blue colour, a variety of iolite.

**STELA**, *n.* [*Gr. στελη.*] In *arch.*, a small column without base or capital.

**STEL**, † *n.* A stale or handle; a stalk.

**STEL/CHITE**, *n.* A fine kind of storax, in larger pieces than the calamite.

**STEL/ENE**, *a.* [*Gr. στελη*, a column.] Columnar.

**STEL/LA**, *n.* [*L.*] A star.

**STEL/LAR**, } *a.* [*It. stellare; L. stell-*  
**STEL/LARY**, } *laris*, from *stella*, a star.] 1. Pertaining to stars; astral; as, *stellar* virtue; *stellar* figure.—2. Starry; full of stars; set with stars; as, *stellary* regions.

**STELLA'RIA**, *n.* Stitch-wort, a genus of plants of the class and order Decandria trigynia, Linn.; nat. order Caryophyllacee, sect. Alsineae. Most of the species are weeds, which are distributed over all parts of the world. Eight species are found in Britain. They possess no active properties, and few of them are thought worthy of

cultivation. — *S. holostea*, a British species, called greater stitch-wort, is the handsomest plant of the genus. It is often planted in gardens as a border flower, on account of its early delicate white flowers.—*S. media* is the common chickweed.

**STELLA'TÆ**, *n.* In *bot.* [*See GALIA-CÆE.*]

**STEL/LATE**, } *a.* [*L. stellatus.*] 1.  
**STEL/LATED**, } Resembling a star;  
radiated.—2. In *bot.*, stellate or ver-

ticillate leaves are when more leaves than two surround the stem in a whorl, or when they radiate like the spokes of a wheel, or like a star. A *stellate* bristle is when a little star of smaller hairs is affixed to the end; applied also to the stigma. A *stellate* flower is a radiate flower.

**STELLA'TION**, † *n.* [*L. stella*, a star.] Radiation of light.

**STEL/LED**, † *a.* Starry.

**STELLERIDANS**, or **STELLERIDÆ**, *n.* [*from Lat. stella*, a star.] Star-fishes, or sea-stars; a family of Echinoderms, of which the Linnæan genus *Asterias* is the type.

**STELLIFEROUS**, *a.* [*L. stella*, a star, and *fero*, to produce.] Having or abounding with stars.

**STEL/LIFORM**, *a.* [*L. stella*, star, and *form.*] Like a star; radiated.

**STEL/LIFY**, † *v. t.* To turn into a star.

**STEL/LIO**, *n.* [*L.*] Cuvier's name for a family of Iguanians. The stelliones are those lizards which have, along with the general characters of the Iguanians, the tail surrounded by rings, composed of great scales which are often spiny.

**STEL/LION**, *n.* See **STALLIO**.

**STEL/LIONATE**, † *n.* [*Fr. stellionat*, a cheating; *Low L. stellionatus.*] In the *Roman law*, a term used to denote all such crimes in which fraud is an ingredient, as have no special names to distinguish them, and are not defined by any written law; as, when one sells the same thing to two purchasers; when a debtor pledges to his creditors what does not belong to him; substituting base for precious metals; dealing in counterfeit or adulterated goods, &c. In the *law of Scotland*, the term is applied, either to any crime, which, though indictable, goes under no general denomination, and is punishable arbitrarily; or to any civil delinquency of which fraud is an ingredient; as fraudulent bankruptcy.

**STEL/LITE**, *n.* [*L. stella*, a star.] A name given by some writers to a white stone found on Mount Libanus, containing the lineaments of the star-fish.—2. A zeolitic mineral, occurring in radiated acicular crystals or fibres, and of a snow-white colour.

**STEL/LULAR**, *a.* [*L. stella*, a star.] Having the appearance of little stars. In *nat. hist.*, having marks resembling *stella*, or stars. The surface of the tubipora or organ-pipe coral is covered with a green fleshy substance, studded with *stellular* polypi.

**STEL/OCHITE**, *n.* A name given to the osteocolla.

**STEOLOGRAPHY**, *n.* [*Gr. στελογραφια*; *στελη*, a pillar, and *γραφω*, to write.]

The art of writing or inscribing characters on pillars.

**STEM**, *n.* [*Sax. stema; G. stamm*, stock, stem, race. The Latin has *stemma*, in the sense of the stock of a family or race. The primary sense is to set, to fix.] 1. The principal body of a tree, shrub, or plant of any kind; the main stock; the firm part which supports the branches; the ascending axis, which grows in an opposite direction to the root or descending axis. The stem is composed of fibrous, spirial, and cellular tissues, arranged in various ways, mostly assuming a cylindrical form, and having a perpendicular direction, and bearing upon it the various parts of the plant. Its form and direction, however, are subject to much variation in particular cases. In regard to internal structure, there are three principal modifications of stems characteristic of the three great natural classes into which the vegetable kingdom is divided, namely, exogens, endogens, and acrogens. [*See these terms.*] In some plants the stem is so short as to seem to be wanting, the leaves and flower-stalks appearing to spring from the top of the root. In this case, the plant is said to be *stemless*, (*acaulis*.) There are also stems, such as the *rhizoma* and *tuber*, which being subterranean, have been mistaken for roots. The direction, form, texture, consistency, and clothing of stems, produce an almost endless variety in this organ, of which the principal kinds, however, may be reduced to eight. Of these four are subterranean, namely, the *cornus*, *tuber*, *rhizoma*, and *creeping-stem*; and four aerial, namely, the *stem*, *trunk*, *stipe*, and *culm*. To these may be added the *runner* and *sucher*. Considered with respect to consistence, a stem may be *herbaceous*, *woody*, *solid*, *spongy*, *succulent*, *stiff*, *brittle*, &c.; with respect to the divisions, it may be *branched*, *alternately branched*, *much branched*, &c.; with respect to direction, it may be *erect*, *prostrate*, *procumbent*, *creeping*, *reclining*, *trailing*, *climbing*, *twining*, &c.; in regard to form, it may be *round*, *compressed*, *square*, *angular*, *jointed*, *knotted*, &c.; in regard to clothing or appendages, the stem may be *leafy*, *naked*, *scaly*, or *winged*; and in regard to surface, it may be *smooth* or *glabrous*, *shining* or *glossy*, *powdery*, *scabrous*, *warty*, *dotted*, *spotted*, *grooved* or *furrowed*, &c.—2. The peduncle of the fructification, or the pedicle of a flower; that which supports the flower or the fruit of a plant; the petiole or leaf-stem.—3. The stock of a family; a race or generation of progenitors; as, a noble stem.

Learn well their lineage and their ancient stem. *Tickel.*

4. Progeny; branch of a family.

This is a *stem*

Of that victorious stock.

5. In a *ship*, a curved piece of timber, to which the two sides of a ship are united at the fore end. The lower end of it is scarfed to the keel, and the bowsprit rests upon its upper end. [*D. steven.*] The outside of the stem is usually marked with a scale of feet, according to its perpendicular height from the keel. Its use is to ascertain the draught of water at the fore part, when the ship is in preparation for a sea voyage, &c. *False stem*, that fixed before the right one. When a ship's



Stellate Leaves.

stem is too flat, so that she cannot keep the wind well, a false stem is put above to remedy the defect.—6. In music, the upright or down-right line added to the head of a note, thus.—7. Any thing resembling the stem of a plant; as the stem of a hydrometer. From stem to stern, is from one end of the ship to the other, or through the whole length.



STEM, *v. t.* To oppose or resist, as a current; or to make progress against a current. We say, the ship was not able with all her sails to stem the tide. They stem the flood with their erected breasts. Denham.

2. To stop; to check; as a stream or moving force.

At length Erasmus, that great injured name, The glory of the priesthood and the shame, Stemm'd the wild torrent of a barb'rous age,

And drove those holy Vandals off the stage. Pope.

STEM-GLÄSPING, *a.* Embracing the stem with its base; amplexical; as, a leaf or petiole.

STEM-LEAF, *n.* A leaf growing from the stem.

STEMLESS, *a.* Having no stem. A stemless plant is one in which the stem is so short as to appear to be wanting; as in the primrose and hyacinth. Some of the simpler plants have no stem; as the lichens.

STEMMATA, *n. pl.* [Gr. *στέμμα*.] The visual organs of certain insects.

STEMMATOPUS, *n.* [Gr. *στέμμα*, a crown, or garland, and *ὄψ*, the eye.] Cuvier's name for a genus of seals, having four superior incisors, and two inferior, the grinders compressed, slightly trilobate, supported by thick roots. Such is the hooded seal (*Phoca cristata*, Gmelin) from the Arctic

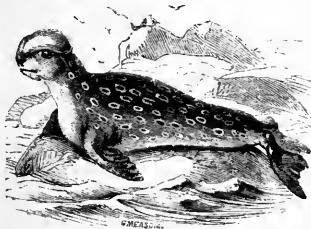

Hood Seal (*Phoca cristata*).

ocean. It is seven or eight feet long, and has a piece of loose inflatable skin on the head. This piece of skin is drawn over the eyes when the animal is menaced, at which time the nostrils are inflated like bladders.

STEMMED, *pp.* Opposed, as a current; stopped.

STEMMING, *ppr.* Opposing, as a stream; stopping.

STEMPLE, *n.* In mining, a cross bar of wood in a shaft.

STEMSON, *n.* In ships, a piece of curved timber fixed on the after part of the apron inside. The lower end is scarfed into the keelson, and receives the scarf of the stem, through which it is bolted.

STENCH, *n.* [Sax. *stenc*, *stencg*. See STINK.] An ill smell; offensive odour. STENCH, *v. t.* To cause to emit a hateful smell.—2. *v. i.* To stanch; to stop.

STENCH'Y, *† a.* Having an offensive smell.

STENCIL, *n.* A piece of thin leather or oil cloth used in painting paper hangings. The pattern is cut in the material composing the stencil, which is applied to the surface to be painted. The brush then being brought over the stencil, only the interstices representing the pattern receive the colours.

STENCIL, *v. t.* To paint or colour in figures with stencils.

STENCILLING, *n.* A method of painting on walls, with stencils, so as to imitate the figures of paper hangings.

STEND, *v. i.* [Fr. *estendre*; It. *stendere*.] To leap; to spring; to move with elastic force; to walk with a long step or stride. As a noun, a leap; a spring; a long step, or stride. [Scotch.]

STENEOSAURUS, *n.* [Gr. *στενος*, narrow, strait, and *σαύρα*, a lizard.] A genus of saurians, whose fossil remains only are found. They have a long and narrow beak, like the existing Gavia; a species of crocodile.

STENOG'RAPHER, *n.* [Gr. *στενος*, close, narrow, and *γραφω*, to write.] One who is skilled in the art of short-hand writing.

STENOGRAPH'IC, } *a.* [supra.]  
STENOGRAPH'ICAL, } Pertaining to the art of writing in short hand; expressing in characters or short hand.

STENOGRAPH'IST, *n.* A stenographer.

STENOGRAPHY, *n.* [supra.] The art of writing in short hand by using abbreviations or characters for whole words. This art has been practised from remote antiquity, and is said to have originated in the hieroglyphics of the Egyptians. To short hand writers we owe full reports of the proceedings of parliament, of public meetings, and of the courts of law. Short hand is also used for taking down sermons, scientific lectures and public speeches, both in parliament and at the bar. The art of stenography, however, is not to be acquired without the diligent application of many months, and it also requires considerable manual dexterity. Numerous systems of stenography have been invented in more recent times, some of them of great simplicity. [See PHONOGRAPHY.]

STENT, for Stint. [See STINT.]

STENT, *v. t.* [Fr. *estendre*; L. *extendere*.] In Scots law, to assess; to tax at a certain rate.

STENT, *n.* In Scots law, a valuation of property in order to taxation; a taxation; a tax. Stent-master, a person appointed to allocate the stent or tax on the persons liable. Stent-roll, the cess-roll. The word stent, in Scotch, also signifies a task; a piece of work to be performed in a determined time; in which sense it corresponds with the English stint.

STENTOR, *n.* A person having a very powerful voice.

STENTORIAN, *a.* [from Stentor.] Extremely loud; as, a stentorian voice.

—2. Able to utter a very loud sound; as, stentorian lungs.

STENTOROPHON'IC, *a.* [from Stentor, a herald in Homer, whose voice was as loud as that of fifty other men, and Gr. *φωνη*, voice.] Speaking or sounding very loud

Of this stentorophonic horn of Alexander there is a figure preserved in the Vatican. Derham.

STEP, *v. i.* [Sax. *stappan*, *steppan*; D. *stappen*; Gr. *στέπα*. Qu. Russ. *stopa*, the foot. The sense is to set, as the foot, or more probably to open or part, to stretch or extend.] 1. To move the foot; to advance or recede by a movement of the foot or feet; as, to step forward, or to step backward.—2. To go; to walk a little distance; as, to step to one of the neighbours.—3. To walk gravely, slowly, or resolutely.

Home the swain retreats,  
His flock before him stepping to the fold. Thomson.

To step forth, to move or come forth.—To step aside, to walk to a little distance; to retire from company.—To step in or into, to walk or advance into a place or state; or to advance suddenly in; John v.—2. To enter for a short time. I just stepped into the house.—3. To obtain possession without trouble; to enter upon suddenly; as, to step into an estate.—To step back, to move mentally; to carry the mind back.

They are stepping almost three thousand years back into the remotest antiquity. Pope.

STEP, *v. t.* To set, as the foot.—2. In marine language, to fix the foot of a mast in the keel; to erect.—To step a boat's mast, is to erect and secure it in readiness for setting sail.

STEP, *n.* [Sax. *stæp*; G. *stufe*; W. *tap*, a ledge; *tapiaw*, to form a step or ledge.] 1. A pace; an advance or movement made by one removal of the foot.—2. One remove in ascending or descending a stair. One of the gradients in a staircase, which is composed of two parts, the tread, or horizontal part, and the riser or vertical part. [See STAIR.]

The breadth of every single step or stair should be never less than one foot. Wotton.

3. The space passed by the foot in walking or running. The step of one foot is generally five feet; it may be more or less.—4. A small space or distance. Let us go to the gardens; it is but a step.—5. The distance between the feet in walking or running.—6. Gradation; degree. We advance in improvement step by step, or by steps.—7. Progression; act of advancing.

To derive two or three general principles of motion from phenomena, and afterward tell us how the properties and actions of all corporeal things follow from those manifest principles, would be a great step in philosophy. Newton.

8. Footstep; print or impression of the foot; track.—9. Gait; manner of walking. The approach of a man is often known by his step.—10. Proceeding; measure; action.

The reputation of a man depends on the first steps he makes in the world. Pope.

11. The round of a ladder.—12. Steps in the plural, walk; passage.

Conduct my steps to find the fatal tree  
In this deep forest. Dryden.

13. In ships, a block of wood, or in large ships, a solid platform, upon the keelson, supporting the heel of the mast. In general, any piece of timber having the foot of another fixed upright in it. In mill-work, a species of bearing in which the lower extremity of a vertical shaft revolves.—Step of a lock, the breast wall.—14. The bottom support on which the lower end of an upright shaft or wheel rests.

STEP, Sax. *steop*, from *stapan*, to de-

prive, is prefixed to certain words to express a relation by marriage, arising out of orphanage.

**STEP'-BROTHER**, *n.* A brother-in-law, or by marriage. [An orphan brother.]

**STEP'-CHILD**, *n.* [*step* and *child*.] A son-in-law or daughter-in-law; [a child deprived of its parent.]

**STEP'-DAME**, *n.* A mother by marriage; [the mother of an orphan or one deprived.]

**STEP'-DAUGHTER**, *n.* A daughter by marriage; [an orphan daughter.]

**STEP'-FATHER**, *n.* A father-in-law; a father by marriage only; [the father of an orphan.]

**STEP'-MOTHER**, *n.* A mother by marriage only; a mother-in-law; [the mother of an orphan.]

**STEP'-SISTER**, *n.* A sister-in-law, or by marriage; [an orphan sister.]

**STEP'-SON**, *n.* A son-in-law; [an orphan son.] [In the foregoing explanation of *step*, we have followed Lye.

The *D.* and *G.* write *stief*, and the Swedes *stiff*, before the name; a word which does not appear to be connected with any verb signifying to *bereave*, and the word is not without some difficulties. If the radical sense of *step*, a pace, is to part or open, the word coincides with Sax. *stapan*, to deprive, and in the compounds above, *step* may imply removal or distance.]

**STEP'-STONE**, *n.* A stone laid before a door as a stair to rise on in entering the house.

**STEPPE**, *n.* In Russ. an uncultivated desert of large extent. [This sense of the Russian word is naturally deducible from Sax. *stapan*, to deprive.]

**STEP'PED**, *pp.* Set; plaed; erected; fixed in the keel, as a mast.

**STEP'PING**, *ppr.* Moving, or advancing by a movement of the foot or feet; placing; fixing or erecting, as a mast.

**STEP'PING**, *n.* The act of walking or running by steps.

**STEP'PING-STONE**, *n.* A stone to raise the feet above the dirt and mud in walking.—2. An aid or means by which an end may be accomplished, or an object gained.

**STER**, in composition, is from the Sax. *steora*, a director. [See *STERER*.] It seems primarily to have signified chief, principal or director, as in the *L. minister*, chief servant; but in other words, as in *spinster*, we do not recognize the sense of *chief*, but merely that of a person who carries on the business of spinning.

**STERCORA'CEOUS**, *a.* [L. *stercorosus*, *stercorosus*, from *stercus*, dung.] Pertaining to dung, or partaking of its nature.

**STERCORA'RIAN**, } *n.* [L. *stercus*, }  
**STER'CORANIST**, } dung.] One in the Romish church who held that the host is liable to digestion, and all its consequences, like other food.

**STER'CORARY**, *n.* A place properly secured from the weather for containing dung.

**STERCORATION**, *n.* [L. *stercoratio*.] The act of manuring with dung.

**STERCORIANISM**, *n.* Doctrine of the Stercorians,—*which see*.

**STERCULIA**, *n.* A genus of plants which gives its name to the nat. order Sterculiaceæ. The name is derived from *L. stercus*, dung, some of the species being remarkable for the strong and disagreeable odour of their leaves and flowers. The species consist of

various sized trees with soft timber, which are found in tropical parts of the world, with simple or compound leaves, and axillary panicles or racemes of flowers. Several of them are mucilaginous, and others yield fibre, which is converted into ropes, as the bark of *S. guttata*. The seeds of *S. acuminata* afford the *hola* spoken of by African travellers, which, when chewed or sucked, is believed by the natives to increase the flavour of any thing they may subsequently eat or drink. The Gum-Tragacanth of Sierra Leone is produced by the *S. pubescens*. The seeds of *S. chicha* are eaten as nuts



Sterculia Chleba.

by the Brazilians, and the seeds of all the genus are filled with an oil, which may be expressed and used for lamps.

**STERCULIA'CEÆ**, *n.* A nat. order of plants, belonging to the syncarpous group of polypetalous exogens. The plants of this order are trees or shrubs, with alternate, stipulate, simple, and often toothed leaves, with a variable inflorescence, and a stellate pubescence. They are natives of India, New Holland, the Cape of Good Hope, and South America, with the West Indies. The species are chiefly remarkable for the abundance of mucilage they contain. The principal genera are Helicteres, Sterculia, Bombax, Dombeya, Buttneria, Lasiopetalum, and Hermania.

**STERE**, *n.* [Gr. *στερίς*, solid.] In the *French system of measures*, the unit for solid measure, equal to a cubic metre, or 35'317 cubic inches.

**STEREOBATE**, *n.* In *arch.*, the same as *stylobate*,—*which see*.

**STEREOGRAPHIC**, } *a.* [from }  
**STEREOGRAPHICAL**, } *stereogra-*  
} *phy*.] Made or done according to the rules of stereography; delineated on a plane; as, a *stereographic chart* of the earth.—*Stereographic projection*, that projection of the sphere which is represented upon the plane of one of its great circles, the eye being situated at the pole of that great circle. The plane on which the points, lines, and circles of the sphere are represented, is called the *plane of projection*, and the point in which the eye is situated is called the *projecting point*. The *primitive circle* is situated in the plane of projection, and the projecting point on the sphere is one of the poles of this great circle; but on the plane of projection, the poles of the primitive are in its centre. In this projection,

all circles are projected either into straight lines or circles. Those which pass through the projecting point are projected into straight lines; in every other case the projection is a circle. A *parallel circle* is one whose plane is parallel to the plane of projection; a *right circle* is one whose plane is at right angles to the plane of the primitive, and as it passes through the projecting point, it is projected into a straight line. An *oblique circle* is one whose plane is oblique to that of the primitive. The *stereographic projection* is employed in the construction of maps, and also in astronomical problems. [See *PROJECTION*.]

**STEREOGRAPHICALLY**, *adv.* By delineation on a plane.

**STEREOGRAPHY**, *n.* [Gr. *στεργος*, firm, and *γραφω*, to write.] The art or art of delineating the forms of solid bodies on a plane; a branch of solid geometry which shows the construction of all solids which are regularly defined.

**STEREOMETER**, *n.* [Gr. *στεργος*, solid, and *μετρον*, a measure.] An instrument invented by M. Say, a French officer of engineers, for determining the specific gravity of liquids, porous bodies, and powders, and also of solid bodies.

**STEREOMETRICAL**, *a.* [See *STEREOMETRY*.] Pertaining to or performed by stereometry.

**STEREOMETRY**, *n.* [Gr. *στεργος*, firm, and *μετρον*, to measure.] The art of measuring solid bodies, and finding their solid content. It chiefly embraces those solids which are inscribed within plane surfaces, and a few inscribed within curved surfaces; namely, the cylinder, cone, and sphere. It also teaches to compare the various solids with each other, and to ascertain their superficial contents.

**STEREOTOMICAL**, *a.* Pertaining to or performed by stereotomy.

**STEREOTOMY**, *n.* [Gr. *στεργος*, fixed, and *τομοια*, to cut.] The science or art of cutting solids into certain figures or sections; as walls or other members in the profiles of architecture.

**STEREOTYPE**, *n.* [Gr. *στεργος*, fixed, and *τυπος*, type, form.] 1. Literally, a fixed metal type; hence, a plate of the size of a page, cast from a plaster mould, or otherwise, in which an exact representation of the types has been made, and which by this means is adapted for book-printing. Thus, we say, a book is printed on *stereotype*, or in *stereotype*. In the latter use, the word seems rather to signify the workmanship or manner of printing, than the plate. There are two stereotype processes used in this country. The *Stanhopian*, so called from Earl Stanhope, its improver, and the *patent process*. By the former process, a stucco mould is taken from the page of types, and after being baked, it is immersed in a liquid metal, in its composition resembling type metal. A metallic plate, called a *stereotype plate*, is thus formed in the mould. After being cooled, the plate is dressed, and then is ready for being printed from. By the *patent process*, the mould or matrix is taken from the types by means of layers of paper, interspread with a mixture of chalk and starch. This mould is obtained by the layers of paper being beat into the face of the types, by repeated blows of a suitable brush. The

mould or matrix being hard dried, a metallic plate is obtained from it by a process similar to that used in the Stanhopean method. Stereotyping is of great value as a means for cheapening the price of books; for, by its aid, where repeated editions are required, the outlay for setting up the types has only once to be encountered; as when a work has been stereotyped, a dozen of reprints may be taken from the plates without incurring further expense, except in printing off the sheets. Many works, such as the Penny Magazine, Chambers' Journal, Hogg's Weekly Instructor, &c. &c., could never have been produced, either in the quantity or at the price, without the aid of the stereotype process. William Ged, a goldsmith in Edinburgh, was one of the first to practise stereotyping, according to the common acceptation of the word. He is recorded to have commenced about the year 1725. Ged was followed by Tilloch and Fonils of Glasgow, Didot in Paris, Wilson and Earl Stanhope in London.—2. The art of making plates of fixed metallic types, or of executing work on such plates.

**STEREOTYPE, a.** Pertaining to fixed metallic types.—2. Done on fixed metallic types, or plates of fixed types; as, *stereotype work*; *stereotype printing*; a *stereotype copy of the Bible*.

**STEREOTYPE, v. t.** To make fixed metallic types or plates of type metal, corresponding with the words and letters of a book; to compose a book in fixed types; as, to *stereotype the New Testament*; certain societies have *stereotyped the Bible*.

**STEREOTYPE FOUNDING, n.** The process of making stereotype plates; also called *stereotyping*.

**STEREOTYPE PRINTING, n.** The art of printing from stereotype plates.

**STEREOTYPYPER, n.** One who makes stereotype.

**STEREOTYPE WORK, n.** Stereotype plates.

**STEREOTYPING, ppr.** Making stereotype plates for any work; or impressing copies on stereotype plates.

**STEREOTYPOGRAPHER, n.** A stereotype printer.

**STEREOTYPOGRAPHY, n.** The art or practice of printing on stereotype.

**STERILE, a.** [L. *sterilis*; It. and Fr. *sterile*; Sp. *estéril*.] 1. Barren; unfruitful; not fertile; producing little or no crop; as, *sterile land*; a *sterile desert*; a *sterile year*.—2. Barren; producing no young.—3. Barren of ideas; destitute of sentiment; as, a *sterile production* or author.—*Sterile flower*, in botany, is a term given by Tournefort to the male flower, or that which bears only stamens.

**STERILITY, n.** [L. *sterilitas*; Fr. *stérilité*.] 1. Barrenness; unproductiveness; unfruitfulness; the quality or state of producing little or nothing; as, the *sterility of land or soil*.—2. Barrenness; unfruitfulness; the state of not producing young; as of animals.—3. Barrenness of ideas or sentiments, as in writings.—4. Want of fertility or the power of producing sentiment; as, the *sterility of an author* or of his mind.

**STERILIZE, v. t.** To make barren; to impoverish, as land; to exhaust of fertility; as, to *sterilize soil or land*. [*Little used.*].—2. To deprive of fecundity, or the power of producing young. [*Little used.*].

**STERLET, n.** A fish of the Caspian

and of various rivers in Russia, the *Acipenser ruthenus* of Linnæus, highly

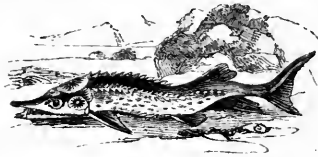

Sterlet (*Acipenser ruthenus*).

esteemed for its flavour, and from whose roe is made the finest caviare.

**STERLING, a.** [probably from *East-erling*, but the etymology is uncertain.] An epithet by which English money of account is distinguished, signifying that it is of the fixed, or standard, national value; as, a pound *sterling*; a shilling *sterling*; a penny *sterling*. [Early writers on Scotch pecuniary matters have not always distinguished native from *sterling money*.]—2. Genuine; pure; of excellent quality; as, a work of *sterling merit*; a man of *sterling wit* or sense.

**STERLING, n.** English money. And Roman wealth in English *sterling view*.

[In this use, *sterling* may signify English coins.]—2. Standard; rate. [*Little used in either sense.*].

**STERLING, n.** A breakwater or cut-water to protect the piers of a bridge.

**STERLINGS, n.** In arch. [See *STARLINGS*.]

**STERN, a.** [Sax. *styrn*, stern; G. *starr*, staring; *störig*, stubborn. See *STARE*, *STARCH*, *STARCK*, with which this word is probably connected. Gr. *στεργος*.] 1. Severe; austere; fixed with an aspect of severity and authority; as, a *stern look*; a *stern countenance*; a *stern frown*.

I would outstare the *sternest* eyes that look.

2. Severe of manner; rigid; harsh; cruel.

*Stern* as tutors, and as uncles hard.

Ambition should be made of *sterner* stuff.

3. Hard; afflictive.

If wolves had at thy gate howl'd that *stern* time

4. Rigidly steadfast; immovable. *Stern* virtue is the growth of few soils.

**STERN, n.** [Sax. *steor* and *ern*, place; the *steer-place*, that is, helm-place.] 1. The hind part of a ship or other vessel, or of a boat; the part opposite to the stem or prow. This part of a ship is terminated by the taffrel above, and by the counters below.—2. Post of management; direction.

And sit at chiefest *stern* of public weal.

[We now say, to sit at the helm.]—3. The hinder part of any thing. [*Not elegant.*]

By the *stern*, is a phrase which denotes that a ship is more deeply laden abaft than forward.

**STERN'A, n.** In ornithology, the generic name of the terns or sea-swallows. [See *TERN*.]

**STERN'AGE, n.** Steerage or stern.

**STERN'AL, a.** Pertaining to the sternum or breast-bone.

**STERNAL'GIA, n.** [Gr. *στερνον*, the breast bone and *αλγος*, pain.] Pain about the sternum or breast bone.—2. A name of the pectoral angina; *angina pectoris*.

**STERN'BERGIA, n.** A fossil plant, probably monocotyledonous, allied to the Pandanaceæ.

**STERN'BERGITE, n.** [from Count *Sternberg*.] A foliated ore of silver, consisting of silver, iron, and sulphur.

**STERN'-BOARD, n.** [*stern* and *board*.] In seamen's language, a loss of way in making a tack, also when a vessel goes stern foremost. To make a *stern-board*, is when, by a current or other cause, a vessel has fallen back from the point she had gained in the last tack; or also to set the sails so as the vessel may be impelled stern foremost.

**STERN'-CHASE, n.** [*stern* and *chase*.] A cannon placed in a ship's stern, pointing backward, and intended to annoy a ship that is in pursuit of her.

**STERN'ED, a.** In compounds, having a stern of a particular shape; as, square-*sterned*; pink-*sterned*, &c.

**STERN'ER, † n.** [Sax. *steoran*, to steer.] A director.

**STERN'-FAST, n.** [*stern* and *fast*.] A rope used to confine the stern of a ship or other vessel.

**STERN'-FRAME, n.** [*stern* and *frame*.] The several pieces of timber which form the stern of a ship.

**STERN'LY, adv.** [See *STERN*.] In a stern manner; with an austere or *stern* countenance; with an air of authority.

*Sternly* he pronounced  
The rigid interdiction.

**STERN'MOST, a.** [*stern* and *most*.] Farthest in the rear; farthest stern; as, the *sternmost* ship in a convoy.

**STERN'NESS, n.** Severity of look; a look of austerity, rigour, or severe authority; as, the *sternness* of one's presence.—2. Severity or harshness of manner; rigour.

I have *sternness* in my soul enough  
To hear of soldiers' work.

**STERN'ON, n.** [Gr.] The breast bone. But *sternum* is chiefly or wholly used.

**STERN'-PORT, n.** [*stern* and *port*.] A port or opening in the stern of a ship.

**STERN'-POST, n.** [*stern* and *post*.] A straight piece of timber, erected on the extremity of the keel to support the rudder and terminate the ship behind.

**STERN'-SHEETS, n.** [*stern* and *sheet*.] That part of a boat which is between the stern and the aftmost seat of the rowers; usually furnished with seats for passengers.

**STERN'UM, n.** [Gr. *στερνον*: from fixing; setting. See *STARCH*, *STARCK*.] The breast bone; the bone which forms the front of the human chest from the neck to the stomach.

**STERNUTA'TION, n.** [L. *sternutatio*.] The act of sneezing.

**STERNU'TATIVE, a.** [L. *sternuo*, to sneeze.] Having the quality of provoking to sneeze.

**STERNU'TATORY, a.** [Fr. *sternutatoire*, from L. *sternuo*, to sneeze.] Having the quality of exciting to sneeze.

**STERNU'TORY, n.** A substance provoking to sneeze. The most familiar *sternutatories* are snuffs of different kinds. They are chiefly employed to occasion a violent succussion of the frame, either to restore suspended respiration, as in some cases of fainting, or to dislodge some foreign body from the nasal passages or windpipe.

**STERN'-WAY, n.** [*stern* and *way*.] The movement of a ship backward, or with her stern foremost.

**STERQUILINOUS, a.** [L. *sterquilinus*



*nium*, a dunghill.] Pertaining to a dunghill; mean; dirty; paltry.

**STERTORIOUS**, } *a.* [L. *sterto*.]  
**STERTOROUS**, } Snoring. The last is the term almost invariably used.

**STEVEN**, † to *starve*.

**STETHOSCOPE**, *n.* [Gr. *σθησος*, the breast, and *σκοπος*, to examine.] A simple cylinder of some fine-grained light wood, as cedar or maple, perforated longitudinally in the middle, with one extremity funnel-shaped and furnished with a conical plug; the other with a comparatively large orbicular ivory plate, fastened by a screw. This instrument is used for distinguishing sounds within the thorax, and other cavities of the body, the funnel-shaped extremity, either with or without the plug, being placed upon the body, and the ivory plate to the ear of the listener. [See **ASCULTATION**.] *Stethoscope* is an ill chosen term, since its application is not confined to the breast, and the termination *scope* does not well express its use. *Phonophorus* or *sound-conductor*, would be preferable.

**STETHOSCOPIC**, *a.* Pertaining to a stethoscope.

**STEVE**, *v. t.* [from the root of *stow*.] To stow, as cotton or wool in a ship's hold. [Local.]

**STEVEDORE**, *n.* One whose occupation is to stow goods, packages, &c., in a ship's hold. [This word and the foregoing are much used by traders in North and South America, especially New York and the ports of Brazil.]

**STEVEN**, † *n.* [Sax. *stefnian*, to call.] An outcry; a loud call; a clamour.

**STEW**, *v. t.* [Fr. *étuver*, to stew; *étuve*, a stove; It. *stufare*, to stew; *stufa*, a stove; *stufu*, weary, surfeited; Sp. *estufa*, a stove; *estofa*, stuff quilted; *estofar*, to quilt and to stew; D. *stooft*, a stove; *stooven*, to stew; Dan. *stue*, a room, [see **Strow**.] and *stuevæn*, a stove; Sw. *stufva*, to stew and to stow.] 1. To seethe or gently boil; to boil slowly in a moderate manner, or with a simmering heat; as, to *stew* meat; to *stew* apples; to *stew* prunes.—2. To boil in heat.

**STEW**, *v. i.* To be seethed in a slow gentle manner, or in heat and moisture.

**STEW**, *n.* A hot-house; a bagnio.

The Lydians were inhibited by Cyrus to use any armour, and give themselves to baths and *stews*. *Abbot*.

2. A brothel; a house of prostitution; but generally or always used in the plural, *stews*.—3. † A prostitute.—4. † [See **Stow**.] A store pond; a small pond where fish are kept for the table.—5. Meat stewed; as, a *stew* of pigeons.—6. A *stew-pan*.

**STEWARD**, *n.* [Sax. *steward*.] *Ward* is a keeper; but the meaning of the first syllable is not evident. It is probably a contraction of G. *stube*, a room, Eng. *stow*, Sax. *stow*, place, or *sted*, place, or of Dan. *stib*, a cup. The *steward* was then originally a chamberlain or a butler.] 1. A man employed in great families to manage the domestic concerns, superintend the other servants, collect the rents or income, keep the accounts, &c. See Gen. xv. 2; xliii. 19.—2. An officer of state; as, lord high *steward*; *steward* of the household, &c. The *lord high steward* of England was one of the ancient great officers of state, the greatest under the crown. This office was

anciently the inheritance of the earls of Leicester, till forfeited by Simon de Montfort, to Henry III., when it was in fact abolished as a permanent dignity. A lord high steward is now made only for particular occasions, the office to cease when the business requiring it is ended; namely, on the occasion of a coronation, or the trial of a peer. In the former case the lord high steward is commissioned to settle matters of precedence, &c.; in the latter, to preside in the house of lords. The *lord steward of the household* is an officer of the king's (queen's) household, who is steward of the marshal's office or court of the household, which office he performs by deputy. His authority extends over the officers and servants of the royal household, except those of the chamber, chapel, and stables. His department includes also the *counting-house*, where the household accounts are kept. Within the counting-house is the *board of green cloth*.—3. In *colleges*, an officer who provides food for the students and superintends the concerns of the kitchen.—4. In a *ship of war*, an officer who is appointed by the purser to distribute provisions to the officers and crew. In other ships, a man who superintends the provisions and liquors, waits at table, &c.—5. In *scrip*, and *theol.*, a minister of Christ, whose duty is to dispense the provisions of the gospel, to preach its doctrines and administer its ordinances.

It is required in *stewards* that a man be found faithful; 1 Cor. iv.

6. A fiscal agent of certain bodies; as, the *steward* of a congregation of methodists, &c.

**STEW'ARD**, † *v. t.* To manage as a steward.

**STEW'ARDESS**, *n.* A female who waits upon ladies in passage vessels, steam-packets, &c.

**STEW'ARDLY**, *adv.* With the care of a steward. [Little used.]

**STEW'ARDSHIP**, *n.* The office of a steward.

**STEW'ARTRY**, *n.* An overseer or superintendent.

The *stewartry* of provisions. *Tooke*. In *Scotland*, a division of a county; as, the *stewartry* of Kirkcudbright.

**STEW'ED**, *pp.* Gently boiled; boiled in heat.

**STEW'ING**, *ppr.* Boiling in a moderate heat.

**STEW'ING**, *n.* The act of seething slowly.

**STEW'ISH**, *a.* Suiting a brothel.

**STEW'PAN**, *n.* A pan or pot in which things are stewed.

**STHEN'IC**, *a.* [Gr. *σθενος*.] In *med.*, attended with a preternatural and morbid increase of vital energy and strength of action in the heart and arteries; phlogistic. *Sthenic* diseases are opposed to diseases of debility or *asthenic diseases*.

**STIAN**, } *n.* A humour in the eyelid;  
**STY'AN**, } a sty,—*whic* see.

**STIB'IAL**, *a.* [L. *stibium*, antimony.] Like or having the qualities of antimony; antimonial.

**STIB'LATED**, *a.* Impregnated with antimony.

**STIB'UM**, *n.* [L.] Antimony.

**STICH**, *n.* [Gr. *σχιχος*.] 1. In *poetry*, a verse, of whatever measure or number of feet. [*Stich* is used in numbering the books of Scripture.]—2. In *rural affairs*, an order or rank of trees.

**STICH'IC**, *a.* Relating to or consisting of lines or verses.

**STICH'OMANCY**, *n.* [Gr. *σχιχος*, a line or verse, and *μαντια*, divination.] Divination by lines or passages in books taken at hazard. This species of divination was in use among the Romans. Verses from the Sibylline books were written on small slips of paper, which were shaken in a vessel, and one of them drawn out, in order to discover from it some intimation of future events. Of the same kind were the *Sortes Virgilianæ*, *Homericæ*, &c.

**STICHOMETRY**, *n.* [Gr. *σχιχος*, a verse, *μετρον*, measure.] A catalogue of the books of Scripture, with the number of verses which each book contains.

**STICH-WÖRT**. See **STITCH-WORT**.

**STICK**, *n.* [Sax. *sticca*; G. *stechen*.] This word is connected with the verb to *stick*, with *stock*, *stack*, and other words having the like elements. The primary sense of the root is to thrust, to shoot, and to set; Fr. *tige*, a stalk.]

1. The small shoot or branch of a tree or shrub, cut off; a rod; also, a staff; as, to strike one with a *stick*.—2. Any stem of a tree, of any size, cut for fuel or timber. It is applied in common language to any long and slender piece of timber, round or square, from the smallest size to the largest, used in the frames of buildings; as, a *stick* of timber for a post, a beam, or a rafter.—3. Many instruments, long and slender, are called *sticks*; as, the composing *stick* of printers.—4. A thrust with a pointed instrument that penetrates a body; a stab.—*Gold stick*, a name applied to the colonels of the two regiments of Life Guards, whose duty it is to be in immediate attendance on the sovereign on all state occasions. These colonels do duty for a month alternately, the one on duty being then called *gold stick* in waiting, and all orders relating to the Life Guards are transmitted through him. The field-officer of the Life Guards when on duty is called *silver stick*. He is in waiting for a week, during which period all reports are made through him to the gold stick, and orders from the gold stick pass through him to the brigade. The term *gold stick* originated in the custom of the sovereign presenting the colonel of the Life Guards with a gold stick on his receiving the regiment.—*Stick of eels*, the number of twenty-five eels. A bind contains ten *sticks*.

**STICK**, *v. t.* pret. and pp. *Stuck*. [Sax. *stican*, *stician*; G. *stetchen*, to sting or prick, and *stechen*, to stick, to adhere; D. *stechen*, to prick or stab; *stikken*, to stitch; Dan. *stikker*, to sting, to prick; Sw. *sticha*; Gr. *στίχο*, *στιγμα*: W. *ystigaw*; Ir. *steacham*.] 1. To pierce; to stab; to cause to enter, as a pointed instrument; hence, to kill by piercing; as, to *stick* a beast in slaughter. [A common use of the word.]—2. To thrust in; to fasten or cause to remain by piercing; as, to *stick* a pin on the sleeve.

The points of spears are *stuck* within the shield. *Dryden*.

3. To fasten; to attach by causing to adhere to the surface; as, to *stick* on a patch or plaster; to *stick* on a thing with paste or glue.—4. To set; to fix in; as, to *stick* card teeth.—5. To set with something pointed; as, to *stick*

cards.—6. To fix on a pointed instrument ; as, to *stick* an apple on a fork. STICK, *v. i.* To adhere ; to hold by cleaving to the surface, as by tenacity or attraction ; as, glue *sticks* to the fingers ; paste *sticks* to the wall, and causes paper to *stick*.

I will cause the fish of thy rivers to *stick* to thy scales ; Ezek. xxix. 2. To be united ; to be inseparable ; to cling fast to, as something reproachful. If on your fame our sex a blot has thrown, 'Twill ever *stick*, through malice of your own. *Young.* 3. To rest with the memory ; to abide.—4. To stop ; to be impeded by adhesion or obstruction ; as, the carriage *sticks* in the mire.—5. 'To stop ; to be arrested in a course.

My faltering tongue *sticks* at the sound. *Smith.* 6. To stop ; to hesitate. He *sticks* at no difficulty ; he *sticks* at the commission of no crime ; he *sticks* at nothing.—7. To adhere ; to remain ; to resist efforts to remove.

I had most need of blessing, and amen *stuck* in my throat. *Shak.* 8. To cause difficulties or scruples ; to cause to hesitate.

This is the difficulty that *sticks* with the most reasonable. *Swift.* 9. To be stopped or hindered from proceeding ; as, a bill passed the house of lords, but *stuck* in the commons.

They never doubted the commons, but heard all *stuck* in the lords' house. *Clarendon.* 10. To be embarrassed or puzzled.

They will *stick* long at part of a demonstration, for want of perceiving the connection between two ideas. *Locke.* 11. To adhere closely in friendship and affection.

There is a friend that *sticketh* closer than a brother ; Prov. xviii. To *stick* to, to adhere closely ; to be constant ; to be firm ; to be persevering ; as, to *stick* to a party or cause.

The advantage will be on our side, if we *stick* to its essentials. *Addison.* To *stick* by, to adhere closely ; to be constant ; to be firm in supporting.

We are your only friends ; *stick* by us, and we will *stick* by you. *Duvenant.*

2. To be troublesome by adhering. I am satisfied to trifle away my time, rather than let it *stick* by me. *Pope.* To *stick* upon, to dwell upon ; not to forsake.

If the matter be knotty, the mind must stop and buckle to it, and *stick* upon it with labour and thought. [Not elegant.] *Locke.* To *stick* out, to project ; to be prominent.

His bones that were not seen, *stick* out ; Job xxxiii.

STICK'INESS, *n.* [from *stick*.] The quality of a thing which makes it adhere to a plain surface ; adhesiveness ; viscosness ; glutinousness ; tenacity ; as, the *stickiness* of glue or paste.

STICK'ING, *n.* In *Arch.*, the operation of forming mouldings by means of a plane, in distinction from the operation of forming them by the hand.

STICK-LAC. *See* LAC. STICK'LE, *v. i.* [from the practice of prize-fighters, who placed seconds with staffs or sticks to interpose occasionally.] 1. To take part with one side or other.

Fortune, as she wont, turn'd fickle, And for the foe began to *stickle*. *Hudibras.* 2. To contend ; to contest ; to alternate. Let the parties *stickle* each for his favourite doctrine.—3. To trim ; to

play fast and loose ; to pass from one side to the other.

STICK'LE, *v. t.* To arbitrate. STICK'LE-BACK, *n.* The popular name for certain small fishes which constitute the genus *Gasterosteus* of Linn. This genus is arranged by Cuvier with the mail-checked acanthopterygians. Several species are found in the ponds and streams of this country, and one species is found in the salt-water ; they are very active and voracious, and live upon aquatic insects and worms. The most common species is the three-spined stickle-back (*G. aculeatus*, Linn.), which is distinguished by the body being protected at the sides with shield-like plates, and by the possession of three spines on the back. It is of an olive colour above, and silvery white beneath, and varies from two to three inches in length.

STICK'LER, *n.* A sidesman to fencers ; a second to a duellist ; one who stands to judge a combat. Basilius the judge, appointed *sticklers* and trumpets whom the others should obey. *Stanyey.* 2. An obstinate contender about any thing ; as, a *stickler* for the church or for liberty.

The tory or high church clergy were the greatest *sticklers* against the exorbitant proceedings of King James. *Swift.*

3. Formerly, an officer who cut wood for the priory of Ederose, within the king's parks of Clarendon. STICK'LING, *ppr.* Trimming ; contending obstinately or eagerly.

STICK'Y, *a.* Having the quality of adhering to a surface ; adhesive ; gluey ; viscous ; viscid ; glutinous ; tenacious. Gums and resins are *sticky* substances. STIFF, *a.* [Sax. *stif* ; G. *steif* ; allied to *L. stipo, stabilis*, Eng. *staple*, Gr. *στίψος, στίβιον, στίβω*.] 1. Not easily bent ; not flexible or pliant ; not flaccid ; rigid ; applicable to any substance ; as, *stiff* wood ; *stiff* paper ; cloth *stiff* with starch ; a limb *stiff* with frost.

They, rising on *stiff* pinions, tower, The mid aerial sky. *Milton.*

2. Not liquid or fluid ; thick and tenacious ; inspissated ; not soft nor hard. Thus melted metals grow *stiff* as they cool ; they are *stiff* before they are hard. The paste is too *stiff*, or not *stiff* enough.—3. Strong ; violent ; impetuous in motion ; as in *seamen's lan.*, a *stiff* gale or breeze.—4. Hardy ; stubborn ; not easily subdued.

How *stiff* is my vile sense ! *Shak.* 5. Obstinate ; pertinacious ; firm in perseverance or resistance.

It is a shame to stand *stiff* in a foolish argument. *Taylor.* A war ensues ; the Cretans own their cause, *Stiff* to defend their hospitable laws. *Dryden.*

6. Harsh ; formal ; constrained ; not natural and easy ; as, a *stiff* formal style.—7. Formal in manner ; constrained ; affected ; starched ; not easy or natural ; as, *stiff* behaviour.

The French are open, familiar, and talkative ; the Italians *stiff*, ceremonious, and reserved. *Addison.*

8. Strongly maintained, or asserted with good evidence. This is *stiff* news. *Shak.*

9. In *seamen's lan.*, a *stiff* vessel is one that will bear sufficient sail without danger of oversetting.—*Stiff stem*, in *bot.*, a stem which rises directly and is firm enough to support itself ; as in

*Rumex crispus*.—*Stiff leaf*, one that is hard and not easily bent ; as in *Ruscus aculeatus*.

STIFFEN, *v. t.* (*stif'n*) [Sax. *stifian* ; G. *stefen* ; Dan. *stivner*, to stiffen, to starch.] 1. To make stiff ; to make less pliant or flexible ; as, to *stiffen* cloth with starch.

He *stiffened* his neck and hardened his heart from turning to the Lord God of Israel ; 2 Chron. xxxvi.

*Stiffen* the sinews ; summon up the blood. *Shak.*

2. To make torpid ; as, *stiffening* grief.—3. To inspissate ; to make more thick or viscous ; as, to *stiffen* paste.

STIFF'EN, *v. i.* (*stif'n*) To become stiff ; to become more rigid or less flexible.

Like bristles rose my *stiff'ning* hair. *Dryden.*

2. To become more thick, or less soft ; to be inspissated ; to approach to hardness ; as, melted substances *stiffen* as they cool.

The tender soil then *stiff'ning* by degrees. *Dryden.*

3. To become less susceptible of impression ; to become less tender or yielding ; to grow more obstinate.

Some souls we see, Grow hard and *stiffen* with adversity. *Dryden.*

STIFF'ENED, *pp.* Made stiff or less pliant.

STIFF'ENING, *ppr.* Making or becoming less pliable, or more thick, or more obstinate.

STIFF'ENING, *n.* Something that is used to make a substance more stiff or less soft.

STIFF-HEARTED, *a.* [*stiff* and *heart*.] Obstinate ; stubborn ; contumacious.

They are impudent children and *stiff-hearted* ; Ezek. ii.

STIFF'LY, *adv.* Firmly ; strongly ; as, the boughs of a tree *stiffly* upheld.—2. Rigidly ; obstinately ; with stubbornness. The doctrine of the infallibility of the Church of Rome is *stiffly* maintained by its adherents.

STIFF'-NECKED, *a.* [*stiff* and *neck*.] Stubborn ; inflexibly obstinate ; contumacious ; as, a *stiff-necked* people ; *stiff-necked* pride.

STIFF'NESS, *n.* Rigidity ; want of pliability or flexibility ; the firm texture or state of a substance which renders it difficult to bend it ; as, the *stiffness* of iron or wood ; the *stiffness* of a frozen limb.—2. Thickness ; spicitude ; a state between softness and hardness ; as, the *stiffness* of sirup, paste, size, or starch.—3. Torpidness ; inaptitude to motion.

An icy *stiffness* Benumbs my blood. *Denham.* 4. Tension ; as, the *stiffness* of a cord.—5. Obstunacy ; stubbornness ; contumaciousness.

The vices of old age have the *stiffness* of it too. *South.*

*Stiffness* of mind is not from adherence to truth, but submission to prejudice. *Locke.*

6. Formality of manner ; constraint ; affected precision.

All this religion sat easily upon him, without *stiffness* and constraint. *Atterbury.*

7. Rigorousness ; harshness. But speak no word to her of these sad plights.

Which too constant *stiffness* doth constrain. *Spenser.*

8. Affected or constrained manner of expression or writing ; want of natural simplicity and ease ; as, *stiffness*

of style.—9. A disease of cows, in which the animal affected falls into a kind of atrophy, and wastes away. [*Scotch.*] **STIFFLE**, *v. t.* [The Fr. *étouffer*, to stifle, is nearly allied to *étouffe*, Eng. *stuff*, L. *stupa*. But *stifle* seems to be more nearly allied to L. *stipo* and Eng. *stiff* and *stop*; all however of one family. Qu. Gr. *στένω*.] 1. To suffocate; to stop the breath or action of the lungs by crowding something into the wind-pipe, or by infusing a substance into the lungs, or by other means; to choke; as, to *stifle* one with smoke or dust.—2. To stop; as, to *stifle* the breath; to *stifle* respiration.—3. To oppress; to stop the breath temporarily; as, to *stifle* one with kisses; to be *stified* in a close room or with bad air.—4. To extinguish; to deaden; to quench; as, to *stifle* flame; to *stifle* a fire by smoke or by ashes.—5. To suppress; to hinder from transpiring or spreading; as, to *stifle* a report.—6. To extinguish; to check or restrain and destroy; to suppress; as, to *stifle* a civil war in its birth.—7. To suppress or repress; to conceal; to withhold from escaping or manifestation; as, to *stifle* passion; to *stifle* grief; to *stifle* resentment.—8. To suppress; to destroy; as, to *stifle* convictions.

**STIFFLE**, *n.* The joint of a horse next to the buttock, and corresponding to the knee in man; called also the *stifle joint*.—2. A disease in the knee-pan of a horse or other animal.

**STIFFLED**, *pp.* Suffocated; suppressed.

**STIFFLE-JOINT**, *n.* The first joint and bending next to the buttock of a horse.

**STIFFLING**, *ppr.* Suffocating; suppressing.

**STIGMA**, *n.* [L. from Gr. *στίγμα*, from *στίξω*, to prick or *stick*.] 1. A brand; a mark made with a burning iron.—2. Any mark of infamy; any reproachful conduct which stains the purity or darkens the lustre of reputation.—3. In *bot.*, the upper extremity of the style, and the part which in impregnation receives the pollen. It is composed of

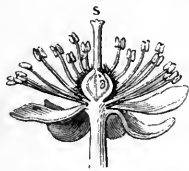

Section of Flower; 4, Stigma.

cellular tissue, and has its surface destitute of true epidermis, and is usually moist. When the style is wanting, the stigma is said to be *sessile*, as in the poppy and tulip. In many plants there is only one stigma, while in others there are two, three, five, or many, the number of stigmas being determined by that of the styles. The stigma is generally *terminal*, or placed at the end of the style; but it is sometimes *lateral*, or occupying its side as in *Ranunculus*. Considered in respect to its substance, form, &c., it is designated *fleshy*, *glandular*, *membranous*, *petaloid*, *globular* or *capitate*, *hemispherical*, *discoid*, *lobed*, *claviform*, *filiform*, *capillary*, *erect*, *oblique*, *slit*, *smooth*, *downy*, *hairy* or *feathery*, &c.—4. In *pathol.*, a small red speck on the skin, 11.

causing no elevation of the cuticle. Also a natural mark or spot on the skin.

**STIGMARIA**, *n.* Formerly supposed to be a family of extinct fossil plants of the coal formation, in external structure resembling the Euphorbiacæ; but now ascertained to be merely the roots of the *Sigillaria*,—*which see*.

**STIGMATA**, *n. plur.* The apertures in the bodies of insects communicating with the tracheæ or air-vessels.—2. In *antiquity*, certain marks impressed on the left shoulders of soldiers when enlisted.—3. In *theol. lan.*, the marks of the wounds of our Saviour.

**STIGMATIC**, } a. Marked with a  
**STIGMATICAL**, } stigma, or with something reproachful to character.—2. Impressing with infamy or reproach.

**STIGMATIC**, *n.* A notorious profligate, or criminal, who has been branded. [*Little used.*]—2. One who bears about him the marks of infamy or punishment. [*Little used.*]—3. One on whom nature has set a mark of deformity. [*Little used.*]

**STIGMATICALY**, *adv.* With a mark of infamy or deformity.

**STIGMATIZE**, *v. t.* [Fr. *stigmatiser*.] 1. To mark with a brand; in a *literal sense*; as, the ancients *stigmatized* their slaves and soldiers.—2. To set a mark of disgrace on; to disgrace with some note of reproach or infamy.

To find virtue extolled and vice *stigmatized*. *Addison.*

Sour enthusiasts affect to *stigmatize* the finest and most elegant authors, ancient and modern, as dangerous to religion. *Addison.*

**STIGMATIZED**, *pp.* Marked with disgrace.

**STIGMATIZING**, *ppr.* Branding with infamy.

**STIGMATIZING**, *n.* In *antiquity*, the act of affixing a mark upon slaves, sometimes as a punishment, but more usually in order to know them. It was done by applying a red-hot iron, marked with certain letters, to their foreheads, till a fair impression was made, and then pouring ink into the furrows. Recruits were burned in the hand, usually with the name of the general.

**STIGONOMANCY**, *n.* [Gr. *στιγών*, from *στίξω*, to mark with points, and *μαντική*.] Divination by writing on the bark of a tree.

**STILAR**, *a.* [from *stile*.] Pertaining to the stile of a dial.

Draw a line for the *stilar line*. *Mozon.*

**STILBITE**, *n.* [Gr. *στίλβω*, to shine.] A mineral of a shining pearly lustre, of a white colour, or white shaded with grey, yellow, or red. It has been associated with zeolite, and called foliated zeolite, and radiated zeolite. Werner and the French mineralogists divide zeolite into two kinds, mesotype and stilbite; the latter is distinguished by its lamellar structure.

**STILE**, *n.* [This is another spelling of *style*. See *STYLE* and *STILL*.] A pin set on the face of a dial to form a shadow.

Erect the *stile* perpendicularly over the sub-stilar line, so as to make an angle with the dial-plane equal to the elevation of the pole of your place. *Mozon.*

**STILE**, *n.* [Sax. *stigel*, a step, ladder, from *stigan*, to step, to walk, to ascend; G. *stegel*; Dan. *stiel*, from *stiger*, to rise, to step up; Sw. *steg*, a step, *stiga*, to step. See *STAIR*.] A contrivance for allowing people to pass over or through fences, without permitting the larger quadrupeds to follow them.

There are various forms of styles; as by steps over a wall; by a zig-zag passage formed by stakes, through a hedge or paling; a turning bar, or turnstile, &c.—2. In *arch.*, the vertical part of a piece of framing, into which timber the ends of the rails are fixed by mortises and tenons.

**STILETTO**, *n.* [It. dim. from *stilo*; Fr. *styilet*. See *STYLE*.] 1. A small dagger with a round pointed blade about six inches long.—2. A pointed instrument for making eyelet holes in working muslin.

**STILETTO**, *v. t.* To stab or pierce with a stiletto.

**STILL**, *v. t.* [Sax. *stillan*; G. and D. *stillen*; Dan. *stiller*; Sw. *stilla*, to still, to quiet or appease, that is, to set, to repress; coinciding with G. *stellen*, to put, set, place, Gr. *στέλλω*, to send, and with *style*, *stool*, *stall*.] 1. To stop, as motion or agitation; to check or restrain; to make quiet; as, to *still* the raging sea.—2. To stop, as noise; to silence.

With his name the mothers *still* their babes. *Shak.*

3. To appease; to calm; to quiet; as tumult, agitation, or excitement; as, to *still* the passions.

**STILL**, *a.* Silent; uttering no sound; applicable to animals or to things. The company or the man is *still*; the air is *still*; the sea is *still*.—2. Quiet; calm; not disturbed by noise; as, a *still evening*.—3. Motionless; as, to stand *still*; to lie or sit *still*.—4. Quiet; calm; not agitated; as, a *still atmosphere*.

**STILL**, *n.* Calm; silence; freedom from noise; as, the *still* of midnight. [*A poetic word.*]

**STILL**, *adv.* To this time; till now. It hath been anciently reported, and is *still* received. *Bacon.*

[*Still* here denotes this time; set or fixed.]—2. Nevertheless; notwithstanding.

The desire of fame betrays an ambitious man into indecencies that lessen his reputation; he is *still* afraid lest any of his actions should be thrown away in private. *Addison.*

[*Still* here signifies *set*, *given*, and refers to the whole of the first clause of the sentence. The desire of fame betrays an ambitious man into indecencies that lessen his reputation; that *fact being given or set*, or *notwithstanding*, he is afraid, &c.]—3. It precedes or accompanies words denoting increase or degree; as, a *still* further advance in prices may be expected.—4. Always; ever; continually.

Trade begets trade, and people go much where many people have already gone; so men run *still* to a crowd in the streets, though only to see. *Temple.*

The fewer *still* you name, you wound the more. *Pope.*

5. After that; after what is stated. In the primitive church, such as by fear were compelled to sacrifice to strange gods, after repented, and kept *still* the office of preaching the gospel. *Whitgift.*

6. In continuation. And, like the watchful minutes to the hour, *Still* and anon cheer'd up the heavy time. *Shak.*

**STILL**, *n.* [L. *stillo*, to drop. See *DISTILL*.] An apparatus for the distillation of liquids upon the large scale. The common still consists of the boiler, made of copper, which contains the liquid to be distilled, and which is usually set in brickwork over a fur-

nance; a movable *head*, with a swan-like neck, which is fitted into the top of the boiler; the *worm*, which is a coiled tube connected with the neck of the head, and which is packed away in a vessel of water kept constantly cold, called a *refrigeratory*. The fire is applied either immediately to the boiler, or mediately by means of a water or sand bath. The liquid to be obtained rises in vapour into the head of the still, and, passing down the curved tube or worm, is condensed by the refrigeratory, and then passes from the extremity of the worm in successive drops, or in a small continuous stream, into the *recipient*. There are a great variety of stills adapted to particular purposes, the most important being those employed for distilling spirituous liquors. Great distilleries are usually mounted with two stills, a larger and a smaller. The former, called the *wash-still*, is used for distilling low wines, and the latter for rectifying the low wines.

**STILL**, *v. t.* [*L. stillo.*] To expel spirit from liquor by heat and condense it in a refrigeratory; to distil. [*See DISTILL.*]  
**STILL**, *v. i.* To drop. [*See DISTILL.*]  
**STILLA'TIM**, *adv.* [*L.*] Drop by drop.  
**STILLATI'V'IOUS**, *a.* [*L. stillatitius.*] Falling in drops; drawn by a still.

**STILLATORY**, *n.* An alembic; a vessel for distillation. [*Little used, or not at all.*]  
 —2. A laboratory; a place or room in which distillation is performed. [*Little used.*]

**STILL-BIRTH**, *n.* State of being still-born; birth of a lifeless thing.

**STILL-BORN**, *a.* Dead at the birth; as, a *still-born* child.—2. Abortive; as, a *still-born* poem.

Your *still born* poems shall revive. *Swift.*

**STILL-BORN**, *adv.* In an abortive manner.

My first essays dropped *still-born* from the press. *David Hume.*

**STILL-BURN**, *v. t.* [*still* and *burn.*] To burn in the process of distillation; as, to *still-burn* brandy.

**STILL'ED**, *pp.* [*See STILL*, the verb.] Calmed; appeased; quieted; silenced.

**STILL'ER**, *n.* One who stills or quiets.

**STILL-HOUSE**, *n.* A distillery; or, rather, the part containing the still.

**STILLICIDE**, *v. t.* [*L. stillicidium*; *stilla*, a drop, and *cado*, to fall.] A continual falling or succession of drops.

The *stillicides* of water, if there be water enough to follow, will draw themselves into a small thread; because they will not discontinue. *Bacon, Nat. Hist.*

**STILLICID'IOUS**, *a.* Falling in drops.  
**STILL'ING**, *ppr.* Calming; silencing; quieting.

**STILL'ING**, *n.* The act of calming; silencing or quieting.—2. A stand for casks.

**STILLIN'GIA**, *n.* A genus of plants, nat. order Euphorbiaceae. It now includes the species of *Sapium*, and is distinguished by one of the species being the famous tallow-tree of China (*S. sebifera*). The species consist of milky trees or shrubs, found in the tropical parts of Asia and America, and likewise in Bourbon and Mauritius. The tallow-tree of China grows to the height of a pear-tree, having a trunk and branches like the cherry, and foliage like the black poplar. Its fruit furnishes the Chinese with candles, and oil for their lamps. The tallow obtained from the fruit is also employed in medicine instead of lard.

**STILL-LIFE**, *n.* [*still* and *life.*] Things that have only vegetable life.—2. In *painting*, the representation of inanimate objects, such as dead animals, furniture, fruits, &c.

Even that, which according to a term of art, we commonly call *still-life*. *Shaftesbury.*

**STILL'NESS**, *n.* Freedom from noise or motion; calmness; quiet; silence; as, the *stillness* of the night, the air, or the sea.—2. Freedom from agitation or excitement; as, the *stillness* of the passions.—3. Habitual silence; taciturnity; as, the *stillness* of youth. *Shak.*

**STILL-ROOM**, *n.* An apartment for distilling; a domestic laboratory.

**STILL-STAND**, *n.* Absence of motion. [*Little used.*]

**STILL'Y**, *adj.* Still, quiet.  
*Of in the stilly night. T. Moore.*

**STILL'Y**, *adv.* Silently; without noise.—2. Calmly; quietly; without tumult.

**STILPNOSID'ERITE**, *n.* [*Gr. stilpnos*, shining, and *siderite*.] A mineral of a brownish black colour, massive, in curving concretions, splendid and resinous. It is an hydrated peroxide of iron.

**STILT**, *n.* [*G. stelze*; *D. stelt, stellen*; *Dan. stytter.*] A stilt is a long piece of wood, with a rest for the foot. Stilts are used in pairs for walking with the feet raised above the ground.

Men must not walk upon stilts. *L' Etrange.*

2. In *arch.*, *stilts* is used synonymously with *starlings*,—*which see.*

**STILT**, *v. t.* To raise on stilts; to elevate.—2. To raise by unnatural means.

**STILT BIRD**, or **STILT PLOVER**, *n.* A bird of the plover kind, the *Himantopus melanopterus* of naturalists; Fr.



Stilt Plover (*Himantopus melanopterus*).

*l'échasse à manteau noir*; *It. cavaliere grande italiano*; *Ger. Schwarzflügelige Strandreuter*. It has a long bill, also very long wings for its size. Whole length of the body, from beak to tail tip, 14 inches; to the claws, 19. Length of legs, which are of bright red colour, 18 to 20 inches; three-toed. The face, neck, and under parts generally, are white, tinged with rose on the breast and belly; the head, much of the wings, &c., nearly black. The Rev. Gilbert White asserts, "that these birds exhibit, weight for inches, incomparably the greatest length of legs of any known kind." The *Stilt bird* is rarely seen in our latitudes, its chief habitats being Southern Europe and the genial regions of Western Asia.

**STILT'ED**, *pp.* Raised on stilts.—2. Unreasonably elevated.—*Stilted arch*, a term applied by Mr. Willis to a form

of the arch used chiefly in the twelfth century. In this form the arch does not spring immediately from the im-

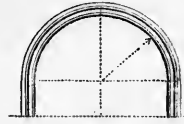

Stilted Arch.

posts, but is raised as it were upon stilts for some distance above them.

**STILT'ING**, *ppr.* Raising on stilts.

**STILT'IFY**, *v. t.* To raise, as on stilts.

**STILT'Y**, *a.* Inflated; pompos.

**STIM'PART**, *n.* The eighth part of a Winchester bushel. [*Scotch.*]

**STIM'ULANT**, *a.* [*L. stimulan.*] In *med.*, producing a quickly diffused and transient increase of vital energy and strength of action in the heart and arteries; provocative; inciting.

**STIM'ULANT**, *n.* In *med.*, an article which produces a quickly diffused and transient increase of vital energy and strength of action in the heart and arterial system; a provocative; an excitement. Stimulants are of two classes: the former comprises medicinal substances; the latter warmth, cold, electricity, galvanism, and mental agents; such as music, joy, hope, &c. The former class are divided into *permanent* and *diffusible stimulants*. Volatile or essential oils, when pure or in the combinations in which they exist, in roots, barks, or flowers, and also malt liquors, are ranked among permanent stimulants; and ammonia, alcohol, and sulphuric ether are employed as diffusible stimulants. Stimulants have also been divided into *general* and *topical*, according as they affect the whole system or a particular part.

**STIM'ULATE**, *v. t.* [*L. stimulo*, to prick, to goad, to excite; *stimulus*, a goad.] 1. Literally, to prick or goad. Hence,—2. To excite, rouse, or animate to action or more vigorous exertion by some pungent motive or by persuasion; as, to *stimulate* one by the hope of reward, or by the prospect of glory.—3. In *med.*, to produce a quickly diffused and transient increase of vital energy and strength of action in the heart and arteries.

**STIM'ULATED**, *pp.* Goaded; roused or excited to more vigorous exertion.

**STIM'ULATING**, *ppr.* Goadling; exciting to more vigorous exertion.

**STIMULA'TION**, *n.* The act of goading or exciting.—2. In *med.*, a quickly diffused and transient increase of vital energy and strength of action in the heart and arteries.

**STIM'ULATIVE**, *a.* Having the quality of stimulating.

**STIM'ULATIVE**, *n.* That which stimulates; and that which rouses into more vigorous action.

**STIM'ULATOR**, } *n.* One that stimulates.  
**STIM'ULATRESS**, } *lates.*

**STIM'ULUS**, *n.* [*L.* This word may be formed on the root of *stem*, a shoot.] 1. Literally, a goad; hence, something that excites or rouses the mind or spirits; as, the hope of gain is a powerful *stimulus* to labour and action.—2. In *med.*, that which produces a quickly diffused and transient increase of vital energy and strength of action in the circulating system.—3. In *bot.*, a sting. The nettle is furnished with *stimuli*.

**STING**, *v. t.* pret. *Stung*. *Stang* is obsolete. [Goth. *stjgvan*; Sax. *stingan*, *styngan*, to rush or thrust, hence to sting; G. *stechen*, to stick, to sting; *stachel*, a prick, goad, sting; Dan. *stikker*, to stick, to sting; *sting*, a thrust, a stitch, a sting. The Dutch

has *steng*, a pole or perch; Sw. *stang*, id.; and *stanga*, to push with the horns, to gore. We see that *sting* is *stich* altered in orthography and pronunciation.] 1. To pierce with the sharp pointed instrument with which certain animals are furnished, such as bees, wasps, scorpions, and thelike. Bees will seldom *sting* persons unless they are first provoked.—2. To pain acutely; as, the conscience is *stung* with remorse. Slander *stings* the brave. Pope.

**STING**, *n.* [Sax. *sting*, *stineg*; Ice. *stang*, a spear; W. *ystang*; D. *steng*, a pole or perch; Sw. *stang*; It. *stanga*, a bar. These words are all of one family.]

1. A sharp pointed weapon or instrument with which certain animals are armed by nature for their defence, and which they thrust from the hinder part of the body to pierce any animal that annoys or provokes them. In most instances, this instrument is a tube, through which a poisonous matter is discharged, which inflames the flesh, and in some instances proves fatal to life.—2. The thrust of a sting into the flesh. The *sting* of most insects produces acute pain.—3. Any thing that gives acute pain. Thus we speak of the *stings* of remorse; the *stings* of reproach.—4. The point in the last verse; as, the *sting* of an epigram.—5. That which gives the principal pain or constitutes the principal terror.

The *sting* of death is sin; 1 Cor. xv.

6. In *bot.*, stings are a sort of hair with which many plants are furnished, which secretes a poisonous fluid, which, when introduced under the skin of animals, produces inflammation. The stinging nettles are provided with this kind of armature, and also several species of the nat. order Malphigiaceae. In tropical climates the poisonous secretion of the glandular hairs of many plants is more powerfully developed than in other climates.

**STING'ER**, *n.* He or that which stings, vexes, or gives acute pain.

**STING'ILY**, *adv.* [from *stingy*.] With mean covetousness; in a niggardly manner.

**STING'INESS**, *n.* [from *stingy*.] Extreme avarice; mean covetousness; niggardliness.

**STING'INGLY**, *adv.* With stinging.

**STING'LESS**, *a.* [from *sting*.] Having no sting.

**STING'GO**, *n.* [from the sharpness of the taste.] Old beer. [A cant word.]

**STING'-RAY**, *n.* In *ich.*, the *Raia pastinaca*, a fish which inflicts wounds with the sharp-pointed bone or spine with which the tail is terminated.

**STING'Y**, *a.* [from *straitness*; W. *ystang*, something strait; *ystangu*, to straiten, to limit.] Extremely close and covetous; meanly avaricious; niggardly; narrow hearted; as, a *stingy* churl. [Colloq.]

**STINK**, *v. i.* pret. *Stunk*. *Stank* is obsolescent. [Sax. *stincan*; G. and D. *stinken*.] To emit a strong offensive smell, most frequently of putrefaction.

**STINK**, *n.* A strong offensive smell.

**STINK'ARD**, *n.* A mean paltry fellow.

—2. An ill-smelling burrowing quadruped, the *Mydaus meliceps* of Cuvier, about eighteen inches long, found in Java and Sumatra.

**STINK'ER**, *n.* Something intended to offend by the smell.

**STINK'HORN**, *n.* A species of fungus; stinking molor.

**STINK'ING**, *ppr.* Emitting a strong offensive smell.

**STINK'INGLY**, *adv.* With an offensive smell.

**STINK'POT** *n.* An artificial composition offensive to the smell.—2. An earthen jar, charged with powder, grenades, and other materials of an offensive nature. It is sometimes used by privateers to annoy an enemy whom they design to board.

**STINK'STONE**, *n.* Swinestone, a variety of compact lucullite; a subspecies of limestone. It gives out a fetid odour when heated or rubbed. The black marble of Kilkenny is an example.

**STINK'TRAP**, *n.* A contrivance to prevent the escape of effluvia from the openings of drains.

**STINT**, *v. t.* [Sax. *stintan*, to stint, or stint; Ice. *stunta*; Gr. *σννω*, narrow.]

1. To restrain within certain limits; to bound; to confine; to limit; as, to *stint* the body in growth; to *stint* the mind in knowledge; to *stint* a person in his meals.

Nature wisely *stints* our appetite. Dryden.

2. To assign a certain task in labour, which being performed, the person is excused from further labour for the day, or for a certain time.

**STINT**, *n.* Limit; bound; restraint.—2. Quantity assigned; proportion allotted. The workmen have their *stint*.

Our *stint* of woe

Is common.

Shak.

3. In *coal mines*, a measure of work two yards long by one broad, which each miner clears before he removes to another place.—4. In *ornithology*, the *Tringa cinclus*, Linn., a water-fowl of the plover kind. It is also called little sandpiper.

**STINT'ED**, *pp.* Restrained to a certain limit or quantity; limited.

**STINT'EDNESS**, *n.* State of being stunted.

**STINT'ER**, *n.* He or that which stints.

**STINT'ING**, *ppr.* Restraining within certain limits; assigning a certain quantity to; limiting.

**STIPA**, *n.* A genus of plants. [See FEATHER-GRASS.]

**STIPE**, *n.* [L. *stipes*; Gr. *στυπος*, a stake.]

In *bot.*, the stem of the monocotyledonous class of plants, such as the palms and yuccae, and of a few dicotyledonous plants, as the cyeas and zamia. When destitute of branches, as it generally is, it presents the appearance of a slender column, being a little thicker at the base than toward the top, frequently swelling out in the middle, and crowned by a tuft of leaves and flowers. Internally it has no appearance of concentric layers, and presents no distinction of wood and bark. It increases in height by the successive growths of the bud at the top, and in thickness by the addition of fibres to its interior. The setae of some mosses, as those of Sphagnum andreaceae, are also called *stipes*; also the stalks of the higher forms of fungi, as well as the part that supports the organs of reproduction in such lichens as Calicium, Coniocybe, and Baecomyces. The petioles of the leaves of ferns, as well as their stems,

are likewise termed *stipes*. The word is also used for the filament or slender stalk which supports the pappus, and connects it with the seed.

**STIPELS**, *n.* In *bot.*, small stipules situated at the base of the leaflets of a compound leaf.

**STIPEND**, *n.* [L. *stipendium*; *stips*, a piece of money, and *pendo*, to pay.] Originally, the pay of soldiers.—In *law*, settled pay or compensation for services, whether daily or monthly wages; or an annual salary.—In *Scotland*, a term applied to the provision made for the support of the parochial ministers of the established church. It consists of payments made in money or grain, or both, varying in amount according to the extent of the parish, and the state of the free teinds, or of any other fund specially set apart for the purpose. All stipends which come short of £150 per annum, are made up to that sum from government funds. By extension, the term is also applied to the annual payments made for the support of ministers of various other denominations besides the established church.

**STIPEND**, *v. t.* To pay by settled wages.

**STIPEND'IARY**, *a.* [L. *stipendiarius*.] Receiving wages or salary; performing services for a stated price or compensation.

His great *stipendiary* prelate came with troops of evil appointed horsemen not half full. Knolles.

**STIPEND'IARY**, *n.* [supra.] One who performs services for a settled compensation, either by the day, month, or year.

If thou art become

A tyrant's vile *stipendiary*. Glover.

**STIP'ITATE**, *a.* [See STRIPE.] In *bot.*, supported by a stipe; elevated on a stipe.

**STIP'PLE**, *v. t.* To engrave by means of dots, in distinction from engraving in lines.

**STIP'PLED**, *pp.* Depicted by means of dots.

**STIP'PLING**, *ppr.* Depicting by means of dots.

**STIP'PLING**, *n.* In *miniature painting* and *engraving*, a mode of producing the desired effect by means of dots. As applied to engraving, it is also called the dotted style, in contradistinction to engraving in lines. By this method the resemblance to chalk drawings is produced. It is performed with the graver, which is so managed as to produce the tints by small dots, rather than by lines, as in the ordinary method.

**STIP'TIC**, *n.* and *a.* See STYPTIC.

**STIP'ULA**, } *n.* [L. *stipula*, a straw  
STIP'ULE, } or stubble.] In *bot.*, a small leaf-like appendage to the leaf. Stipules are commonly situated at the base of the petiole in pairs, either adhering to it, or standing separate. They are usually of a more delicate texture than the leaf, but vary in this respect as well as in form and colour. In describing them, the terms used for the leaf are employed. They are generally considered as analogons to the leaves, or accessory to them, and are sometimes trans-



Leaf with Stipules, &c.

formed into leaflets. Stipules are not of constant occurrence, not being found in all plants, but where they occur, they frequently characterize a whole family; as in Leguminosæ, Rosaceæ, Malvaceæ, &c.

STIPULA'CEOUS, } *a.* [from *L. sti-*  
STIP'ULAR, } *pula, stipularis.*

See STIPULA. 1. Resembling stipules; consisting of stipules.—2. Growing on stipules, or close to them; as, *stipular glands*.—*Stipular buds*, such as are enveloped by the stipules; as in the tulip-tree.

STIP'ULATE, *v. i.* [*L. stipulor*, from *stipes*, or from the primary sense of the root, as in *stipo*; to crowd; whence the sense of agreement, binding, making fast.] 1. To make an agreement or covenant with any person or company to do or forbear anything; to contract; to settle terms; as, certain princes *stipulated* to assist each other in resisting the armies of France. Great Britain and the United States *stipulate* to oppose and restrain the African slave trade. A. has *stipulated* to build a bridge within a given time. B. has *stipulated* not to annoy or interdicit our trade.—2. To bargain. A. has *stipulated* to deliver me his horse for fifty guineas.

STIP'ULATE, *a.* [from *stipula*.] Having stipules on it; as, a *stipulate* stalk. STIP'ULATED, *pp.* Agreed; contracted; covenanted. It was *stipulated* that Great Britain should retain Gibraltar.

STIP'ULATING, *ppr.* Agreeing; contracting; bargaining.

STIPULA'TION, *n.* [*Fr.* from *L. stipulatio*.] 1. The act of agreeing and covenanting; a contracting or bargaining.—2. An agreement or covenant made by one person with another for the performance or forbearance of some act; a contract or bargain; as, the *stipulations* of the allied powers to furnish each his contingent of troops.—3. In *bot.*, the situation and structure of the stipules.

STIP'ULATOR, *n.* One who stipulates, contracts, or covenants.

STIP'ULE, *n.* See STIPULA.

STIP'ULED, *a.* Furnished with stipules or leafy appendages.

STIR, *v. t.* (*stur.*) [*Sax. stirian, styrian*; *D. stören*; *G. stören*, to stir, to disturb; *W. ystwrïaw*. This word gives *storm*; *Ice. stir, war.*] 1. To move; to change place in any manner.

My foot I had never yet in five days been able to stir. Temple.

2. To agitate; to bring into debate. *Stir* not questions of jurisdiction. Bacon.

3. To incite to action; to instigate; to prompt.

An Ate *stirring* him to blood and strife.

4. To excite; to raise; to put into motion.

And for her sake some mutiny will stir.

Dryden.

To stir up, to incite; to animate; to instigate by inflaming passions; as, to stir up a nation to rebellion.

The words of Judas were good, and able to stir them up to valour; 2 Macc.

2. To excite; to put into action; to begin; as, to stir up a mutiny or insurrection; to stir up strife.—3. To quicken; to enliven; to make more lively or vigorous; as, to stir up the mind.—4. To disturb; as, to stir up the sediment of liquor.

STIR, *v. i.* (*stur.*) To move one's self.

He is not able to stir.—2. To go or be carried in any manner. He is not able to stir from home, or to stir abroad.—3. To be in motion; not to be still. He is continually stirring.—4. To become the object of notice or conversation.

They fancy they have a right to talk freely upon every thing that stirs or appears. Watts.

5. To rise in the morning. [*Colloquial.*] STIR, *n.* [*W. ystwr.*] 1. Agitation; tumult; bustle; noise or various movements.

Why all these words, this clamour and this stir? Denham.

Consider, after so much stir about the genus and species, how few words have yet settled definitions. Locke.

2. Public disturbance or commotion; tumultuous disorder; seditious uproar.

Being advertised of some stir raised by his unnatural sons in England, he departed from Ireland without a blow. Davies.

3. Agitation of thoughts; conflicting passions.

STIR'ABOUT, *n.* A Yorkshire dish formed of oat-meal boiled in water to a certain consistency. [See PORRIDGE.]

STIRE, *n.* A kind of cider apple which grows in Herefordshire.

STIR'IATED, *a.* [*L. stiria, an icicle.*] Adorned with pendants like icicles.

STIR'IOUS, *a.* [*supra.*] Resembling icicles. [*Not much used.*]

STIRK, *n.* [*Sax. styr.*] A bullock or heifer between one and two years old. [*Scotch.*]

STIR'LESS, *a.* Still without stirring.

STIRP,† *n.* (*sturp.*) [*L. stirps.*] Stock; race; family.

STIR'ORAGE,† *n.* Motion; act of stirring.

STIR'RED, *pp.* Moved; agitated; put in action.

STIR'RER, *n.* One who is in motion.—2. One who puts in motion.—3. A riser in the morning.—4. An inciter or exciter; an instigator.—5. A stirrer up, an exciter; an instigator.

STIR'RING, *ppr.* Moving; agitating; putting in motion.—2. *a.* Active; active in business; habitually employed in some kind of business; accustomed to a busy life.

STIR'RING, *n.* [*supra.*] The act of moving or putting in motion.

STIRRUP, *n.* (*stur'up.*) [*Sax. stige-rapa, step-ropes; stigan, to step or ascend, and rap, rope; G. steig-bügel, step-bow or mounting-bow.* The first stirrups appear to have been ropes.] A kind of ring or bending piece of metal, horizontal on one side for receiving the foot of the rider, and attached to a strap which is fastened to the saddle; used to assist persons in mounting a horse, and to enable them to sit steadily in riding, as well as to relieve them by supporting a part of the weight of the body.—2. In ships, stirrups are short ropes having their upper ends plaited, and nailed round the yards, and eyes made in their lower ends, through which the horses are reeved, to keep them parallel to the yards. [See HORSE.] A piece of timber put under the keel of a ship, when some part of it is lost, is also denominated a stirrup.

STIR'RUP GLÄSS, or STIR'RUP 'CUP,† *n.* A glass of liquor presented to a rider, on having mounted his horse at parting.

STIR'RUP-IRON, *n.* An iron or steel

hoop which is suspended by a leather strap; a stirrup.

STIR'RUP-LEATHER, *n.* A strap that supports a stirrup.

STIR'RUP PIECE, *n.* A name given to a piece of wood or iron in framing, by which any part is suspended; a vertical or inclined tie.

STIR'RUP-STRAP, *n.* A stirrup-leather.

STITCH, *v. t.* [*G. stichen.* This is another form of *stich*.] 1. To sew; to sew in a particular manner; to join or unite by sewing; to sew slightly or loosely; as, to stitch a collar or a wrist-band; to stitch the leaves of a book and form a pamphlet.—2. In agriculture, to form land into ridges.—To stitch up, to mend or unite with a needle and thread; as, to stitch up a rent; to stitch up an artery.

STITCH, *v. i.* To practise stitching; to practise needle work.

STITCH, *n.* A single pass of a needle in sewing.—2. A single turn of the thread round a needle in knitting; a link of yarn; as, to let down a stitch; to take up a stitch.—3. In agriculture, a land; the space between two double furrows in ploughed ground; a furrow or ridge.—4. A local sharp pain; a sharp spasmodic pain in the intercostal muscles, like the piercing of a needle; as, a stitch in the side. [*Vulgar.*]

STITCH'ED, *pp.* Sewed; sewed slightly.

STITCH'EL, *n.* A kind of hairy wool. [*Local.*]

STITCH'ER, *n.* One that stitches.

STITCH'ERY, *n.* Needlework; *in contempt.*

STITCH'FALLEN,† *a.* Fallen, as a stitch in knitting.

STITCH'ING, *ppr.* Sewing in a particular manner; uniting with a needle and thread.

STITCH'ING, *n.* The act of stitching.—2. Work done by sewing in a particular manner.—3.† The forming of land into ridges or divisions.

STITCH'-WORT, *n.* The English name of the British species of plants belonging to the genus *Stellaria*. [See STELLARIA.]

STITH,† *n.* An anvil.

STITH, }† *a.* [*Sax.*] Strong; rigid.

STITH'E, }†

STITH'Y, *n.* [*Ice. stedia.*] 1. An anvil. [*Local.*].—2. A disease in oxen.

STITH'Y, *v. t.* To forge on an anvil. [*Local.*]

STITH'YING, *ppr.* Forging on an anvil.

STIVE,† *v. t.* [See STUFF and STEW.] To stuff up close.—2.† To make hot, sultry, and close.

STIVER, *n.* [*Sw. stifer*; *D. stuiver.*] A Dutch coin, value about a halfpenny.

STO'A, *n.* [*Gr.*] In *Grecian arch.*, a term corresponding with the Latin *porticus*, the Italian *portico*, and the English porch.

STOAK, *v. t.* To stop; to choke; *in seamen's language.*

STOAT, *n.* The ermine weasel, an animal of the genus *Mustela*, the *M. erminea*, Linn. This animal is called *stoat* when of a reddish colour, and *ermine* when white, as in winter. It is a digitigrade carnivorous mammal, found in great abundance in the northern parts of Asia and America, and occurring also in the temperate parts of Europe. Its habits are very similar to those of the common weasel of Europe. [See ERMINE, WEASEL.]

STO'CAH, *n.* [*Ir.* and *Erse.*] An at-

tendant; a wallet boy. [Not English nor used.]

**STOCCADE**, } *n.* [It. *stoccatto*, a  
**STOCCA'DO**, } thrust, from *stocco*, a  
 stock or race, a rapier or long sword;  
 Sp. *estocada*; Fr. *estocade*. This gives  
 the sense of thrust. But we give the  
 word another signification, from *stock*,  
 a post or fixed piece of timber. The  
 It. *stocco* and Eng. *stock* are the same  
 word.] 1. A stab; a thrust with a  
 rapier.—2. A fence or barrier made  
 with stakes or posts planted in the  
 earth; a slight fortification. [See  
 STOCKADE.]

**STOCCADE**, *v. t.* To fortify with  
 sharpened posts.

**STOCCADED**, *pp.* Fortified with  
 posts.

**STOCCADING**, *ppr.* Fortifying with  
 posts.

**STOCHASTIC**, } *a.* [Gr. *στοχαστικός*.]  
 Conjectural; able to conjecture.

**STOCK**, *n.* [Sax. *stoc*, a place, the stem  
 of a tree; G. *stock*, a stem, a staff, a  
*stick*, a block; Fr. *estoc*. This word  
 coincides with *stake*, *stick*, *stock*; that  
 which is set or fixed.] 1. The stem or  
 main body of a tree or other plant;  
 the fixed, strong, firm part; the origin  
 and support of the branches; Job xiv.  
 —2. The stem in which a graft is in-  
 serted, and which is its support. [See  
 STOCKS.]

The scion overruleth the stock quite.

Bacon.

3. A post; a log; something fixed, solid,  
 and senseless.

When all our fathers worshipping'd stocks and  
 stones. Milton.

4. A person very stupid, dull, and  
 senseless.

Let's be no stoics, nor no stocks. Shak.

5. The handle of anything.—6. The  
 wood in which the barrel of a musket  
 or other fire-arm is fixed.—7. † A  
 thrust with a rapier.—8. That part of  
 a soldier's dress which is worn round  
 the neck instead of a neckcloth. Ap-  
 plied also to a similar article of dress,  
 much worn by gentlemen in place of  
 a neckcloth.—9. † A cover for the leg.  
 [Now *stocking*.]—10. The original pro-  
 genitor; also, the race or line of a  
 family; the progenitors of a family  
 and their direct descendants; lineage;  
 family. From what *stock* did he  
 spring?

Thy mother was no goddess, nor thy *stock*  
 From Dardanus. Denham.

Men and brethren, children of the *stock*  
 of Abraham; Acts xiii.

11. A fund; capital; the money or  
 goods employed in trade, manufactur-  
 es, insurance, banking, &c.; as, the  
*stock* of a banking company; the *stock*  
 employed in the manufacture of cotton,  
 in making insurance and the like. Also  
 the goods on hand of a merchant or  
 trading company. *Stock* may be in-  
 dividual or joint.—12. Money lent to  
 government, or property in a public  
 debt; a share or shares of a national  
 or other public debt, or in a company  
 debt. British *stocks* are the objects of  
 perpetual speculation. [See *STOCKS*.]

—13. Supply provided; store. Every  
 one may be charitable out of his own  
*stock*. So we say, a *stock* of honour, a  
*stock* of fame.

Add to that *stock* which justly we bestow.  
 Dryden.

14. In *agriculture*, the domestic ani-  
 mals or beasts belonging to the owner  
 of a farm; as, a *stock* of cattle or of  
 sheep. These are called *live stock*. It

is also used for the implements and  
 other lifeless articles of property on a  
 farm, called *dead stock*.—15. In *carpen-  
 try* and *joinery*, a tool for boring  
 wood, with a crank. One end of it  
 rests against the breast of the work-  
 man, while with one hand he holds the  
 boring end steady, and with the other  
 turns the crank. It is provided with  
 a set of steel borers, called *bits*, of  
 various sizes, and the whole instru-  
 ment is commonly called a *stock and  
 bit*, *brace and bit*, or *centre-bit*.—16.  
 The *stock* of an anchor is the piece of  
 timber into which the shank is insert-  
 ed.—17. In *book-keeping*, the owner  
 or owners of the books.—To *take  
 stock*, in *mercantile lan.*, to take an in-  
 ventory of the goods which a merchant  
 has on hand, affixing a value to each  
 article. It also includes an account of  
 the money on hand. By comparing the  
 result of this operation with the  
 original stock, the quantity and value  
 of goods bought and sold, the debts  
 due by him, and those owing to him,  
 a merchant is enabled to ascertain the  
 state of his affairs, and to balance his  
 books.

**STOCK**, *n.* The English name for the  
 genus of plants named by Brown *Mat-  
 thiola*. Many of the species are great  
 favourites in gardens, on account of  
 their handsome flowers, and fragrant  
 smell. [See MATTHIOLA, STOCK-GILLY-  
 FLOWER.]

**STOCK**, *v. t.* To store; to supply; to  
 fill; as, to *stock* the mind with ideas.  
 Asia and Europe are well *stocked* with  
 inhabitants.—2. To lay up in store; as,  
 he *stocks* what he cannot use.—3. To  
 put in the stocks. [Little used.]—

4. To pack; to put into a pack; as, to  
*stock* cards.—5. To supply with do-  
 mestic animals, implements, &c.; as,  
 to *stock* a farm.—6. Among *American  
 farmers*, to supply with seed; as, to  
*stock* land with clover or herdsgrass.  
 —7. To suffer cows to retain their  
 milk for twenty-four hours or more,  
 previous to sale.—To *stock up*, to ex-  
 tirpate; to dig up.

**STOCKADE**, *n.* [See *STOCCADE*.] In  
*fort.*, a sharpened post or stake set  
 in the earth.—2. A line of posts or stakes  
 set in the earth as a fence or barrier.

**STOCKADE**, *v. t.* To surround or for-  
 tify with sharpened posts fixed in the  
 ground.

**STOCKADED**, *pp.* Fortified with  
 stockades.

**STOCKADING**, *ppr.* Fortifying with  
 sharpened posts or stakes.

**STOCK**-BROKER, *n.* [*stock* and  
*broker*.] A broker who deals in the  
 purchase and sale of stocks or shares  
 in the public funds. [See *STOCK-EX-  
 CHANGE*.]

**STOCK**-DOVE, *n.* [*stock* and *dove*.]  
 The wild pigeon of Europe, (*Columba  
 enas*), long considered as the *stock* of  
 the domestic pigeon, but now regarded  
 as a distinct species.

**STOCK**-EXCHANGE, *n.* The place  
 or building where the public stock is  
 bought and sold. The present stock  
 exchange is situated in Capel-court,  
 Bartholomew-lane, and was opened in  
 1802. Formerly, the place of rendez-  
 vous for persons transacting business  
 in the stocks, was Jonathan's coffee-  
 house, in 'Change Alley, Cornhill, and  
 it is from this circumstance that the  
 term *Alley* is familiarly used, as a cant  
 phrase, for the stock exchange, and  
 that a petty speculator in the funds is

styled a "dabbler in the Alley." The  
 term stock exchange is also applied to  
 the system by which the purchase,  
 sale, and "carrying over" of stock and  
 shares are effected by certain parties  
 called brokers. The members of the  
 stock exchange are divided into two  
 classes, namely, the stock brokers and  
 the stock jobbers. It is the business  
 of the brokers to receive and execute  
 the orders of merchants, bankers, ca-  
 pitalists, and private individuals, who  
 are "out of the house," as the stock  
 exchange is termed amongst its own  
 members. The jobbers remain sta-  
 tionary in the "house," and are ready  
 to act upon the orders thus received  
 by the brokers. They are men pos-  
 sessed of more or less capital, and it is  
 their business to be always prepared  
 to make a price at which they will sell  
 or buy to the brokers whenever the  
 latter present themselves. Thus, a  
 jobber declares he is ready to buy 3 per  
 cent. consols at 85½, or to sell at 85⅝;  
 so that, in this way, a person willing  
 to buy or sell any sum, however small,  
 has never any difficulty in finding an  
 individual with whom to deal. The  
 jobber's profit is generally ¼ per cent.  
 or 2s. 6d. for the £100, for which he  
 transacts both a sale and a purchase.  
 The proceedings of the stock exchange  
 are regulated by a committee, who are  
 elected by ballot.

**STOCK**' FARMER, *n.* A farmer who  
 devotes himself to the breeding and  
 rearing of different kinds of live stock,  
 especially horses and cattle.

**STOCK**'-FISH, *n.* [*stock* and *fish*.]  
 Cod dried hard and without salt.

**STOCK**-GILLYFLOWER, *n.* *Matthiola*,  
 a genus of plants. [See MATTHIOLA.]

There are several species,  
 natives of Europe and Barbary. Two  
 species, the common Gillyflower (*M.  
 incana*), and great sea stock (*M. sinu-  
 ata*), are indigenous to Britain. They  
 have been long favourite ornaments of  
 the flower garden, the double species  
 being esteemed for the beauty and  
 deep tints of the flower, and for its  
 delightful odour.

**STOCK**'HOLDER, *n.* [*stock* and *hold*.]  
 One who is a proprietor of stock in  
 the public funds, or in the funds of a  
 bank or other company.

**STOCK**ING, *n.* [from *stock*; Ir. *stoca*;  
 supposed by Johnson to be a corrup-  
 tion of *stochen*, plural of *stock*. But  
 qu.] A garment made to cover the  
 leg. Stockings were anciently made  
 of cloth or milled stuff, sewed together,  
 but they are now invariably knitted,  
 the material being wool, cotton, or  
 silk. They are either knitted by the  
 hand or woven in a frame, so as to  
 form a species of tissue extremely  
 elastic, and readily adapting itself to  
 the part it is employed to cover. The  
 art of knitting stockings appears to  
 have been introduced into England  
 from Spain, about the beginning of the  
 16th century.

**STOCK**ING, *n.* The act of furnishing  
 with stock, the act of storing up.—  
*Stocking of a pasture*, in *agriculture*,  
 the putting as many head of cattle  
 upon the pasture as it will maintain.

**STOCK**ING, *v. t.* To dress in stock-  
 ings.

**STOCK**INGER, *n.* A stocking-weaver.

[Local.]  
**STOCK**'ING-FRAME, *n.* A machine  
 for weaving or knitting stockings. It  
 is a somewhat complicated machine,

said to have been invented by William Lee, A.M., of St. John's College, Cambridge, in 1589. During the first century after the invention of the stocking-frame, few improvements were made upon it, and two men were usually employed to work one frame. But in the course of last century, the machine was very greatly improved.

**STOCKING-LOOM**, *n.* A stocking-frame.

**STOCK'ISH**, *a.* Hard; stupid; blockish. [Little used.]

**STOCK'-JOBBER**, *n.* [*stock and job.*] One who speculates in the public funds for gain; one whose occupation is to buy and sell stocks. [See **STOCK-EXCHANGE**.]

**STOCK'-JOBING**, *n.* The act or art of dealing in the public funds.

**STOCK'-LOCK**, *n.* [*stock and lock.*] A lock fitted into a wooden case. The larger and coarser sort of locks are generally of this kind.

**STOCK'-PURSE**, *n.* In *milit. lan.*, savings made in the outlay of a corps, and applied to regimental purposes.

**STOCKS**, *n.* [See **STOCK**.] A term applied to the various funds which constitute the national debt. These funds are variously designated, partly according to the rate of interest which the government engages to pay, and partly from the financial operations to which they have been subjected. Thus there are three per cent. stock, or three per cent. consols; three per cent. reduced; three and a half per cent. reduced; four per cent.; long annuities; life annuities, &c. The price of stocks or rates per cent. are the several sums for which £100 of the respective stocks sell at any given time; as each proprietor of stock may transfer his interest to others by sale. Few persons buy or sell stock except through the medium of a broker, but the general practice is to receive their dividends themselves. The dividends on all descriptions of stock are due half yearly, either on the 5th of January, or 5th of July, or on the 5th of April, or 5th of October, and are paid about a week afterwards. — *Time bargains* form a very important portion of the business of the stock exchange. They are bargains to deliver stock on a certain day at a certain price, the seller of course believing that the price will fall, and the buyer that it will rise. When the period for completing the bargain has arrived, a settlement is usually effected without any payment of stock, the losing party simply paying the difference. These bargains are usually made for certain days, fixed by a committee of the stock exchange, called *settling days*, of which there are about eight in the year. The price at which stock is sold to be transferred on the next settling day, is called the price on *account*. Sometimes instead of closing the account on the settling day, the stock is carried on to a future day, on such terms as the parties agree on. This is called a *continuation*, or *carrying over*. Time bargains cannot be enforced in a court of law, and the parties are held to them only by a sense of honour and self-interest, and the fear of exclusion from the stock exchange, which ruins their credit. A defaulter, in the language of the stock exchange, is termed a *lame duck*, and his name is posted for a certain time in the great room. The sellers of time

bargains are also technically called *bears*, and the buyers *bulls*; the interest of the former being to beat down prices, and of the latter to raise them. — *Bank stock*, the trading capital of the Bank of England, or that upon which interest is paid to the proprietors. It amounts to £10,914,250, and the interest is 8 per cent. — *East India stock*, the capital belonging to the East India company, which amounts to six millions, and the interest upon it is 10½ per cent. Besides these English funds, shares in many descriptions of foreign stocks, created by loans raised in this country, are constantly for sale in the money-market, as are also shares in railway, canal, mining, and numerous other similar speculations. — 2. In *horticulture*, young trees, which are designed for the reception of the grafts or buds from other trees. Stocks are, for practical purposes, divided into three kinds, *crab-stocks*, *free-stocks*, and *dwarf-stocks*. Crab-stocks are those which are grown from the seeds of wild and ungrafted trees; as the cherry, plum, apple, &c. Free-stocks are those which are raised from the seeds or layers of fruit and orchard trees which have been grafted. Dwarf-stocks are those which are raised from low-growing shrubby-trees, and are used in the grafting of low-standards, and also for wall-trees and espaliers. Stocks are raised in nurseries from seeds, suckers, layers, and cuttings, and may be used when they have attained the size of a goose quill, up to that of a man's finger. — 3. A frame erected on the shore of a river or of the sea, and in the large establishments, in the inside of docks, for the purpose of building ships. It generally consists of a number of solid wooden blocks, ranged parallel to each other at convenient distances, upon a very firm foundation, and with a gradual declivity towards the water, for the purpose of launching. — 4. A wooden machine, forming a kind of foot-pillory, in which the ankles of petty offenders

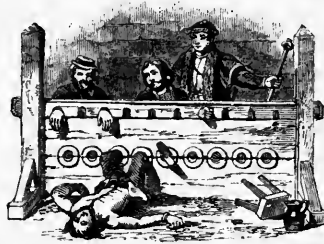

Punished in the Stocks.

are enclosed, for an hour or more, in a market or other public place. This punishment, once common in England, is now nearly out of use.

**STOCK'-SHAVE**, *n.* In *block-making*, a large sharp edged knife used to pare off the rough wood from the shells of blocks, &c.

**STOCK'-STILL**, *a.* [*stock and still.*] Still as a fixed post; perfectly still.

Our preachers stand *stock-still* in the pulpit. *Anon.*

**STOCK'-TACKLE**, *n.* In *ships*, a tackle composed of a double and single block, and employed to keep the stock of the anchor clear of the ship's side when fishing the anchor.

**STOCK'Y**, *a.* [from *stock*.] Thick and firm; stout. A *stocky* person is one rather thick than tall or corpulent; one whose bones are covered well with flesh, but without a prominent belly. [*Colloq.*] **STO'IC**, *n.* [Gr. *στωικός*, from *στος*, a porch in Athens, where the philosopher Zeno taught.] A disciple of the philosopher Zeno, who founded a sect. He taught that men should be free from passion, unmoved by joy or grief, and submit without complaint to the unavoidable necessity by which all things are governed. The Stoics are proverbially known for the sternness and austerity of their ethical doctrines, and for the influence which their tenets exercised over some of the noblest spirits of antiquity. Their system appears to have been an attempt to reconcile a theological pantheism, and a materialist psychology, with a logic which seeks the foundations of knowledge in sensible experience, and a morality which claims as its first principle the absolute freedom of the human will. "Live according to nature" is, with the stoics, the expression of the coincidence which ought to exist between the human will and the universal reason, which they identified with the life and power of nature. This coincidence is virtue, the only good; as vice, its opposite, is the only evil. All things else are in themselves indifferent; being approved or disapproved only by comparison. Virtue, according to them, is the perfect harmony of the soul with itself; vice is, in its essence, inconsistent and self-contradictory. The wise man, the ideal of human perfection, is absolutely and without qualification, free. His actions are determined by his free will, with a power as irresistible as that by which universal nature is guided and animated.

**STO'IC**, } *a.* Pertaining to the Stoics  
**STO'ICAL**, } or to their doctrines. —  
2. Not affected by passion; unfeeling; manifesting indifference to pleasure or pain.

**STO'ICALLY**, *adv.* In the manner of the Stoics; without apparent feeling or sensibility; with indifference to pleasure or pain.

**STO'ICALNESS**, *n.* The state of being stoical; indifference to pleasure or pain.

**STOICHIOMETRY**, *n.* [Gr. *στοιχίον*, element, and *μετρον*, measure.] A branch of chemistry that treats of the proportions which substances must have when they enter into a state of neutrality.

**STO'ICISM**, *n.* The opinions and maxims of the Stoics. — 2. A real or pretended indifference to pleasure or pain; insensibility.

**STO'ICITY**, } *n.* Stoicalness.

**STOIT**, or **STOITER**, *v. i.* [Sui-Goth. *stœta*.] To walk in a staggering way; to totter, to stumble on any object. [*Scotch.*]

**STOKE**, Sax. *stocce*, *stoc*, place, is the same word as *stock*, differently applied. It is found in many English names of towns.

**STOKE**, *v. t.* To poke, stir up, supply a fire with fuel, and attend to its combustion, applied chiefly to furnaces, such as the furnaces of steam-engines.

**STOKE-HOLE**, *n.* The space in front of a furnace.

**STOKER**, *n.* One who looks after a furnace fire. — 2. A poker. [*Local.*]

**STO'LA**, *n.* [L. from Gr. *στολή*.] A garment worn by the Roman women in later times. It was a long vest or



tunic with sleeves, reaching down to the ankles. It was worn within doors,



Roman matron attired in the Stola.

and was covered with the palla or cloak when they went out.

STOLE, *pret.* of Steal.

STOLE, *n.* [L. and It. *stola*; Sp. *estola*.] 1. A long vest or robe, which forms a part of the sacerdotal dress of Roman Catholic parish priests over their surplice, as a mark of superiority in their respective churches, and by other priests over the alb while celebrating mass. It is a long broad white band,

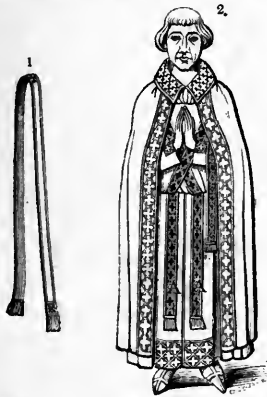

1. Stole. 2. Priest wearing the Stole, A. A.

of silk or silver stuff, lined with stiff linen, worn by deacons over the left shoulder, and reaching to the right hip; but the priests wear it over both shoulders, and hanging down across the breast. It is marked with three crosses, and not unfrequently has little bells at the end.—2. [L. *stolo*.] A sucker; a shoot from the root of a plant, by which some plants are propagated; written also *stool*—*Groom of the stole*, an officer in the king's household, the first lord of the bed-chamber. His title is derived from the long robe (*stola*) worn by the king on solemn occasions. His original duty was also to put the king's shirt on in the morning.

STOLED, *a.* Wearing a stole, or long robe; robed like an antique statue. [Seldom used but in poetry.]

STOLEN, *pp.* (*sto*'*ln.*) The passive participle of *Steal*.

Stolen waters are sweet; Prov. ix.

STOLID,† *a.* [L. *stolidus*; from the root of *still*, *stall*, to set.] Dull; foolish; stupid.

STOLIDITY, *n.* [supra.] Dulness of intellect; stupidity. [Little used.]

STOLON, *n.* [L. *stolo*.] In *bot.*, a runner or shoot proceeding horizontally, and taking root, as in some grasses and other plants, by which they increase.

STOLONIFEROUS, *a.* [L. *stolo*, a sucker, and *fero*, to produce.] Producing suckers; putting forth suckers; as, a *stoloniferous* stem, *stoloniferous* grasses.

STOMA, } *n.* [Gr.] In *bot.*, open-  
STOMATA, } ings in the epidermis of plants, usually bounded by two or more lunate or kidney-shaped vesicles. They are capable of being closed by the elongation or enlargement of these kidney-shaped vesicles. They are best seen in the monocotyledonous plants; but not without the aid of a microscope or convex lens. They are regarded as spiracles or breathing pores.

STOMACACE, *n.* [Gr. *stoma*, the mouth, and *akos*, evil, bad.] A factor in the mouth, with bloody discharge from the gums, which are ulcerated along their edges.

STOMACH, *n.* [L. *stomachus*; Fr. *estomac*.] 1. In *animal bodies*, a membranous receptacle, the principal organ of digestion, in which food is prepared for entering into the several parts of the body for its nourishment. The human stomach is of an irregularly conical form; it is situated in the epigastric region, lying almost transversely across the upper and left portion of the abdominal cavity. Its largest extremity is directed to the left, its smaller to the right. Its superior orifice, where the œsophagus terminates, is called the *cardia*; the inferior orifice, where the intestine begins, the *pylorus*. The stomach, like the intestinal canal, is composed of three coats or membranes, connected by a firm but very extensive cellular tissue. The external or *peritoneal* coat is a dense firm membrane; the internal or *villous* coat is soft, mucous, and vascular; the central coat is muscular, and the glands of the stomach are situated between it and the villous coat. The arteries of the stomach come chiefly from the *cœliac* artery, and are accompanied by veins which terminate in the *vena portæ*. The nerves of the stomach are very numerous, and come from the eighth pair and the sympathetic nerve. The lymphatic vessels are distributed throughout the whole substance, and proceed immediately to the thoracic duct. The use of the stomach is to excite hunger and partly thirst; to receive the food from the œsophagus, and to retain it, till by the motion of the stomach, the admixture of various fluids, and many other changes, it is rendered fit to pass the right orifice of the stomach, and be converted into chyle in the intestines.—2. Appetite; the desire of food caused by hunger; as, a good *stomach* for roast beef. [A popular use of the word.]—3. Inclination; liking.

He which hath no stomach to this fight,  
Let him depart. *Shak.*

4. Anger; violence of temper.

Stern was his look, and full of stomach vain. *Spenser.*

5. Sullenness; resentment; wilful obstinacy; stubbornness.

This sort of crying proceeding from pride, obstinacy, and *stomach*, the will, where the fault lies, must be bent. *Locke.*

6. Pride; haughtiness.

He was a man

Of an unbounded *stomach*, ever ranking  
Himself with princes. *Shak.*

Note. This word in all the foregoing senses, except the first, is nearly obsolete or inelegant.

STOMACH, *v. t.* [L. *stomachor*.] 1. To resent; to remember with anger.

The lion began to show his teeth, and to *stomach* the affront. *L'Estrange.*

2. To brook; to bear without open resentment or without opposition. [Not elegant.]

STOMACH,† *v. i.* To be angry.

STOMACHAL, *a.* [Fr. *stomacal*.] Cordial; helping the stomach.

STOMACHED, *a.* Filled with resentment.

STOMACHER, *n.* An ornament or support to the breast, worn by females; Isaiah iii.—2. The lower peak of a kind of female's gown.—3. One who stomachs.

STOMACHFUL, *a.* Wilfully obstinate; stubborn; perverse; as, a *stomachful* boy.

STOMACHFULLY, *adv.* In an angry manner.

STOMACHFULNESS, *n.* Stubbornness; sullenness; perverse obstinacy.

STOMACH'IC, } *a.* Pertaining to  
STOMACH'ICAL, } the stomach; as,  
*stomachic* vessels.—2. Strengthening to the stomach; exciting the action of the stomach.

STOMACH'IC, *n.* A medicine that strengthens the stomach and excites its action.

STOMACHING, *ppr.* Brooking; bearing without open resentment.

STOMACHING,† *n.* Resentment.

STOMACHLESS, *a.* Being without a stomach or appetite.

STOMACHOUS,† *a.* Stout; sullen; obstinate.

STOMACH PUMP, *n.* A small pump or syringe lately introduced into medical practice, for the purpose of withdrawing poisons from the stomach and introducing cleansing or other liquids. It resembles the common syringe, except that it has two apertures near the end, instead of one, in which the valves open different ways, so as to constitute a *sucking* and a *forcing* passage. When the object is to extract from the stomach, the pump is worked, while its sucking orifice is in connection with a flexible tube passed into the stomach; and the extracted matter escapes by the forcing orifice. When it is desired, on the contrary, to throw cleansing water or other liquid into the stomach, the tube is connected with the forcing orifice, by which the action of the pump is reversed.

STOMACH STAGGERS, *n.* A disease in horses, depending on a paralytic affection of the stomach. In this disease the animal dozes in the stable and rests his head in the manger; he then wakes up, and falls to eating, which he continues to do till the stomach swells to an enormous extent, and the animal at last dies of apoplexy, or his stomach bursts.

STOMACHY, *a.* Obstinate; sullen.

STOMAPODA, } *n.* [Gr. *stoma*, a  
STOMAPODA, } mouth, and *podos*, a foot.] An order of marine crustaceans,

having the shell divided into two portions, the anterior of which supports the eyes and intermediate antennae, or composes the head without giving origin to the foot-jaws. These organs, as well as the four anterior feet, are frequently approximated to the mouth on two lines that converge inferiorly, hence the name given to these animals. They are found chiefly in intertropical climates.

**STOMATA.** See **STOMA.**

**STOMP,** for **Stamp**,—which see.

**STOND,**† *n.* [for *stand*.] A stop; a post; a station. [See **STAND**.]

**STONE,** *n.* [Sax. *stan*; Goth. *staina*; G. *stein*; D. and Dan. *steen*.] This word may be a derivative from the root of *stand*. The primary sense is to set, to fix; Gr. *στανω*.] 1. A hard concretion of some species of earth, as lime, silex, clay, and the like; a hard compact body, of any form and size. In *nat. hist.*, stones, as distinguished from simple minerals, are defined to be essentially compound fossils; found in continued strata, or beds, of great extent, formed either of congeries of small particles, in some degree resembling sand, and lodged in a smoother cementitious matter, both of these running together into one smooth mass; or, finally, of granules cohering by contact, without any cementitious matter among them; or composed of crystal or spar, usually debased by earth, and often mixed with talc, and other extraneous particles. The principal component parts of stones are silex, alumina, zirconia, glucina, lime, and magnesia; sometimes the oxides of iron, manganese, nickel, chromium, and copper, are also found to enter into their composition. In popular language, very large masses of concretions are called *rocks*; and very small concretions are universally called gravel or sand, or grains of sand. Stones are of various degrees of hardness and weight; they are brittle and fusible, but not malleable, ductile, or soluble in water. Stones are of great and extensive use in the construction of buildings of all kinds, for walls, fences, piers, abutments, arches, monuments, sculpture, and the like. The qualities requisite for a building stone are hardness, tenacity, and compactness. When we speak of the substance generally, we use *stone* in the singular; as, a house or wall of *stone*. But when we speak of particular separate masses, we say, *a stone*, or *the stones*.—2. A gem; a precious stone. Inestimable *stones*, unvalu'd jewels. *Shak.*

3. Any thing made of stone; a mirror.—4. A calculous concretion in the kidneys or bladder; the disease arising from a calculus.—5. A testicle.—6. The nut of a drupe or stone fruit; or the hard covering inclosing the kernel, and itself inclosed by the pulpy pericarp.—7. A weight of 14 pounds avoirdupois, and equal to  $\frac{1}{4}$  of a hundred weight.—8. A monument erected to preserve the memory of the dead.

Should some relentless eye

Glance on the *stone* where our cold relics lie. *Pope.*

9. It is used to express torpidness and insensibility; as, a heart of *stone*.

I have not yet forgot myself to *stone*. *Pope.*

10. *Stone* is prefixed to some words to qualify their signification. Thus *stone-dead*, is perfectly dead, as lifeless as a stone; *stone-still*, still as a stone, per-

fectly still; *stone-blind*, blind as a stone, perfectly blind.—*To leave no stone unturned*, a proverbial expression which signifies to do every thing that can be done; to use all practicable means to effect an object.—*Meteoritic stones*, stones which fall from the atmosphere, as after the disposal of a meteor. [See **AEROLITE**.]—*Philosopher's stone*, a pretended substance that was formerly supposed to have the property of turning any other substance into gold.—*Artificial stone*, a species of stone prepared artificially for statuary and other decorations of architecture. The materials are nearly the same with those of English pottery. These stones are manufactured at Berlin.

**STONE,** *a.* Made of stone, or like stone; as, a *stone jug*.

**STONE,** *v. t.* [Sax. *stænan*.] 1. To pelt, beat or kill with stones.

And they *stoned* Stephen, calling upon God, and saying, Lord Jesus, receive my spirit; Acts vii.

2. To harden.

O perjur'd woman, thou dost *stone* my heart.

*Shak.*

3. To free from stones; as, to *stone* raisins.—4. To wall or face with stones; to line or fortify with stones; as, to *stone* a well; to *stone* a cellar.

**STONE-BLIND,** *a.* [*stone* and *blind*.] Blind as a stone; perfectly blind.

**STONE-BORER,** *n.* An animal that bores stones. The stone-borers or *Lithophagi* are molluscous bivalves, which by means of a fleshy foot, upon which they turn as upon a pivot, perforate or bore into rocks. [See **PHOLAS**.]

**STONE-BOW,** *n.* [*stone* and *bow*.] A cross bow for shooting stones.

**STONE-BRASH,** *n.* In agriculture, a subsoil composed of shattered rock or stone.

**STONE-BREAK,** *n.* [*stone* and *break*; L. *saxifraga*.] A plant, saxifrage.

**STONE-CHAT,** } *n.* [*stone* and  
**STONE-CHATTER,** } *chatter*.] A

bird of the family of warblers, the *Motacilla rubicola*, Linn., and the *Saxicola rubicola* of modern ornithologists. The stone-chats are common in Europe, and frequent moors and other open wastes. They run with much celerity, and their food consists of insects and worms, which they take chiefly upon the ground. In Scotland, the wheat ear, *Saxicola æwanthe*, is usually named stone-chat, or stone-chack.

**STONE-COAL,** *n.* Hard coal; anthracite.

**STONE-CRAY,** *n.* A distemper in hawks.

**STONE-CROP,** *n.* [Sax. *stan-crop*.] The common name of various British species of plants of the genus *Sedum*. [See **SEDUM**.]

**STONE-CUR LEW,** *n.* In *zool.*, a large species of the plover family, *Edicnemus creptians* of Temminck, which frequents stony places. It is also called *thick-kneed plover* or *bustard*; and, simply, *thick-knee*.

**STONE-CUTTER,** *n.* [*stone* and *cut*.] One whose occupation is to hew stones.

**STONE-CUTTING,** *n.* The business of hewing stones for walls, steps, cornices, monuments, &c.

**STONED,** *pp.* Pelted or killed with stones; freed from stones; walled with stones.

**STONE-DEAD,** *a.* [*stone* and *dead*.] As lifeless as a *stone*.

**STONE-EATER,** *n.* An animal that eats stones. Applied to certain bivalve molluscs, which form holes in rocks.

**STONE-FAL'CON,** *n.* A sort of hawk, which builds its nest in rocks.

**STONE-FERN,** *n.* [*stone* and *fern*.] A plant, the *Allosorus crispus*.

**STONE-FLY,** *n.* [*stone* and *fly*.] An insect, the May fly.

**STONE-FRUIT,** *n.* [*stone* and *fruit*.] Fruit whose seeds are covered with a hard shell enveloped in the pulp, as peaches, cherries, plums, &c.; a drupe.

**STONE-GALL,** *n.* The name given by workmen to a roundish mass of clay, often occurring in variegated sandstone. Stone-galls lessen the value of stones for building.

**STONE-HAWK,** *n.* [*stone* and *hawk*.] A kind of hawk which builds its nest in rocks; *Lithofalco*.

**STONE-HEARTED,** } *a.* [*stone* and  
**STONY-HEARTED,** } *heart*.] Hard

hearted; cruel; pitiless; unfeeling.

**STONEHENGE,** *n.* [Sax. *stan*, stone; and *heng* or *hang*, to hang or support.] A remarkable monument of antiquity, about six miles from Salisbury in England. It consists of two circles and two ovals, composed of huge stones, uprights and impost. The outer or largest circle is 105 feet in diameter, and between it and the interior smaller circle is a space of about 9 feet. Within this smaller circle, which is half the height (8 feet) of the exterior one, was a portion of an ellipse, formed by five groups of stones, which have been called *trilithons*, because formed by two vertical and one horizontal stone. Within this ellipse is another of single stones, half the height of the trilithons. The outer circle was



Stonehenge.

originally composed of thirty upright stones, at nearly equal distances apart; sustaining as many stones in a horizontal position, forming a continuous impost. The inner circle consisted of about the same number of upright stones of smaller size, and without impost. Within the inner elliptical enclosure was a block of stone, 16 feet long, 4 feet broad, and 20 inches thick. This has usually been called the altar stone. Round the larger circle, and at the distance of 100 feet, was a vallum 52 feet in width, and 15 in height. Nothing is known respecting the date of the erection of this wonderful monument of antiquity. It has been conjectured that the priests of the ancient Britons were priests of Baal, and hence that Stonehenge was a temple for the worship of Baal.

**STONE-HORSE,** *n.* [*stone* and *horse*.] A horse not castrated.

**STONE-HOUSE,** *n.* [*stone* and *house*.] A house built of stone.

**STONE-MASON, n.** One who shapes and places stones for buildings.  
**STONE-MORTAR, n.** A kind of mortar in which stones are laid.  
**STONE-PARSLEY, n.** A British plant of the genus *Sison*, the *S. amomum*, called also hedge stonewort. [See *Sison*.]  
**STONE-PINE, n.** A tree of the genus *Pinus*, the *P. pinea*, common in the south of Italy. [See *PINE*.]  
**STONE-PIT, n.** [stone and pit.] A pit or quarry where stones are dug.  
**STONE-PITCH, n.** [stone and pitch.] Hard inspissated pitch.  
**STONE-PLANT, n.** In *bot.*, the lithophyte,—which see.  
**STONE-PILOVER, } n.** [stone and plo-  
**STONE-CURLEW, } ver.]** A large species of plover, the *Ædicnemus crepitans* of Temminck. It appears in England at the latter end of April,

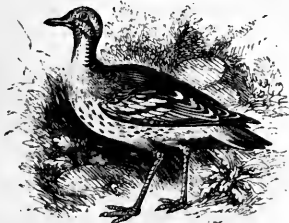
Stone Plover (*Ædicnemus crepitans*).

frequently open, hilly situations; makes no nest, but lays two eggs on the bare ground, and emigrates in small flocks about the end of September.

**STONE-POCK, n.** An acrid and hard pimple which suppurates.

**STONE-QUARRY, n.** A pit or excavation, out of which stones are dug.

**STONER, n.** One who beats or kills with stones; one who walls with stones.

**STONE'S-CAST, } n.** [stone and cast  
**STONE'S-THROW, } or throw.]** The distance which a stone may be thrown by the hand.

**STONE-SEED, n.** A perennial plant.

**STONE-SQUARER, n.** [stone and square.] One who forms stones into squares; 1 Kings v.

**STONE-STILL, a.** [stone and still.] Still as a stone; perfectly still or motionless.

**STONE-WALL, n.** [stone and wall.] A wall built of stones.

**STONE-WARE, n.** [stone and ware.] A species of potter's ware. It is a composition of clay and flint. The clay is beaten in water and purified, and the flint is calcined, ground, and suspended in water, and then mixed, (in various proportions for various wares,) with the former liquor. The mixture is then dried in a kiln, and being afterwards beaten to a proper temper, it becomes fit for being formed at the wheel into dishes, plates, bowls, &c. These are baked in a furnace, and glazed by common salt. The salt being thrown into the furnace, is instantly converted into a thick vapour, which attaches itself to the surface of the ware, and forms that vitreous coat upon the surface which is called its glaze.

**STONE-WEED, n.** A troublesome weed, of the genus *Lithospermum*, having spear-shaped flowers, with yellowish or milk-white corols.

**STONE-WORK, n.** [stone and work.] Work or wall consisting of stone; mason's work of stone.

**STONE-WORT, n.** The common name of two British plants of the genus *Sison*, *S. amomum*, hedge stone-wort, called also bastard stone-parsley; and *S. segetum*, stone-wort, called also corn-parsley. [See *Sison*.] The same name is also given to two British plants of the genus *chara*.

**STONINESS, n.** [from *stony*.] The quality of abounding with stones; as, the *stoniness* of ground renders it difficult to till.—2. Hardness of heart.

**STONING, ppr. or n.** Pelting with stones.—2. Walling with stone.

**STONY, a.** [D. *steenig*; G. *steinig*; Sw. *steneg*.] 1. Made of stone; as, a *stony* tower.—2. Consisting of stone; as, a *stony* cave.—3. Full of stones; abounding with stones; as, *stony* ground.—4. Petrifying; as, the *stony* dart of senseless cold.—5. Hard; cruel; unrelenting; pitiless; as, a *stony* heart.—6. Insensible; obdurate; perverse; morally hard.

**STONY-HEARTED, a.** Hard-hearted.

**STOOD, pret. of Stand.**

**STOOK, n.** [W. *ystoc*, a shock of grain.] A shock of corn, consisting of twelve sheaves. [Scotch.]

**STOOK, v. t.** To set up sheaves of grain in stooks. [Scotch.]

**STOOK'ING, n.** The operation of setting up sheaves of corn in stooks or shoocks. [Scotch.]

**STOOL, n.** [Sax. *stol*, Goth. *stols*, a seat, a throne; G. *stuhl*, a stool, a stock, a pew, a chair, the see of a bishop; W. *ystal*. This coincides with *stall* and *still*. A *stool* is that which is set, or a seat; Russ. *prestol*, a throne.] 1. A seat without a back; a little form consisting of a board with three or four legs, intended as a seat for one person.

2. The seat used in evacuating the contents of the bowels; hence, an evacuation; a discharge from the bowels.—3. [L. *stolo*.] The root of a timber tree which throws up shoots. Coppice wood consists chiefly of the shoots sent up by the roots of stools of trees or shrubs, which have been cut over by the surface of the ground. All dicotyledonous trees have the property of sending up shoots from the stumps or stools. Suckers or shoots from the root of a plant are also sometimes termed *stools*.—*Stool of repentance*, in Scotland, an elevated seat in the church, on which persons, in former times, were made to sit during divine service, as a punishment for fornication and adultery.—*Stools in ships*, are small channels fixed to the ship's sides, to contain the dead eyes for the backstays. Also, pieces of plank fastened to the ship's side, to receive the birthing of the gallery.

**STOOL'-BALL, n.** [stool and ball.] A play in which balls are driven from stool to stool.

**STOOM, v. t.** To put bags of herbs or other ingredients into wine, to prevent fermentation. [Local.]

**STOOP, v. i.** [Sax. *stupan*; D. *stuipein*.] 1. To bend the body downward and forward; as, to *stoop* to pick up a book.

2. To bend or lean forward; to incline forward in standing or walking. We often see men *stoop* in standing or walking, either from habit or from age.—3. To yield; to submit; to bend by compulsion; as, Carthage at length *stooped* to Rome.—4. To descend from

rank or dignity; to condescend. In modern days, attention to agriculture is not called *stooping* in men of property.

Where men of great wealth *stoop* to husbandry, it multiplieth riches exceedingly. *Bacon*.

5. To yield; to be inferior.

These are arts, my prince  
In which our Zana does not *stoop* to Rome. *Addison*.

6. To come down on prey, as a hawk. The bird of Jove *stoop'd* from his airy tour, Two birds of gayest plume before him drove. *Milton*.

7. To alight from the wing. And *stoop* with closing pinions from above. *Dryden*.

8. To sink to a lower place.

Cowering low  
With blandishments, each bird *stoop'd* on his wing. *Milton*.

**STOOP, v. t.** To cause to incline downward; to sink; as, to *stoop* a cask of liquor.—2. To cause to submit. [*Little used*.]

**STOOP, n.** The act of bending the body forward; inclination forward.—2. Descent from dignity or superiority; condescension.—3. Fall of a bird on its prey.

**STOOP, n.** [Sax. *stoppa*; D. *stopp*, a measure of about two quarts; Sw. *stop*, a measure of about three pints.] 1. A vessel of liquor; as, a *stoop* of wine or ale. [See *STROUP*.]—2. [*stooep*, Dutch.] A kind of verandah, encircling the lower story of a house, with benches to sit on. [*Peculiar to the state of New York*.]

**STOOPED, pp.** Caused to lean.

**STOOPER, n.** One that bends the body forward.

**STOOPING, ppr.** Bending the body forward; yielding; submitting; condescending; inclining.

**STOOPINGLY, adv.** With a bending of the body forward.

**STOOTER, n.** A small silver coin in Holland, value 2½ stivers.

**STOOTHINGS, n.** In *arch.*, a provincial term for battening.

**STOP, v. t.** [D. *stoppen*; G. *stopfen*, to stop, to check, to pose, to fill, to cram, to *stuff*, to quilt, to darn, to mend; Dan. *stopper*, to stop, to puzzle, to darn, to cram, to *stuff*; Sw. *stoppa*, to stop, to *stuff*; It. *stoppare*, to stop with tow; *stoppa*, tow, L. *stupa*; Sp. *estopa*, tow; *estofa*, quilted stuff; *estofar*, to quilt, to *stew* meat with wine, spice, or vinegar; Port. *estofa*, stuff; *estofar*, to quilt, to stuff; Fr. *étoupe*, tow; *etouper*, to stop with tow; *etouffer*, to choke, to *stifle*, (see *STIFLE*); L. *stupa*, tow; *stipo*, to stuff, to crowd, and *stupeo*, to be stupefied, whence *stupid*, *stupor*, (that is, to stop, or a stop;) Ir. *stopam*, to stop, to shut. The primary sense is either to cease to move, or to *stuff*, to press, to thrust in, to cram, probably the latter.]

1. To close; as an aperture, by filling or by obstructing; as, to *stop* a vent; to *stop* the ears; to *stop* wells of water; 2 Kings iii.—2. To obstruct; to render impassable; as, to *stop* a way, road, or passage.—3. To hinder; to impede; to arrest progress; as, to *stop* a passenger in the road; to *stop* the course of a stream.—4. To restrain; to hinder; to suspend; as, to *stop* the execution of a decree.—5. To repress; to suppress; to restrain; as, to *stop* the progress of vice.—6. To hinder; to check; as, to *stop* the approaches of old age or in-

firmity.—7. To hinder from action or practice.

Whose disposition, all the world well knows. Will not be rubb'd nor stopp'd. *Shak.*

8. To put an end to any motion or action; to intercept; as, to *stop* the breath; to *stop* proceedings.—9. To regulate the sounds of musical strings, with the finger or otherwise; as, to *stop* a string.—10. In *seamanship*, to make fast.—11. † To point; as a written composition.

STOP, v. i. To cease to go forward.

Some strange commotion

Is in his brain; he bites his lip, and starts; Stops on a sudden, looks upon the ground—*Shak.*

2. To cease from any motion or course of action. When you are accustomed to a course of vice, it is very difficult to *stop*.

The best time to *stop* is at the beginning. *Lesley.*

STOP, n. Cessation of progressive motion; as, to make a *stop*.—2. Hindrance of progress; obstruction; act of stopping.

Ocult qualities put a *stop* to the improvement of natural philosophy. *Newton.*

3. Repression; hindrance of operation or action.

It is a great step toward the mastery of our desires, to give this *stop* to them. *Locke.*

4. Interruption.

These *stops* of thine fright me the more. *Shak.*

5. Prohibition of sale; as, the *stop* of wine and salt.—6. That which obstructs; obstacle; impediment.

A fatal *stop* travers'd their headlong course. *Daniel.*

So melancholy a prospect should inspire us with zeal to oppose some *stop* to the rising torrent. *Rogers.*

7. The instrument by which the sounds of wind music are regulated; as, the *stops* of a flute or an organ. The *stops* of an organ are a collection of pipes similar in tone and quality, which run through the whole or a great part of the compass of the instrument. In great organs, the *stops* are numerous and multifarious; but the principal ones are the two *diapasons*, the *principal*, the *twelfth*, the *fifteenth*, the *sesquialtera*, the *mixture* or *furniture*, the *trumpet*, the *clarion*, and the *cornet*. The choir-organ usually contains the *stopt diapason*, the *dulciana*, the *principal*, the *flute*, the *twelfth*, the *bassoon*, and the *vox humana*. The *stops* of an organ are so arranged, that by means of registers the air proceeding from the bellows may be admitted to supply each stop or series of pipes, or excluded from it at pleasure; and a valve is opened when the proper key is touched, which causes all the pipes belonging to the note, in those series of which the registers are open, to sound at once. Several of the *stops* are designed to produce imitations of different musical instruments, as the *trumpet*, *clarion*, *cornet* and *flute stops*.—8. Regulation of musical chords by the fingers.

In the *stops* of lutes, the higher they go, the less distance is between the frets. *Bacon.*

9. The act of applying the *stops* in music.

Th' organ-sound a time survives the *stop*. *Daniel.*

10. A point or mark in writing, intended

ed to distinguish the sentences, parts of a sentence or clauses, and to show the proper pauses in reading. The *stops* generally used are the comma, semi-colon, colon, and period. To these may be added the marks of interrogation and exclamation.

STOP'-COCK, n. [*stop* and *cock*.] A turning cock used in plumbery to turn off or regulate the supply of water, gas, &c., which flows through pipes.

STOP'-GAP, † n. [*stop* and *gap*.] A temporary expedient.

STOP'LESS, † a. Not to be stopped.

STOP'PAGE, n. The act of stopping or arresting progress or motion; or the state of being stopped; as, the *stoppage* of the circulation of the blood; the *stoppage* of commerce.—*Stoppage in transitu*, in law, the term applied to the right which a seller of goods has to stop them in their *transit* or passage to the buyer, in case of his bankruptcy or insolvency. When a seller of goods has committed them to some middleman, as a carrier, shipmaster, &c., to be conveyed to the buyer, and if the buyer should become insolvent or unable to pay the price, while the goods are in the hands of the middleman, the seller may remand them, and retain them in security. The doctrine of *stoppage in transitu* is the same, in its practical operation, in the laws of England and Scotland.

STOPPED, pp. Closed; obstructed; hindered from proceeding; impeded; intercepted.

STOPPER, n. One who stops, closes, shuts, or hinders; that which stops or obstructs; that which closes or fills a vent or hole in a vessel.—2. In *seamen's lan.*, a short piece of rope used for making something fast, as the anchor or cables. Stoppers are also used to prevent the running rigging from coming up, whilst the men are belaying it.

STOP'PER, v. t. To close with a stopper.—To *stopper the cable*, among *seamen*, is to put stoppers on it to prevent it from running out of the ship when riding at anchor.

STOP'PER BOLTS, n. In *ship-building*, large ring-bolts which are driven into the deck before the main hatch, &c., for the use of the stoppers.

STOP'PERED, pp. Closed with a stopper; as, a *stoppered* retort.

STOP'PERING, ppr. Closing with a stopper.

STOP'PING, ppr. Closing; shutting; obstructing; hindering from proceeding; ceasing to go or move; putting an end to; regulating the sounds of.—2. Amongst *workmen generally*, the filling up of holes and cracks in their work.

STOP'-PLANKS, n. A certain description of dam employed on canals and other hydraulic works. In order to prevent the loss of water on canals, &c., it is usual to contract the waterway at certain points, and carry up wing-walls from below, making vertical grooves in the face of the masonry upon each side, corresponding with each other, for the insertion of hatches or *stop-planks*. Provision is made for *stop-planks* in most hydraulic works; for instance, grooves are made at each end of a lock, on the outside of the chamber, in order that the water may be kept out during any repairs.

STOP'PLE, n. [*Sw. stopp*.] That which stops or closes the mouth of a vessel; as, a glass *stopple*; a cork *stopple*.

STOPS, n. In *joinery*, pieces of wood nailed on the frame of a door to form the recess or rebate into which the door shuts.

STORAGE, n. [*from store*.] The act of depositing in a store or warehouse for safe keeping; or the safe keeping of goods in a warehouse.—2. The price charged or paid for keeping goods in a store.

STORAX, n. [*L. styrax*.] A resinous and odoriferous balsam. It is obtained by incisions made in the branches of the *Styrax officinalis*, a small tree which grows in the Levant, and also known by the name of *Storax*. The best is imported in red tears, but the common sort in large cakes. This last is the most fragrant, though very impure. Storax has an agreeable, slightly pungent, and aromatic taste; it is stimulant, and in some degree expectorant. Formerly it was much employed in medicine, but it is now little used, except in perfumes. [*See STYRAX*.]—



Storax (*Styrax officinalis*).

*Liquid storax* is obtained from the *Liquid amber*, *Styraciflua*, a tree which grows in Virginia. It is greenish, of an agreeable taste, and aromatic smell.—*Benjamin storax* is obtained from the *Styrax benzoin*, a native of Sumatra and Java.

STORE, n. [*W. ystor*, that forms a bulk, a store; *Sax. stor*; *Dan. stor*; *Sw. id.* great, ample, spacious, main; *Ir. stor, storas*; *Heb. Ch. Eth. and Ar. ܣܬܪܐ, atsar.*] 1. † A large number; as, a *store* of years.—2. † A large quantity; great plenty; abundance; as, a *store* of wheat or provisions.—3. A stock provided; a large quantity for supply; ample abundance. The troops have great *stores* of provisions and ammunition. The ships have *stores* for a long voyage. [This is the present usual acceptance of the word, and in this sense the plural, *stores*, is commonly used. When applied to a single article of supply, it is still sometimes used in the singular; as, a good *store* of wine or bread.]—4. Quantity accumulated; fund; abundance; as, *stores* of knowledge.—5. A storehouse; a magazine; a warehouse.—6. In the *United States*, shops for the sale of goods of any kind, by wholesale or retail, are often called *stores*.—In *store*, in a state of accumulation, in a *literal sense*; hence, in a state of preparation for supply; in a state of readiness. Happiness is laid up in *store* for the righteous; misery is in *store* for the wicked. STORE, a. Hoarded; laid up; as, *store* treasure, *store* fruit, &c.

## STORK

STORE, *v. t.* To furnish; to supply; to replenish.

Wise Plato said the world with men was  
*stor'd.* Denham.

Her mind with thousand virtues stor'd.

Prior.

2. To stock against a future time; as, a garrison well stor'd with provisions.

One having stor'd a pond of four acres with carp, tench, and other fish. Hale.

3. To reposit in a store or warehouse for preservation; to warehouse; as, to store goods.

STORED, *pp.* Furnished; supplied.—  
2. Laid up in store; warehoused.

STORE-FARMER, *n.* In agriculture, a farmer who devotes himself chiefly to the breeding of sheep and cattle.

STORE-HOUSE, *n.* [store and house.] A building for keeping grain or goods of any kind; a magazine; a repository; a warehouse.

Joseph opened all the store-houses and sold to the Egyptians; Gen. xli.

2. A repository.

The Scripture of God is a store-house abounding with inestimable treasures of wisdom and knowledge. Hooker.

3. † A great mass repositied.

STORE-KEEPER, *n.* [store and keeper.] One who has the care of a store.

STORER, *n.* One who lays up or forms a store.

STORE-ROOM, *n.* A room set apart in a large country-house, for articles of domestic use, especially edibles; as, dried fruits, groceries, &c.—2. In ships, an apartment or place of reserve, of which there are usually several in the same ship, to contain provisions or stores.

STORES, *n. plur.* Necessary articles accumulated or laid up for use; as, military, commissariat, and naval stores. These comprehend arms, ammunition, provisions, clothing, and every article of equipment.—2. In commercial navigation, the supplies of different articles provided for the use of the crew and passengers of a vessel.

STORE-SHIP, *n.* A vessel employed to carry artillery or naval stores for the use of a fleet, fortress, or garrison.

STORGE, *n.* (storj or stor'je.) [Gr.] Maternal affection; tender love; that strong instinctive affection which animals have for their young.

STORIAL, † *a.* [from story.] Historical.

STORIED, *a.* [from story.] Furnished with stories; adorned with historical paintings.

Some greedy minion or imperious wife,

The trophied arches, storied halls, invade.

Pope.

2. Related or referred to in story; told or recited in history.

STORIED, *pp.* Told in historical relation; narrated; inscribed with stories; as, a storied wall, a storied window, a storied urn.

STORIER, † *n.* A relater of stories; an historian.

STORIFY, † *v. t.* To form or tell stories.

STORING, *ppr.* Laying up in a store or warehouse.

STORK, *n.* [Sax. *storc*; Dan. and Sw. *stork*.] *Ciconia*, a genus of culirotstral birds belonging to the heron tribe. They are tall and stately birds, and easily distinguished from the herons by their small mouth, the beak being moderately cleft, and destitute of the nasal furrow. Most of them inhabit Europe. Their food consists of fish, reptiles, small quadrupeds, worms, and

## STORM

insects. The common stork (*C. alba*) is found throughout the greater part of Europe, but passes the winter in Africa. It is remarkable for its great



White Stork (*Ciconia alba*).

affection towards its young; and, according to popular belief, for its attention towards its parents in old age. The black stork (*C. nigra*) occurs in Poland and Prussia, and in the sequestered parts of the Alps. The American stork is the *C. magnari*; and the gigantic stork, or adjutant of Bengal, is the *C. argala*.—In her., the stork, as an emblem of piety and gratitude, is a frequent bearing in coat armour.

STORK'S-BILL, *n.* The common name of three British plants of the genus *Erodium*. Musky stork's bill (*E. moschatum*) exhales a musky odour. It grows in hilly pastures.

STORM, *n.* [Sax. *storm*; D. Dan. and Sw. *storm*; G. *sturm*; W. *ystorm*; D. *stooren*, to disturb; W. *ysturtiaw*, Eng. to stir. In Italian, *stormo* is a fight, combat, a band, or troop; *stormire*, to make a noise; *stormeggiare*, to throng together, to ring the alarm bell. The Italian seems to be from *L. turma*. The primary sense of storm is a rushing, raging, or violent agitation.] 1. A violent wind; a tempest; a violent commotion of the atmosphere. Thus a storm of wind is correct language, as the proper sense of the word is rushing, violence. It has primarily no reference to a fall of rain or snow. But as a violent wind is often attended with rain or snow, the word storm has come to be used, most improperly, for a fall of rain or snow without wind.

O beat those storms and roll the seas in vain. Pope.

Law of storms. The causes of those violent commotions of the atmosphere to which we give the name of storms, tempests, hurricanes, tornados, &c., have particularly engaged the attention of natural philosophers for several years past; but their causes are involved in great obscurity, chiefly owing to the difficulty of obtaining a precise knowledge of the various circumstances with which storms are accompanied. It is in the torrid zone that storms display the greatest violence, and rage with most destructive fury. In temperate regions they are comparatively rare, and in the polar regions they seldom amount to more than a strong wind. From the observations of Mr. Redfield of New York, the following general phenomena respecting storms which occur in the northern hemisphere, appear to be established:—1. The severest hurricanes originate in

## STORM

tropical latitudes to the north or east of the West India Islands. 2. They cover simultaneously an extent of surface from 100 to 150 miles in diameter, acting with diminished violence towards the exterior, and increased energy towards the interior of that space. 3. The tract over which the hurricane passes is not a straight line. South of the parallel of 30° north latitude, it proceeds in a westerly course inclined to the north; but when it comes to about this parallel, it changes rather abruptly to the north and eastward, and continues to incline gradually more to the east. The average progressive velocity appears to be from 15 to 25 miles per hour. 4. The duration of a storm at any particular place depends of course on the extent of the mass of agitated air and the progressive velocity, and storms of smaller extent move with even greater rapidity than large ones. 5. The direction of the wind in a hurricane is not in the direction of its progress. When the progressive motion of the storm is westward, the wind at the commencement is from a northern quarter, and during the latter part of the gale, from a southern quarter of the horizon. When the progressive motion is eastward, the phenomena are reversed; the wind blows at first from a southern quarter, and towards the end of the gale from a northern quarter of the horizon. From these phenomena, and particularly the last, Mr. Redfield concludes that the great body of the storm whirls in a horizontal circuit round a vertical or somewhat inclined axis of rotation, which is carried forward with the storm; and that to a spectator placed at the centre, the direction of the rotation is invariably from right to left. Colonel Reid, of the engineers, has investigated the subject of storms with great care and minuteness, and the results of his investigations he considers as in all respects confirming the conclusions of Mr. Redfield. He has also given an account of several great hurricanes in the southern hemisphere, from which it appears that the southern storms follow exactly the same law as the northern, but in a reversed order. Colonel Reid conjectures that the force and frequency of storms may have some connection with the law of magnetic intensity. A knowledge of the general laws which regulate the phenomena of storms would be of immense importance, inasmuch as it would enable the navigator to avoid those tracts of the ocean in which they chiefly prevail at particular seasons, or at least, if surprised by a storm, to steer on the course by which he may soonest escape from it, or fall into its wake. [See WHIRLWIND, WIND.]—2. A violent assault on a fortified place; a furious attempt of troops to enter and take a fortified place by scaling the walls, forcing the gates, and the like.—3. Violent civil or political commotion; sedition; insurrection; also, clamour; tumult; disturbance of the public peace.

I will stir up in England some black storms. Shak.

Her sister

Began to scold and raise up such a storm. Shak.

4. Affliction; calamity; distress; adversity.

A brave man struggling in the storms of fate. Pope.

5. Violence; vehemence; tumultuous force.

**STORM**, *v. t.* To assault; to attack and attempt to take by scaling the walls, forcing gates or breaches, and the like; as, to *storm* a fortified town.

**STORM**, *v. i.* To raise a tempest.—2. To blow with violence; *impersonally*; as, it *storms*.—3. To rage; to be in a violent agitation or passion; to fume. The master *storms*.

**STORM' PETREL**, } See **PETREL**.  
**STORM'Y PETREL**, }

**STORM-BEAT**, *a.* [*storm* and *beat*.] Beaten or impaired by storms.

**STORM-BIRD**, } *n.* A sea-fowl; the  
**STORM-FINCH**, } petrel.

**STORM'-COCK**, *n.* A bird; the missel thrush.

**STORM'ED**, *pp.* Assaulted by violence.

**STORM'FUL**, *a.* Abounding with storms.

**STORM'FULNESS**, *n.* Abundance of storms.

**STORM'INESS**, *n.* Tempestuousness; the state of being agitated by violent winds.

**STORMING**, *ppr.* Attacking with violent force; raging.

**STORM'LESS**, *n.* Free from storms.

**STORM'-MENACING**, *a.* Threatening a storm.

**STORM'-PRESAGING**, *a.* Presaging a storm.

**STORM'-PROOF**, *a.* Proof against storms or bad weather.

**STORM'-TOSSED**, *a.* Tossed by storms or high winds.

**STORM'-VEXED**, *a.* Harassed with storms.

**STORM'Y**, *a.* Tempestuous; agitated with furious winds; boisterous; as, a *stormy* season; a *stormy* day or week.—2. Proceeding from violent agitation or fury; as, a *stormy* sound; *stormy* shocks.—3. Violent; passionate. [*Un-usual*.]

**STOR' THING**, *n.* [Dan. *stor*, great, and *ting*, court.] The parliamentary legislature of Norway, created in 1814. It is composed of about 100 deputies, from all classes of the Norwegians, who assemble every third year on the first week-day of February, and the sittings usually continue till all public business is finished, but the king may prorogue at the end of three months. A kind of head committee, called the *lagthing*, sits in a chamber apart; and the two form the supreme legislature.

**STORY**, *n.* [Sax. *stær*, *ster*; L. *historia*; Gr. *ἱστορία*.] 1. A verbal narration or recital of a series of facts or incidents. We observe in children a strong passion for hearing *stories*.—2. A written narrative of a series of facts or events. There is probably on record no *story* more interesting than that of Joseph in Genesis.—3. History; a written narrative or account of past transactions, whether relating to nations or individuals.

The four great monarchies make the subject of ancient *story*. Temple.

4. Petty tale; relation of a single incident or of trifling incidents.—5. A trifling tale; a fiction; a fable; as, the *story* of a fairy. In popular usage, *story* is sometimes a softer term for a lie.—6. A loft; a stage or floor of a building, called in Scotland a *flat*; a subdivision of the height of a house; or a set of rooms on the same floor or level. A *story* comprehends the distance from one floor to another; as, a *story* of nine, ten, twelve, or sixteen

feet elevation. Hence each floor terminating the space is called a *story*; as a house of one *story*, of two *stories*, of five *stories*. The houses in Paris have usually five *stories*, a few have more; those in London three or four. In the United States, the floor next the ground is the first *story*; in France and England, the first floor or *story* is the second from the ground.

**STORY**, *v. t.* To tell in historical relation; to narrate.

How worthy he is, I will leave to appear hereafter, rather than *story* him in his own hearing. Shak.

It is *storied* of the brazen colossus in Rhodes, that it was seventy cubits high. Wilkins.

[*This verb is chiefly used in the passive participle*.]—2. To arrange under one another; to arrange in *stories*; to build in *stories*. [*Little used*.]

**STORY-BOOK**, *n.* A collection of short tales.

**STORYING**, *ppr.* Telling in historical relation.

**STORY-POSTS**, *n.* In *arch.*, upright posts to support a floor or superincumbent wall, through the medium of a beam placed over them. They are chiefly used in sheds, workshops, and wooden houses.

**STORY-ROD**, *n.* In *arch.*, a rod used in setting up a staircase, equal in length to the height of a *story* of a house, and divided into as many parts as there are intended to be steps in the stair, so that the steps may be measured, and distributed with accuracy.

**STORY-TELLER**, *n.* [*story* and *tell*.] One who tells *stories*; a narrator of a series of incidents; as, an amusing *story-teller*.—2. An historian; *in contempt*.—3. One who tells fictitious *stories*.

**STORY-TELLING**, *n.* The act of relating short histories, true or fictitious.

**STOT**, *n.* [Sax. *stotte*, a poor horse.] 1.† A horse.—2. A young bullock or steer. [*Local*.]

**STOTE**. See **STOAT**.

**STOUND**, *v. i.* [Ice. *stunde*.] 1.† To be in pain or sorrow.—2.† Stunned. [*See ASTOUND*.]

**STOUND**, *† n.* Sorrow; grief.—2.† A shooting pain.—3.† Noise.—4.† Astonishment; amazement.—5.† Hour; time; season. [Dan. *stund*.]—6. A vessel to put small beer in. [*Local*.]

**STOUP**, *n.* [Sax. *stoppa*. See **STROOF**.] A basin for holy water, usually placed in a niche at the entrance of Roman

holding liquids; a flagon. Also, a vessel used as a measure; as, a *pirit stoup*; a *mutchkin stoup*; a *gill stoup*.

**STOUR**, *† n.* [Sax. *styrian*, to stir.] A battle or tumult.—In *Scotch*, it also signifies dust in a state of motion; trouble; vexation.

**STOUT**, *a.* [D. *stout*, bold, stout, *stoeten*, to push; Dan. *stöder*, to push; *studsær*, to strut. The primary sense is to shoot forward or to swell.] 1. Strong; lusty; firm set; compact and round of frame and limb.

A *stouter* champion never handled sword. Shak.

2. Bold; intrepid; valiant; brave. He lost the character of a bold, *stout*, magnanimous man. Clarendon.

3. Large; bulky. [A popular use of the word.]—4. Proud; resolute; obstinate.

The lords all stand to clear their cause, Most resolutely *stout*. Daniel.

5. Strong; firm; as, a *stout* vessel.

**STOUT**, *n.* A cant name for strong beer.

**STOUT'-BUILT**, } *a.* Having a stout  
**STOUT'-MADE**, } frame.

**STOUT'-HEARTED**, *a.* Having a stout heart.

**STOUTH'RIEF**, *n.* [Scotch, *stouth*, theft or stealth, and *rief*, the carrying off by force.] In *Scots law*, theft accompanied with violence; robbery. The term is usually applied in cases in which robbery is committed within a dwelling house.

**STOUT'LY**, *adv.* Lustily; boldly; obstinately. He *stoutly* defended himself.

**STOUT'NESS**, *n.* Strength; bulk.—2. Boldness; fortitude.—3. Obstinacy; stubbornness.

**STOVE**, *n.* [Sax. *stofa*; Sp. *estufa*, a warm close room, a bath, a room where pitch and tar are heated; *estofar*, to stew meat, and to quilt; Fr. *étuve*; G. *badstube*, a bagnio or hot-house; *stube*, a room; *stuben-öfen*, a stove; Dan. *stover*, to stew; *stue*, a room; *stue-ovn*, a stove. This primarily is merely a room, a place. See **STOW**.] 1. A hot-house; a house or room artificially warmed.—2. A small box with an iron pan, used for holding coals to warm the feet. It is a bad practice for young persons to accustom themselves to sit with a warm *stove* under the feet.—3. A receptacle more or less close for the combustion of fuel for the purpose of heating apartments, &c. When it allows the burning coals to be seen, it is called a *stove-grate*; hence *register-stoves*, *bath-stoves*, &c. But the term *stove* is usually restricted to those contrivances for heating apartments in which the fire is enclosed so as to exclude it from sight, the heat being given out through the material of which the stove is composed, and the smoke conveyed away by means of a pipe leading from the stove. Stoves are of various constructions, and numerous patents have been taken out for inventions and improvements upon them. In the German stoves, the heated air before it finally enters the chimney is made to circulate through various chambers constructed over the fire box, to which it communicates much of its excess of heat, and those again impart it to the surrounding air. Sometimes buildings are warmed by sending up currents of hot air from stoves placed in the basement story.—4. An iron box with various apartments in it for cooking; a culinary utensil of



Stoup, Maidstone Church, Kent.

Catholic churches. In the *Scottish dialect*, a deep and narrow vessel for

various forms.—5. In *horticulture*, a structure in which plants are cultivated which require a considerably higher temperature than the open air in Britain and similar climates. The principal stoves of this kind are the dry stove and damp stove. The dry stove is a structure the atmosphere of which is heated to the temperature of from 55° to 60° during winter. It is employed chiefly for the cultivation of succulent plants. The damp stove, sometimes called the *bark-stove* and *bark-bed*, is used for the cultivation of tropical plants. [See BARK-BED.] Both stoves are heated by smoke-flues, or by hot water, or steam circulated in metallic or other tubes. The plants cultivated in this manner are often called *stove-plants*.

STOVE, *v. t.* To keep warm in a house or room by artificial heat; as, to *stove* orange trees and myrtles. In *Scotland*, to *stove* signifies to *stew*.

STOVE, *pret.* of *Stave*.

STÖVER, *n.* [a contraction of *estover*.] Fodder for cattle; primarily, fodder from threshed grain.

STOVING, *ppr.* Keeping warm by the heat of a stove, or by artificial heat.

STÖVER, *v. t.* [Sax. *stow*, a place, a fixed place or mansion; G. *stauen*, D. *stucven*, Dan. *stuver*, to *stow*, to place; Sp. and Port. *estivar*, id., coinciding with L. *stipo*, to crowd, to *stuff*; Sp. *estiva*, a rammer; L. *stiva*, the handle of a plough. The sense is to set or throw down, from the more general sense of throwing, driving.] 1. To place; to put in a suitable place or position; as, to *stow* bags, bales, or casks in a ship's hold; to *stow* hay in a mow; to *stow* sheaves. The word has reference to the placing of many things, or of one thing among many, or of a mass of things.—2. To lay up; to reposit. [Stow in names, signifies place, as in *Darstow*.]

STOWAGE, *n.* The act or operation of placing in a suitable position; or the suitable disposition of several things together. The *stowage* of a ship's cargo to advantage requires no little skill. It is of great consequence to make good *stowage*. [This is the principal use of the word.]—2. Room for the reception of things to be reposit.

In every vessel there is *stowage* for immense treasures.

3. The state of being laid up. I am anxious to have the plate and jewels in safe *stowage*.—4. Money paid for stowing goods. [Little used.]

STOWED, *pp.* Placed in due position or order; reposit.

STÓWING, *ppr.* Placing in due position; disposing in good order.

STRABISM, *n.* [L. *strabismus*, from *straba*, *strabo*, a squint-eyed person.] 1. Squinting; a non-coincidence of the optic axes of the eyes upon an object, occasioned by a permanent lengthening of one of the lateral muscles of the ball of the eye, and a permanent shortening of its antagonist. This disorder may often be, to a great extent, overcome, especially in children, by blindfolding the sound eye, presuming one only to be affected. In very bad cases, especially those of squinting inwards, the deformity may be greatly relieved, by an operation recently introduced, which consists in dividing the internal rectus muscle of the eye-ball. This is done by proper scissors, without externally wounding the eyelid.—2. A squinting; the act or habit of looking askint.

STRAD'DLE, *v. i.* [from the root of *stride*; Sax. *stredan*, to scatter.] To part the legs wide; to stand or walk with the legs far apart.

STRAD'DLE, *v. t.* To place one leg on one side and the other on the other of any thing; as, to *straddle* a fence or a horse. [But in this sense there is an ellipsis of *across*.]

STRAD'DLING, *ppr.* Standing or walking with the legs far apart; placing one leg on one side and the other on the other.

STRAGGLE, *v. i.* (strag'l) [This word seems to be formed on the root of *stray*. In Sax. *stragan* is to *strew*, to *spread*; D. *strekken*, to *stretch*; G. *streichen*, to *pass*, to *migrate*; W. *treiglaw*, to *turn*, *revolve*, *wander*.] 1. To *wander* from the direct course or way; to *rove*. When troops are on the march, let not the men *straggle*.—2. To *wander* at large without any certain direction or object; to *ramble*. The wolf spied a *straggl*ing kid. L' *Estrange*.

3. To *exuberate*; to *shoot* too far in growth. Prune the *straggl*ing branches of the hedge.—4. To be dispersed; to be apart from any main body.

They came between Scylla and Charybdis and the *straggl*ing rocks. Raleigh.

STRAG'GLER, *n.* A wanderer; a rover; one that departs from the direct or proper course; one that rambles without any settled direction.—2. A vagabond; a wandering shiftless fellow.—3. Something that shoots beyond the rest or too far.—4. Something that stands by itself.—5. A seaman who deserts his ship.

STRAG'GLING, *ppr.* Wandering; roving; rambling; being in a separate position.

STRÄHL-STEIN, *n.* [G. *strahl*, a beam or gleam, and *stein*, stone.] Another name of actinolite.

STRAIGHT, *a.* (strait.) L. *strictus*, from *stringo*; Sax. *strac*; formed from the root of *reach*, *stretch*, *right*, L. *rectus*, G. *recht*, Fr. *etroit*, It. *stretto*, in which the palatal letter is lost; but the Spanish retains it in *estrecho*, *estrechar*. It is lost in the Port. *estretto*. It is customary to write *straight*, for direct or right, and *strait*, for narrow; but both senses proceed from *stretching*, *straining*.] 1. Right, in a mathematical sense; direct; passing from one point to another by the nearest course; not deviating or crooked; as, a *straight* line; a *straight* course; a *straight* piece of timber. [See LINE.]—2. Narrow; close; tight; as, a *straight* garment. [See STRAIT, as it is generally written.]—3. Upright; according with justice and rectitude; not deviating from truth or fairness.

STRAIGHT, *adv.* Immediately; directly; in the shortest time.

I know thy generous temper well; Flung but the appearance of dishonour on it, It *straight* takes fire, and mounts into a blaze. Addison.

STRAIGHT ARCH, *n.* In *arch.*, the arch over an aperture in which the intrados is straight, or an arch consisting of straight lines and a pointed top, comprising two sides of an equilateral triangle. Its form may be considered as intermediate between that of the semi-circular and of the Gothic arch.

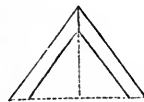

Straight Arch.

STRAIGHT EDGE, *n.* In *joinery*, a slip of wood made perfectly straight on the edge, and used to ascertain whether other edges are straight, or whether the face of a board is planed straight. It is made of different lengths, according to the required magnitude of the work. Its use is obvious, as its application will shew whether there is a coincidence between the straight edge and the surface or edge to which it is applied. It is also used for drawing straight lines on the surface of wood. [See WINDING STICKS.]

STRAIGHTEN, *v. t.* (stra'it'n.) To make straight; to reduce from a crooked to a straight form.—2. To make narrow, tense, or close; to tighten.—3. To reduce to difficulties or distress; to straighten.

STRAIGHTENED, *pp.* Made straight; made narrow.

STRAIGHTENER, *n.* He or that which straightens.

STRAIGHTENING, *ppr.* Making straight or narrow.

STRAIGHTFORTH, *adv.* Directly; henceforth.

STRAIGHTFORWARD, *a.* Proceeding in a straight course; not deviating. STRAIGHTFORWARDLY, *adv.* In a direct manner.

STRAIGHTFORWARDNESS, *n.* Direction in a straight course; undeviating rectitude.

STRAIGHT-JOINT FLOOR. In *arch.* [See FLOOR.]

STRAIGHTLINED, *a.* Having straight lines.

STRAIGHTLY, *adv.* In a right line; not crookedly.—2. Tightly; closely.

STRAIGHTNESS, *n.* The quality or state of being straight; rectitude.—2. Narrowness; tension; tightness.

STRAIGHT-PIGHT, *adv.* Straight-fixed; erect.

STRAIGHTWAY, *adv.* [straight and way.] Immediately; without loss of time; without delay.

He took the damsel by the hand, and said to her, Talitha cumi. And *straightway* the damsel arose; Mark v. [Straightways is obsolete.]

STRAIKS, *n.* Strong plates of iron on the circumference of a cannon wheel, over the joints of the fellics. [See STRAKE.]

STRAIN, *v. t.* [Fr. *etrendre*; L. *stringo*. This word retains its original signification, to stretch. *Strain* is the L. *stringo*, as *straight* is *strictus*, in different dialects.] 1. To stretch; to draw with force; to extend with great effort; as, to *strain* a rope; to *strain* the shrouds of a ship; to *strain* the cords of an instrument.—2. To cause to draw with force, or with excess of exertion; to injure by pressing with too much effort. He *strained* his horses or his oxen by overloading them.—3. To stretch violently or by violent exertion; to stretch beyond the proper extent; as, to *strain* the arm or the muscles.—4. To put to the utmost strength. Men in desperate cases will *strain* themselves for relief.—5. To press or cause to pass through some porous substance; to purify or separate from extraneous matter by filtration; to filter; as, to *strain* milk. Water may be *strained* through sand.—6. To sprain; to injure by drawing or stretching.

Prudes decay'd about may tack, *Strain* their necks with looking back. Swift.

7. To make tighter; to cause to bind closer. To *straiten* his fetters with a stricter care.

*Dryden.*

8. To force; to constrain; to make uneasy or unnatural.

His mirth is forced and *strained*. *Denham.*  
9. To press or squeeze in an embrace. I would have *strained* him with a strict embrace.

*Dryden.*

**STRAIN**, *v. i.* To make violent efforts. To build his fortune I will *strain* a little.

*Shak.*

*Straining* with too weak a wing. *Pope.*  
2. To be filtered. Water *straining* through sand becomes pure.

**STRAIN**, *n.* A violent effort; a stretching or exertion of the limbs or muscles, or of any thing else.—2. An injury by excessive exertion, drawing, or stretching.—3. Style; continued manner of speaking or writing; as, the genius and *strain* of the Book of Proverbs. So we say, poetic *strains*, lofty *strains*.—4. Song; note; sound; or a particular part of a tune.

Their heavenly harps a lower *strain* began.

*Dryden.*

5. Turn; tendency; inborn disposition. Because heretics have a *strain* of madness, he applied her with some corporal chastisements.

*Hayward.*

6. Manner of speech or action. Such take too high a *strain* at first. *Bacon.*

7. Race; generation; descent.

He is of a noble *strain*.

*Shak.*

8. Hereditary disposition.

Intemperance and lust breed diseases, which propagated, spoil the *strain* of a nation.

*Tillotson.*

9. Rank; character.—10. In *mech.*, the force which acts on any material, and which tends to disarrange its component parts or destroy their cohesion. A solid body may be subjected to four different kinds of strains: 1. A longitudinal strain, which tends to pull its parts asunder; 2. A transverse strain, which tends to break it asunder; 3. A compressing strain, which tends to crush it; and 4. A strain of torsion, which tends to wrench it asunder. In all edifices and machines there must be a just adaptation of the strength at any one point to the strain there experienced, as upon this adaptation depends the stability of the whole.

**STRAINABLE**, *† a.* Capable of being strained.

**STRAINED**, *pp.* Stretched; violently exerted; filtered.

**STRAINER**, *n.* That through which any liquid passes for purification; an instrument for filtration.

**STRAINING**, *ppr.* Stretching; exerting with violence; making great efforts; filtering.

**STRAINING**, *n.* The act of stretching; the act of filtering; filtration.

**STRAINING PIECE**, *n.* In *arch.*, a beam placed between two opposite beams to prevent their nearer approach; as rafters, braces, struts, &c. If such a piece performs also the office of a sill, it is called a *straining sill*.

**STRAINT**, *† n.* A violent stretching or tension.

**STRAIT**, *a.* [See STRAIGHT.] Narrow; close; not broad; tense; tight.

*Strait* is the gate, and narrow is the way that leadeth to life, and few there be that find it; *Matt. vii.*

2. Close; intimate; as, a *strait* degree of favour.—3. Strict; rigorous.

He now, forsooth, takes on him to reform Some certain edicts, and some *strait* decrees.

*Shak.*

4. Difficult; distressful.—5. Straight; not crooked. [*Lit. us.* See STRAIGHT.]

—6. Stingy; avaricious.

**STRAIT**, *n.* [See STRAIGHT.] A narrow pass or passage, either in a mountain or in the ocean, between continents or other portions of land; as, the *straits* of Gibraltar; the *straits* of Magellan; the *straits* of Dover. [*In this sense, the plural is more generally used than the singular, and often without any apparent reason or propriety.*]—2. Distress; difficulty; distressing necessity; formerly written *streight*. [*Used either in the singular or plural.*]

Let no man who owns a Providence, become desperate under any calamity or *strait* whatsoever.

*South.*

Ulysses made use of the pretence of natural infirmity to conceal the *straits* he was in at that time in his thoughts.

*Broome.*

**STRAIT**, *† v. t.* To put to difficulties.

**STRAIT-EDGE**, *n.* A small board or piece of metal having one edge perfectly straight; used to ascertain whether a surface is perfectly plane, &c. [See STRAIGHT EDGE.]

**STRAITEN**, *v. t.* (*strait'n*.) To make narrow.

In narrow circuit *straiten'd* by a foe.

*Milton.*

2. To contract; to confine; as, to *straiten* the British commerce.—3. To make tense or tight; as, to *straiten* a cord.—4. To distress; to perplex; to press with poverty or other necessity; as, a man *straitened* in his circumstances.—5. To press by want of sufficient room.

Waters, when *straitened*, as at the falls of bridges, give a roaring noise.

*Bacon.*

**STRAITENED**, *pp.* Made narrow; contracted; perplexed.

**STRAIT-HANDED**, *a.* [*strait* and *hand*.] Parsimonious; sparing; niggardly. [*Not much used.*]

**STRAIT-HAND'EDNESS**, *n.* Niggardliness; parsimony.

**STRAIT-JACKET**. See STRAIT-WAISTCOAT.

**STRAIT-LACED**, *a.* [*strait* and *lace*.] Griped with stays.

We have few well-shaped that are *strait-laced*.

*Locke.*

2. Stiff; constrained. Hence,—3. Rigid in opinion; strict.

**STRAITLY**, *adv.* Narrowly; closely.—2. Strictly; rigorously. [For this, *strictly* is now used.]—3. Closely; intimately.

**STRAITNESS**, *n.* Narrowness; as, the *straitness* of a place; *straitness* of mind; *straitness* of circumstances.—2. Strictness; rigour; as, the *straitness* of a man's proceedings.—3. Distress; difficulty; pressure from poverty of any kind, particularly from poverty.—4. Want; scarcity; or rather narrowness; as, the *straitness* of the conveniences of life.

**STRAIT-WAISTCOAT**, *n.* An ap-

**STRAIT-JACKET**, *n.* A paratus to confine the arms of a distracted person.

**STRAKE**, *† pret.* of *Strike*. [See STRIKE.]

**STRAKE**, *n.* [*Sp. traca*.] 1. A streak. [Not used, unless in reference to the range of planks in a ship's side. See STREAK.]—2. A narrow board.

—3. The iron band of a wheel or tire of a carriage-wheel by which the fel-lies are defended and kept firm.

**STRAM'ASH**, *v. t.* [*It. stramazare*.]

To strike, beat, or bang; to break; to destroy. [*Local and vulgar.*]

**STRAMINEOUS**, *a.* [*L. stramineus*, from *stramen*, straw.] 1. Strawy; consisting of straw.—2. Chaffy; like straw: light.

**STRAMONINE**, *n.* A crystalline compound found along with daturine in the seeds of *Datura stramonium*. It is crystallizable, volatile, soluble in alcohol and ether, insoluble in water. Its nature is uncertain and its composition unknown.

**STRAM'ONY**, or THORN APPLE, *n.* A narcotic plant, the *Datura stramonium*. [See DATURA.]

**STRAND**, *n.* [*Sax. strand*; G. D. Dan. and Sw. *strand*.] 1. The shore or beach of the sea or ocean, or of a large lake, and perhaps of a navigable river. It is never used of the bank of a small river or pond. The Dutch on the Hudson apply it to a landing place; as, the *strand* at Kingston.—2. One of the twists or parts of which a rope is composed. [*Russ. struma*, a cord or string.]

**STRAND**, *v. t.* To drive or run aground on the sea shore; as a ship.—2. To break one of the strands of a rope.

**STRAND**, *v. i.* To drift or be driven on shore; to run aground; as, a ship *strands* at high water.

**STRAND'ED**, *pp.* Run ashore; a term applied to a ship that is driven on a rock or shoal by a tempest, or run aground through ill steerage, so as to be either rendered useless or entirely dashed to pieces.—2. Having a strand broken; as a rope or cable.

**STRAND'ING**, *ppr.* Running ashore; breaking a strand.

**STRAND'ING**, *n.* The running of a ship on the shore, beach, or strand, by which she is wrecked. By statute, all sheriffs, justices, &c., on application from those in danger of being, or who actually have been, stranded or run on shore, are required to call together as many men as may be necessary, and demand aid from the queen's ships, or those of her subjects in the neighbourhood, under a penalty of £100 on the superior officer who refuses to obey the call. The master of the stranded ship is entitled to repel by force all who intrude without leave of the officer of customs, &c.; and provision is made for the orderly proceedings of salvors, and for the settling of the salvage.

**STRANGE**, *a.* [*Fr. e strange*; *It. strano*, strange, foreign, pale, wan, rude, unpolite; *stranare*, to alienate, to remove, to abuse; *stranare*, to separate; *Sp. extraño*, foreign, extraneous, rare, wild; *L. extraneus*; *W. estronaiz*, strange; *estrawm*, a stranger. The primary sense of the root *tran* is to depart, to proceed; *W. traaw*, over; *traw*, an advance or distance.] 1. Foreign; belonging to another country.

I do not condemn the knowledge of *strange* and divers tongues. [*This sense is nearly obsolete.*]

*Ascham.*

2. Not domestic; belonging to others. So she, impatient her own faults to see, Turns from herself, and in *strange* things delights. [*Nearly obsolete.*]

3. New; not before known, heard, or seen. The former custom was familiar; the latter was *strange* to them. Hence,—4. Wonderful; causing surprise; exciting curiosity. It is *strange* that men will not receive improve-



ment, when it is shown to be improved.

Sated at length, ere long I might perceive  
Strange alteration in me. *Milton.*

5. Odd; unusual; irregular; not according to the common way.  
He's *strange* and peevish. *Shak.*

6. Remote. [*Little used.*]-7. Uncommon; unusual.

This made David to admire the law of  
God at that *strange* rate. *Tillotson.*

8. Unacquainted.  
They were now at a gage, looking  
*strange* at one another. *Bacon.*

9. *Strange* is sometimes uttered by way of exclamation.

*Strange!* what extremes should thus preserve  
the snow,  
High on the Alps, or in deep caves below. *Waller.*

This is an elliptical expression for *it is strange.*

STRANGE, † v. t. To alienate; to estrange.

STRANGE, † v. i. To wonder; to be astonished.—† To be estranged or alienated.

STRANGE-LOOKING, a. Having an odd or unusual look.

STRANGELY, † adv. With some relation to foreigners.—2. Wonderfully; in a manner or degree to excite surprise or wonder.

How *strangely* active are the arts of peace. *Dryden.*

It would *strangelj* delight you to see  
with what spirit he converses. *Lau.*

STRANGENESS, n. Foreignness; the state of belonging to another country.

If I will obey the gospel, no distance of place, no *strangeness* of country can make any man a stranger to me. *Sprat.*

2. Distance in behaviour; reserve; coldness; forbidding manner.

Will you not observe  
The *strangeness* of his alter'd countenance? *Shak.*

3. Remoteness from common manners or notions; uncothness.

Men worthier than himself  
Here tend the savage *strangeness* he puts on. *Shak.*

4. Alienation of mind; estrangement; mutual dislike.

This might seem a means to continue a  
*strangeness* between the two nations. *Bacon.*

[*This sense is obsolete or little used.*]-

5. Wonderfulness; the power of exciting surprise and wonder; uncommonness that raises wonder by novelty.

This raised greater tumults in the hearts  
of men, than the *strangeness* and seeming  
unreasonableness of all the former articles. *South.*

STRANGER, n. [Fr. *étranger*.] 1. A foreigner; one who belongs to another country. Paris and London are visited by *strangers* from all the countries of Europe.—2. One of another town, city, state, or province in the same country.—3. One unknown. The gentleman is a *stranger* to me.—4. One unacquainted.  
My child is yet a *stranger* to the world. *Shak.*

I was no *stranger* to the original. *Dryden.*

5. A guest; a visitor.—6. One not admitted to any communication or fellowship.

Melons on beds of ice are taught to bear,  
And *strangers* to the sun yet ripen here. *Granville.*

7. In *law*, one not privy or party to an act.

STRANGER, † v. t. To estrange; to alienate.

STRAN'GLE, v. t. [Fr. *étrangler*; It. *strangolare*; L. *strangulo*.] 1. To choke; to suffocate; to destroy life by stopping respiration.

Our Saxon ancestors compelled the adulteress to *strangle* herself. *Ayliffe.*

2. To suppress; to hinder from birth or appearance.

STRAN'GLEABLE, a. That may be strangled.

STRAN'GLED, pp. Choked; suffocated; suppressed.

STRAN'GLER, n. One who strangles.

STRAN'GLES, n. A disorder which attacks most horses, and generally between the ages of three and five years. When strangles occur in the stables and now and then in the field, it proves a severe disease, and shows itself under the appearance of a cold, with cough, sore throat, and swellings of the glands under the jaws, or behind and under the ears.

STRAN'GLING, ppr. Choking; suffocating; suppressing.

STRAN'GLING, n. The act of destroying life by stopping respiration.

STRAN'GULATED, a. In *sur.*, having the circulation stopped in any part, by compression. A hernia is said to be *strangulated*, when it is so compressed as to obstruct the circulation in the part, and cause dangerous symptoms.

STRANGULA'TION, n. [Fr. from L. *strangulatio*.] 1. The act of strangling; the act of destroying life by stopping respiration; suffocation.—2. That kind of suffocation which is common to women in hysterics; also, the compression of the intestines in hernia, so as to suspend the circulation in the part.

STRANGU'RIOUS, a. Labouring under strangury; of the nature of strangury; denoting the pain of strangury.

STRAN'GURY, n. [L. *stranguria*; Gr. *στανγυρία*; a drop, and *ουρον*, urine.] A disease in which there is pain in passing the urine, which is excreted by drops.

STRAP, n. [D. *strop*, a rope or halter; Sax. *stropp*; L. *stropus*. *Strap* and *strop* appear to be from *stripping*, and perhaps *stripe* also; all having resemblance to a *strip* of bark peeled from a tree.] 1. A long narrow slip of cloth or leather, of various forms and for various uses; as, the *strap* of a shoe or boot; *straps* for fastening trunks or other baggage, for stretching limbs in surgery, &c.—2. In *bot.*, the flat part of the corollet in ligulate florets; also, the leaf exclusive of its sheath in some grasses.—3. In *carpentry*, an iron plate placed across the junction of two timbers for the purpose of securing them together.—4. In *ships*, a piece of rope, generally spliced into a circular wreath, and used to surround the body of a block, so that the latter may be hung to any particular station about the masts, yards, or rigging. Sometimes a hoop of iron is used instead of rope.—5. In the *army*, a long strip of worsted, silk, gold, or silver, worn on the shoulder that has no epaulette.

STRAP, v. t. To beat or chastise with a strap.—2. To fasten or bind with a strap.

STRAPPA'DO, n. [It. *strappata*, a pull, strappado; *strappare*, to pull.] A military punishment formerly practised.

It consisted in drawing an offender to the top of a beam and letting him fall, by which means a limb was sometimes dislocated.

STRAPPA'DO, v. t. To torture.

STRAP'PED, pp. Beaten with a strap; fastened with a strap.

STRAP'PING, ppr. Binding or beating with a strap.—2. a. Tall; or lusty, as a *strapping* fellow. [*Vulgar.*]-In *Scotch*, *strapping* or *strappan* signifies tall and handsome.

STRAP'-SHAPED, a. In *bot.*, ligulate, —*which see.*-*Strap-shaped corolla*, a corolla which is tubular at the base, then slit on one side, so that the limb becomes flat, as in the Dandelion.

STRAP'-WORT, n. A British plant of the genus *Corrigiola*, the *C. littoralis*, belonging to the nat. order Illecebraceæ or knot-grass tribe. It is an annual with spreading stems, leaves between lance-shaped and linear, and numerous white flowers. It grows on the eastern coast of England.

STRASS, n. A compound mineral substance, used in making artificial gems.

STRATA, n. plur. [*See* STRATUM.] Beds; layers; as, *strata* of sand, clay, or coal.

STRAT'AGEM, n. [L. *stratagema*; Fr. *stratagème*; Gr. *στρατηγία*, from *στρατηγος*, to lead an army.] 1. An artifice, particularly in war; a plan or scheme for deceiving an enemy.—2. Any artifice; a trick by which some advantage is intended to be obtained.

Those oft are *stratagems* which errors seem. *Pope.*

STRATAGEM'ICAL, a. Containing stratagem, or artifice. [*Little used.*]

STRAT'ARITH'METRY, n. [Gr. *στρατηγία*, a camp, *ἀριθμός*, a multitude, and *μέτρον*, measure.] In *milit. tactics*, the art of drawing up an army or body of men in a geometrical figure.

STRATE'GIC, } a. Pertaining to  
STRATE'GICAL, } strategy; effected by artifice.

STRATE'GICS, } n. pl. *See* STRA-  
STRATEGE'TICS, } TEGY.

STRATE'GIST, n. One skilled in the art of arranging an army for conflict.

STRATE'GUS, n. [Gr. *στρατηγός*.] An Athenian general officer.

STRATE'GY, or STRATE'GY, n. Properly, the science of combining and employing the means which the different branches of the art of war afford, for the purpose of forming projects of operations, and of directing great military movements. It was formerly distinguished from the art of making dispositions and of manœuvring, when in the presence of the enemy; but military writers now, in general, comprehend all these subjects under the denomination of grand and elementary tactics. [*See* TACTICS.]

STRATH, n. [Gael. *srath*, a country confined by hills on two sides of a river.] In *Scotland*, a valley of considerable size, through which a river runs. Such a valley is generally designated by prefixing *strath* to the name of the river; as, *Strathspey*, *Strathdon*, *Strathearn*, &c.

STRATH'SPEY, n. In *Scotland*, a species of dance in which two persons are engaged. It is so denominated from the country of Strathspey, probably as having been first used there.—2. A species of dance music in common time, peculiar to Scotland. It probably originated in the same district as the above dance, and at the same

time, but it is not now confined to that dance.

**STRATIFICATION**, *n.* [from *stratify*.] The process by which substances in the earth have been formed into strata or layers.—2. The arrangement of substances in strata or layers; one upon another, like the leaves of a book; as the *stratification* of rocks.—3. The act of laying in strata.

**STRATIFIED**, *pp.* Arranged or disposed in layers or strata, as *stratified rocks*. Rocks are divided into *stratified* and *unstratified*. Stratified rocks are those which are disposed in layers one above the other; as, slates, sandstones, limestones. Unstratified rocks appear in masses, without any such arrangement as that exhibited by the stratified rocks. Granite, greenstone, and lava belong to the latter class.

**STRATIFORM**, *a.* In the form of strata.

**STRATIFY**, *v. t.* [Fr. *stratifier*, from *L. stratum*.] 1. To form into a layer, as substances in the earth. Thus clay, sand, and other species of earth are often found *stratified*.—2. To lay in strata.

**STRATIFYING**, *ppr.* Arranging in a layer, as terrene substances.

**STRATIGRAPHICAL**, *a.* Belonging to stratigraphy.

**STRATIGRAPHICALLY**, *adv.* In a stratigraphical manner.

**STRATIO'NES**, *n.* A genus of aquatic plants, nat. order Hydrocharaceæ. There is only one species a native of Britain, the *S. aloides* or water-soldier, which grows in lakes, pools, and ditches.

It is a singular plant, with numerous sword-shaped leaves and white flowers, from a compressed two-leaved spathe.

**STRATOE'RACY**, *n.* [Gr. *στρατος*, an army, and *κρατος*, to hold.] A military government; government by military chiefs and an army.

**STRATOG'RAPHY**, *n.* [Gr. *στρατος*, an army, and *γραφω*, to describe.] Description of armies, or what belongs to an army.

**STRATON'IC**, *a.* Pertaining to an army.

**STRATOT'IC**, *a.* Warlike; military.

**STRATUM**, *n.* plur. *Strata*. [L. from *sterno*, to spread or lay; Sax. *streone*.] 1. In *geol.* and *mineral.*, a layer of any deposited substance, as sand, clay, limestone, &c., which is spread out over a certain surface by the action of water, or in some cases by wind. The deposition of successive layers of sand and gravel in the bed of a river, or in a canal, affords an illustration both of the form and origin of strata. Some geologists make a distinction between a *stratum* and a bed, restricting the latter term to the thicker kind of strata; others, however, use the terms synonymously. Strata are masses having a much greater extension in two of their dimensions than in the third, and generally occupying large spaces. In its simplest or most perfect form, the stratum may be considered as a great bed or plate, of which the upper and lower surfaces are straight and parallel. But many modifications are observed; for the surfaces may be inclined to each other, so that if prolonged they would terminate in an edge, or the stratum may be thicker at one part than another; or it may be variously bent, undulated, or fractured. While some strata are horizontal, others are perpendicular, and all intermediate

degrees of inclination are met with. Strata of sandstone and clay are generally supposed to have been deposited from the turbid waters of the sea, lakes, or rivers, their laminae being arranged over each other in a regular manner. Others again, as of mica-slate, are supposed to have resulted from chemical precipitation. A stratum may vary in thickness from a few yards to a thousand feet or more. Strata are separated from each other by seams or parallel planes, and sometimes by joints or fissures, forming some angle with the planes. When a stratum does not lie horizontally but is inclined, it is said to *dip* towards some point of the compass, and the angle it makes with the horizon is called the angle of *dip* or inclination. The direction or strike of the strata is indicated by a horizontal line at right angles to the dip. When strata protrude above the surface, or appear uncovered, they are said to *crop out*. They are said to be *conformable*, when their planes are parallel, whatever their dip may be; and *unconformable*, when a set of them are connected with another, so that the planes of stratification of the one series have a different direction from that of the other series. On examining the crust of the earth, we find that it consists chiefly of distinct strata of different materials. These differ in depth and extent, but they are found to follow each other, on the large scale, as masses in an apparently regular and uniform succession, in all places, districts, and countries, where they admit of examination, and have been attentively studied. They appear in most instances to rest upon, and are blended with, invaded, and, in some few instances, overflowed, as it were, by unstratified rocks. Stratified rocks have been divided, according to the order of their deposition, into four groups: 1. Primary; 2. Secondary; 3. Tertiary; 4. Alluvial. The primary or lowest stratified rocks, such as gneiss, mica slate, clay-slate, quartz, &c., are distinguished from the others by a crystalline structure, and by containing no organic remains. These secondary stratified rocks, commencing with the graywacke, and ending with the chalk, are found to contain remains of plants and animals for the most part extinct. They have been variously grouped and subdivided by geologists. The tertiary stratified rocks include the eocene, miocene, older pliocene, and newer pliocene of Lyell. [See these terms.] The alluvial, or recent strata, consist of alluvial, concretionary, coralline, and vegetable deposits.—2. A bed or layer artificially made.

**STRAT'US**, *n.* [L.] Fall cloud; a name applied to fogs, mists, and other extensive sheets of clouds that rest on the earth's surface. [See *CLOUD*.]

**STRAUGHT**, *pp.* for *Stretched*.

**STRAVAIG'**, *v. i.* [It. *stravagare*, from *L. extravagare*.] To stroll; to wander; to go about idly. [Scotch.]

**STRAW**, *n.* [Sax. *strew*, straw, and a stratum or bed; G. *stroh*; Dan. *straae*; L. *stramentum*, from *sterno*, *stravi*, *stratum*. See *STREW*.] 1. The stalk or stem of certain species of grain, pulse, &c., chiefly of wheat, rye, oats, barley, buckwheat, and peas. When used of single stalks, it admits of a plural, *straws*. *Straws* may show which way the wind blows. We say of grain while growing, the *straw* is large, or it is

rusty.—2. A mass of the stalks of certain species of grain when cut, and after being thrashed; as, a bundle or a load of *straw*. In this sense, the word admits not the plural number. Straw is used for various purposes; as for fodder to cattle, as thatch for corn stacks and houses, ropes for securing the thatch of corn stacks, &c.; litter for cattle and horses; and finally, as manure. Wheat-straw is the material chiefly used in the manufacture of straw bonnets for ladies.—3. Any thing proverbially worthless. I care not a *straw* for the play. I will not abate a *straw*.

**STRAW**, *v. t.* To spread or scatter. [See *STREW* and *STROW*.]

**STRAW'BERRY**, *n.* [*straw* and *berry*; Sax. *straw-berie*.] The English name of the fruit and plant of the *Fragaria*, a genus of plants, nat. order Rosaceæ. The fruit of the *Fragaria* is one of the most delicious of our summer fruits. The species are perennial plants, throwing out runners; the leaves are trifoliate, each leaflet being coarsely toothed; the receptacle on which is seated the carpels, and which is called the fruit, is round, and assumes a variety of colours, from a scarcely perceptible pink to a dark red. All the species are natives of temperate or cold climates, and are found in Europe, America, and the mountains of Asia. The following species afford the varieties of cultivated strawberries: 1. Wood or Alpine strawberry, *F. vesca*, found wild in woods and on hill sides throughout Europe, and abundant in Great Britain. Of this species there are several varieties cultivated in gardens; as the red, the white, the American, and Danish Alpine strawberries; the red wood strawberry, the white wood strawberry, and the red and white Alpine bush strawberry. 2. The hill strawberry, *F. collina*, a native of Switzerland and Germany. The varieties of strawberries called green, are the produce of this species. 3. Hautbois strawberry, *F. elatior*, a native of North America. It is the parent of a great number of sorts known in gardens, most of which are much prized, as the black, brown, and common hautbois, the globe, the large flat hautbois, the long-fruited muscatella, and Sir Joseph Banks. 4. Virginian strawberry, *F. virginiana*, a native of Virginia. To this species belongs the great list of sorts, cultivated in gardens, and known by the name of scarlet and black strawberries. The various kinds of scarlet, globe, cone, and some pine strawberries are produced from this species. 5. Large flowered strawberry, *F. grandiflora*, a native of Surinam, which has furnished our gardens with the sorts called pine strawberries. 6. Chili strawberry, *F. chilensis*, a native of Chili and Peru, and the parent of a number of mostly inferior strawberries. Strawberries, when ripe, may be eaten in almost any quantity without injury. They are frequently eaten mixed with sugar and cream or wine. When ripe and well grown they hardly require such additions; but when their sugar is deficient, this may be safely added, and the addition of wine, under these circumstances, should be preferred to cream, as the latter is very liable to disagree with disordered stomachs.

**STRAW'BERRY-PEAR**, *n.* A plant of the genus cactus, the *C. triangularis*,

which grows in the West India Islands. It bears the best flavoured fruit of any



Strawberry Pear (Cactus triangularis).

of the Cactaceæ. It is sweetish, slightly acid, pleasant, and cooling.

**STRAWBERRY-TREE, n.** An evergreen tree of the genus *Arbutus*, the *A. unedo*, a native of the South of Europe, and found in a wild state near Killarney in Ireland; the fruit is of a fleshy substance, like a strawberry. It is edible, and in Spain both a sugar and spirit are extracted from it.

**STRAW'-BONNET, n.** A bonnet for females, made of plaited wheat-straw.

**STRAW'-BUILT, a.** [*straw and built.*] Constructed of straw; as, the suburbs of a *straw-built* citadel.

**STRAW'-COLOUR, n.** The colour of dry straw; a beautiful yellowish colour.

**STRAW'-COLOURED, a.** Of a light yellow, the colour of dry straw.

**STRAW'-CROWNED, a.** Covered with straw.

**STRAW'-CUTTER, n.** An instrument to cut straw for fodder.

**STRAW'-DRAIN, n.** A drain filled with straw.

**STRAW'-HAT, n.** A woman's hat made of straw, as a Leghorn hat. Straw hats are also manufactured for men.

**STRAW'-HOUSE, n.** In *agric.*, a house for holding straw after the grain has been thrashed out.

**STRAW'-PLAIT, n.** Ribbons formed of wheat straws plaited together, from half an inch to an inch broad. These when sewed together, according to fancy or fashion, form different descriptions of ladies' bonnets; and the commoner plait and coarser straw form men's hats. There are various kinds of plait in general use, some of which are composed of entire straws, and others of split straws. The straw chiefly used for plait is that of the *triticum turgidum*, a variety of bearded wheat, cultivated in Italy between Leghorn and Florence.

**STRAW'-ROOFED, a.** Having a roof of straw.

**STRAW'-ROPE, n.** A rope made of straw twisted, and used to secure the thatch of corn ricks and stacks, and also the thatch of the poorer description of cottages.

**STRAW'-STUFFED, a.** Stuffed with straw.

**STRAW'-WORM, n.** [*straw and worm.*] A worm bred in straw.

**STRAW'Y, a.** Made of straw; consisting of straw.—2. Like straw; light. **STRAY, v. i.** [The elements of this word

are not certainly known. If they are *Strg*, the word coincides with Sax. *strægan*, *strégan*, to scatter, to spread, the *L. stravi*, Eng. to *strow*, *strew*, or *throw*, also with *G. streichen*, to wander, to strike; both probably from the root of *reach*, *stretch*. Possibly *stray* is from the It. *straviare*, from *L. extra* and *via*. We are inclined, however, to refer it to a Teutonic origin. See **STRAGGLE**.] 1. To wander, as from a direct course; to deviate or go out of the way. We say, to *stray* from the path or road into the forest or wood.—2. To wander from company, or from the proper limits; as, a sheep *strays* from the flock; a horse *strays* from an inclosure.—3. To rove; to wander from the path of duty or rectitude; to err; to deviate.

We have erred and *strayed*.

Common Prayer.

4. To wander; to rove at large; to play free and unconfined.

*L. o, the glad gales o'er all her beauties stray,*  
Breathe on her lips and in her bosom play.

Pope.

5. To wander; to run a serpentine course.

Where Thames among the wanton valley *strays*.

Denham.

**STRAY, † v. t.** To mislead.

**STRAY, n.** Any domestic animal that has left an inclosure or its proper place and company, and wanders at large or is lost. The laws provide that *strays* shall be taken up, impounded and advertised.

Seeing him wander about, I took him up for a *stray*.

Dryden.

2. The act of wandering. [*Little used.*]

**STRAYER, n.** A wanderer.

**STRAYING, ppr.** Wandering; roving; departing from the direct course, from the proper inclosure, or from the path of duty.

**STRAYING, n.** The act of wandering away.

**STREAK, n.** [*Sax. strica*, a line, direction, course; *strican*, to go; *stric*, a stroke, a plagne, and *strec*, a stretch; *G. streich*, a stroke or stripe, and *strich*, id.; *D. streeh*, a course; *Dan. streg*, a stroke or line; *strihke*, a cord; *strög*, a stroke, a tract, a row; *Sw. sträh*; *Ir. strioc*. These have all the same elements, and the *L. stria* is probably a contraction of the same word; *Sp. traca*, without a prefix.] 1. A line or long mark, of a different colour from the ground; a stripe.

What mean those colour'd streaks in heaven?

Milton.

2. In a *ship*, streaks are the uniform ranges of planks on the bottom or sides of a ship; or the continuation of planks joined to each other at their ends, and reaching from the stem to the stern post. The lowest of these is called the *garboard streak*, which is let into the keel below, and into the stem and stern post. The word is sometimes written and pronounced *strakes*.—3. In *min.*, the appearance of a mineral which arises from its being scratched with a hard sharp instrument. The *streak* is said to be *similar*, when the colour of the powder produced by scratching the mineral is the same with the colour of the mineral itself; and when the colour varies, the streak is said to be *dissimilar*.

**STREAK, v. t.** To form streaks or stripes in; to stripe; to variegate with

lines of a different colour or of different colours.

A mule admirably *streaked* and dappled with white and black. *Sandys*.  
Now *streak'd* and glowing with the morning red. *Prior*.

2. To stretch. [*Not elegant.*]

**STREAKED, pp.** Marked or variegated with stripes of a different colour.

**STREAKING, ppr.** Making streaks in. **STREAKY, a.** Having stripes; striped; variegated with lines of a different colour.

**STREAM, n.** [*Sax. stream*; *G. strom*; *W. ystrym*; *Ir. sreamh* or *creav*.] 1. A current of water or other fluid; a liquid substance flowing in a line or course, either on the earth, as a river or brook, or from a vessel or other reservoir or fountain. Hence.—2. A river, brook or rivulet.—3. A current of water in the ocean; as, the gulf *stream*.—4. A current of melted metal or other substance; as, a *stream* of lead or iron flowing from a furnace; a *stream* of lava from a volcano.—5. Any thing issuing from a source and moving with a continued succession of parts; as, a *stream* of words; a *stream* of sand.

A *stream* of beneficence. *Atterbury*.

6. † A continued current or course; as, a *stream* of weather.

The *stream* of his life. *Shak*.

7. A current of air or gas, or of light.

—8. Current; drift; as, of opinions or manners. It is difficult to oppose the *stream* of public opinion.—9. Water.

**STREAM, v. i.** To flow; to move or run in a continuous current. *Blood streams* from a vein.

Beneath the banks where rivers *stream*.

Milton.

2. To emit; to pour out in abundance. His eyes *streamed* with tears.—3. To issue with continuance, not by fits.

From op'ning skies may *streaming* glories shine.

Pope.

4. To issue or shoot in streaks; as, light *streaming* from the east.—5. To extend; to stretch in a long line; as, a flag *streaming* in the wind.

**STREAM, v. t.** To mark with colours or embroidery in long tracts.

The herald's mantle is *streamed* with gold.

Bacon.

**STREAMER, n.** An ensign or flag; a pennon extended or flowing in the wind; a *poetic use of the word*.

Brave Rupert from afar appears.

Whose waving *streamers* the glad general knows.

Dryden.

*Auroral streamer*, a luminous beam or column; one of the forms of the *Aurora Borealis*.

**STREAMING, ppr.** Flowing; running in a current.—2. Emitting; pouring out in abundance; as, *streaming* eyes.—3. Flowing; floating loosely; as a flag. In *her.*, an epithet for a comet sending forth a stream of light.

**STREAMING, n.** In *tin mines*, the management of a stream work, or of stream tin during the process of refinement.

**STREAMLET, n.** A small stream; a rivulet; a rill.

**STREAM-TIN, n.** Among *miners*, tin ore, or native oxide of tin, found beneath the surface of alluvial ground, in rounded particles and masses, mixed with other alluvial matters. It is separated from the earthy matters by passing a stream of water over it;

hence the name. The finest grain-tin is obtained from this ore.

**STREAM-WORKS**, *n.* In *tin mines*, the repositories in which stream tin is found.

**STREAMY**, *a.* Abounding with running water.

Arcadia.

However *streamy* now, adust and dry. Denied the goddess water. *Prior.*

2. Flowing with a current or streak. His nodding helm emits a *streamy* ray. *Pope.*  
**STREET**, *n.* [*Sax. stræte, strete; G. strasse; Ir. sraid; W. ystryd; L. stratum, from stratus, strewed or spread. See STREW.*] 1. Properly, a paved way or road; but in usage, any way or road in a city, having houses on one or both sides, chiefly a main way, in distinction from a lane or alley. In common usage, the word *street* often includes the houses as well as the open way.—2. *Streets*, plural, any public way, road, or place.

That there be no complaining in our streets; *Ps. cxlv.*

**STREET-DOOR**, *n.* An outer-door.  
**STREET-KEEPER**, *n.* A kind of local policeman, who has the supervision of a street, &c.

**STREET-PACING**, *a.* Perambulating the streets.

**STREET-WALKER**, *n.* [*street and walk.*] A common prostitute.—2. An idler.

**STREET-WARD**, *n.* [*street and ward.*] Formerly, an officer who had the care of the streets.

**STREIGHT**, † *n.* A narrow. [*See STRAIT.*]  
**STREIGHT**, † *adv.* Strictly. [*See STRAIT.*]

**STREL'ITE**, *n.* In *min.*, anthropophyllite.

**STRELITZ**, *n.* A soldier of the ancient Muscovite guards, abolished by Peter the Great.

**STRELITZIA**, *n.* A genus of plants, growing in Cape Colony.

**STRENE**, † *n.* Race; offspring.  
**STRENGTH**, *n.* [*Sax. strength, from strenu, strong. See STRONG.*] 1. That property or quality of an animal body by which it is enabled to move itself or other bodies. We say, a sick man has not *strength* to walk, or to raise his head or his arm. We say, a man has *strength* to lift a weight, or to draw it. This quality is called also *power* and *force*. But *force* is also used to denote the effect of strength exerted, or the quantity of motion. *Strength*, in this sense, is positive, or the power of producing positive motion or action, and is opposed to *weakness*. In *mech.*, the strength of animals is the muscular force or energy which they are capable of exerting. It is a matter of much importance to be able to estimate, with tolerable accuracy, the effort which an animal of the average strength employed in labour is capable of exerting under different circumstances, because the results afford data for determining the modes in which animal labour may be most advantageously employed. In order to compare the effects produced by different animals, or the same animal under different circumstances, it is usual to estimate the force required to raise or transport 1 pound through one foot of space in a minute of time, which force is called the *dynamic unit*. Hence if an animal, as a horse, for example, is

able to raise 33,000 pounds one foot high in a minute, he must exert a force 33,000 times greater than that required to raise one pound through the same space in the same time. Of the different modes of estimating human strength, the most practically useful is the observation of the average effect produced daily by a labourer, who continues his exertions for a number of successive days, as in transporting materials in a wheel-barrow, carrying a load, or dragging a load, working a pump, turning a winch, ringing a bell, rowing a boat, &c. On comparing the strength of men in different countries it has been found that the English are the strongest.—2. Firmness; solidity or toughness; the quality of bodies by which they sustain the application of force without breaking or yielding. Thus we speak of the *strength* of a bone, the *strength* of a beam, the *strength* of a wall, the *strength* of a rope. In this sense, *strength* is a passive quality, and is opposed to *weakness* or *frangibility*. In *mech.*, the strength of materials is the resistance which bodies oppose to a force acting on them. This resistance can only be ascertained by experiment. [*See MATERIAL, STRAIN, STRESS.*] The strength of bodies depends on their magnitude, form, and position, as well as on the degree of cohesion in the material.—3. Power or vigour of any kind.

This act

Shall crush the *strength* of Satan. *Milton.*  
*Strength* there must be either of love or war.

Holiday.

4. Power of resisting attacks; fastness; as, the *strength* of a castle or fort.—5. Support; that which supports; that which supplies strength; security.

God is our refuge and *strength*; *Ps. xlv.*

6. Power of mind; intellectual force; the power of any faculty; as, *strength* of memory; *strength* of reason; *strength* of judgment.—7. Spirit; animation.

Methinks I feel new *strength* within me rise.

Milton.

8. Force of writing; vigour; nervous diction. The *strength* of words, of style, of expression, and the like, consists in the full and forcible exhibition of ideas, by which a sensible or deep impression is made on the mind of a hearer or reader. It is distinguished from *softness* or *sweetness*. *Strength* of language enforces an argument, produces conviction, or excites wonder or other strong emotion; *softness* and *sweetness* give pleasure.

And praise the easy vigour of a line,  
Where Denham's *strength* and Waller's  
sweetness join. *Pope.*

9. Vividness; as, *strength* of colours or colouring.—10. Spirit; the quality of any liquor which has the power of affecting the taste, or of producing sensible effects on other bodies; as, the *strength* of wine or spirit; the *strength* of an acid.—11. The virtue or spirit of any vegetable, or of its juices or qualities.—12. Legal or moral force; validity; the quality of binding, uniting, or securing; as, the *strength* of social or legal obligations; the *strength* of law; the *strength* of public opinion or custom.—13. Vigour; natural force; as, the *strength* of natural affection.—14. That which supports; confidence.

The allies, after a successful summer, are too apt upon the *strength* of it to neglect preparation for the ensuing campaign.

Addison.

15. Amount of force, military or naval; an army or navy; number of troops or ships well appointed. What is the *strength* of the enemy by land, or by sea?—16. Soundness; force; the quality that convinces, persuades, or commands assent; as, the *strength* of an argument or of reasoning; the *strength* of evidence.—17. Vehemence; force proceeding from motion and proportioned to it; as, the *strength* of wind or a current of water.—18. Degree of brightness or vividness; as, the *strength* of light.—19. † Fortification; fortress; as, an inaccessible *strength*.—20. Support; maintenance of power.

What they boded would be a mischief to us, you are providing shall be one of our principal *strengths*. † *Sprat.*

**STRENGTH**, † *v. t.* To strengthen.  
**STRENGTHEN**, *v. t.* (strength 'n.) To make strong or stronger; to add strength to, either physical, legal, or moral; as, to *strengthen* a limb; to *strengthen* an obligation.—2. To confirm; to establish; as, to *strengthen* authority.—3. To animate; to encourage; to fix in resolution.

Charge Joshua, and encourage him, and *strengthen* him; *Deut. iii.*

4. To cause to increase in power or security.

Let noble Warwick, Cobham, and the rest,  
With powerful policy *strengthen* themselves. *Shak.*

**STRENGTH'EN**, *v. i.* To grow strong or stronger.

The disease that shall destroy all length,  
Grows with his growth, and *strengthens*  
with his strength. *Pope.*

**STRENGTH'ENED**, *pp.* Made strong or stronger; confirmed.

**STRENGTH'ENER**, *n.* That which increases strength, physical or moral.—2. In *med.*, something which, taken into the system, increases vital energy and strength of action.

**STRENGTH'ENING**, *ppr.* Increasing strength, physical or moral; confirming; animating.

**STRENGTH'LESS**, *a.* Wanting strength; destitute of power.—2. Wanting spirit. [*Little used.*]

**STRENUOUS**, *a.* [*L. strenuus; It. strenuo; W. tren, force, also impetuous.*] The sense is pressing, straining, or rushing forward.] 1. Eagerly pressing or urgent; zealous; ardent; as, a *strenuous* advocate for national rights; a *strenuous* opposer of African slavery.—2. Bold and active; valiant, intrepid, and ardent; as, a *strenuous* defender of his country.

**STRENUOUSLY**, *adv.* With eager and pressing zeal; ardently.—2. Boldly; vigorously; actively.

**STRENUOUSNESS**, *n.* Eagerness; earnestness; active zeal; ardour in pursuit of an object, or in opposition to a measure.

**STREP'ENT**, *a.* [*L. strepens, strepo.*] Noisy; loud. [*Little used.*]

**STREP'EROUS**, *a.* [*L. strepo.*] Loud; boisterous. [*Little used.*]

**STREPITO'SO**. [*It.*] In *music*, a term denoting that the part to which it is prefixed is to be performed in an impetuous and boisterous style.

**STREPSIP'TERA**, } *n.* [*Gr. στρεπτος, streptos, a wing.*] Kirby's name for an order of parasitic insects, having two elytriform sub-spiral organs, appendages of the base of the anterior legs.

**STRESS**, *n.* [*W. trais, force, violence, oppression; treissau, to force or drive;*

*Ir. treise*, force; *Arm. tręzen*, a twist; *trozeta, trouezal*, to *trug*, *Fr. trousseur*. Hence, *distress*, *tristle*, &c.] 1. Force; urgency; pressure; importance; that which bears with most weight; as, the *stress* of a legal question. Consider how much *stress* is laid on the exercise of charity in the New Testament.

This, on which the great *stress* of the business depends. *Locke.*

2. Force or violence; as, *stress* of weather.—3. Force; violence; strain. Though the faculties of the mind are improved by exercise, yet they must not be put to a *stress* beyond their strength.

*Locke.*

4. In *mech.*, stress and strain are terms used indiscriminately to express the force which is exerted in any part of a machine or structure of any kind, tending to break it in that part. Thus every part of a rope is equally strained by the weight which it supports. Every part of a column is equally strained by the load which it supports. A mill axle is equally twisted and strained in every part which lies between the part of the wheel actuated by the moving power, and the part which is resisted by the work to be performed. Every part of a lever or joist is differently strained by a force acting on a distant part. No structure can be made fit for its purpose unless the strength at every part be at least equal to the stress laid on or the strain excited in that part. Hence, in the erection of any machine or structure, it is necessary to ascertain the strains to which the different parts are exposed, and also to determine the strength of the materials which it is necessary to oppose in every part to these strains, and how to oppose this strength in such a manner that it shall be exerted to the best advantage.

**STRESS**, *v. t.* To press; to urge; to distress; to put to difficulties. [*Little used.*]

**STRETCH**, *v. t.* [*Sax. streccan*; *G. strecken*; probably formed on the root of *reach*, *right*, *L. rego*, &c.] 1. To draw out to greater length; to extend in a line; as, to *stretch* a cord or a rope.—2. To extend in breadth; as, to *stretch* cloth.—3. To spread; to expand; as, to *stretch* the wings.—4. To reach; to extend.

*Stretch* thine hand to the poor. *Eccles.*

5. To spread; to display; as, to *stretch* forth the heavens.—6. To draw or pull out in length; to strain; as, to *stretch* a tendon or muscle.—7. To make tense; to strain.

So the *stretch'd* cord the shackled dancer tries. *Smith.*

8. To extend mentally; as, to *stretch* the mind or thoughts.—9. To exaggerate; to extend too far; as, to *stretch* the truth; to *stretch* one's credit.

**STRETCH**, *v. i.* To be extended; to be drawn out in length or in breadth, or both. A wet hempen cord or cloth contracts; in drying, it *stretches*.—2. To be extended; to spread; as, a lake *stretches* over a hundred miles of earth. Lake Erie *stretches* from Niagara nearly to Huron. Hence.—3. To *stretch* to, is to reach.—4. To be extended or to bear extension without breaking; as elastic substances.

The inner membrane...because it would *stretch* and yield, remained unbroken. *Boyle.*

5. To sally beyond the truth; to exaggerate. A man who is apt to *stretch*,

has less credit than others.—6. In *navigation*, to sail; to direct a course. It is often understood to signify to sail under a great spread of canvas close hauled. In this it differs from *stand*, which implies no press of sail. We were *standing* to the east, when we saw a ship *stretching* to the southward.

—7. To make violent efforts in running. **STRETCH**, *n.* Extension in length or in breadth; reach; as, a great *stretch* of wings.—2. Effort; struggle; strain.

Those put lawful authority upon the *stretch* to the abuse of power, under colour of prerogative. *L'Estrange.*

3. Force of body; straining.

By *stretch* of arms the distant shore to gain. *Dryden.*

4. Utmost extent of meaning.

Quotations in their utmost *stretch*, can signify no more than that Luther lay under severe agonies of mind. *Atterbury.*

5. Utmost reach of power.

This is the utmost *stretch* that nature can. *Grannville.*

6. In *sailing*, a tack; the reach or extent of progress on one tack.—7. Course; direction; as, the *stretch* of seams of coal.

**STRETCH'ANT**, *ppr.* In *her.*, *stretching*, a term applied to beasts upon their legs, but stretching themselves out.

**STRETCH'ED**, *pp.* Drawn out in length; extended; exerted to the utmost.—*Stretched out*, in *arch.*, a term applied to a surface that will just cover a body so extended that all its parts are in a plane, or may be made to coincide with a plane.

**STRETCH'ER**, *n.* He or that which stretches.—2. In *arch.*, a brick or stone laid horizontally with its length in the direction of the face of the wall. It is thus distinguished from a header, which is laid lengthwise across the thickness of the wall, so that its small head or end is seen in the external face of the wall. [*See BEND.*].—3. A piece of timber in building.—4. A narrow piece of plank placed across a boat for the rowers to set their feet against.—5. A flat board on which corpses are *stretched*, previously to confining.

**STRETCH'ING**, *ppr.* Drawing out in length; extending; spreading; exerting force.

**STRETCH'ING COURSE**, *n.* In *arch.*, a course of stretchers; that is, of stones or bricks laid horizontally with their lengths in the direction of the face of the wall. [*See HEADING COURSE.*]

**STRETCH'ING MACHINE**, *n.* A machine in which cotton goods and other textile fabrics are stretched, by which means all their warp and woof yarns are laid in truly parallel directions.

**STRET'TO**. [*Ital.*] In *music*, a term which signifies that the movement to which it is prefixed is to be performed in a quick, concise manner. Opposed to *largo*.

**STREW**, *v. t.* [*Goth. strawan*; *Sax. streawian, streowian*; *G. streuen*; *Sw. strö*; contracted from *stragan*, which is retained in the Saxon. The Latin has *sterno, stravi*; the latter is our *strew, straw*. This verb is written *straw, strew, or strow*; *straw* is nearly obsolete, and *strow* is obsolescent. *Strew* is generally used.] 1. To scatter; to spread by scattering; always applied to dry substances separable into

parts or particles; as, to *strew* seed in beds; to *strew* sand on or over a floor; to *strew* flowers over a grave.—2. To spread by being scattered over.

The snow which does the top of Pindus *strews*.

*Spenser.*

Is thine alone the seed that *strews* the plain?

*Pope.*

3. To scatter loosely.

And *strew'd* his mangled limbs about the field. *Dryden.*

**STREW'ED**, *pp.* Scattered; spread by scattering; as, sand *strewed* on paper.—2. Covered or sprinkled with something scattered; as, a floor *strewed* with sand.

**STREW'ING**, *ppr.* Scattering; spreading over.

**STREW'ING**, *n.* The act of scattering or spreading over.—2. Any thing fit to be *strewed*.

**STREW'MENT**, *n.* Any thing scattered in decoration.

**STR'Æ**, *n. plur.* [*L. stria*, a streak.] In *nat. his.*, fine thread-like lines or streaks, generally on the exterior surface of shells, minerals, plants, or other objects, longitudinal, transverse, or oblique.—2. In *arch.*, the fillets which separate the channels or flutes of columns.

**STR'iated**, } *a.* Formed with small  
**STR'iated**, } channels; channelled.

—2. In *bot.*, streaked; marked or scored with superficial or very slender lines; marked with fine parallel lines; as the stems of some plants.—3. In *arch.*, channelled; fluted as a column.—*Striated fracture*, in *mineral.*, consists of long narrow separable parts laid on or beside each other.

**STR'iation**, *n.* The state of being striated, or marked with fine parallel lines.

**STR'ATURE**, *n.* Disposition of striae. **STRICK**, *n.* [*Gr. στρίξις*, *L. strix*, a screech-owl.] A bird of ill omen.

**STRICK'EN**, *pp.* of *Strike*. Struck; smitten; as, the *stricken* deer. [*See STRIKE.*].—2. Advanced; worn; far gone.

Abraham was old and well *stricken* in age; *Gen. xxiv.* [*Öör.*]

**STRICK'LE**, *n.* [*from strike.*] A strike; an instrument to strike grain to a level with the measure.—2. An instrument for whetting scythes.

**STR'ICT**, *a.* [*L. strictus*, from *stringo*; *Sax. strac*. *See STRAIN.*] 1. Strained; drawn close; tight; as, a *strict* embrace; a *strict* ligature.—2. Tense; not relaxed; as, a *strict* or lax fibre.—3. Exact; accurate; rigorously nice; as, to keep *strict* watch. Observe the strictest rules of virtue and decorum.—4. Severe; rigorous; governed or governing by exact rules; observing exact rules; as, the father is very *strict* in observing the sabbath. The master is very *strict* with his apprentices.—5. Rigorous; not mild or indulgent; as, *strict* laws.—6. Confined; limited; not with latitude; as, to understand words in a *strict* sense.

**STR'ICT'LY**, *adv.* Closely; tightly.—2. Exactly; with nice accuracy; as, patriotism *strictly* so called, is a noble virtue.—3. Positively. He commanded his son *strictly* to proceed no further.—4. Rigorously; severely; without remission or indulgence.

Examine thyself *strictly*, whether thou didst not best at first. *Bacon.*

**STR'ICTNESS**, *n.* Closeness; tightness; opposed to *laxity*.—2. Exact-

ness in the observance of rules, laws, rites, and the like; rigorous accuracy; nice regularity or precision.

I could not grant too much or distrust too little, to men that pretended singular piety and religious *strictness*. *K. Charles*.

2. Rigour; severity.

These commissioners proceeded with such *strictness* and severity as did much obscure the king's mercy. *Bacon*.

**STRIC'TURE**, *n.* [*L. strictura*. See **STRIKE** and **STROKE**, which unite with *L. stringo*.] 1. A stroke; a glance; a touch.—2. A touch of criticism; critical remark; censure.

I have given myself the liberty of these *strictures* by way of reflection on every passage. *Hammond*.

3. A drawing; a spastic or other morbid contraction of some tube or duct of the body; as the œsophagus, intestines, urethra, vagina, &c. It is either *organic*, that is, accompanied with an actual thickening of the walls of the canal; or *spasmodic*.

**STRIDE**, *n.* [*Sax. stræde*, a step; *gestridan*, to stride; *bestridan*, to bestride; probably formed on the root of *L. gradior*, Shemitic דרדא, *redah*, in Syr. to go, Ch. to spread, *Sax. stredan*, id.] A long step; a step taken with violence; a wide stretch of the legs.

Her voice theatrically loud,  
And masculine her *stride*. *Swift*.

**STRIDE**, *v. i.* pret. *Strid*, *Stroke*; pp. *Strid*, *Stridden*. 1. To walk with long steps.

Mars in the middle of the shining shield  
Is grav'd, and *strides* along the field. *Dryden*.

2. To straddle.

**STRIDE**, *v. t.* To pass over at a step.

See him *stride*  
Valleys wide. *Arbutnot*.

**STRIDING**, *ppr.* Walking with long steps; passing over at a step.

**STRIDOR**, *n.* [*L.*] A harsh creaking noise, or a crack.—*Stridor dentium*, [*L.*] grinding of the teeth. A common symptom during sleep in children affected with worms, or other intestinal irritation. It occurs also in fevers as a symptom of irritation of the brain.

**STRID'ULOUS**, *a.* [*L. stridulus*.] Making a small harsh sound or a creaking.

**STRIFE**, *n.* [*Norm. estrif*. See **STRIFE**.] 1. Exertion or contention for superiority; contest of emulation, either by intellectual or physical efforts. *Strife* may be carried on between students or between mechanics.

Thus gods contended, noble *strife*,  
Who most should ease the wants of life. *Congreve*.

2. Contention in anger or enmity; discord; contest; struggle for victory; quarrel or war.

I and my people were at great *strife* with the children of Ammon; Judges xii.  
These vows thus granted, raised a *strife* above,

Betwixt the god of war and queen of love. *Dryden*.

3. Opposition; contrariety; contrast.

Artificial *strife*  
Lives in these touches livelier than life. *Shak*.

4. The agitation produced by different qualities; as, the *strife* of acid and alkali. [*Little used*.]

**STRIFEFUL**, *a.* Contentious; discordant.

The ape was *strife*ful, and ambitious,  
And the fox guileful and most covetous. *Spenser*.

**STRIG'Æ**, *n. plur.* [*L.*] In *bot.*, a species of pubescence in plants, consisting of little close-pressed, rigid, unequal, irregular hairs.—2. In *arch.*, the flutings of a column.

**STRIG'IDÆ**, *n.* [from *strig*, one of the genera.] A family of nocturnal birds of prey, comprehending the owls.

**STRIG'IL**, *n.* [*L.*] Among the *ancients*, a little instrument of ivory or horn used for rubbing the skin.

**STRIG'MENT**, *n.* [*L. strigmentum*, from *stringo*.] Scraping; that which is scraped off.

**STRIG'OSE**, *a.* [*L. strigosus*, from *stringo*.] *strig*ous. In *bot.*, having strigæ; a *strigos* leaf is one set with stiff lanceolate bristles.

**STRIKE**, *v. t.* pret. *Struck*; pp. *Struck* and *Stricken*; but *Struck* is in the most common use. *Strook* is wholly obsolete. [*Sax. astrican*, to strike, *D. stryken*, to strike, and to *stroke*, to smooth, to anoint or rub over, to slide; *G. streichen*, to pass, move, or ramble, to depart, to touch, to *stroke*, to glide or glance over, to lower or *strike*, as sails, to curry, [*L. stringo, strigil*], to sweep together, to spread, as a plaster, to play on a violin, to card, as wool, to *strike* or whip, as with a rod; *streich, strich*, a stroke, stripe, or lash, *Eng. streak*; *Dan. streg*, a stroke; *stryger*, to rub, to *stroke*, to *strike*, to trim, to iron or smooth, to *strike*, as sails, to whip, to play on a violin, to glide along, to plane; *Sw. stryha*, id. We see that *strike, stroke*, and *streak*, and the *L. stringo*, whence *strain, strict, stricture*, &c., are all radically one word. *Strong* is of the same family. Hence we see the sense is to rub, to scrape; but it includes often the sense of thrusting.

It is to touch or graze with a sweeping or stroke. Hence our sense of *striking* a measure of grain, and *strike, strickle*, and a *stroke* of the pencil in painting. Hence the use of *stricken* applied to age, worn with age, as in the *L. strigo*, the same word differently applied. Hence also we see the propriety of the use of *stricture*, applied to criticism. It seems to be formed on the root of *rake* and *stretch*.] 1. To touch or hit with some force, either with the hand or an instrument; to give a blow to, either with the open hand, the fist, a stick, club, or whip, or with a pointed instrument, or with a ball or an arrow discharged. An arrow *struck* the shield; a ball *strikes* a ship between wind and water.

He at Philippi kept  
His sword e'en like a dancer, while I *struck*  
The lean and wrinkled Cassius. *Shak*.

2. To dash; to throw with a quick motion.

They shall take of the blood, and *strike*  
it on the two side posts; Exod. xii.

3. To stamp; to impress; to coin; as, to *strike* coin at the mint; to *strike* sovereigns.—4. To thrust in; to cause to enter or penetrate; as, a tree *strikes* its root deep.—5. To punish; to afflict; as *smite* is also used.

To punish the just is not good, nor to *strike* princes for equity; Prov. xvii.

6. To cause to sound; to notify by sound; as, the clock *strikes* twelve; the drums *strike* up a march.—7. In *seamanship*, to lower; to let down; as, to *strike* sail; to *strike* a flag or ensign; to *strike* a yard or top-mast in a gale; [that is, to run or slip down.]

When a ship in a fight, or on meeting with a ship of war, lets down or lowers

her top-sails, at least half-mast high, she is said to *strike*, which means that she yields, or submits or pays respect to the ship of war. Also, when a ship touches ground in shoal water, she is said to *strike*. And when a top-mast, &c., is to be taken down, the word of command is *strike the top-mast*, &c.

To *strike soundings*, to ascertain the depth of water with the hand-lead, &c.

—8. To impress strongly; to affect sensibly with strong emotion; as, to *strike* the mind with surprise; to *strike* with wonder, alarm, dread, or horror.

Nice works of art *strike* and surprise us most on the first view. *Atterbury*.

They please as beauties, here as wonders *strike*. *Pope*.

9. To make and ratify; as, to *strike* a bargain, *L. fœdus ferire*. This expression probably arose from the practice of the parties striking a victim when they concluded a bargain.—10. To produce by a sudden action.

Waving wide her myrtle wand,  
She *strikes* a universal peace through sea  
and land. *Milton*.

11. To affect in some particular manner by a sudden impression or impulse; as, the plan proposed *strikes* me favourably; to *strike* one dead; to *strike* one blind; to *strike* one dumb.—12. To level a measure of grain, salt, or the like, by scraping off with a straight instrument what is above the level of the top.—13. To be advanced or worn with age; *used in the participle*; as, he was *stricken* in years or age; well *struck* in years.—14. To run on; to ground; as a ship.—To *strike up*, to cause to sound; to begin to beat.

*Strike up* the drums. *Shak*.

2. To begin to sing or play; as, to *strike up* a tune.—To *strike off*, to erase from an account; to deduct; as, to *strike off* the interest of a debt.—

2. To impress; to print; as, to *strike off* a thousand copies of a book.—3. To separate by a blow or any sudden action; as, to *strike off* a man's head with a scimitar; to *strike off* what is superfluous or corrupt.—To *strike out*, to produce by collision; to force out; as, to *strike out* sparks with steel.—2. To blot out; to efface; to erase.

To methodize is as necessary as to *strike out*. *Pope*.

3. To form something new by a quick effort; to devise; to invent; to contrive; as, to *strike out* a new plan of finance.—To *strike a tent*, to loosen the cords of a tent for the purpose of removing it.

**STRIKE**, *v. i.* To make a quick blow or thrust.

It pleas'd the king  
To *strike* at me upon his misconstruction. *Shak*.

2. To hit; to collide; to dash against; to clash; as, a hammer *strikes* against the bell of a clock.—3. To sound by percussion; to be *struck*. The clock *strikes*.—4. To make an attack.

A puny subject *strikes*  
At thy great glory. *Shak*

5. To hit; to touch; to act on by impulse.

Hidden light from *striking* on it, and its colours vanish. *Locke*.

6. To sound with blows.

Whilst any trump did sound, or drum *struck*  
up. *Shak*.

7. To run upon; to be stranded. The ship *struck* at twelve, and remained

fast.—8. To pass with a quick or strong effect; to dart; to penetrate.

Now and then a beam of wit or passion strikes through the obscurity of the poem.

*Dryden.*

9. To lower a flag or colours in token of respect, or to signify a surrender of the ship to an enemy.—10. † To break forth; as, to *strike* into reputation.—*To strike in*, to enter suddenly; also, to recede from the surface, as an eruption; to disappear.—*To strike in with*, to conform to; to suit itself to; to join with at once.—*To strike out*, to wander; to make a sudden excursion; as, to *strike out* into an irregular course of life.—*To strike*, among *workmen*, is to quit work in a body, or by combination, in order to compel their employers to raise their wages.

**STRIKE**, *n.* An instrument with a straight edge for levelling a measure of grain, salt, and the like, for scraping off what is above the level of the top; a strickle.—2. A bushel; four pecks. [*Local.*]—3. A measure of four bushels or half a quarter. [*Local.*]—4. Among *workmen*, the act of quitting work in a body, after having demanded higher wages, and having been refused. In such a case the workmen refuse to resume their work, until their demand shall have been complied with, reckoning that their employer or employers, from the necessity of having the work carried on or completed, will at length be obliged to yield, especially as it frequently happens that other hands cannot be procured, either from their scarcity, or from the threats and intimidations of the body that has *struck*.—5. In *geol.*, the direction or line of bearing of strata, which is always at right angles to their prevailing dip.—*Strike of flax*, a handful that may be huddled at once. [*Local.*]

**STRIKE**, *a.* This word is used, as an epithet, only in the compound term *strike-measure*; that is, the employment of a *strike*, or roller, to remove or strike off all of an article measured which stands above the level or rim of a measure of capacity.—*Strike* is now the only legal measure of that kind, *heaped* measure having been discontinued in 1834-5.

**STRIKE-BLOCK**, *n.* [*strike* and *block*.] A plane shorter than a jointer, used for shooting a short joint.

**STRIKER**, *n.* One that strikes, or that which strikes.—2. In *Scrp.*, a quarrelsome man; *Tit. i.*

**STRIKING**, *ppr.* Hitting with a blow; impressing; imprinting; punishing; lowering, as sails or a mast, &c.—2. *a.* Affecting with strong emotions; surprising; forcible; impressive; as, a *striking* representation or image.—3. Strong; exact; adapted to make impression; as, a *striking* resemblance of features.

**STRIK'ING**, *n.* In *arch.*, the drawing of lines on the surface of a body; the drawing of lines on the face of a piece of stuff for mortises, and cutting the shoulders of tenons. In *joinery*, the act of running a moulding with a plane.—*The striking of a centre*, is the removal of the timber framing, upon which an arch is built after its completion.

**STRIKINGLY**, *adv.* In such a manner as to affect or surprise; forcibly; strongly; impressively.

**STRIKINGNESS**, *n.* The quality of affecting or surprising.

**STRING**, *n.* [Sax. *string*; G. *strang*; also Dan. *strikke*; G. *strick*; connected with *strong*, L. *stringo*, from drawing, stretching; Ir. *srang*, a string; *sreangaim*, to draw.] 1. A small rope, line, or cord, or a slender strip of leather or other like substance, used for fastening or tying things.—2. A ribbon. Round Ormond's knee thou ty'st the mystic strings. *Prior.*

3. A thread on which anything is filed; and hence, a line of things; as, a *string* of shells or beads.—4. The cord of a musical instrument, as of a harpsichord, harp, or violin; as, an instrument of ten strings.—5. A fibre, as of a plant.

Duck weed putteth forth a little string into the water, from the bottom. *Bacon.*

6. A nerve or tendon of an animal body.

The string of his tongue was loosed; Mark vii.

[This is not a technical word.]-7. The line or cord of a bow.

He twangs the quiv'ring string. *Pope.*

8. A series of things connected or following in succession; any concatenation of things; as, a *string* of arguments; a *string* of propositions.—9. In *ship-building*, the highest range of planks in a ship's ceiling, or that between the gunwale and the upper edge of the upper deck ports.—10. The tough substance that unites the two parts of the pericarp of leguminous plants; as, the *strings* of beans.—*To have two strings to the bow*, to have two expedients for executing a project or gaining a purpose; to have a double advantage, or to have two views. [*In the latter sense, unusual.*]

**STRING**, *v. t. pret.* and *pp.* *Strung.* To furnish with strings.

Has not wise nature strung the legs and feet? *Gay.*

2. To put in tune a stringed instrument.

For here the muse so oft her harp has strung. *Addison.*

3. To file; to put on a line; as, to *string* beads or pearls.—4. To make tense; to strengthen.

Toil strung the nerves, and purified the blood. *Dryden.*

5. To deprive of strings; as, to *string* beans.

**STRING'-BOARD**, **STRING'-PIECE**, or **STRING'-ER**, *n.* In *arch.*, a board placed next to the well-hole in wooden stairs, and terminating the ends of the steps.

**STRING-COURSE**, *n.* In *arch.*, a narrow moulding or projecting course continued horizontally along the face of a building, frequently under windows. It is sometimes merely a flat band.

**STRING'ED**, *a.* Having strings; as, a *stringed* instrument.—2. Produced by strings; as, *stringed* noise.

**STRIN'GENCY**, *n.* State of being stringent.

**STRIN'GENT**, *a.* [L. *stringens*.] Binding; contracting; tense; drawn tight.—2. Severe; rigid.

**STRIN'GENT**, *a.* [L. *stringens*.] Binding; strict; as, *stringent* rules.—2. † Astrigent.

**STRIN'GENTLY**, *adv.* In a stringent manner.

**STRIN'GENTNESS**, *n.* Stringency. [*The latter is the better word.*]

**STRIN'GER**, *n.* One who arranges on a string, or thread; as, a bead or pearl stringer.

**STRING'HALT**, *n.* [*string* and *halt*.]

A sudden twitching of the hinder leg of a horse, or an involuntary or convulsive motion of the muscles that extend or bend the hough.

**STRING'INESS**, *n.* The state of being stringy; fibrous.

**STRING'ING**, *ppr.* Furnishing with strings; putting in tune; filing; making tense; depriving of strings.

**STRING'LESS**, *a.* Having no strings. His tongue is now a *stringless* instrument. *Shak.*

**STRING'Y**, *a.* Consisting of strings or small threads; fibrous; filamentous; as, a *stringy* root.—2. Ropy; viscid; gluey; that may be drawn into a thread.

**STRIP**, *v. t.* [G. *streifen*, to strip, to flay, to strip or streak, to graze upon, to swerve, ramble, or stroll; D. *streepen*, to strip, to reprimand; Dan. *striber*, to stripe or streak, and *stripper*, to strip, to skin or flay, to ramble; Sax. *bestrypan*. Some of the senses of these verbs seem to be derived from the noun *stripe*, which is probably from *stripping*. Regularly, this verb should be referred to the root of *rip*, L. *rapio*.]

1. To pull or tear off, as, a covering; as, to *strip* the skin from a beast; to *strip* the bark from a tree; to *strip* the clothes from a man's back.—2. To deprive of a covering; to skin; to peel; as, to *strip* a beast of his skin; to *strip* a tree of its bark; to *strip* a man of his clothes.—3. To deprive; to bereave; to make destitute; as, to *strip* a man of his possessions.—4. To divest; as, to *strip* one of his rights and privileges. Let us *strip* this subject of all its adventitious glare.—5. To rob; to plunder; as, robbers *strip* a house.—6. To bereave; to deprive; to impoverish; as, a man *stripped* of his fortune.—7. To deprive; to make bare by cutting, grazing or other means; as, cattle *strip* the ground of its herbage.—8. In *America*, to pull off husks; to husk; as, to *strip* maize, or the ears of maize.—9. To press out the last milk at a milking.—10. To unrig; as, to *strip* a ship.—11. To pare off the surface of land in strips, and turn over the strips upon the adjoining surface.—*To strip off*, to pull or take off; as, to *strip off* a covering; to *strip off* a mask or disguise.—2. † To cast off.—3. † To separate from something connected. [We may observe the primary sense of this word is to peel or skin, hence to pull off in a long narrow piece; hence *stripe*.]

**STRIP**, *n.* [G. *streif*, a stripe, a streak; D. *streep*, a stroke, a line, a stripe; Dan. *stribe*.] 1. A narrow piece, comparatively long; as, a *strip* of cloth.

**STRIPE**, *n.* [See **STRIP**.] It is probable that this word is taken from *stripping*.] 1. A line or long narrow division of anything, of a different colour from the ground; as, a *stripe* of red on a green ground; hence, any linear variation of colour.—2. A strip or long narrow piece attached to something of a different colour; as, a long *stripe* sewed upon a garment.—3. The wale or long narrow mark discoloured by a lash or rod.—4. A stroke made with a lash, whip, rod, strap, or scourge.

Forty stripes may he give him, and not exceed; Deut. xxv. [A blow with a club is not a *stripe*.]—5. Affliction; punishment; sufferings.

By his stripes are we healed; Is. liii.

**STRIPE**, *v. t.* To make stripes; to

form with lines of different colours; to variegate with stripes.—2. To strike; to lash. [Little used.]

STRIPED, *pp.* Formed with lines of different colours.—2. *a.* Having stripes of different colours.

STRIPING, *ppr.* Forming with stripes. STRIP'LING, *n.* [from *strip, stripe*]; primarily, a tall slender youth, one that shoots up suddenly.] A youth in the state of adolescence, or just passing from boyhood to manhood; a lad.

And the king said, Inquire thou whose son the stripling is; 1 Sam. xviii.

STRIP'PED, *pp.* Pulled or torn off; peeled; skinned; deprived; divested; made naked; impoverished.

STRIP'PEE, *n.* One that strips.

STRIP'PING, *ppr.* Pulling off; peeling; skinning; flaying; depriving; divesting.

STRIP'TINGS, *n.* The last milk drawn from a cow at a milking. [Local.]

STRIVE, *v. i. pret.* *Strove*; *pp.* *Striven*. [G. *streben*; formed perhaps on the Heb.  $\text{מָרַב}$ , *rub*. This word coincides in elements with *drive*, and the primary sense is nearly the same. See RIVAL.]

1. To make efforts; to use exertions; to endeavour with earnestness; to labour hard; applicable to exertions of body or mind. A workman strives to perform his task before another; a student strives to excel his fellows in improvement.

Was it for this that his ambition strove  
To equal Cesar first, and after Jove?

Cowley.

Strive with me in your prayers to God for me; Rom. xv.

Strive to enter in at the strait gate; Luke xiii.

2. To contend; to contest; to struggle in opposition to another; to be in contention or dispute; followed by *against* or *with* before the person or thing opposed; as, *strive against* temptation; *strive for* the truth.

My spirit shall not always *strive* with man; Gen. vi.

3. To oppose by contrariety of qualities. Now private pity *strive* with public hate, Reason with rage, and eloquence with fate.

Derham.

4. To vie; to be comparable to; to emulate; to contend in excellence.

Not that sweet grove

Of Daphne by Orontes, and the inspir'd Castalian spring, might with this paradise Of Eden *strive*.

Milton.

STRIVER, *n.* One that strives or contends; one who makes efforts of body or mind.

STRIVING, *ppr.* Making efforts; exerting the powers of body or mind with earnestness; contending.

STRIVING, *n.* The act of making efforts; contest; contention.

Avoid foolish questions, and genealogies, and contentions, and *strivings* about the law; Tit. iii.

STRIVINGLY, *adv.* With earnest efforts; with struggles.

STRIX, *n.* [L.] The owl; a Linnæan genus of nocturnal birds of the Accipitrine order, now divided into various sub-genera, according to their tufts, the size of their ears, the extent of the circle of feathers which surrounds their eyes, &c.; as *Otus*, *Syrnium*, *Bubo*, *Scops*, and *Noctua*. [See OWL.]—2. In *archæol.*, a channel in a fluted column or pillar.

STROAM, † *v. i.* [Ger. *strömen*, to stream,

flow, D. *stroomen*.] To flow on, or stream past; as, a crowd of people.

STROB'ILE, *n.* [L. *strobilus*.] In bot., an enlarged catkin, the



Section of Strobile.

carpels of which are scale-like, and spread open and bear naked seeds; sometimes the scales are thin, with little cohesion; but they are often woody, and cohere into a single tuberculated mass. Example, the cone or fruit of the pines.

STROBIL'IFORM, *a.* [L. *strobilus* and *forma*, supra.] Shaped like a strobile.

STRO'CAL, } *n.* An instrument used

STRO'KAL, } by glass-makers to empty the metal from one pot to another.

STROKE, } † for *Struck*.

STROOK, }

STROKE, *n.* [from *strike*.] A blow; a knock; the striking of one body against another; the act of one body upon another when brought suddenly into contact with it; applicable to a club, a hammer, a mallet, or to any heavy body, or to a rod, whip, or lash. A piece of timber falling may kill a man by its stroke; a man, when whipped, can hardly fail to flinch or wince at every stroke.

Th' oars were silver,  
Which to the time of flutes kept *stroke*.

Shak.

The force or intensity of a stroke is directly proportional to the velocity and quantity of matter or weight of the striking body, and to the sine of the angle of incidence, that is, the angle which the direction of the striking body makes with the surface of the body struck. Hence, the greatest effect is produced by a stroke when the angle of incidence is a right angle, or when the striking body is made to move in a direction perpendicular to the surface of the body struck.—2. A hostile blow or attack.

He entered and won the whole kingdom of Naples without striking a *stroke*. *Baron*.

3. A sudden attack of disease or affliction; calamity.

At this one *stroke* the man look'd dead in law. *Harte*.

4. Fatal attack; as, the *stroke* of death.

—5. The sound of the clock.

What is't o'clock?

Upon the *stroke* of four. *Shak*.

6. The touch of a pencil.

Oh, lasting as those colours may they shine,  
Free as thy *stroke*, yet faultless as thy line. *Pope*.

Some parts of my work have been brightened by the *strokes* of your lordship's pencil. *Middleton*.

7. A touch; a masterly effort; as, the boldest *strokes* of poetry.

He will give one of the finishing *strokes* to it. *Addison*.

8. An effort or effect suddenly or unexpectedly produced.—9. † Power; efficacy.

He has a great *stroke* with the reader, when he condemns any of my poems, to make the world have a better opinion of them. *Dryden*.

10. Series of operations; as, to do a great *stroke* of business. [Familiar.]—11. A dash in writing or printing; a line; a touch of the pen; as, a hair *stroke*.—12. In *seamen's* lan., the sweep of an oar; as, to row with a long *stroke*.—*Stroke* of the sun, a *coup de soleil*,—which see.

STROKE, *v. t.* [Sax. *stracan*. See STRIKE and STRICK.] 1. To rub gently with the hand by way of expressing kindness or tenderness; to soothe.

He dried the falling drops, and, yet more kind,

He *strook*'d her cheeks. *Dryden*.

2. To rub gently in one direction.—

3. To make smooth.—4. In *masonry*, to work the face of a stone in such a manner as to produce a sort of fluted surface.

STROKED, *pp.* Rubbed gently with the hand.

STROKER, *n.* One who strokes; one who pretends to cure by stroking.

STROKESMAN, *n.* In *rowing*, the man who rows the aftmost oar, and whose stroke is to be followed by the rest.

STROKING, *ppr.* Rubbing gently with the hand.

STROKING, *n.* The act of rubbing gently.—2. In *masonry*, an operation performed upon the face of a stone by the broad tool, by which a sort of fluted surface is produced.

STROKINGS, *n. plur.* The milk last drawn from the teats of a cow.—*To stroke the teats*, is to milk.

STROLL, *v. i.* [formed probably on *troll, roll*.] To rove; to wander on foot; to ramble idly or leisurly.

These mothers *stroll* to beg sustenance for their helpless infants. *Swift*.

STROLL, *n.* A wandering on foot; a walking idly and leisurly.

STROLLER, *n.* One who strolls; a vagabond; a vagrant; an itinerant player.

STROLLING, *ppr.* Roving idly; rambling on foot.

STROMAT'IC, *a.* [Gr.  $\sigma\tau\rho\mu\alpha\tau\iota\kappa\acute{o}\varsigma$ .] Miscellaneous; composed of different kinds.

STROMBIDÆ, *n.* A family of marine testaceous gastropods, of which the genus *Strombus*, Linn. is the type.

STROMBITE, *n.* A petrified shell of the genus *Strombus*.

STROMBUL'IFORM, *a.* [Gr.  $\sigma\tau\rho\mu\beta\upsilon\lambda\acute{o}\varsigma$ , a top.] In *geol.*, formed like a top.

STROMBUS, *n.* [L.] The name given by Linnæus to a genus of univalve, spiral, marine shells. The aperture is much dilated; the lip expanding and produced into a groove. In some of the shells of this genus, the spines are of great length, and are arranged round

the circumference of the base, being at first tubular, and afterwards solid, according to the period of growth. Only two species have been found in the seas of this country. Cuvier places this genus under his pectinibranchiate gastropods, and Lamarck divides it into two subgenera, *Strombus* proper, and *Pteroceras*.

STROM'EYERITE, *n.* [from the name of *Stromeyer*, the celebrated chemist.] A steel-gray ore of silver, consisting of sulphur, silver, and copper.

STROM'NITE, *n.* A mineral. [See BARYSTRONTIANITE.]

STROND, *n.* The beach. [See STRAND.]

Winged *Strombus* (*S. tricristatus*).

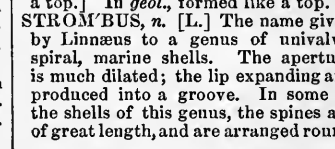

Winged Strombus (S. tricristatus).

the circumference of the base, being at first tubular, and afterwards solid, according to the period of growth. Only two species have been found in the seas of this country. Cuvier places this genus under his pectinibranchiate gastropods, and Lamarck divides it into two subgenera, *Strombus* proper, and *Pteroceras*.

STROM'EYERITE, *n.* [from the name of *Stromeyer*, the celebrated chemist.] A steel-gray ore of silver, consisting of sulphur, silver, and copper.

STROM'NITE, *n.* A mineral. [See BARYSTRONTIANITE.]

STROND, *n.* The beach. [See STRAND.]



**STRONG, a.** [Sax. *strong*, *strang*, or *streg*; from the latter is formed *strength*; G. *strenge*; D. and Dan. *streg*; Sw. *strång*, strict, severe, rigid. As *n* is casual in this word, the original orthography was *strag*, *streg*, or *strog*, coinciding with *L. strictus, stringo*. The sense of the radical word is to stretch, strain, draw, and probably from the root of *stretch* and *reach*. We observe in all the kindred dialects on the Continent, the sense of the word is somewhat different from that of the English. The Russ. *strogei*, strict, rigid, severe, retains the original orthography without *n*.] 1. Having physical active power, or great physical power; having the power of exerting great bodily force; vigorous. A patient is recovering from sickness, but is not yet *strong* enough to walk. A *strong* man will lift twice his own weight.

That our oxen may be *strong* to labour; Ps. cxliv.

Orses the *strong* to greater strength must yield. Dryden.

2. Having physical passive power; having ability to bear or endure; firm; solid; as, a constitution *strong* enough to bear the fatigues of a campaign:—3. Well fortified; able to sustain attacks; not easily subdued or taken; as, a *strong* fortress or town.—4. Having great military or naval force; powerful; as, a *strong* army or fleet; a *strong* nation; a nation *strong* at sea.—5. Having great wealth, means, or resources; as, a *strong* house or company of merchants.—6. Moving with rapidity; violent; forcible; impetuous; as, a *strong* current of water or wind; the wind was *strong* from the northeast; we had a *strong* tide against us.—7. Hale; sound; robust; as, a *strong* constitution.—8. Powerful; forcible; cogent; adapted to make a deep or effectual impression on the mind or imagination; as, a *strong* argument; *strong* reasons; *strong* evidence; a *strong* example or instance. He used *strong* language.—9. Ardent; eager; zealous; earnestly engaged; as, a *strong* partisan; a *strong* whig or tory.

Her mother, ever *strong* against that match. Shak.

10. Having virtues of great efficacy; or having a particular quality in a great degree; as, a *strong* powder or tincture; a *strong* decoction; *strong* tea; *strong* coffee.—11. Full of spirit; intoxicating; as, *strong* liquors.—12. Affecting the sight forcibly; as, *strong* colours.—13. Affecting the taste forcibly; as, the *strong* flavour of onions.—14. Affecting the smell powerfully; as, a *strong* scent.—15. Not of easy digestion; solid; as, *strong* meat; Heb. v.—16. Well established; firm; not easily overthrown or altered; as, a custom grown *strong* by time.—17. Violent; vehement; earnest.

Who in the days of his flesh, when he offered up prayers with *strong* crying and tears; Heb. v.

18. Able; furnished with abilities. I was *stronger* in prophecy than in criticism. Dryden.

19. Having great force of mind, of intellect, or of any faculty; as, a man of *strong* powers of mind; a man of a *strong* mind or intellect; a man of *strong* memory, judgment or imagination.—20. Having great force; com-

prising much in few words; forcibly expressed.

Like her sweet voice is thy harmonious song,

As high, as sweet, as easy, and as *strong*. Smith.

21. Bright; glaring; vivid; as, a *strong* light.—22. Powerful to the extent of force named; as, an army ten thousand *strong*.

**STRONG'-BACKED, a.** Having a strong back.

**STRONG'-COLOURED, a.** Having strong colours.

**STRONG'-GER, a.** comp. of *Strong*. Having more strength.

**STRONG'-GEST, a.** superl. of *Strong*. Having most strength.

**STRONG'-FISTED, a.** [*strong* and *fast*.] Having a strong hand; muscular.

**STRONG'-HAND, n.** [*strong* and *hand*.] Violence; force; power.

It was their meaning to take what they needed by *strong-hand*. Raleigh.

[*Not properly a compound word.*]

**STRONG'-HANDED, a.** Having strong hands, or having many hands for the execution of a work.

**STRONG'-HOLD, n.** [*strong* and *hold*.] A fastness; a fort; a fortified place; a place of security.

**STRONG'-ISH, a.** Somewhat strong. [*Colloq.*]

**STRONG'-LY, adv.** With strength; with great force or power; forcibly; a *word of extensive application*.—2. Firmly; in a manner to resist attack; as, a town *strongly* fortified.—3. Vehemently; forcibly; eagerly. The evils of this measure were *strongly* represented to the government.

**STRONG'-MINDED, a.** Having a vigorous mind.

**STRONG'-RIBBED, a.** Solidly formed; as, a *strong-ribbed* ship.

**STRONG'-SET, a.** [*strong* and *set*.] Firmly set or compacted.

**STRONG'-VOICED, a.** Having great strength of voice.

**STRONG'-WATER, † n.** [*strong* and *water*.] Distilled or ardent spirits.

**STRON'GYLUS, n.** A genus of intestinal worms in Rudolphi's classification, characterized by having a cylindrical body, the anal extremity of which, in the male, is surrounded by a kind of pouch of a varied shape, from which is protruded a small filament or spiculum. *S. armatus* infests the mesenteric arteries of the horse and ass, producing aneurisms. *S. gigas* is sometimes found in the kidney of the human subject.

**STRON'TIA, n.** One of the alkaline earths, of which *strontium* is the metallic base. It occurs in a crystalline state, as a carbonate, in the lead mines of Strontian, in Argyleshire, whence its name. It was discovered by Dr. Hope in 1792. It has subsequently been found in England, America, and France; but strontitic minerals are rather rare. The pure earth to which the name of strontia is given, is prepared from the carbonate exactly like baryta. It is a greyish white powder, infusible in the furnace; of a specific gravity approaching that of baryta, having an acrid burning taste, but not so corrosive as baryta, though sharper than lime. It becomes hot when moistened, and slakes into a pulverulent hydrate, dissolves in 150 parts of water at 60°, and in much less at the boiling point, forming an alkaline solution, called *strontia water*, which deposits

crystals in four-sided tables as it cools. The dry earth, which is an oxide of strontium, is composed of 44 equivalents of strontium, and 8 of oxygen. It is readily distinguished from baryta, by forming with hydrochloric acid a chloride which crystallizes in needles, and is very deliquescent, and soluble in alcohol, to which it gives the property of burning with a crimson flame. The sulphate of strontia is found native, and some of the native varieties have a pale blue tint, whence the term *celestine*. The nitrate of strontia is used in making the red fire of the theatres, and of fire-works; and it is also employed for signal lights.

**STRONTIAN, n.** A name sometimes given to strontia.

**STRONTIAN, } a.** Pertaining to  
**STRONTIANIC, }** strontia; containing strontia; as, *strontitic* minerals.

**STRONTIANITE, n.** Native carbonate of strontia, a mineral that occurs massive, fibrous, stellated, and crystallized in the form of a hexahedral prism, modified on the edges, or terminated by a pyramid. It was first discovered in the lead mines of Strontian, in Argyleshire. It greatly resembles carbonate of baryta, but it is not poisonous like that mineral.

**STRONTITES, n.** The name given to strontia by Dr. Hope, who first obtained this earth from strontianite, or native carbonate of strontia. This name was modified into strontia by Klaproth.

**STRONTIUM, n.** The metallic base of strontia, procured from the carbonate of strontia by Davy in 1808. It is analogous to barium, but has less lustre; it is heavier than sulphuric acid, difficultly fusible, and not volatile. When exposed to the air it attracts oxygen, and becomes converted into strontia, or protoxide of strontium; when thrown into water, it decomposes it with great violence, producing hydrogen gas, and forming with the water a solution of strontia. Strontium is harmless, while barium and all its compounds are poisonous.

**STROOK, †** for *Struck*.

**STROP, n.** A strap. [*See STRAP.*]

This orthography is particularly used for a strip of leather used for sharpening razors and giving them a fine smooth edge; a razor-strop.—2. [*Sp. estrovo.*] A piece of rope spliced into a circular wreath, and put round a block, so that the latter may be suspended from any particular part about the masts, yards, or rigging.

**STROP, v. t.** To sharpen with a strop or strap; as, he *stropped* his razor.

**STRO'PHE, n.** [*Fr. strophe*; Gr. *στροφή*, a turn, from *στρέφω*, to turn.] In *Greek poetry*, a division of a choral ode, answering to a stanza, and so named because the singers turned in one direction while they recited that portion of the poem; they then turned round and sung the next portion, which was of exactly the same length and metre as the preceding, and was termed the anti-strophe (*ἀντιστροφή*). [*See ANTISTROPHE.*] The choral poems of the Greeks consisted of three main parts, strophe, anti-strophe, and epode, the latter forming the concluding stanza of a chorus.

**STROPHIC, a.** Relating to, or consisting of, strophes.

**STROPHIOLATE, } a.** [*L. stro-*  
**STROPHIOLATED, }** *phium*, a garland.] Furnished with a garland, or

that which resembles a garland.—2. In *bot.*, having strophioles or caruncles, as seeds.

**STROPHIOLE**, *n.* [*L. strophiotum.*] In *bot.*, a little tubercular part near the base or hilum of some seeds, particularly those of the papilionaceous order. It is otherwise called a *caruncle*.

**STROPHULUS**, *n.* [*L.*] A papular eruption upon the skin, peculiar to infants, and exhibiting a variety of forms, known popularly as *red-gum*, *white-gum*, *tooth-rash*, &c.

**STROUT**, *v. i.* [*for strut.*] To swell; to puff out.

**STROVE**, *pret. of Strive.*  
**STROW**, is only a different orthography of *Strew*. [*See STREW.*]

**STROWL**, *for Stroll*, is not in use. [*See STROLL.*]

**STROY**, *for Destroy*, is not in use. [*See DESTROY.*]

**STRUCK**, *pret. and pp. of Strike.* [*See STRIKE.*]

**STRUCKEN**, *the old pp. of Strike*, is obsolete.

**STRUCTURAL**, *a.* Pertaining to structure.

**STRUCTURE**, *n.* [*Fr. from L. structura, from struo, [for strugo,] to set or lay; it. struttura.*] 1. Act of building; practice of erecting buildings.

His son builds on and never is content,  
Till the last farthing is in structure spent.  
[*Rarely used.*] *Dryden.*

2. Manner of building; form; make; construction; as, the want of insight into the structure and constitution of the terraqueous globe.—3. Manner of organization of animals and vegetables, &c.—4. A building of any kind, but chiefly a building of some size or of magnificence; an edifice. Waterloo bridge over the Thames, in London, is a beautiful structure.

There stands a structure of majestic frame.  
*Pope.*

5. In *mineral.*, the particular arrangement of the integrant particles or molecules of a mineral.

**STRÖDE**, *n.* A stock of breeding stöde; mares; a stud.

**STRUGGLE**, *v. i.* [This word may be formed on the root of *stretch*, *right*, &c., which signifies to strain; or more directly on the same elements in *L. rugo*, to wrinkle, and *Eng. wriggle*. In *W. ystreiglan*, is to turn.] 1. Properly, to strive, or to make efforts with a twisting or with contortions of the body. Hence,—2. To use great efforts; to labour hard; to strive; to contend; as, to *struggle* to save life; to *struggle* with the waves; to *struggle* against the stream; to *struggle* with adversity.—3. To labour in pain or anguish; to be in agony; to labour in any kind of difficulty or distress.

'Tis wisdom to beware,  
And better shun the bait than *struggle* in the snare.  
*Dryden.*

**STRUGGLE**, *n.* Great labour; forcible effort to obtain an object, or to avoid an evil; properly, a violent effort with contortions of the body.—2. Contest; contention; strife.

An honest man might look upon the struggle with indifference. *Addison.*

3. Agony; contortions of extreme distress.

**STRUGGLER**, *n.* One who struggles, strives, or contends.

**STRUGGLING**, *ppr.* Making great efforts; using violent exertions; affected with contortions.

**STRUGGLING**, *n.* The act of striving; vehement or earnest effort.

**STRULL**, *n.* A bar so placed as to resist weight.

**STRUMA**, *n.* [*L.*] Scrofula; the king's evil; a specific morbid condition, considered by many as a peculiar sort of inflammation, manifested, in very many cases, by an indolent glandular enlargement, which sometimes suppurates, but slowly and imperfectly, and heals with difficulty. The same term is also used to signify bronchocele, or an enlargement of the thyroid gland.—2. In *bot.*, a swelling in some leaves at the extremity of the petiole, where it is connected to the lamina; as in *Mimosa sensitiva*. Also, in mosses, a dilatation or swelling which is sometimes present upon one side of the base of the theca.

**STRUMOSE**, *a.* Scrofulous.—2. In **STRUMOUS**, *bot.*, having *strumæ*. [*See STRUMA.*]

**STRUMPET**, *n.* [*Ir. stribríd, stríopach.*] A prostitute.

**STRUMPET**, *a.* Like a strumpet; false; inconstant.

**STRUMPET**, *v. t.* To debauch.

**STRUNG**, *pret. of String.*

**STRUNT**, *v. i.* To walk sturdily; to walk with state; to strut. [*Scotch.*]

**STRUNT**, *n.* Spirituous liquor of any kind. Also a pet; a sullen fit. [*Scotch.*]

**STRUT**, *v. i.* [*G. stroten; Dan. strutter.*] 1. To walk with a lofty proud gait and erect head; to walk with affected dignity.

Does he not hold up his head and *strut* in his gait? *Shak.*

2. To swell; to protuberate.  
The belling canvas *strutted* with the gale. *Dryden.*

**STRUT**, *n.* A lofty proud step or walk with the head erect; affectation of dignity in walking.—2. In *arch.*, struts are oblique framing pieces having one end joined to the king posts, or queen posts, and the other end to the principal rafters, for the purpose of supporting the latter. They are sometimes called braces. [*See ROOF.*—3. Any piece of timber in a system of framing which is pressed or crushed in the direction of its length; as the struts of a roof or a gate.

**STRUTHIO**, *n.* The ostrich; a genus of birds of the order Gallatoræ, and family Struthionidæ, or Brevipennes. The *S. camelus* is the ostrich of the eastern Continent, celebrated from the earliest ages; the *S. casuarius* is the cassowary, common in the peninsula of Malacca and the islands of the Asiatic Archipelago; and the *S. rheia* is the American ostrich, common in South America, and one half smaller than the eastern species. [*See OSTRICH.*]

**STRUTHIONIDÆ**, *n.* [*L. struthio, an ostrich.*] A family of terrestrial birds incapable of flight, the wings being, in the majority of instances, merely rudimentary, but having long and strong legs, which enable them to run with great rapidity. This family includes the ostrich, and other congeneric species, which constitute the *Cursores* of Kirby and the *Brevipennes* of Cuvier.

**STRUTHIOUS**, *a.* [*L. struthio.*] Pertaining to or like the ostrich; belonging to the ostrich tribe.

**STRUTTER**, *n.* One who struts; a pompous fellow.  
**STRUTTING**, *ppr.* Walking with a lofty gait and erect head.

**STRUTTING**, *n.* The act of walking with a proud gait.

**STRUTTING-BEAM**, *n.* In *arch.* **STRUT-BEAM**, } an old term for a collar-beam.

**STRUTTINGLY**, *adv.* With a proud lofty step; boastingly.

**STRUTTING-PIECE**, *n.* In *arch.*, the same as straining-piece,—which see.

**STRYCHNIA**, *n.* [*Gr. στρυχνης, an ancient Greek name for several plants, most of which were narcotics.*] A vegetable alkaloid, the sole active principle of *Strychnos Treutæ*, the most active of the Java poisons, and one of the active principles of *Strychnos Ignatii*, *S. nux-vomica*, *S. colubrina*, &c. It is usually obtained from the seeds of *Strychnos nux-vomica*. It is colourless, inodorous, crystalline, unalterable by exposure to the air, and extremely bitter. It is very insoluble, requiring 7000 parts of water for solution. It dissolves in hot alcohol, although sparingly, if the alcohol be pure and not diluted. It forms crystallizable salts, which are intensely bitter. Strychnine and its salts, especially the latter, from their solubility, are most energetic poisons. They produce lockjaw and other tetanic affections, and are used in very small doses as remedies in paralysis. *Strychnia* is composed of 44 atoms of carbon, 23 of hydrogen, 2 of nitrogen, and 8 of oxygen.

**STRYCHNIC ACID**, *n.* An acid which exists in combination with strychnia in the *Strychnos nux-vomica*. It is soluble both in water and alcohol, and has an acid rough taste. It is also called Igasuric acid.

**STRYCHNOS**, *n.* A genus of plants, nat. order Apocynaceæ, section Strychnæ. It is composed of trees or shrubs which do not yield a milky juice, and have opposite, usually nerved leaves, and corymbose flowers; some of the species are possessed of tendrils, and are climbing plants. They are found principally in the tropical parts of Asia and America. *S. nux-vomica*, poison-nut or ratsbane. [*See NUX-VOMICA.*] *S. potatorum*, or clearing nut, is an abundant plant in the woods and mountains of the East Indies. The seeds, when dried, are sold by the natives for the purpose of clearing muddy water. *S. St. Ignatii*, or St. Ignatius's bean, is a native of Cochín China, the Philippine Islands, and other parts of Asia. [*See IGNATIUS'S BEAN.*] *S. colubrina*, snake-wood, or snake-poison nut, is a native of the coasts of Coromandel and of Silhet. It is considered by the Indian doctors as an effectual remedy for the bite of the cobra da capello. [*See SNAKE-WOOD.*] *S. ticuté*. [*See CHETTICK AND UPAS.*] *S. toxicifera*, woody, or poison-plant of Guiana, is used by the natives as an arrow-poison. *S. pseudo-quina*, is a native of Brazil. Its bark is said to be fully equal to cinchona in curing intermittent fevers. The fruit of this species is eaten by the native children.

**STUB**, *n.* [*Sax. steb; Dan. stub; Sw. stubbe, a stock or stem; L. stipes; from setting, fixing. See STOP.*] 1. The stump of a tree; that part of the stem of a tree which remains fixed in the earth when the tree is cut down.—2. † A log; a block.

**STUB**, *v. t.* To grub up by the roots; to extirpate; as, to *stub* up edible roots.  
**STUBBED**, *a.* Short and thick like

something truncated; blunt; obtuse. [Sw. *stubbj*.]—2. Hardy; not nice or delicate.

**STUB-BEDNESS**, *n.* Bluntness; obtuseness.

**STUB'ING**, *ppr.* Grubbing up by the roots; extirpating.

**STUB'BLE**, *n.* [D. and G. *stoppel*; Sw. *stubb*; L. *stipula*. It is a diminutive of *stub*.] The stumps of wheat, rye, barley, oats, or buckwheat, left in the ground; the part of the stalk left by the scythe or sickle.

After the first crop is off, they plough in the *stubble*. *Mortimer.*

**STUB'BLE-GOOSE**, *n.* [*stubble* and *goose*.] A goose fed among stubble.

**STUB'BLE-RAKE**, *n.* A rake with long teeth for raking together stubble.

**STUB'BORN**, *a.* [This word is doubtless formed on the root of *stub* or *stiff*, and denotes fixed, firm. Chaucer writes it *stibborne*, 6038. But the origin of the latter syllable is not obvious.] 1. Unreasonably obstinate; inflexibly fixed in opinion; not to be moved or persuaded by reasons; inflexible; as, a *stubborn* son; a *stubborn* mind or soul. The queen is obstinate...

*Stubborn* to justice. *Shak.*  
2. Persevering; persisting; steady; constant; as, *stubborn* attention.—3. Stiff; not flexible; as, a *stubborn* bow.

Take a plant of *stubborn* oak. *Dryden.*

4. Hardy; firm; enduring without complaint; as, *stubborn* Stoics.—5. Harsh; rough; rugged. [*Little used*.]—6. Refractory; not easily melted or worked; as, a *stubborn* ore or metal.—7. Refractory; obstinately resisting command, the goad, or the whip; as, a *stubborn* ass or horse.

**STUB'BORNLY**, *adv.* Obstinate; inflexibly; contumaciously.

**STUB'BORNNESS**, *n.* Perverse and unreasonable obstinacy; inflexibility; contumacy.

*Stubbornness* and obstinate disobedience must be mastered with blows. *Locke.*

2. Stiffness; want of pliancy.—3. Refractoriness, as of ores.

**STUB'BY**, *a.* [from *stub*.] Abounding with stubs.—2. Short and thick; short and strong; as, *stubby* bristles.

**STUB'-MORTYSE**, *n.* A mortise that does not pass through the timber mortised.

**STUB'-NAIL**, *n.* [*stub* and *nailed*.] A nail broken off; a short thick nail.

**STUC'CO**, *n.* [It. *id.*; Fr. *stuc*; allied probably to *stick, stuck*.] 1. A word applied as a general term to plaster of any kind, used as a coating for walls, and to give them a finished surface. Stucco for internal decorative purposes, such as the cornices and mouldings of rooms, and the enrichment of ceilings, is a composition of very fine sand, pulverized marble, and gypsum, mixed with water till it is of a proper consistency. Within a short time after being first applied, it begins to set, or gradually harden, in which state it is moulded, and may at length be finished up with metal tools. The stucco employed for external purposes is of a coarser kind, and variously prepared; the different sorts being generally distinguished by the name of cements. Some of these take a surface and polish almost equal to that of the finest marble. The third coat of three-coat plaster is termed *stucco*, consisting of fine lime and sand. There is a species called *bastard stucco*, in which a small portion of hair is used. Rough stucco

is merely floated and brushed with water, but the best kind is trowelled.—

2. Work made of stucco.—3. In popular *lan.*, plaster of Paris or gypsum.

**STUC'CO**, *v. t.* To plaster; to overlay with fine plaster.

**STUC'COED**, *pp.* Overlaid with stucco.

**STUC'COER**, *n.* One versed in stucco work.

**STUC'COING**, *ppr.* Plastering with stucco.

**STUC'CO WÖRK**, *n.* In *arch.*, the name given to all interior ornamental work composed of stucco; such as cornices, mouldings, and other ornaments to the ceilings of rooms.

**STUCK**, *pret.* and *pp.* of *Stick*.

*Stuck* o'er with titles, and hung round with strings. *Pope.*

**STUCK**, *† n.* A thrust.

**STUCK'LING**, *n.* An apple pasty, thin, somewhat half circular in shape, and not made in a dish. [*Local*.]

**STUCK MOULDINGS**, *n.* In *arch.*, mouldings formed by the planes instead of being wrought by the hand.

**STUCKS**, *n.* Iron pins which are put into the upper part of the blocks of a drag, or low timber cart, for the purpose of preventing the timber slipping off the side. [*Local*.]

**STUD**, *n.* [Sax. *stod*, *studu*; G. *stütze*, a stay or prop; *stützen*, to butt at, to gore; Dan. *stöder*, to push, to thrust, G. *stossen*. The sense of the root is to set, to thrust. It coincides with *stead*, place, Ir. *stadam*, to stay or stand, *stid*, a prop.] 1. In *carpentry*, studs are posts or quarters which are placed in partitions, about a foot distant from each other.—2. A nail with a large head, inserted in work chiefly for ornament; an ornamental knob.

A belt of straw, and ivy buds,  
With coral clasps and amber studs. *Raleigh.*  
Crystal and myrrhine cups, emboss'd with gems

And studs of pearl. *Milton.*

3. A collection of breeding horses and mares; or the place where they are kept.

In the *studs* of Ireland, where care is taken, we see horses bred of excellent shape, vigour, and fire. *Temple.*

4. An ornamental button, loosely set, for a shirt bosom, &c.

**STUD**, *v. t.* To adorn with shining studs or knobs.

Their horses shall be trapp'd,  
Their harness *studded* all with gold and pearl. *Shak.*

2. To set with detached ornaments or prominent objects.

**STUD'DED**, *pp.* Adorned with studs.—2. Set with detached ornaments.

The sloping sides and summits of our hills, and the extensive plains that stretch before our view, are *studded* with substantial, neat, and commodious dwellings of freemen. *Bp. Hobart.*

**STUD'DING**, *ppr.* Setting or adorning with studs or shining knobs.

**STUD'DING SAIL**, *n.* In *navigation*, a sail that is set beyond the skirts of the principal sails. The studding-sails are set only when the wind is light. They appear like wings upon the yard arms.—*Lower studding sails* are set beyond the leeches of the main-sail, and fore-sail, and fixed nearly in the same manner.—*Topmast*, and *top-gallant studding sails* are set on the outside of the top-sails and top-gallant sails; they are spread at the foot by booms, which slide out from the extremities of the main and fore yards, and have their heads or upper edges attached to small

yards, which are hoisted up to the top-sail, and top-gallant yard-arms.—*Studding sail booms*, long poles sliding through boom-irons at the extremities

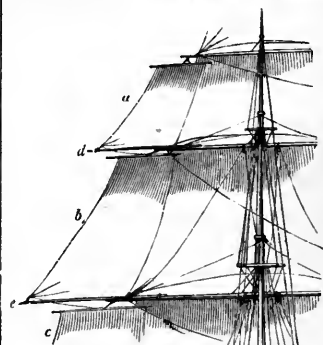

Studding Sails.

a, Top-royal studding sail; b, Top-gallant studding sail. c, Top-mast studding sail. d, e, Studding sail booms.

of the yards, and from the vessel's sides, used to spread the studding sails.

**STUDENT**, *n.* [L. *studens*, *studeo*. See *STUDY*.] 1. A person engaged in study; one who is devoted to learning; either in a seminary or in private; a scholar; as, the *students* of an academy, of a college, or university; a medical *student*; a law *student*.—2. A man devoted to books; a bookish man; as, a hard *student*; a close *student*.

Keep a gamester from dice, and a good *student* from his books. *Shak.*

3. One who studies or examines; as, a *student* of nature's works.

**STUDENTSHIP**, *n.* The state of being a student.

**STUD'-HORSE**, *n.* [Sax. *stod-hors*; Low L. *stotarius*; Chaucer, *stot*.] A breeding horse; a horse kept for propagating his kind.

**STUD'IED**, *pp.* [from *study*.] Read; closely examined; read with diligence and attention; well considered. The book has been *studied*. The subject has been well *studied*.—2. *a.* Learned; well versed in any branch of learning; qualified by study; as, a man well *studied* in geometry, or in law, or medical science.—3. Premeditated.—4. Having a particular inclination.

**STUD'IEDLY**, *adv.* In a studied manner.

**STUD'IER**, *n.* [from *study*.] One who studies; a student.

Lipsius was a great *studier* in the stoical philosophy. *Tillotson.*

**STUD'IES**, *n. plur.* [see *STUDY*.] In *painting*, a term applied to those preparatory sketches or exercises made by an artist, consisting of separate parts of a picture, first designed and painted unconnectedly, with a view to their future introduction into the entire work. Thus, entire figures in some instances; in others, human heads, hands, or feet, animals, trees, plants, flowers, and, in short, any thing designed from nature, receive the general name of *studies*. The use of studies is to enable a painter to acquire a practical knowledge of his art, and facility of execution.—2. Pieces of instrumental music composed for the purpose of familiarizing the player with the difficulties of his instrument.

**STUDIO**, *n.* [It.] An artist's study; a college or seminary; an academy for painters.

**STUDIOUS**, *a.* [Fr. *studieux*; L.

*studiosus*.] 1. Given to books or to learning; devoted to the acquisition of knowledge from books; as, a *studious* scholar.—2. Contemplative; given to thought, or to the examination of subjects by contemplation.—3. Diligent; eager to discover something, or to effect some object; as, be *studious* to please; *studious* to find new friends and allies.—4. Attentive to; careful; with *of*.

Divines must become *studious* of pious and venerable antiquity. *White*.

5. Planned with study; deliberate.

For the frigid villany of *studious* lewdness, for the calm malignity of laboured impiety, what apology can be invented?

*Rambler*.  
6. Favourable to study; suitable for thought and contemplation; as, the *studious* shade.

Let my due feet never fail,

To walk the *studious* cloister pale. *Milton*.

[The latter signification is forced, and not much used.]

*STUDIOUSLY*, *adv.* With study; with close attention to books.—2. With diligent contemplation.—3. Diligently; with zeal and earnestness.—4. Carefully; attentively.

*STUDIOUSNESS*, *n.* The habit or practice of study; addictedness to books. Men of sprightly imagination are not generally the most remarkable for *studiousness*.

*STUDWORK*, *n.* A wall of brickwork built between studs.

*STUDY*, *n.* [Fr. *etude*; L. *studium*, from *studeo*, to study, that is, to set the thoughts or mind. See *ASSIDUOUS*.

*Studeo* is connected with the English *stud*, *stead*.] 1. Literally, a setting of the mind or thoughts upon a subject; hence, application of mind to books, to arts, or science, or to any subject, for the purpose of learning what is not before known.

Hammond generally spent thirteen hours of the day in *study*. *Fell*.

*Study* gives strength to the mind; conversation, *grace*. *Temple*.

2. Attention; meditation; contrivance. Just men they seem'd, and all their *study* bent

To worship God aright and know his works. *Milton*.

3. Any particular branch of learning that is studied. Let your *studies* be directed by some learned and judicious friend.—4. Subject of attention.

The Holy Scriptures, especially the New Testament, are her daily *study*. *Law*.

5. A building or an apartment devoted to study or to literary employment; the room or apartment in which a person studies.—6. Deep cogitation; perplexity. [Little used.] [See *STUDIES*.]

*STUDY*, *v. i.* [L. *studeo*.] 1. To fix the mind closely upon a subject; to muse; to dwell upon in thought.

I found a moral first, and then *studied* for a fable. *Swift*.

2. To apply the mind to books. He *studies* eight hours in the day.—3. To endeavour diligently.

That ye *study* to be quiet, and to do your own business: 1 Thess. iv.

*STUDY*, *v. t.* To apply the mind to; to read and examine for the purpose of learning and understanding; as, to *study* law or theology; to *study* languages.—2. To consider attentively; to examine closely. *Study* the works of nature.

*Study* thyself; what rank or what degree Thy wise Creator has ordain'd for thee.

*Dryden*.

3. To form or arrange by previous thought; to con over; or to commit to memory; as, to *study* a speech.

*STUDY*, } *n.* [Icelandic *stedia*, an  
*STUD'DIE*, } anvil.] A smith's anvil or forge. [Scotch.]

*STUD'YING*, *ppr.* Applying the mind to; reading and examining closely.

*STU'FA*, *n.* [It.] A jet of steam issuing from a fissure of the earth in volcanic regions.

*STUFF*, *n.* [D. *staff*, *staffe*; G. *staff*; Sp. *estafa*, quilted stuff; *estofur*, to quilt, to *stew*. See *STOVE* and *STREW*.] 1. A mass of matter, indefinitely; or, a collection of substances; as, a heap of dust, of chips, or of dross.—2. The matter of which any thing is formed; materials. The carpenter and joiner speak of the *stuff* with which they form wood work; mechanics pride themselves on having their wares made of good *stuff*.

Time is the *stuff* which life is made of.

Degrading prose explains his meaning ill,  
And shows the *stuff*, and not the workman's skill.

Cesar hath wept;  
Ambition should be made of sterner *stuff*.

3. Furniture; goods; domestic vessels in general.

He took away locks, and gave away the king's *stuff*. [Nearly obsolete.] *Hayward*.

4. That which fills any thing. Cleanse the stuff'd bosom of that perilous *stuff*

That weighs upon the heart. *Shak.*

5. Essence; elemental part; as, the *stuff* of the conscience.—6. A medicine.

—7. In *com.*, a general name for all kinds of fabrics, of silk, wool, hair, cotton, or thread manufactured on the loom, as, silk *stuffs*; woollen *stuffs*.

In this sense the word has a plural. *Stuff* comprehends all cloths, but it signifies particularly woollen cloth of slight texture, formerly much used for curtains and bed-furniture, and still used for linings and women's apparel.—8. Matter or thing; particularly, that which is trifling or worthless, a *very extensive use of the word*. Flattery is fulsome *stuff*; poor poetry is miserable *stuff*.

Anger would indite  
Such woful *stuff* as I or Shadwell write.

9. Among *seamen*, a melted mass of turpentine, tallow, &c., with which the masts, sides, and bottom of a ship are smeared.

*STUFF*, *v. t.* To fill; as, to *stuff* a bed-tick.—2. To fill very full; to crowd.

This crook drew hazel boughs adown,  
And *stuff'd* her apron wide with nuts so brown.

3. To thrust in; to crowd; to press.

Put roses into a glass with a narrow mouth, *stuffing* them close together. *Bacon*.

4. To fill by being put into any thing. With inward arms the dire machine they load,  
And iron bowels *stuff* the dark abode.

5. To swell or cause to bulge out by putting something in.

6. To fill with something improper. For these I dim these eyes, and *stuff* this head  
With all such reading as was never read.

7. To obstruct; as any of the organs. I'm *stuff'd*, cousin; I cannot smell. *Shak.*

8. To fill meat with seasoning; as, to *stuff* a leg of veal.—9. To fill the skin of a dead animal for presenting and preserving his form; as to *stuff* a bird or a lion's skin.—10. To form by filling.

An eastern king put a judge to death for an iniquitous sentence, and ordered his hide to be *stuffed* into a cushion, and placed upon the tribunal. *Swift*.

*STUFF*, *v. i.* To feed gluttonously. Taught harmless man to cram and *stuff*.

*STUFF'ED*, *pp.* Filled; crowded; crammed.

*STUFF'ING*, *ppr.* Filling; crowding.

*STUFF'ING*, *n.* That which is used for filling any thing; as, the *stuffing* of a saddle or cushion.—2. Seasoning for meat; that which is put into meat to give it a higher relish.

Arrach leaves are very good in pottages and *stuffings*. *Mortimer*.

*STUFFING-BOX*. In *mech.*, a contrivance for securing a steam, air, or water tight joint, when it is required to pass a movable rod out of a vessel or into it. It consists of a close box cast round the hole through which the rod passes, in which is laid, around the rod and in contact with it, a quantity of hemp packing. This packing is lubricated with oily matter, and a ring, as shown in the annexed figure is then placed on the top of it and pressed down by screws, so as to squeeze the packing into every crevice. The stuffing-box is used in steam-engines, pumps, &c. The accompanying figure of the section of the cylinder of a steam-engine shows the *stuffing-box* at *s, s*.

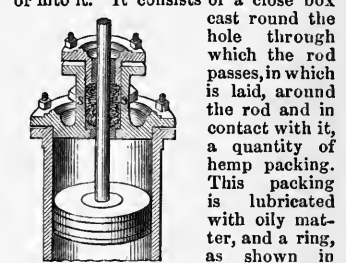

Part of Steam-engine Cylinder.  
s, s, Stuffing-box.

*STUFFY*, *a.* Stout; mettlesome; resolute. [Scotch, *pp.*]—2. Angry; sulky; obstinate. [American.]

*STUKE*, *†* for *Stucco*.

*STULM*, *n.* A shaft to draw water out of a mine. [Local or obsol.]

*STUL'TIFIED*, *pp.* Made foolish.

*STUL'TIFY*, *v. t.* [L. *stultus*, foolish, and *facio*, to make.] 1. To make foolish; to make one a fool.—2. In *law*, to allege or prove to be insane, for avoiding some act.—To *stultify one's self*, or incur the charge of *self-stultification*, is to unsay, directly or by implication, what one has already asserted; lay one's self open to an accusation of self-contradiction.

*STUL'TIFYING*, *ppr.* Making foolish.

*STULTIL'OUQUENCE*, *n.* [L. *stultus*, foolish, and *loquentia*, a talking.] Foolish talk; a babbling.

*STULTIL'OQUY*, *n.* [L. *stultiloquium*, supra.] Foolish talk; silly discourse; babbling.

*STUM*, *n.* [D. *stom*, stum, dumb; G. *stumm*, Dan. and Sw. *stum*, dumb, mute.] 1. Must; the unfermented juice of the grape when it has been several times racked off and separated from the sediment.—2. New wine used to raise fermentation in dead or rapid wines.—3. Wine revived by fermentating anew.

*STUM*, *v. t.* To renew wine by mixing must with it, and fermentating anew.—2. To fume a cask with brimstone.

**STUMBLE**, *v. t.* [Ice. *stumra*. This word is probably from a root that signifies to stop or to strike, and may be allied to *stammer*.] 1. To trip in walking or moving in any way upon the legs; to strike the foot so as to fall, or to endanger a fall; applied to any animal. A man may *stumble*, as well as a horse.

The way of the wicked is as darkness; they know not at what they *stumble*; Prov. iv.

2. To err; to slide into a crime or an error.

He that loveth his brother, abideth in the light, and there is no occasion of *stumbling* in him; 1 John ii.

3. To strike upon without design; to fall on; to light on by chance. Men often *stumble* upon valuable discoveries. Ovid *stumbled* by some inadvertence upon Livia in a bath. Dryden.

**STUMBLE**, *v. t.* To obstruct in progress; to cause to trip or stop.—2. To confound; to puzzle; to put to a non-plus; to perplex.

One thing more *stumbles* me in the very foundation of this hypothesis. Locke.

**STUMBLE**, *n.* A trip in walking or running.—2. A blunder; a failure.

One *stumble* is enough to deface the character of an honourable life. L'Étrange.

**STUMBLER**, *n.* One that stumbles or makes a blunder.

**STUMBLING**, *ppr.* Tripping; erring; puzzling.

**STUMBLING-BLOCK**, } *n.* [stumble  
STUMBLING-STONE, } and block  
or stone.] Any cause of stumbling; that which causes to err.

We preach Christ crucified; to the Jews a *stumbling-block*, and to the Greeks foolishness; 1 Cor. i.

This *stumbling-stone* we hope to take away. Burnet.

**STUMBLINGLY**, *adv.* In a stumbling manner.

**STUMMED**, *pp.* Renewed by mixing must with it and raising a new fermentation.

**STUMP**, *n.* [Sw. and Dan. *stump*; Sw. *stympta*, to mutilate; D. *stomp*, a stump, and blunt; G. *stumpf*.] 1. The stub of a tree; the part of a tree remaining in the earth after the tree is cut down, or the part of any plant left in the earth by the scythe or sickle.—2. The part of a limb or other body remaining after a part is amputated or destroyed; as, the *stump* of a leg, of a finger, or a tooth.

**STUMP**, *v. t.* To strike any thing fixed and hard with the toe. [Vulgar.]—2. To challenge; to defy; to puzzle; to confound. [Americanism.]—3. To lop as trees.

**STUMP**, *v. i.* To walk or move like one with his legs cut down to a stump; to walk stiffly, heavily, noisily.

**STUMPED**, *pp.* Struck hard with the toe.

**STUMPER**, *n.* One who stumps.—2. A boaster.

**STUMP-ORATOR**, *n.* In America, a man who harangues the populace from the stump of a tree, or other elevation.

**STUMP-ORATORY**, *n.* In America, an electioneering speech from a stump or other elevation.

**STUMPY**, *a.* Full of stumps.—2. Hard; strong. [Lit. us.]—3. Short; stubby. [Little used.]

**STUN**, *v. t.* [Sax. *stunian*; Fr. *étonner*. The primary sense is to strike or to stop, to blunt, to stupify.] 1. To make senseless or dizzy with a blow on the

head; as, to be *stunned* by a fall, or by a falling timber.

One hung a pole-ax at his saddle-bow. And one a heavy mace to *stun* the foe. Dryden.

2. To overpower the sense of hearing; to blunt or stupify the organs of hearing. To prevent being *stunned*, cannoners sometimes fill their ears with wool.—3. To confound or make dizzy by loud and mingled sound.

...An universal hubbub wild  
Of *stunning* sounds and voices all confus'd. Milton.

**STUNG**, *pret.* and *pp.* of *Sting*.

**STUNK**, *pret.* of *Stink*.

**STUNNED**, *pp.* Having the sense of hearing overpowered; confounded with noise.

**STUNNING**, *ppr.* Overpowering the organs of hearing; confounding with noise.

**STUNT**, *v. t.* [Ice. *stunta*; Sax. *stintan*, to stint; *stunt*, foolish, stupid. See *Stint*.] To hinder from growth; applied to animals and plants; as, to *stunt* a child; to *stunt* a plant.

**STUNTED**, *pp.* or *a.* Hindered from growth or increase; dwarfish; stubbed.

**STUNTEDNESS**, *n.* The state of being stunted.

**STUNTING**, *ppr.* Hindering from growth or increase.

**STUPE**, *n.* [L. *stupa*, tow; probably allied to *stuff*.] Cloth or flax dipped in warm medicaments and applied to a hurt or sore; fomentation; sweating bath.

**STUPE**, *v. t.* To foment.

**STUPE**, *† n.* A stupid or foolish person.

**STUPEFACIENT**, *a.* [L. *stupefaciens*.] Of a stupifying quality.

**STUPEFACTION**, *n.* [L. *stupefacio*; *stuepo*, whence *stupidus*, and *facio*. See *Stop*.] 1. The act of rendering stupid.—2. A stupid or senseless state; insensibility; dulness; torpor; stupidity.

Resistance of the dictates of conscience brings a hardness and *stupefaction* upon it. South.

**STUPEFACTIVE**, *a.* Causing insensibility; deadening or blunting the sense of feeling or understanding; narcotic.

**STUPEFY**. See *Stupify*.

**STUPENDOUS**, *a.* [Low L. *stupendus*, from *stuepo*, to astonish.] Literally, striking dumb by its magnitude; hence, astonishing; wonderful; amazing; particularly, of astonishing magnitude or elevation; as, a *stupendous* pile; a *stupendous* edifice; a *stupendous* mountain; a *stupendous* bridge.

**STUPENDOUSLY**, *adv.* In a manner to excite astonishment.

**STUPENDOUSNESS**, *n.* The quality or state of being stupendous or astonishing.

**STUPID**, *a.* [Fr. *stupid*; L. *stupidus*, from *stuepo*, to be stupified, properly to stop. See *Stop*.] 1. Very dull; insensible; senseless; wanting in understanding; heavy; sluggish.

O that men should be so *stupid* grown, As to forsake the living God. Milton.

With wild surprise,  
A moment *stupid*, motionless he stood. Thomson.

2. Dull; heavy; formed without skill or genius.

Observe what loads of *stupid* rhymes  
Oppress us in corrupted times. Swift.

**STUPIDITY**, *n.* [Fr. *stupidité*; L. *stupiditas*.] Extreme dulness of perception or understanding; insensibility; sluggishness.

**STUPIDLY**, *adv.* With extreme dulness; with suspension or inactivity of

understanding; sottishly; absurdly; without the exercise of reason or judgment.

**STUPIDNESS**, *n.* Stupidity.

**STUPIFIED**, *pp.* or *a.* Made dull or stupid; having the perception or understanding blunted.

**STUPIFIER**, *n.* [from *stupify*.] That which causes dulness or stupidity.

**STUPIFY**, *v. t.* [Fr. *stupefier*; L. *stupefacio*.] 1. To make stupid; to make dull; to blunt the faculty of perception or understanding; to deprive of sensibility. It is a great sin to attempt to *stupify* the conscience.

The fumes of passion intoxicate his discerning faculties, as the fumes of drink *stupify* the brain. South.

2. To deprive of material motion. It is not malleable nor fluent, but *stupified*. [Not in use.] Bacon.

**STUPIFYING**, *ppr.* Rendering extremely dull or insensible.

**STUPOR**, *n.* [L.] Great diminution or suspension of sensibility; suppression of sense; numbness; as, the *stupor* of a limb.—2. Intellectual insensibility; moral stupidity; heedlessness or inattention to one's interests.

**STUPOSE**, *a.* In bot., having a tuft of hairs.

**STUPRATE**, *v. t.* [L. *stupro*.] To ravish; to debauch.

**STUPRATION**, *n.* Rape; violation of chastity by force.

**STURDILY**, *adv.* [from *sturdy*.] Hardly; stoutly; lustily.

**STURDINESS**, *n.* [from *sturdy*.] Stoutness; hardness; as, the *sturdiness* of a school-boy.—2. Brutal strength.

**STURDY**, *a.* [G. *störriq*, connected with *storren*, a stub.] 1. Hardy; stout; foolishly obstinate; implying coarseness or rudeness.

This must be done, and I would fain see Mortal so *sturdy* as to gainsay. Hudibras.

A *sturdy* hardened sinner advances to the utmost pitch of impiety with less reluctance than he took the first step. Atterbury.

2. Strong; forcible; lusty; as, a *sturdy* lout.—3. Violent; laid on with strength; as, *sturdy* strokes.—4. Stiff; stout; strong; as, a *sturdy* oak.

He was not of a delicate contexture, his limbs rather *sturdy* than dainty. Wotton.

**STURDY**, *n.* A disease in sheep, marked by dulness and stupor. *Sturdy*, *stagers*, *gid*, *turnsick*, *goggles*, *worm under the horn*, *watery head*, and *pendro*, are all popular terms for hydatids, or an animal now known as the *Temias globulus*, which by some unaccountable way finds entrance into the brain of the sheep and settles there, either in some of the ventricles, or more frequently in the substance of the brain. Their size varies from that of the smallest speck to that of a pigeon's egg; and the sheep attacked are generally under two years old. Stupidity, a disposition to sit on the rump, to turn to one side &c., are indications of this disease. It may be cured by thrusting instruments through the skull, or a wire through the nostrils, so as to destroy the hydatid.

**STURGEON**, *n.* [Fr. *esturgeon*; Low L. *sturio*; G. *stör*; Sw. *stör*; the *stirrer*, one that turns up the mud; G. *stören*.] A genus of cartilaginous fishes (*acipenser*, Linn.) The general form of the sturgeon is similar to that of the shark, but the body is more or less covered with bony plates in longitudinal rows; the exterior portion of the head is also well mailed; the

mouth placed under the snout is small and edentated; the palatal bones, soldered to the maxillaries, convert them into the upper jaw. The mouth, placed on a pedicle that has three articulations, is more protractile than that of a shark. The eyes and nostrils are on the side of the head, and cirri are inserted under the snout. On the back is a single dorsal fin, and the tail is forked. The sturgeons ascend the larger rivers of Europe in great abundance, and are the objects of important fisheries. The flesh of most of the species is wholesome and agreeable food; their ova is converted into caviar, and their air-bladder affords the finest isinglass. The common sturgeon (*Acipenser sturio*), is found in most of the



Sturgeon (*Acipenser sturio*).

large rivers of Europe. Its flesh is delicate and well-flavoured, somewhat resembling veal. The sterlet, (*A. ruthenus*) is found in the Po. It is seldom more than two feet in length; but it is the most highly prized species. Its flesh is delicious food, and its caviar is reserved for the Russian court. The great sturgeon (*A. huso*), is found in the Po, and Danube. It frequently exceeds 12 and 15 feet in length, and weighs above 1200 pounds. The flesh is not much esteemed, but the finest isinglass is made from its air-bladder. There are several species peculiar to North America.

**STURIONÆS,** } *n.* A family of chon-  
**STURIONIDÆ,** } dropterygious fishes, of which the common sturgeon, (*Acipenser sturio*) is the type. It contains four genera, *Acipenser*, *Spatularia*, *Chimæra*, and *Callorhynchus*.  
**STURIONIAN,** *n.* See **STURIONIDÆ**.  
**STURIONIDÆ,** *n.* Vigors's name for the starling family, belonging to his order Insectores.

**STURNUS,** *n.* The starling, a genus of insectorial birds. The common starling (*S. vulgaris*) is a well known familiar bird, and an inhabitant of almost every climate. It is very docile in confinement, and may be easily taught to repeat short phrases, or whistle tunes with great exactness, its powers of imitation being considerable. In the autumn, the starlings fly in vast flocks, and may be known at a great distance by their whirling mode of flight. The *Sturnus unicolor* is found in the south of Europe.

**STURT,** *v. t.* [Suis Goth. *stoerta*.] To vex; to trouble; as a noun, trouble; disturbance; vexation; wrath; heat of temper. [*Scotch*.]

**STURT,** *v. i.* To startle; to be afraid. [*Scotch*.]

**STUTTER,** *v. z.* [*D. stotteren*; *G. stottern*]; that is, to stop. *Stut* is not used.] To stammer; to hesitate in uttering words.

**STUTTER,** *n.* A stammer; a hesitation in speaking. [See **STAMMER**.]

**STUTTERER,** *n.* A stammerer.

**STUTTERING,** *ppr.* Stammering;

speaking with hesitation.

**STUTTERING,** *n.* A stammering; a hesitation of speech; an interrupted articulation, accompanied generally with more or less of straining, and distortion of feature. If owing to a vicious conformation of the tongue or other organ of speech, it is incurable, but when merely spasmodic, the cure is possible and sometimes easy. In some cases it may be relieved at once by avoiding carefully the usual hurried repetition of the same syllable, or by opening the mouth and allowing simple sound to pass, when any one oral position threatens to become spasmodically permanent. Should it arise from the attempt to speak being made while drawing in the breath, or when the chest is not sufficiently inflated, it may be avoided by filling the chest well with air before beginning to speak. A table of articulations, with minute directions as to the proper positions of the organs in pronouncing the different sounds, may likewise in some instances prove useful to the patient.

**STUTTERINGLY,** *adv.* With stammering.

**STY,** *n.* [*Sax. stige*.] 1. A pen or inclosure for swine.—2. Any place literally or morally filthy.—3. A place of bestial debauchery.

To roll with pleasure in a sensual *sty*.

*Milton*.

4. Hordeolum, an inflamed tumor on the edge of the eyelid. Written also *stye*, and *stian*.

**STY,** *v. t.* To shut up in a sty.

**STY,** *† v. i.* [*Sax. stigan*; Goth. *steigan*.]

To soar; to ascend. [See **STIRREP**.]

**STY'G'AN,** *n.* A Saxon copper coin of the lowest value.

**STY'G'IAN,** *a.* [*L. stygius, styx*.] Pertaining to Styx, fabled by the ancients to be a river of hell over which the shades of the dead passed, or the region of the dead; hence, hellish; infernal. At that so sudden blaze, the *Stygian* throng Bent their aspect. *Milton*.

**STY'ING,** *ppr.* Shutting up in a sty.

**STYLAGALMATE,** *n. or a.* [*Gr. στυλος*, a pillar, and *αγαλμα*, an image.] In *arch.*, a figure which performs the office of a column, or relating to such.

**STY'LLAR,** *a.* Pertaining to a style; belonging to the style or stile of a dial. It is also written *stilar*.

**STYLE,** *n.* [*L. stylus*; *D. and G. styl*; *Fr. style* or *stile*; *Gr. στυλος*, a column, a pen or bodkin; from the root of the Teutonic *stellen*, to set or place.] 1.

Manner of writing with regard to language; the peculiar manner in which a person expresses his conceptions. It may be considered as a picture of the ideas which rise in his mind, and of the order in which they are there produced. The distinctive manner of writing which belongs to each author, is called his *style*. Thus, we speak of a harsh *style*; a dry *style*; a timid or bombastic *style*; a loose *style*; a terse *style*; a laconic or verbose *style*; a flowing *style*; a lofty *style*; an elegant *style*; an epistolary *style*. The style of an author is made up of various minute particulars, which it is extremely difficult to describe, but each of which adds something to the aggregate of qualities which belong to him. The selection and arrangement of words, turn of sentences, syntax, rhythm; the relation, abundance, and the character of his usual figures and metaphors; the usual order in which thoughts succeed each other; the logical form in

which conclusions are usually deduced from their premises; the particular qualities most insisted on in description; amplification and conciseness, clearness and obscurity, directness and indirectness, exhaustion, suggestion, suppression;—all these are features of style in the largest sense of the term, in which it seems to comprehend all peculiarities belonging to the manner in which thought is communicated from the writer to the reader. A particular style may belong not only to an individual, but to a body of individuals, allied to each other as belonging to the same school, country, or age. The principal requisites of a good style are purity, perspicuity, vigour, harmony, dignity and beauty.

Yet let some lord but own the happy lines,  
How the wit brightens and the *style* rises!

*Pope.*

2. Manner of speaking appropriate to particular characters; or, in general, the character of the language used.

No *style* is held for base, where love well named is. *Sidney.*

According to the usual *style* of dedications.

*Middleton.*

So we say, a person addresses another in a *style* of haughtiness, in a *style* of rebuke.—3. In the *fine arts*, the mode in which an artist forms and expresses his ideas on and of a given subject. It is a characteristic essence by which we distinguish the works of one master from those of another. We speak of the *style* of a design, of a composition, of draperies, &c., but we apply the word *manner* to colouring, and harmony of tints. Style in the arts depends on the character of the artist, the subjects, the art itself, the materials used, the object aimed at, &c. The style varies in different periods, and is also influenced by differences of national character. The various branches of an art too have each its peculiar style. Thus in poetry, there are the epic, lyric, and dramatic *styles*; in music, the sacred, opera, and concert *styles*, the vocal and instrumental *styles*, the quartetto, sonata, and symphony *styles*, &c.; in painting, there are the historical, landscape, &c., *styles*—4. A particular character of music; as, a grave *style*; a lively *style*; a brilliant *style*.—5. Title; appellation; as, the *style* of majesty.

Propitious hear our prayer,

Whether the *style* of Titan please thee more.

*Pope.*

6.† Course of writing.—7. *Style of court*, is properly the practice observed by any court in its way of proceeding. In *Scots law*, *style* is the particular form of expressions and arrangement necessary to be observed in formal deeds and instruments.—8. In *popular use*, manner; form; as, the entertainment was prepared in excellent *style*.—9. A pointed instrument or iron bodkin, used by the ancient Romans for writing by scratching on wax tablets; while the pointed end was used for writing, the other end, which was made blunt and smooth, was employed to make erasures with. From the instrument of writing the term was transferred to the writing itself, and came to signify a particular manner of writing.—10. An instrument of surgery; a probe.—11. Something with a sharp point; a graver; the pin or gnomon of a dial, which projects the shadow on the plane of the dial; written also *stille*.—

12. In bot., the prolongation of the summit of the ovary which supports the stigma. Sometimes it is entirely wanting, and then the stigma is sessile; as in the poppy and tulip. When the ovary is composed of a single carpel, the style is also single; and the number of styles varies according to the number of carpels; though when the carpels are numerous, the styles may be united. Considered in reference to its direction or position, the style may be lateral, basal, vertical, included, protruded, ascending, or declinate. Viewed in reference to its form, it may be filiform, subulate, trigonal, claviform, or petaloid. Viewed with reference to its divisions, it may be simple or divided; when the divisions do not extend far, it is slit; when more prolonged, partite. Thus it may be bifid or bipartite, trifid or tripartite, &c. After fecundation the style generally falls off, when it is said to be caducous; but when it remains, it is said to be persistent.—



a. Ovary. b. Style. c. Stigma.

13. In arch., a particular mode of erecting buildings; as the Gothic style, the Grecian style, the Moorish style, the Norman style, &c.—14. In joinery. [See STYLE.]—15. In chronology, a mode of reckoning time, with regard to the Julian and Gregorian calendar. Style is Old or New. The Old Style follows the Julian manner of computing the months and days, or the calendar as established by Julius Cesar, in which the year consists of 365 days and 6 hours. This is something more than 11 minutes too much, and in the course of time, between Cesar and Pope Gregory XIII., this surplus amounted to 11 days. Gregory reformed the calendar by retrenching 10 days, and fixing the ordinary length of the civil year at 365 days; and to make up for the odd hours, it was ordained that every fourth year (which we call leap year) should consist of 366 days. But the true length of the equinoctial year is only 365 d. 5 h. 48 m. 51.6 s.; hence, four equinoctial years would fall short of four years of 365 d. 6 h. each, or of four Julian years, three of 365 d. and one of 366 d. by 44 m. 33.6 s., and 400 equinoctial years would fall short of 400 Julian years by 74 h. 16 m., or by a little more than three days. This error would very nearly be rectified by omitting three days in three of the four years which completed centuries. Accordingly it was determined, that, dividing time into portions of 400 years, every fourth year, excepting those which terminated the first three centuries of such a period, should be of 366, but that those three, like the common years, should each be of 365 days only. Thus the years 1600, 2000, 2400, would be leap years, or have 366 days, and the years 1700, 1800, 1900, 2100, 2200, 2300, would be common years of 365 days each. This mode of correcting the calendar has been adopted at different times in almost all civilized nations. Russia and Greece are the only countries in which the Old style is still adhered to. In England it was adopted by act of par-

liament in 1752, and as one of the years concluding a century in which the additional or intercalary day was to be omitted (the year 1700) had elapsed since the correction by Pope Gregory, it was necessary to omit 11 instead of 10 days in the current year. Accordingly 11 days in September 1752 were retrenched, and the 3d day was reckoned the 14th. This mode of reckoning time is called New style. The difference between the Old and New styles is now 12 days.

Note.—The word style is used in other significations besides those above specified. Thus we speak of a style of dancing, a style of acting, a style of dress; in short, a style of any thing in which form or manner is conceived to be, in however slight a degree, expressive of taste or sentiment.

STYLE, v. t. To call; to name; to denominate; to give a title to in addressing. The emperor of Russia is styled autocrat; the sovereign of Great Britain is styled Defender of the Faith. STYLED, pp. Named; denominated; called.

STYLET, n. [from style.] A small poniard or dagger.

STYLIDIA'CEÆ, n. Styleworts, a natural order of gynandrous exogens, including plants belonging to the genus Stylidium, which are found in Australia.

STYLID'IUM, n. A genus of Australian plants, remarkable for the peculiarly irritable column which bears both the stamens and pistil. This column is



Stylidium jarroifolium.

jointed, and when touched at a particular point, it throws itself with force from one side of the flower to the other, bursting the anther lobes, and scattering the pollen on the stigma.

STYLIFORM, a. [style and form.] Like a style, pin or pen. Applied to processes of bones and parts of plants.

STYLING, ppr. Calling; denominating.

STYLISH, a. Being in fashionable form, or in high style; modish; showy.

STYLISTIC, n. The art of forming a good style in writing.—2. A treatise on style.

STYLITE, n. [Gr. στυλος, a column.] In eccles. hist., the Stylites were a sect of solitaries, who stood motionless on columns or pillars for the exercise of their patience. This strange method of devotion took its rise in the 2d century, and continued to be practised in Syria and Egypt by many individuals for a great length of time. The most famous among the Stylites, was one St. Simeon, in the 5th century, who is

said to have lived thirty-seven years upon various columns of considerable height, in the neighbourhood of Antioch.

STY'LO. In anat., names compounded of this word apply to muscles which are attached to the styloid process of the temporal bone; as, stylo-glossus, stylo-hyoides, stylo-mastoid foramen, stylo-pharyngeus.

STY'LOBATE, n. [Gr. στυλος, a pillar, and βασίς, base.] In arch., in a general sense, any sort of basement upon which columns are placed to raise them above the level of the ground or floor; but in its technical sense, it is applied only to a continuous unbroken pedestal, upon which an entire range of columns stand, contradicting from pedestals, which are merely detached fragments of a stylobate placed beneath each column.

STYLOBA'TION, n. The pedestal of a column.

STY'LOBITE, n. In min., gehlenite.

STYLOGRAPH'IC, } a. Pertain-  
STYLOGRAPH'ICAL, } ing to or  
used in stylography; as, stylographic cards, or such as may be written on with a style.—Stylographic pencil, a pencil or style for this kind of writing.

STYLOG'RAPHY, n. [L. stylos, a style, and Gr. γραφο, to write.] Art of tracing with a style; a new method of drawing and engraving with a style on a tablet.

STY'LOID, a. [L. stylos, and Gr. εidos.] Having some resemblance to a style or pen; as, the styloid process of the temporal bone.

STY'LOPOD, n. The projection or swelling at the base of the styles in the umbelliferae. It is considered as a double disk.

STYPTIC, a. [Fr. styptique; L. stypticus; Gr. στυπτικός; from the root of L. stipo, Eng. stop.] An astringent; something which produces contraction; that stops bleeding; having the quality of restraining hemorrhage.

STYPTIC, n. A medicine which has an astringent quality. Styptics are mere astringents; as, a saturated solution of alum, sulphate of zinc, or creasote.

STYPTIC'ITY, n. The quality of astringency.

STYRA'CEÆ, n. A small natural order of plants belonging to the polycarpous group of monopetalous exogens. The species are trees or shrubs with alternate leaves without stipules. The flowers are axillary, and are either solitary or clustered with membranaceous bracts; the fruit is a drupe, the seeds solitary, with the embryo lying in the midst of albumen. The order is nearly allied to Ericaceæ. The species are found in the temperate and tropical parts of North and South America, and also in Nepal and China. The order is chiefly remarkable for furnishing the storax and benzoin of commerce. Some of the species are used for dyeing yellow. The various species of Halesia are the snow-drop trees of Carolina.

STY'RACINE, n. A crystalline substance extracted from storax. It is neutral, and has the properties of a resin.

STY'RAX, n. A genus of plants, natural order Styracaceæ, of which it is the type. The species are elegant trees and shrubs, mostly covered with hairs, having a stellate form, with entire leaves, and white or cream-coloured

racemose flowers. They are principally natives of America and Asia; one is found in Europe, and one in Africa.—*S. officinalis* or official storax, is a native of Syria, Italy, and most parts of the Levant. It yields the storax of commerce, and which is used in medicine.—*S. benzoin*, benjamin-storax, or gum-benjamin tree, is a native of Sumatra and Java. It yields the gum-benzoin, or benjamin of commerce, also used in medicine. [See STORAX, BENZOIN.] The hardy species of styrax are well adapted for shrubberies, on account of their foliage and handsome flowers.

STYRIAN, *n.* A native of Styria, a province of Austria.

STYRIAN, *a.* Of or belonging to Styria.

STYROLE, *n.* Oil of storax, obtained from styracine by distilling it with hydrate of lime.

STYTHY, *v. t.* To forge on an anvil. [See STITHY.]

STYX, *n.* [L.; Gr. Στυξ.] In *ancient myth.*, the principal river of the infernal regions, which had to be crossed in passing to the regions of disembodied souls. The divinity of the river, fabled to dwell in a rock palace, was also called *Styx*.

SUABILITY, *n.* Liability to be sued; the state of being subject by law to civil process.

SU'ABLE, *a.* [from *sue*.] That may be sued; subject by law to be called to answer in court.

SUADE, for *Persuade*, is not in use.

SUAGE, for *Assuage*, is not in use.

SUARROW NUT, *n.* See SUWALLOW NUT.

SUA'SIBLE, *a.* [L. *suadeo*.] That may be persuaded or easily persuaded.

SUASION, *n.* (sua'zhun.) The act of persuading. [See PERSUADE.]

SUA'SIVE, *a.* [L. *suadeo*.] Having power to persuade.

SUA'SIVELY, *adv.* In a manner tending to persuade.

SUA'SORY, *a.* [L. *suasorius*.] Tending to persuade; having the quality of convincing and drawing by argument or reason.

SUAVERIED, *† pp.* Rendered affable.

SUAVERY, *† v. t.* [L. *suavis*, sweet.] To make affable.

SUAVERYING, *† ppr.* Making affable.

SUAVIL/OUQUY, *† n.* [L. *suavis* and *loquor*.] Sweetness of speech.

SUAVITER IN MODO. [L.] Agreeable or kindly in manner.

SUAVITY, *n.* [L. *suavitas*; Fr. *suavité*; from L. *suavis*, sweet.] 1.† Sweetness, in a literal sense.—2. Sweetness, in a figurative sense; that which is to the mind what sweetness is to the tongue; agreeableness; softness; pleasantness; as, *suavity* of manners; *suavity* of language, conversation or address.

SUB, a Latin preposition, denoting *under* or *below*, used in English as a prefix, to express a subordinate degree, or some degree, and sometimes the least sensible degree of that which the word to which it is prefixed expresses. The last letter of this prefix is often changed into the letter which begins the next syllable; as in *succinct*, *suffer*, *suggest*, *summon*, *suppress*, &c. In *chemical nomenclature*, when *sub* is prefixed to the name of a salt, it denotes a deficiency of acid, and an excess of base.

SUBAC'ID, *a.* [*sub* and *acid*.] Mode-

rately acid or sour; as, a *subacid* juice.

SUBAC'ID, *n.* A substance moderately acid.

SUBAC'RID, *a.* [*sub* and *acid*.] Moderately sharp, pungent or acrid.

SUBACT', *v. t.* [L. *subactus*, *subago*; *sub* and *ago*.] To reduce; to subdue.

SUBAC'TION, *n.* The act of reducing to any state, as, of mixing two bodies completely, or of beating them to a powder.

SUBACÛTE, *a.* Acute in a modified degree.

SUBADAR, or SOUBAHDAR, *n.* In *India*, a viceroys, or provincial governor.—2. A native serjeant of infantry. The *subadar-major* is the principal native officer in a company's black regiment; the commissioned officers being all Europeans.

SUBAERIAL, *a.* Being under the air or sky. [Opposed to *subaqueous*.]

SUBAGITA'TION, *n.* [L. *subagitatio*.] Carnal knowledge.

SUBAH, *n.* In *India*, a province or viceroyship.

SUBAHSHIP, *n.* The jurisdiction of a subahdar.

SUBAL'TERN, *a.* [Fr. *subalterne*; L. *sub* and *alternus*.] Inferior; subordinate; that in different respects is both superior and inferior; as, a *subaltern* officer. It is used chiefly of military officers.—*Subaltern*, or *subalternating propositions*, in *Logic*, universal and particular propositions, which agree in quality but not in quantity; as, *every vine is a tree*; *some vine is a tree*.

SUBAL'TERN, *n.* A subordinate officer in an army or military body. It is applied to officers below the rank of captain.

SUBALTERN'ATE, *a.* [supra.] Successive; succeeding by turns.

SUBALTERN'ATION, *n.* State of inferiority or subjection.—2. Act of succeeding by course.

SUB-ANG'ULAR, *a.* Slightly angular.

SUBAP'ENNINE, *a.* Under or at the foot of the Apennine mountains.—2. In *geol.*, a term applied to a series of strata of the older pliocene period. These strata rest unconformably upon the inclined beds of the Apennine range, and are composed of sand, clay, marl, and calcareous tufa.

SUBAQUAT'IC, } *a.* [L. *sub* and *aqua*, }  
SUBA'QUEOUS, } water.] Being under water, or beneath the surface of water, formed under water, deposited under water; as, *subaqueous* formations.

SUBARRA'TION, *n.* [Low L. *subarrare*.] The ancient custom of betrothing.

SUBAS'TRAL, *a.* [*sub* and *astral*.] Beneath the stars or heavens; terrestrial.

SUBASTRIN'GENT, *a.* Astringent in a small degree.

SUBAUDY'TION, *n.* [L. *subauditio*; *sub* and *audio*, to hear.] The act of understanding something not expressed.

SUBAX'ILLARY, *a.* [L. *sub* and *axilla*, the arm-pit.] Placed under the axil or angle formed by the branch of a plant with the stem, or by a leaf with the branch.

SUB-BASE, *n.* In *music*, the deepest pedal stop or the lowest notes of an organ.

SUB-BEADLE, *n.* [*sub* and *beadle*.] An inferior or under beadle.

SUBBRA'CHIANS, *n.* An order of Malacopterygious fishes, comprising

those which have the ventral fins situated either immediately beneath and between, or a little in front or behind the pectoral fins.

SUB-BRIGADIER, *n.* An officer in the horse guards, who ranks as cornet.

SUB-CAR'BONATE, *n.* A carbonate in which there is an excess of base.

SUB-CARBURETTED, *a.* Consisting of a greater number of equivalents of the base than of the carbon.

SUB-CARTILAG'INOUS, *a.* Partially gristly.

SUB-CAU'DAL, *a.* Being beneath the tail.

SUB-CELESTIAL, *a.* [*sub* and *celestial*.] Being beneath the heavens; as, *sub-celestial* glories.

SUB-CEN'TRAL, *a.* Being under the centre.

SUB-CHAN'TER, *n.* [*sub* and *chanter*.] An under chanter; a deputy of the precentor of a cathedral.

SUBCLA'VIAN, *a.* [L. *sub* and *clavis*, a key.] Situated under the clavicle or collar bone; as, the *subclavian* veins and arteries.

SUB-COMMIT'TEE, *n.* [*sub* and *committee*.] An under committee; a part or division of a committee.

SUB-COMPRESS'ED, *a.* Not fully compressed.

SUB-CONFORM'ABLE, *a.* Partially conformable.

SUB-CONICAL, *a.* Slightly conical.

SUB-CONSTELLA'TION, *n.* A subordinate constellation.

SUB-CON'TRACT, *n.* A contract under a previous contract.

SUB-CONTRACT'ED, *a.* [*sub* and *contracted*.] Contracted after a former contract.

SUB-CON'TRARY, *a.* [*sub* and *contrary*.] Contrary in an inferior degree. In *geom.*, when two similar triangles are so placed as to have a common angle at their vertex, and yet their bases not parallel, they are said

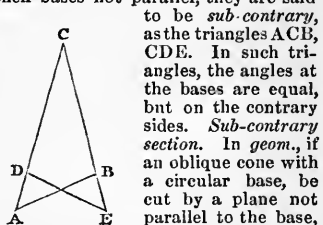

to be *sub-contrary*, as the triangles ACB, CDE. In such triangles, the angles at the bases are equal, but on the contrary sides. *Sub-contrary section*. In *geom.*, if an oblique cone with a circular base, be cut by a plane not parallel to the base, but inclined to the

axis so that the section is a circle, then the section is said to be *sub-contrary*. In this case the plane of the section, and the section of the base, are equally inclined to the axis, but the inclinations are in opposite directions.—*Sub-contrary propositions*, in *logic*, are such propositions as agree in quantity, but differ in quality; as, *some men are wise*, *some men are not wise*.

SUB-CORD'ATE, *a.* [L. *sub* and *cor*, the heart.] In shape somewhat like a heart; as, a *sub-cordate* leaf.

SUB-COSTAL, *a.* [L. *sub* and *costa*, a rib.] The *sub-costal* muscles are the internal intercostal muscles.

SUB-CRY'S'TALLINE, *a.* Imperfectly crystallized.

SUB-CUTA'NEOUS, *a.* [*sub* and *cutaneous*; L. *cutis*, skin.] Situated under the skin. In *anat.*, a term applied to the *platysma myoides* muscle, and to some nerves, vessels, glands, &c., which are very superficial.—*Sub-cutaneous glands*, sebaceous glands



lying under the skin, which they perforate by their excretory ducts.

**SUBCUTIC'ULAR, a.** [L. *sub* and *cuticula*, cuticle.] Being under the cuticle or scarf-skin.

**SUB-CYLINDRICAL, a.** Imperfectly cylindrical.

**SUBDEACON, n.** [*sub* and *deacon*.] An under deacon; a deacon's servant in the Romish church.

**SUBDEACONRY, } n.** The order  
**SUBDEACONSHIP, }** and office of subdeacon in the Catholic church.

**SUBDEAN, n.** [*sub* and *dean*.] An under dean; a dean's substitute or vicergerent.

**SUBDEANERY, n.** The office and rank of subdean.

**SUBDEE'ANAL, a.** Relating to a subdeanery.

**SUBDEE'UPLE, a.** [L. *sub* and *decuplus*.] Containing one part of ten.

**SUBDEL'EGATE, n.** A subordinate delegate.

**SUBDEL'EGATE, v. t.** To appoint to act under another.

**SUBDENT'ED, a.** [*sub* and *dent*.] Indented beneath.

**SUBDEPOSIT, n.** That which is deposited beneath something else.

**SUBDERISORIOUS, † a.** [L. *sub* and *derisor*.] Ridiculing with moderation or delicacy.

**SUBDERIVATIVE, n.** A word following in immediate grammatical derivation.

**SUBDIALECT, n.** An inferior dialect.

**SUB-DILATED, a.** Partially dilated.

**SUBDITI'TIOUS, a.** [L. *subdititi*us, from *subdo*, to substitute.] Put secretly in the place of something else. [Little used.]

**SUBDIVERS'IFIED, pp.** Diversified again.

**SUBDIVERSIFY, v. t.** [*sub* and *diversify*.] To diversify again what is already diversified. [Little used.]

**SUBDIVERSIFYING, ppr.** Diversifying again what is already diversified.

**SUBDIVIDE, v. t.** [*sub* and *divide*.] To divide a part of a thing into more parts; to part into smaller divisions.

In the rise of eight in tones, are two half tones; so as if you divide the tones equally, the eight is but seven whole and equal notes; and if you subdivide that into half notes, as in the stops of a lute, it makes the number thirteen. Bacon.

The progenies of Cham and Japhet swarmed into colonies, and those colonies were subdivided into many others. Dryden.

**SUBDIVIDE, v. i.** To be subdivided.

**SUBDIVIDED, pp.** Divided again or into smaller parts.

**SUBDIVIDING, ppr.** Dividing into smaller parts that which is already divided.

**SUBDIVISIBLE, a.** Susceptible of subdivision.

**SUBDIVI'SION, n.** The act of subdividing or separating a part into smaller parts.—2. The part of a thing made by subdividing; the part of a larger part.

In the decimal table, the subdivisions of the cubit, as span, palm, and digit, are deduced from the shorter cubit. Arbuthnot.

**SUB'DOLOUS, a.** [L. *subdolos*; *sub* and *dolos*, deceit.] Sly; crafty; cunning; artful; deceitful. [Little used.]

**SUBDOMINANT, n.** In music, the fourth note above the tonic, being under the dominant. Thus in the key of C, F is the subdominant.

**SUBDU'ABLE, a.** That may be subdued.

**SUBDU'AL, n** [from *subdue*.] The act of subduing.

**SUBDUCE, }**  
**SUBDUCE, }** v. t. [L. *subduco*; *sub*  
**SUBDUCE, }** and *duco*, to draw.]  
1. To withdraw; to take away.  
Or from my side *subducing*, took perhaps More than enough. Milton.  
2. To subtract by arithmetical operation.

If out of that infinite multitude of antecedent generations we should *subduct* ten. Hale.

**SUBDUCED, pp.** Withdrawn; taken away.

**SUBDUCING, ppr.** Withdrawing; subtracting by arithmetical operation.

**SUBDUCTION, n.** The act of taking away or withdrawing.—2. Arithmetical subtraction.

**SUBDUE, v. t.** (subdu') [L. *subdo*, *subdere*, from *sub* and *do*, to give, to cause, to effect.] 1. To conquer by force or the exertion of superior power, and bring into permanent subjection; to reduce under dominion. Thus Cesar *subdued* the Gauls; Angustus *subdued* Egypt; the English *subdued* Canada. Subduing implies conquest or vanquishing, but it implies also more permanence of subjection to the conquering power than either of these words.  
I will *subdue* all thine enemies; 1 Chron. xvii.  
2. To oppress; to crush; to sink; to overpower so as to disable from further resistance.  
Nothing could have *subdu'd* nature  
To such a lowness, but his unkind daughters. Shak.  
If aught were worthy to *subdue*  
The soul of man. Milton.  
3. To tame; to break by conquering a refractory temper or evil passions; to render submissive; as, to *subdue* a stubborn child.—4. To conquer; to reduce to mildness; as, to *subdue* the temper or passions.—5. To overcome by persuasion or other mild means; as, to *subdue* opposition by argument or entreaties.—6. To overcome; to conquer; to captivate; as by charms.—7. To soften; to melt; to reduce to tenderness; as, to *subdue* ferocity by tears.—8. To overcome; to overpower and destroy the force of; as, medicines *subdue* a fever.—9. To make mellow; to break, as land; also, to destroy, as weeds.

**SUBDUE'D, pp.** Conquered and reduced to subjection; oppressed; crushed; tamed; softened.

**SUBDUEMENT, n.** Conquest.

**SUBDU'ER, n.** One who conquers and brings into subjection; a tamer.—2. That which subdues or destroys the force of.

**SUBDU'ING, ppr.** Vanquishing and reducing to subjection; crushing; destroying the power of resistance; softening.

**SUBDU'PLE, a.** [L. *sub* and *duplus*, double.] Containing one part of two. *Subduplex ratio*, in math., is when the antecedent is equal to half the consequent. [Little used.]

**SUBDUPLICATE, a.** [*sub* and *duplicate*.] Having the ratio of the square roots. In math., the subduplicate ratio of two quantities is the ratio of their square roots. Thus, the subduplicate ration of *a* to *b*, is the ratio of  $\sqrt{a}$  to  $\sqrt{b}$ , or it is the ratio whose duplicate is that of *a* to *b*. The term is little used by modern mathematicians.

**SUBELON'GATE, a.** Not fully elongated.

**SUBEQUAL, a.** [*sub* and *equal*.] Nearly equal.

**SUB'ERATE, n.** [L. *suber*, cork.] A salt formed by the suberic acid in combination with a base; as, the *suberate* of ammonia.

**SUBERIC, a.** Pertaining to cork.—*Suberic acid*, an acid substance produced by treating rasped cork with nitric acid. It is also produced when nitric acid acts on stearic acid, margaric acid, oleic acid, and other fatty bodies. It forms small granular crystals; its acid powers are but feeble; it is very soluble in boiling water, in alcohol, and ether; it fuses at about 300°, and sublimes in acicular crystals. It consists of 8 equivalents of carbon, 6 of hydrogen, and 3 of oxygen.

**SUB'ERINE, or SUB'ERIN, n.** [L. *suber*, the cork tree.] The name given by Chevreul to the cellular tissue of cork, after the various soluble matters have been removed by the action of water and alcohol. It is very inflammable.

**SUB'EROSE, a.** [L. *sub* and *erosus*, gnawed.] In bot., having the appearance of being gnawed; appearing as if a little eaten or gnawed.

**SUB'EROUS, a.** [from *suber*, cork.] Corky; soft and elastic.

**SUB'FAMILY, n.** In nat. hist., a subdivision of a family.

**SUBFUSE', a.** [L. *subfuscus*; *sub* and *fuscus*.] Dusky; moderately dark; brownish; tawny.

**SUBGELATINOUS, a.** Imperfectly gelatinous.

**SUBGENER'IC, a.** Pertaining to a subgenus.

**SUBGENUS, n.** A subordinate genus.

**SUB-GLOBOSE, a.** Not quite globose.

**SUBGLOBULAR, a.** Having a form approaching to globular.

**SUBGLUMACEOUS, a.** Somewhat glumaceous.

**SUB-GOVERNOR, n.** An under governor.

**SUBGRANULAR, a.** Somewhat granular.

**SUBIASTA'TION, n.** [L. *sub* *hasta*, under the spear.] A public sale of immovable property to the highest bidder, so called from the Roman practice of planting a spear on the spot where a public sale was to take place.

**SUBHYDROSULPHURET, n.** A compound of sulphuretted hydrogen with a less number of equivalents of the base than of the sulphuretted hydrogen.

**SUBINDICATE, v. t.** To indicate in a less degree.

**SUBINDICATION, n.** [L. *sub* and *indico*.] The act of indicating by signs.

**SUBINDUCE, † v. t.** To offer indirectly.

**SUBINFEDA'TION, n.** [*sub* and *infederation*. See FEUD.] 1. In law, the act of enfeoffing by a tenant or feoffee, who holds lands of the crown; the act of a greater baron, who grants land or a smaller manor to an inferior person. By 34 Edward III. all *subinfutations* previous to the reign of king Edward I. were confirmed.—2. Under tenancy.

The widow is immediate tenant to the heir, by a kind of *subinfederation* or under tenancy. Blackstone.

**SUBINGRES'SION, † n.** [L. *sub* and *ingressus*.] Secret entrance.

**SUBITA'NEOUS**, *a.* [L. *subitaneus*.] Sudden; hasty.  
**SUB'ITANY**, *† a.* Sudden.  
**SU'BITO**, in *music*, quickly; suddenly; a term of direction; as, *volti subito*, turn (the leaf) quickly.  
**SU'BITO-VOLTO**, *n.* [It.] An invention for turning leaves of music, by a pressure of the foot from an instrumental performer while playing.  
**SUBJA'CENT**, *a.* [L. *subjacens*; *sub* and *jacere*, to lie.] 1. Lying under or below.—2. Being in a lower situation, though not directly beneath. A man placed on a hill, surveys the *subjacent* plain.—3. In *geol.*, a term applied to rocks, beds, or strata, which lie under or are covered by others.  
**SUBJECT**, *a.* [L. *subjectus*, from *subjicio*; *sub* and *jacio*, to throw, that is, to drive or force.] 1. Placed or situate under.

The eastern tower

Whose height commands, as *subject*, all the vale,

To see the fight. *Shak.*  
 2. Being under the power and dominion of another; as, Jamaica is *subject* to Great Britain.

Esau was never *subject* to Jacob. *Locke.*  
 3. Exposed; liable from extraneous causes; as, a country *subject* to extreme heat or cold.—4. Liable from inherent causes; prone; disposed.  
 All human things are *subject* to decay.

*Dryden.*

5. Being that on which any thing operates, whether intellectual or material; as, the *subject* matter of a discourse.—6. Obedient; Tit. iii.; Col. ii.

**SUB'JECT**, *n.* [L. *subjectus*; Fr. *sujet*; It.  *soggetto*.] 1. One that owes allegiance to a sovereign, and is governed by his laws. The natives of Great Britain are *subjects* of the British government. The natives of the United States, and naturalized foreigners, are *subjects* of the federal government. Men in free governments are *subjects* as well as citizens; as citizens, they enjoy rights and franchises; as *subjects*, they are bound to obey the laws.

The *subject* must obey his prince, because God commands it, and human laws require it. *Swift.*

2. That on which any mental operation is performed; that which is treated or handled; as, a *subject* of discussion before the legislature; a *subject* of negotiation.

This *subject* for heroic song pleased me. *Milton.*

3. In *logic*, the *subject* of a proposition is that concerning which any thing is affirmed or denied.—4. That on which any physical operation is performed; as, a *subject* for dissection or amputation.—5. That in which any thing inheres or exists.

Anger is certainly a kind of baseness, as it appears well in the weakness of those *subjects* in whom it reigns. *Bacon.*

6. The person who is treated of; the hero of a piece.

Authors of biography are apt to be prejudiced in favour of their *subject*. *Middleton.*

7. In *gram.*, the nominative case to a verb passive.—8. In *music*, the principal melody or theme of a movement.—

9. In the *arts*, the design of a composition or picture; any thing which constitutes the object or aim of any given art. In painting, sculpture, and engraving, it often designates the representation of an action, *subject* and *object*. In the intellectual philosophy,

these terms are thus distinguished:—The *subject* is used to express the mind, soul, or personality of the thinker—the *Ego*. The *object* is its co-relative, and uniformly expresses any thing or every thing external to the mind; every thing or any thing distinct from it—the *non-Ego*. The universe itself, when considered as a unique existence, is an object to the thinker, and the very subject itself (the mind) can become an object by being psychologically considered. These co-relatives, *subject* and *object*, correspond to the first most important distinction in philosophy, viz., the original antithesis of self and not-self.—10. In *anat.*, a dead body for the purposes of dissection.—*Subject* of a proposition, in *logic*, the term of which the other is affirmed or denied. Thus in the proposition, "Plato was a philosopher," Plato is the subject, *philosopher* being its predicate, or that which is affirmed of the subject. Also in the proposition, "No man living on earth can be completely happy," *man living on earth* is the subject, *can be* is the affirmative particle or copulative, and *completely happy* is the predicate, or that which is denied of the subject.

**SUBJECT**, *v. t.* To bring under the power or dominion of. Alexander *subjected* a great part of the civilized world to his dominion.

Firmness of mind that *subjects* every gratification of sense to the rule of right reason. *Middleton.*

2. To put under or within the power of.

In one short view *subjected* to our eye, Gods, emperors, heroes, sages, beauties lie. *Pope.*

3. To enslave; to make obnoxious. He is the most *subjected*, the most enslaved, who is so in his understanding. *Locke.*

4. To expose; to make liable. Credulity *subjects* a person to impositions.—5. To submit; to make accountable. God is not bound to *subject* his ways of operation to the scrutiny of our thoughts. *Locke.*

6. To make subservient.

*Subjected* to his service angel wings. *Milton.*

7. To cause to undergo; as, to *subject* a substance to a white heat; to *subject* it to a rigid test.

**SUBJECTED**, *pp.* Reduced to the dominion of another; enslaved; exposed; submitted; made to undergo.

**SUBJECT'ING**, *ppr.* Reducing to submission; enslaving; exposing; submitting; causing to undergo.

**SUBJECT'ION**, *n.* The act of subduing; the act of vanquishing and bringing under the dominion of another.

The conquest of the kingdom and the *subjection* of the rebels. *Hale.*

2. The state of being under the power, control, and government of another. The safety of life, liberty, and property, depends on our *subjection* to the laws. The islands of the West Indies are held in *subjection* to the powers of Europe. Our appetites and passions should be in *subjection* to our reason, and our will should be in entire *subjection* to the laws of God.

**SUBJECT'IST**, *n.* One versed in the subjective philosophy.

**SUBJECT'IVE**, *a.* Relating to the subject, as opposed to the *object*.

Certainty is distinguished into objective and *subjective*; objective, is when the pro-

position is certainly true of itself; and *subjective*, is when we are certain of the truth of it. *Watts.*

**Subjective and objective**, in *philosophy*, terms expressing the distinction which in analyzing every intellectual act we necessarily make between ourselves, the conscious *subject*, and that of which we are conscious, the *object*. *Subjective* applies to the manner in which an object is conceived of by an individual *subject*, and *objective* is expressive of that which truly belongs to an object.

**SUBJECT'IVELY**, *adv.* In relation to the subject.

**SUBJECT'IVENESS**, *n.* State of being subjective.

**SUBJECT'IVITY**, *n.* In *philosophy*, individuality; that which relates or pertains to self, or to impressions made upon the mind.

**SUBJECT MAT'TER**, *n.* The matter or thought presented for consideration in some statement or discussion.

**SUBJOIN'**, *v. t.* [*sub* and *join*; L. *subjungo*.] To add at the end; to add after something else has been said or written; as, to *subjoin* an argument or reason. [It is never used in a literal physical sense, to express the joining of material things.]

**SUBJOIN'ED**, *pp.* Added after something else said or written.

**SUBJOIN'ING**, *ppr.* Adding after something else said or written.

**SUB JUDGE**, [L.] Before the judge; not decided.

**SUB'JUGATE**, *v. t.* [Fr. *subjuguier*; L. *subjugo*; *sub* and *jugo*, to yoke. See *Yoke*.] To subdue and bring under the yoke of power or dominion; to conquer by force, and compel to submit to the government or absolute control of another.

He *subjugated* a king, and called him his vassal. *Baker.*

[*Subjugate* differs from *subject* only in implying a reduction to a more tyrannical or arbitrary sway; but they are often used as synonyms.]

**SUB'JUGATED**, *pp.* Reduced to the absolute control of another.

**SUB'JUGATING**, *ppr.* Conquering and bringing under the absolute power of another.

**SUBJUGA'TION**, *n.* The act of subduing and bringing under the power or absolute control of another; subjection.

**SUB'JUGATOR**, *n.* One who subjugates.

**SUBJUN'CTION**, *n.* The act of subjoining, or state of being subjoined.

**SUBJUN'CTIVE**, *a.* [L. *subjunctivus*; Fr. *subjunctif*; It. *soggiunto*. See *Subjoin*.] 1. Subjoined or added to something before said or written.—2. In *gram.*, designating a form of verbs which follow other verbs or words expressing condition, hypothesis, or contingency; as, "veni ut me videas," I came that you may see me; "Si fecerint æquum," If they should do what is just.—3. *Subjunctive* is often used as a noun denoting the subjunctive mode.

**SUBKING'DOM**, *n.* A subordinate kingdom.

**SUBLA'NATE**, *a.* [L. *sub* and *lana*, wool.] In *bot.*, somewhat woolly.

**SUBLAPSA'RIAN**, *a.* [L. *sub* and *lapsus*, fall.] Done after the apostacy of Adam. [See the *noun*.]

**SUBLAPSA'RIAN**, *n.* One who maintains the sublapsarian doctrine, that the sin of Adam's apostacy being in-

puted to all his posterity, God, in compassion, decreed to send his Son to rescue a great number from their lost state, and to accept his obedience and death on their account. The decree of reprobation, according to the *sublapsarians*, is nothing but a preterition or non-election of persons, whom God left as he found, involved in the guilt of Adam's transgression without any personal sin, when he withdrew some others as guilty as they. [*Sublapsarian* is opposed to *supralapsarian*.]

**SUBLAP'SARY**, *n.* A *sublapsarian*.  
**SUBLA'TION**, *n.* [*L. sublatio*.] The act of taking or carrying away.

**SUBLA'TIVE**, *a.* Of depriving power.  
**SUB'LEASE**, *n.* In *Scotland*, an under lease; a lease of a farm, a house, &c., granted by the original tenant or lease-holder.

**SUBLET**, *v. t.* [*sub* and *let*.] In *Scotland*, to underlet; to lease, as a lessee to another person.

**SUBLEVA'TION**, *n.* [*L. sublevo*.] The act of raising on high.

**SUBLIBRA'RIAN**, *n.* An under librarian.

**SUBLECTEN'ANT**, *n.* An officer in the royal regiment of artillery and fusileers, in which there are no ensigns, and who is the same as second lieutenant. In the *navy*, an officer who holds a rank intermediate between that of the full lieutenant and the midshipman. This rank is now done away with.

**SUBLIGA'TION**, *n.* [*L. subligo* and *ligo*, to bind.] The act of binding underneath.

**SUBLIMABLE**, *a.* [*from sublime*.] That may be sublimated; capable of being raised by heat into vapour, and again condensed by cold.

**SUBLIMABLENESS**, *n.* The quality of being sublimable.

**SUBLIMATE**, *v. t.* [*from sublime*.] To bring a solid substance, as camphor or sulphur, into the state of vapour by heat, which on cooling, returns again to the solid state. [*See* SUBLIMATION.]—2. To refine and exalt; to heighten; to elevate.

And as his actions rose, so raise they still their vein.

In words whose weight best suits a *sublimated* strain. *Dryden*.

**SUBLIMATE**, *n.* Any thing which is sublimed; the result of a process of sublimation. *Corrosive sublimate* is the *bichloride of mercury*, a valuable medicine, which, in excessive doses, produces poisonous effects, like every other medicine. It is sometimes simply called *sublimate*, by way of eminence. [*See* CORROSIVE.]—*Blue sublimate* is a preparation of mercury with flowers of sulphur and sal ammoniacum; used in *painting*.

**SUBLIMATE**, *a.* Brought into a state of vapour by heat, and again condensed, as solid substances.

**SUBLIMATED**, *pp. or a.* Brought into a state of vapour by heat, as a solid substance; refined.

**SUBLIMATING**, *ppr.* Converting into the state of vapour by heat, and condensing; as solid substances.

**SUBLIMA'TION**, *n.* In *chem.*, a process by which solid substances are, by the aid of heat, converted into vapour, which is again condensed into the solid state by the application of cold. Sublimation bears the same relation to a solid, that distillation does to a liquid.

Both processes purify the substances to which they are severally applied, by separating them from the fixed and grosser matters with which they are connected. Sublimation is usually conducted in one vessel, the product being deposited in the upper part of the vessel in a solid state, and often in the crystalline form, while the impurity remains in the lower part. If iodine, for example, be heated in a Florence flask, a purple vapour rises, which almost immediately condenses in small brilliant, dark-coloured crystals in the upper part of the flask, the impurity remaining in the lower. The vapour of some substances which undergo the process of sublimation, condenses in the form of a fine powder called *flowers*: such are the *flowers of sulphur*, *flowers of benzoïn*, and others of the same kind. Other sublimates require to be in a solid and compact form, as camphor, hydrochlorate of ammonia, and all the sublimates of mercury.—2. Exaltation; elevation; act of heightening or improving.

Religion, the perfection, refinement, and sublimation of morality. *South*.

**SUBLIMATORY**, *a.* Tending to sublimation.

**SUBLIME**, *a.* [*L. sublimis*; *Fr. It. and Sp. sublime*.] 1. High in place; exalted aloft.

Aloft on these a tow'r of steel is rear'd. *Dryden*.

2. High in excellence; exalted by nature; elevated.

Can it be that souls *sublime* Return to visit our terrestrial clime? *Dryden*.

3. High in style or sentiment; lofty and grand.

Easy in style thy work, in sense *sublime*. *Prior*.

4. In *natural objects*, possessing grandeur and vastness; as, a *sublime scene*; *sublime scenery*.—5. In the *fine arts*, high or exalted in style.—6. Elevated by joy; as, *sublime* with expectation.—7. Lofty of mien; elevated in manner. His fair large front and eye *sublime* declar'd Absolute rule. *Milton*.

**SUBLIME**, *n.* A grand or lofty style; a style that expresses lofty conceptions.

The *sublime* rises from the nobleness of thoughts, the magnificence of words, or the harmonious and lively turn of the phrase. *Adison*.

2. The grand in the works of nature as distinguished from the beautiful, as that which strikes the beholder on viewing a lofty mountain; a broad river, a wide prospect; the ocean; the sky, &c.—3. The grand and elevated in the fine arts as distinguished from the beautiful. The works of Michael Angelo and Raffaele furnish instances of the sublime.—4. The emotion produced in the mind by grand and vast objects, and by grandeur and elevation in style.

**SUBLIME**, *v. t.* To sublimate,—*which see*.—2. To raise on high.—3. To exalt; to heighten; to improve.

The sun... Which not alone the southern wit *sublimes*, But ripens spirits in cold northern climes. *Pope*.

**SUBLIME**, *v. i.* To be brought or changed into a state of vapour by heat, and then condensed by cold, as a solid substance.

Particles of antimony which will not *sublime* alone. *Newton*.

**SUBLIMED**, *pp.* Brought into a state of vapour by heat, and when cooled, changed to a solid state.

**SUBLIME GEOMETRY**, *n.* A name given by the older mathematicians to the higher parts of geometry, in which the infinitesimal calculus, or something equivalent, was employed.

**SUBLIMELY**, *adv.* With elevated conceptions; loftily; as, to express one's self *sublimely*.

In English lays, and all *sublimely* great, Thy Homer charms with all his ancient heat. *Parnell*.

**SUBLIMENESS**, *n.* Loftiness of style or sentiment; sublimity.

**SUBLIMIFICA'TION**, *n.* [*L. sublimis, and facio*.] Act of making sublime.

**SUBLIMING**, *ppr.* Sublimating; exalting.

**SUBLIMITY**, *n.* [*Fr. sublimité*; *L. sublimitas*.] 1. Elevation of place; lofty height.—2. Height in excellence; loftiness of nature or character; moral grandeur; as, God's incomprehensible *sublimity*.

The *sublimity* of the character of Christ owes nothing to his historians. *Buckminster*.

3. In *oratory and composition*, lofty conceptions, or such conceptions expressed in corresponding language; loftiness of sentiment or style.

Milton's distinguishing excellence lies in the *sublimity* of his thoughts. *Adison*.

4. Grandeur; vastness; elevation, whether exhibited in the works of nature or of art.

*Note*.—The true nature of sublimity is a subject of great interest and importance in mental philosophy, and it has always been a favourite subject of speculation. The term, psychologically considered, has two significations; one that of the quality or circumstance in objects, which raises the emotion named sublimity; the other that of the emotion itself. The invariable condition in objects, either material or moral, is vastness or intensity. The invariable condition of the emotion of sublimity—that which distinguishes this emotion from every other emotion—is a comprehension of this vastness, with a simultaneous feeling of our own comparative insignificance, together with a concomitant sense of present security from any danger which might result from this superior power. The antithesis to the emotion of sublimity is the emotion of contempt. In every case of sublimity in material objects, whatever feelings may simultaneously concern, vastness will be found to be an invariable condition—vastness either of form or of power; as in the violent dashing of a cataract, in the roar of the ocean, in the violence of the storm, in the majestic quiet of Mount Blanc, preserving its calm amidst all the storms that play around it. In the moral world, the invariable condition of sublimity is intensity—intensity of will. Mere intensity is sufficient to produce the sublime. Lear, who appeals to the heavens, "for they are old like him," is sublime from the very intensity of his sufferings and his passions. Lady Macbeth is sublime from the intensity of her will, which crushes every female feeling for the attainment of her object. Scævola, with his hand in the burning coals, exhibits an intensity of will which is sublime. In all the cases above-mentioned we are moved by a vivid feeling of some greater power than

our own; or some will more capable of suffering, more vast in its strength, than our feeble vacillating will.

**SUBLINEATION**, *n.* [L. *sub* and *linea*.] Mark of a line or lines under a word in a sentence.

**SUBLINGUAL**, *a.* [L. *sub* and *lingua*, the tongue.] Situated under the tongue; as, the *sublingual* glands.

**SUBLINATION**, *n.* In *painting*, laying the ground colour under the perfect colour.

**SUBLUNAR**, } *a.* [Fr. *sublunaire*; **SUBLUNARY**, } L. *sub* and *luna*, the moon.] Literally, beneath the moon; but *sublunary*, which is the word chiefly used, denotes merely terrestrial, earthly, pertaining to this world.

All things *sublunary* are subject to change. *Dryden*.

**SUBLUNARY**, } *n.* Any worldly thing. **SUBLUXATION**, *n.* [L. *sub* and *luxatio*.] In *sur.*, an incomplete dislocation; a sprain.

**SUBMARINE**, *a.* [L. *sub* and *marinus*, from *mare*, the sea.] Being, acting, or growing under water in the sea; as, *submarine* volcanoes; *submarine* navigators; *submarine* plants.—2. Formed under the sea; as, *submarine* lava; *submarine* strata, &c.—*Submarine forests*, the name given by geologists to numerous accumulations of vegetable matter, involving roots, stems, branches, leaves, and fruits of trees, rarely in the attitude of growth, sometimes in the condition of having fallen, and locally with the appearance of having been drifted from some distance, but all occurring on the margin of the sea below the level of high water, and extending not infrequently much below the low water line. *Submarine forests* have been traced for several miles along the margins of the estuaries on the north and south shores of the county of Fife, and the existence of these may be accounted for by the encroachments of the sea in those estuaries.—*Submarine descent*, the art or operation of diving or descending to the bottom of the sea, and remaining there for a certain time, by means of diving bells or other contrivances. Various purposes are accomplished by *submarine descents*, such as levelling or clearing the bottoms of harbours, preparing a foundation for buildings under water, raising sunken materials, fishing for pearls, coral, sponges, &c. [See DIVING BELL.]—*Submarine navigation*, the art of sailing under the surface of the sea in vessels peculiarly constructed for that purpose. Various projects have been suggested for sailing under the surface of water, but none of them has hitherto succeeded.

**SUBMAXILLARY**, *a.* [L. *sub* and *maxilla*, the jaw-bone.] Situated under the jaw. The *submaxillary glands* are two salivary glands, situated, one on either side, immediately within the angle of the lower jaw.

**SUBMEDIAL**, or **SUBMEDIAN**, *a.* Lying under the middle.

**SUBMEDIAN**, *n.* In *music*, the sixth note, or middle note between the octave and subdominant. It is the greater sixth in the major scale, and the lesser sixth in the minor scale.

**SUBMENTAL**, *a.* In *anat.*, under the chin.

**SUBMERGE**, *v. t.* (submerg'ed.) [L. *sub-mergo*; *sub* and *mergo*, to plunge.] 1. To put under water; to plunge.—2.

To cover or overflow with water; to drown.

So half my Egypt was *submerg'ed*. *Shak.* **SUBMERGE**, *v. i.* (submerg'ed.) To plunge under water, as swallows.

**SUBMERG'ED**, *pp.* Put under water; overflowed.

**SUBMERG'ENCE**, *n.* Act of plunging under water.

**SUBMERG'ING**, *ppr.* Putting under water; overflowing.

**SUBMERS'ER**, *v. t.* [L. *sub* and *mergo*, to plunge.] To put under water; to drown. [Little used.]

**SUBMERSE**, } *a.* (submers'ed.) [L. **SUBMERS'ED**, } *mersus*.] Being or growing under water, as the leaves of aquatic plants.

**SUBMERS'ED**, *pp.* Pnt under water; drowned. [Little used.]

**SUBMERSION**, *n.* [Fr. from *submersus*.] 1. The act of putting under water or causing to be overflowed; as, the *submersion* of an isle or tract of land.—2. The act of plunging under water; the act of drowning.

**SUBMIN'ISTER**, } *v. t.* [L. **SUBMIN'ISTRATE**, } *istro*; *sub* and *ministro*.] To supply; to afford. **SUBMIN'ISTER**, } *v. i.* To subserv; to be useful to.

Our passions...*subminister* to the best and worst of purposes. *L'Estrange*.

[See MINISTER and ADMINISTER.] **SUBMIN'ISTRANT**, } *a.* Subservient; serving in subordination.

**SUBMINISTRA'TION**, } *n.* The act of furnishing or supplying.

**SUBMISS'**, } *a.* [L. *submissus*, *submitto*.] Submissive; humble; obsequious.

**SUBMISSION**, *n.* [L. *submitio*, from *submitto*; Fr. *soumission*; It. *sommessione*.] 1. The act of submitting; the act of yielding to power or authority; surrender of the person and power to the control or government of another. *Submission*, dauphin! 'tis a mere French word;

We English warriors wot not what it means. *Shak.*

2. Acknowledgment of inferiority or dependence; humble or suppliant behaviour.

In all *submission* and humility, York doth present himself unto your highness. *Shak.*

3. Acknowledgment of a fault; confession of error.

Be not as extreme in *submission*, as in offence. *Shak.*

4. Obedience; compliance with the commands or laws of a superior. *Submission* of children to their parents is an indispensable duty.—5. Resignation; a yielding of one's will to the will or appointment of a superior without murmuring. Entire and cheerful *submission* to the will of God is a Christian duty of prime excellence.—6. In *Scots law*, a deed by which parties agree to submit a disputed point to arbitration.

**SUBMIS'SIVE**, *a.* Yielding to the will or power of another; obedient.—2. Humble; acknowledging one's inferiority; testifying one's submission.

Her at his feet *submissive* in distress, He thus with peaceful words uprais'd. *Milton*.

**SUBMISS'IVELY**, *adv.* With submission; with acknowledgment of inferiority; humbly.

The goddess, Soft in her tone, *submissively* replies. *Dryden*.

**SUBMISS'IVENESS**, *n.* A submissive

temper or disposition.—2. Humbleness; acknowledgment of inferiority.—3. Confession of fault.

Frailly gets pardon by *submissiveness*. *Heybert*.

**SUBMISS'LY**, } *adv.* Humbly; with submission.

**SUBMISS'NESS**, } *n.* Humbleness; obedience.

**SUBMIT'**, *v. t.* [L. *submitto*; *sub*, under, and *mitto*, to send; Fr. *soumettre*; It. *soumettere*; Sp. *someter*.] 1. To let down; to cause to sink or lower.

Sometimes the hill *submits* itself a while. *Dryden*.

[This use of the word is nearly or wholly obsolete.]—2. To yield, resign, or surrender to the power, will, or authority of another; with the reciprocal pronoun,

Return to thy mistress, and *submit* thyself under her hand; Gen. xvi.

Wives, *submit yourselves* to your own husbands; Eph. v.

*Submit yourselves* to every ordinance of man; 1 Pet. ii.

3. To refer; to leave or commit to the discretion or judgment of another; as, to *submit* a controversy to arbitrators; to *submit* a question to the court.

**SUBMIT'**, *v. i.* To surrender; to yield one's person to the power of another; to give up resistance. The enemy *submitted*.

The revolted provinces presently *submitted*. *Middleton*.

2. To yield one's opinion to the opinion or authority of another. On hearing the opinion of the court, the counsel *submitted* without further argument.—3. To be subject; to acquiesce in the authority of another.

To thy husband's will Thine shall *submit*. *Milton*.

4. To be submissive; to yield without murmuring.

Our religion requires us...to *submit* to pain, disgrace, and even death. *Rogers*.

**SUBMIT'TED**, *pp.* Surrendered; resigned; yielded; referred.

**SUBMIT'TER**, *n.* One who submits. **SUBMIT'TING**, *ppr.* Surrendering; resigning; yielding; referring to another for decision.

**SUB MO'DO**, [L.] In a special manner; under a particular restriction.

**SUBMON'ISH**, } *v. t.* [L. *submoneo*.] To suggest; to prompt.

**SUBMON'TION**, } *n.* Suggestion.

**SUBMUL'TIPLE**, *n.* [See MULTIPLY.] A number or quantity which is contained in another a certain number of times, or is an aliquot part of it. Thus 7 is the *submultiple* of 56, being contained in it eight times.

**SUBMUL'TIPLE**, *a.* Noting a number or quantity which is exactly contained in another number or quantity a certain number of times; as, a *submultiple* number.—*Submultiple ratio*, the ratio which exists between an aliquot part of any number or quantity, and the number or quantity itself: Thus, the ratio of 3 to 21 is *submultiple*, 21 being a multiple of 3. The term is seldom employed by modern mathematicians.

**SUBNARCOTIC**, *a.* Moderately narcotic.

**SUBNAS'CENT**, *a.* [L. *sub* and *nascor*.] Growing underneath.

**SUBNECT'**, } *v. t.* [L. *subnecto*.] To tie, buckle, or fasten beneath.

**SUBNORM'AL**, *n.* [L. *sub* and *norma*, a rule.] In the *conic sections*, a sub-perpendicular, or the portion of a dia-

meter intercepted between the ordinate and the normal. In all curves the subnormal is a third proportional to the subtangent and the ordinate. [See NORMAL, ORDINATE, SUBTANGENT.]

**SUBNUDE**, *a.* [L. *sub* and *nudus*, naked.] In *bot.*, almost naked or bare of leaves.

**SUBOBSCURELY**, *adv.* Somewhat obscurely or darkly.

**SUBOCIPITAL**, *a.* Being under the occiput; as, the *suboccipital* nerves.

**SUBOC'TAVE**, } *a.* [L. *sub* and *oc-*  
**SUBOC'TUPLE**, } *tavus*, or *ocuple*.]  
Containing one part of eight.

**SUBOC'ULAR**, *a.* [L. *sub* and *oculus*.]  
Being under the eye.

**SUBORBIC'ULAR**, } *a.* [L. *sub* and  
**SUBORBIC'ULATE**, } *orbiculatus*.]  
Almost orbiculate or orbicular; nearly circular.

**SUBORDINACY**, *n.* [See SUBORDINATE.] The state of being subordinate or subject to control; as, to bring the imagination to act in *subordinacy* to reason.—2. Series of subordination. [Little used.]

**SUBORDINANCY**,† *n.* See SUBORDINACY.

**SUBORDINARY**, *n.* In *her.*, subordinaries are certain figures borne in charges in coat-armour, which are not considered to be so honourable as what are termed ordinaries, and to which the subordinaries give place, and cede the principal points of the shield. According to some writers, an ordinary, when it comprises less than one-fifth of the whole shield, is termed a *subordinary*.

**SUBORDINATE**, *a.* [L. *sub* and *ordinatus*, from *ordo*, order.] 1. Inferior in order, in nature, in dignity, in power, importance, &c.; as, *subordinate* officers.

It was *subordinate*, not enslaved, to the understanding. *South.*

2. Descending in a regular series.

The several kinds and *subordinate* species of each, are easily distinguished.

*Woodward.*

3. In *geol.*, inferior in the order of superposition; as *subordinate* strata.

**SUBORDINATE**, *v. t.* To place in an order or rank below something else; to make or consider as of less value or importance; as, to *subordinate* one creature to another; to *subordinate* temporal to spiritual things.—2. To make subject; as, to *subordinate* the passions to reason.

**SUBORDINATE**, *n.* One inferior in power, order, rank, dignity, office, &c.—2. One of a descent in a regular series.

**SUBORDINATED**, *pp.* Placed in an inferior rank; considered as of inferior importance; subjected.

**SUBORDINATELY**, *adv.* In a lower rank or of inferior importance.—2. In a series, regularly descending.

**SUBORDINATION**, *n.* [Fr. See SUBORDINATE.] The state of being inferior to another; inferiority of rank or dignity.—2. A series regularly descending.

Natural creatures having a local *subordination*. *Holiday.*

3. Place of rank among inferiors.

Persons, who in their several *subordinations*, would be obliged to follow the example of their superiors. *Swift.*

4. Subjection; state of being under control or government.

The most glorious military achievements

would be a calamity and a curse, if purchased at the expense of habits of *subordination* and love of order. *J. Ewart.*

**SUBORN'**, *v. t.* [Fr. *suborner*; L. *suborno*; *sub* and *orno*. The sense of *orno*, in this word, and the primary sense, is to *put on*, to furnish. Hence *suborno*, to furnish privately, that is, to bribe.] 1. In *law*, to procure a person to take such a false oath as constitutes perjury.—2. To procure privately or by collusion.

Or else thou art *suborn'd* against his honour. *Shak.*

3. To procure by indirect means.

Those who by despair *suborn* their death.

*Dryden.*

**SUBORNATION**, *n.* [Fr.] In *law*, a secret or underhand preparing, instructing, and bringing forward a witness to give false testimony; any act that allures or disposes to perjury.—*Subornation of perjury*, the wilfully procuring of any person to take a false oath amounting to perjury. It is essential to this offence that the false oath should be actually taken. The same punishment is assigned to subordination as to perjury. In *Scots law*, subordination of perjury, may, in some cases, be summarily tried in the course of proceedings either on complaint, or by the court itself. Attempts to suborn or to procure false testimony are in English law misdemeanours, and in *Scots law* are indictable.—2. The crime of procuring one to do a criminal or bad action.

**SUBORN'ED**, *pp.* Procured to take a false oath, or to do a bad action.

**SUBORN'ER**, *n.* One who procures another to take a false oath, or to do a bad action.

**SUBORN'ING**, *ppr.* Procuring one to take a false oath, or to do a criminal action.

**SUBOVAL**, *a.* Somewhat oval.

**SUBOVATE**, *a.* [L. *sub* and *ovatus*, from *ovum*, an egg.] Almost ovate; nearly in the form of an egg, but having the inferior extremity broadest.

**SUBOXIDE**, *n.* An oxide which consists of one equivalent of oxygen and two of another element. Such compounds are more frequently termed *dioxides*.

**SUBPERPENDIC'ULAR**, *n.* [sub and perpendicular.] A subnormal,—*which see.*

**SUBPET'IOULATE**, *a.* [sub and *petiole*.] In *bot.*, having a very short petiole.

**SUB'PLINTH**, *n.* In *arch.*, a second and lower plinth placed under the principal one in columns and pedestals.

**SUBPC'ENA**, } *n.* [L. *sub* and *pæna*,  
**SUBPE'NA**, } pain, penalty.] In *law*, a writ by which common persons are called into chancery, in cases where the common law has provided no ordinary remedy. Also, the writ for calling a witness to bear evidence, whether in the court of chancery, or in any other court, called the *sub-pæna ad testificandum*. And where the witness is required to bring with him books or writings to be produced in *modum probationis*, it is called *sub-pæna duces tecum*. The party or witness is called to appear, *subpæna centum librorum* (under penalty of £100); hence the use of the word.

**SUBPC'ENA**, } *v. t.* To serve with a  
**SUBPE'NA**, } writ of subpoena; to command attendance in court by a legal writ.

**SUBPC'NAED**, } *pp.* Served with a  
**SUBPE'NAED**, } writ of subpoena.  
**SUBPE'NAING**, } *ppr.* Commanding  
**SUBPE'NAING**, } attendance in  
court by a legal writ.

**SUBPRIN'ICIPAL**, *n.* An under principal.

**SUBPRIN'ICIPALS**, *n.* In *arch.*, auxiliary rafters or principal braces.

**SUBPR'IOR**, *n.* [sub and *prior*.] The vicegerent of a prior; a claustral officer who assists the prior.

**SUBPUR'CHASER**, *n.* A purchaser who buys from a purchaser.

**SUBQUAD'RATE**, *a.* Nearly square.

**SUBQUAD'RUPLE**, *a.* [sub and *quadruple*.] Containing one part of four; as, *subquadruple* proportion.

**SUBQUIN'QUEFID**, *a.* [sub and *quinquefid*.] Almost quinquefid.

**SUBQUIN'TUPLE**, *a.* [sub and *quintuple*.] Containing one part of five; as, *subquintuple* proportion.

**SUBRA'MOSE**, } *a.* [L. *sub* and *ramo-*  
**SUBRA'MOUS**, } *sus*, full of branches.]

In *bot.*, having few branches.

**SUB-READ'ER**, *n.* An under-reader in the inns of court.

**SUB-REC'TOR**, *n.* [sub and *rector*.] A rector's deputy or substitute.

**SUBREP'TION**, *n.* [L. *subreptio*, from *subrepto*, to creep under.] The act of obtaining a favour by surprise or unfair representation, that is, by suppression or fraudulent concealment of facts.

—2. In *Scots law*, the obtaining gifts of escheat, &c., by concealing the truth. *Obreption* signifies obtaining such gifts by telling a falsehood.

**SUBREPT'I'TIOUS**, } *a.* [L. *surrepti-*  
**SUBREP'TIVE**, } *tivus*, supra.]

Falsely crept in; fraudulently obtained. [See SURREPTITIOUSLY.]

**SUBREPT'I'TIOUSLY**, *adv.* By falsehood; by stealth.

**SUB'ROGATE**,† *v. t.* [L. *subrogo*.] To put in the place of another. [See Surorogate.]

**SUBROGA'TION**, *n.* In the *civil law*, the substituting of one person in the place of another, and giving him his rights; but in its general sense, the term implies a succession of any kind, whether of a person to a person, or of a person to a thing.

**SUB RO'SA**, [L.] Literally, *under the rose*; but meaning secretly; privately; in a manner that forbids disclosure.

**SUBROTUND'**, *a.* [L. *sub* and *rotundus*, round.] Almost round; almost orbicular.

**SUBSALINE**, *a.* Moderately saline or salt.

**SUB'SALT**, *n.* A salt having an excess of the base. It is opposed to *supersalt*.

**SUBSANNA'TION**, *n.* [L. *subsanno*.] Derision; scorn.

**SUBSCAP'ULAR**, *a.* [L. *sub* and *scapula*.] The *subscapular* artery is the large branch of the axillary artery, which rises near the lowest margin of the scapula. The *subscapular muscle* is a tendinous and fleshy muscle situated under the shoulder-blade, adhering to the capsular ligament, and inserted into the upper part of the lesser tuberosity, at the head of the *os humeri*. Its principal office is to roll the arm inwards. It likewise serves to bring it close to the ribs.

**SUBSCRIBABLE**, *a.* That may be subscribed.

**SUBSCRIBE**, *v. t.* [L. *subscribo* & *sub* and *scribo*, to write; Fr. *souscrire*.] Literally, to write underneath. Hence, —1. To sign with one's own hand; to

give consent to something written, or to bind one's self by writing one's name beneath; as, parties *subscribe* a covenant or contract; a man *subscribes* a bond or articles of agreement.—2. To attest by writing one's name beneath; as, officers *subscribe* their official acts; and secretaries and clerks *subscribe* copies of records.—3. To promise to give by writing one's name; as, each man *subscribed* ten pounds or ten shillings.—4.† To submit.

**SUBSCRIBE**, *v. i.* To promise with others a certain sum for the promotion of an undertaking by setting one's name to a paper. The paper was offered and many *subscribed*.—2. To assent; as, I could not *subscribe* to his opinion.

**SUBSCRIBED**, *pp.* Having a name or names written underneath. The petition is *subscribed* by two thousand persons.—2. Promised by writing the name and sum. A large sum is *subscribed*.

**SUBSCRIBER**, *n.* One who subscribes; one who contributes to an undertaking by subscribing.—2. One who enters his name for a paper, book, map, and the like.—3. One who makes an announcement to the public, in a journal, &c., with his name appended; as, the *subscriber* has on sale some fine tea.

**SUBSCRIBING**, *ppr.* Writing one's name underneath; assenting to or attesting by writing the name beneath; entering one's name as a purchaser.

**SUBSCRIPT**, *a.* Underwritten; as, a Greek letter *subscript*; thus, ϖ, which is equivalent to ω.

**SUBSCRIPT**, † *n.* Something underwritten.

**SUBSCRIPTION**, *n.* [*L. subscriptio.*]

1. Any thing, particularly a paper, with names subscribed.—2. The act of subscribing or writing one's name underneath; name subscribed; signature at the bottom of a letter, writing, or instrument.—3. Consent or attestation given by underwriting the name.—4. The act of contributing to any undertaking; the giving of any sum of money, or engaging to give it, for the furtherance of some common object in which several are interested; as, *subscriptions* in support of charitable institutions, and the like.—5. Sum subscribed; amount of sums subscribed. We speak of an individual *subscription*, or of the whole *subscription* to a fund.—6. In the *book trade*, an engagement to take a copy or a certain number of copies of some new publication on some stated terms.—7. In *eccles. matters*, a solemn declaration of one's assent to the articles of any church, by taking an oath, and subscribing one's name thereto, as occasion requires; as, *subscription* to the Thirty-nine Articles of the Church of England; *subscription* to the Confession of Faith of the Church of Scotland. *Subscription* to articles of religion is required of the clergy of every established church, and of some churches not established.—8.† Submission; or obedience.—*Subscription of deeds.* In *Scots law*, the subscription of deeds consists not only in the subscription of the grantor, but in the subscriptions of two witnesses specially named and designed. In *English law*, subscription is not essential to the validity of a deed, but sealing is absolutely necessary.

**SUBSECTION**, *n.* [*L. sub and sectio.*]

The part or division of a section; a subdivision; the section of a section.

**SUBSECTIVE**, *a.* [*L. subsequor, subsecutus.*] Following in a train or succession. [*Little used.*]

**SUBSELLIA**, *n. plur.* [*L. sellium, a bench or seat.*] In *eccles. arch.*, the small shelving seats in the stalls of churches or cathedrals, made to turn up upon hinges so as to form either a

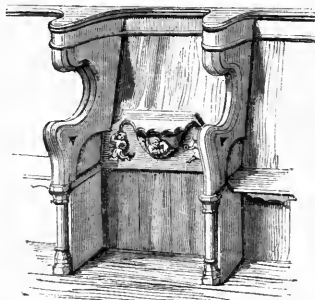

Subsellia, All Souls, Oxford, the Seat turned up.

seat, or a form to kneel upon, as occasion required. They are still in constant use on the Continent, though comparatively seldom used in England. They are also called *misereres*.

**SUBSEMITONE**, *n.* In *music*, the sharp seventh or sensible of any key.

**SUBSEPTUPLE**, *a.* [*L. sub and septuplus.*] Containing one of seven parts.

**SUBSEQUENCE**, } *n.* [*L. subsequor, subsequency.*] } *subsequens*; *sub* and *sequor*, to follow.] A following; a state of coming after something.

**SUBSEQUENT**, *a.* [*Fr. from L. subsequens, supra.*] 1. Following in time; coming or being after something else at any time, indefinitely; as, *subsequent* events; *subsequent* ages or years; a period long *subsequent* to the foundation of Rome.—2. Following in the order of place or succession; succeeding; as, a *subsequent* clause in a treaty. What is obscure in a passage may be illustrated by *subsequent* words.

**SUBSEQUENTLY**, *adv.* At a later time; in time after something else. Nothing was done at the first meeting; what was *subsequently* transacted, I do not know.—2. After something else in order. These difficulties will be *subsequently* explained.

**SUBSERVE**, *v. t.* (*subserv'*) [*L. subservio*; *sub* and *servio*, to serve.] To serve in subordination; to serve instrumentally. In most engines, we make the laws of matter *subserve* the purposes of art.

Not made to rule,

But to *subserve* where wisdom bears command. *Milton.*

**SUBSERVED**, *pp.* Served in subordination.

**SUBSERVIENCE**, } *n.* Instrumental

**SUBSERVIENCY**, } use; use or operation that promotes some purpose.

The body, wherein appears much fitness, use, and *subserviency* to infinite functions.

*Bentley.*

There is a regular subordination and *subserviency* among all the parts to beneficial ends. *Cheyne.*

**SUBSERVIENT**, *a.* [*L. subserviens.*]

1. Useful as an instrument to promote a purpose; serving to promote some end.

Hammond had an incredible dexterity, scarcely ever reading any thing which he did not make *subservient* in one kind or other. *Fell.*

2. Subordinate; acting as a subordinate instrument. These are the creatures of God, subordinate to him, and *subservient* to his will.

These ranks of creatures are *subservient* one to another. *Ruy.*

**SUBSERVIENTLY**, *adv.* In a *subservient* manner.

**SUBSERVING**, *ppr.* Serving in subordination; serving instrumentally.

**SUBSESILE**, *a.* [*L. sub and sessilis.*] In *bot.*, almost sessile; having very short footstalks.

**SUBSEX'TUPLE**, *a.* [*L. sub and sextuplus.*] Containing one part in six.

**SUBSIDE**, *v. i.* [*L. subsido*; *sub* and *sido*, to settle. *See SET.*] 1. To sink or fall to the bottom; to settle; as leas.—2. To fall into a state of quiet; to cease to rage; to be calmed; to become tranquil. Let the passions *subside*. The tumults of war will *subside*. Christ commanded, and the storm *subsid*ed.—3. To tend downward; to sink; as, a *subsiding* hill. The land *subsides* into a plain.—4. To abate; to be reduced.

In cases of danger, pride and envy naturally *subside*. *Middleton.*

**SUBSIDENCE**, } *n.* The act or pro-

**SUBSIDENCY**, } cess of sinking or falling, as in the lees of liquors.—2. The act of sinking or gradually descending, as ground or buildings.

**SUBSIDIARY**, *a.* [*Fr. subsidiaire*; *L. subsidiarius.* *See SUBSIDY.*] 1. Aiding; assistant; furnishing help. *Subsidiary* troops are troops of one nation hired by another for military service.—2. Furnishing additional supplies; as, a *subsidiary* stream.—*Subsidiary quantity* or *symbol*, in *math.*, a quantity or symbol which is not essentially a part of a problem, but is introduced to help in the solution. The term is particularly applied to angles in trigonometrical investigations.

**SUBSIDIARY**, *n.* An assistant; an auxiliary; he or that which contributes aid or additional supplies.

**SUBSIDIZE**, *v. t.* [*from subsidy.*] To furnish with a subsidy; to purchase the assistance of another by the payment of a subsidy to him. Great Britain *subsidized* some of the German powers in the late war with France.

**SUBSIDIZED**, *pp.* Engaged as an auxiliary by means of a subsidy.

**SUBSIDIZING**, *ppr.* Purchasing the assistance of by subsidies.

**SUBSIDY**, *n.* [*Fr. subsido*; *L. subsidium*, from *subsido*, literally to be or sit under or by.] 1. Aid in money; supply given; a tax; something furnished for aid, as by the people to their prince; as, the *subsidies* granted formerly to the kings of England. *Subsidies* were a tax, not immediately on property, but on persons in respect of their reputed estates, after the nominal rate of 4s. the pound for lands, and 2s. 8d. for goods.—2. A sum of money paid by one prince or nation to another, in pursuance of a treaty, to purchase the service of auxiliary troops, or the aid of such foreign prince in a war against an enemy. Thus Great Britain paid *subsidies* to Austria and Prussia, to engage them to resist the progress of the French.

**SUBSIGN**, *v. t.* (*subsi'ne.*) [*L. subsigno*; *sub* and *signo*, to sign.] To sign under; to write beneath. [*Little used.*]

**SUBSIGNATION**, *n.* The act of writing the name under something for attestation. [*Little used.*]

**SUB SILENTIO.** [L.] In silence or secrecy.

**SUBSIST**, *v. i.* [Fr. *subsister*; L. *subsisto*; *sub* and *sisto*, to stand, to be fixed.] 1. To be; to have existence; applicable to *matter* or *spirit*.—2. To continue; to retain the present state.

Firm we *subsist*, but possible to *swerve*.  
*Milton.*

3. To live; to be maintained with food and clothing. How many of the human race *subsist* on the labours of others! How many armies have *subsisted* on plunder!—4. To inhere; to have existence by means of something else; as, qualities that *subsist* in substances.

**SUBSIST**, *v. t.* To feed; to maintain; to support with provisions. The king *subsisted* his troops on provisions plundered from the enemy.

**SUBSISTENCE**, *n.* [Fr. *subsistence*; **SUBSISTENCY**,] *It. sussistenza.* 1. Real being; as, a chain of differing *subsistencies*.

Not only the things had *subsistence*, but the very images were of some creatures existing.  
*Stillingfleet.*

2. Competent provisions; means of supporting life.

His viceroy could only propose to himself a comfortable *subsistence* out of the plunder of his province.  
*Addison.*

3. That which supplies the means of living; as money, pay or wages.—4. Inherence in something else; as, the *subsistence* of qualities in bodies.

**SUBSISTENT**, *a.* [L. *subsistens*.] 1. Having real being; as, a *subsistent spirit*.—2. Inherent; as, qualities *subsistent* in matter.

**SUB/SOIL**, *n.* [*sub* and *soil*.] Under-soil, the bed or stratum of earth or earthy matter which intervenes between the surface soil and the base, or rocks on which this under-stratum rests. Subsoils are retentive or porous. A *retentive subsoil*, is one which does not absorb the moisture which collects in the surface soil. A *porous subsoil*, is one which absorbs the superfluous moisture of the surface soil. The former consists of clay, marl, and stony beds of various kinds, and the latter of gravel or sand, or it is one in which gravel or sand predominates. *Subsoil plough*, a swing plough of somewhat stronger construction than that in common use, but without the coulter and mould-board. The use of this plough is to follow the common plough, and loosen the subsoil at the bottom of the furrow, without raising it to the surface. It is the invention of Mr. Smith of Deanstone in Perthshire.

**SUBSOL'ARY**, *a.* Being under the sun.

**SUBSP'E/CIES**, *n.* [*sub* and *species*.] A subordinate species; a division of a species.

**SUBSTANCE**, *n.* [Fr.; *It. sustanza*; Sp. *substancia*; L. *substantia, substō*; *sub* and *sto*, to stand.] 1. In a *general sense*, being; something existing by itself; that which really is or exists; equally applicable to *matter* or *spirit*. Thus the soul of man is called an *immaterial substance*, a cogitative *substance*, a *substance* endowed with thought. We say, a stone is a *hard substance*; tallow is a *soft substance*.—2. In a *philosophical sense*, as contradistinguished from *accident*, that which exists independently and unchangeably, whilst *accident* denotes the changeable phenomena in substance, whether these phenomena are necessary or casual, in

which latter case they are called *accidents* in a narrower sense. The relation of accident to substance is called the relation of inherence, and corresponds to the logical relation of subject and predicate; because the substance is the subject to which are assigned the qualities, states, and relations, as predicates; substance itself is the essence which is capable of these phenomena, and in spite of these changes, remains the same. Substance is, with respect to the mind, a merely logical distinction from its attributes. We can never imagine it, but we are compelled to assume it. We cannot conceive substance shorn of its attributes, because those attributes are the sole staple of our conceptions, but we must assume that substance is something different from its attributes. Substance is the unknown, unknowable substratum, on which rests all that we experience of the external world.—3. The essential part; the main or material part. In this epitome we have the *substance* of the whole book. This edition is the same in *substance* with the Latin.  
*Burnet.*

4. Something real, not imaginary; something solid, not empty. Heroic virtue did his actions' guide,  
And he the *substance*, not th' appearance  
chose  
*Dryden.*

5. Body; corporeal nature or matter, that which is solid.—*Simple substances*. [See ELEMENTARY SUBSTANCES.] The qualities of plants are more various than those of animal *substances*. *Arbutnot.*

6. Goods; estate; means of living. Job's *substance* was seven thousand sheep, three thousand camels, &c.; Job i.

We are...exhausting our *substance*, but not for our own interest.  
*Swift.*

**SUBSTAN'TIAL**, *a.* Belonging to substance; real; actually existing.

If this atheist would have his chance to be a real and *substantial* agent, he is more stupid than the vulgar.  
*Bentley.*

2. Real; solid; true; not seeming or imaginary.

If happiness be a *substantial* good.  
*Denham.*  
The *substantial* ornaments of virtue.  
*L'Estrange.*

3. Corporeal; material. The rainbow appears like a *substantial* arch in the sky.  
*Watts.*

4. Having substance; strong; stont; solid; as, *substantial* cloth; a *substantial* fence or gate.—5. Possessed of goods or estate; responsible; moderately wealthy; as, a *substantial* freeholder or farmer; a *substantial* citizen.

**SUBSTANTIA'LIA**, *n. plur.* [L.] In *Scots law*, those parts of a deed which are essential to its validity as a formal instrument.

**SUBSTANTIALITY**, *n.* The state of real existence.—2. Corporeity; materiality.

The soul is a stranger to such gross *substantiality*.  
*Granville.*

**SUBSTAN'TIALIZE**, *v. t.* To realize.

**SUBSTAN'TIALLY**, *adv.* In the manner of a substance; with reality of existence.

In him his Father shone, *substantially* expressed.  
*Milton.*

2. Strongly; solidly.—3. Truly; solidly; really.

The laws of this religion would make men, if they would truly observe them, *substantially* religious toward God, chaste and temperate.  
*Tillotson.*

4. In substance; in the main; essentially. This answer is *substantially* the same as that before given.—5. With competent goods or estate.

**SUBSTANTIALNESS**, *n.* The state of being substantial.—2. Firmness; strength; power of holding or lasting; as, the *substantialness* of a wall or column.

**SUBSTANTIALS**, *n. plur.* Essential parts.

**SUBSTANTIATE**, *v. t.* To make to exist.—2. To establish by proof or competent evidence; to verify; to make good; as, to *substantiate* a charge or allegation; to *substantiate* a declaration.

**SUB'STANTIVE**, *a.* Betokening existence; as, the *substantive* verb to be.—2. Not adjective; as a noun-substantive.—3. Solid; depending on itself.—*Substantive colours*, those which, in the process of dyeing, remain fixed or permanent without the intervention of other substances, in distinction from *adjective colours*, which require the aid of mordants to fix them.

**SUB'STANTIVE**, *n.* In *gram.*, a noun or name; the part of speech which expresses something that exists, either material or immaterial. Thus man, horse, city, goodness, excellence, are *substantives*. [Better called *name*, L. *nomen*, or even *noun*, a corruption of *nomen*.]

**SUB'STANTIVELY**, *adv.* In substance; essentially.—2. In *gram.*, as a name or noun. An adjective or pronoun may be used *substantively*.

**SUB'STILE**, *n.* [*sub* and *stile*.] The line of a dial on which the stile is erected.

**SUB'STITUTE**, *v. t.* [Fr. *substituer*; L. *substituo*; *sub* and *statuo*, to set.] To put in the place of another.

Some few verses are inserted or *substituted* in the room of others.  
*Congreve.*

**SUB'STITUTE**, *n.* One person put in the place of another to answer the same purpose. A person may be a *substitute* with full powers to act for another in an office. Representatives in legislation are the *substitutes* of their constituents. The orthodox creed of Christians is that Christ died as the *substitute* of sinners.—2. One thing put in the place of another. If you have not one medicine, use another as its *substitute*.—3. In *law*, one delegated to act for another.—4. In the *militia*, one engaged to serve in the room of another.—*Substitutes in an entail*, in *Scots law*, those heirs who are called to the succession, failing the institute, whether dispocee or grantee.

**SUB'STITUTED**, *pp.* Put in the place of another.

**SUB'STITUTING**, *ppr.* Putting in the place of another.

**SUBSTITUTION**, *n.* The act of putting one person or thing in the place of another to supply its place; as, the *substitution* of an agent, attorney or representative to act for one in his absence; the *substitution* of bank notes for gold and silver, as a circulating medium.—2. State of being put in the place of another.—3. In *gram.*, syllepsis, or the use of one word for another.—4. In *civil law*, the designation of a second, third, or other heir to enjoy in default of a former heir, or after him. It includes all those modes of disposition which are known by the names of *entail, remainder, executory, devise*, &c. *Vulgar substitution* is that in which the testator names a second heir to receive

the succession, if the first should be unable or unwilling to do so.—*Fidei commissary substitution*, is that in which the second heir is named to receive the succession after the first. In *Scots law*, substitution is defined to be an enumeration of a series of heirs described in proper technical language. The substitution may be *simple*, calling certain heirs in their order, which the person in possession may at any time put an end to, even by a gratuitous deed; or it may be a substitution with prohibitory clauses, guarding the destination against the gratuitous deeds of the person in possession; or lastly, the substitution may be guarded by irritant and resolute clauses, whereby it becomes a statutory entail. There are substitutions also in movables, as in bonds of provision, legacies, &c.—5. In *alge*, the putting of one quantity in the place of another, to which it is equal but differently expressed. This process is frequently employed in the solution of equations.—*Chords of substitution in music*, are those of the ninth major and minor.

**SUBSTITUTIONAL**, *a.* Pertaining to substitution.

**SUBSTITUTIVE**, *a.* Furnishing a substitute.

**SUBTRACT**, *v. t.* [*L. subtrahō, subtractum.*] To subtract.

*Note.*—*Subtract* was formerly used in analogy with *abstract*. But in modern usage, it is written according to the Latin, *subtract*.—*See this word and its derivatives.*

**SUBSTRAC'TION**, *n.* In *law*, the withdrawing or withholding of some right. Thus the *substraction* of conjugal rights, is when either the husband or wife withdraws from the other and lives separate. The *substraction* of a legacy, is the withholding or detaining of it from the legatee by the executor. In like manner, the withholding of any service, rent, duty, or custom is a *substraction*, for which the law gives a remedy.

**SUBSTRATE**, *n.* That which lies beneath.

**SUBSTRATE**, *a.* Having very slight furrows.

**SUBSTRATUM**, *n.* [*L. substratus, spread under; sub and sterno.*] 1. That which is laid or spread under a stratum of earth lying under another. In *agriculture*, the subsoil.—2. In *meta.*, the matter or substance supposed to furnish the basis in which the perceptible qualities inhere. [*See SUBSTANCE.*]

**SUBSTRUC'TION**, *n.* [*L. constructio.*] Under building.

**SUBSTRUCTURE**, *n.* [*L. sub and structure.*] An under structure; a foundation.

**SUBSTYLAR**, *a.* In *dialling*, the *substylar* line is a right line on which the gnomon or style is erected at right angles with the plane.

**SUBSTYLE**, *n.* [*sub and style.*] In *dialling*, the line on which the gnomon stands. It is formed by the intersection of the face of the dial with the plane which passes through the gnomon.

**SUBSULPHATE**, *n.* A sulphate with an excess of the base.

**SUBSULTIVE**, } *a.* [from *L. subsultus*; } *sultus*, a leap, from *sub* and *salto*.] Bounding; leaping; moving by sudden leaps or starts, or by twitches.

**SUBSULTORILY**, *adv.* In a bound-

ing manner; by leaps, starts, or twitches.

**SUBSULT'US**, *n.* [*L.*] In *med.*, a starting, twitching, or convulsive motion; as, *subsultus tendinum*. Convulsive motions or twitchings of the tendons, which are observed in the extreme stages of debility produced by low nervous and typhus fevers.

**SUBSŪME**, } *v. t.* [*L. sub and sumo.*]

To assume a position by consequence. **SUBSUMPTION OF LIBEL**. In *Scots law*, a narrative of the alleged criminal act, which, to be good, must narrate facts amounting to the crime charged. It must also specify the manner, place, and time of the crime libelled, the person injured, &c.

**SUB'TACK**, *n.* In *Scots law*, an under lease; a lease of a farm, a tenement, &c., granted by the principal tenant or leaseholder.

**SUBTAN'GENT**, *n.* In the *conic sections*, the segment of a produced diameter or produced axis, intercepted between an ordinate and a tangent, both drawn from the same point in the curve. Thus, let C A be part of a parabola, A G its axis, C T a tangent to the curve at the point C, meeting the axis produced in T, and C D an ordinate to the axis, drawn from the point C; then the segment D T of the produced axis intercepted between C T and C D is called the *subtangent*.

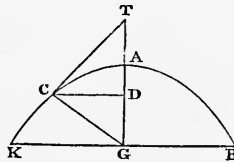

Also, if C G be drawn from the point C, perpendicular to the tangent C T, and meeting the axis in G, then C G is called the *normal*; and D G the part of the axis intercepted between the ordinate C D and the normal, is called the *subnormal*.

**SUBTEND**, *v. t.* [*L. sub and tendo, to stretch.*] To extend under; to extend or be opposite to; as, the line of a triangle which *subtends* the right angle; to *subtend* the chord of an arch. The apparent diameter of the sun *subtends* an angle at the observer's eye of rather more than 30 minutes.

**SUBTEND'ED**, *pp.* Extended under; being opposite to; as the greater angle of every triangle is *subtended* by the greater side.

**SUBTEND'ING**, *ppr.* Extending under; being opposite to.

**SUBTENSE**, *n.* (subtens'). [*L. sub and tensus.*] The chord of an arch or arc. A line or angle opposite to a line or angle spoken of. [*Not much used.*]

**SUBTEP'ID**, *a.* [*L. sub and tepidus, warm.*] Very moderately warm.

**SUBTER**, a Latin preposition, signifies under.

**SUBTERFLUENT**, } *a.* [*L. subterflu-*

**SUBTERFLUOUS**, } *ens, subterfluus.* Running under or beneath.

**SUBTERFUGE**, *n.* [*Fr.* from *L. subter* and *fugio*, to flee.] Literally, that to which a person resorts for escape or concealment; hence, a shift; an evasion; an artifice employed to escape censure or the force of an argument, or to justify opinions or conduct.

Affect not little shifts and *subterfuges*, to avoid the force of an argument. *Watts.*

**SUBTERRANE**, *n.* [*infra.*] A cave or room under ground.

**SUBTERRANEAN**, } *a.* [*L. subter,*  
**SUBTERRANEANOUS**, } under, and *terra*, earth; *Fr. souterrain*; *It. sotterraneo.*] Being or lying under the surface of the earth; situated within the earth or under ground; as, *subterranean springs*; a *subterranean* passage. *Subterranean forests*, accumulations of vegetable matter, involving roots, stems, branches, leaves, and fruits of trees, lying below the surface of the earth, and generally covered with peat to a greater or less depth. These differ from submarine forests, in not being limited to any particular level, nor to a close proximity with the sea. Such forests are found in various parts of Scotland, England, Ireland, and the Continent. [*Subterranean and Subterrany* are not in use.]

**SUBTERRANITY**, } *n.* A place under ground.

**SUBTERRANY**, } *n.* What lies under ground.

**SUBTERRENE**, *a.* Subterranean.

**SUB'TILE**, *a.* [*Fr. subtil*; *L. subtilis*; *It. sottile.*] 1. Thin; not dense or gross; extremely fine; as, *subtile air*; *subtile vapour*; a *subtile* medium; *subtile* odours, or effluvia.—2. Nice; fine; delicate.

I do distinguish plain Each *subtle* line of her immortal face.

*Davies.*

3. Acute; piercing; as, *subtile* pain.—4. Sly; artful; cunning; crafty; insinuating; as, a *subtile* person; a *subtile* adversary.—5. Planned by art; deceitful; as, a *subtile* scheme.—6. Deceitful; treacherous.—7. Refined; fine; acute; as, a *subtile* argument.

**SUB'TILELY**, *adv.* Thinly; not densely.—2. Finely; not grossly or thickly.

The opakest bodies, if *subtily* divided... become perfectly transparent. *Newton.*

3. Artfully; cunningly; craftily; as, a scheme *subtily* contrived.

**SUB'TILENESS**, *n.* Thinness; rareness; as, the *subtleness* of air.—2. Fineness; acuteness; as, the *subtleness* of an argument.—3. Cunning; artfulness; as, the *subtleness* of a foe.

**SUBTIL'LATE**, } *v. t.* To make thin.

**SUBTILIA'TION**, } *n.* The act of making thin or rare.

**SUBTIL'ITY**, *n.* Fineness; subtleness.

**SUBTILIZAT'ION**, *n.* [from *subtilize*.] The act of making subtle, fine or thin.

In the laboratory, the operation of making so volatile as to rise in steam or vapour.—2. Refinement; extreme acuteness.

**SUB'TILIZE**, *v. t.* [*Fr. subtiliser, from L. subtilis.*] 1. To make thin or fine; to make less gross or coarse.—2. To refine; to spin into niceties; as, to *subtilize* arguments.

**SUB'TILIZE**, *v. i.* To refine in argument; to make very nice distinctions.

In whatever manner the papist might *subtilize*. *Milner.*

**SUB'TILIZED**, *pp.* Made thin or fine.

**SUB'TILIZING**, *ppr.* Making thin or fine; refining.

**SUB'TILITY**, *n.* [*Fr. subtilité*; *L. subtilitas.*] 1. Thinness; fineness; exility; in a physical sense; as, the *subtility* of air or light; the *subtility* of sounds.—2. Refinement; extreme acuteness.

Intelligible discourses are spoiled by too much *subtility* in nice divisions. *Locke.*

3. Slyness in design; cunning; artifice; usually written *subtlety*.

**SUB'TLE**, *a.* (sut'tl.) [*See SUBTILE.*] Sly



in design; artful; cunning; insinuating; applied to persons; as, a subtle foe.—2. Cunningly devised; as, a subtle stratagem.

**SUB'TLENESS**, n. (sut'tleness.) Artfulness; cunning.

**SUB'TLETY**, n. (sut'tlety.) Subtleness.

**SUB'TLY**, adv. Silly; artfully; cunningly.

Thou seeest how *subtly* to detain thee I devise. Milton.

2. Nicely; delicately.

In the nice bee, what sense so *subtly* true. Pope.

**SUBTON'IC**, } n. The semitone or  
**SUBSEMI'TONE**, } note next below the tonic; the leading note of the scale.  
**SUBTRACT'**, v. t. [L. *subtraho, subtractus*; *sub* and *traho*, to draw.] To withdraw or take a part from the rest; to deduct. *Subtract 5* from 9, and the remainder is 4.

**SUBTRACT'ED**, pp. Withdrawn from the rest; deducted.

**SUBTRACT'ER**, n. He that subtracts.

2.† The number to be taken from a larger number. [See SUBTRAHEND.]

**SUBTRACT'ING**, ppr. Withdrawing from the rest; deducting.

**SUBTRACT'ION**, n. [L. *subtractio*.] 1. The act or operation of taking a part from the rest.—2. In *arith.*, the taking of a lesser number from a greater of the same kind or denomination; an operation by which is found the difference between two sums. Subtraction is one of the first four fundamental rules of arithmetic, and is either simple or compound, the first relating to numbers or quantities which are all of the same kind or denomination, and the latter to quantities of different denominations, as pounds, shillings, pence and farthings, hundred weights, quarters, pounds, ounces, &c.

**SUBTRACT'IVE**, a. Tending or having power to subtract.

**SUBTRAHEND'**, n. In *arith.*, the sum or number to be subtracted or taken from another, which is called the minuend. [These terms are now almost out of use.]

**SUBTRANSLU'CENT**, a. Imperfectly translucent.

**SUBTRANSPA'RENT**, a. Imperfectly transparent.

**SUBTRIP'FID**, a. Slightly trifid.

**SUBTRIP'LE**, a. [sub and triple.] Containing a third or one part of three. Thus 3 is subtriple of 9.—*Subtriple ratio*, the ratio of 1 to 3.

**SUBTRIP'PLICATE**, a. In the ratio of the cubic roots; thus  $\sqrt[3]{a}$  to  $\sqrt[3]{b}$  is the subtripluate ratio of *a* to *b*.

**SUBTU'TOR**, n. [sub and tutor.] An under tutor.

**SUBULA'RIA**, n. A genus of plants belonging to the nat. order Cruciferæ. [See AWLWORT.]

**SUB'ULATE**, } a. [L. *subula*, an awl.]  
**SUB'ULATED**, } In bot., shaped like an awl; awl-shaped. A *subulate leaf* is linear at the bottom, but gradually tapering toward the end. Applied also to filaments, styles, or stigmata.—2. In *conchology*, applied to shells tapering to a point.—3. In *entom.*, an epithet given to a long thin cone, softly bent throughout its whole course.

**SUBULICOR'NES**, n. A family of neuropterous insects, having awl-shaped antennæ. It includes the dragon-flies, and *Ephemera*, or May-flies.

**SUBUNDA'TION**, n. [L. *sub* and *unda*.] Flood; deluge.

**SUBUN'GUAL**, a. [L. *sub* and *unguis*, a nail.] Under the nail.

**SUB'URB**, } n. [L. *suburbium*; *sub* and  
**SUB'URBS**, } *urbs*, a city.] 1. A building without the walls of a city, but near them; or more generally, the parts that lie without the walls, but in the vicinity of a city. The word may signify buildings, streets or territory. We say, a house stands in the *suburbs*; a garden is situated in the *suburbs* of London or Paris.—2. The confines; the out part.

The *suburb* of their straw-built citadel. Milton.

**SUBURB'AN**, } a. [L. *suburbanus*. See  
**SUBURB'IAL**, } SUBURBS.] Inhabiting or being in the suburbs of a city.

**SUB'URBED**, a. Bordering on a suburb; having a suburb on its out part.

**SUBURBICA'RIAN**, or **SUBURB'ICARY**, a. [Low L. *suburbicarius*.] Being in the suburbs; an epithet applied to the provinces of Italy which composed the ancient diocese of Rome.

**SUBVARI'ETY**, n. [sub and *variety*.] A subordinate variety, or division of a variety.

**SUBVENTA'NEOUS**, † a. [L. *subventaneus*; *sub* and *ventus*.] Adde; windy.

**SUBVENT'ION**, n. [L. *subventio*.] 1. The act of coming under.—2. The act of coming to relief; support; aid. [Little used.]

**SUBVERSE**, † v. t. (subvers'). To subvert.

**SUBVER'SION**, n. [Fr. from L. *subversio*. See SUBVERT.] Entire overthrow; an overthrow of the foundation; utter ruin; as, the *subversion* of a government or state; the *subversion* of despotic power; the *subversion* of the constitution or laws; the *subversion* of an empire.

**SUBVER'SIVE**, a. Tending to subvert; having a tendency to overthrow and ruin. Every immorality is *subversive* of private happiness. Public corruption of morals is *subversive* of public happiness.

**SUBVERT'**, v. t. [L. *subverto*; *sub* and *verto*, to turn; Fr. and Sp. *subvertir*.] 1. To overthrow from the foundation; to overturn; to ruin utterly. The northern nations of Europe *subverted* the Roman empire. He is the worst enemy of man, who endeavours to *subvert* the Christian religion. The elevation of corrupt men to office will slowly, but surely, *subvert* a republican government.

This would *subvert* the principles of all knowledge. Locke.

2. To corrupt; to confound; to pervert the mind, and turn it from the truth; 2 Tim. ii.

**SUBVERT'ANT**, } In *her.*, reversed;  
**SUBVERT'ED**, } turned upside down, or contrary to the natural position or usual way of bearing.

**SUBVERT'ED**, pp. Overthrown; overturned; entirely destroyed.

**SUBVERT'ER**, n. One who subverts; an overthrower.

**SUBVERT'IBLE**, a. That may be subverted.

**SUBVERT'ING**, ppr. Overthrowing; entirely destroying.

**SUBW'ORK'ER**, n. [sub and *worker*.] A subordinate worker or helper.

**SUCCEDA'NEOUS**, a. [L. *succedaneus*; *sub* and *cedo*.] Supplying the place of something else; being or employed as a substitute.

**SUCCEDANEUM**, n. [supra.] That which is used for something else; a

substitute, a medicine or remedy substituted for another.

**SUCCEED**, v. t. [Fr. *succéder*; L. *succedo*; *sub* and *cedo*, to give way, to pass.] 1. To follow in order; to take the place which another has left; as, the king's eldest son *succeeds* his father on the throne. Queen Victoria *succeeded* her uncle, his late majesty William IV.; Nicholas, Emperor of Russia, *succeeded* his brother Alexander; General Taylor *succeeded* Mr. Polk in the presidency of the United States.—2. To follow; to come after; to be subsequent or consequent.

Those destructive effects *succeeded* the curse. Brown.

3. To prosper; to make successful. *Succeed my wish*, and second my design. Dryden.

**SUCCEED**, v. i. To follow in order. Not another comfort like to this, *Succeeds* in unknown fate. Shak.

2. To come in the place of one that has died or quitted the place, or of that which has preceded. Day *succeeds* to night, and night to day. Enjoy till I return

Short pleasures; for long woes are to *succeed*. Milton.

*Revenge succeeds* to love, and rage to grief. Dryden.

3. To obtain the object desired; to accomplish what is attempted or intended; to have a prosperous termination. The enemy attempted to take the fort by storm, but did not *succeed*. The assault was violent, but the attempt did not *succeed*.

It is almost impossible for poets to *succeed* without ambition. Dryden.

4. To terminate with advantage; to have a good effect.

Spenser endeavoured imitation in the Shepherds' Kalender; but neither will it *succeed* in English. Dryden.

5. To go under cover. Or will you to the cooler cave *succeed*? [Not much used.] Dryden.

**SUCCEED'ANT**, ppr. In *her.*, succeeding or following one another.

**SUCCEED'ED**, pp. Followed in order; prospered; attended with success.

**SUCCEED'ER**, n. One that follows or comes in the place of another; a successor. [But the latter word is generally used.]

**SUCCEED'ING**, ppr. Following in order; subsequent; coming after; as, in all *succeeding* ages. He attended to the business in every *succeeding* stage of its progress.—2. Taking the place of another who has quitted the place, or is dead; as, a son *succeeding* his father; an officer *succeeding* his predecessor.—3. Giving success; prospering.

**SUCCEED'ING**, n. The act or state of prospering or having success. There is a good prospect of his *succeeding*.

**SUCCENT'OR**, n. A person who sings the bass in a concert.

**SUCCESS**, n. [Fr. *succès*; L. *successus*, from *succedo*.] 1. The favourable or prosperous termination of anything attempted; a termination which answers the purpose intended; *properly in a good sense, but often in a bad sense*.

Or teach with more *success* her son, The vices of the time to shun. Waller.

Every reasonable man cannot but wish me *success* in this attempt. Tillotson.

Be not discouraged in a laudable undertaking at the ill *success* of the first attempt. Anon.

Military *successes*, above all others, elevate the minds of a people. Atterbury.

## 2. † Succession.

Note.—*Success*, without an epithet, generally means a prosperous issue.

**SUCCESSFUL**, *a.* Terminating in accomplishing what is wished or intended; having the desired effect; hence, *in a good sense*, prosperous; fortunate; happy; as, a *successful* application of medicine; a *successful* experiment in chemistry or in agriculture; a *successful* enterprise.—2. *In a bad sense*; as, a *successful* attempt to subvert the constitution.

**SUCCESSFULLY**, *adv.* With a favourable termination of what is attempted; prosperously; favourably.

A reformation *successfully* carried on.

*Swift.*

**SUCCESSFULNESS**, *n.* Prosperous conclusion; favourable event; success.

**SUCCESSION**, *n.* [Fr. from *L. successio*.] 1. A following of things in order; consecution; series of things following one another, either in time or place. Thus we speak of a *succession* of events in chronology, a *succession* of kings or bishops, and a *succession* of words or sentences.—2. The act of succeeding or coming in the place of another; as, this happened after the *succession* of that prince to the throne. So we speak of the *succession* of heirs to the estates of their ancestors, or collateral *succession*.—3. Lineage; an order or series of descendants.

A long *succession* must ensue. *Milton.*

4. The power or right of coming to the inheritance of ancestors. He holds the property by the title of *succession*. What people is so void of common sense, To vote *succession* from a native prince? *Dryden.*

5. In *music*, the successive notes in melody, in distinction from the successive chords of harmony, called *progression*.—*Law of succession*, in *political economy*, the law or rule according to which the succession to the property of deceased individuals is regulated. In *general*, this law obtains only in cases where a deceased party has died intestate, or in cases where the power of bequeathing property by will is limited by the legislature. In most countries, a preference has been given, in regulating the succession to property vacant by intestacy, and in defining the power to leave property by will, in favour of male heirs; and in some countries, especially in modern times, a marked predilection has been shown in favour of the eldest son, or, as it is usually termed, in favour of the right of *primogeniture*. In England and also in Scotland, when a person possessed of landed property dies intestate, his estate descends entire to his eldest son. The laws of England and of Scotland differ in some respects in regard to succession; but in both countries, the succession opens first to descendants, the preference being given to males. According to the law of England, when there is a failure of lineal descendants, the nearest lineal ancestor succeeds, a father inheriting before a brother, a grandfather before an uncle, &c. In default of father, brothers, or sisters of the whole blood and their issue, the succession opens to the eldest brother or sister of the half blood by a different mother. On failure of male ancestors on the paternal side, and their descendants, female paternal ancestors

and their descendants succeed. On failure of these, the mother, her ancestors—first male, then female,—and their respective descendants. In the law of Scotland, in default of descendants, the succession opens to collateral, as brothers and sisters; but brothers and sisters *uterine* (that is children by the same mother, but not, by the same father) do not succeed at all, there being no succession through the mother. Failing descendants and collaterals, the succession opens to ascendants; as, father, grandfather, &c., the mother being excluded. In regard to movable property, the order of succession is the same as in real or heritable property; but here no right of primogeniture, nor any preference of males to females is recognised, the property being divided in equal portions among the children or kinsmen of the deceased, without respect to sex or seniority.—*Apostolical succession*, in *theol.*, the uninterrupted succession of priests in the church by regular ordination, from the first apostles down to the present day.—*Doctrine of the apostolical succession*, the belief that the clergy thus regularly ordained, have a commission from God to preach the gospel, administer the sacraments, and guide the church; and that through their ministrations only, we can derive the grace which is communicated by the word and sacraments. Hence, according to this doctrine, those bodies of Christians whose pastors have not this regular succession, have, properly speaking, neither church nor sacraments. This doctrine is maintained by the church of Rome, and by the high-church party in the church of England; but it is repudiated by all other protestant churches.—*Succession of the signs*, in *astron.*, is the order in which the sun enters the signs of the Zodiac; as, Aries, Taurus, Gemini, &c.—*Succession of crops*, in *agriculture*, is more generally called *rotation*.

**SUCCESSIONAL**, *a.* Relating to succession; implying succession.

**SUCCESSIONALLY**, *adv.* By way of succession.

**SUCCESSIONIST**, *n.* One who adheres to succession.

**SUCCESSIVE**, *a.* [Fr. *successif*; It. *successivo*.] 1. Following in order or uninterrupted course, as a series of persons or things, and either in time or place; as, the *successive* revolutions of years or ages; the *successive* kings of Egypt. The author holds this strain of declamation through seven *successive* pages or chapters.

Send the *successive* ills through ages down. *Prior.*

2. Inherited by succession; as, a *successive* title; a *successive* empire. [Little used.]

**SUCCESSIVELY**, *adv.* In a series or order, one following another. He left three sons, who all reigned *successively*.

The whiteness at length changed *successively* into blue, indigo and violet. *Newton.*

**SUCCESSIVENESS**, *n.* The state of being successive.

**SUCCESSLESS**, *a.* Having no success; unprosperous; unfortunate; failing to accomplish what was intended.

*Successless* all her soft caresses prove. *Pope.*

Best temper'd steel *successless* prov'd in field. *Phillips.*

**SUCCESSLESSNESS**, *n.* Unprosperous conclusion.

**SUCCESSOR**, *n.* [L.] One that succeeds or follows; one that takes the place which another has left, and sustains the like part or character; correlative to *predecessor*; as, the *successor* of a deceased king; the *successor* of a president or governor; a man's son and *successor*.

A gift to a corporation, either of lands or of chattels, without naming their *successors*, vests an absolute property in them so long as the corporation subsists. *Blackstone.*

**SUCCIDUOUS**, *a.* [L. *succidius*; *sub* and *cado*.] Ready to fall; falling. [Little used.]

**SUCCIFEROUS**, *a.* [L. *succus*, juice, and *fero*, to bear.] Producing or conveying sap.

**SUCCINAMIDE**, *n.* A substance formed by the action of ammonia upon succinate of oxide of ethule. It is a crystalline solid, soluble in water and alcohol.

**SUCCINATE**, *n.* [from *L. succinum*, amber.] A salt formed by the succinic acid and a base; as, the succinate of ammonia.

**SUCCINATED**, *a.* Combined with succinic acid.

**SUCCINCT**, *a.* [L. *succinctus*; *sub* and *cingo*, to surround.] 1. Tucked up; girded up; drawn up to permit the legs to be free.

His habit fit for speed *succinct*. [Lit. us.] *Milton.*

2. Compressed into a narrow compass; short; brief; concise; as, a *succinct* account of the proceedings of the council.

Let all your precepts be *succinct* and clear. *Roscommon.*

**SUCCINCTLY**, *adv.* Briefly; concisely. The facts were *succinctly* stated.

**SUCCINCTNESS**, *n.* Brevity; conciseness; as, the *succinctness* of a narration.

**SUCCINIC**, *a.* Pertaining to amber.—*Succinic acid*, an acid obtained from amber by distilling it. It is also one of the products of the oxidation of stearic and margaric acids. When pure it is a white crystalline substance. It was formerly employed in medicine under the name of salt of amber, but it is now chiefly used in combination with ammonia, forming succinate of ammonia, in chemical investigations, especially in precipitating iron from solution.

**SUCCINITE**, *n.* [L. *succinum*, amber.] A mineral of an amber colour, considered as a variety of garnet. It frequently occurs in globular or granular masses, about the size of a pea.

**SUCCINOUS**, *a.* Pertaining to amber.

**SUCCINUM**, *n.* [L.] The Latin name for amber. It was called  $\mu\alpha\sigma\tau\epsilon\gamma\alpha$ , (electron) by the Greeks, whence our word electricity. [See AMBER.]

**SUC'CORY**, or **CHIC'ORY**, *n.* Wild endive, a plant of the genus *Cichorium*, the *C. intybus*, found growing wild on calcareous soils in England, and in most countries of Europe. In its natural state the stem rises from 1 to 3 feet high, but when cultivated it rises to the height of 5 or 6 feet. The root is white, fleshy, and yields a milky juice. It is cultivated in this country to some extent as an herbage plant; but in Germany, and some other parts of the Continent, it is extensively cultivated for the sake of its root, which,

when dried and ground, is used as a substitute for coffee, but as it wants the essential oil and rich aromatic flavour of coffee, it has nothing in common



Succory (*Cichorium intybus*).

with that article, except its colour, and little to recommend it except its cheapness. It has of late been used in this country as a substitute for, but more particularly to adulterate coffee. [See CICHORIUM, ENDIVE.]

**SUC'OTASH, n.** In *America*, green maize and beans boiled together. The dish, as well as the name, is borrowed from the native Indians.

**SUC'COUR, v. t.** [*Fr. secourir*; *L. succorro*; *sub* and *curro*, to run.] Literally, to run to, or run to support; hence, to help or relieve when in difficulty, want or distress; to assist and deliver from suffering; as, to *succour* a besieged city; to *succour* prisoners.

He is able to *succour* them that are tempted; Heb. ii.

**SUC'COUR, n.** Aid; help; assistance; particularly, assistance that relieves and delivers from difficulty, want or distress.

My father

Flying for *succour* to his servant Banister.

*Shak.*

2. The person or thing that brings relief. The city when pressed received *succours* from an unexpected quarter. The mighty *succour* which made glad the foe. *Dryden.*

**SUC'CURED, pp.** Assisted; relieved. **SUC'COURER, n.** He that affords relief; a helper; a deliverer.

**SUC'OURING, ppr.** Assisting; relieving.

**SUC'COURLESS, a.** Destitute of help or relief.

**SUC'CUBA, } n. [*L. sub* and *cubo*.] A  
**SUC'UBUS, }** [pretended kind of demon.**

**SUC'ULA, n.** In *mech.*, a bare axis or cylinder, with staves on it to move round.

**SUC'EULENCE, } n. [See SUCCULENT.]  
**SUC'EULENCY, }** Juiciness; as, the *succulence* of a peach.**

**SUC'EULENT, a.** [*Fr.*; *L. succulentus*, from *succus*, juice.] Full of juice; juicy. *Succulent* plants are such as have a juicy and soft stem, as distinguished from such as are ligneous, hard, and dry. Thus the grasses are *succulent* herbs; as are peas, beans, and the like.

**SUCCULENTÆ, n.** A nat. order of plants in the Linnæan system. It includes those families which are remarkable for the succulent character of their leaves, as Saxifragaceæ, Crasulaceæ, Ficoidæ, &c.

**SUC'EULENTLY, adv.** Juicily. **SUCCUMB', v. i.** [*L. succumbo*; *sub* and *cumbo, cubo*, to lie down.] 1. To yield; to submit; as, to *succumb* to a foreign power.—2. To yield; to sink unresistingly; as, to *succumb* under calamities.

**SUCCUMB'ING, ppr.** Yielding; submitting; sinking.

**SUC'EUS, n.** [*L.*] In *med.*, a term frequently employed to denote the extracted juice of different plants; as, *succus liquoritiæ*, Spanish liquorice, &c.

**SUCCUSSATION, n.** [*L. succusso*, to shake.] 1. A trot or trotting.—2. A shaking; succussion.

**SUCCUS'SION, n.** [*L. succussio*, from *succusso*, to shake; *sub* and *quasso*.] 1. The act of shaking; a violent shock.—2. In *med.*, an ague; a shaking, particularly of the nervous parts by medical stimulants.—3. A mode of exploring the chest, which consists in shaking the patient's body, and listening to the sounds thereby produced.

**SUCH, a.** [It is possible that this word may be a contraction of *Sax. swelc, swyle, G. solch, D. zolch*. More probably it is the *Russ. sitze, sitzev*, the old Scotch *sich*. *Qu. Lat. sic*.] 1. Of that kind; of the like kind. We never saw *such* a day; we have never had *such* a time as the present. It has as before the thing to which it relates. Give your children *such* precepts as tend to make them wiser and better. It is to be noted that the definitive adjective *a*, never precedes *such*, but is placed between it and the noun to which it refers; as, *such* a man; *such* an honour.—2. The same that. This was the state of the kingdom at *such* time as the enemy landed.—3. The same as what has been mentioned.

That thou art happy, owe to thyself. *Milton.*  
That thou continu'st *such*, owe to thyself.

4. Referring to what has been specified. I have commanded my servant to be at *such* a place.—5. *Such* and *such*, is used in reference to person, place, or thing of a certain kind.

The sovereign authority may enact a law, commanding *such* and *such* an action. *South.*

*Note.*—*Such* is usually considered by grammarians as an adjective pronoun.

**SUCK, v. t.** [*Sax. sucan, succan*; *G. saugen*; *Ir. sagham*; *W. sugaw*; *L. sugo*; *Fr. sucer*; *Sp. and Port. sacar*, to draw out.] 1. To draw with the mouth; to draw out, as a liquid from a cask, or milk from the breast; to draw into the mouth. To *suck* is to exhaust the air of the mouth or of a tube; the fluid then rushes into the mouth or tube by means of the pressure of the surrounding air.—2. To draw milk from with the mouth; as, the young of an animal *sucks* the mother or dam, or the breast.—3. To draw into the mouth; to imbibe; as, to *suck* in air; to *suck* the juice of plants.—4. To draw or drain. Old ocean *suck'd* through the porous globe. *Thomson.*

5. To draw in, as a whirlpool; to absorb.—6. To inhale.—*To suck in*, to draw into the mouth; to imbibe; to absorb.—*To suck out*, to draw out with the mouth; to empty by suction.—*To suck up*, to draw into the mouth.

**SUCK, v. i.** To draw by exhausting the air, as with the mouth, or with a tube.—2. To draw the breast; as, a child, or the young of an animal, is first

nourished by *sucking*.—3. To draw in; to imbibe.

**SUCK, n.** The act of drawing with the mouth.—2. Milk drawn from the breast by the mouth.

**SUCK'ED, pp.** Drawn with the mouth, or with an instrument that exhausts the air; imbibed; absorbed.

**SUCKEN, n.** [*Sax. soene*, privilege, immunity.] In *Scots law*, the jurisdiction attached to a mill, or the whole lands attached to a mill, the tenants of which are bound to bring their grain to the mill to be ground. The tenants subjected to this restriction are called *suckeners*. [See THIRLAGR.]

**SUCK'ER, n.** He or that which draws with the mouth.—2. A name vulgarly given to the piston of the common sucking pump.—3. A pipe through which anything is drawn.—4. In *bot.*, a shoot or branch which proceeds from the neck of the root of a plant beneath the surface, and becomes erect as soon as it emerges from the earth, immediately producing leaves and branches, and subsequently roots from its base, as in many roses. It is so called perhaps from its drawing its nourishment from the root or stem.—5. A fish, called also remora; also, a name of the Cyclopterus or lump-fish.—6. The name of a common river fish in New England; a species of *Catostomus*.—7. A piece of leather laid wet upon a stone, which adheres to the stone, and owing to the pressure of the atmosphere, requires considerable force to pull it off. The feet of various insects adhere to surfaces on the same principle.

**SUCK'ET, n.** A sweetmeat for the mouth.

**SUCK'ING, ppr.** Drawing with the mouth or with an instrument; imbibing; absorbing.

**SUCK'ING-BOTTLE, n.** A bottle to be filled with milk for infants to suck instead of the pap.

**SUCK'ING-FISH, n.** A fish of the genus *Echineis*, the *E. remora*, belonging to the order Malacopterygii sub-brachiati, Cuvier. It inhabits the Mediterranean sea, the Indian ocean, &c. [See REMORA.]

**SUCK'ING-PUMP, or SUC'TION-PUMP, n.** The common pump, in which the two valves open upwards. It is so named from an erroneous idea that the piston draws the water up after it by a sort of attraction. [See PUMP SUCTION.]

**SUCK'LE, † n.** A teat.

**SUCK'LE, v. t.** To give suck to; to nurse at the breast. Romulus and Remus are fabled to have been *sucked* by a wolf.

**SUCK'LED, pp.** Nursed at the breast.

**SUCK'LING, ppr.** Nursing at the breast.

**SUCK'LING, n.** A young child or animal nursed at the breast; *Ps. viii.*—2. A sort of white clover.

**SUC'TION, n.** [*Fr.*] The act of sucking or drawing into the mouth fluids and other substances, by removing more or less from the surface of the part on which the operation is performed the pressure of the air, whilst on every other portion the ordinary pressure remains. Suction, strictly speaking, consists in producing a partial vacuum, into which, when made by the mouth or otherwise, the fluid is forced by the external pressure of the atmosphere. The child obtains milk from the breast, by making a vacuum in its mouth, which exhausts the air from the pores

of the nipple, and the milk is consequently ejected from the breast by the unresisted elasticity of the air within.—2. The act of drawing, as fluids, into a pipe or other thing, which is effected on the same principle as that stated above.

**SUCTORIAL**, } a. Adapted for suck-  
**SUCTORIOUS**, } ing; that live by sucking; as, the humming birds are *suctorial*.

**SUCTORIANS**, *n.* A tribe of cartilaginous fishes, comprehending those which have a circular mouth adapted for suction; as the lamprey.

**SUDARY**,† *n.* [L. *sudarium*, from *sudo*, to sweat.] A napkin or handkerchief.

**SUDATION**, *n.* [L. *sudatio*.] A sweating.

**SUDATORY**, *n.* [L. *sudatorium*, from *sudo*, to sweat.] A hot house; a sweating bath.

**SUDATORY**, *a.* Sweating.

**SUD'DEN**, *a.* [Sax. *soden*; Fr. *soudain*; L. *subitaneus*.] 1. Happening without previous notice; coming unexpectedly, or without the common preparatives.

And sudden fear troubleth thee; Job xxi.

For when they shall say, peace and safety, then sudden destruction cometh upon them; 1 Thess. v.

2.† Hasty; violent; rash; precipitate; passionate.

**SUD'DEN**,† *n.* An unexpected occurrence; surprise.—*On a sudden*, sooner than was expected; without the usual preparatives.

How art thou lost, how on a sudden lost! Milton.

[Of a sudden, is not usual, and is less elegant.]

**SUD'DENLY**, *adv.* In an unexpected manner; unexpectedly; hastily; without preparation.

Therefore his calamity shall come suddenly; Prov. vi.

2. Without premeditation.

**SUD'DENNESS**, *n.* State of being sudden; a coming or happening without previous notice. The *suddenness* of the event precluded preparation.

**SUD'DER**, *n.* In India, the chief seat or head-quarters of government, as distinguished from the *Mofussil* or interior of the country.

**SUDOR**, *n.* [L.] Sweat or perspiration.

**SUDOR ANGLICA** NUS. See SWEATING-SICKNESS.

**SUDORIFIC**, *a.* [Fr. *sudorifique*; L. *sudor*, sweat, and *facio*, to make.] Causing sweat; as *sudorific* herbs.

**SUDORIFIC**, *n.* A medicine that produces sweat, a diaphoretic. Volatile salts, essential oils, guaiacum, antimonial and mercurial preparations, opium, musk, camphore, &c., are employed as sudorifics.

**SUDOROUS**, *a.* [L. *sudor*, sweat.] Consisting of sweat.

**SU'DRA**, } n. The lowest of the  
**SOD'DRAH**, } four great castes among the Hindoos.

**SUDS**, *n. plur.* [from Sax. *seothan*, to seethe, pret. *Sod*, pp. *Sodden*.] A lixivium of soap and water, or water impregnated with soap, and forming a frothy mass.

**SUE**, *v. t.* (su.) [Fr. *suivre*, to follow, L. *sequor*. See SEEK and ESSAY.] 1. To seek justice or right from one by legal process; to institute process in law against one; to prosecute in a civil

action for the recovery of a real or supposed right; as, to sue one for debt; to sue one for damages in trespass; Matt. v.—2. To gain by legal process.—3. To clean the beak, as a hawk; a term of falconry.—*To sue out*, to petition for and take out; or to apply for and obtain; as, to sue out a writ in chancery; to sue out a pardon for a criminal.

**SUE**, *v. t.* To prosecute; to make legal claim; to seek for in law; as, to sue for damages.—2. To seek by request; to apply for; to petition; to entreat.

By adverse destiny constrain'd to sue  
For counsel and redress, he sues to you. Pope.

3. To make interest for; to demand.

Cesar came to Rome, to sue for the double honour of a triumph and the consulship. Middleton.

**SU'ED**, *pp.* Prosecuted; sought in law.

**SU'ENT**, *a.* Even; smooth; plain; regularly. [Local.]

**SU'ENTLY**, *adv.* Evenly; smoothly; regularly.

**SU'ET**, *n.* [W. *seyv* and *swyved*, a surface, coating, suet, yeast, &c.] The fat situated about the loins and kidneys of animals. There are several kinds of it, according to the species of animal from which it is procured, as that of the hart, the goat, the ox, and the sheep. That of the ox and sheep is chiefly used, and when melted out of its containing membranes, it forms tallow. Mutton suet is used as an ingredient in cerates, plasters, and ointments, and beef suet, and also mutton suet, are used in cookery.

**SU'ETY**, *a.* Consisting of suet, or resembling it; as, a *suet* substance.

**SUF'FER**, *v. t.* [L. *suffero*; *sub*, under, and *fero*, to bear; as we say, to undergo; Fr. *souffrir*. See BEAR.] 1. To feel or bear what is painful, disagreeable or distressing, either to the body or mind; to undergo. We suffer pain of body; we suffer grief of mind. The criminal suffers punishment; the sinner suffers the pangs of conscience in this life, and is condemned to suffer the wrath of an offended God. We often suffer wrong; we suffer abuse; we suffer injustice.—2. To endure; to support; to sustain; not to sink under.

Our spirit and strength entire,  
Strongly to suffer and support our pains. Milton.

3. To allow; to permit; not to forbid or hinder. Will you suffer yourself to be insulted?

I suffer them to enter and possess. Milton.

Thou shalt in any wise rebuke thy neighbour, and not suffer sin upon him; Lev. xix.

4. To undergo; to be affected by. Substances suffer an entire change by the action of fire, or by entering into new combinations.—5. To sustain; to be affected by; as, to suffer loss or damage.

**SUF'FER**, *v. i.* To feel or undergo pain of body or mind; to bear what is inconvenient. We suffer with pain, sickness, or sorrow. We suffer with anxiety. We suffer by evils past, and by anticipating others to come. We suffer from fear and from disappointed hopes.—2. To undergo, as punishment.

The father was first condemned to suffer on a day appointed, and the son afterward, the day following. Clarendon.

3. To be injured; to sustain loss or damage. A building suffers for want

of seasonable repairs. It is just that we should suffer for neglect of duty.

Public business suffers by private infirmities. Temple.

**SUF'FERABLE**, *a.* That may be tolerated or permitted; allowable.—2. That may be endured or borne.

**SUF'FERABLENESS**, *n.* Tolerableness.

**SUF'FERABLY**, *adv.* Tolerably; so as to be endured.

**SUF'FERENCE**, *n.* The bearing of pain; endurance; pain endured; misery. He must not only die,

But thy unkindness shall the death draw out  
To ling'ring suffering. Shak.

2. Patience; moderation; a bearing with patience.

But hasty head temp'ring with suffering  
wise. Spenser.

3. Toleration; permission; allowance; negative consent by not forbidding or hindering.

In process of time, sometimes by suffering, sometimes by special leave and favour, they erected to themselves oratories.

Hooker.  
In their beginning, they are weak and wan,  
But soon through suffering grow to fearful end. Spenser.

An estate at suffering, in law, is where a person comes into possession of land by lawful title, but keeps it after the title ceases, without positive leave of the owner. Such person is called a *tenant at suffering*.

**SUF'FERED**, *pp.* Borne; undergone; permitted; allowed.

**SUF'FERER**, *n.* One who endures or undergoes pain, either of body or mind; one who sustains inconvenience or loss; as, sufferers by poverty or sickness. Men are sufferers by fire or losses at sea; they are sufferers by the ravages of an enemy; still more are they sufferers by their own vices and follies.—2. One that permits or allows.

**SUF'FERING**, *ppr.* Bearing; undergoing pain, inconvenience, or damage; permitting; allowing.

**SUF'FERING**, *n.* The bearing of pain, inconvenience, or loss; pain endured; distress, loss, or injury incurred; as, sufferings by pain or sorrow; sufferings by want or by wrongs.

**SUF'FERINGLY**, *adv.* With suffering or pain.

**SUF'FERINGS MEETING**, *n.* Called also *Meeting for Sufferings*; a standing committee of the Friends' Yearly Meeting, resembling the Commission of the General Assembly of the Established and Free Churches of Scotland. It is so called, because originally appointed to have charge of the sufferings sustained by Friends, in the support of their testimony against the exactions of the State Church; by which several thousand pounds are still annually taken from the society, for tithes, church rates, &c.

**SUFFICE**, *v. t.* (suffi'ze.) [Fr. *suffire*; L. *sufficio*; *sub* and *facio*.] To be enough or sufficient; to be equal to the end proposed.

To recount Almighty works  
What words or tongue of seraph can suffice? Milton.

**SUFFICE**, *v. t.* (suffi'ze.) To satisfy; to content; to be equal to the wants or demands of.

Let it suffice thee; speak no more to me of this matter; Deut. iii.

Lord, show us the Father, and it sufficeth us; John xiv.; Ruth ii.

2. To afford; to supply. The pow'r appears'd, with wind *suffic'd* the sail.† Dryden.

SUFFICED, *pp.* (suffi'zed.) Satisfied; adequately supplied.

SUFFI'CIENCE, *a.* Sufficiency.

SUFFI'CIENCY, *n.* The state of being adequate to the end proposed.

His *sufficiency* is such, that he bestows and possesses, his plenty being unexhausted. Boyle.

2. Qualification for any purpose.

I am not so confident of my own *sufficiency* as not willingly to admit the counsel of others. K. Charles.

3. Competence; adequate substance or means.

An elegant *sufficiency*, content. Thomson.

4. Supply equal to wants; ample stock or fund.—5. Ability; adequate power.

Our *sufficiency* is from God; 2 Cor. iii.

6. Conceit; self-confidence. [See SELF-SUFFICIENCY.]

SUFFI'CIENT, *a.* [L. *sufficiens*.] 1. Enough; equal to the end proposed; adequate to wants; competent; as, provision *sufficient* for the family; water *sufficient* for the voyage; an army *sufficient* to defend the country.

My grace is *sufficient* for thee; 2 Cor. xii.

2. Qualified; competent; possessing adequate talents or accomplishments; as, a man *sufficient* for an office.—3. Fit; able; of competent power or ability.

Who is *sufficient* for these things? 2 Cor. ii.

*Sufficient reason*, a term, or rather a principle, introduced by Leibnitz into his system of philosophy. According to this philosopher, all our reasonings are based upon two great principles; the one, that of *consistency*, by means of which we judge that to be false which involves a contradiction, and that to be true which is the reverse of the false; the other, that of *sufficient reason*, which admits nothing to exist without a sufficient reason of its existence, though that reason may not be known to us. Of contingent truths or facts, a sufficient reason must be found which may be traced up through a series of preceding contingencies, till they ultimately terminate in a necessary substance, which is a sufficient reason of the whole series of changes, and with which the whole series is connected. In this way Leibnitz demonstrated the being of God. The same principle has been employed in mathematics, to prove the equality of symmetrical solids or magnitudes which cannot be made to coincide or to fill the same space. Playfair, in his notes to his edition of Euclid's Elements, has expressed this principle as a general axiom, thus: "Things of which the magnitude is determined by conditions that are exactly the same, are equal to one another; or two magnitudes A and B are equal, when there is no reason that A should exceed B, rather than that B should exceed A." [See SYMMETRICAL.] By the aid of the principle of *sufficient reason*, we can compare geometrical quantities, whether they be of one, of two, or of three dimensions, nor is there any danger of being misled by this principle so long as it is confined to the objects of mathematical investigation; but in physical questions the same principle cannot be applied with equal safety, because in such cases we have seldom a complete definition of the thing which we reason about, or one which includes all its properties.

Still less admissible is this principle in questions of a metaphysical character. SUFFI'CIENTLY, *adv.* To a sufficient degree; enough; to a degree that answers the purpose, or gives content; as, we are *sufficiently* supplied with food and clothing; a man *sufficiently* qualified for the discharge of his official duties.

SUFFICING, *ppr.* (suffi'zing.) Supplying what is needed; satisfying.

SUFFY'CIINGNESS, *n.* The quality of being sufficient, or of affording 'satisfaction.

SUFFI'SANCE,† *n.* [Fr.] Sufficiency; plenty.

SUFFIX, *n.* [L. *suffixus*; *suffigo*; *sub* and *figo*, to fix.] A letter or syllable added or annexed to the end of a word.—2. A term lately introduced into mathematical language to denote the indices which are written under letters; as,  $x_0, x_1, x_2, x_3$ , &c.

SUFFIX', *v. t.* To add or annex a letter or syllable to a word.

SUFFIX'ED, *pp.* Added to the end of a word.

SUFFIX'ING, *ppr.* Adding to the end of a word.

SUFFLAMINATE, *v. t.* [L. *sufflamen*, a stop.] 1. To retard the motion of a carriage by preventing one or more of its wheels from revolving either by a chain or otherwise.—2.† To stop; to impede.

SUFFLATE, *v. t.* [L. *sufflo*; *sub* and *flo*, to blow.] To blow up; to inflate. [Little used.]

SUFFLA'TION, *n.* [L. *sufflatio*.] The act of blowing up or inflating.

SUFFOCATE, *v. t.* [Fr. *suffoquer*; L. *suffoco*; *sub* and *focus*, or its root.] 1. To choke or kill by stopping respiration. Respiration may be stopped by the interception of air, as in hanging and strangling, or by the introduction of smoke, dust, or mephitic air into the lungs. Men may be *suffocated* by the halter; or men may be *suffocated* in smoke or in carbonic acid gas, as in mines and wells.

And let not hemp his windpipe *suffocate*. Shak.

2. To stifle; to destroy; to extinguish; as, to *suffocate* fire or live coals.

A swelling discontent is apt to *suffocate* and strangle without passage. Collier.

SUFFOCATE, *a.* Suffocated.

SUFFOCATED, *pp.* Choked; stifled.

SUFFOCATING, *ppr.* Choking; stifling.

SUFFOCATINGLY, *adv.* So as to suffocate; as, *suffocatingly* hot.

SUFFOCA'TION, *n.* The act of choking or stifling; or a stopping of respiration, either by intercepting the passage of air to and from the lungs, or by inhaling smoke, dust, or air that is not respirable.—2. The act of stifling, destroying, or extinguishing.

SUFFOCATIVE, *a.* Tending or able to choke or stifle; as, *suffocative* catarrhs.

SUFFOLK CRAG, *n.* In *geol.*, a marine deposit of the older pliocene period. It consists of beds of sand and gravel, abounding in shells and corals. This deposit is so named from its being found in Suffolk, *crag* being a local name for gravel.

SUFFOSSION, *n.* [L. *suffossio*; *sub* and *fodio*, to dig.] A digging under; an undermining.

SUFFRAGAN, *a.* [Fr. *suffragant*; It. *suffraganeo*; L. *suffragans*, assisting; *suffragor*, to vote for, to favour.] As-

sisting; as, a *suffragan* bishop; but in ecclesiastical usage, every bishop is said to be *suffragan* relatively to the archbishop of his province.

SUFFRAGAN, *n.* A titular bishop ordained to assist a bishop in his spiritual functions. By 26 Henry VIII. *suffragans* are to be denominated from some principal place in the diocese of the prelate whom they are to assist.—2. A term of relation applied to every bishop, with respect to the archbishop who is his superior.

SUFFRAGANSHIP, *n.* The station of suffragan.

SUFFRAGANT,† *n.* An assistant; a favourer; one who concurs with.

SUFFRAGANT, *a.* Assisting.

SUFFRAGATE,† *v. t.* [L. *suffragor*.] To vote with.

SUFFRAGATOR, *n.* [L.] One who assists or favours by his vote.

SUFFRAGE, *n.* [L. *suffragium*; Fr. *suffrage*; Sax. *frægnan*, to ask, G. *fragen*.] 1. A vote; a voice given in deciding a controverted question, or in the choice of a man for an office or trust. Nothing can be more grateful to a good man than to be elevated to office by the unbiased *suffrages* of a free enlightened people.

Lactantius and St. Austin confirm by their *suffrages* the observation made by heathen writers. Atterbury.

2. United voice of persons in public prayer.—3.† Aid; assistance; a *Latinism*.

SUFFRAG'INOUS, *a.* [L. *suffrago*, the pastern or hough.] Pertaining to the knee-joint of a beast.

SUFFRUTES'CENT, *a.* Moderately frutescent.

SUFFRUTICOSE, } *a.* [L. *sub* and

SUFFRUTICOUS, } *fruticulosus*; *fruticosa*, a shrub.] In *bot.*, under-shrubby, or part shrubby; permanent or woody at the base, but the yearly branches decaying; as sage, thyme, hyssop, &c.

SUFFUMIGATE, *v. t.* [L. *suffumigo*.] To apply fumes or smoke to the parts of the body, as in medicine.

SUFFUMIGATING, *ppr.* Applying fumes to the parts of the body.

SUFFUMIGA'TION, *n.* Fumigation; the operation of smoking any thing, or rather of applying fumes to the parts of the body.—2. A term applied to all medicines that are received in the form of fumes.

SUFFUMIGE, *n.* A medical fume.

SUFFUSE, *v. t.* (suffu'ze.) [L. *suffusus*, *suffundo*; *sub* and *fundo*, to pour.] To overspread, as with a fluid or tincture; as, eyes *suffused* with tears; cheeks *suffused* with blushes.

When purple light shall next *suffuse* the skies. Pope.

SUFFUSED, *pp.* Overspread, as with a fluid or with colour.

SUFFUSING, *ppr.* Overspreading, as with a fluid or tincture.

SUFFUSION, *n.* [Fr. from L. *suffusio*.] 1. The act or operation of overspreading, as with a fluid or with a colour.—2. The state of being suffused or spread over.

To those that have the jaundice or like *suffusion* of eyes, objects appear of that colour. Ray.

3. That which is suffused or spread over.—4. In *med.*, a cataract. Also an extravasation of some humour, as the blood. Thus we say, a *suffusion* of blood in the eye, when it is what is vulgarly called bloodshot.

SU'FL, } n. A kind of Mussulman re-  
SO'FL, } cluse, of contemplative habits.  
SUG, n. [L. *sugo*, to suck.] A small  
kind of worm.

SUGAR, n. (shug'ar.) [Fr. *sucre*; G. *zucker*; D. *sukker*; W. *sygur*; Ir. *siacra*; L. *saccharum*; Gr. *σακχαρον*; Pers. Ar. *sukkar*; Sans. *scharhara*. It is also in the Syr. and Eth.] 1. A well known sweet granular substance, prepared chiefly from the expressed juice of the sugar-cane (*Saccharum officinarum*), but obtained also from a great variety of other plants; as maple, beet root, birch, parsnep, &c. The process of manufacturing sugar, as carried on in our West India Islands, consists in pressing out the juice of the canes by passing them between the rollers of a rolling-mill. The juice is received in a shallow trough placed beneath the rollers. This saccharine liquor is concentrated by boiling, which expels the water; lime is added to neutralize the acid that is usually present; the grosser impurities rise to the surface, and are separated in the form of scum. When duly concentrated, the syrup is run off into shallow wooden coolers, where it concretes; it is then put into hogsheads with holes in the bottom, through which the molasses drain off into cisterns below, leaving the sugar in the state known in commerce by the name of *raw* or *muscovado* sugar. This is further purified by means of clay, or more extensively by bullocks' blood, which, forming a coagulum, envelopes the impurities. Thus clarified, it takes the names of *lump*, *loaf*, *refined*, &c., according to the different degrees of purification. The manufacture of sugar from beet root is carried on to a very considerable extent in several parts of the Continent, particularly in France. In the United States and in Canada, great quantities of sugar are obtained from the sap of the sugar maple (*Acer saccharinum*), but this kind of sugar is inferior both in grain and strength to that which is produced from the cane. Sugar is a proximate element of the vegetable kingdom, and is found in most ripe fruits, and many farinaceous roots. By fermentation, sugar is converted into alcohol, and hence forms the basis of those substances which are used for making intoxicating liquors, as molasses, grapes, apples, malt, &c. The ultimate elements of sugar are oxygen, carbon, and hydrogen. The West Indies, Brazil, Surinam, Java, Mauritius, Bengal, Siam, the Isle de Bourbon, and the Philippine Islands, are the principal sources whence the supplies of sugar required for the European and American markets are derived. Sugar in this country ranks rather among the indispensable necessities of life, than among luxuries. Of all vegetable principles, it is considered by many eminent physicians as the most wholesome and nutritious.—2. *Sugar of lead*, the acetate of lead; called *saccharum saturni* by the older chemists, from a supposed resemblance in its crystals to sugar, or from their having a slight sweetness in the mouth. Sugar of lead, though poisonous, is useful in medicine, having a strongly detensive quality; and is much employed in calico-printing.—3. *Sugar of milk*, lactine,—which see. SUGAR, a. (shug'ar.) Made of sugar; sugary.

SUGAR, v. t. (shug'ar.) To impregnate, season, cover, sprinkle, or mix with sugar.—2. To sweeten.  
But flattery still in *sugar'd* words betrays.  
Denham.

SUGAR-BAKER, n. One who refines sugar, or makes loaf-sugar.

SUGAR-CANDY, n. [*sugar* and *candy*.] Sugar clarified and concreted or crystallized.

SUGAR-CANE, n. [*sugar* and *cane*] The cane or plant from whose juice sugar is obtained; *Saccharum officinarum*. It resembles the reeds common in morasses, except that its skin is soft, and its pulp a spongy substance. It usually grows to the height of 18 to 20 feet, with a diameter of two inches. It is divided by knots at the distance of 18 inches from each other. At its top it protrudes several long green leaves, and in the centre of these is its flower. When the leaves springing from the knots decay, the plant is ripe. It is then cut, stripped of its leaves, and carried to the mills, where it is crushed and its juice expressed. [See SACCHARUM.]



Sugar Cane  
(*Saccharum officinarum*).

SUGARED, pp. Sweetened.

SUGAR-HOUSE, n. A building in which sugar is refined.

SUGAR-KETTLE, n. A boiler used for boiling down saccharine juice.

SUGARLESS, a. Free from sugar.

SUGAR-LOAF, n. A conical mass of refined sugar.

SUGAR-MAPLE, n. A tree of the genus *Acer*, the *A. saccharinum*, a native of North America, where it is also known under the name of rock maple. Its average height is from 50 to 60 feet, with a diameter of from 12 to 18 inches. To obtain the sap the trees are perforated at the proper season (February and March), and tubes inserted into the orifices. Through these tubes the sap flows, and is received in troughs. From the troughs it is conveyed to boilers, and manufactured into sugar on the spot. [See MAPLE.]

SUGAR-MILL, n. A machine for pressing out the juice of the sugar-cane. It consists of three rollers placed vertically or horizontally, and parallel to each other. These are driven by a steam-engine, by water, or by animal power. The canes are made to pass between the rollers, by which means they are crushed, and the juice expressed from them. The annexed illustration represents the form of sugar-mill generally in use in our colonies. The motive power (derived either from a steam-engine or a cattle gin), is applied to the upper roller *a*, through the shaft *d*, and is communicated with an equal velocity, by means of the spur pinions *b* and *c*, to the two lower rollers, which are brought nearly into contact with the upper. The canes are spread upon the feeding table *e*, regularly, and, as nearly as possible, at

right angles to the axes of the rollers, by which they are drawn forward and crushed so as to separate the liquor, which flows downwards into the hol-

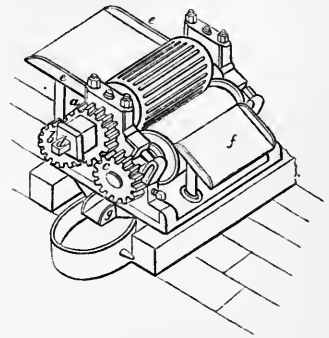

Horizontal Sugar Mill.

low bed of the mill, and is then drawn off by a spout *g*, while the empty canes are detached from the rollers, and guided to the floor of the mill by the delivering board *f*.

SUGAR-MITE, n. [*sugar* and *mite*.] A winged insect; Lepisma. The *Lepisma saccharina* is an apterous or wingless insect, covered with silvery scales.

SUGAR-PLUM, n. [*sugar* and *plum*.] A species of sweetmeat in small balls.

SUGAR-REFINERY, a. A sugar-house.

SUGAR-TREE, n. The sugar-maple,—which see.

SUGARY, a. Tinctured or sweetened with sugar; sweet; tasting like sugar.—2. Fond of sugar, or of sweet things.

—3. Containing sugar.—4. Like sugar.

SUGES'CENT, a. [L. *sugens*, sucking.] Relating to sucking.

SUGGEST, v. t. [L. *suggero*, *suggestus*; *sub* and *gero*; Fr. *suggerer*.] 1. To hint; to intimate or mention in the first instance; as, to suggest a new mode of cultivation; to suggest a different scheme or measure; to suggest a new idea.—2. To offer to the mind or thoughts.

Some ideas are suggested to the mind by all the ways of sensation and reflection.

Locke.

3. To seduce; to draw to ill by insinuation.

Knowing that tender youth is soon suggested.†  
Shak.

4. To inform secretly.

We must suggest the people. Shak.

SUGGESTED, pp. Hinted; intimated.

SUGGESTER, n. One that suggests.

SUGGESTING, ppr. Hinting; intimating.

SUGGESTION, n. [Fr.; from *suggest*.] A hint; a first intimation, proposal, or mention. The measure was adopted at the suggestion of an eminent philosopher.—2. Presentation of an idea to the mind; as, the suggestions of fancy or imagination; the suggestions of conscience.—3. Insinuation; secret notification or incitement.—4. In law, information without oath.—*Principle of suggestion*, a term employed by Dr. Brown to express what other philosophers call the *association of ideas*. That mental capacity by which feelings, formerly existing, are revived, in consequence of the mere existence of other feelings, Dr. Brown terms *simple suggestion*; and that mental capacity of

feeling, resemblance, difference, proportion, or relation in general, when two or more external objects, or two or more feelings of the mind itself, are considered by us, he calls, in distinction from the former, the capacity of *relative suggestion*. [See ASSOCIATION.]  
**SUGGESTIVE**, *a.* Containing a hint or intimation.

**SUG'GIL**, † *v. t.* [*L. suggillo.*] To defame.

**SUG'GILATE**, † *v. t.* [*L. suggillo.*] To beat livid or black and blue.

**SUGGILA'TION**, † *n.* A livid or black and blue mark; a blow; a bruise.

**SU'ICIDAL**, } *a.* Partaking of the  
**SUICIDAL**, } crime of suicide.

**SUICIDALLY**, *adv.* In a suicidal manner.

**SU'ICIDE**, *n.* [Fr. from *I. suicidium*; *se* and *cædo*, to slay.] 1. Self-murder; the act of designedly destroying one's own life. To constitute suicide, in a legal sense, the person must be of years of discretion and of sound mind. Suicide, by the law of England, is a crime, the legal effect of which is a forfeiture to the crown of all the personal property which the party had at the time he committed the act by which the death was caused, including debts due to him, but it is not attended with forfeiture of freehold, or corruption of blood. In order to vest these chattels in the crown, the fact of self-murder must be proved by an inquisition. In *Scots law*, suicide draws after it the falling of the single escheat, or forfeiture to the crown of the person's movable estate; and a proof of the self-murder may be brought in an action before the court of session, at the instance of the queen's donatory, against the executors of the deceased.

—2. One guilty of self-murder; a *felô de se*, or a person who, being of the years of discretion and in his senses, destroys himself.

**SU'ICIDISM**, *n.* State of self-murdering.

**SU'ICISM**, for *Suicide*, is not in use.

**SU'IDÆ**, *n.* [*L. sus*, a hog or a swine.] Swine, a family of pachydermatous mammalia, of high importance to man for economical purposes. The animals composing this family are characterized by having on each foot two large principal toes, shod with stout hoofs, and two lateral toes, which are much shorter, and hardly touch the earth. The incisor teeth are variable in number, but the lower incisors are all levelled forwards; the canines are projected from the mouth and recurved upwards. The muzzle is terminated by a truncated snout, fitted for turning up the ground. The family includes the domestic hog, of which there is an endless variety of

domestic hog; the masked boar of Africa, *Phacochaerus*; the *Babyroussa*,

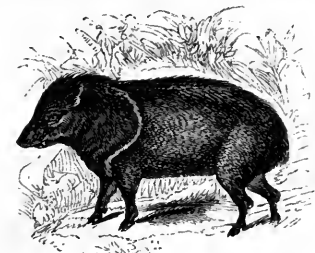

Collared Peccary (*Sus tajassu*.)

a native of Asia; and the Peccary, (*Dicotyles*, Cuv.), a native of America.  
**SU'IGENERIS**. [*L.*] Of its own or peculiar kind; singular.

**SUILLAGE**, † *n.* [Fr. *souillage.*] Drain of filth.

**SU'ING**, *ppr.* of *Sue*. Prosecuting.

**SU'ING**, † *n.* [Fr. *suer*, to sweat, *L. sudo.*] The process of soaking through any thing.

**SUIT**, *n.* [Norm. *suit* or *svyt*; Fr. *suite*, from *suivre*, to follow, from *L. sequor*. See **SEEK**. In Law Latin, *secta* is from the same source.] Literally, a following; and so used in the old English statutes. 1. Consecution; succession; series; regular order; as, the same kind and suit of weather. [*Not now so applied.*]—2. A set; a number of things used together, and in a degree necessary to be united, in order to answer the purpose; as, a *suit* of curtains; a *suit* of armour; a *suit* of sails for a ship; sometimes with less dependence of the particular parts on each other, but still united in use; as, a *suit* of clothes; a *suit* of apartments.

—3. A set of the same kind or stamp; as, a *suit* of cards.—4. Retinue; a company or number of attendants or followers; attendance; train; as, a nobleman and his *suit*. But in this sense the word is usually written *suite*,—*which see.*—5. A petition made to the king or to any great person; a seeking for something by petition or application.

Many shall make *suit* to thee; Job xi.  
 6. Solicitation of a woman in marriage; courtship.—7. In *law*, an action or process for the recovery of a right or claim; legal application to a court for justice; prosecution of right before any tribunal; as, a *civil suit*; a *criminal suit*; a *suit* in chancery. Where the remedy is sought in a court of law, the term *suit* is synonymous with *action*; but when the proceeding is in a court of equity, the term *suit* alone is used. The term is also applied to proceedings in the ecclesiastical and admiralty courts.

In England, the several *suits* or remedial instruments of justice, are distinguished into three kinds, actions personal, real, and mixed. *Blackstone.*

8. Pursuit; prosecution; chase.—*Suit and service*, in *feudal law*, the duty of feudatories to attend the courts of their lords or superiors in time of peace, and in war to follow them and perform military service.—*To bring suit*, a phrase in law, denoting literally to bring *secta*, followers or witnesses to prove the plaintiff's demand. The phrase is antiquated, or rather it has changed its signification; for to *bring a suit*, now is to institute an action.—

*Out of suits*, having no correspondence.—*Suit-covenant*, in *law*, is a covenant to sue at a certain court.—*Suit-court*, in *law*, the court in which tenants owe attendance to their lord.—*Suit of court*, an obligation to follow; that is, to attend, and to assist in constituting a court. It is either *real* or *personal*. *Suit-real*, or rather *suit-regal*, is the obligation under which all the residents within a leet or town are bound, in respect of their allegiance as subjects, to attend the king's criminal court for the district.—*Suit-personal*, is an obligation to attend the civil courts of the lord under whom the suitor holds lands or tenements, and this is either *suit-service* or *suit-custom*. If freehold lands, &c., be holden of the king immediately, *suit-service* is performed by attendance at the county court. If freehold lands, &c., are held mediately only of the king, but immediately of an inferior lord, the *suit-service* demandable is attendance at the court-baron of the lord. In manners where there are copyhold estates, the custom of the manor imposes upon the copyholder an obligation to attend the lord's customary court; but as this obligation is not annexed by the tenure to the land held by the copyholder, but is annexed by custom to his position as tenant, the *suit* is not *suit-service*, but *suit-custom*.

**SUIT**, *v. t.* To fit; to adapt; to make proper. *Suit* the action to the word. *Suit* the gestures to the passion to be expressed. *Suit* the style to the subject.—2. To become; to be fitted to.

Ill *suits* his cloth the praise of railing well.

*Dryden.*

Raise her notes to that sublime degree, Which *suits* a song of piety and thee. *Prior.*

3. To dress; to clothe.

Such a Sebastian was my brother too, So went he *suit*ed to his watery tomb.

*Shak.*

4. To please; to make content. He is well *suit*ed with his place.

**SUIT**, *v. i.* To agree; to accord; as, to *suit with*; to *suit to*. *Pity suits with* a noble nature.

Give me not an office

That *suits* with me so ill. *Addison.*  
 The place itself was *suit*ing to his care.

*Dryden.*

[The use of *with*, after *suit*, is now most frequent.]

**SUITABILITY**, *n.* Suitableness,—*which see.*

**SUITABLE**, *a.* Fitting; according with; agreeable to; proper; becoming; as, ornaments *suitable* to one's character and station; language *suitable* to the subject.—2. Adequate. We cannot make *suitable* returns for divine mercies.

**SUITABLENESS**, *n.* Fitness; propriety; agreeableness; a state of being adapted or accommodated. Consider the laws, and their *suitableness* to our moral state.

**SUITABLY**, *adv.* Fitly; agreeably; with propriety. Let words be *suitably* applied.

**SUITE**, *n.* (sweet.) [Fr.] Retinue; a company or number of attendants or followers; attendance; train; as, a nobleman and his *suite*.

**SUITED**, *pp.* Fitted; adapted; pleased. **SUITING**, *ppr.* Fitting; according with; becoming; pleasing.

**SUITOR**, *n.* One that sues or prosecutes a demand of right in law, as a plaintiff, petitioner, or an appellant.—

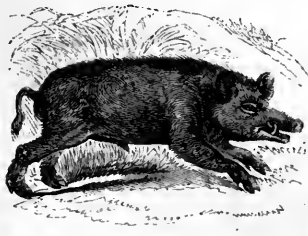

Wild Boar (*Sus scrofa*).

breeds; the wild boar, (*Sus scrofa*, Linn.) which is the parent stock of our

2. One who attends a court, whether plaintiff, defendant, petitioner, appellant, witness, juror, or the like. These, in legal phraseology, are all included in the word *suitors*.—3. A petitioner; an applicant.  
She hath been a *suito*r to me for her brother.

Shak.

4. One who solicits a woman in marriage; a wooer; a lover.  
SUITRESS, *n.* A female applicant.  
SUL'CATE, } *a.* [L. *sulcus*, a furrow.]  
SUL'CATED, } In *bot.*, furrowed; grooved; scored with deep broad channels longitudinally. Applied to stems, leaves, seeds, &c., of plants.—2. In *zool.*, a term applied to a surface that is deeply impressed with longitudinal parallel lines; as various shells.

SUL'CUS, *n. plur. Sulci.* [L.] A groove or furrow.

SULK, *v. i.* To be sullen; to become sour.—*To be in the sulks*, to be in a state of sullenness. [Colloq.]

SUL'KILY, *adv.* Sullenly; morosely.

SUL'KINESS, *n.* [from *sulky*.] Sullenness; sourness; moroseness.

SULKS, *n. plur.* State of sulkiness; as, to be in the *sulks*; to have a fit of the *sulks*. [Familiar.]

SUL'KY, *a.* [Sax. *solcen*, sluggish.] Sullen; sour; heavy; obstinate; morose.

While these animals remain in their inclosures, they are *sulky*. *As. Res.*

SUL'KY, *n.* A carriage for a single person.

SULL,† *n.* [Sax. *sulh*.] A plough.

SUL'LAGÉ, *n.* [See SULLIAGE.] A drain of filth, or filth collected from the street or highway.

SUL'LEN, *a.* [perhaps set, fixed, and allied to *silent*, *still*, &c.] 1. Gloomily, angry, and silent; cross; sour; afflicted with ill humour.

And *sullen* I forsook th' imperfect feast.

Prior.

2. Mischievous; malignant.

Such *sullen* planets at my birth did shine.

Dryden.

3. Obstinate; intractable.

Things are as *sullen* as we are. *Tillotson*.

4. Gloomy; dark; dismal.

Why are thine eyes fix'd to the *sullen* earth?

Shak.

Night with her *sullen* wings.

Milton.

No cheerful breeze this *sullen* region knows.

Pope.

5. Heavy; dull; sorrowful.

Be thou the trumpet of our wrath,

And *sullen* presage of your own decay.

Shak.

SUL'LEN,† *v. t.* To make sullen.

SUL'LENLY, *adv.* Gloomily; malignantly; intractably; with moroseness.

SUL'LENNESS, *n.* Ill nature with silence; silent moroseness; gloominess; malignity; intractableness.

SUL'LENS,† *n. plur.* A morose temper; gloominess.

SUL'LIAGE, *n.* [Fr. *souillage*.] Foulness; filth.

SUL'LIED, *pp.* Soiled; tarnished; stained.

SUL'LY, *v. t.* [Fr. *souiller*; from the root of *soil*, G. *süle*.] 1. To soil; to dirt; to spot; to tarnish.

And statues *sullied* yet with sacrilegious smoke. *Roscommon*.

2. To tarnish; to darken.

Let there be no spots to *sully* the brightness of this solemnity. *Atterbury*.

3. To stain; to tarnish; as, the purity of reputation; as, virtues *sullied* by slanders; character *sullied* by infamous vices.

SUL'LY, *v. i.* To be soiled or tarnished.

Silvering will *sully* and canker more than gilding. *Bacon*.

SUL'LY, *n.* Soil; tarnish; spot.

A noble and triumphant merit breaks through little spots and *sullies* on his reputation. *Spectator*.

SUL'LYING, *pp.* Soiling; tarnishing; staining.

SULPHAME'THYLANE, *n.* A crystalline compound, produced when a current of dry ammonia is made to act upon neutral sulphate of methule. It is a very deliquescent compound, analogous to oxamethylane.

SULPHA'SATYDE, *n.* A substance formed by the action of potash on sulphate, from which it differs but slightly. It is a white crystalline powder.

SULPHATE, *n.* [from *sulphur*.] A salt formed by sulphuric acid in combination with any base; as, *sulphate* of lime. Of the sulphates, some are found native; some are very soluble, some sparingly soluble, and some insoluble. All those that are soluble are recognized in solution by the test of nitrate of baryta, which causes a white precipitate of sulphate of baryta, insoluble in acids. All the insoluble sulphates, when fused with carbonate of soda, yield sulphate of soda, which may be recognized as above. Some neutral sulphates occur in the anhydrous state, and others occur combined with water. The most important sulphates are:—

Sulphate of alumina and potash or alum; sulphate of ammonia, employed for making carbonate of ammonia; sulphate of copper, or blue vitriol, much used as an escharotic in surgery; and also used in dyeing, and for preparing certain green pigments; sulphate of iron, or green vitriol, used in making ink, and very extensively in dyeing, and calico printing; it is also much used in medicine; sulphate of lime or gypsum; sulphate of magnesia, or Epsom salts; sulphate of manganese, used in calico printing; sulphate of peroxide of mercury, used in the preparation of corrosive sublimate, and of calomel; bisulphate of potash, much used as a flux in mineral analysis; sulphate of soda, or Glauber's salts; sulphate of quinia, much used in medicine; sulphate of zinc, or white vitriol, used in surgery, also in the preparation of drying oils for varnishes, and in the reserve or resist pastes of the calico printer. Some of the sulphates are double; as the sulphate of magnesia and potash, the sulphate of alumina and potash or alum.

SULPHA'TIC, *a.* Relating to sulphate.

SULPHE'SATYDE, *n.* A substance formed by the action of sulphuretted hydrogen on isatine, dissolved in alcohol. It is a greyish yellow amorphous powder.

SUL'PHITE, *n.* [from *sulphur*.] A salt formed by a combination of sulphurous acid with a base. The sulphites are recognized by giving off the suffocating smell of sulphurous acid when acted on by a stronger acid. A very close analogy exists between them and the carbonates.

SULPHOBENZIDE, *n.* A substance obtained in colourless crystals, when anhydrous sulphuric acid is made to act upon benzole. It is an inodorous indifferent body, composed of 12 equivalents of carbon, 5 of hydrogen, and 2 of sulphuric acid.

SULPHOCAMPHIC ACID, *n.* An acid obtained from camphogene when acted on by sulphuric acid.

SULPHOCAMPHORIC ACID, *n.* An acid formed by the action of sulphuric acid on anhydrous camphoric acid. It is crystallizable, and forms crystallizable salts.

SULPHOCYANIC ACID, *n.* An acid composed of sulphur, cyanogen, and hydrogen. It occurs in the seeds and blossoms of cruciferous plants, and in the saliva of man and sheep. It is a colourless liquid of a pure acid taste, and smells somewhat like vinegar. It colours the salts of peroxide of iron blood-red. It is more properly called *hydro-sulphocyanic acid*.

SULPHOCYANIDE, *n.* A compound formed by the union of hydro-sulphocyanic acid with a metallic base.

SULPHOCYANOGEN, *n.* A compound of sulphur and cyanogen, called also bisulphuret of cyanogen. It is obtained in the form of a deep yellow amorphous powder, insoluble in water, alcohol, and ether, but is dissolved by strong sulphuric acid.

SULPHOGLYCERIC ACID, *n.* An acid formed by treating glycerine with sulphuric acid. It forms double salts, analogous to the sulphovinates.

SULPHOINDIGOTIC ACID, *n.* An acid formed by the action of sulphuric acid on indigo. When 1 part of pure indigo is added to 8 parts of sulphuric acid, the addition of water causes the deposition of a purple powder called *sulpho-purpuric acid*, while a blue solution is obtained. The blue solution contains two acids, *sulphoindigotic acid*, and *hypo-sulphoindigotic acid*.

SULPHOLEIC ACID, *n.* When a mixture of oleine and margarine is acted on by sulphuric acid, two new acids are formed, *sulpholeic acid*, and *sulphomargaric acid*. Little is known respecting them.

SULPHOMETHYLIC ACID, *n.* Bisulphate of oxide of methyle, perfectly analogous to sulphovinic acid, forming double salts, which are often called *sulphomethylates*.

SULPHONAPHTHALIC ACID, *n.* An acid compounded of sulphuric acid and naphthaline, discovered by Faraday. When naphthaline is dissolved in excess by sulphuric acid, two new compounds are formed, *sulphonaphthaline*, and *sulphonaphthalide*; both insoluble in water.

SULPHOPROTEIC ACID, *n.* An acid resulting from the union of diluted sulphuric acid with proteine.

SULPHOPURPURIC ACID, *n.* A purple powder, obtained by dissolving 1 part of indigo in 8 parts of oil of vitriol, and adding water to the solution. It gives purple salts with bases, and is soluble in pure water.

SULPHOSAC'CHARIC ACID, *n.* An acid formed by dissolving grape sugar in strong sulphuric acid. It is a sweet liquid, slightly acid, and forming soluble salts with almost all bases. Its true composition is not yet known.

SULPHOSELS, } The name  
SULPHUR SALTS, } given by Berzelius to certain double sulphurets. The simple sulphurets, by the union of which a sulphur salt is formed, are bi-elementary compounds, strictly analogous in their constitution to acids and alkaline bases; and, like them, are capable of assuming opposite electric



energies in relation to each other. Electro-positive sulphurets are termed *sulphur bases*, and the electro-negative sulphurets, *sulphur acids*. The principal sulphur bases are the protosulphurets of potassium, sodium, lithium, barium, strontium, calcium, and magnesium, and hydro-sulphate of ammonia; and the principal sulphur acids are the sulphurets of arsenic, antimony, tungsten, molybdenum, tellurium, tin, and gold, together with hydrosulphuric acid, bisulphuret of carbon, and sulphuret of selenium. The compounds resulting from the union of a sulphuret of the former class with one of the latter, constitute *sulphur salts*, or *sulphosels*. These are analogous to oxy-salts.

**SULPHOSINAP'ISINE**, *n.* In *chem.*, a crystallizable substance, obtained from mustard-seed.

**SULPHOVINATE**, *n.* A double salt formed by the union of sulphovinic acid with a base; as, *sulphovinate* of etherole, or heavy oil of wine.

**SULPHOVIN'IC ACID**, *n.* An acid produced by the action of sulphuric acid upon alcohol, and called also acid sulphate of oxide of ethyle. To obtain it pure, the double sulphate of ethyle and baryta in solution is decomposed by sulphuric acid, and the filtered liquid is a solution in water of the acid sulphate. It has a very sour taste, and cannot be concentrated by evaporation without being decomposed into alcohol and sulphuric acid. It forms with most bases crystallizable double salts, called *sulphovicates*, which are all soluble.

**SULPHUR**, *n.* [*L.*, whence *Fr. soufre*.] Brimstone, a simple non-metallic combustible substance, which has been known from the earliest ages of the world. It occurs in great abundance in the mineral, sparingly in the vegetable, and still more sparingly in the animal kingdom. It occurs sometimes pure or merely mixed, and sometimes in chemical combination with oxygen and various metals, forming sulphates and sulphurets. It is found in greatest abundance and purity in the neighbourhood of volcanoes, modern or extinct, as at Solfatara, in Italy; and, as an article of commerce, is chiefly imported from the Mediterranean. That which is manufactured in this country is obtained by the roasting of iron pyrites. It is commonly met with in two forms; that of a compact, brittle solid, and a fine powder. It is nearly tasteless, of a greenish yellow colour, and when rubbed or melted emits a peculiar odour. Its specific gravity is 1.99; it is insoluble in water, and not very readily soluble in alcohol, but is taken up by spirits of turpentine. It is a non-conductor of electricity. It is readily melted and volatilized. It fuses at 232°, and between 232° and 280° it possesses the greatest degree of fluidity, and when cast into cylindrical moulds, forms the common roll-sulphur of commerce. It possesses the peculiar property of solidifying at a higher degree, or when raised to 320°. Between 428° and 482° it is very tenacious. From 482° to its boiling point (600°) it again becomes liquid. At 600° it rises in vapour, and in close vessels condenses in the form of a fine yellow powder, called *flowers of sulphur*. When sulphur is heated to at least 428°, and then poured into water, it

becomes a ductile mass, and may be employed for taking the impressions of seals and medals. Sulphur combines with oxygen, hydrogen, chlorine, &c., forming various important compounds. It unites also with the metals forming sulphurets. It is of great importance in the arts, being employed in the manufacture of gunpowder, and in the formation of sulphuric acid. It is also employed in medicine, and for various other purposes.

**SULPHURATE**, *a.* [*L. sulphuratus*.] Belonging to sulphur; of the colour of sulphur. [*Little used*.]

**SULPHURATE**, † *v. t.* To combine with sulphur.

**SULPHURATED**, † *pp.* Combined or impregnated with sulphur; as, *sulphurated hydrogen gas*.

**SULPHURATING**, † *ppr.* Combining or impregnating with sulphur.

**SULPHURATION**, *n.* Act of dressing or anointing with sulphur.—2. The process by which woollen, silk, and cotton goods, and likewise straw-hats, are whitened or bleached by being exposed to the vapours of burning sulphur, or to sulphurous acid gas.

**SULPHUREOUS**, *a.* Consisting of sulphur; having the qualities of sulphur or brimstone; impregnated with sulphur.—*Sulphureous waters*, such as the springs of Aix-la-Chapelle, Harrowgate, and Moffat, contain sulphuretted hydrogen, and are easily recognized by their odour, and by causing a brown precipitate with a salt of lead or silver.

Her snakes untied, *sulphureous waters* drink.  
*Pope.*

**SULPHUREOUSLY**, *adv.* In a sulphureous manner.

**SULPHUREOUSNESS**, *n.* The state of being sulphureous.

**SULPHURET**, *n.* A compound of sulphur with an electro-positive or inflammable body; as the *sulphuret* of potassium; *sulphuret* of phosphorus; *sulphuret* of iron, &c. The principal ores of iron, copper, lead, &c., are sulphurets of those metals.

**SULPHURETTED**, *a.* Applied to bodies having sulphur in combination.—*Sulphuretted hydrogen*, a compound formed when hydrogen and sulphur come in contact in the nascent state. It is a transparent colourless gas, recognized by its peculiar fetid odour, resembling that of putrid eggs. It is very deleterious to animal life, and is often formed where animal matters or excrements putrify. It extinguishes flame, but is itself combustible. It is the active constituent of sulphureous mineral waters. It is also known by the name of hydro-sulphuric acid, and consists of 1 atom of sulphur and 1 of hydrogen.

**SULPHURIC**, *a.* Pertaining to sulphur.—*Sulphuric acid*, oil of vitriol; a most important acid, discovered by Basil Valentine towards the close of the 15th century. It was formerly procured by the distillation of dried sulphate of iron, called *green vitriol*, whence the corrosive liquid which came over in the distillation, having an oily consistence, was called *oil of vitriol*. It is now prepared in this and most other countries, by burning sulphur along with nitre in large leaden chambers. Pure sulphuric acid is a dense, oily, colourless fluid, having, when strongly concentrated, a specific gravity of about 1.8. It is exceedingly acid and corrosive,

decomposing all animal and vegetable substances by the aid of heat. It unites with alkaline substances, and separates all other acids, more or less completely, from their combinations with the alkalies. It has a very great affinity for water, and unites with it in every proportion, producing great heat; it attracts moisture strongly from the atmosphere, becoming rapidly weaker if exposed. The sulphuric acid of commerce is never pure, but it may be purified by distillation. With bases sulphuric acid forms salts, called sulphates, some of which are neutral, and others acid. Common sulphuric acid is properly hydrated sulphuric acid, which may be regarded as a compound of 1 atom of dry acid, and 1 of water.—*Fuming sulphuric acid*, or that obtained by distilling partially dried green vitriol, consists of 2 equivalents of anhydrous or dry acid, and 1 equivalent of water. The best test of the presence of sulphuric acid, whether free or combined, is a soluble compound of barium. Thus, when a solution of chloride of barium is added to a liquid containing sulphuric acid, it causes a white precipitate; viz., sulphate of baryta, which is not only insoluble in water, but in the strongest acids. Of all the acids the sulphuric is the most extensively used in the arts, and is in fact the primary agent for obtaining almost all the others by disengaging them from their saline combinations. Its uses to the scientific chemist are innumerable. In medicine it is used in a diluted state, as a refrigerant.

**SULPHURIC ETHER**, *n.* A colourless transparent liquid, of a pleasant smell and a pungent taste, extremely exhilarating, and producing a degree of intoxication when its vapour is inhaled by the nostrils. It is produced by distilling a mixture of equal weights of sulphuric acid and alcohol, and by various other means. It consists of 4 atoms of carbon, 5 of hydrogen, and 1 of oxygen, and has a specific gravity of 0.75. It is extremely volatile, and highly inflammable; and its vapour, mixed with oxygen or atmospheric air, forms a very dangerous explosive mixture. It dissolves in 10 parts of water, and is miscible with alcohol and the fatty and volatile oils in all proportions. It is employed in medicine as a stimulant and antispasmodic. The vapour of ether was recently administered, with great success, to patients when about to undergo surgical operations. The patient was made to inhale the vapour by means of an apparatus contrived for the purpose, in consequence of which he was thrown into a state of stupor, and was thus enabled to undergo the operation without any sensation of pain. Sulphuric ether, as an anæsthetic agent in surgical operations, is now, however, superseded by chloroform.

**SULPHUROUS**, *a.* Like sulphur; containing sulphur.—*Sulphurous acid*, an acid formed by the combustion of sulphur in air or dry oxygen, consisting of 1 equivalent of sulphur, and 2 of oxygen. It is a transparent and colourless gas, of a disagreeable taste, a pungent and suffocating odour, is fatal to life, and very injurious to vegetation. At 45°, under the pressure of two atmospheres, it becomes liquid, and also at 0° under the pressure of one atmosphere. It extinguishes flame, but is not itself inflammable. It has consi-

derable bleaching properties, so that the fumes of burning sulphur are often used to whiten straw, and silk and cotton goods. It combines with metallic oxides, forming salts called *sulphites*.

**SULPHUR-SALTS.** See **SULPHOSES.**  
**SULPHUR-WORT,** *n.* A plant, hog's fennel, of the genus *Peucedanum*, the *P. officinale*. [See **PEUCEDANUM**.]

**SULPHURY, a.** Partaking of sulphur; having the qualities of sulphur.

**SULTAN, n.** [Qu. Ch. Syr. and Heb. שַׁלַּט, *shalat*, to rule.] An appellation given to the emperor of the Turks, denoting ruler or commander.

**SULTANA, } n.** The queen of a  
**SULTANESS, } sultan; the empress of the Turks.**

**SULTAN-FLOWER, n.** A plant, a species of *Centaurea*.

**SULTANRY, n.** An eastern empire; the dominions of a sultan.

**SULTANSHIP, n.** The office or state of a sultan.

**SULTRINESS, n.** [from *sultry*.] The state of being sultry; heat with a moist or close air.

**SULTRY, a.** [G. *schwül*, sultry; Sax. *swolath*, *swole*, heat, G. *schwüle*. See **SWELTER**.] 1. Very hot, burning, and oppressive; as, Libya's *sultry* deserts. —2. Very hot and moist, or hot, close, stagnant, and unelastic; as air or the atmosphere. A *sultry* air is usually enfeebling and oppressive to the human body.

Such as born beneath the burning sky  
And *sultry* sun, betwixt the tropics lie.

*Dryden.*

**SUM, n.** [Fr. *somme*; G. *summe*; L. *summa*, a sum; Sax. *somed*, L. *stimul*, together; Sax. *somnian*, to assemble. These words may be from the root of Ch. סָם, *som*, Heb. שָׁם, *shom*, to set or place.] 1. The aggregate of two or more numbers, magnitudes, quantities, or particulars; the amount or whole of any number of individuals or particulars added. The *sum* of 5 and 7 is 12; the *sum* of *a* and *b* is *a + b*.

How precious are thy thoughts to me,  
O God! how great is the *sum* of them!  
Ps. cxxxix.

Take the *sum* of all the congregation;  
Num. i.

[*Sum* is now applied more generally to numbers, and *number* to persons.] —2. A quantity of money or currency; any amount indefinitely. I sent him a *sum* of money, a small *sum*, or a large *sum*. I received a large *sum* in bank notes. —3. Compendium; abridgment; the amount; the substance. This is the *sum* of all the evidence in the case. This is the *sum* and substance of all his objections. The *sum* of all I have said is this. The phrase, *in sum*, is obsolete, or nearly so.

*In sum*, the gospel considered as a law, prescribes every virtue to our conduct, and forbids every sin. —*Rogers.*

4. Height; completion.  
Thus have I told thee all my state, and brought

My story to the *sum* of earthly bliss. *Milton.*  
**SUM, v. t.** To add particulars into one whole; to collect two or more particular numbers into one number; to cast up; usually followed by *up*, but it is superfluous. Custom enables a man to *sum up* a long column of figures with surprising facility and correctness.

The hour doth rather *sum up* the moments, than divide the day. —*Bacon.*

2. To bring or collect into a small compass; to comprise in a few words; to condense. He *summed up* his arguments at the close of his speech, with great force and effect.

"Go to the ant, thou sluggard," in few words, *sums up* the moral of this fable.

*L'Estrange.*

3. In *fulconry*, to have feathers full grown.

With prosperous wing full *summ'd*. [Unusual.] *Milton.*

**SUMACH, } n.** (shu'mak.) [Fr. *sumach*;  
**SUMAC, } G. id.; Ar. and Pers. *sumak*.] A genus of plants (*Rhus*), of many species, some of which are used in tanning; some in dyeing; and some in medicine. [See **RHUS**.]**

**SUMATRAN, n.** A native of Sumatra.  
**SUM'LESS, a.** Not to be computed; of which the amount cannot be ascertained.

The *sumless* treasure of exhausted mines. *Pope.*

**SUMMARILY, adv.** [from *summary*.] In a summary manner; briefly; concisely; in a narrow compass or in few words. The Lord's Prayer teaches us *summarily* the things we are to ask for. —2. In a short way or method.

When the parties proceed *summarily*, and they choose the ordinary way of proceeding, the cause is made plenary.

*Ayliffe.*

**SUMMARY, a.** [Fr. *sommaire*; from *sum*, or L. *summa*.] Reduced into a narrow compass; or into few words; short; brief; concise; compendious; as, a *summary* statement of arguments or objections; a *summary* proceeding or process. —*Summary application*, in *English law*, signifies redress by means of a motion in court, which is applicable to cases respecting annuities, attorneys, warrants of attorney, &c., and to those matters which by law or statute are placed within the immediate and peculiar jurisdiction of the courts of law, and which may be decided without hinderance or delay. —*Summary actions*, in *Scots law*, are those which are brought into court, not by summons, advocacy, or suspension, but by petition or *summary* complaint.

**SUMMARY, n.** An abridged account; an abstract, abridgment, or compendium, containing the *sum* or substance of a fuller account; as, the comprehensive *summary* of our duty to God in the first table of the law.

**SUMMATION, n.** The act of forming a *sum* or total amount. —2. An aggregate. —*Summation of series*, in *math.*, the method of finding the *sum* of a series, whether the number of its terms be finite or infinite. [See **SERIES**.]

**SUM'MED, pp.** [from *sum*.] Collected into a total amount; fully grown, as feathers.

**SUMMER, n.** One who casts up an account.

**SUMMER, a.** Relating to summer; as, *summer* heat.

**SUM'MER, n.** [Sax. *sumer*, *sumor*; G. and Dan. *sommer*; Ir. *samh*, the sun, and *summer*, and *samhradh*, summer.] One of the four seasons of the year, in the popular acceptance of the term, including May, June, and July. Astronomically considered, summer begins in the northern hemisphere when the sun enters Cancer, about the 21st of June, and continues for three months,

till Sept. 23d; during which time, the sun being north of the equator, shines more directly upon this part of the earth, which renders this the hottest period of the year. In latitudes south of the equator, just the opposite takes place, or it is summer there when it is winter here. The entire year is also sometimes divided into summer and winter, the former signifying the warmer and the latter the colder part of the year. —*Indian summer*, in the *U. States*, a period of warm weather late in autumn, when, it is said, the Indians go hunting to supply themselves with the flesh of wild animals for provisions in the winter.

**SUM'MER, v. i.** To pass the summer or warm season.

The fowls shall *summer* upon them; Is. xviii.

**SUM'MER,† v. t.** To keep or carry through the summer. [*Little used*.]

**SUM'MER, n.** [Fr. *sommer*, a hair quilt, the sound-board of an organ, the winter and head of a printer's press, a large beam and a sumpter horse; W. *sumer*, that which supports or keeps together, a summer. From the latter explanation, we may infer that *summer* is from the root of *sum*.]

1. A large stone, the first that is laid over columns and pilasters, beginning to make a cross vault; or a stone laid over a column, and hollowed to receive the first haunch of a plinth. —2. A large timber supported on two stone piers or posts, serving as a lintel to a door or window, &c. —3. A large timber or beam laid as a bearing beam. —4. A girder. —5. A breast summer.

**SUM'MER-COLT, n.** The undulating state of the air near the surface of the ground when heated.

**SUMMER-CY'PRESS, n.** A plant, a species of *Chenopodium*, the *C. scoparia*, Linn.

**SUMMER-FAL'LOW, n.** [See **FAL'LOW**.] Naked fallow; land lying bare of crops in summer, but frequently ploughed, harrowed, and rolled so as to pulverize it and clean it of weeds.

**SUMMER-FAL'LOW, v. t.** To plough and work repeatedly in summer, to prepare for wheat or other crop.

**SUMMER-HOUSE, n.** A house or apartment in a garden to be used in summer. —2. A house for summer's residence.

**SUMMERINGS, n.** In *arching*, the name given by the workmen to the beds of the stones.

**SUM'MERSET, n.** A high leap in which the heels are thrown over the head. [See **SOMERSAULT**, **SOMERSET**.]

**SUM'MER-STIR, v. t.** To plough land that it may be fallowed in summer; to summer-fallow.

**SUM'MER-TREE, n.** A beam full of mortises for the reception of the ends of joists.

**SUM'MER-WHEAT, n.** Spring wheat.

**SUMMING, pp. of *sum*.** Adding together. —*Summing up the evidence*. In *Scots law*, in criminal prosecutions, before the jury enter on a consideration of their verdict, the presiding judge recapitulates, in a clear and succinct manner, the different facts and circumstances which have been adduced in evidence in the case before the court, giving at the same time an exposition of the law where it appears necessary, in order to instruct the jury, and correct the exaggerated representations of parties. This is termed *summing up the evidence*.

**SUM'MIST**, *n.* One that forms an abridgment. [*Little used.*]

**SUM'MIT**, *n.* [*L. summitas*, from *summus*, highest.] 1. The top; the highest point; as, the *summit* of a mountain.

—2. The highest point or degree; utmost elevation. The general arrived to the *summit* of human fame.—3. In *conchology*, the most elevated point of the shell where the hinge is placed.

**SUM'MITLESS**, *a.* Having no summit.

**SUM'MIT-LEVEL**, *n.* The highest level; the highest of a series of elevations over which a canal or watercourse is carried.

**SUM'MITY**, *n.* [*Fr. sommité.*] The height or top of any thing.

**SUM'MON**, *v. t.* [*L. submoneo*; and *sub* and *moneo*; *Fr. sommer.* See **ADMONISH.**]

1. To call, cite or notify, by authority to appear at a place specified, or to attend in person to some public duty, or both; as, to *summon* a jury; to *summon* witnesses.

The parliament is *summoned* by the king's writ or letter. *Blackstone.*

Nor trumpets *summon* him to war.

*Dryden.*

2. To give notice to a person to appear in court and defend.—3. To call or command.

Love, duty, safety *summon* us away. *Pope.*

4. To call up; to excite into action or exertion; with *up*. *Summon up* all your strength or courage.

Stiffen the sinews, *summon up* the blood.

*Shak.*

**SUM'MONED**, *pp.* Admonished or warned by authority to appear or attend to something; called or cited by authority.

**SUM'MONER**, *n.* One who summons or cites by authority. In *England*, the sheriff's messenger, employed to warn persons to appear in court.

**SUM'MONING**, *ppr.* Citing by authority to appear or attend to something.

**SUM'MONS**, *n.* With a plural termination, but used in the singular number; as, a *summons* is prepared. [*L. submoneas.*] 1. A call by authority or the command of a superior to appear at a place named, or to attend to some public duty.

This *summons* he resolved not to disobey.

*Fell.*

He sent to *summon* the seditious and to offer pardon; but neither *summons* nor pardon was regarded.

*Hayward.*

2. In *law*, a warning or citation to appear in court; or a written notification, signed by the proper officer, to be served on a person, warning him to appear in court at a day specified, to answer to the demand of the plaintiff.

A writ of *summons* may issue from either of the four superior courts of common law, and a copy of it must be personally served on the defendant against whom it is intended to proceed. The duration of a writ of *summons*, is four calendar months inclusive, from the day of issuing, but it may be continued by renewals. In *Scots law*, a *summons* is a writ issuing from the court of session in the sovereign's name, signed by a writer to the signet, and passing the signet, setting forth the grounds and conclusions of an action, and containing the royal warrant or mandate to messengers-at-arms, to cite the defender to appear in court to answer the demand, with certification that if he fail to appear, the court will pronounce decree in the terms concluded for in the *summons*. *Summonses*

in the inferior courts are framed on the same model, only the citation is given on the warrant of the inferior judge or magistrate, and not of the sovereign.

**SUMMUM BONUM**. [*L.*] The chief good.

**SUMOOM**, *n.* A pestilential wind of Persia. [*See SIZOOM.*]

**SUMP**, *n.* In *metallurgy*, a round pit of stone, lined with clay, for receiving the metal on its first fusion.—2. A pond of water reserved for salt-works.—3. In *mining*, a pit sunk below the bottom of the mine.

**SUMPH**, *n.* A dunce; a blockhead; a soft blunt fellow. [*Scotch.*]

**SUMPTAN**, *n.* A small poisoned dart or arrow, thrown by means of a long cane tube called a *sumptan* tube. It is used by the natives of Borneo, and other islands in the eastern Archipelago.

**SUMPTER**, *n.* [*Fr. sommier.*]

**SUMPTER-HORSE**, *n.* [*It. somaro.*] A horse that carries clothes or furniture, or necessities for a journey; a baggage-horse; usually called a pack-horse.

**SUMPTER-MULE**, *n.* A mule that carries clothes or furniture for a journey.

**SUMPTER-SADDLE**, *n.* A pack-saddle; a pannel.

**SUMPTION**, *n.* [*L. sumo, sumptus.*] A taking.

**SUMPTUARY**, *a.* [*L. sumptuarius*, from *sumptus*, expense; *Fr. somptuaire.*] Relating to expense. *Sumptuary* laws or regulations are such as restrain or limit the expenses of citizens in apparel, food, furniture, &c. Such laws were in former times frequently enacted both in England and Scotland, but they have long been in desuetude. Those of England were repealed by 1 Jac. 1. c. 25.

*Sumptuary* laws are abridgments of liberty, and of very difficult execution. They can be justified only on the ground of extreme necessity.

**SUMPTUOUS'ITY**, *n.* [*from sumptuos.*] Expensiveness; costliness.

**SUMPTUOUS**, *a.* [*L. sumptuosus*; *It. sumtuoso*; from *sumplus*, cost, expense.] Costly; expensive; hence, splendid; magnificent; as, a *sumptuous* house or table; *sumptuous* apparel.

We are too magnificent and *sumptuous* in our tables and attendance. *Atterbury.*

**SUMPTUOUSLY**, *adv.* Expensively; splendidly; with great magnificence.

**SUMPTUOUSNESS**, *n.* Costliness; expensiveness.

I will not fall out with those who can reconcile *sumptuousness* and charity. *Boyle.*

2. Splendour; magnificence.

**SUN**, *n.* [*Sax. sunna*; *G. sonne*; *Sans. sunuh.* The Danish has *Søndag*, Sunday, Slav. *Sonze*. Qu. W. *tan*, Ir. *teine*, fire, and *shan*, in *Bethshan.*] 1. The splendid orb or luminary which, being in or near the centre of our system of worlds, gives light and heat to all the planets, and is therefore the primary cause of all the motions and changes effected on the surface of our globe by those mighty agents. The light of the sun constitutes the day, and the darkness which proceeds from its absence, or the shade of the earth, constitutes the night; Ps. cxxxvi. All the planets and comets of our system revolve round the sun as a common centre, at different distances and in different periods of time. His mean apparent diameter is about 32 minutes, and his mean distance from the earth about 95,000,000 miles. His real diameter is 882,000 miles, and hence his magnitude is

1,384,472 times that of the earth, but his mass or quantity of matter is only about 23 times that of the earth. He revolves on his axis from west to east in 25 $\frac{1}{2}$  of our mean solar days, his axis being inclined at an angle of 82° 40' to the plane of the ecliptic. When viewed through powerful telescopes the sun's discs observed to have frequently large and perfectly black spots upon it. These spots are of various irregular shapes, and of various sizes, from the least visible to the twentieth part of the sun in diameter. They alter in size and gradually vanish, lasting from a few days to six or seven weeks.

Herschel conjectures that the shining matter of the sun consists of a mass of phosphoric clouds, floating above his atmosphere, or else mixed with the higher strata of it, and that owing to disturbances in the equilibrium of this luminous atmosphere, openings are made through it; and that therefore a spot on the sun is a portion of the body of the sun itself, seen through one of these openings. Several hypotheses have been advanced respecting the emission of heat and light from the sun, but none of them are satisfactory. The sun, besides his motion round his own axis, revolves round the common centre of gravity of the solar system, which centre is a point within the body of the sun. The apparent diurnal motion of the sun from east to west, is owing to the revolution of the earth on its axis, and his apparent annual path in the ecliptic from west to east, is owing to the motion of the earth round the sun in an elliptical orbit, the sun being in one of the foci. Astronomers seem to have ascertained beyond a doubt that the sun has a proper motion in space, and is advancing along with the planets toward some distant point among the fixed stars.—2. In *popular usage*, a sunny place; a place where the beams of the sun fall; as, to stand in the *sun*, that is, to stand where the direct rays of the sun fall.—3. Any thing eminently splendid or luminous; that which is the chief source of light or honour. The native Indians of America complain that the *sun* of their glory is set.

I will never consent to put out the *sun* of sovereignty to posterity. *K. Charles.*

4. In *Scripture*, Christ is called the *sun* of righteousness, as the source of light, animation, and comfort to his disciples.—5. The luminary or orb which constitutes the centre of any system of worlds. The fixed stars are supposed to be *sun*s in their respective systems.—*Under the sun*, in the world; on earth; a proverbial expression.

There is no new thing *under the sun*;

*Eccles. 1.*

**SUN**, *v. t.* To expose to the sun's rays; to warm or dry in the light of the sun; to insolate; as, to *sun* cloth; to *sun* grain.

Then to *sun* thyself in open air. *Dryden.*

**SUN AND PLANET WHEELS**. In *mech.*, an ingenious contrivance adopted by Watt in the early history of the steam engine, for converting the reciprocating motion of the beam into a rotatory motion. In the annexed figure the sun-wheel *a*, is a toothed wheel fixed fast to the axis of the fly wheel, and the planet wheel *b*, is a similar wheel bolted to the lower end of the connecting rod *c*; it is retained in its orbit by a link at the back of both wheels. By the reciprocating motion

of the connecting rod, the wheel *b* is compelled to circulate round the wheel *a*, and in so doing carries the latter

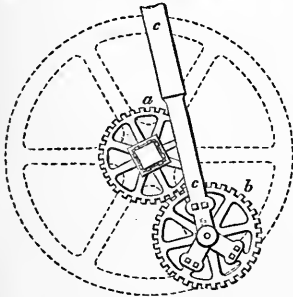

Sun and Planet Wheels.

along with it, communicating to the fly wheel a velocity double of its own. **SUN-BEAM**, *n.* [*sun* and *beam*.] A ray of the sun. Truth written with a *sunbeam*, is truth made obviously plain. Gliding through the even on a *sunbeam*.

Milton.

**SUN-BEAT**, *a.* [*sun* and *beat*.] Struck by the sun's rays; shone brightly on. **SUN-BEATEN**, *n.* Sunbeaten. **SUN-BIRDS**, *n.* Cymniridae, a family of birds found principally in the tropical parts of Africa and Asia, and in the adjacent islands. They are small birds, with plumage approaching in splendour to that of the humming birds, which in

Sun Birds (*Cynniris afra*), Male and Female.

many respects they resemble. They live on the juices of flowers; their nature is gay, and their song agreeable. They hold the same place in the old world that humming birds do in the new.

**SUN-BLINK**, *n.* A flash or glimpse of sunshine. [*Scotch*.]

**SUN-BORN**, *a.* Proceeding from the sun. **SUN-BRIGHT**, *a.* [*sun* and *bright*.] Bright as the sun; like the sun in brightness; as, a *sun-bright* shield; a *sun-bright* chariot.

How and which way I may bestow myself To be regarded in her *sun-bright* eye. *Shak.* **SUN-BURN**, *v. t.* To discolour or scorch by the sun.

**SUN-BURNING**, *n.* [*sun* and *burning*.] The burning or tan occasioned by the rays of the sun on the skin.

**SUNBURNT**, *a.* [*sun* and *burnt*.] Discoloured by the heat or rays of the sun; tanned; darkened in hue; as, a *sunburnt* skin.

*Sunburnt* and swarthy though she be.

Dryden.

2. Scorched by the sun's rays; as, a *sunburnt* soil.

**SUNCLAD**, *a.* [*sun* and *clad*.] Clad in radiance or brightness.

**SUNDART**, *n.* A ray of the sun.

**SUNDAY**, *n.* [*Sax. sunna-dæg*; *G. sonntag*; so called because this day was anciently dedicated to the sun, or to its worship.] The Christian sabbath; the first day of the week, a day consecrated to rest from secular employments, and to religious worship. It is called also the Lord's day. Many pious persons however discard the use of *Sunday*, and call the day the *sabbath*. [*See* **SABBATH**.]

**SUNDAY**, *a.* Belonging to the Lord's day, or Christian sabbath.

**SUNDAY-LETTER**, *n.* The dominical letter,—*which see*.

**SUNDAY-SCHOOL**, *n.* A school for the religious instruction of children and youth on the Lord's day.

**SUNDER**, *v. t.* [*Sax. sundrian, syndrian; G. sondern; Dan. sinder, torn in pieces; Sw. söndra, to divide*.] 1. To part; to separate; to divide; to disunite in almost any manner, either by rending, cutting, or breaking; as, to *sunder* a rope or cord; to *sunder* a limb or joint; to *sunder* friends, or the ties of friendship. The executioner *sunders* the head from the body at a stroke. A mountain may be *sundered* by an earthquake.

Bring me lightning, give me thunder; Jove may kill, but ne'er shall *sunder*.

Glanville.

2. To expose to the sun. [*Provincial*.] **SUNDER**, *n.* *In sunder*, in two.

He cutteth the spear *in sunder*; Ps. xlii.

**SUNDERED**, *pp.* Separated; divided; parted.

**SUNDERING**, *ppr.* Parting; separating.

**SUN-DEW**, *n.* [*sun* and *dew*.] A genus of plants, (*Drosera*), belonging to the nat. order *Droseraceæ*, of which it is the type. The species inhabit marshes and moist places in various parts of the world; their leaves are all radical and fringed with hairs, each of which supports a globule of pellucid dew-like liquor, even in the hottest weather. Three species are found in Britain, the most common of which (*D. rotundifolia*) is an acrid, caustic plant, said to remove warts and corns, and to curdle milk.

**SUN-DIAL**, *n.* [*sun* and *dial*.] An instrument to show the time of day, by means of the shadow of a gnomon or style on a plate.

**SUN-DOG**, *n.* A luminous spot occasionally seen a few degrees from the sun, supposed to be formed by the intersection of two or more haloes. Sometimes the spot appears when the haloes themselves are invisible.

**SUN-DOWN**, *n.* In *America*, sunset; sunsetting.

**SUN-DRIED**, *a.* [*sun* and *dry*.] Dried in the rays of the sun.

**SUN-DRIES**, *n. pl.* Several small things, or miscellaneous matters, too minute or numerous to be classified.

**SUNDRY**, *a.* [*Sax. sunder, separate*.] Several; divers; more than one or two. [This word, like *several*, is indefinite; but it usually signifies a small number, sometimes many.]

I have composed *sundry* collects.

Sunderston.

*Sundry* foes the rural realm surround.

Dryden.

**SUNFISH**, *n.* [*sun* and *fish*.] *Orthogoriscus*, a genus of cartilaginous fishes belonging to the family *Gymnodontes*, and so named on account of the almost circular form and shining surface of the typical species. The Sunfish appears

like the head of a large fish separated from the body. While swimming it turns upon itself like a wheel. It

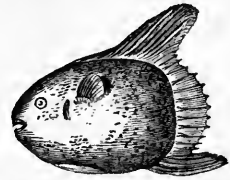
Short Sunfish (*Orthogoriscus mola*).

grows to a large size, often attaining a diameter of four feet and sometimes even that of twelve feet. It is found in all seas from the arctic to the antarctic circle. Two or three species are known.—2. The basking shark.

**SUN-FLOWER**, *n.* [*sun* and *flower*.] The English name of a genus of plants called *Helianthus*, so named from the form and colour of the flower, or from its habit of turning to the sun. [*See* **HELIANTHUS**.] The *bastard sunflower* is of the genus *Helenium*; the *dwarf sunflower* is of the genus *Rudbeckia*, and another of the genus *Tetragonotheca*; the *little sunflower* is of the genus *Cistus*.

**SUNG**, *pret. of Sing*.

While to his harp divine Amphion *sung*.  
Pope.

**SUN-GILT**, *a.* Gilded, as it were, by the rays of the sun.

**SUNK**, *pret.* and *pp. of Sink*.

Or tossed by hope, or *sunk* by care. *Prior*. **SUNK'EN**, *a.* Sunk; lying on the bottom of a river or other water.

**SUN'LESS**, *a.* [*sun* and *less*.] Destitute of the sun or its rays; shaded.

**SUN-LIGHT**, *n.* The light of the sun.

**SUN-LIKE**, *a.* [*sun* and *like*.] Resembling the sun.

**SUN'LIT**, *a.* Lit or lighted by the sun.

**SUN'NAH**, *n.* The name given by Mohammedans to the traditionary portion of their law; which was not, like the Koran, committed to writing by Mohammed, but preserved from his lips by his immediate disciples, or founded on the authority of his actions. The orthodox Mohammedans who receive the *Sunnah* call themselves *Sunnites*, in distinction to the various sects comprehended under the name of *Shiites*.

**SUN'NED**, *pp.* Exposed to the sun's rays.

**SUN'NIAH**, *n.* A name of the sect of *Sunnites*. [*See* **SUNNAH**.]

**SUN'NINESS**, *n.* State of being sunny.

**SUN'NING**, *ppr.* Exposing to the sun's rays; warming in the light of the sun.

**SUN'NITES**, *n. pl.* The orthodox Mohammedans who receive the *Sunnah*,—*which see*.

**SUN'NUL**, *n.* In *India*, a patent, charter, or written authority.

**SUN'NY**, *a.* [*from sun*.] Like the sun; bright.—2. Proceeding from the sun; as, *sunny* beams.—3. Exposed to the rays of the sun; warmed by the direct rays of the sun; as, the *sunny* side of a hill or building.

Her blooming mountains and her *sunny* shores.  
Addison.

4. Coloured by the sun.

Her *sunny* locks,

Hang on her temples like a golden fleece.

Shak.

**SUN-PLANT**, *n.* A plant cultivated in India and Sumatra, *Crotalaria juncea*,

from whose fibres are made small ropes and twine.

SUN'PROOF, *a.* [*sun* and *proof*.] Impervious to the rays of the sun.

SUN'RISE, } *n.* [*sun* and *rise*.] The

SUN'RISING, } first appearance of the sun above the horizon in the morning; or more generally, the time of such appearance, whether in fair or cloudy weather.—2. The east.

SUN-SCORCHED, *a.* Scorched by the sun.

SUN'SET, } *n.* [*sun* and *set*.] The

SUN'SSETTING, } descent of the sun below the horizon; or the time when the sun sets; evening.

SUN'SHINE, *n.* [*sun* and *shine*.] The light of the sun, or the place where it shines; the direct rays of the sun, or the place where they fall.

But all *sunshine*, as when his beams at noon Culminate from th' equator. *Milton.*

2. A place warmed and illuminated; warmth; illumination.

The man that sits within a monarch's heart, And ripens in the *sunshine* of his favour. *Shak.*

SUN'SHINE, } *a.* Bright with the rays

SUN'SHINY, } of the sun; clear, warm, or pleasant; as, a *sunshiny* day; *sunshiny* weather.—2. Bright like the sun.

Flashing beams of that *sunshiny* shield. *Spenser.*

SUNSTONE, *n.* In *min.*, the adularia; a species of felspar.

SUN-STROKE, *n.* A stroke of the sun or his heat.—2. In *med.*, an *ictus solis*, a kind of erysipelas, or an inflammation of the brain or of its membranes, caused by the action of the sun's rays in hot countries.

SUN'WARD, *a.* Toward the sun.

SUO JURE. [*L.*] In or by one's own right.

SUO MARTE. [*L.*] By his own strength or exertion.

SUP, *v. t.* [*Sax* *supan*; *Fr.* *souper*. See SOUP and SIP.] To take into the mouth with the lips, as a liquid; to take or drink by a little at a time; to sip.

There I'll *sup* *Crashaw.*

SUP, *v. i.* To eat the evening meal.

When they had *supped*, they brought Tobias in. *Tobit.*

SUP, *v. t.* To treat with supper.

*Sup* them well.† *Shak.*

SUP, *n.* A small mouthful, as of liquor or broth; a little taken with the lips; a sip.

Tom Thumb got a little *sup*. *Drayton.*

SUP'ER, *a.* Latin preposition, *Gr.* *ὑπερ*, signifies *above, over, excess*. It is much used in composition.—2. In *chem.*, a term prefixed to the name of a salt, to denote an excess of the acid, but the prefix *bi* is now more generally used in this case.

SUP'ERABLE, *a.* [*L.* *superabilis*, from *supero*, to overcome.] That may be overcome or conquered. These are *superable* difficulties.

SUP'ERABLENESS, *n.* The quality of being conquerable or surmountable.

SUP'ERABLY, *adv.* So as may be overcome.

SUPERABOUND', *v. i.* [*super* and *abound*.] To be very abundant or exuberant; to be more than sufficient. The country *superabounds* with corn.

SUPERABOUND'ING, *ppr.* Abounding beyond want or necessity; abundant to excess or a great degree.

SUPERABUND'ANCE, *n.* More than enough; excessive abundance; as, a *superabundance* of the productions of the earth.

SUPERABUND'ANT, *a.* Abounding to excess; being more than is sufficient; as, *superabundant* zeal.

SUPERABUND'ANTLY, *adv.* More than sufficiently.

SUPERACID'ULATED, *a.* [*super* and *acidulated*.] Acidulated to excess.

SUPERADD', *v. t.* [*super* and *add*.] To add over and above; to add to what has been added.—2. To add or annex something extrinsic.

The strength of a living creature, in those external motions, is something distinct from and *superadded* to its natural gravity. *Wilkins.*

SUPERADD'ED, *pp.* Added over and above.

SUPERADD'ING, *ppr.* Adding over and above; adding something extrinsic.

SUPERADDY'TION, *n.* [*super* and *addition*.] The act of adding to something, or of adding something extraneous.—2. That which is added.

This *superaddition* is nothing but fat. *Arbutnot.*

SUPERADVE'NIENT, *a.* [*L.* *superadveniens*.] Coming upon; coming to the increase or assistance of something.

When a man has done bravely by the *superadvenient* assistance of his God. *More.*

2. Coming unexpectedly. [*This word is little used.*]

SUPERANGEL'IC, *a.* [*super* and *angelic*.] Superior in nature or rank to the angels. One class of Unitarians believe Christ to be a *superangelic* being.

SUPERAN'NUATE, *v. t.* [*L.* *super* and *annus*, a year.] To impair or disqualify by old age and infirmity; as, a *superannuated* magistrate.

SUPERAN'NUATE,† *v. i.* To last beyond the year.

SUPERAN'NUATED, *pp.* Impaired or disqualified by old age.

SUPERANNUA'TION, *n.* The state of being too old for office or business, or of being disqualified by old age.

SUPERB', *a.* [*Fr.* *superbe*; *L.* *superbus*, proud, from *super*.] 1. Grand; magnificent; as, a *superb* edifice: a *superb* colonnade.—2. Rich; elegant; as, *superb* furniture or decorations.—3. Showy; pompous; as, a *superb* exhibition.—4. Rich; splendid; as, a *superb* entertainment.—5. August; stately.

SUPERB'-LILY, *n.* A plant and flower.

SUPERB'LY, *adv.* In a magnificent or splendid manner; richly; elegantly.

SUPER'CARGO, *n.* [*super* and *carago*.] An officer or person in a merchant's ship, whose business is to manage the sales and superintend all the commercial concerns of the voyage.

SUPERCELES'TIAL, *a.* [*super* and *celestial*.] Situated above the firmament or great vault of heaven.

SUPERCHARGE, *v. t.* In *her.*, to place one bearing on another.

SUPERCHARGED, *pp.* In *her.*, borne upon another.

SUPERCHARG'ING, *ppr.* In *her.*, placing one bearing on another.

SUPERCH'ERY,† *n.* [*Fr.*] Deceit; cheating.

SUPERCIL'IARY, *a.* [*L.* *super* and *cilium*, the eyebrow.] Situated or being above the eyebrow. The *superciliary arch* is the bony superior arch of the orbit.

SUPERCIL'IOUS, *a.* [*L.* *superciliosus*. See *above*.] 1. Lofty with pride; haughty; dictatorial; overbearing; as, a *supercilious* officer.—2. Manifesting haughtiness, or proceeding from it;

overbearing; as, a *supercilious* air; *supercilious* behaviour.

SUPERCIL'IOUSLY, *adv.* Haughtily; dogmatically; with an air of contempt.

SUPERCIL'IOUSNESS, *n.* Haughtiness; an overbearing temper or manner.

SUPERCIL'IUM, *n.* [*L.* an eyebrow.] In *ancient arch.*, the upper member of a cornice. It is also applied to the small fillets on each side of the scotia of the Ionic base.

SUPERCONCEP'TION, *n.* [*super* and *conception*.] A conception after a former conception.

SUPERCONSEQUENCE,† *n.* [*super* and *consequence*.] Remote consequence.

SUPERCRESC'ENCE, *n.* [*L.* *super* and *crecens*.] That which grows upon another growing thing.

SUPERCRESC'ENT, *a.* [*supra*.] Growing on some other growing thing.

SUPERDOMINANT, *n.* In *music*, the sixth of the key in the descending scale.

SUPEREMINENCE, } *n.* [*L.* *super*

SUPEREMINENCY, } and *emineo*.] Eminence superior to what is common; distinguished eminence; as, the *supereminence* of Cicero as an orator; the *supereminence* of Dr. Johnson as a writer, or of Lord Chatham as a statesman.

SUPEREMINENT, *a.* Eminent in a superior degree; surpassing others in excellence; as, a *supereminent* divine; the *supereminent* glory of Christ.

SUPEREMINENTLY, *adv.* In a superior degree of excellence; with unusual distinction.

SUPEREROGANT, *a.* Supererogatory,—*which see*.

SUPEREROGATE, *v. i.* [*L.* *super* and *erogatio*, *erogo*.] To do more than duty requires. Aristotle's followers have *supererogated* in observance. [*Little used.*]

SUPEREROGATION, *n.* [*supra*.] Performance of more than duty requires.—*Works of supererogation*, in the *church of Rome*, good works performed by men beyond what are necessary for salvation; and which are believed, by Roman Catholics, to be applicable to the benefit of those who fall short in the performance of such works.

There is no such thing as works of *supererogation*. *Tillotson.*

SUPEREROGATIVE, *a.* Supererogatory. [*Not much used.*]

SUPEREROGATORY, *a.* Performed to an extent not enjoined or not required by duty; as, *supererogatory* services.

SUPERESSENTIAL, *a.* [*super* and *essential*.] Essential above others, or above the constitution of a thing.

SUPERETHICAL, *a.* More than ethical.

SUPEREXALT', *v. t.* [*super* and *exalt*.] To exalt to a superior degree.

SUPEREXALTA'TION, *n.* [*super* and *exaltation*.] Elevation above the common degree.

SUPEREXALT'ED, *pp.* Exalted to a superior degree.

SUPEREXALT'ING, *ppr.* Exalting to a superior degree.

SUPEREXCELLENCE, *n.* [*super* and *excellence*.] Superior excellence.

SUPEREXCELLENT, *a.* Excellent in an uncommon degree; very excellent.

SUPEREXCRESC'ENCE, *n.* [*super* and *excrecens*.] Something superfluously growing.

SUPERFECUNDITY, *n.* [*super* and

*fecundity.*] Superabundant fecundity or multiplication of the species.

**SUPERFETATE**, *v. i.* [L. *super* and *fetus*.] To conceive after a prior conception.

The female is said to *superfetate*. *Grev.*  
**SUPERFETATION**, or **SUPERFŒTATION**, *n.* A second conception after a prior one, and before the birth of the first, by which two fetuses are growing at once in the same womb, as in the case of hares and rabbits. The possibility of superfetation in females of the human species, is a matter of controversy among physiologists and medical juriconsults. Examples of superfetation are said to have been found amongst vegetables.

**SUPERFETE**, *v. i.* To superfetate. [*Little used.*]

**SUPERFETE**, *v. t.* To conceive after a former conception. [*Little used.*]

**SUPERFICE**, *n.* Superficies; surface. [*Little used.*] [See **SUPERFICIES**.]

**SUPERFICIAL**, *a.* [It. *superficial*; Sp. *superficial*; Fr. *superficiel*; from *superficies*.] 1. Being on the surface; not penetrating the substance of a thing; as, a *superficial* colour; a *superficial* covering.—2. Composing the surface or exterior part; as, soil constitutes the *superficial* part of the earth.—3. Shallow; contrived to cover something.

This *superficial* tale

Is but a preface to her worthy praise. *Shak.*  
4. Shallow; not deep or profound; reaching or comprehending only what is obvious or apparent; as, a *superficial* scholar; *superficial* knowledge.—*Superficial* content of any body, the number of square inches, feet, &c., contained in its surface.—*Superficial* measure, square measure. [See **MEASURE**, **SQUARE**.]

**SUPERFICIALIST**, *n.* One of superficial attainments.

**SUPERFICIALITY**, *n.* The quality of being superficial. [*Not much used.*]

**SUPERFICIALLY**, *adv.* On the surface only; as, a substance *superficially* tinged with a colour.—2. On the surface or exterior part only; without penetrating the substance or essence; as, to survey things *superficially*.—3. Without going deep or searching things to the bottom; slightly. He reasons *superficially*.

I have laid down *superficially* my present thoughts. *Dryden.*

**SUPERFICIALNESS**, *n.* Shallow-ness; position on the surface.—2. Slight knowledge; shallowness of observation or learning; show without substance.

**SUPERFICIARY**, *n.* In *law*, one who pays the quit-rent of a house built on another man's ground.

**SUPERFICIES**, *n.* [L. from *super*, upon, and *facies*, face.] The surface; the exterior part of a thing. A *superficies* consists of length and breadth without thickness, and therefore forms no part of the substance or solid content of a body; as, the *superficies* of a plate or of a sphere. *Superficies* is rectilinear, curvilinear, plane, convex, or concave. [See these terms, and also **SURFACE**.]

**SUPERFINE**, *a.* [*super* and *fine*.] Very fine or most fine; surpassing others in fineness; as, *superfine* cloth. The word is chiefly used of cloth, but sometimes of liquors; as, *superfine* wine or cider; and of other things, as *superfine* wire; *superfine* flour.

**SUPERFINE'NESS**, *n.* Quality of being superfine.

**SUPERFLUENCE**, *n.* [L. *super* and *fluo*, to flow.] Superfluity; more than is necessary. [*Little used.*]

**SUPERFLUITANCE**, *n.* [L. *super* and *fluito*, to float.] The act of floating above or on the surface. [*Little used.*]

**SUPERFLUITANT**, *a.* Floating above or on the surface. [*Little used.*]

**SUPERFLUITY**, *n.* [Fr. *superfluité*; It. *superfluità*; L. *superfluitas*; *super* and *fluo*, to flow.] 1. Superabundance; a greater quantity than is wanted; as, a *superfluity* of water or provisions.—2. Something that is beyond what is wanted; something rendered unnecessary by its abundance. Among the *superfluities* of life we seldom number the abundance of money.

**SUPERFLUOUS**, *a.* [L. *superfluus*, overflowing; *super* and *fluo*, to flow.] 1. More than is wanted; rendered unnecessary by superabundance; as, a *superfluous* supply of corn.—2. More than sufficient; unnecessary; useless; as, a composition abounding with *superfluous* words. *Superfluous* epithets rather enfeeble than strengthen description. If what has been said will not convince, it would be *superfluous* to say more.—*Superfluous interval*, in *music*, is one that exceeds a true diatonic interval by a semitone minor.—*Superfluous polygamy*, (*Polygamia superflua*), a kind of inflorescence or compound flower, in which the florets of the disk are hermaphrodite and fertile, and those of the ray, though female or pistilliferous only, are also fertile; designating the second order of the class *Syngenesia* of Linnæus.—*Superfluous sound or tone*, is one which contains a semitone minor more than a tone.

**SUPERFLUOUSLY**, *adv.* With excess; in a degree beyond what is necessary.

**SUPERFLUOUSNESS**, *n.* The state of being superfluous or beyond what is wanted.

**SUPERFLUX**, *n.* [L. *super* and *fluxus*.] That which is more than is wanted. [*Little used.*]

**SUPERFOLIATION**, *n.* [*super* and *foliation*.] Excess of foliation.

**SUPERHUMAN**, *a.* [*super* and *human*.] Above or beyond what is human; divine.

**SUPERIMPENDING**, *ppr.* Hanging over; threatening from above.

**SUPERIMPOSE**, *v. t.* (*superimpo'ze*) [*super* and *impose*.] To lay or impose on something else; as, a stratum of earth *superimposed* on a different stratum.

**SUPERIMPOSED**, *pp.* Laid or imposed on something.

**SUPERIMPOSING**, *ppr.* Laying on something else.

**SUPERIMPOSITION**, *n.* The act of laying or the state of being placed on something else.

**SUPERIMPREGNATION**, *n.* [*super* and *impregnation*.] The act of impregnating upon a prior impregnation; impregnation when previously impregnated.

**SUPERINCUMBENCY**, } *n.* State of  
**SUPERINCUMBENCE**, } lying upon something.

**SUPERINCUMBENT**, *a.* [*super* and *incumbent*.] Lying or resting on something else; as, a *superincumbent* bed or stratum.

**SUPERINDUCE**, *v. t.* [*super* and *in-*

*duce*.] To bring in or upon as an addition to something; as, to *superinduce* a virtue or quality upon a person not before possessing it.

Long custom of sinning *superinduces* upon the soul new and absurd desires.

*South.*

**SUPERINDUCED**, *pp.* Induced or brought upon something.

**SUPERINDUCEMENT**, *n.* Act of superinducing.

**SUPERINDUCING**, *ppr.* Inducing on something else.

**SUPERINDUC'TION**, *n.* The act of superinducing.

The *superinduction* of ill habits quickly defaces the first rude draught of virtue.

*South.*

**SUPERINFUSE**, *v. t.* To infuse over.

**SUPERINJECTION**, *n.* [*super* and *injection*.] An injection succeeding another.

**SUPERINSPECT**, *v. t.* [*super* and *inspect*.] To oversee; to superintend by inspection. [*Little used.*]

**SUPERINSTITUTION**, *n.* [*super* and *institution*.] One institution upon another; as when A. is instituted and admitted to a benefice upon a title, and B. is instituted and admitted upon the presentation of another.

**SUPERINTELLECTUAL**, *a.* [*super* and *intellectual*.] Being above intellect.

**SUPERINTEND**, *v. t.* [*super* and *tend*.] To have or exercise the charge and oversight of; to oversee with the power of direction; to take care of with authority; as, an officer *superintends* the building of a ship or the construction of a fort. God exercises a *superintending* care over all his creatures.

**SUPERINTEND'ED**, *pp.* Overseen; taken care of.

**SUPERINTEND'ENCE**, } *n.* The act  
**SUPERINTEND'ENCY**, } of superintending; care and oversight for the purpose of direction, and with authority to direct.

**SUPERINTEND'ENT**, *n.* One who has the oversight and charge of something, with the power of direction; as, the *superintendent* of an alms-house or work-house; the *superintendent* of public works; the *superintendent* of customs or finance.—2. An ecclesiastical superior in some reformed churches. In the *Church of Scotland*, *superintendents* were persons chosen immediately after the reformation, to watch over the conduct of the parochial clergy, and to attend to the affairs of the church. They were appointed in place of the bishops, but were discontinued after the church had been regularly organized.

**SUPERINTEND'ER**, *n.* A superintendent.

**SUPERINTEND'ING**, *ppr.* Overseeing with the authority to direct what shall be done and how it shall be done.

**SUPERINVEST'ITURE**, *n.* An upper vest or garment.

**SUPERIOR**, *a.* [Sp. and L. from *super*, above; Fr. *superieur*.] 1. Higher; upper; more elevated in place; as, the *superior* limb of the sun; the *superior* part of an image.—2. Higher in rank or office; more exalted in dignity; as, a *superior* officer; a *superior* degree of nobility.—3. Higher or greater in excellence; surpassing others in the greatness, goodness, or value of any quality; as, a man of *superior* merit, of *superior* bravery, of *superior* talents

or understanding, of *superior* accomplishments.—4. Being beyond the power or influence of; too great or firm to be subdued or affected by; as, a man *superior* to revenge.

There is not on earth a spectacle more worthy than a great man *superior* to his sufferings. *Spectator*.

5. In *bot.*, a *superior ovary* is one that is situated above the perianth, as in the hyacinth and tulip.—*Superior courts*, in *England*, the courts of law and equity, ecclesiastical, maritime, prize or international courts, and courts of appeal and error. The superior courts of law are the court of king's bench, of common pleas, and of the exchequer. The superior courts of equity are the high court of chancery, the rolls court, and the court of the vice-chancellor of England; all these are located in the metropolis. In *Scotland*, the *superior courts* are the court of session and the court of exchequer.—*Superior planets*, an epithet applied to those planets which are more distant from the sun than the earth, as, Mars, Jupiter, Saturn, Herschel, and Neptune.

**SUPERIOR**, *n.* One who is more advanced in age. Old persons or elders are the *superiors* of the young.—2. One who is more elevated in rank or office.—3. One who surpasses others in dignity, excellence, or qualities of any kind. As a writer of pure English, Addison has no *superior*.—4. The chief of a monastery, convent, or abbey.—5. In *Scots law*, one who has made an original grant of heritable property, on condition that the grantee, termed the *vassal*, shall annually pay to him a certain sum or perform certain services.

**SUPERIORITY**, *n.* Pre-eminence; the quality of being more advanced or higher, greater or more excellent than another in any respect; as, *superiority* of age, of rank or dignity, of attainments or excellence. The *superiority* of others in fortune and rank, is more readily acknowledged than *superiority* of understanding.—2. In *Scots law*, the right which the superior enjoys in the land held by the vassal. It is not a right of use in the lands, but only a right to the civil rights of feu duty, and other services stipulated in the grant, and to the casualties which are by law given to a superior. The right of the superior is technically called *dominium directum*, and the interest which the vassal enjoys in the land is called *dominium utile*, and also fee or property. By the law of Scotland, the sovereign is overlord or superior of all the lands in the kingdom; but a person holding lands under the sovereign as superior may convey them to another, to be held under himself as superior; and in general a proprietor of land may convey the same to be held under himself as superior.

**SUPERLATION**, *† n.* [*L. superlatio*.] Exaltation of anything beyond truth or propriety.

**SUPERLATIVE**, *a.* [*Fr. superlatif*; *L. superlatus*; *super* and *latus*, *latus*, *fero*.] 1. Highest in degree; most eminent; surpassing all other; as, a man of *superlative* wisdom or prudence, of *superlative* worth; a woman of *superlative* glory.—2. Supreme; as, the *superlative* beauty of the divine character.—3. In *gram.*, expressing the highest or utmost degree of something; as, the *superlative* degree of comparison.

**SUPERLATIVE**, *n.* In *gram.*, the superlative degree of adjectives, which is formed by the termination *est*, as *meanest*, *highest*, *bravest*; or by the use of *most*, as *most high*, *most brave*; or by *least*, as *least amiable*.

**SUPERLATIVELY**, *adv.* In a manner expressing the utmost degree.

I shall not speak *superlatively* of them.

*Bacon*.

2. In the highest or utmost degree. Tiberius was *superlatively* wicked; Clodius was *superlatively* profligate.

**SUPERLATIVENESS**, *n.* The state of being in the highest degree.

**SUPERLUNAR**, } *a.* [*L. super* and  
**SUPERLUNARY**, } *luna*, the moon.]  
Being above the moon; not sublunary or of this world.

The head that turns at *superlunar* things.

*Pope*.

**SUPERMEDIAL**, *a.* Lying or being above the middle.

**SUPERMOLECULE**, *n.* A compounded molecule or combination of two molecules of different substances.

**SUPERMUNDANE**, *a.* [*super* and *mundane*.] Being above the world.

**SUPERNAULUM**, *n.* [*L. super* and *G. nagel*, a nail.] Good liquor, of which not enough is left to wet one's nail. [*Local*.]

**SUPERNAL**, *a.* [*L. supernus*, *super*.] 1. Being in a higher place or region; locally higher; as, the *supernal* orbs; *supernal* regions.—2. Relating to things above; celestial; heavenly; as, *supernal* grace.

Not by the sufferings of *supernal* pow'r.

*Milton*.

**SUPERNATANT**, *a.* [*L. supernatus*, *supernato*; *super* and *nato*, to swim.] Swimming above; floating on the surface; as, oil *supernatant* on water; *supernatant* leaves.

**SUPERNATATION**, *n.* The act of floating on the surface of a fluid.

**SUPERNATURAL**, *a.* [*super* and *natural*.] Being beyond or exceeding the powers or laws of nature; miraculous. A *supernatural* event is one which is not produced according to the ordinary or established laws of natural things. Thus if iron has more specific gravity than water, it will sink in that fluid; and the floating of iron on water must be a *supernatural* event. Now no human being can alter a law of nature; the floating of iron on water therefore must be caused by divine power specially exerted to suspend, in this instance, a law of nature. Hence, *supernatural* events or miracles can be produced only by the immediate agency of divine power.

**SUPERNATURALISM**, *n.* The state of being supernatural.—2. A term used chiefly in German theology, in contradistinction to *rationalism*. In its widest extent, *supernaturalism* is the doctrine that religion and the knowledge of God require a revelation from God. It considers the Christian religion as an extraordinary phenomenon, out of the circle of natural events, and as communicating truths above the comprehension of human reason. [*See RATIONALISM*.]

**SUPERNATURALIST**, *n.* One who upholds the principles of supernaturalism.

**SUPERNATURALISTIC**, *a.* Relating to supernaturalism.

**SUPERNATURALISTS**, *n.* In *Germany*, a name given to those who hold the doctrine of supernaturalism. They

may be regarded as a middle party between the evangelicals and rationalists.

**SUPERNATURALLY**, *adv.* In a manner exceeding the established course or laws of nature. The prophets must have been *supernaturally* taught or enlightened, for their predictions were beyond human foreknowledge.

**SUPERNATURALNESS**, *n.* The state or quality of being beyond the power or ordinary laws of nature.

**SUPERNUMERARY**, *a.* [*Fr. supernumeraire*; *L. super* and *numerus*, number.] 1. Exceeding the number stated or prescribed; as, a *supernumerary* officer in a regiment; a *supernumerary* canon in the church.—2. Exceeding a necessary, a usual or a round number; as, *supernumerary* addresses; *supernumerary* expense.

**SUPERNUMERARY**, *n.* A person or thing beyond the number stated, or beyond what is necessary or usual.—2. In *milit. affairs*, *supernumeraries* are the officers and non-commissioned officers, attached to a regiment for the purpose of supplying the places of such as fall in action, &c. On the reduction of the regiments, several *supernumeraries* were to be provided for.

**SUPEROXIDE**, *n.* An oxide containing more equivalents of oxide than of the base with which it is combined; a hyperoxide.

**SUPERPARTICULAR**, *† a.* [*super* and *particular*.] Noting a ratio when the excess of the greater term is a unit; as the ratio of 1 to 2, or of 3 to 4.

**SUPERPARTIENT**, *† a.* [*L. super* and *partio*.] Noting a ratio when the excess of the greater term is more than a unit; as that of 3 to 5, or of 7 to 10.

**SUPERPLANT**, *† n.* [*super* and *plant*.] A plant growing on another plant; as the mistletoe. [*We now use parasite and epiphyte*.]

**SUPERPLUS**. *See SURPLUS*.

**SUPERPLUSAGE**, *n.* [*L. super* and *plus*.] That which is more than enough; excess. [*We now use surplussage, which see*.]

**SUPERPONDERATE**, *† v. t.* [*L. super* and *pondero*.] To weigh over and above.

**SUPERPOSE**, *v. t.* (*superpo'ze*.) [*super* and *Fr. poser*, to lay.] To lay upon, as one kind of rock on another.

**SUPERPOSED**, *pp.* Laid or being upon something.

**SUPERPOSING**, *ppr.* Placing upon something.

**SUPERPOSITION**, *n.* [*super* and *positio*.] A placing above; a lying or being situated above or upon something.—2. In *geol.*, the order in which mineral masses are placed upon or above each other; as more recent strata upon those that are older; secondary rocks upon primary, tertiary upon secondary, &c. Stratified rocks in their arrangement observe a certain order of superposition, unless where volcanic agency has disturbed the arrangement, by forcing up rocks from below, and throwing them as it were upon those which in the usual order of superposition would be above them. [*See STRATA*.]—3. That which is situated above or upon something else.

**SUPERPRAISE**, *v. i.* (*su'perpraze*.) To praise to excess.

**SUPERPROPORTION**, *n.* [*super* and *proportion*.] Overplus of proportion.

**SUPERPURGATION**, *n.* [*super* and *purgatio*.] More purgation than is sufficient.

**SUPERREFLECTION**, *n.* [*super* and

*reflection.*] The reflection of an image reflected.

**SUPER-REG'AL**, *a.* More than regal.  
**SUPERREWARD'**, *v. t.* To reward to excess.

**SUPERROY'AL**, *a.* [*super* and *royal*.] Larger than royal, the name of a large species of printing paper.

**SUPERSA'LIENCY**, *n.* [*L. super* and *salio*, to leap.] The act of leaping on anything. [*Little used.*]

**SUPERSA'LIENT**, *a.* Leaping upon.

**SUPERSALT**, *n.* In *chem.*, a salt with a greater number of equivalents of acid than base, opposed to *subsalt*. Chemists, however, now usually prefix a numeral to such a salt to indicate its composition. Thus a salt consisting of two equivalents of oxalic acid, and one of potassa, is termed *binoxalate* of potassa; and when four equivalents of the same acid are united with one of potassa, the salt is termed *quadroxalate* of potassa. Also, the two salts of sulphuric acid and potassa are called *sulphate* and *bisulphate*, the first containing an equivalent of the acid and alkali, and the second two equivalents of the acid and one of the alkali.

**SUPERSAT'URATE**, *v. t.* [*L. super* and *saturō*.] To add to beyond saturation.

**SUPERSAT'URATED**, *pp.* More than saturated.

**SUPERSAT'URATING**, *ppr.* More than saturating; filling to excess.

**SUPERSATURAT'ION**, *n.* The operation of adding beyond saturation, or the state of being thus supersaturated.

**SUPERSCAP'ULAR**, *a.* [*L. super* and *scapula*, the shoulder-blade.] Situated above the shoulder-blade, as the *superscapular* muscles.

**SUPERSCRIBE**, *v. t.* [*L. super* and *scribo*, to write.] To write or engrave on the top, outside, or surface; or to write the name or address of one on the outside or cover; as, to *superscribe* a letter.

**SUPERSCRIBED**, *pp.* Inscribed on the outside.

**SUPERSCRIBING**, *ppr.* Inscribing, writing, or engraving on the outside, or on the top.

**SUPERSCRIPT**, *† n.* Superscription.

**SUPERSCRIPTION**, *n.* The act of superscribing.—2. That which is written or engraved on the outside, or above something else.

The *superscription* of his accusation was written over, the king of the Jews; Mark xv.; Luke xxiii.

3. An impression of letters on coins; Matt. xxii.

**SUPERSEC'ULAR**, *a.* [*super* and *secular*.] Being above the world or secular things.

**SUPERSEDE**, *v. t.* [*L. supersedeo*; *super* and *sedeo*, to sit.] 1. Literally, to set above; hence, to make void, inefficacious, or useless by superior power, or by coming in the place of; to set aside; to render unnecessary; to suspend. The use of artillery in making breaches in walls, has *superseded* the use of the battering ram. The effect of passion is to *supersede* the workings of reason.

Nothing is supposed that can *supersede* the known laws of natural motion. *Bentley*.  
2. To come or be placed in the room of; hence, to displace or render unnecessary; as, an officer is *superseded* by the appointment of another person.

**SUPERSEDEAS**, *n.* In *law*, a writ of *supersedeas* is a writ or command to

suspend the powers of an officer in certain cases, or to stay proceedings; as, to stay an execution after a writ of error has been allowed, and bail put in; to set aside erroneous judicial processes, &c. In bankruptcy, it is the writ used for the purpose of superseding the fiat. In its more general sense, the term is used to express that which stays legal proceedings, although no writ of *supersedeas* may have been used for that purpose.

**SUPERSEDED**, *pp.* Made void; rendered unnecessary or inefficacious; displaced; suspended.

**SUPERSEDE'RE**. [*L. supersedeo*.] In *Scots law*, a term used in two significations. It is either a private agreement amongst creditors under a trust-deed and accession, that they will *supersede* or *sist* diligence for a certain period; or it is a judicial act by which the court, where it sees cause, grants a debtor protection against diligence, without consent of the creditors.

**SUPERSEDING**, *ppr.* Coming in the place of; setting aside; rendering useless; displacing; suspending.

**SUPERSEN'SIBLE**, *a.* Beyond the reach of the senses; above the natural powers of perception.

**SUPERSEN'SUAL**, *a.* Above the senses.

**SUPERSEV'ICEABLE**, *† a.* [*super* and *serviceable*.] Over officious; doing more than is required or desired.

**SUPERSESS'ION**, *n.* The act of superseding.—2. The act of sitting upon anything.

**SUPERSTI'TION**, *n.* [*Fr.* from *L. superstitiō*, *supersto*; *super* and *sto*, to stand.] 1. Absurd opinions and actions, arising from mean and defective ideas of the moral attributes of God. It respects God and beings superior to man, and extends to our religious opinions, worship, and practices. It displays itself in excessive exactness or rigour in religious opinions or practice; extreme and unnecessary scruples in the observance of religious rites not commanded, or of points of minor importance; excess or extravagance in religion; the doing of things not required by God, or abstaining from things not forbidden; or the belief of what is absurd, or belief without evidence. We apply the word *superstition* to the idolatry of the heathens; we apply it also to the Jews, who made the will of God of no effect by their traditions, and substituted ceremonies in place of the religion of their fathers. It is applied to the unscriptural opinions, rites, and ceremonies of the Roman Catholics; and to those protestants who esteem baptism and the Lord's Supper, and the punctual observance of other ceremonies, without regard to morality, as sufficient to ensure salvation. Those persons are also reckoned superstitious who believe, without any evidence, that prophecies are still uttered by divine inspiration, and that miracles are still performed. The word is also extended to those who believe in witchcraft, magic, and apparitions, or that the divine will is declared by omens, or augury; that the fortune of individuals can be affected by things indifferent, by things deemed lucky or unlucky, or that diseases can be cured by words, charms, or incantations.—2. False religion; false worship.—3. A rite or practice proceeding from excess of

scruples in religion. In this sense, it admits of a plural.

They the truth  
With *superstitions* and traditions taint.  
*Milton*.

4. Excessive nicety; scrupulous exactness.—5. Belief in the direct agency of superior powers in certain extraordinary or singular events, or in omens and prognostics.

**SUPERSTI'TIONIST**, *n.* One addicted to superstition.

**SUPERSTI'TIOUS**, *a.* [*Fr. superstitieux*; *L. superstitiosus*.] 1. Over scrupulous and rigid in religious observances; addicted to superstition; full of idle fancies and scruples in regard to religion; as, *superstitious* people.—2. Proceeding from superstition; manifesting superstition; as, *superstitious* rites; *superstitious* observances.—3. Over exact; scrupulous beyond need.—*Superstitious use, in law*, the use of land for a religious purpose, or by a religious corporation.

**SUPERSTI'TIOUSLY**, *adv.* In a superstitious manner; with excessive regard to uncommanded rites or unessential opinions and forms in religion.—2. With too much care; with excessive exactness or scruple.—3. With extreme credulity in regard to the agency of superior beings in extraordinary events.

**SUPERSTI'TIOUSNESS**, *n.* Superstition.

**SUPERSTRAIN**, *v. t.* [*super* and *strain*.] To overstrain or stretch. [*Little used.*]

**SUPERSTRAINED**, *pp.* Overstrained or stretched.

**SUPERSTRAT'UM**, *n.* [*super* and *stratum*.] A stratum or layer above another, or resting on something else.

**SUPERSTRUCT'**, *v. t.* [*L. superstruo*; *super* and *struo*, to lay.] To build upon; to erect.

This is the only proper basis on which to *superstruct* first innocence and then virtue. [*Little used.*] *Decay of Piety*.

**SUPERSTRUCT'ED**, *pp.* Built upon.

**SUPERSTRUCT'ING**, *ppr.* Building upon.

**SUPERSTRUCT'ION**, *n.* An edifice erected on something.

My own profession hath taught me not to erect new *superstructions* on an old ruin. *Denham*.

**SUPERSTRUCTIVE**, *a.* Built or erected on something else.

**SUPERSTRUCT'URE**, *n.* Any structure or edifice built on something else; particularly, the building raised on a foundation. This word is used to distinguish what is erected on a wall or foundation from the foundation itself.

—2. Anything erected on a foundation or basis. In education, we begin with teaching languages as the foundation, and proceed to erect on that foundation the *superstructure* of science.

**SUPERSUBSTANTIAL**, *a.* [*super* and *substantial*.] More than substantial; being more than substance.

**SUPERSUBT'LE**, *a.* Over subtle.

**SUPERsul'PHATE**, *n.* Sulphate with a greater number of equivalents of acid than base. [*See SUBSALT*.]

**SUPERsul'PHURETTED**, *a.* Consisting of a greater number of equivalents of sulphur than of the base with which the sulphur is combined.

**SUPERTERRENE**, *a.* [*super* and *terrene*.] Being above ground, or above the earth.

**SUPERTERRES'TRIAL**, *a.* Being



above the earth, or above what belongs to the earth.

**SUPERTONIC**, *n.* In *music*, the note next above the key-note.

**SUPERTRAGICAL**, *a.* Tragical to excess.

**SUPERVACANEOUS**, *a.* [L. *super- vacaneus*; *super* and *vaco*, to make void.] Superfluous; unnecessary; needless; serving no purpose.

**SUPERVACANEOUSLY**, *adv.* Needlessly.

**SUPERVACANEOUSNESS**, *n.* Needlessness.

**SUPERVENE**, *v. i.* [L. *supervento*; *super* and *venio*.] 1. To come upon as something extraneous.

Such a mutual gravitation can never *super- vene* to matter, unless impressed by di- vine power. *Bentley.*

2. To come upon; to happen to.

**SUPERVENIENT**, *a.* Coming upon as something additional or extraneous.

That branch of belief was in him *super- venient* to Christian practice. *Hammond.*

Divorces can be granted, *a mensa et toro*, only for *supervenient* causes. *Z. Swift.*

**SUPERVENTION**, *n.* The act of super- vening.

**SUPERVISAL**, } (*supervi*'zal, su-  
**SUPERVIS'ION**, } *pervizh*'on.) [from  
*supervise*.] The act of overseeing; inspection; superintendence.

**SUPERVISE**, *v. n.* (*supervi*'ze.) Inspec- tion.

**SUPERVISE**, *v. t.* [L. *super* and *visus*, *video*, to see.] To oversee for direc- tion; to superintend; to inspect; as, to *supervise* the press for correction.

**SUPERVISED**, *pp.* Inspected.

**SUPERVISING**, *ppr.* Overseeing; in- specting; superintending.

**SUPERVISOR**, *n.* An overseer; an inspector; a superintendent; as, the *supervisor* of a pamphlet; a *supervisor* of the customs or of the excise.

**SUPERVIS'ORY**, *a.* Pertaining to or having supervision.

**SUPERVIVE**, *v. t.* [L. *super* and *vivo*, to live.] To live beyond; to outlive. The soul will *supervive* all the revolutions of nature. [Little used.] [See **SURVIVE**.]

**SUPINA'TION**, *n.* [L. *supino*.] 1. The act of lying, or state of being laid with the face upward.—2. The act of turning the palm of the hand upward.

**SUPINA'TORS**, *n.* [L. *supino*, to lay with the face upwards.] In *anat.*, a name given to those muscles which turn the hand upwards, as the *supinator longus* and the *supinator brevis*.

**SUPINE**, *a.* [L. *supinus*.] 1. Lying on the back, or with the face upward; opposed to *prone*.—2. Leaning back- ward; or inclining with exposure to the sun.

If the vine  
On rising ground be plac'd on hills *supine*.  
*Dryden.*

3. Negligent; heedless; indolent; thoughtless; inattentive.

He became pusillanimous and *supine*, and openly exposed to any temptation.

*Woodward.*  
These men suffer by their *supine* credulity.

**SUP'INE**, *n.* [L. *supinum*.] In *Latin grammar*, part of the conjugation of a verb, being a verbal substantive of the singular number and the fourth declen- sion. There are two kinds of supines; one called the first supine, ending in *um* of the accusative case, which is always of an active signification, and

follows a verb of motion; as, *abiit de- ambulatum*, he has gone to walk; the other, called the last supine, and ending in *u* of the ablative case, is of a passive signification, and is governed by substantives or adjectives; as, *facile dictu*, easy to be told.

**SUPINELY**, *adv.* With the face upward.—2. Carelessly; indolently; drowsily; in a heedless, thoughtless state.

Who on beds of sin *supinely* lie. *Sandys.*

**SUPINENESS**, *n.* A lying with the face upward.—2. Indolence; drowsiness; heedlessness. Many of the evils of life are owing to our own *supineness*.

**SUPIN'ITY**, for *Supineness*, is not used.

**SUP'PAGE**, *† n.* [from *sup*.] What may be supped; pottage.

**SUPPALP'ATION**, *n.* [L. *suppalpor*; *sub* and *palpor*, to stroke.] The act of enticing by soft words.

**SUPPARASITA'TION**, *† n.* [L. *sup- parasitor*; *sub* and *parasite*.] The act of flattering merely to gain favour.

**SUPPAR'ASITE**, *v. t.* To flatter; to cajole.

**SUPPAWN**. See **SERPAWN**.

**SUP'PED**, *pp.* Having taken the evening meal.

**SUPPED'NEOUS**, *a.* [L. *sub* and *pes*, the foot.] Being under the feet.

**SUPPED'ITATE**, *† v. t.* [L. *suppedito*.] To supply.

**SUPPEDITA'TION**, *n.* [L. *suppedita- tio*.] Supply; aid afforded. [Little used.]

**SUP'PER**, *n.* [Fr. *souper*. See **SUP**.] The evening meal. People who dine late, eat no *supper*. The dinner of fashionable people would be the *supper* of rustics.—*Lord's supper*, the eucha- rist, the sacrament ordained by Christ in his church, of which the outward part is bread and wine, and the inward part or thing signified is the body and blood of Christ.

**SUPPERLESS**, *a.* Wanting supper; being without supper; as, to go *super- less* to bed.

**SUPPER-TIME**, *n.* The time when supper is taken; evening.

**SUPPLANT**, *v. t.* [Fr. *supplanter*; L. *supplanto*; *sub* and *planta*, the bottom of the foot.] 1. To trip up the heels. *Supplanted* down he fell. *Milton.*

2. To remove or displace by stratagem; or to displace and take the place of; as, a rival *supplants* another in the affections of his mistress, or in the favour of his prince.

Suspecting that the courtier had *supplanted* the friend. *Fell.*

3. To overthrow; to undermine.

**SUPPLANTA'TION**, *n.* The act of supplanting.

**SUPPLANT'ED**, *pp.* Tripped up; dis- placed.

**SUPPLANT'ER**, *n.* One that supplants.

**SUPPLANT'ING**, *ppr.* Tripping up the heels; displacing by artifice.

**SUP'PLE**, *a.* [Fr. *souple*; Arm. *soublat*, *soublein*, to bend.] 1. Pliant; flexible; easily bent; as, *supple* joints; *supple* fingers.—2. Yielding; compliant; not obstinate.

If punishment makes not the will *supple*, it hardens the offender. *Locke.*

3. Bending to the humour of others; flattering; fawning.—4. That makes pliant; as, *supple* government.

**SUP'PLE**, *v. t.* To make soft and pliant; to render flexible; as, to *supple* leather.

—2. To make compliant.

A mother persisting till she had *suppled* the will of her daughter. *Locke.*

**SUP'PLE**, *v. i.* To become soft and pliant; as, stones *suppled* into softness.

**SUP'PLED**, *pp.* Made soft and pliant; made compliant.

**SUP'PLELY**, *adv.* Softly; pliantly; mildly.

**SUPPLEMENT**, *n.* [Fr. from L. *sup- plementum*, *suppleo*; *sub* and *pleo*, to fill.] 1. Literally, a supply; hence, an addition to any thing, by which its defects are supplied, and it is made more full and complete. The word is particu- larly used of an addition to a book or paper.—2. † Store; supply.—3. In *trigonometry* and *geometry*, the quantity by which an arc or an angle falls short of 180 degrees or a semicircle; or it is what must be added to an arc or angle in order to make a semicircle or two right angles. Hence, two angles which are together equal to two right angles, or two arcs which are together equal to a semicircle, are the supplements of each other. Thus, in the figure, the angle

B C E is the supplement of the angle B C A, and B C A is the supplement of B C E; also, the arc E B is the supplement of the arc E A, and B A is the supplement of

E B. Hence, when an angle is expressed in degrees, minutes, and seconds, its supplement is found by subtracting the degrees, minutes, and seconds from 180°.

—*Letters of supplement*, in *Scots law*, letters obtained on a warrant from the court of session, where a party is to be sued before an inferior court, and does not reside within its jurisdiction. In virtue of these letters the party may be cited to appear before the inferior judge. They run in the sovereign's name; they recite the ground of action, the reason why it should proceed be- fore the inferior judge, and contain a warrant addressed to messengers-at- arms, as sheriffs in that part, ordering them to cite the defender.—*Oath in sup- plement*, in *Scots law*, an oath allowed to be given by a party in his own favour, after establishing a *semiplena probatio*, that is, something less than a proof, and more than a suspicion; as when a merchant, who proves by the oath of one witness that furnishings have been made, is allowed to prove the particu- lars and prices by his own oath in supplement.

**SUPPLEMENT**, *v. t.* To add something to a writing, &c.

**SUPPLEMENTAL**, } *a.* Additional;  
**SUPPLEMENT'ARY**, } added to sup-  
ply what is wanted; as, a *supplemental* law or bill.—*Supplementary summons*. In *Scots law*, a summons raised in an action where all the parties interested have not been called, or where the original summons requires amendment, and the defender has not appeared.—*Supplemental arcs* in *trigonometry*, arcs of a circle or other curve which have a common extremity, and together sub- tend an angle of 180° or two right angles at the centre. Thus, in the figure under *Supplement*, A B and B E are supplemental arcs. Also the chords of such arcs are termed *supplemental chords*.

**SUPPLEMENTING**, *ppr.* Adding a supplement.

**SUP'PLENESS**, *n.* [from *supple*.] Pliancy; pliability; flexibility; the quality of being easily bent; as, the

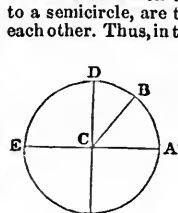

E B. Hence, when an angle is expressed in degrees, minutes, and seconds, its supplement is found by subtracting the degrees, minutes, and seconds from 180°.

—*Letters of supplement*, in *Scots law*, letters obtained on a warrant from the court of session, where a party is to be sued before an inferior court, and does not reside within its jurisdiction. In virtue of these letters the party may be cited to appear before the inferior judge. They run in the sovereign's name; they recite the ground of action, the reason why it should proceed be- fore the inferior judge, and contain a warrant addressed to messengers-at- arms, as sheriffs in that part, ordering them to cite the defender.—*Oath in sup- plement*, in *Scots law*, an oath allowed to be given by a party in his own favour, after establishing a *semiplena probatio*, that is, something less than a proof, and more than a suspicion; as when a merchant, who proves by the oath of one witness that furnishings have been made, is allowed to prove the particu- lars and prices by his own oath in supplement.

**SUPPLEMENT**, *v. t.* To add something to a writing, &c.

**SUPPLEMENTAL**, } *a.* Additional;  
**SUPPLEMENT'ARY**, } added to sup-  
ply what is wanted; as, a *supplemental* law or bill.—*Supplementary summons*. In *Scots law*, a summons raised in an action where all the parties interested have not been called, or where the original summons requires amendment, and the defender has not appeared.—*Supplemental arcs* in *trigonometry*, arcs of a circle or other curve which have a common extremity, and together sub- tend an angle of 180° or two right angles at the centre. Thus, in the figure under *Supplement*, A B and B E are supplemental arcs. Also the chords of such arcs are termed *supplemental chords*.

**SUPPLEMENTING**, *ppr.* Adding a supplement.

**SUP'PLENESS**, *n.* [from *supple*.] Pliancy; pliability; flexibility; the quality of being easily bent; as, the

*suppleness* of the joints.—2. Readiness of compliance; the quality of easily yielding; facility; as, the *suppleness* of the will.

**SUP'PLETIVE**, *a.* Supplying; helping. **SUP'PLETORY**, *a.* [from *L. suppleo*, to supply.] Supplying deficiencies; as, a *suppletory* oath.

**SUP'PLETORY**, *n.* That which is to supply what is wanted.

**SUPPLYAL**, *† n.* The act of supplying.

**SUPPLYANCE**, *† n.* Continuance. **SUP'PLIANT**, *a.* [Fr. from *supplier*, to entreat, contracted from *L. supplico*, to supplicate; *sub* and *plico*, to fold. See **COMPLY** and **APPLY**.] 1. Entreating; beseeching; supplicating; asking earnestly and submissively.

The rich grow *suppliant*, and the poor grow proud. *Dryden.*

2. Manifesting entreaty; expressive of humble supplication.

To bow and sue for grace with *suppliant* knee. *Milton.*

**SUP'PLIANT**, *n.* A humble petitioner; one who entreats submissively.

Spare this life, and hear thy *suppliant's* prayer. *Dryden.*

**SUP'PLIANTLY**, *adv.* In a suppliant or submissive manner.

**SUP'PLICANT**, *n.* [L. *supplicans*.] Entreating; asking submissively.

**SUP'PLICANT**, *n.* One that entreats; a petitioner who asks earnestly and submissively.

The wise *suppliant* left the event to God. *Rogers.*

**SUPPLICAT**, *n.* [L.] In the *English universities*, a petition; particularly, a written application with a certificate that the requisite conditions have been complied with.

**SUPPLICATE**, *v. t.* [L. *supplico*; *sub* and *plico*. See **SUPPLIANT**.] 1. To entreat for; to seek by earnest prayer; as, to *supplicate* blessings on Christian efforts to spread the gospel.—2. To address in prayer; as, to *supplicate* the throne of grace.

**SUPPLICATE**, *v. i.* To entreat; to beseech; to implore; to petition with earnestness and submission.

A man cannot brook to *supplicate* or beg. *Bacon.*

**SUPPLICATING**, *ppr.* or *a.* Entreating; imploring.

**SUPPLICATINGLY**, *adv.* By way of supplication.

**SUPPLICATION**, *n.* [Fr. from *L. supplicatio*.] 1. Entreaty; humble and earnest prayer in worship. In all our *supplications* to the Father of mercies, let us remember a world lying in ignorance and wickedness.—2. Petition; earnest request.—3. In *Roman antiquity*, a religious solemnity observed in consequence of some military success. It consisted in sacrifices, feasting, offering thanks, and praying for a continuance of success.

**SUPPLICATOR**, *† n.* One who supplicates.

**SUPPLICATORY**, *a.* Containing supplication; humble; submissive.

**SUPPLICAVIT**, [L.] In *law*, a writ issuing out of the king's (queen's) bench or chancery, for taking the surety of the peace against a man, when one is in danger of being hurt in the body by another.

**SUPPLIED**, *pp.* [from *supply*.] Fully furnished; having a sufficiency.

**SUPPLIER**, *n.* He that supplies.

**SUPPLIES**, *n. plur.* Things supplied in sufficiency. In *politics*, the sums granted by parliament for defraying the

public expenditure for the current year. The known or probable amount of the different branches of the year's expenses is stated to the house of commons, in a committee of supply, by the chancellor of the exchequer. And after they have been voted by the committee, they are formally granted by an act of parliament. The granting of the annual supplies is one of the peculiar privileges of the house of commons, and the bills passed for this purpose cannot be altered or amended by the house of lords. In *com.*, quantities of goods, provisions, &c., imported or brought into market; as *supplies* of cotton; *supplies* of grain. In this sense used also in the singular.

**SUPPLY'**, *v. t.* [L. *suppleo*; *sub* and *plico*, disused, to fill; Fr. *suppleer*.] 1. To fill up; as any deficiency happens; to furnish what is wanted; to afford or furnish a sufficiency; as, to *supply* the poor with bread and clothing; to *supply* the daily wants of nature; to *supply* the navy with masts and spars; to *supply* the treasury with money. The city is well *supplied* with water.

I wanted nothing fortune could *supply*. *Dryden.*

2. To serve instead of.

Burning ships the banish'd sun *supply*. *Waller.*

3. To give; to bring or furnish.

Nearer care *supplies* Sighs to my breast, and sorrow to my eyes. *Prior.*

4. To fill vacant room.

The sun was set, and Vesper, to *supply* His absent beams, had lighted up the sky. *Dryden.*

5. To fill; as, to *supply* a vacancy.

6. In *general*, to furnish; to give or afford what is wanted.

Modern infidelity *supplies* no such motives. *Rob. Hall.*

**SUPPLY**, *n.* Sufficiency of things for use or want. The poor have a daily *supply* of food; the army has ample *supplies* of provisions and munitions of war. Customs, taxes, and excise constitute the *supplies* of revenue.—2. In *parliamentary lan.*, and *com.* [See **SUPPLIES**.]—*Commissioners of supply*. [See **COMMISSIONER**.]

**SUPPLY'ANT**, *† a.* Auxiliary; supplementary.

**SUPPLYING**, *ppr.* Yielding or furnishing what is wanted; affording a sufficiency.

**SUPPLYMENT**, *† n.* A furnishing.

**SUPPORT**, *v. t.* [Fr. *supporter*; It. *supportare*; L. *supporto*; *sub* and *porto*, to carry.] 1. To bear; to sustain; to uphold; as, a prop or pillar *supports* a structure; an abutment *supports* an arch; the stem of a tree *supports* the branches. Every edifice must have a foundation to *support* it; a rope or cord *supports* a weight.—2. To endure without being overcome; as, to *support* pain, distress, or misfortunes.

This fierce demeanour and his insolence, The patience of a God could not *support*. *Dryden.*

3. To bear; to endure; as, to *support* fatigues or hardships; to *support* violent exertions. The eye will not *support* the light of the sun's disk.—4. To sustain; to keep from fainting or sinking; as, to *support* the courage or spirits.—5. To sustain; to act or represent well; as, to *support* the character of King Lear; to *support* the part assigned.—6. To bear; to supply funds for or the means of continuing; as, to *support* the annual expenses of govern-

ment.—7. To sustain; to carry on; as, to *support* a war or a contest; to *support* an argument or debate.—8. To maintain with provisions and the necessary means of living; as, to *support* a family; to *support* a son in college; to *support* the ministers of the gospel.—9. To maintain; to sustain; to keep from failing; as, to *support* life; to *support* the strength by nourishment.—10. To sustain without change or dissolution; as, clay *supports* an intense heat.—11. To bear; to keep from sinking; as, water *supports* ships and other bodies; air *supports* a balloon.—12. To bear without being exhausted; to be able to pay; as, to *support* taxes or contributions.—13. To sustain; to maintain; as, to *support* a good character.—14. To maintain; to verify; to make good; to substantiate. The testimony is not sufficient to *support* the charges; the evidence will not *support* the statements or allegations; the impeachment is well *supported* by evidence.—15. To uphold by aid or countenance; as, to *support* a friend or a party.—16. To vindicate; to maintain; to defend successfully; as, to be able to *support* one's own cause.—17. To act as an aid, or attendant, on some public occasion; as, the chairman was *supported* by, &c.—18. To second one in his views, in public discourse; as, the hon. mover was well *supported* by other speakers.

**SUPPORT**, *n.* The act or operation of upholding or sustaining.—2. That which upholds, sustains, or keeps from falling, as a prop, a pillar, a foundation of any kind.—3. That which maintains life; as, food is the *support* of life, of the body, of strength. Oxygen or vital air has been supposed to be the *support* of respiration and of heat in the blood.—4. Maintenance; subsistence; as, an income sufficient for the *support* of a family; or revenue for the *support* of the army and navy.—5. Maintenance; an upholding; continuance in any state, or preservation from falling, sinking, or failing; as, taxes necessary for the *support* of public credit; a revenue for the *support* of government.—6. In *general*, the maintenance or sustaining of any thing without suffering it to fail, decline, or languish; as, the *support* of health, spirits, strength, or courage; the *support* of reputation, credit, &c.—7. That which upholds or relieves; aid; help; succour; assistance.—*Points of support*, in *arch.* [See **POINT**.]—*Servitude of support*, in *Scots law*, an urban servitude, whereby the owner of a dominant tenement is entitled to rest the whole, or part of a building, or of a beam, on the house wall or property of the servient tenement.

**SUPPORTABLE**, *a.* [Fr.] That may be upheld or sustained.—2. That may be borne or endured; as, the pain is *supportable*, or not *supportable*.—3. Patience renders evils *supportable*.—4. Tolerable; that may be borne without resistance or punishment; as, such insults are not *supportable*.—5. That can be maintained; as, the cause or opinion is *supportable*.

**SUPPORTABLENESS**, *n.* The state of being tolerable.

**SUPPORTABLY**, *adv.* In a supportable manner.

**SUPPORTANCE**, *† n.* Maintenance; support.

**SUPPORTATION**, *† n.* Maintenance; support. In *Scots law*, any assistance rendered, to enable a person, who is

otherwise incapable, to go to kirk or market, so as to render valid a conveyance of heritage made within sixty days before death.

**SUPPORTED**, *pp.* Borne; endured; upheld; maintained; subsisted; sustained; carried on.

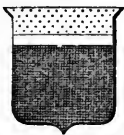

Supported.

—2. In *her.*, a term applied to an ordinary that has another under it by way of support; as, a chief supported.

**SUPPORTER**, *n.* One that supports or maintains.—2. That which supports or upholds; a prop, a pillar, &c.

The sockets and supporters of flowers are figured. *Bacon.*

3. A sustainer; a comforter. The saints have a companion and supporter in all their miseries. *South.*

4. A maintainer; a defender. Worthy supporters of such a reigning impiety. *South.*

5. One who maintains or helps to carry on; as, the supporters of a war.—6. An advocate; a defender; a vindicator; as, the supporters of religion, morality, justice, &c.—7. An adherent; one who takes part; as, the supporter of a party or faction.—8. One who sits by or walks with another, on some public occasion, as an aid or attendant.—9. In *ship-building*, a knee placed under the cat-head.—10. *Supporters*, in *her.*, those figures which are placed on each side of the shield of arms, of sovereigns, noblemen, knights of the garter, bath, bannerets, &c., and appear to support the shield. The origin of supporters is not well ascertained, but the most probable opinion seems to be that they are a comparatively modern invention, or ornamental addition by painters and limners. No person under the rank of a banneret is now allowed the honour of supporters. In the arms of the



Arms of the City of Glasgow.

city of Glasgow, salmon are the supporters.—11. In *arch.*, supporters are images which serve to bear up any part of a building in the place of columns.

**SUPPORTFUL**, *† a.* Abounding with support.

**SUPPORTING**, *ppr.* Bearing; enduring; upholding; sustaining; maintaining; subsisting; vindicating.

**SUPPORTLESS**, *a.* Having no support.

**SUPPORTMENT**, *† n.* Support.

**SUPPOSABLE**, *a.* [from *suppose*.] That may be supposed; that may be imagined to exist. That is not a *supposable* case.

**SUPPOSAL**, *n.* [from *suppose*.] Position.

tion without proof; the imagining of something to exist; supposition.

Interest, with a Jew, never proceeds but upon *supposal* at least, of a firm and sufficient bottom. *† South.*

**SUPPOSE**, *v. t.* [suppo'ze.] [Fr. *supposer*; L. *suppositus*, *suppono*; *sub* and *pono*, to put.] 1. To lay down without proof, or state as a proposition or fact that may exist or be true, though not known or believed to be true or to exist; or to imagine or admit to exist, for the sake of argument or illustration. Let us *suppose* the earth to be the centre of the system, what would be the consequence?

When we have as great assurance that a thing is, as we could possibly, *supposing* it were, we ought not to doubt of its existence. *Tillotson.*

2. To imagine; to admit without proof; to believe without examination; to receive as true.

Let not my lord *suppose* that they have slain all the young men, the king's sons; for Amnon only is dead; 2 Sam. xiii.

3. To imagine; to think.

If our proposals once again were heard... *Milton.*

4. To require to exist or be true. The existence of things *supposes* the existence of a cause of the things.

One falsehood *supposes* another, and renders all you say suspected. *Female Quixote.*

5. *†* To put one thing by fraud in the place of another.

**SUPPOSE**, *n.* Supposition; position without proof.

Fit to be trusted on a bare *suppose* That she is honest. *† Dryden.*

**SUPPOSED**, *pp.* Laid down or imagined as true; imagined; believed; received as true.—*Supposed bass*, in *music*, the bass of a chord when it is not the root of the common chord, as the bass note E or G taken with the chord of C.

**SUPPOSER**, *n.* One who supposes.

**SUPPOSING**, *ppr.* Laying down or imagining to exist or be true; stating as a case that which may be; imagining; receiving as true.

**SUPPOSITION**, *n.* The act of laying down, imagining or admitting as true or existing, what is known not to be true or what is not proved.—2. The position of something known not to be true or not proved; hypothesis.

This is only an infallibility upon *supposition*, that if a thing be true, it is impossible to be false. *Tillotson.*

3. Imagination; belief without full evidence.—4. In *music*, a term borrowed from the French, and used to signify the use of discords followed by concords.

**SUPPOSITIVAL**, *a.* Hypothetical.

**SUPPOSITIVIOUS**, *a.* [L. *suppositivus*, from *suppositus*, *suppono*.] Put by trick in the place or character belonging to another; not genuine; as a *supposititious* child; a *supposititious* writing.

**SUPPOSITIVIOUSLY**, *adv.* Hypothetically; by supposition.

**SUPPOSITIVIOUSNESS**, *n.* The state of being supposititious.

**SUPPOSITIVE**, *a.* Supposed; including or implying supposition.

**SUPPOSITIVELY**, *adv.* With, by, or upon supposition.

**SUPPOSITORY**, *n.* [Fr. *suppositoire*.]

In *med.*, a body introduced into the rectum, there to remain and dissolve gradually, in order to procure stools when clysters cannot be administered.

**SUPPOSURE**, *† n.* Supposition; hypothesis.

**SUPPRESS**, *v. t.* [L. *suppressus*, *supprimo*; *sub* and *premo*, to press.] 1. To overpower and crush; to subdue; to destroy; as, to *suppress* a rebellion; to *suppress* a mutiny or riot; to *suppress* opposition. Every rebellion, when it is *suppressed*, makes the subject weaker and the government stronger. *Davies.*

2. To keep in; to restrain from utterance or vent; as, to *suppress* the voice; to *suppress* sighs.—3. To retain without disclosure; to conceal; not to tell or reveal; as, to *suppress* evidence.

She *suppresses* the name, and this keeps him in a pleasing suspense. *Bacon.*

4. To retain without communication or making public; as, to *suppress* a letter; to *suppress* a manuscript.—5. To stifle; to stop; to hinder from circulation; as, to *suppress* a report.—6. To stop; to restrain; to obstruct from discharges; as, to *suppress* a diarrhea, a hemorrhage, and the like.

**SUPPRESSED**, *pp.* Crushed; destroyed; retained; concealed; stopped; obstructed.

**SUPPRESSING**, *ppr.* Subduing; destroying; retaining closely; concealing; hindering from disclosure or publication; obstructing.

**SUPPRESSION**, *n.* [Fr. from L. *suppressio*.] 1. The act of suppressing, crushing, or destroying; as, the *suppression* of a riot, insurrection, or tumult.—2. The act of retaining from utterance, vent, or disclosure; concealment; as, the *suppression* of truth, of reports, of evidence, and the like.—3. The retaining of any thing from public notice; as, the *suppression* of a letter or any writing.—4. The stoppage, obstruction, or morbid retention of discharges; as, the *suppression* of urine, of diarrhea, or other discharge.—5. In *gram.* or *composition*, omission; as, the *suppression* of a word or words in a sentence, as when a person says, "This is my book," instead of saying, "This book is my book."

**SUPPRESSIVE**, *a.* Tending to suppress; subduing; concealing.

**SUPPRESSOR**, *n.* One that suppresses; one that subdues; one that prevents utterance, disclosure, or communication.

**SUPPURATE**, *v. i.* [L. *suppura*; *sub* and *pus*, *puris*; Fr. *suppurer*; It. *suppurare*.] To generate pus; as, a boil or abscess *suppurates*.

**SUPPURATE**, *v. t.* To cause to suppurate. [In this sense unusual.]

**SUPPURATING**, *ppr.* Generating pus.

**SUPPURATION**, *n.* [Fr. from L. *suppuratio*.] 1. The process of producing purulent matter, or of forming pus, as in a wound or abscess; one of the natural terminations of phlegmonous inflammation.—2. The matter produced by supuration.

**SUPPURATIVE**, *a.* [Fr. *suppuratif*.] Tending to suppurate; promoting supuration.

**SUPPURATIVE**, *n.* A medicine that promotes supuration.

**SUPPUTATION**, *n.* [L. *supputatio*, *supputo*; *sub* and *puto*, to think.] Reckoning; account; computation.

**SUPPUTE**, *† v. t.* [L. *supputo*, *supra*.] To reckon; to compute.

**SUPRA**, a Latin preposition, signifying *above, over, or beyond*, and used as a prefix.

**SUPRA-AX'ILLARY**, *a.* [*supra* and *axil.*] In *bot.*, growing above the axil; inserted above the axil; as a peduncle. [*See SUPRAFOLIACEOUS.*]

**SUPRACIL'IARY**, *a.* [*L. supra* and *cilium*, eyebrow.] Situated above the eyebrow.

**SUPRA-CRETA'CEOUS**, *a.* [*L. supra* and *cretaceus*, chalky.] In *geol.*, a term applied to certain deposits lying above the chalk, or of more recent origin than the chalk formation. Supracretaceous rocks and strata, are synonymous with tertiary rocks and strata.

**SUPRA-DECOM'POUND**, *a.* [*supra* and *decompound.*] More than decomposed; thrice compound. A *supra-decompound leaf*, is when a petiole, divided several times, connects many leaflets; each part forming a decomposed leaf.

**SUPRAFOLIA'CEOUS**, *a.* [*L. supra* and *folium*, a leaf.] In *bot.*, inserted into the stem above the leaf or petiole, or axil, as a peduncle or flower.

**SUPRALAPSA'RIAN**, *a.* [*L. supra* and *lapsus*, fall.] Antecedent to the apostasy of Adam.

**SUPRALAPSA'RIAN**, *n.* One who maintains that God, antecedent to the fall of man or any knowledge of it, decreed the apostasy and all its consequences, determining to save some and condemn others, and that in all he does he considers his own glory only.

**SUPRALAP'SARY**, *n.* or *a.* Supralapsarian.

**SUPRAMUND'ANE**, *a.* [*L. supra* and *mundus*, the world.] Being or situated above the world or above our system.

**SUPRANAT'URALISM**. *See* SUPERNATURALISM.

**SUPRANAT'URALISTS**. *See* SUPERNATURALISTS.

**SUPRA-ORB'ITAL**, *a.* [*supra* and *orbit.*] Being above the orbit of the eye.

**SUPRARE'NAL**, *a.* [*L. supra* and *ren*, *renes*, the kidneys.] Situated above the kidneys.

**SUPRASCAP'ULARY**, *a.* [*L. supra* and *scapula.*] Being above the scapula.

**SUPRA-SPINA'TUS**, *n.* The *suprascapularis* of Cowper, a muscle of the arm, so named from its situation. It arises fleshy from the whole of the base of the scapula that is above its spine, and likewise from the spine itself, and from the superior costa. Its principal use seems to be to assist in raising the arm upwards; at the same time, by drawing the capsular ligament upwards, it prevents it from being pinched between the head of the os humeri and that of the scapula.

**SUPRAVUL'GAR**, *a.* [*supra* and *vulgar.*] Being above the vulgar or common people.

**SUPREMACY**, *n.* [*See* SUPREME.] State of being supreme or in the highest station of power; highest authority or power; as, the *supremacy* of the king of Great Britain; or the *supremacy* of parliament. The term, however, is used particularly to signify supreme and undivided authority in ecclesiastical affairs. This is either papal or regal. Papal supremacy is the authority, legislative, judicial, and executive, which the pope exercised over the churches of England, Scotland, and Ireland, until the middle of the 16th

century, when it was abolished, and which he still exercises, *de facto*, over that portion of the inhabitants of those countries who are in communion with the church of Rome. Regal supremacy is the authority and jurisdiction which the king of England exercises over the church of England, as being the supreme head of that church. This authority is not legislative, but judicial and executive only. Henry VIII. was first acknowledged supreme head of the church in 1533; and this supremacy was confirmed by parliament to him, his heirs, and successors, kings of this realm in 1534. Regal supremacy over the church is not recognized by the established church of Scotland, as it acknowledges no head upon earth.—*Oath of supremacy.* In *Great Britain*, an oath which renounces or abjures the supremacy of the pope in ecclesiastical or temporal affairs in this realm. It is, properly speaking, an oath of non-supremacy, since it negatives the pope's supremacy, and is silent as to any supremacy of the king. It was by many statutes required to be taken, along with the oath of allegiance, by persons in order to qualify themselves for office, &c.; but it is now become almost an unmeaning form.

**SUPREME**, *a.* [*L. supremus*, from *supra*; *Fr. suprême.*] 1. Highest in authority; holding the highest place in government or power. The parliament of Great Britain is *supreme* in legislation; but the king is *supreme* in the administration of the government. In the *United States*, the congress is *supreme* in regulating commerce and in making war and peace. In the universe, God only is the *supreme* ruler and judge. His commands are *supreme*, and binding on all his creatures.—2. Highest, greatest, or most excellent; as *supreme* love; *supreme* glory; *supreme* degree.—3. It is sometimes used in a bad sense; as, *supreme* folly or baseness, folly or baseness carried to the utmost extent. [*A bad use of the word.*]—*The Supreme*, the highest of beings, the sovereign of the universe.

**SUPREME'LY**, *adv.* With the highest authority. He rules *supremely*.—2. In the highest degree; to the utmost extent; as, *supremely* blest.

**SUR**, a prefix, from the French, contracted from *L. super, supra*, signifies *over, above, beyond, upon*. It is sometimes merely intensive.

**SUR'RA**, *n.* [*L.*] The calf of the leg; the fibula.

**SURADDI'TION**, *n.* [*Fr. sur*, on or upon, and *addition.*] Something added to the name.

**SUR'RAL**, *n.* [*L. sura.*] Being in or pertaining to the calf of the leg; as, the *sural* artery.

**SUR'RANCE**, for *Assurance*, not used.

**SUR-ANCRE'E**, [*Fr.*] In *her.*, a *cross sur-ancrée*, or double anchored, is a cross with double anchor flukes at each termination.

**SUR'BASE**, *n.* [*sur* and *base.*] The crowning moulding or cornice of a pedestal; a border or moulding above the base; as, the mouldings immediately above the base of a room.

**SURBASED**, *a.* Having a surbase, or moulding above the base.—*Surbased*

*arch*, an arch whose rise is less than the half-space.

**SURBASEMENT**, *n.* The trait of any arch or vault which describes a portion of an ellipsis.

**SURBATE**, *v. t.* [*It. sobattere*; either *L. sub* and *battere*, or *solea*, sole, and *battere*, to beat the sole or hoof.] 1. To bruise or batter the feet by travel.

Chalky land *surbates* and spoils oxen's feet. *Mortimer.*

2. To harass; to fatigue.

**SURBATED**, *pp.* Bruised in the feet; harassed; fatigued.

**SURBATING**, *ppr.* Bruising the feet of; fatigued.

**SURBEAT**, for *Surbate*, not in use.

**SURBED'**, *v. t.* [*sur* and *bed.*] To set edgewise, as a stone; that is, in a position different from that which it had in the quarry.

**SURBED'DED**, *pp.* Set edgewise.

**SURBED'DING**, *ppr.* Setting edgewise.

**SUR'BET**, *pp.* or *a.* *Surbated*; bruised.

**SURCEASE**, *v. i.* [*Fr. sur* and *cesser*, to cease.] 1. To cease; to stop; to be at an end.—2. To leave off; to practise no longer; to refrain finally.

So prayed he, whilst an angel's voice from high,  
Bade him *surcease* to importune the sky. *Harte.*

[This word is entirely useless, being precisely synonymous with *cease*, and it is nearly obsolete.]

**SURCEASE'**, *v. t.* To stop; to cause to cease.

**SURCEASE'**, *n.* Cessation; stop.

**SURCHARGE**, *v. t.* [*Fr. surcharger*; *sur* and *charge.*] 1. To overload; to overburden; as, to *surcharge* a boat or a ship; to *surcharge* a cannon.

Your head reclined, as hiding grief from view,  
Droops like a rose *surcharged* with morning dew. *Dryden.*

2. In *law*, to overstock; to put more cattle into a common than the person has a right to do, or more than the herbage will sustain.—3. To overcharge; to make an extra charge upon.

**SURCHARGE**, *n.* An excessive load or burden; a load greater than can be well borne.—2. In *law*, an extra charge made by assessors upon such as neglect to make a due return of the taxes to which they are liable.—3. An overcharge beyond what is just and right. *Surcharge of forest*, the putting of more cattle into a forest, by a commoner, than he has a right to do.

**SURCHARGED**, *pp.* Overloaded; overstocked; overcharged.

**SURCHARGER**, *n.* One that overloads or overstocks.—2. *Surcharge of forest*,—*which see.*

**SURCHARGING**, *ppr.* Overloading; burdening to excess; overstocking with cattle or beasts; overcharging.

**SUR' CINGLE**, *n.* [*Fr. sur*, upon, and *L. cingulum*, a belt.] 1. A belt, band, or girth which passes over a saddle, or over any thing laid on a horse's back, to bind it fast.—2. The girdle with which clergymen of the church of England bind their cassocks.

**SUR' CINGLED**, *a.* Girt; bound with a surcingle.

**SUR'CLE**, *n.* [*L. surculus.*] A little shoot; a twig; a sucker.

**SUR'COAT**, *n.* [*Fr. sur* and *Eng. coat.*] A short coat worn over the other clothes.—2. During the *middle ages*, a covering of body armour; being a loose



Cross Sur-Ancrée.

sleeveless wrapper, worn over a coat of mail. It was open in front, but not



Surcoat.—William Longespée, Earl of Salisbury, Salisbury Cathedral.

at the sides, usually reached to the mid-leg, and was girt to the waist by the sword-belt. In late examples, surcoats were often emblazoned with the wearer's arms, but were originally of one colour, or simply variegated.

*Surcoats* seem to have originated with the crusaders, partly for the purpose of distinguishing the many different nations serving under the banner of the cross. *Meyrick.*

**SUR'CREW**, † *n.* [Fr. *surcroit.*] Additional collection; augmentation.

**SUR'FULATE**, † *v. t.* [L. *surculo.*] To prune.

**SURCULA'TION**, † *n.* Act of pruning.

**SUR'CULOSE**, } *a.* In *bot.*, being full of shoots or twigs.

**SUR'ULUS**, *n.* [L.] In *bot.*, any little branch, or twig. Applied by Linnæus particularly to the stem of mosses, or the shoot which bears the leaves.

**SURD**, *a.* [L. *surdus*, deaf.] 1. † Deaf; not having the sense of hearing.—2. † Unheard.—3. Designating a quantity whose root cannot be exactly expressed in numbers.

**SURD**, *n.* In *algea.*, an irrational quantity; a quantity which is incommensurable to unity. Or, a *surd* denotes the root of any quantity, when that quantity is not a complete power of the dimension required by the index of the root. Hence, the roots of such quantities cannot be expressed by rational numbers. Thus the square root of 2, the cube root of 4, the fourth root of 7, &c., are surds, for they cannot be expressed by rational numbers. Surds are usually represented by prefixing the radical signs indicating the operation; thus,  $\sqrt{2}$ ,  $\sqrt[3]{4}$ ,  $\sqrt[4]{7}$ , or they may be expressed by fractional indexes;

thus,  $2^{\frac{1}{2}}$ ,  $4^{\frac{1}{3}}$ ,  $7^{\frac{1}{4}}$ , &c. If 2, 4, and 7 be represented by *a*, *b*, and *c*, then

$\sqrt{a}$ ,  $\sqrt[3]{b}$ , and  $\sqrt[4]{c} = a^{\frac{1}{2}}$ ,  $b^{\frac{1}{3}}$ ,  $c^{\frac{1}{4}}$  are surds. Any rational quantity may be expressed in the form of a surd by reducing its integral into an equivalent

fraction; thus,  $a = a^{\frac{1}{1}}$ , or  $a^{\frac{1}{1}}$ .

**SURD'ITY**, † *n.* Deafness.

**SURD'-NUMBER**, *n.* A number that is incommensurate with unity.

**SURE**, *a.* (shure.) [Fr. *sûr*, *seur*; Arm. *sâr*; Norm. *seor*, *seur*.] 1. Certain; unfailling; infallible.

The testimony of the Lord is *sure*; Ps. xix.

We have also a more *sure* word of prophecy; 2 Pet. i.

2. Certainly knowing; or having full confidence.

We are *sure* that the judgment of God is according to truth; Rom. ii.

Now we are *sure* that thou knowest all things; John xvi.

3. Certain; safe; firm; permanent.

Thy kingdom shall be *sure* to thee; Dan. iv.

4. Firm; stable; steady; not liable to failure, loss or change; as, a *sure* covenant; 2 Sam. xxiii; Nch. ix; Is. xxviii.

The Lord will make my lord a *sure* house; 1 Sam. xxv.

So we say, to stand *sure*, to be *sure* of foot.—5. Certain of obtaining or of retaining; as, to be *sure* of game; to be *sure* of success; to be *sure* of life or health.—6. Strong; secure; not liable to be broken or disturbed.

Go your way, make it as *sure* as ye can; Matth. xxvii.

7. Certain; not liable to failure. The income is *sure*.—*To be sure*, or *be sure*, certainly. Shall you go? *be sure* I shall.—*To make sure*, to make certain; to secure so that there can be no failure of the purpose or object.

*Make sure* of Cato. *Addition.*

A peace cannot fail, provided we *make sure* of Spain. *Temple.*

Give all diligence to *make* your calling and election *sure*; 2 Pet. i.

**SURE**, *adv.* Certainly; without doubt; doubtless.

*Sure* the queen would wish him still unknown. *Smith.*

[But in this sense, *surely* is more generally used.]

**SUREFOOT'ED**, *a.* [*sure* and *foot*] Not liable to stumble or fall; as, a *sure-footed* horse.

**SURELY**, *adv.* Certainly; infallibly; undoubtedly.

In the day thou eatest thereof, thou shalt *surely* die; Gen. ii.

He that created something out of nothing *surely* can raise great things out of small. *South.*

2. Firmly; without danger of falling.

Heth walketh uprightly, walketh *surely*; Prov. x.

**SURENESS**, *n.* Certainty.

For more *sureness* he repeats it. [*Little used.*] *Woodward.*

**SURETISHIP**, *n.* [from *surety*.] The state of being surety; the obligation of a person to answer for another, and make good any debt or loss which may occur from another's delinquency.

He that hateth *suretiship* is sure; Prov. xi.

**SURETY**, *n.* [Fr. *sureté*.] 1. Certainty; indubitableness.

Know of a *surety*, that thy seed shall be a stranger in a land that is not theirs; Gen. xv.

2. Security; safety.

Yet for the more *surety* they looked round about. *Sidney.*

3. Foundation of stability; support.

We our state hold, as you yours, while our obedience holds;

On other *surety* none. *Milton.*

4. Evidence; ratification; confirmation.

She call'd the saints to *surety*, That she would never put it from her finger, Unless she gave it to yourself. *Shak.*

5. Security against loss or damage; security for payment.

There remains unpaid A hundred thousand more, in *surety* of the which

One part of Aquitan is bound to us. *Shak.*

6. In *law*, one that is bound with and for another; one who enters into a bond or recognizance to answer for another's appearance in court, or for his payment of a debt or for the performance of some act, and who, in case of the principal debtor's failure, is compellable to pay the debt or damages; a bondsman; a bail.—*Surety of the peace*, the acknowledging of a recognizance or bond to the king, taken by a competent judge of record for keeping the peace. Magistrates, and justices of the peace, have the power to take such recognizances. A magistrate or a justice of the peace may, according to his discretion, bind all those to keep the peace, who, in his presence, shall make any affray, or shall threaten to kill or beat any person, or shall contend together in hot words; and all those who shall go about with unlawful weapons, or attendance to the terror of the people; and all such persons as shall be known by him to be common barrators, and who shall be brought before him by a constable, for a breach of the peace, in the presence of such constable; and all such persons who, having been before bound to keep the peace, shall be convicted of having forfeited their recognizance. Such recognizance may be obtained by any party from another, on application to a magistrate, and stating on oath that he has just cause to fear that such other "will burn his house or do him a corporal hurt, or that he will procure others to do him mischief." This kind of surety is termed, in Scots law, *law burrows*. Sureties may be similarly required for the good behaviour of parties who have been guilty of conduct tending to a breach of the peace.

He that is *surety* for a stranger shall smart for it; Prov. xi.

Thy servant became *surety* for the lad to my father; Gen. xlv.

7. In *Scrip.*, Christ is called, "the *surety* of a better testament;" Heb. vii. 22. He undertook to make atonement for the sins of men, and thus prepare the way to deliver them from the punishment to which they had rendered themselves liable.—8. A hostage.

**SURETYSHIP**. See **SURETISHIP**.

**SURF**, *n.* The swell of the sea which breaks upon the shore, or upon sand banks or rocks.—2. In *agriculture*, the bottom or conduit of a drain. [*Local.*]

**SURFACE**, *n.* [Fr. *sur*, upon, and *face*.] The exterior part of any thing that has length and breadth; one of the limits that terminates a solid; the superficies; outside; as, the *surface* of the earth; the *surface* of the sea; the *surface* of a diamond; the *surface* of the body; the *surface* of a cylinder; an even or an uneven *surface*; a smooth or rough *surface*; a spherical *surface*.

In *geom.*, a surface or superficies is defined to be "that which has length and breadth only," and is thus distinguished from a line which has length only, and from a solid, which has length, breadth, and thickness. The extremities of a surface are lines, and the intersections of one surface with another are also lines. A *plane surface*, is that in which any two points being taken,

the straight line between them lies wholly in that surface. A surface which may be cut by a plane through any given point, so that the line of common section of the plane and surface may be a curve, is called a *curved surface*; as, the surface of a sphere, cylinder, or cone. Surfaces are distinguished algebraically by the nature and order of their equations. Thus, we have surfaces of the first order, or plane surfaces, and surfaces of the second order, or curved surfaces. Surfaces are also distinguished by their mode of generation; thus the surface of a sphere is generated by the revolution of a semicircular arc about the diameter, which remains fixed. In *physics*, a surface is supposed to be composed of a number of material particles, placed together side by side, without any opening or interstice between them. Such a surface, therefore, cannot be said to be absolutely destitute of thickness, but may be regarded as a film of matter whose thickness is indefinitely small. In *common language*, the word surface is often used to signify not merely the outside or exterior boundary of any substance, but also a certain thickness of the exterior material part. In this way we speak of the *surface* of the earth, the *surface* of the soil, of taking off the surface of any thing, &c.—*Surface damage*, in *Scots law*, damage done to the surface of the ground in consequence of mining operations, &c.

**SURFEIT**, *v. t.* (sur'fit.) [Fr. *sur*, over, and *faire, fait*, to do, *L. facio*.] 1. To feed with meat or drink, so as to oppress the stomach and derange the functions of the system; to overfeed and produce sickness or uneasiness.— 2. To cloy; to fill to satiety and disgust. He *surfeits* us with his eulogies.

**SURFEIT**, *v. i.* To be fed till the system is oppressed, and sickness or uneasiness ensues.

They are as sick that *surfeit* with too much, as they that starve with nothing.

**SURFEIT**, *n.* Fulness and oppression of the system, occasioned by excessive eating and drinking; or of something unwholesome or improper in the food. He has not recovered from a *surfeit*.— 2. Excess in eating and drinking.

Now comes the sick hour that his *surfeit* made.

**SURFEITED**, *pp.* Surcharged and oppressed with eating and drinking to excess; cloyed.

**SURFEITER**, *n.* One who riots; a glutton.

**SURFEITING**, *pp.* Oppressing the system by excessive eating and drinking; cloying; loading or filling to disgust.

**SURFEITING**, *n.* The act of feeding to excess; gluttony; Luke xxi.

**SURFEIT-WATER**, *n.* [*surfeit* and *water*.] Water for the cure of surfeits.

**SURGE**, *n.* [*L. surgo*, to rise; Sans. *surgo*, height.] 1. A large wave or billow; a great rolling swell of water. [It is not applied to small waves, and is chiefly used in poetry and eloquence.] He flies aloft, and with impetuous roar, Pursues the foaming surges to the shore.

2. In *ship-building*, the tapered part in front of the whelps, between the chocks of a capstan, on which the messenger may surge.

**SURGE**, *v. t.* To let go a portion of a rope suddenly. *Surge* the messenger.

**SURGE**, *v. i.* To swell; to rise high and roll; as waves.

The *surging* waters like a mountain rise.

2. To slip back; as, the cable *surges*.

**SURGELESS**, *a.* (surj'less.) Free from surges; smooth; calm.

**SUR'GEON**, *n.* (sur'jen.) [contracted from *chirurgion*.] In a limited sense, one whose profession or occupation is to cure diseases or injuries of the body by manual operation. In a more general sense, one whose occupation is to cure external diseases, whether by manual operation, or by medicines externally or internally. But this latter definition is still too limited, as there are many diseases which cannot be considered *external*, and which, according to modern practice, fall within the province of the surgeon. The truth is, no accurate definition of the term has yet been given, for the reasons stated under *surgery*,— *which see*.

**SUR'GEONCY**, *n.* The office of surgeon in the army or navy.

**SUR'GEONRY**, *n.* The practice of a surgeon; surgery; a surgery.

**SUR'GERY**, *n.* Originally, the manual procedure by means of instruments or not, directed towards the repair of injury, and the cure of disease, in contradistinction to the practice of *medicine*, denoting the treatment of disease by the administration of drugs or other substances, supposed to be of a sanative tendency. The matured progress, however, of the healing art, has rendered such a definition of surgery, in these days, utterly untenable. Many attempts have been made to define surgery according to its present state, so as to prevent interference with the department of physic. By some it has been represented as that branch of medicine which principally effects the cure of diseases by the application of the hand alone, by the employment of instruments, or the use of topical remedies; but this definition is more applicable to the state of surgery some centuries ago, than to the present state of practice. By some writers surgery is said to have for its object the treatment of external diseases, while physic treats of internal diseases. This definition can only be received with numerous exceptions in regard to modern practice, for there are many internal disorders, which are universally allowed to constitute strictly surgical cases; as, for instance, the psoas abscess; stone in the bladder, polyp, and scirrhus of the uterus, stricture of the œsophagus, an extravasation of blood within the skull in consequence of accidental violence. Others have defined surgery to be the mechanical part of physic; but this definition is equally objectionable, as it confines this branch of medicine within too narrow limits. The fact is, that the line of demarcation between surgery and physic cannot be easily traced, nor is it desirable that the attempt should be made. Their principles are the same throughout, and the exercise of their different branches requires the same fundamental knowledge. The physician, before he can be accomplished or successful in his profession, must be intimate with the principles, if not with the practice, of surgery. On the other hand, no one can lay claim to the title of surgeon, far less hope for eminence or success, unless he be equally qualified to assume both the appellation

and the employment of the physician. Surgery, however, in its common acceptation, has been understood to include: 1. The treatment of injuries of all kinds; 2. Of the greater part of external and local complaints; 3. Of such internal affections as produce changes recognizable externally; for example, alterations of figure, colour, or consistency; 4. Of all cases requiring external topical treatment, operations, or manual proceedings of any kind. Still there are various exceptions to some of the above principles of classification.

**SUR'GIANT**, *n. her.*, the same as *Roussant*, or *Rising*,—*which see*.

**SUR'GICAL**, *a.* Pertaining to surgeons or surgery; done by means of surgery; as, *surgical* instruments; *surgical* operations.

**SUR'GING**, *pp.* Swelling and rolling, as billows.

*Surging* waves against a solid rock. *Milton*.

**SUR'GY**, *a.* Rising in surges or billows; full of surges; as, the *surgy* main.

**SUR'GULATE**, *n.* An animal like the ichneumon; the four-toed weasel.

**SUR'LILY**, *adv.* [from *surly*.] In a surly, morose manner.

**SUR'LINESS**, *n.* Gloomy moroseness; crabbed ill nature; as, the *surliness* of a dog.

**SUR'LING**, *n.* A sour morose fellow.

**SUR'LOIN**. See *SIRLOIN*.

**SUR'LY**, *a.* [W. *swr*, surly, snarling; *swri*, surliness; sullenness. Qu. its alliance with *sour*.] 1. Gloomily morose; crabbed; snarling; sternly sour; rough; cross and rude; as, a *surly* groom; a *surly* dog.

2. Rough; dark; tempestuous.

That *surly* spirit, Melancholy. *Shak.*

Now soften'd into joy the *surly* storm.

**SUR'MARKS**, *n.* [*sur* and *mark*.] In *shipbuilding*, the stations of the ribbands and harpings which are marked on the timbers.

**SURMISAL**, *n.* Surmise.

**SURMISE**, *v. t.* (surmi'ze.) [Norm. *surmys*, alleged; *surmitter*, to surmise, to accuse, to suggest; Fr. *sur* and *mettre*, to put.] To suspect; to imagine without certain knowledge; to entertain thoughts that something does or will exist, but upon slight evidence.

It waited nearer yet, and then she knew That what before she but *surmis'd*, was true.

*Dryden*.

This change was not wrought by altering the form or position of the earth, as was *surmised* by a very learned man, but by dissolving it.

*Woodward*.

**SURMISE**, *n.* Suspicion; the thought or imagination that something may be, of which however there is no certain or strong evidence; as, the *surmises* of jealousy or of envy.

We double honour gain From his *surmise* prov'd false. *Milton*.

No man ought to be charged with principles he disowns, unless his practices contradict his professions; not upon small *surmises*.

**SURMISED**, *pp.* Suspected; imagined upon slight evidence.

**SURMISEL**, *n.* One who surmises.

**SURMISING**, *pp.* Suspecting; imagining upon slight evidence.

**SURMISING**, *n.* The act of suspecting; surmise; as, evil *surmisings*; 1 Tim. vi.

**SURMOUNT**, *v. t.* [Fr. *surmonter*; *sur* and *monter*, to ascend.] 1. To rise above.

The mountains of Olympus, Athos and Atlas, *surmount* all winds and clouds.

*Raleigh*.

2. To conquer; to overcome; as, to *surmount* difficulties or obstacles.—3. To surpass; to exceed.

What *surmounts* the reach  
Of human sense. *Milton.*

**SURMOUNT'ABLE**, *a.* That may be overcome; superable.

**SURMOUNT'ABLENESS**, *n.* The state of being surmountable.

**SURMOUNT'ED**, *pp.* Overcome; conquered; surpassed. In *her.*, a term applied to a chief having another smaller chief over it, of a different colour or metal. It is also applied to a charge, with another placed over it; as, a bend, fesse, pale, &c. If on a lion, more properly expressed by the term *debruisé*.—*Surmounted arch* or *dome*, an arch or dome that rises higher than a semicircle.



Surmounted.

**SURMOUNT'ER**, *n.* One that surmounts.

**SURMOUNT'ING**, *ppr.* Rising above; overcoming; surpassing.

**SURMUL'LET**, *n.* A name given to the mullet, a fish of the genus *Mugil*. The red surmullet, (*M. barbatus* or *ruber*), inhabits the Mediterranean, and attains a length of from 12 to 15 inches. Its flesh is esteemed very delicious, and was extravagantly prized by the Romans. It is remarkable for the brilliancy of its colours, and for the changes which they undergo as the fish expires. The striped surmullet (*M. surmuletus*, Linn.) is somewhat smaller, but equal to the red surmullet in delicacy. [See **MULLET**.]

**SUR'MULOT**, *n.* A name given by Buffon to the brown or Norway rat.

**SUR'NAME**, *n.* [Fr. *surnom*; It. *soprannome*; Sp. *sobrenombre*; L. *super* and *nomen*.] 1. An additional name; a name or appellation added to the baptismal or Christian name, and which becomes a family name. Surnames, with us, originally designated occupation, estate, place of residence, or some particular thing or event that related to the person. Thus William *Rufus* or *red*; Edmund *Ironsides*; Robert *Smith*, or *the smith*; William *Turner*. Surnames seem to have been formed at first by adding the name of the father to that of the son, and in this manner several of our surnames were produced. Thus from Thomas William's son we have Thomas Williamson; from John's son we have Johnson, &c. Surnames are said to have been first assumed in England a little before the Conquest, but they were never fully established among the common people till the time of Edward II. They seem to have been introduced into Scotland in the time of William the Conqueror.—2. An appellation added to the original name.

My *surname* Coriolanus. *Shak.*

**SURNAME**, *v. t.* [Fr. *surnommer*.] To name or call by an appellation added to the original name.

Another shall subscribe with his hand to the Lord, and *surname* himself by the name of Israel; Is. xlv.

And Simon he *surnamed* Peter; Mark iii.

**SURNAMED**, *pp.* Called by a name added to the Christian or original name.

**SURNAMING**, *ppr.* Naming by an appellation added to the original name.

**SURNO'MINAL**, *a.* Relating to surnames.

**SUROX'IDE**, *n.* [sur and *oxide*.] An oxide containing a greater number of equivalents of oxygen, than of the base, with which it is combined. [French.]

**SUROX'IDATE**, *n.* To form a suroxide.

**SURP'ASS**, *v. t.* [Fr. *surpasser*; sur and *passer*, to pass beyond.] To exceed; to excel; to go beyond in any thing good or bad. Homer *surpasses* modern poets in sublimity. Pope *surpasses* most other poets in smoothness of versification. Achilles *surpassed* the other Greeks in strength and courage. Clodius *surpassed* all men in the profligacy of his life. Perhaps no man ever *surpassed* Washington in genuine patriotism and integrity of life.

**SURP'ASSABLE**, *a.* That may be exceeded.

**SURP'ASSED**, *pp.* Exceeded; excelled.

**SURP'ASSING**, *ppr.* Exceeding; going beyond.—2. *a.* Excellent in an eminent degree; exceeding others.

O thou, that with *surpassing* glory crown'd.  
*Milton.*

**SURP'ASSINGLY**, *adv.* In a very excellent manner; or in a degree surpassing others.

**SURP'ASSINGNESS**, *n.* The state of surpassing.

**SURPLICE**, *n.* (sur'plis.) [Fr. *surplis*; Sp. *sobrepellicz*; L. *super pellicium*, above the robe of fur.] A white garment worn by clergymen of some de-



Surplice, Brass of Prior Nelond, Cowfold, Sussex.

nominations over their other dress, in their ministrations. It is particularly the habit of the clergy of the church of England.

**SUR'PLICED**, *a.* Wearing a surplice.

**SUR'PLICE-FEES**, *n.* [surplice and *fees*.] Fees paid to the clergy for occasional duties.

**SUR'PLUS**, *n.* [Fr. *sur* and *plus*, L. *id.*, more.] 1. Overplus; that which remains when use is satisfied; excess beyond what is prescribed or wanted.—2. In *law*, the residuum of an estate, after the debts and legacies are paid.

**SURPLUS'AGE**, *n.* Surplus; as, *surplusage* of grain or goods beyond what is wanted.—2. In *law*, something in the pleadings or proceedings not necessary or relevant to the case, and which may be rejected.—3. In *accounts*, a greater disbursement than the charge of the accountant amounteth to.

**SURPRISAL**, *n.* (surpri'zal.) [See **SURPRISE**.] The act of surprising or coming upon suddenly and unexpect-

edly; or the state of being taken unawares.

**SURPRISE**, *v. t.* (surpri'ze.) [Fr. from *surprendre*; sur and *prendre*, to take; L. *super, supra*, and *prendo*, to take.]

1. To come or fall upon suddenly and unexpectedly; to take unawares.

The castle of Macduff I will *surprise*. *Shak.*

Who can speak  
The mingled passions that *surpris'd* his heart?  
*Thomson.*

2. To strike with wonder or astonishment by something sudden, unexpected, or remarkable, either in conduct, words, or story, or by the appearance of something unusual. Thus we are *surprised* at desperate acts of heroism, or at the narration of wonderful events, or at the sight of things of uncommon magnitude or curious structure.—3. To confuse; to throw the mind into disorder by something suddenly presented to the view or to the mind.

Up he starts, discover'd and *surpris'd*.  
*Milton.*

**SURPRISE**, *n.* The act of coming upon unawares, or of taking suddenly and without preparation. The fort was taken by *surprise*.—2. The state of being taken unexpectedly.—3. An emotion excited by something happening suddenly and unexpectedly, as something novel told or presented to view. Nothing could exceed his *surprise* at the narration of these adventures. It expresses less than *wonder* and *astonishment*.—4. † A dish with nothing in it.

**SURPRISED**, *pp.* Come upon or taken unawares; struck with something novel or unexpected.

**SURPRIS'ER**, *n.* One who surprises.

**SURPRISING**, *ppr.* Falling on or taking suddenly or unawares; striking with something novel; taking by a sudden or unexpected attack.—2. *a.* Exciting surprise; extraordinary; of a nature to excite wonder and astonishment; as, *surprising* bravery; *surprising* patience; a *surprising* escape from danger.

**SURPRISINGLY**, *adv.* In a manner or degree that excites surprise. He exerted himself *surprisingly* to save the life of his companion.

**SURPRISINGNESS**, *n.* State of being surprising.

**SUR'QUEDRY**, *n.* [sur and Norm. Fr. *cuidr*, to think. Qu. Sp. *cuidar*, to heed. See **HEED**.] Overweening pride; arrogance.

**SURREBUT**, *v. i.* [sur and *rebut*.] In *legal pleadings*, to reply, as a plaintiff, to a defendant's rebutter.

**SURREBUTTER**, *n.* The plaintiff's reply in pleading to a defendant's rebutter.

**SURREIN'ED**, *† a.* Overridden or injured.

**SURREJOIN**, *v. i.* [sur and *rejoin*.] In *legal pleadings*, to reply, as a plaintiff to a defendant's rejoinder.

**SURREJOIN'DER**, *n.* The answer of a plaintiff to a defendant's rejoinder.

**SURREN'DER**, *v. t.* [Fr. *se rendre*, to yield. *Surrender* is probably a corruption of *se rendre*.] 1. To yield to the power of another; to give or deliver up possession upon compulsion or demand; as, to *surrender* one's person to an enemy, or to commissioners of bankrupt; to *surrender* a fort or a ship. [To *surrender up* is not elegant.]

—2. To yield; to give up; to resign in favour of another; as, to *surrender* a right or privilege; to *surrender* a

place or an office.—3. To give up; to resign; as, to *surrender* the breath.—4. In *law*, to yield an estate, as a tenant, into the hands of the lord for such purposes as are expressed in the act.—5. To yield to any influence, passion, or power; as, to *surrender* one's self to grief, to despair, to indolence, or to sleep.

**SURRENDER**, *v. i.* To yield; to give up one's self into the power of another. The enemy seeing no way of escape, *surrendered* at the first summons.

**SURRENDER**, *n.* The act of yielding or resigning one's person or the possession of something, into the power of another; as, the *surrender* of a castle to an enemy; the *surrender* of a right or of claims.—2. A yielding or giving up.—3. In *law*, the yielding up of an estate for life, or for years, to him that has the immediate estate in reversion or remainder, and is either in fact or in law.—*Surrenders in fact*, must be made by deed, which is the allowable evidence.—A *surrender in law*, is one which may be implied, and generally has reference to estates or tenancies from year to year, &c.—*Surrender of tithes*, in *Scots law*, the submission of tithes made to the crown. [See **TEINDS**.]

**SURRENDERED**, *pp.* Yielded or delivered to the power of another; given up; resigned.

**SURRENDEREE**, *n.* In *law*, a person to whom the lord grants *surrendered* land; the *cestuy que use*.

**SURRENDERING**, *ppr.* Yielding or giving up to the power of another; resigning.

**SURRENDEROR**, *n.* The tenant who *surrenders* an estate into the hands of his lord.

Will the admittance of *cestuy que use*, the lord takes notice of the *surrenderor* as his tenant. *Blackstone*.

**SURREND'RY**, *n.* A *surrender*. [*Surrender* is the most elegant and best authorized.]

**SURREPTION**, *n.* [L. *surreptus*, *sur-repo*; *sub* and *repo*, to creep.] A coming unperceived; a stealing upon insensibly. [Little used.]

**SURREPTIVIOUS**, *a.* [L. *surreptivus*, *supra*.] Done by stealth or without proper authority; made or introduced fraudulently; as, a *surreptitious* passage in a manuscript.

A correct copy of the *Dunciad*, the many *surreptitious* ones have rendered necessary. *Letter to Publisher of Dunciad*.

**SURREPTIVIOUSLY**, *adv.* By stealth; without authority; fraudulently.

**SURROGATE**, *n.* [L. *surrogatus*, *sur-rogo*, *subrogo*; *sub* and *rogo*, to propose. *Rogo*, to ask or propose, signifies primarily to reach, put, or thrust forward; and *subrogo* is to put or set in the place of another.] In a *general sense*, a deputy; a delegate; a substitute; a person appointed to act for another, particularly the deputy of an ecclesiastical judge, most commonly of a bishop or his chancellor.

**SURROGATE**, *v. t.* To put in the place of another. [Little used.]

**SURROGATESHIP**, *n.* The office of surrogate.

**SURROGA'TION**, *n.* The act of substituting one person in the place of another. [Little used.]

**SURROGA'TUM**, *n.* [L.] In *Scots law*, that which comes in place of something else.

**SURROUND**, *v. t.* [*sur* and *round*, Fr.

*round*.] 1. To encompass; to environ; to inclose on all sides; as, to *surround* a city. They *surrounded* a body of the enemy.—2. To lie or be on all sides of; as, a wall or ditch *surrounds* the city. **SURROUND'ED**, *pp.* Encompassed; inclosed; beset.

**SURROUND'ING**, *ppr.* Encompassing; inclosing; lying on all sides of.

**SURROUND'ING**, *n.* An encompassing.

**SUR'ROY**, or **SOUTH'ROY**, *n.* In *her.*, the ancient title of the king-at-arms, for the south parts of England, now called *Clarencieux*.

**SUR'SHARP**, *n.* In *music*, the fifth tetra chord above.

**SURSOLID**, *n.* [*sur* and *solid*, or *surd-solid*.] A name given by the early algebraists to the fifth power of a number; or the product of the fourth multiplication of a number considered as the root. Thus  $3 \times 3 = 9$ , the square of 3, and  $9 \times 3 = 27$ , the third power or cube, and  $27 \times 3 = 81$ , the fourth power, and  $81 \times 3 = 243$ , which is the *sursolid* of 3.

**SURSOLID**, *a.* Denoting the fifth power.—*Sursolid problem*, is that which cannot be resolved but by curves of a higher kind than the conic sections. [Little used.]

**SURTOUT**, *n.* [Fr. *sur-tout*, over all.] Originally a man's coat to be worn over his other garments, but in modern usage, an upper coat with wide skirts reaching down to near the knees, and enveloping the thighs.—2. In *her.*, an escutcheon of pretence, placed upon the centre of a shield of arms, is often said to be in *surtout*.

**SUR'TURBRAND**, *n.* Fibrous brown coal or bituminous wood; so called in Iceland.

**SURVEILLANCE**, *n.* [Fr.] Watch; inspection; oversight.

**SURVENE**, *v. t.* [Fr. *survenir*; *sur* and *venir*, to come.] To supervene; to come as an addition; as, a suppiration that *survenes* lethargies. [Little used.]

**SURVEY**, *v. t.* [Norm. *surveoir*, *sur-veoir*; *sur* and Fr. *voir*, to see or look, contracted from L. *video*, *videre*.] 1. To inspect or take a view of; to overlook; to view with attention, as from a high place; as, to stand on a hill, and *survey* the surrounding country. It denotes more particular and deliberate attention than *look* or *see*.—2. To view with a scrutinizing eye; to examine.

With such alter'd looks,  
All pale and speechless, he *survey'd* me round. *Dryden*.

3. To examine with reference to condition, situation, and value; as, to *survey* a building, to determine its value and exposure to loss by fire.—4. To determine the boundaries and superficial extent of fields, estates, tracts of ground, &c.; to determine the form and dimensions of the plans of towns, the courses of roads, rivers, &c.—5. In *milit. affairs*, to ascertain and represent on paper the roads, rivers, hills and marshes of a country, in order to obtain a knowledge of the positions which may be occupied as fields of battle, or as quarters, &c.—6. To examine or ascertain the position and distances of objects on the shore of the sea, the depth of water, nature of the bottom, and whatever may be necessary to facilitate the navigation of the waters and render the entrance into harbours, sounds, and rivers easy

and safe. Thus officers are employed to *survey* the coast and make charts of the same.—7. To examine and ascertain, as the boundaries and royalties of a manor, the tenure of the tenants, and the rent and value of the same.—8. To examine and ascertain, as the state of agriculture.

**SURVEY**, *n.* [formerly accented on the last syllable.] 1. An attentive view; a look or looking with care. He took a *survey* of the whole landscape.

Under his proud *survey* the city lies. *Denham*.

2. A particular view; an examination of all the parts or particulars of a thing, with a design to ascertain the condition, quantity, or quality; as, a *survey* of the stores, provisions, or munitions of a ship. So also a *survey* of roads and bridges is made by proper officers; a *survey* of buildings is intended to ascertain their condition, value, and exposure to fire. A *survey* of land, as of fields, estates, tracts of country, &c., consists in determining by measurement, laying down angles and taking levels, the dimensions, forms, and boundaries, of such portions of ground, and representing the same upon paper. [See **SURVEYING**.] A *survey* of a harbour, sound, or coast comprehends an examination of the distance and bearing of points of land, isles, shoals, depth of water, course of channels, &c. A *survey* of agriculture includes a view of the state of property, buildings, fences, modes of cultivation, crops, gardens, orchards, woods, live-stock, &c. And in general, *survey* denotes a particular view and examination of anything.—3. In the *U. States*, a district for the collection of the customs, under the inspection and authority of a particular officer.—*Trigonometrical survey*, a survey on a large scale, for determining the length of an arc of the meridian, from which the true figure and magnitude of the earth may be ascertained; for determining the geographical position of the principal places of a country, with a view to give greater accuracy to maps and charts; and for determining the difference of longitude between two observations, as those of Greenwich and Paris. [See **TRIGONOMETRICAL**.]

**SURVEYAL**, *n.* Survey; a viewing.

**SURVEYED**, *pp.* Viewed with attention; examined; measured.

**SURVEYING**, *ppr.* Viewing with attention; examining particularly; measuring.

**SURVEYING**, *n.* In *practical math.*, measuring and delineating portions of the surface of the earth with their divisions and features, and computing of their extent. [See **TRIGONOMETRICAL**.] The principal instruments employed by the surveyor are, the chain for measuring linear distances, commonly called Gunter's chain; the theodolite for the measurement of angles, accompanied by a compass and needle, for determining the bearings; the plane table, the cross-staff or optical square; rods for measuring off-sets; levelling staves; a spirit level; and prismatic compasses. In the higher departments of surveying, instruments of the most refined description must be employed, and processes of calculation deduced from mathematics of the highest order.—*Marine*



*surveying*, consists in determining the forms of coasts and harbours, the positions and distances of objects on the shore, of islands, rocks and shoals, the entrances of rivers, the depth of water, nature of the bottom. [*See SOUNDINGS.*]—*Military surveying*, consists chiefly in ascertaining and representing on paper the principal features of a country, as roads, rivers, hills, marshes, with the view of ascertaining the best positions for fields of battle, or for quarters; and also the facilities which may be afforded for the march of an army.

**SURVEYOR, n.** An overseer; one placed to superintend others.—2. One that views and examines for the purpose of ascertaining the condition, quantity, or quality of anything; as, a *surveyor* of land; a *surveyor* of highways; *surveyors* of ordnance.—*Surveyors of the navy*, officers, belonging to the navy board, who are invested with the charge of building and repairing ships of the navy, at the different dockyards.

**SURVEYOR-GENERAL, n.** A principal surveyor; as, the *surveyor-general* of the king's manors, or of woods and parks in England.—2. In the *U. States*, the chief surveyor of lands; as, the *surveyor-general* of the United States, or of a particular state.

**SURVEYORSHIP, n.** The office of a surveyor.

**SURVIEW, † v. t.** To survey.

**SURVIEW, † n.** Survey.

**SURVISE, † v. t.** [*Fr. sur and viser.*] To look over.

**SURVIVAL, n.** [*See SURVIVE.*] A living beyond the life of another person, thing, or event; an outliving.

**SURVIVANCE, n.** Survivorship. [*Little used.*]

**SURVIVE, v. t.** [*Fr. survivre; sur and vivre, to live; It. sopravvivere; Sp. sobrevivir; L. supervivo.*] 1. To outlive; to live beyond the life of another; as, the wife *survives* her husband; or a husband *survives* his wife.—2. To outlive anything else; to live beyond any event. Who would wish to *survive* the ruin of his country? Many men *survive* their usefulness or the regular exercise of their reason.

**SURVIVE, v. i.** To remain alive.

Try pleasure,  
Which when no other enemy *survives*,  
Still conquers all the conquerors.

Denham.

**SURVIVENCY, n.** A surviving; survivorship.

**SURVIVER, n.** One that outlives another. [*See SURVIVOR.*]

**SURVIVING, ppr.** Outliving; living beyond the life of another, or beyond the time of some event.—2. *a.* Remaining alive; yet living; as, *surviving* friends or relatives.

**SURVIVOR, n.** One who outlives another.—2. In *law*, the longer liver of two joint tenants, or of any two persons who have a joint interest in anything.

**SURVIVORSHIP, n.** The state of outliving another.—2. In *law*, the right of a joint tenant or other person who has a joint interest in an estate, to take the whole estate upon the death of the other. When there are more than two joint tenants, the whole estate remains to the last survivor by right of *survivorship*.—2. In the *doctrine of annuities*, a question of life contingencies is said to be one of survivorship, when a re-

versionary benefit is contingent upon the circumstance of some life or lives surviving some other life or lives, in such a manner that it shall be necessary to calculate the chance of one individual dying before another in every year of life. Thus, the question of finding the premium of an assurance on the death of A, provided B die first, is one of survivorship. Questions of this sort are readily solved by means of tables constructed for the purpose.

**SUS, n.** [*L.*] The generic name for the animal which is well known by the name of the *hog*. [*See SWINE.*]

**SUSCEPTIBILITY, n.** [*From susceptible.*] The quality of admitting or receiving either something additional, or some change, affection, or passion; or the tendency to admit or receive; as, the *susceptibility* of colour in a body; *susceptibility* of culture or refinement; *susceptibility* of love or desire, or of impressions.

**SUSCEPTIBLE, a.** [*Fr. from L. suscipio, to take; sub and capio.*] 1. Capable of admitting anything additional, or any change, affection, or influence; as, a body *susceptible* of colour or of alteration; a body *susceptible* of pain; a heart *susceptible* of love or of impression.—2. Tender; capable of impression; impressible. The minds of children are more *susceptible* than those of persons more advanced in life.—3. Having nice sensibility; as, a man of a *susceptible* heart.

**SUSCEPTIBLENESS, n.** Susceptibility.—*which see.*

**SUSCEPTIBLY, adv.** In a susceptible manner.

**SUSCEPTION, n.** The act of taking. [*But little used.*]

**SUSCEPTIVE, a.** Capable of admitting; readily admitting. Our natures are *susceptive* of errors.

**SUSCEPTIVITY, n.** Capacity of admitting. [*Little used.*]

**SUSCEPTOR, n.** [*L.*] One who undertakes; a godfather.

**SUSCIP'ENCY, n.** Reception; admission.

**SUSCIP'IENT, a.** Receiving; admitting.

**SUSCIP'IENT, n.** One who takes or admits; one that receives.

**SUSCITATE, v. t.** [*Fr. susciter; L. suscito; sub and cito.*] To rouse; to excite; to call into life and action.

**SUSCITATED, pp.** Roused; excited.

**SUSCITATING, ppr.** Exciting; calling into life and action.

**SUSCITATION, n.** The act of raising or exciting.

**SUS'LIK, or SOUS'LIK, n.** A pretty little animal of the marmot kind, *Mus citillus*, Linn., of a grayish-brown,



Suslik (*Mus citillus*).

waved or spotted with white. It is found in Bohemia, and as far north as Siberia, and has a particular taste for flesh, not sparing even its own species. There are some species in America. It is named also the earless marmot.

**SUSPECT, v. t.** [*L. suspectus, suspicio; sub and specio, to see or view.*] 1. To mistrust; to imagine or have a slight opinion that something exists, but without proof, and often upon weak evidence or no evidence at all. We *suspect* not only from fear, jealousy, or apprehension of evil, but in modern usage, we *suspect* things which give us no apprehension.

Nothing makes a man *suspect* much, more than to know little. Bacon.

From her hand I could *suspect* no ill.

Milton.

2. To imagine to be guilty, but upon slight evidence or without proof. When a theft is committed, we are apt to *suspect* a person who is known to have been guilty of stealing; but we often *suspect* a person who is innocent of the crime.—3. To hold to be uncertain; to doubt; to mistrust; as, to *suspect* the truth of a story.—4. To hold to be doubtful. The veracity of a historian, and the impartiality of a judge, should not be *suspected*.—5. To conjecture.

**SUSPECT v. i.** To imagine guilt.

If I *suspect* without cause, why then let me be your jest. Shak.

**SUSPECT, a.** Doubtful. [*Not much used.*]

**SUSPECT, † n.** Suspicion.

**SUSPECTABLE, a.** That may be suspected. [*Little used.*]

**SUSPECTANT, or SPEC'TANT, ppr.** In *her*, looking upwards, the nose bendways.

**SUSPECTED, pp.** Imagined without proof; mistrusted.

**SUSPECTEDLY, adv.** So as to excite suspicion; so as to be suspected.

**SUSPECTEDNESS, n.** State of being suspected or doubted.

**SUSPECTER, n.** One who suspects.

**SUSPECTFUL, or SPEC'TANT, ppr.** Mistrust.

**SUSPECTING, ppr.** Imagining without evidence; mistrusting upon slight grounds.

**SUSPECTLESS, a.** Not suspecting; having no suspicion.—2. Not suspected; not mistrusted.

**SUSPEND, v. t.** [*Fr. suspendre; L. suspendo; sub and pendo, to hang.*]

1. To hang; to attach to something above; as, to *suspend* a ball by a thread; to *suspend* the body by a cord or by hooks; a needle *suspended* by a lodestone.—2. To make to depend on.

God hath *suspended* the promise of eternal life on the condition of faith and obedience.—3. To interrupt; to intermit; to cause to cease for a time. The guard nor fights nor flies; their fate so near

At once *suspends* their courage and their fear. Denham.

4. To stay; to delay; to hinder from proceeding for a time.

*Suspend* your indignation against my brother. Shak.

I *suspend* their doom. Milton.

5. To hold in a state undetermined; as, to *suspend* one's choice or opinion.

—6. To debar from any privilege, from the execution of an office, or from the enjoyment of income.

Good men should not be *suspended* from the exercise of their ministry and deprived of their livelihood, for ceremonies which are acknowledged indifferent. Sanderson.

7. To cause to cease for a time from operation or effect; as, to *suspend* the

habeas corpus act.—*To suspend an officer* in the army, is to deprive him, on account of some misconduct, of his pay, and render him incapable of exercising the duties of his office, during the pleasure of the commander-in-chief.—*To suspend an officer* in the navy, is to put him under arrest for some misconduct. [See SUSPENSION.]

SUSPEND'ED, *pp.* Hung up; made to depend on; caused to cease for a time; delayed; held undetermined; prevented from executing an office or enjoying a right.

SUSPEND'ER, *n.* One that suspends.—2. *Suspenders*, plur. straps worn for holding up pantaloons, &c.; braces. [American, or local.]

SUSPEND'ING, *ppr.* Hanging up; making to depend on; intermitting; causing to cease for a time; holding undetermined; debarring from action or right.

SUSPENS'ION, *n.* A temporary cessation.  
SUSPENSE, *n.* (suspens'.) [L. *suspensus*.] A state of uncertainty; indetermination; indecision. A man's mind is in *suspense*, when it is balancing the weight of different arguments or considerations, or when it is uncertain respecting facts unknown, or events not in his own power.

Ten days the prophet in *suspense* remain'd.  
Denham.

2. Stop; cessation for a time.  
A cool *suspense* from pleasure or from pain.  
Pope.

3. In *law*, suspension; a temporary cessation of a man's right; as when the rent or other profits of land cease by unity of possession of land and rent.

SUSPENSE, *a.* (suspens'.) Held from proceeding; held in doubt or expectation. [Little used.]

SUSPENSIBIL'ITY, *n.* The capacity of being suspended or sustained from sinking; as, the *susceptibility* of indurated clay in water.

SUSPENS'IBLE, *a.* Capable of being suspended or held from sinking.

SUSPENS'ION, *n.* [Fr. from L. *suspensio*. See SUSPEND.] 1. The act of hanging up, or of causing to hang by being attached to something above.—

2. The act of making to depend on any thing for existence or taking place; as, the *suspension* of payment on the performance of a condition.—3. The act of delaying; delay; as, the *suspension* of a criminal's execution; called a respite or reprieve.—4. Act of withholding or balancing the judgment; forbearance of determination; as, the *suspension* of opinion, of judgment, of decision, or determination. *Suspension* of judgment often proceeds from doubt or ignorance of facts.—5. Temporary cessation; interruption; intermission; as, the *suspension* of labour or of study; the *suspension* of pain.—6. Temporary privation of powers, authority, or rights; usually intended as a censure or punishment; as, the *suspension* of an ecclesiastic or minister for some fault. This may be merely a *suspension* of his office, or it may be both of his office and his income.

A military or naval officer's *suspension* takes place when he is arrested.—7. Prevention or interruption of operation; as, the *suspension* of the habeas corpus act.—8. In *rhet.*, a keeping of the hearer in doubt and in attentive expectation of what is to follow, or what is to be the inference or conclusion from the arguments or observations.—9. In *law*,

the temporary stop of a man's right, as when a seignory, rent, or other profit out of land, by reason of the unity of possession of the seignory, rent, &c., and of the land out of which they issue, lies dormant for a time.—10. In *Scots law*, the name of a process in the supreme civil or criminal court, by which execution or diligence on a sentence or decree is stayed until the judgment of the supreme court is obtained on the point. In civil causes, the party complaining presents a bill of suspension to the lord ordinary on the bills, setting forth that diligence has been used or threatened in virtue of the decree or warrant to which he objects, and after stating the circumstances of the case, and his cause of complaint, his bill concludes that the diligence or execution in question ought to be suspended, and therefore he prays for letters of suspension in the premises, and offers caution to implement the decree of which he complains, and to pay the expenses of the process, if the court shall so decide. If the lord ordinary thinks that the complainant has made out a sufficient *prima facie* case, he pronounces an interlocutor, sisting execution in the meanwhile, and appointing the bill of suspension to be answered. Afterwards, the lord ordinary resumes consideration of the bill along with the answers (if lodged), and if he still thinks that there is ground for the objection to the diligence or execution, he passes the bill of suspension, or grants warrant for expediting letters of suspension at the signet, whereby the cause is brought formally into the court of session. If, on the other hand, the lord ordinary be of opinion, either on considering the bill itself, or on resuming consideration of it with answers, that there is no just ground of complaint, he refuses the bill, and the diligence or execution is in consequence allowed to proceed. His decision, however, is subject to the review of the court. [See BILL.]—11. In *mech.*, points of suspension, in a balance, are the points in the axis or beam where the weights are applied, or from which they are suspended.—12. In *music*, every sound of a chord to a given base, which is continued to another base, is a *suspension*.—*Suspension of arms*, in war, a short truce or cessation of operations agreed on by the commanders of the contending parties, as for burying the dead, making proposals for surrender, or for peace, &c.—*Suspension and interdict*, in *Scots law*, a judicial remedy competent in the bill chamber of the court of session, where there has been no decree, nor any proceeding which can issue in a decree, but where the object is to stop or interdict some act or to prevent some encroachment on property or possession, or in general to stay any unlawful proceeding. The remedy is applied for by a bill of suspension and interdict. [See INTERDICT.]—*Suspension and liberation*, in *Scots law*, where a debtor has been incarcerated in consequence of diligence on a decree, or on any other warrant of incarceration, he may apply in the bill chamber for redress by a bill of suspension and liberation, and if he can satisfy the lord ordinary on the bills that his imprisonment has been wrongful or illegal, the bill of suspension and liberation, after it has been answered, will be passed. The procedure in this

case is analogous to that in ordinary suspensions.

SUSPENS'ION-BRIDGE, *n.* A structure which is hung and stretched across some chasm, water-course, or other space, over which it is designed to form a passage. In modern structures of this sort, the leading features for the most part consist in fixing securely, in the two opposite banks, the extremities of strong chains, which, being carried over piers or pillars, reach across the space to be passed in such a manner that each portion of chain intercepted between two piers is allowed naturally to assume, by its weight, the figure of the curve named the *catenarian*. From these chains, a platform for the roadway is suspended by means of a series of equidistant vertical rods. The largest suspension bridge is that over the Menai Strait, the distance between the points of suspension being 560 feet.

SUSPENS'IVE, *a.* Doubtful.—*Suspensive conditions*, in *Scots law*, conditions precedent, or conditions without the purification of which the contract cannot be completed.

SUSPENS'OR, } *n.* In *sur.*, a bag-  
SUSPENS'ORY, } hernia. It is applied in cases of truss.—2. In *bot.*, a name given to the ends by which the embryo of some plants is suspended from the foramen or opening of the seed.

SUSPENS'ORY, *a.* That suspends; suspending; as, a *suspensory* muscle.

SUSPENS'ORY, *n.* That which suspends or holds up; a truss.

SUSPICABLE, } *a.* [L. *suspicio*.] That  
SUSPICABLE, } may be suspected; liable to suspicion.

SUSPICI'ON, *n.* [Fr. from L. *suspicio*. See SUSPECT.] The act of suspecting; the sentiment or passion which is excited by signs of evil without sufficient proof; the imagination of the existence of something without proof, or upon very slight evidence, or upon no evidence at all. *Suspicion* often proceeds from the apprehension of evil; it is the offspring or companion of jealousy.

*Suspitions* among thoughts, are like bats among birds; they ever fly by twilight.  
Bacon.

SUSPICI'OUS, *a.* [L. *suspiciosus*.] 1. Inclined to suspect; apt to imagine without proof.

Nature itself, after it has done an injury will ever be *suspicious*, and no man can love the person he suspects.  
South.

2. Indicating suspicion or fear.

We have a *suspicious*, fearful, constrained countenance.  
Swift.

3. Liable to suspicion; adapted to raise suspicion; giving reason to imagine ill; as, an author of *suspicious* innovations. I spy a black *suspicious* threatening cloud.  
Shak.

4. Entertaining suspicion; given to suspicion.

Many mischievous insects are daily at work to make men of merit *suspicious* of each other.  
Pope.

SUSPICI'OUSLY, *adv.* With suspicion.

—2. So as to excite suspicion.

SUSPICI'OUSNESS, *n.* The quality of being liable to suspicion, or liable to be suspected; as, the *suspiciousness* of a man's appearance, of his weapons, or of his actions.—2. The quality or state of being apt to suspect; as, the *suspiciousness* of a man's temper or mind.

SUSPIRA'L, *n.* [L. *suspīro*, to breathe; *sub* and *spīro*.] 1. A breathing-hole; a vent or ventiduct.—2. A spring of

water passing under ground toward a cistern or conduit. [*Local.*]

**SUSPIRATION**, *n.* [L. *spiratio*, *spirare*, to sigh; *sub* and *spiro*, to breathe.] The act of sighing or fetching a long and deep breath; a sigh.

**SUSPIRE**, *v. i.* [supra.] To sigh; to fetch a long deep breath; to breathe. [*Little used.*]

**SUSPIRED**, *pp.* or *a.* Wished for; desired.

**SUSSEX MARBLE**, *n.* In *geol.*, a fresh water deposit which constitutes a member of the Wealden group. It occurs in layers varying from a few inches to upwards of a foot in thickness, the layers being separated by seams of clay or loose friable limestone. It occurs in great abundance in the Weald of Sussex; hence the name. It is of various shades of grey and bluish grey, mottled with green and yellow; it bears a high polish, and is extensively used for architectural and ornamental purposes.

**SUSTAIN**, *v. t.* [L. *sustineo*; *sub* and *teneo*, to hold under; Fr. *soutenir*.] 1. To bear; to uphold; to support; as, a foundation *sustains* the superstructure; pillars *sustain* an edifice; a beast *sustains* a load.—2. To hold; to keep from falling; as, a rope *sustains* a weight.—3. To support; to keep from sinking in dependence. The hope of a better life *sustains* the afflicted amidst all their sorrows.—4. To maintain; to keep alive; to support; to subsist; as, provisions to *sustain* a family or an army.—5. To support in any condition by aid; to assist or relieve.

His sons who seek the tyrant to *sustain*.  
*Dryden.*  
6. To bear; to endure without failing or yielding. The mind stands collected and *sustains* the shock.  
Shall Turnus then such endless toil *sustain*?  
*Dryden.*

7. To suffer; to bear; to undergo.  
You shall *sustain* more new disgraces.  
*Shak.*

8. To maintain; to support; not to dismiss or abate. Notwithstanding the plea in bar or in abatement, the court *sustained* the action or suit.—9. To maintain as a sufficient ground. The testimony or the evidence is not sufficient to *sustain* the action, the accusation, the charges, or the impeachment.—10. In *music*, to continue, as the sound of notes through their whole length.

**SUSTAIN**, *fr. n.* That which upholds.

**SUSTAINABLE**, *a.* That may be sustained or maintained. The action is not *sustainable*.

**SUSTAINED**, *pp.* Borne; upheld; maintained; supported; subsisted; suffered.

**SUSTAINER**, *n.* He or that which sustains, upholds, or suffers.

**SUSTAINING**, *ppr.* Bearing; upholding; maintaining; suffering; subsisting.

**SUSTAINMENT**, *n.* The act of sustaining; support.

**SUSTANTIC**, *a.* [Gr. *συστατικός*.] Mourningful; affecting; an epithet given to a species of music by the Greeks.

**SUSTENANCE**, *n.* [Norm. Fr.; from *sustain*.] 1. Support; maintenance; subsistence; as, the *sustenance* of the body; the *sustenance* of life.—2. That which supports life; food; victuals; provisions. This city has ample *sustenance*.

**SUSTENTACLE**, *fr. n.* [L. *sustentaculum*.] Support.

**SUSTENTATION**, *n.* [Fr. from L. *sustentatio*, *sustento*.] 1. Support; preservation from falling.—2. Use of food.—3. Maintenance; support of life.

**SUSTENTATION**, *a.* Having a sustaining power; calculated to sustain or support; as, the *sustentation fund* of the Free Church of Scotland.

**SUSURRATION**, *fr. n.* [L. *susurratio*; *susurro*, to whisper.] A whispering; a soft murmur.

**SUTILE**, *a.* [L. *sutillis*, from *suo*, to sew.] Done by stitching.

**SUTLER**, *n.* [D. *zoetelaar*, as if from *zoet*, sweet. But in German, *sudelhock* is a paltry victualler, as if from *sudeln*, to soil; *sudler*, a dirty fellow. In Danish, *sudelhock* is a pastry-cook, from the same root; *sudler*, to soil. The Danish may be the original signification.] A person who follows an army and sells to the troops provisions and liquors.

**SUTLING**, *a.* Belonging to sutlers; engaged in the occupation of a sutler.

**SUTTEE**, *n.* [*sati*, from the Sanscrit *sat*, good; pure; properly a chaste and virtuous wife.] 1. A widow who immolates herself on the funeral pile of her husband.—2. The voluntary self-immolation of Hindoo widows on the funeral pile of their husbands. The origin of this horrid custom is uncertain. It is not absolutely commanded in the sacred books of the Hindoos, but they speak of it as highly meritorious, and the means of obtaining eternal beatitude. It is believed also to render the husband and his ancestors happy, and to purify him from all offences. Since the year 1756, upwards of 70,000 Hindoo widows have been thus sacrificed. The suttee was abolished throughout the British dominions in India, in 1829, by Lord W. Bentinck, governor-general of India.

**SUTTEEISM**, *n.* Suttee,—*which see*.

**SUTTLE**, *a.* *Suttle weight*, in *com.*, is when tret is allowed; neat weight.

**SUTURAL**, *a.* [L. *sutura*, a seam.] Relating to a suture or seam. In *bot.*, the dehiscence of a pericarp is *sutural*, when it takes place at a suture.

**SUTURATED**, *a.* Stitched; sewed or knit together.

**SUTURE**, *n.* [L. *sutura*, from *suo*, to sew.] 1. Literally, a sewing; hence a mode of uniting the edges of a wound by keeping them in contact with stitches; also the threads with which the operation is effected. There are several kinds of sutures in use, as the *interrupted*, the *uninterrupted*, and the *twisted*.—2. The seam or joint which unites the bones of the skull; or the peculiar articulation or connection of those bones; as, the coronal *suture*; the sagittal *suture*.—3. In *bot.*, the seam of a dehiscen pericarp, where the valves unite.—4. In *entom.*, the line at which the elytra meet, and are sometimes confluent.

**SUTURED**, *a.* Having sutures; united.

**SUUM CUIQUE**, } [L. *suum cuique*  
**SUUM CUIQUE**, } *tributo.*] Give every one his due.

**SUWARROW NUT**, *n.* The fruit of a tree of the genus *Caryocar*, the *C. butyrosam*, nat. order *Rhizobolacæ*. The kernel of the suwarrow nuts is

one of the most delicious fruits of the nut kind that is known. An oil is extracted from them not inferior to that of the olive. The tree which produces these nuts is a native of Guiana, and is also known by the name of butter-nut tree, and the fruit by that of butter-nuts.

**SUZERAIN**, *n.* [Fr.] A feudal lord or baron.

**SUZERAINTY**, *n.* [Fr. *suzeraineté*, from *suzerain*, a lord paramount.] Paramount authority or command.

**SWAB**, *n.* [Sax. *swebban*, to sweep; formed perhaps on the root of *wipe*, as G. *schweben*, to wave or soar, is on that of *wave*, and D. *zweepen*, on that of *whip*.] 1. A mop for cleaning floors, on board of ships; a large mop or bunch of old rope yarn, used to clean the deck and cabin.—*Hand-swab*, a smaller kind of swab, used for wiping dry the stern-sheets of a boat; washing of plates, and dishes, &c.—2. A bit of sponge fastened to a handle for cleansing the mouth of the sick, or for giving them nourishment.—3. In *metal founding*, a small tapering tuft of hemp, charged with water, for touching up the edges of moulds.

**SWAB**, *v. t.* [supra.] To clean with a mop; to wipe when wet or after washing; as, to *swab* the deck of a ship.

**SWABBED**, *pp.* Cleaned with a mop.

**SWABBER**, *n.* [D. *zweerber*.] One that uses a swab to clean a floor or deck; on board of ships of war, an inferior officer, whose business is to see that the ship is kept clean.

**SWABBING**, *ppr.* Cleaning with a mop.

**SWAD**, *n.* A pod, as of beans or peas. [*Local.*] 2. † A short fat person.

**SWAD'DLE**, *v. t.* [Sax. *swathe*, *swethel*, a border, fringe, or band; *beswethan*, to swathe; G. *schwaden*, a *swath*.] 1. To swathe; to bind, as with a bandage; to bind tight with clothes; used generally of infants; as, to *swaddle* a child. They *swaddled* me in my night-gown.

2. † To beat; to cudgel.

**SWAD'DLE**, *n.* Clothes bound tight round the body.

They put me in bed in all my *swaddles*.

**SWAD'DLED**, *pp.* Swathed; bound in tight clothes.

**SWAD'DLING**, *ppr.* Swathing; binding in tight clothes.

**SWAD'DLING-BAND**, } *n.* A band  
**SWAD'DLING-CLOTH**, } or cloth

wrapped round an infant; Luke ii.

**SWAG**, *v. i.* [Qu. Sax. *sigan*, to fall; Ice. *sveigia*; Dan. *svehkar*, to weaken. See **WEAK**.] To sink down by its weight; to lean.—2. To move as something heavy and pendant.

**SWAG-BELLIED**, *a.* Having a prominent overhanging belly.

**SWAGE**, *v. t.* [probably allied to *swag* **SUAQE**, } and *weak*; from falling or  
throwing down.] To ease; to soften; to mitigate.

Apt words have power to *swage*  
The tumours of a troubled mind. *Milton.*

[See **ASSUAGE**, which is the word now used.]

**SWAGE**, } *n.* In *smith-work*, an im-  
**SWADGE**, } plement used by blacksmiths for smoothing and finishing any article reduced by previous hammering nearly to the required form. Swadges are round, square, &c., and are simply a species of moulds, on the lower of which, called the bottom swadage, the work is placed in a heated state, while



v s, Ventral Suture.  
d s, Dorsal Suture.

the top swadge is, by repeated blows of the sledge-hammer, beat down upon it until it assumes the proper shape.

**SWAGE**, *v. t.* To use a swage; to fashion a piece of iron by hammering it in a groove or mould, having the required shape.

**SWAG'GER**, *v. i.* [Sax. *swegan*, to sound or rattle.] To bluster; to bully; to boast or brag noisily; to be tumultuously proud.

What a pleasure it is to *swagger* at the bar.

*Arbutnot.*  
To be great is not to *swagger* at our footmen.  
*Collier.*

**SWAG'GERER**, *n.* A blusterer; a bully; a boastful noisy fellow.

**SWAG'GERING**, *ppr.* Blustering; boasting noisily.

**SWAG'GING**, *ppr.* Sinking or inclining.  
**SWAG'GY**, *a.* [from *swag*.] Sinking, hanging, or leaning by its weight.

**SWAIN**, *n.* [Sax. *swain*, *swam*, a boy, a youth, a servant, a herdsman; Sw. *swen*, a boy.] 1. A young man.—2. A country servant employed in husbandry; a rustic.—3. A pastoral youth; a lover. *Blest swains!* whose nymphs in every grace excel.  
*Pope.*

[It is used chiefly in this sense, and in poetry.]

**SWAINISH**, *a.* Rustic.

**SWAINMOTE**, } *n.* [swain and mote,  
**SWEINMOTE**, } meeting.] In Eng-  
**SWANMOTE**, } land, a court held before the verderors of the forest as judges, by the steward of the court, thrice every year; the swains or freeholders within the forest composing the jury. Its principal jurisdiction is to inquire into the oppressions and grievances committed by the officers of the forest. It receives and tries also presentments certified from the court of attachments against offences in vert and venison. This court is incident to a forest, as a court of piepoudre is to a fair.

**SWALE**, *n.* [probably from *vale*.] In *England*, a shade.

**SWALE**, *v. i.* To waste; to consume.  
[See **SWEAL**.]

**SWALE**, *v. t.* To dress a hog for bacon, by singeing or burning off his hair.  
[Local.]

**SWALLET**, *n.* [See **WELL**.] Among the tin-miners, water breaking in upon the miners at their work.

**SWALLOW**, *n.* [Sax. *swalewe*; D. *zwalwe*; G. *schwalbe*; Dan. *svale*; Sw. *svala*.] A genus of passerine birds (*Hirundo*, Linn.) several species of which are well known in this country.

climates the swallows are migratory birds, marking the beginning of the summer by their coming, and giving notice that it is over by their departure to warmer regions. They pass more of their time upon the wing than any other birds which inhabit or visit the British islands. The most common species are, the chimney-swallow (*Hirundo rustica*, Linn.); the sand-martin (*H. riparia*, Linn.); and the house-martin (*H. urbica*, Linn.) Several



House Martin (*Hirundo urbica*).

species belong to America. The Swift, *Cypselus murarius*, belongs to a different family.

**SWALLOW-FISH**, *n.* A sea fish of the genus *Trigla*, the *T. hirundo*, called in Cornwall *tub-fish*; remarkable for the size of its gill fins. It is called also the *sapphirine gurnard*.

**SWALLOW-FLY**, *n.* The name of the *Chelidonium*, a fly remarkable for its swift and long flight.

**SWALLOW-STONE**, *n.* *Chelidonium lapis*, a stone which Pliny and other authors affirm to be found in the stomachs of young swallows.

**SWALLOW-TAIL**, *n.* A plant, a species of willow.—2. In *joinery* and *carpentry*, the same as *dove-tail*.—3. In *fort.*, an outwork composed of two redans, and called also *queue d'hyrondie*.  
[See **REDAN**.]

**SWALLOW-TAILED**, *a.* Dove-tailed, —which see.

**SWALLOW-WORT**, *n.* The English name of various species of plants of the genus *Asclepias*, belonging to the nat. order *Asclepiadaceæ*. The *African swallow-wort* is of the genus *Stapelia*.

**SWALLOW**, *v. t.* [Sax. *swelgan*, *swilgan*, to swallow, to swill; Sw. *svälja*, to swallow; *swalg*, the throat; Qu. the Fr. *avaler*, with a prefix, and the root of *fall*.] 1. To take into the stomach; to receive through the gullet or oesophagus into the stomach; as, to *swallow* food or drink. Food should be well chewed before it is *swallowed*.—2. To absorb; to draw and sink into an abyss or gulf; to engulf; usually followed by *up*. The Mæstrom off the coast of Norway, it is said, will *swallow up* a ship.

In bogs *swallow'd up* and lost. *Milton*.  
The earth opened and *swallowed* them up; Numb. xvi.

3. To receive or embrace, as opinions or belief, without examination or scruple; to receive implicitly.—4. To engross; to appropriate.

Homer...has *swallowed up* the honour of those who succeeded him. *Pope*.

5. To occupy; to employ.

The necessary provision of life *swallows* the greatest part of their time. *Locke*.

6. To seize and waste.

Corruption *swallow'd* what the liberal hand Of bounty scatter'd. *Thomson*.

7. To engross; to engage completely. The priest and the prophet have erred through strong drink; they are *swallowed up* of wine; Is. xxviii.

8. To exhaust; to consume. His expenses *swallow up* all his income.

**SWALLOW**, *n.* The gullet or oesophagus; the throat.—2. Voracity.—3. As much as is swallowed at once.

**SWALLOWED**, *pp.* Taken into the stomach; absorbed; received without scruple; engrossed; wasted; exhausted.

**SWALLOWED**, *n.* One who swallows; also, a glutton.

**SWALLOWING**, *ppr.* Taking into the stomach; absorbing; engulfing; receiving implicitly; engrossing; wasting; exhausting.

**SWALLOWING**, *n.* The act of taking into the stomach or of absorbing; the act of receiving implicitly; the act of engrossing.

**SWAM**, *pret. of Swim*.

**SWAMP**, *n.* [Sax. *swam*, a fungus or mushroom; Goth. *swamms*, a sponge, G. *schwamm*, D. *zwam*, Dan. *swamp*; Sw. *id.* a sponge, a fungus.] Spongy land; low ground filled with water; soft wet ground which does not admit of being trod on by cattle, but which nevertheless may produce various kinds of herbage, bushes, and plants. A distinction is sometimes made between a swamp, a bog, and a marsh, which consists in the former producing trees and shrubs, whereas the latter produce only herbage, plants, and mosses.

In *common language*, however, the terms are used almost synonymously.

**SWAMP**, *v. t.* To plunge, overset, or sink and be lost in water.—2. To plunge into inextricable difficulties.

**SWAMP'ED**, *pp.* Overwhelmed; plunged into difficulties.

**SWAMP'ING**, *ppr.* Overwhelming; plunging into inextricable difficulties.

**SWAMP'-ORE**, *n.* In *mineral.*, an ore of iron found in swamps and morasses; called also bog-ore, or indurated bog iron ore. Its colour is a dark yellowish brown or grey; its fracture is earthy, and it contains so much phosphoric acid as to injure its tenacity.

**SWAMP'Y**, *a.* Consisting of swamp; like a swamp; low, wet, and spungy; as, *swampy* land.

**SWAN**, *n.* [Sax. *swan*; D. *zwaan*; G. *schwan*; Dan. *svane*; Sw. *svan*. Qu. *vau*, white, with a prefix.] A genus of web-footed swimming birds (*cygnus*) of the family *Anatidæ*, and order *Anseres*, Linn. They are found upon rivers



Wild Swan or Hooper (*Cygnus ferus*).

and small pools of fresh water, rather than the sea or the larger lakes. They are among the most ornamental of all the water birds, on account of their great size, the gracefulness of their



Chimney Swallow (*Hirundo rustica*).

They are remarkable for their dense plumage, extreme length of wing, velocity of flight, but having the feet comparatively weak. In temperate

forms and motions, and the snowy whiteness of the plumage of those species with which we are most familiar. The species which inhabit or visit Britain are the tame swan, *Cygnus olor*, the wild swan or hooper, *C. ferus*, and the Bewick swan, *C. bewickii*. The black swan, *C. atratus*, is an



Black Swan (*Cygnus atratus*).

Australian species, about the size of the tame swan. Like the white swan, it is frequently kept as an ornament in parks in this country. In England, the swan is said to be a bird-royal, in which no subject can have property, when at large in a public river or creek, except by grant from the crown. In creating this privilege, the crown grants a swan-mark for a game of swans. The swan-marks are made upon the upper mandible, with a knife or other sharp instrument. Several species of swans are found in other parts of the world.

**SWANG**, *n.* A piece of low land or green sward, liable to be covered with water. [*Local*.]

**SWANK**, *a.* [Dan. *svang*, lean, meagre, thin; G. *schwank*, agile, easily moved.] Thin; slender; pliant; agile. [*Scotch*.]

**SWANK'IE**, *n.* An active or clever young fellow. [*Scotch*.]

**SWAN'-LIKE**, *a.* Resembling a swan.

**SWAN-NECK**, *n.* The end of a pipe curved or arched like the neck of a swan.

**SWAN'NERY**, *n.* A place where swans are bred and reared.

**SWANS'-DOWN**, } *n.* 1. The down of  
**SWAN-DOWN**, } the swan.—2. A fine soft thick woollen cloth.

**SWAN'SKIN**, *n.* [*swan* and *skin*.] A species of flannel of a soft texture, thick and warm.—2. A very thick kind of cloth, used for the clothes of seamen and laborers.

**SWAP**, *adv.* [Qu. *swEEP*.] Hastily; as at a snatch; with hasty violence. [*A low word and local*.]

**SWAP**, *† v. t.* 1. To strike with a sweeping stroke.—2. To cast down with violence.

**SWAP**, *† v. i.* To fall completely down.—2. To ply the wings with a sweeping noise, as a bird.—3. To swap.

**SWAP**, *† n.* A blow; a stroke.

**SWAPE**, *n.* A machine for raising water, consisting of a bucket hung to the end of a counter-poised lever. It is extensively used in the East. In Egypt it is called a *shadoof*.

**SWARD**, *n.* [Sax. *sweard*; Dan. *sver*; D. *zwoerd*; G. *schwarte*, rind, skin; W. *gweryd*, an excretion, sward, moss.] 1. The skin of bacon. [*Local*.]—2. The grassy surface of land; turf; that part of the soil which is filled with the roots of grass, forming a kind of mat. When covered with green grass, it is called *green-sward*.

**SWARD**, *v. t.* To produce sward; to cover with sward.

**SWARD'-CUTTER**, *n.* An instrument for cutting sward across the ridges.

**SWARD'ED**, *a.* Covered with sward.

**SWARD'Y**, *a.* Covered with sward or grass; as, *swardy* land.

**SWARE**, *old pret. of Swear.* [We now use *swore*.]

**SWARE**, } *n.* A copper coin and  
**SCHWARE**, } money of account in Bremen, value nearly one farthing.

**SWARF**, *v. i.* [Etymol. uncertain.] To faint, to swoon. As a *noun*, stupor, a fainting fit, a swoon. [*Scotch*.]

**SWARM**, *n.* [Sax. *swearm*; G. *schwarm*.] This seems to be formed on the root of *warm*. The Sp. *heruir*, to boil, to swarm, is the L. *ferveo*, and boiling is very expressive of the motions of a swarm of bees. See the Verb.] 1. In a general sense, a large number or body of small animals or insects, particularly when in motion; but *appropriately*, a great number of honey bees which emigrate from a hive at once, and seek new lodgings under the direction of a queen; or a like body of bees united and settled permanently in a hive. The bees that leave a hive in spring, are the young bees produced in the year preceding; Exod. viii; Judges xiv.—2. A swarm or multitude; particularly, a multitude of people in motion. *Swarms* of northern nations overran the South of Europe in the fifth century.

*Note*.—The application of this word to inanimate things, as swarms of *advantages*, by Shakspeare, and swarms of *themes*, by Young, is not legitimate, for the essence of the word is motion.

**SWARM**, *v. i.* [Sax. *swearmian*; G. *schwärmen*; Sw. *svärma*, to swarm, to rove, to wander, to swerve.] 1. To collect and depart from a hive by flight in a body, as bees. Bees *swarm* in warm, clear days in summer.—2. To appear or collect in a crowd; to run; to throng together; to congregate in a multitude.

In crowds among the *swarming* people join. *Dryden*.

3. To be crowded; to be thronged with a multitude of animals in motion. The northern seas in spring *swarm* with herrings.

Every place *swarms* with soldiers. *Spenser*. [Such phrases as "life swarms with ills," "those days swarmed with fables," are not legitimate or wholly obsolete.]

—4. To breed multitudes.—5. In the *United States*, to climb, as a tree, by embracing it with the arms and legs, and scrambling.

At the top was placed a piece of money, as a prize for those who could *swarm* up and seize it. *Coxe's Russ*.

**SWARM**, *† v. t.* To crowd or throng.

**SWARM'ED**, *pp. of Swarm*.

**SWARM'ING**, *ppr. of Swarm*. [See the Verb.]

**SWART**, } *a.* [Sax. *swart*, *swear*;  
**SWARTH**, } Sw. *swart*; Dan. *svært*;  
G. *schwarz*; D. *zwart*.] 1. Being of a dark hue; moderately black; tawny.

A nation strange with visage *swart*. *Spenser*.

2. *†* Gloomy; malignant.

**SWART**, *v. t.* To make tawny.

**SWARTH**, } *n.* An apparition.  
**SWARTH**, } *n.* The sward.—2. The swath; the bands or ridges of grass, hay, &c., produced by mowing with the scythe.

**SWARTH'LY**, *adv.* [from *swarthy*.] Duskiy; with a tawny hue.

**SWARTH'INESS**, *n.* Tawinness; a dusky or dark complexion.

**SWARTH'Y**, *a.* [See *SWART*.] Being of a dark hue or dusky complexion; tawny. In warm climates, the complexion of men is universally *swarthy* or black. The Moors, Spaniards, and Italians are more *swarthy* than the French, Germans, and English.

Their *swarthy* hosts would darken all our plains. *Addison*.

2. Black; as, the *swarthy* African.

**SWART'INESS**, *n.* A tawny colour.

**SWART'ISH**, *a.* Somewhat dark or tawny.

**SWART'NESS**, *n.* Swarthinness.

**SWART'Y**, *a.* Swarthy; tawny.

**SWART'ZIA**, *n.* A genus of leguminous plants, the species of which are natives of South America and the West India Islands. The *S. tomentosa* is a high thick tree growing in Guiana. It has a fine reddish coloured wood, which becomes black by age, and is considered very indestructible, and is used for the making of rudders for ships. The bark is very bitter, and is used as a medicine in Guiana.

**SWARVE**, *† v. i.* To swerve.

**SWASH**, *n.* An oval figure, whose mouldings are oblique to the axis of the work. [*A cant word*.]

**SWASH**, *n.* A blustering noise; a vapouring. [*Not in use or vulgar*.]—2. Impulse of water flowing with violence. *Swash* or *swashway* is a name given to a narrow sound or channel of water lying within a sand bank, or between that and the shore.

**SWASH**, *† v. i.* [D. *zwoetsen*, to boast.] To bluster; to make a great noise; to vapour or brag.

**SWASH'-BUCKLER**, *† n.* A sword-player; a bully or braggadocio.

**SWASH'ER**, *† n.* One who makes a blustering show of valour or force of arms.

**SWAT**, } *† v. i.* To sweat.  
**SWATE**, } *† v. i.* To sweat.

**SWATCH**, *† n.* A swath.

**SWATCH**, *n.* A pattern, generally of cloth; a specimen of any kind. [*Scotch*.]

**SWATH**, *n.* [Sax. *swathe*, a track, a border, or fringe, a band; D. *zwaad*; G. *schwaden*.] 1. A line; or ridge of grass or corn cut and thrown together by the scythe in mowing.—2. The whole breadth or sweep of a scythe in mowing; as, a wide *swath*.—3. A band or fillet. They wrapped me in a hundred yards of *swath*. More usually written *swathe*.

**SWATH-BALK**, *n.* In agriculture, the line between two swaths, where the stubble is cut least closely, presenting a little ridge of stubble.

**SWATHE**, *v. t.* To bind with a band, bandage, or rollers; as, to *swathe* a child.—2. To bind or wrap.

Their children are never *swathed* or bound about with any thing when first born. *Abbot*.

**SWATHE**, *n.* A bandage; a band or fillet.

**SWATHED**, *pp.* Bound with a bandage or rollers.

**SWATH'ING**, *ppr.* Binding or wrapping.

**SWATHS**, *n. plur.* New ale or beer. [*Scotch*.]

**SWAY**, *v. t.* [D. *zwaaijen*, to turn, to wield, to swing, to sway. This word is probably formed on the root of *weigh*, *wave*, Sax. *wæg*, *weg*, and *swag*, and probably *swing* is written for

*swig*, and is of the same family.] 1. To move or wave; to wield with the hand; as, to *sway* the sceptre.—2. To bias; to cause to lean or incline to one side. Let not temporal advantages *sway* you from the line of duty. The king was *swayed* by his council from the course he intended to pursue.

As bows run true by being made  
On purpose false, and to be *sway'd*.

*Hudibras.*

3. To rule; to govern; to influence or direct by power and authority, or by moral force.

This was the race

To *sway* the world, and land and sea subdued.

*Dryden.*

She could not *sway* her house.

*Shak.*

Take heed lest passion *sway*

Thy judgment to do aught which else free will

Would not admit.

*Milton.*

SWAY, *v. i.* To be drawn to one side by weight; to lean. A wall *sways* to the west.

The balance *sways* on our part.

*Bacon.*

[This sense seems to indicate that this word and *swag* are radically one.]—2. To have weight or influence.

The example of sundry churches... doth *sway* much.

*Hooker.*

3. To bear rule; to govern.  
Hadst thou *sway'd* as kings should do.

*Shak.*

4. In seamen's language, to hoist; particularly applied to the lower yards and to the topmast yards, &c.

SWAY, *n.* The swing or sweep of a weapon.

To strike with huge two-handed *sway*.

*Milton.*

2. Any thing moving with bulk and power.

Are not you moved when all the *sway* of earth

Shakes like a thing unfirm?

*Shak.*

3. Preponderation; turn or cast of the balance.

Expert

When to advance, or stand, or turn the *sway* of battle.

*Milton.*

4. Power exerted in governing; rule; dominion; control.

When vice prevails and impious men bear *sway*,

The post of honour is a private station.

*Addison.*

5. Influence; weight or authority that inclines to one side; as, the *sway* of desires. All the world is subject to the *sway* of fashion.—6. A switch used by thatchers to bind their work.

SWAYED, *pp.* Wielded; inclined to one side; ruled; governed; influenced; biased.

SWAYING, *ppr.* Wielding; causing to lean; biasing; ruling.

SWÄYING, *n.* *Swäying of the back*, among beasts, is a kind of lumbago, caused by a fall or by being overloaded.

SWEAL, *v. i.* [Sax. *swelan*; sometimes written *swale*.] 1. To melt and run down, as the tallow of a candle; to waste away without feeding the flame.—2. To blaze away.

SWEAL, *v. t.* To singe or burn the hair, as of hogs.

SWEALING, *ppr.* Melting and wasting away.

SWEÄR, *v. i.* pret. *Swore*, [formerly *swæran*;] *pp.* *Sworn*. [Sax. *swerian*, *swærgan*; G. *schwören*; Sw. *sväria*, to swear, and *svara*, to answer; Dan. *sværge*, to swear, and *svarer*, to answer. The latter seems to be from *svarrer*, to turn, Eng. *veer*. *Swear* seems to be

allied to *aver* and the L. *assevero*.] 1. To affirm or utter a solemn declaration, with an appeal to God for the truth of what is affirmed.

Ye shall not *swear* by my name falsely; Lev. xix.

But I say to you, *Swear* not at all; Matth. v.

2. To promise upon oath.

Jacob said, *Swear* to me this day; and he *swore* to him; Gen. xxv.

3. To give evidence on oath; as, to *swear* to the truth of a statement. He *swore* that the prisoner was not present at the riot.—4. To be profane; to practise profaneness; to use the name or names of God irreverently in common conversation; to utter profane oaths. Certain classes of men are accustomed to *swear*. For men to *swear* is sinful, disreputable, and odious; but for females or ladies to *swear*, appears more abominable and scandalous.

SWEAR, *v. t.* To utter or affirm with a solemn appeal to God for the truth of the declaration; as, to *swear* on oath.

[This seems to have been the primitive use of *swear*; that is, to affirm.]—2. To put to an oath; to cause to take an oath; as, to *swear* witnesses in court; to *swear* a jury; the witness has been *sworn*; the judges are *sworn* into office.—3. To declare or charge upon oath; as, to *swear* treason against a man.—4. To obstruct by an oath.

Now by Apollo, king, thou *swear'st* thy gods in vain.

*Shak.*

To *swear the peace* against one, to make oath that one is under the actual fear of death or bodily harm from the person; in which case the person must find sureties of the peace. [See SURETY.]

SWEÄRER, *n.* One who swears; one who calls God to witness for the truth of his declaration.—2. A profane person; one who habitually utters profane oaths.

Then the liars and *swearers* are fools.

*Shak.*

SWEÄRING, *ppr.* or *n.* Affirming upon oath; uttering a declaration, with an appeal to God for the truth of it.—2. Putting upon oath; causing to swear.—3. Using profane oaths.

SWEÄRING, *n.* The act or practice of affirming on oath. *Swearing* in court is lawful.—2. Profaneness, the using of profane oaths; a profane use of the name of the Deity. Profane cursing and swearing is an offence punishable by law. All *swearing* not required by some law, or in conformity with law, is criminal. False *swearing* or perjury is a crime of a deep dye.

SWEAT, *n.* (swet.) [Sax. *swat*; G. *schweiss*; L. *sudor*.] 1. The fluid or sensible moisture which is excreted from the skin of an animal. [See PERSPIRATION.]

In the *sweat* of thy face shalt thou eat bread; Gen. iii.

2. Labour; toil; drudgery.—3. Moisture evacuated from any substance; as, the *sweat* of hay or grain in a mow or stack.

SWEAT, *v. i.* (swet.) pret. and *pp.* *Sweat* or *Sweated*. *Swot* is obsolete. [Sax. *swetan*; G. *schwitzen*; L. *sudo*; Fr. *suer*.] 1. To excrete sensible moisture from the skin. Horses *sweat*; oxen *sweat* little or not at all.—2. To toil; to labour; to drudge.

He'd have the poets *sweat*.

*Waller.*

3. To emit moisture, as green plants in a heap.

SWEAT, *v. t.* (swet.) To emit or suffer to flow from the pores; to exude.

For him the rich Arabia *sweats* her gums.

*Dryden.*

2. To cause to excrete moisture from the skin. His physicians attempted to *sweat* him by the most powerful sudorifics.—3. In *cant language*, to shake (gold coin), and appropriate the particles thus lost by attrition.

SWEATER, *n.* One that causes to sweat.

SWEATILY, *adv.* (swetily.) So as to be moist with sweat.

SWEATINESS, *n.* The state of being sweaty or moist with sweat.

SWEATING, *ppr.* or *n.* Excreting moisture from the skin; throwing out moisture; exuding.—2. Causing to emit moisture from the skin.—*Sweating of hay*, a slight fermentation produced in hay by putting it into small cocks, in a rather green or damp state. Coarse hay, by undergoing this process, is rendered more palatable and nutritious.

SWEATING-BATH, *n.* A sudatory; a bath for producing sensible sweat; a hypocaust or stove.

SWEATING-HOUSE, *n.* A house for sweating persons in sickness.

SWEATING-IRON, *n.* A kind of knife or a piece of a scythe, used to scrape off sweat from horses.

SWEATING-ROOM, *n.* A room for sweating persons.—2. In *rural economy*, a room for sweating cheese and carrying off the superfluous juices.

SWEATING-SICKNESS, *n.* *Sudor anglicanus*, *ephemera sudatoria*, or *ephemera maligna*; a febrile epidemic disease which prevailed in some countries of Europe, but particularly in England, in the 15th and 16th centuries.

SWEATY, *a.* Moist with sweat; as, a *sweaty* skin; a *sweaty* garment.—2. Consisting of sweat.

No noisy whiffs or *sweaty* streams.

*Swift.*

3. Laborious; toilsome; as, the *sweaty* forge.

SWED, *n.* A native of Sweden.—2. A Swedish turnip.

SWEDENBORGIANS, *n.* The followers of Emanuel Swedenborg, a Swedish nobleman, born at Stockholm in 1689. He professed himself to be the founder of the New Jerusalem church, alluding to the New Jerusalem spoken of in the book of the Revelation, and conceived that the members of this church were gifted with peculiar insight into spiritual things. The Swedenborgians believe that the regenerate man is in direct communication with angels, and with heaven. They maintain that the sacred Scriptures contain three distinct senses, called celestial, spiritual, and natural, which are united by correspondences, and are accommodated respectively to particular classes, both of men and angels. They date the second advent of Christ from the year 1757, and the commencement of the New Jerusalem church. In the United States the Swedenborgians are numerous, and they have several chapels in London, and other large towns.

SWEDENBORGIANISM, *n.* The doctrines and practice of the Swedenborgians.

SWEDISH, *a.* Pertaining to Sweden.

SWEDISH, *n.* The language of the Swedes.

SWEDISH-TURNIP, *n.* The Brassica campestris, or ruta бага, a hard sort

of turnip, of two kinds, the white and the yellow. The latter is most valued. [See TURNIP.]

**SWEEP**, *v. t. pres. and pp. Sweep.* [Sax. *swapan, sweepan.* It seems to be allied to *swab*, and may be formed on the root of *wipe*. G. *schweifen.*]  
1. To brush or rub over with a brush, broom, or besom, for removing loose dirt; to clean by brushing; as, to sweep a chimney or a floor. When we say, to sweep a room, we mean to sweep the floor of the room; and to sweep the house, is to sweep the floors of the house.—2. To carry with a long swinging or dragging motion; to carry with pomp.

And like a peacock, sweep along his tail.

*Shak.*

3. To drive or carry along or off by a long brushing stroke or force, or by flowing on the earth. Thus, the wind sweeps the snow from the tops of the hills; a river sweeps away a dam, timber, or rubbish; a flood sweeps away a bridge or a house. Hence,—4. To drive, destroy, or carry off many at a stroke, or with celerity and violence; as, a pestilence sweeps off multitudes in a few days. The conflagration swept away whole streets of houses. I have already swept the stakes. *Dryden.*

5. To rub over.

Their long descending train.

With rubies edg'd and sapphires, swept the plain. *Dryden.*

6. To strike with a long stroke. Wake into voice each silent string, And sweep the sounding lyre. *Pope.*

7. In *mar. lan.*, to draw or drag over; as, to sweep the bottom of a river with a net, or with the bight of a rope to hook an anchor.

**SWEEP**, *v. i.* To pass with swiftness and violence, as something broad or brushing the surface of any thing; as, a sweeping rain; a sweeping flood. A fowl that flies near the surface of land or water, is said to sweep along near the surface.—2. To pass over or brush along with celerity and force; as, the wind sweeps along the plain.—3. To pass with pomp; as, a person sweeps along with a trail.

She sweeps it through the court with troops of ladies. *Shak.*

4. To move with a long reach; as, a sweeping stroke.

**SWEEP**, *n.* The act of sweeping.—2. The compass of a stroke; as, a long sweep.—3. The compass of any turning body or motion; as, the sweep of a door.—4. The compass of any thing flowing or brushing; as, the flood carried away every thing within its sweep.—5. Violent and general destruction; as, the sweep of an epidemic disease.—6. Direction of any motion not rectilinear; as, the sweep of a compass.—7. The mould of a ship when she begins to compass in, at the rump heads; also, any part of a ship shaped by the segment of a circle; as, a floor-sweep; a back-sweep, &c.—8. Among refiners of metals, the almond-furnace.—9. Among seamen, a large oar, used to assist the rudder in turning a ship in a calm, or to increase her velocity in a chase, &c.—10. An old name for the balista or engine anciently used in war for throwing stones into fortresses.—Sweep of the tiller, a circular frame on which the tiller traverses in large ships.—11. A chimney sweeper.—12. Sweepstake,—which see.

**SWEEP-BAR**, *n.* The bar of a waggon,

which is fixed on the hind part of the fore-guide, and passes under the hind-pole, which slides upon it.

**SWEEPER**, *n.* One that sweeps.—Sweepers of the sky, a name given by sailors to the north-west winds of America.

**SWEEPING**, *ppr.* Brushing over; rubbing with a broom or besom; cleaning with a broom or besom; brushing along; passing over; dragging over.

**SWEEPINGLY**, *adv.* In a sweeping manner.

**SWEEPINGS**, *n. plur.* Things collected by sweeping; rubbish. The sweepings of streets are often used as manure.

**SWEEP-NET**, *n.* [sweep and net.] A large net for drawing over a wide compass.

**SWEEPSTAKE**, *n.* [sweep and stake.] A man that wins all; usually sweepstakes.

**SWEEPSTAKES**, *n. plur.* A gaming transaction, in which one adventurer, by the turn of fortune, wins (sweeps) the stakes of himself and others.—2. A prize in a horse-race made up of several stakes. Sweepstakes are classed with lotteries, and have been declared illegal.

**SWEEP-WASHER**, *n.* In the refineries of gold and silver, the person who extracts from the sweepings, potsherd, &c., the small particles of those metals which are contained in them.

**SWEEPY**, *a.* Passing with speed and violence over a great compass at once. The branches bend before their sweepy sway. *Dryden.*

2. Strutting.—3. Wavy.

**SWEER**, } *a.* [Sax. *swær, swære*, lazy,  
**SWEIR**, } idle.] Lazy; indolent; reluctant; unwilling. [Scotch.]

**SWEET**, *a.* [Sax. *swete*; G. *süss*; Sans. *swad*. Qu. L. *suavis*.] 1. Agreeable or grateful to the taste; as, sugar or honey is sweet.—2. Pleasing to the smell; fragrant; as, a sweet rose; sweet odour; sweet incense; Exod. xlvii.—3. Pleasing to the ear; soft; melodious; harmonious; as, the sweet notes of a flute or an organ; sweet music; a sweet voice.—4. Pleasing to the eye; beautiful; as, a sweet face; a sweet colour or complexion; a sweet form.—5. Fresh; not salt; as, sweet water.—6. Not sour; as, sweet fruits; sweet oranges.—7. Mild; soft; gentle.

Canst thou bind the sweet influences of Pleiades? Job xxxviii.

8. Mild; soft; kind; obliging; as, sweet manners.—9. Grateful; pleasing.

Sweet interchange of hill and valley.

*Milton.*

10. Making soft or excellent music; as, a sweet singer.—11. Not stale; as, sweet butter. The bread is sweet.—12. Not turned; not sour; as, sweet milk.—13. Not putrescent or putrid; as, the meat is sweet.

**SWEET**, *n.* Something pleasing or grateful to the mind; as, the sweets of domestic life.

A little bitter mingled in our cup, leaves no relish of the sweet. *Locke.*

2. A sweet substance; particularly, any vegetable juice which is added to wines to improve them.—3. A perfume.—4. A word of endearment.—5. Cane juice, molasses, or other sweet vegetable substance.

**SWEET-APPLE**, *n.* [sweet and apple.]

The *Anona squamosa*, or custard apple.

**SWEET-BAY**, *n.* A plant of the genus *Laurus*, the *L. nobilis*.

**SWEET-BREAD**, *n.* [sweet and bread.]

The pancreas of a calf; the pancreas of any animal.

**SWEET-BRIER**, *n.* [sweet and brier.] A shrubby plant of the genus *Rosa*, the *R. rubiginosa*, cultivated for its fragrant smell.

**SWEET-BROOM**, *n.* [sweet and broom.] A plant.

**SWEET-CALAMUS**, } *n.* An aromatic  
**SWEET-CANE**, } plant, some-

times called *lemon-grass* and *spikenard*.  
**SWEET-CICELY**, *n.* A plant of the genus *Myrrhis*, the *M. odorata*. [See MYRRHIS.]

**SWEET-CISTUS**, *n.* A shrub of the genus *Cistus*, the *C. villosus*.

**SWEET-CORN**, *n.* A variety of the maize, of a sweet taste.

**SWEET-FERN**, *n.* A small aromatic shrub.

**SWEET-FLAG**, *n.* A plant of the genus *Acorus*, the *A. calamus*.

**SWEET-GALE**, *n.* A plant of the genus *Myrica*, the *M. gale*; called also Dutch myrtle.

**SWEET-GRASS**, *n.* The English name of various species of plants of the genus *Glyceria* (*G. fluitans*),—which see.

**SWEET-GUM**, *n.* A tree of the genus *Liquidambar*, the *L. styraciflua*.

**SWEET-JOHN'S**, *n.* A plant, a species of *Dianthus*, the *D. barbatus*.

**SWEET-MARJORAM**, *n.* A very fragrant plant, of the genus *Origanum*, the *O. majoranum*.

**SWEET-MAUD'LIN**, *n.* A species of *Achillea*, the *A. ageratum*.

**SWEET-PEA**, *n.* A pea cultivated for ornament, of the genus *Lathyrus*, the *L. odoratus*.

**SWEET-POTATO**, *n.* A plant of the genus *Convolvulus*, the *C. batatas*, a



Sweet Potato (*Convolvulus batatas*).

native of the East Indies, but now cultivated in all the warmer parts of the globe. There are numerous varieties. The tubers are edible, and are much used in tropical countries. They are considered to be very nutritious, wholesome, and easy of digestion.

**SWEET-ROOT**, *n.* The liquorice, or Glycyrrhiza.

**SWEET-RUSH**, *n.* Another name of the sweet-flag, or *Acorus calamus*. It is one of the most pleasing and powerful of the aromatic bitters. The root is the medicinal part. It has been administered in intermittent fevers, and with success, even after the failure of Peruvian bark. In this country, however, it is chiefly used by perfumers in the manufacture of hair powder, on account of its fragrant essential oil. In Constantinople it is made into a confection, is considered a good stomachic, and eaten freely during

the prevalence of epidemic diseases. The plant is common in many parts of

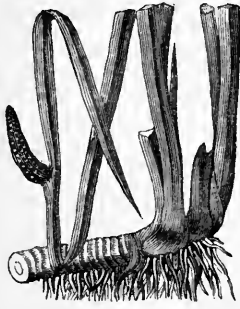

Sweet Rush (*Acorus calamus*).

England, and usually grows in stagnant waters, and by the sides of rivers. **SWEET-SCENTED**, *a.* [*sweet and scent.*] Having a sweet smell; fragrant.

**SWEET-SCENTED GRASS**, *n.* A plant of the genus *Anthoxanthum*, the *A. odoratum*. [*See SPRING GRASS.*]

**SWEET-SMELLING**, *a.* [*sweet and smell.*] Having a sweet smell; fragrant.

**SWEET-SOP**, *n.* A name of the *Anona squamosa*.

**SWEET-SULTAN**, *n.* A plant, a species of *Centaurea*, the *C. moschata*.

**SWEET-TEMPERED**, *a.* Having a sweet disposition.

**SWEET-TONED**, *a.* Having a sweet sound.

**SWEET-VIOLET**, *n.* A plant of the genus *Viola*, the *V. odorata*, a favourite flower, and a native of England.

**SWEET-WEED**, *n.* A plant of the genus *Capraria*, the *C. biflora* or *peruviana*. The same name is given to a species of *scoparia*, the *S. veronica*.

**SWEET-WIL'LIAM**, *n.* A plant of the genus *Dianthus*, the *D. barbatus*, a species of pink of many varieties, cultivated in flower gardens.

**SWEET-WILLOW**, *n.* A plant, the *Myrica gale*, or Dutch myrtle.

**SWEET-WOOD**, *n.* Another name for the *Laurus nobilis*, or sweet bay.

**SWEET-WORT**, *n.* Any plant of a sweet taste.

**SWEETEN**, *v. t.* (*sweet'n.*) To make sweet; as, to *sweeten* tea or coffee.—

2. To make pleasing or grateful to the mind; as, to *sweeten* life; to *sweeten* friendship.—3. To make mild or kind; as, to *sweeten* the temper.—4. To make less painful; as, to *sweeten* the cares of life.—5. To increase agreeable qualities; as, to *sweeten* the joys or pleasures of life.—6. To soften; to make delicate.

Correggio has made his name immortal by the strength he has given to his figures, and by *sweetening* his lights and shades.

*Dryden.*

7. To make pure and salubrious by destroying noxious matter; as, to *sweeten* rooms or apartments that have been infected; to *sweeten* the air.—8. To make warm and fertile; as, to dry and *sweeten* soils.—9. To restore to purity; as, to *sweeten* water, butter, or meat.

**SWEETEN**, *v. i.* (*sweet'n.*) To become sweet.

**SWEETENED**, *pp.* Made sweet, mild, or grateful.

**SWEETENER**, *n.* He or that which

sweetens; he that palliates; that which moderates acrimony.

**SWEETENING**, *ppr.* Making sweet or grateful.

**SWEETENING**, *n.* That which sweetens.

**SWEET-HEART**, *n.* A lover or mistress.

**SWEETING**, *n.* A sweet apple.—2. A word of endearment.

**SWEETISH**, *a.* Somewhat sweet or grateful to the taste.

**SWEETISHNESS**, *n.* The quality of being sweetish.

**SWEETLY**, *adv.* In a sweet manner; gratefully; agreeably.

He *sweetly* temper'd awe. *Dryden.*  
No poet ever *sweetly* sung,

Unless he was, like Phœbus, young. *Swift.*

**SWEETMEAT**, *n.* [*sweet and meat.*] Fruit preserved with sugar; as peaches, pears, melons, nuts, orange peel, and the like.

**SWEETNESS**, *n.* The quality of being sweet, in any of its senses; as, gratefulness to the taste, or to the smell; fragrance; agreeableness to the ear, melody; as, *sweetness* of the voice; *sweetness* of elocution.—2. Agreeableness of manners; softness; mildness; obliging civility; as, *sweetness* of behaviour.—3. Softness; mildness; amiableness; as, *sweetness* of temper.

**SWEETS**, *n. plur.* Home-made wine; mead, &c.

**SWELL**, *v. i.* pret. *Swelled*; pp. *Swelled*.

*Swollen* is nearly obsolete. [*Sax. swellan*; *G. schwellen*. Qu. is it not from the verb to *well*, or its root?]

1. To grow larger; to dilate or extend the exterior surface or dimensions, by matter added to the interior part, or by expansion of the inclosed substance. Thus the legs *swell* in dropsy; a bruised part *swells*; a tumour *swells*; a bladder *swells* by inflation.—2. To increase in size or extent by any addition; as, a river *swells* and overflows its banks.—3. To rise or be driven into waves or billows.

In a tempest, the ocean *swells* into waves mountain high.—4. To be puffed up or bloated; as, to *swell* with pride.

—5. To be bloated with anger; to be exasperated. He *swells* with rage.—

6. To be inflated; to belly; as, *swelling* sails.—7. To be turgid or bombastic; as, *swelling* words; a *swelling* style.—

8. To protuberate; to bulge out; as, a cask *swells* in the middle.—9. To be elated; to rise into arrogance.

Your equal mind yet *swells* not into state. *Dryden.*

10. To grow more violent; as a moderate passion may *swell* to fury.—11. To grow upon the view; to become larger.

And monarchs to behold the *swelling* scene. *Shak.*

12. To become larger in amount. Many little debts added, *swell* to a great amount.—13. To become louder; as, a sound gradually *swells* as it approaches.

—14. To strut; to look big.

*Swelling* like a turkey cock. *Shak.*

15. To rise in altitude; as, land *swells* into hills.

**SWELL**, *v. t.* To increase the size, bulk, or dimensions of; to cause to rise, dilate, or increase. Rains and dissolving snow *swell* the rivers in spring, and cause floods. Jordan is *swelled* by the snows of mount Libanus.—2. To aggravate; to heighten.

It is low ebb with the accuser, when such peccadillos are put to *swell* the charge. *Atterbury.*

3. To raise to arrogance; as, to be *swelled* with pride or haughtiness.—

4. To enlarge. These sums *swell* the amount of taxes to a fearful size. These victories served to *swell* the fame of the commander.—5. In *music*, to augment, as the sound of a note.

**SWELL**, *n.* Extension of bulk.—2. Increase, as of sound; as, the *swell* of a note, or the increase and diminution of sound, *crescendo* and *diminuendo*, in one continued note.—3. A gradual ascent or elevation of land; as, an extensive plain abounding with little *swells*.—4. A wave or billow; more generally, a succession of large waves rolling in any particular direction; as, a heavy *swell* sets into the harbour.

*Swell* is also used to denote the waves or fluctuation of the sea after a storm, and the waves that roll in and break upon the shore.—5. In an organ, a certain number of pipes which are acted on by a key board, and so arranged that the intensity of their sounds may be gradually augmented by the action of a pedal.—6. A showily dressed, but vulgar person.

**SWELL**, *a.* An epithet used only in one term, namely, *swell mob*; meaning the better dressed kind of thieves or pickpockets. [*This and the preceding word (sig. 6.) are trivial.*]

**SWELL'ED**, *pp.* Enlarged in bulk; inflated; tumefied.

**SWELL'ING**, *ppr.* Growing or enlarging in its dimensions; growing tumid; inflating; growing or making louder.

**SWELL'ING**, *n.* A tumour, or any morbid enlargement of the natural size; as, a *swelling* on the hand or leg.—2. Protuberance; prominence. The superficies of such plates are not even, but have many cavities and *swellings*. *Newton.*

3. A rising or enlargement by passion; as, the *swellings* of anger, grief, or pride.

**SWELL**, for *Swelled*, is not in use.

**SWELL**, *† v. i.* [*Sax. sweltan*; *Goth. swiltan*; *ga-swiltan*, to perish, to die; properly, to fail, to swoon. Qu. is not this formed on the root of *wilt*?]

To faint, to swoon; as by excess of heat.

**SWELL**, *† v. t.* To overpower, as with heat; to cause to faint. [We now use *swelter*.]

**SWELLTER**, *v. i.* [*from swelt.*] To be overcome and faint with heat; to be ready to perish with heat.

**SWELLTERED**, *pp.* Oppressed with heat.

**SWELLTERING**, *ppr.* Fainting or languishing with heat; oppressing with heat.

**SWELLTRY**, *a.* Suffocating with heat; oppressive with heat; sultry. [*See SULTRY*, which is probably a contraction of *sweltry*.]

**SWEPT**, *pret.* and *pp.* of *Sweep*.

**SWERD**, for *Sward*, is not in use.

**SWERTIA**, *n.* A genus of perennial aquatics, and annual and biennial herbs, natives of Europe. Class and order Pentandria digynia; nat. order Gentianacææ. *S. perennis*, marsh felwort, is a native of Britain, and is distinguished by radical nerved ovate leaves, attenuated at each extremity.

**SWERVE**, *v. i.* (*swerv.*) [*D. swerven*, to swerve, to rove. In sense it coincides with the verb to *swarm*, and in German it is rendered *schwärmen*. It seems to be formed on *warp*, and all



may spring from the root of *veer*. See VARY.] 1. To wander; to rove. The *swerving* vines on the tall elms prevail.

*Dryden.*

2. To wander from any line prescribed, or from a rule of duty; to depart from what is established by law, duty, or custom; to deviate.

I *swerve* not from thy commandments.

*Com. Prayer.*

They *swerve* from the strict letter of the law.

*Clarendon.*

Many who, through the contagion of evil example, *swerve* exceedingly from the rules of their holy religion.

*Atterbury.*

3. To bend; to incline.—4. To climb or move forward by winding or turning.

The tree was high,

Yet nimbly up from bough to bough I *suerv'd*.

*Dryden.*

SWERVING, *ppr.* Roving; wandering; deviating from any rule or standard; inclining; climbing or moving by winding and turning.

SWERVING, *n.* The act of wandering; deviation from any rule, law, duty, or standard.

SWEVEN, † *n.* A dream.

SWIETE'NIA, *n.* A small genus of plants belonging to the nat. order Cedrelaceae. The species are found in the hot parts of the world, forming large trees, and yielding valuable timber. The most important species is the *S. mahogani*, a native of Campeachy and the West Indies. [See MAHOGANY.]

SWIFT, *a.* [Sax. *swift*, from *swifan*, to turn, to rove, to wander, to whirl round; D. *zweeven*, to rove, to hover, to fluctuate; G. *schweben*, to wave, soar, or hover. The latter appear to be formed on the root of *wave*. See SWIVEL and WAFF.] 1. Moving a great distance, or over a large space in a short time; moving with celerity or velocity; fleet; rapid; quick; speedy. We say, *swift* winds, a *swift* stream, *swift* lightnings, *swift* motion, *swift* as thought, a fowl *swift* of wing, a man *swift* of foot. *Swift* is applicable to any kind of motion.—2. Ready; prompt.

Let every man be *swift* to hear, slow to speak, slow to wrath; James i.

3. Speedy; that comes without delay. There shall be false teachers among you, who shall privily bring in damnable heresies, even denying the Lord that bought them, and bring upon themselves *swift* destruction; 2 Pet. ii.

SWIFT, *n.* The current of a stream. [Little used.]—2. In domestic affairs, a reel or turning instrument for winding yarn. [This is a sense directly from the Saxon verb.]—3. The *Cypselus murarius*, Temminck, the largest and most

bably the most imperfect feet of any known bird. Owing to their extreme shortness, it is unable to walk, except with a most constrained and hobbling gait, and with the assistance of the wings. It lives habitually, and pursues its prey at a greater height from the ground than the swallows, and it constructs its nest at a more lofty elevation, choosing the crevices of steeples and towers, and the crannies of rocks. During the long summer days it often passes sixteen hours in vigorous continued flight. The swift is among the last of our swallows in its arrival, and the first to depart. Another species, the white-bellied or Alpine swift (*Cypselus Alpinus*, Temminck) is known in this country, but it is only a rare straggler. The weight of the swift is most disproportionately small to its extent of wing, the former being scarcely an ounce, the latter eighteen inches; the length of the body being near eight inches.—4. The common newt or eft, a species of lizard.

SWIFTER, *n.* In a ship, a rope used to confine the bars of the capstan in their sockets, while men are turning it; also, a rope used to encircle a boat longitudinally, to strengthen and defend her sides from the impulse of other boats. Swifthers also are two shrouds fixed on the starboard and larboard sides of the lower masts, above all the other shrouds, to give the masts additional security.

SWIFTER, *v. t.* To stretch, as shrouds by tackles.

SWIFTER, *a.* [comp. of *Swift*.] More swift.

SWIFTEST, *a.* [sup. of *Swift*.] Most swift.

SWIFT'FOOT, *a.* Nimble.

SWIFT'FO'ATED, *a.* Fleet; swift in running.

SWIFT'HEELED, *a.* Swift of foot.

SWIFT'LY, *adv.* Fleetly; rapidly; with celerity; with quick motion or velocity.

Pleas'd with the passage we slide *swiftly* on.

*Dryden.*

SWIFT'NESS, *n.* Speed; rapid motion; quickness; celerity; velocity; rapidity. *Swiftness* is a word of general import, applicable to every kind of motion, and to every thing that moves; as, the *swiftness* of a bird; the *swiftness* of a stream; *swiftness* of descent in a falling body; *swiftness* of thought, &c.

SWIFT'-WINGED, *a.* Rapid in flight. SWIG, *v. t.* or *i.* [Ice. *swiga*. Qu. *suck*.] To drink by large draughts; to suck greedily.

SWIG, *n.* A large draught. [Vulgar.]—2. In seamen's lan., a pulley with ropes which are not parallel.

SWIG, *v. t.* [Sax. *swigan*, to stupefy.] To castrate, as a ram, by binding the testicles tight with a string, so that they mortify and slough off. [Local.]

SWIG'GING OFF. In mar. lan., the act of pulling upon the middle of a tight rope which is made fast at both ends.

SWILL, *v. t.* [Sax. *swelgan*, *swylgan*, to swallow.] 1. To drink grossly or greedily; as, to *swill* down great quantities of liquors.—2. To wash; to drench.—3. To inebriate; to swell with fulness.

I should be loth

To meet the rudeness and *swill'd* insolence Of such late wassailers.

*Milton.*

SWILL, † *v. i.* To be intoxicated.

SWILL, *n.* Large draughts of liquor; or drink taken in excessive quantities.—2. The wash or mixture of liquid substances, given to swine; called in some places *swillings*.

SWILL'ED, *pp.* Swallowed grossly in large quantities.

SWILL'ER, *n.* One who drinks voraciously.

SWILL'LEY, *n.* A coal field of small extent. [Provincial.]

SWILL'ING, *ppr.* Swallowing excessive quantities of liquors.

SWILL'INGS, *n.* Swill.

SWIM, *v. i.* pret. *Swam*; pp. *Swam*.

[Sax. *swimman*; D. *zweemmen*, to swim; *zweymen*, to swoon; G. *schwemmen*, *schwimmen*; Sw. *swima*, to swoon.]

1. To float; to be supported on water or other fluid; not to sink. Most species of wood will *swim* in water. Any substance will *swim*, whose specific gravity is less than that of the fluid in which it is immersed.—2. To move progressively in water by means of the motion of the hands and feet, or of fins. In Paris, boys are taught to *swim* by instructors appointed for that purpose.

Leap in with me into this angry flood, And *swim* to yonder point.

*Shak.*

3. To float; to be borne along by a current. In all states there are men who will *swim* with the tide of popular opinion.—4. To glide along with a smooth motion, or with a waving motion.

She with pretty and with *swimming* gait...

*Shak.*

A hov'ring mist came *swimming* o'er his sight.

*Dryden.*

5. To be dizzy or vertiginous; to have a waving motion of the head or a sensation of that kind, or a reeling of the body. The head *swims* when we walk on high.—6. To be floated; to be overflowed or drenched; as, the earth *swims* in rain.

Sudden the ditches swell, the meadows *swim*.

*Thomson.*

All the night I make my bed to *swim*; I water my couch with my tears; Ps. vi.

7. To overflow; to abound; to have abundance.

They now *swim* in joy.

*Milton.*

SWIM, *v. t.* To pass or move on; as, to *swim* a stream. Deer are known to *swim* rivers and sounds.

Sometimes he thought to *swim* the stormy main.

*Dryden.*

2. To immerse in water that the lighter parts may swim; as, to *swim* wheat for seed.

SWIM, *n.* The bladder of fishes, by which they are said to be supported in water; motion on the water; as, in swimming.

SWIM'MER, *n.* One that swims.—2. A protuberance on the leg of a horse.—3. A bird that swims, as the duck and goose.

SWIM'MERS, or SWIM'MING - BIRDS, *n.* The Palmipedes of Cuvier, and the Natatores of Illiger, an order of web-footed aquatic birds formed for swimming. Their feet are placed far back on the body, attached to short and compressed tarsi, and with palmated toes. Their dense and polished plumage, saturated with oil, and the thickly set down which is next to their skin, protect these birds from the water in which they live. The bill is long, enabling them to search for their food below water while they swim on the surface. Their sternum is very

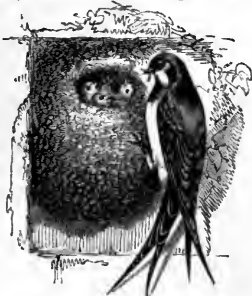

Swift (*Cypselus murarius*).

powerful fier of the swallow tribe which visits this country. It has pro-

long, affording a complete guard to the greater part of their viscera, having on each side but one emargination or oval foramen filled up with membrane. Cuvier divided this order into four families. 1. The Brachypterae, comprehending the grebes, divers, guillemots, anks, and penguins. 2. The Longipennes, including the petrels, puffins, albatrosses, gulls, terns, noddies, and skimmers. 3. Totipalmantae, comprehending the pelicans, cormorants, frigate birds, boobies, and darters. 4. The Lamellirosres, comprehending the swans, geese, ducks, and mergansers.

**SWIMMERS**, *n.* A tribe of spiders (*Araneidae natantes*), which live in water, and there spin their webs to entrap their prey.

**SWIMMING**, *ppr.* Floating on a fluid; moving on a fluid; having a waving or reeling motion; overflowing; abounding.

**SWIMMING**, *n.* The act of sustaining the body in water, and of moving in it; as fishes, which are assisted in this action by their air-bladder and fins. Amphibious animals also possess this faculty to a greater or less extent. Swimming, as applied to human beings, is the act or art of balancing the body on or near the surface of the water, and of making a progress through it. A great proportion of the animal tribes are furnished with a greater or less capacity for swimming either in water or on its surface, but man is unqualified for swimming without learning to do so as an art, owing to the structure of his body. The head by its gravity naturally sinks in water, and thus causes drowning, unless it, or at least the mouth, can be kept above the surface by art. The art of swimming, which can be acquired by exercise only, chiefly consists in keeping the head above water, and using the hands and feet as oars and helm. The best school for swimming is deep water, and the best teacher the frog. Swimming is a highly useful exercise; it strengthens the abdominal muscles, the muscles of the chest, the organs of respiration, the spine, neck, and arms. It increases courage, and furnishes an agreeable excitement. It also affords us the means of preserving our lives or those of others in perilous situations.—2. Dizziness.

**SWIMMINGLY**, *adv.* Smoothly; without obstruction; with great success. [*Not elegant.*]

**SWINDLE**, *v. t.* [*D. zwendelen.*] To cheat and defraud grossly, or with deliberate artifice; as, to *swindle* a man out of his property.

**SWINDLED**, *pp.* Grossly cheated and defrauded.

**SWINDLER**, *n.* [*G. schwindler.*] A cheat; a rogue; one who defrauds grossly, or one who makes a practice of defrauding others by imposition or deliberate artifice.

**SWINDLING**, *n.* The practices of a swindler. When a person by the assumption of a false character, or by a false representation of some sort, obtains the possession of money or other property from another or others, and appropriates it to himself, he is said to be guilty of swindling, and is liable to punishment by law.

**SWINE**, *n. sing. and plur.* [*Sax. swin; G. Schwein; L. suinus.* It is found in the *Fr. marsouin*, a porpoise; *L. mare*,

the sea, and *swine*; the sea-hog; *Port. suino*, pertaining to swine.] A hog; a pachydermatous mammal of the genus *Sus*, which furnishes man with a large portion of his most nourishing food. The fat or lard of this animal enters into various dishes in cookery. The numerous varieties of the hog or swine cultivated in Britain, are partly the result of climate and keep in the European variety, and partly the effects of crossing with the Chinese hog. Berkshire, in England, has long been famous for its breed of swine. [*See SUIDÆ.*]

**SWINE-BREAD**, *n.* A kind of plant, truffle.

**SWINE-CASE**, } *n.* A hog-sty; a pen  
**SWINE-COAT**, }  
**SWINE-CRUE**, } for swine. [*Local.*]

**SWINE-GRASS**, *n.* A plant, knot-grass.

**SWINEHERD**, *n.* [*swine and herd.*] A keeper of swine.

**SWINE-OAT**, *n.* [*swine and oat.*] A kind of oats, cultivated for the use of pigs, as in Cornwall; the *Avena nuda* of botanists.

**SWINE-PIPE**, *n.* [*swine and pipe.*] A bird, the red-wing. [*Local.*]

**SWINE-POX**, *n.* The chicken-pox. [*Local.*] A variety of the chicken-pox, with acuminated vesicles containing a watery fluid; the water-pox.

**SWINE'S CRESS**, *n.* A plant of the genus *Senebiera*, the *S. coronopus*, called also wart-cress.

**SWINE'S FEATHER**, *n.* In *ancient armour*, a small spear about six inches long, called also a *hog's bristle*, and used originally as a bayonet. The name was afterwards, in the 17th century, applied to a similar spear fitted into the musket rests in order to render it a defence against cavalry.

**SWINE-STONE**, *n.* [*swine and stone.*] A name given to those kinds of limestone which, when rubbed, emit a fetid odour, resembling that of naphtha combined with sulphuretted hydrogen. [*See STINKSTONE.*]

**SWINE-STY**, *n.* A sty or pen for swine.

**SWINE-THISTLE**, *n.* A plant, the sow thistle.

**SWING**, *v. i. pret. and pp. Swing.* [*G. schwingen*, to swing, to brandish, to beat; *Sw. swinga*; *Dan. svinger*, to swing, to brandish, to soar. It seems that this is the *Sax. swingan*, to beat, strike, flagellate, whence to *swingle* flax. *Swing* seems to be formed on the root of *wag*.] 1. To move to and fro, as a body suspended in the air; to wave; to vibrate.

I tried if a pendulum would *swing* faster, or continue *swinging* longer in our receiver, if exhausted. *Boyle.*

2. To practise swinging; as, a man *swings* for health or pleasure.—3. To move or float. A ship is said to *swing* when she turns round the anchor or moorings, or changes her position at the change of the wind or tide. This only takes place when the ship is moored by the head, or riding at a single anchor.

**SWING**, *v. t.* To make to play loosely; to cause to wave or vibrate; as, a body

suspended in the air.—2. To whirl round in the air.

*Swing* thee in air, then dash thee down. *Milton.*

3. To wave; to move to and fro; as, a man *swings* his arms when he walks. He *swings* his tail, and swiftly turns him round. *Dryden.*

4. To brandish; to flourish.

**SWING**, *n.* A waving or vibratory motion; oscillation; as, the *swing* of a pendulum.—2. Motion from one side to the other. A haughty man struts or walks with a *swing*.—3. A line, cord, or other thing suspended and hanging loose; also, an apparatus suspended for persons to *swing* in.—4. Influence or power of a body put in motion. The rain that batters down the wall, For the great *swing* and rudeness of his poise. *Shak.*

5. Free course; unrestrained liberty or license. Take thy *swing*. *Dryden.*

To prevent anything which may prove an obstacle to the full *swing* of his genius. *Burke.*

6. The sweep or compass of a moving body.—7. Unrestrained tendency; as, the prevailing *swing* of corrupt nature; the *swing* of propensities.

**SWING'-BRIDGE**, or **SWIV'EL-BRIDGE**, *n.* [*swing and bridge.*] A bridge that may be moved by swinging. It consists of two parts, which join mid-way between the two abutments, each turning upon an upright axis or pivot. By turning the two parts upon their respective pivots, a passage is opened for allowing ships to pass. This kind of bridge is used on canals and rivers.

**SWINGE**, *v. t.* (*swinj.*) [*Sax. swingan*, *supra.*] 1. To beat soundly; to whip; to bastinate; to chastise; to punish.

You *swing'd* me for my love. *Shak.*  
And *swinges* his own vices in his son. *Dryden.*

2.† To move as a lash. [*This verb is obsolescent and vulgar.*]

**SWINGE**,† *n.* (*swinj.*) A sway; a swing; the sweep of anything in motion.

**SWINGE-BUCKLER**,† *n.* (*swinj'-buckler.*) A bully; one who pretends to feats of arms.

**SWING'GEL**, *n.* That part of a flail that falls upon the grain in threshing. [*Local.*]

**SWING'ER**, *n.* One who swings; one who hurls.

**SWING'ING**, *ppr.* of *Swing*. Waving; vibrating; brandishing.

**SWING'ING**, *n.* The act of swinging; an exercise for health or pleasure.

**SWING'ING**, *ppr.* of *Swinge*. Beating soundly.—2. *n.* Huge; very large. [*Vulgar.*]

**SWING'INGLY**, *adv.* Vastly; hugely. [*Vulgar.*]

**SWING'LE**, *v. i.* [*from swing.*] To dangle; to wave hanging.—2.† To swing for pleasure.

**SWING'LE**, *v. t.* [*Sax. swingan*, to beat. *See SWING.*] To beat; to scutch or clean flax by beating it with a wooden instrument resembling a large knife. Flax is first broken and then *swingled*. [*Provincial.*]

**SWING'GLE**, *n.* A sentcher.—2. In *wire-works*, a wooden spoke fixed to the barrel that draws the wire; also, a crank.—3. A wooden instrument like a large knife, about two feet long, with one thin edge, used for cleaning flax of the shives. [*Provincial.*]



Swine's Feather.

**SWIN'GLED**, *pp.* Scutched, beat and cleaned as flax. [*Provincial.*]

**SWING'LE-WAND**, *n.* An instrument for swingling flax.

**SWING'GLING**, *ppr.* Scutching, beating, and cleaning, as flax.—*Swingling machine*, a scutching machine. [*Provincial.*]

**SWING'GLING-TOW**, *n.* The coarse part of flax, separated from the finer by swingling and hatcheling. [*Provincial.*]

**SWING'-PLOUGH**, *n.* Any plough without wheels.

**SWING'-TREE**, or **SWING'LE-TREE**, *n.* [*swing and tree.*] A cross bar by which a horse is yoked to a carriage, plough, &c., and to which the traces are fastened.

**SWING'-WHEEL**, *n.* [*swing and wheel.*] In a time-piece, the wheel which drives the pendulum. In a watch or balance clock, it is called the crown-wheel. [*See CROWN-WHEEL.*]

**SWINISH**, *a.* [*from swine.*] Befitting swine; like swine; gross; hoggish; brutal; as, a *swinish* drunkard or sot; *swinish* gluttony.

**SWINISHLY**, *adv.* In a swinish manner.

**SWINK**, *† v. i.* [*Sax. swincan.*] To labour; to toil; to drudge.

**SWINK**, *† v. t.* To overlabour.

**SWINK**, *† n.* Labour; toil; drudgery.

**SWINK'ER**, *† n.* A labourer; a ploughman.

**SWIPE**, *n.* [*D. wippe, wippen,* to hang, to depend.] A pole supported by a fulcrum on which it turns, used for raising water from a well.

**SWIPES**, *n. plur.* [*Qu. sweeps.*] Poor washy beer. [*Vulgar.*]

**SWIPE**, *n.* [*Ice. swipa;* Goth. *swepa*, a scourge.] That part of a flail which beats out the grain, called in Scotland a *soupe*. [*Provincial.*]

**SWIP'ER**, *† a.* [*Sax. swipan,* to move quick.] Nimble; quick.

**SWIRL**, *v. i.* [*Ice. swirra,* to be hurried round.] To whirl like a vortex. As a noun, a whirling motion; an eddy, as of water; a twist or contortion in the grain of wood, a curl. [*Scotch.*]

**SWIR'LE**, *a.* Full of contortions or twists; entangled; twisted; applied to grass lying in various positions, so that it cannot be easily cut by the mower. [*Scotch.*]

**SWISS**, *n.* A native of Switzerland or Switzerland. — 2. The language of Switzerland.

**SWITCH**, *n.* [*Sw. svege.*] 1. A small flexible twig or rod.

On the medal, Mauritania leads a horse by a thread with one hand, and in the other holds a *switch*. *Addition.*

2. On railways, a contrivance for transferring a car from one track to another. [*See SWITCHES.*]

**SWITCH**, *v. t.* To strike with a small twig or rod; to heat; to lash.

**SWITCH**, *† v. i.* To walk with a jerk.

**SWITCH'EL**, *n.* A beverage made of molasses and water.

**SWITCHES**, *n. plur.* [*Fr. aiguilles.*] In railways, short pieces of railway bars movable upon joints at one end, and applied at the points of junction between two lines of rails, for the purpose of guiding the wheels of the carriages from the one to the other. Switches are susceptible of considerable variety of form and application. They may be either single or double, self-acting, or worked by hand, &c.

In the annexed cut, *a, a* is the straight, and *b, b* the diverging line of rails;

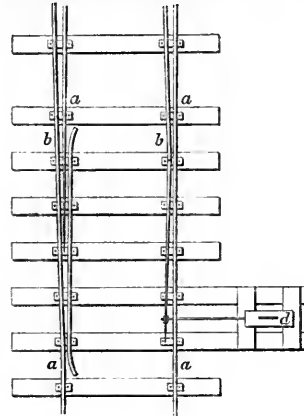

Switch.

the switch, bedded in the ordinary manner, is movable horizontally at the butt end by a lever with a balance weight, and handle, inclosed in the switch-box *d*; the open or closed position of the switch determines the direction of the train along the main line *a*, or on the siding *b*. [*See RAILWAY.*]

**SWITCH'ING**, *n.* A beating with a switch.—*Switching of hedges*, the cutting off of the one year's growth which protrudes from the sides of the hedges. — *Switching bill*, an instrument used in pruning hedges.

**SWITH**, or **SWITHE**, *† adv.* [*Sax. swith*, very, very much, from *swithian*, to prevail.] Instantly; quickly; speedily; promptly. [*Retained in the Scottish dialect.*]

**SWITHER**, or **SWID'DER**, *n.* [*Etymol. uncertain.*] Doubt; hesitation; perplexity. As a verb neuter, to doubt; to hesitate. [*Scotch.*]

**SWITZER**, *† n.* A Swiss.

**SWIVEL**, *n.* (*swiv'l*) [*from Sax. swifan*, to turn or whirl round; or from the root of *whiffle*,—*whic* see. In *D. wiefelen* is to palter, to waver, to whiffle.] 1. A kind of ring or link of a chain, rendered capable of turning round by jointing it to another ring or link, by means of a pin or axis, thus forming a movable joint. Swivel joints are adapted and modified in a variety of ways, and are used when one part of a chain requires to have a rotatory motion, while the other is at rest or moves in a direction contrary to that of the other; and also for many other purposes.—2. In *marine affairs*, a strong link of iron on the above principle, used in mooring-chains, &c., which permits the bridles to be turned repeatedly round as occasion requires.—3. A small cannon or piece of artillery, carrying a shot of 1½ pounds, fixed in a swivel on the top of a ship's side, stern, or bow, or in her tops, in such a manner as to be turned in any direction.

**SWIVEL**, *v. i.* (*swiv'l*) To turn on a staple, pin, or pivot.

**SWIVEL-HOOK**, *n.* A hook that turns in the end of an iron block strap, for the ready taking the turns out of a tackle.

**SWOB**, *n.* A mop. [*See SWAB.*]

**SWOB**, *v. t.* To clean or wipe with a swob. [*See SWAB.*]

**SWOB'BER**, *n.* One who swabs or cleans with a mop. [*See SWABBER.*]

—2. *Swobbers*, four privileged cards, only used incidentally in betting at the game of whist.

**SWOLL'EN**, } *pp.* of *Swell*; irregular

**SWOLN**, } and obsolescent. The regular participle, *swelled*, is to be preferred.

**SWOM**, *old pret.* of *Swim*, is obsolete. We now use *swum* and *swam*.

**SWOON**, *v. i.* [*Sax. aswinan.* *Qu. wane, vain, vanish.*] To faint; to sink into a fainting fit, in which there is an apparent suspension of the vital functions and mental powers.

The most in years *swoon'd* first away for pain. *Dryden.*

He never ready to *swoon* away in the surprise of joy. *Tatler.*

**SWOON**, *n.* A fainting fit; lipothymy; syncope.

**SWOON'ING**, *ppr.* Fainting away.

**SWOON'ING**, *n.* The act of fainting; syncope.

**SWOOP**, *v. t.* [This is probably from *sweep*, or the same root.] 1. To fall on at once and seize; to catch while on the wing; as, a hawk *swoops* a chicken; a kite *swoops* up a mouse.—

2. To seize; to catch up; to take with a sweep.—3. *†* To pass with violence.

**SWOOP**, *v. i.* To pass with pomp.

**SWOOP**, *n.* A falling on and seizing, as of a rapacious fowl on his prey.

The eagle fell ... and carried away a whole litter of cubs at a *swoop*.

*L'Etrange.*

**SWOP**, *v. t.* To exchange; to barter; to give one commodity for another. [*See SWAP.* This is a common word, but not in elegant use.]

**SWOP**, *n.* An exchange; a barter. In *Scotch*, *swap*.

**SWÖRD**, *n.* [*Sax. sword, sweord; G. schwert.*] 1. An offensive weapon worn at the side, and used by hand either for thrusting or cutting. Its parts are, the handle, guard, and blade; to which may be added, the bow, scabbard, pommel, &c.—2. Figuratively, destruction by war.

I will bring a *sword* upon you; *Lev. xxvi. 18. li.*

3. Vengeance or justice. She quits the balance, and resigns the *sword*. *Dryden.*

4. Emblem of authority and power. The ruler...beareth not the *sword* in vain; *Rom. xiii.*

5. War; dissension. I came not to send peace but a *sword*; *Matt. x.*

6. Emblem of triumph and protection. The Lord...the *sword* of thy excellence; *Deut. xxxiii.*

*Sword of state*, the sword which is borne before the king, lords, and governors of counties, cities, or boroughs, &c. Four swords are used at the coronation of a British sovereign, viz. the sword of state, properly so called; the sword of mercy, which is pointless; the sword of spiritual justice, and the sword of temporal justice.—*Broad sword*, an original weapon of Scotland, having a basket-hilt, and a broad blade with but one cutting edge. It is about three feet two inches long, but there is also a small broad sword.—*Double-handed sword*, a large sword wielded with both hands, now disused as a weapon of war.—*To surrender the sword*, denotes submission, and *to break the sword*, degradation. Crooked swords are used by light cavalry in

Enrope, but the heavy cavalry use the straight long sword, and likewise all British officers. Toledo, Milan, Damascus, Ispahan and Cairo, were celebrated for the manufacture of sword blades.

**SWORD BAYONET, n.** A bayonet which is longer than the common one, and generally used with rifles.

**SWORD-BEARER, n.** [*sword* and *bear*.] The official who, on ceremonial occasions, carries the sword of state or the sword of justice.

**SWORD-BELT, n.** [*sword* and *belt*.] A belt by which a sword is suspended and borne by the side.

**SWORD-BLADE, n.** [*sword* and *blade*.] The blade or cutting part of a sword.

**SWORD-CUTLER, n.** One who makes or mounts swords.

**SWORDED, a.** Girded with a sword.

**SWORDEE, n.** A soldier; a cut-throat.

**SWORD-FIGHT, n.** [*sword* and *fight*.] Fencing; a combat or trial of skill with swords.

**SWORD-FISH, n.** [*sword* and *fish*.] Xiphias, a genus of Acanthopterygians fishes, belonging to the Scomberoides or mackerel tribe. The single species (*X. gladius*) is an inhabitant of the



Sword-Fish (*Xiphias gladius*).

Mediterranean and Atlantic, and occasionally visits our coasts. It is remarkable for its elongated upper jaw, which forms a sword-like weapon; whence the name. It measures from ten to fifteen feet in length. Its body is lengthy and covered with minute scales, the sword forming three-tenths of its length. On the back, it has a single long elevated dorsal fin, but it is destitute of central fins. The swordfish is said to attack the whale with its beak, and it sometimes perforates the planks of ships with the same powerful weapon. The young fish is said to be excellent eating.

**SWORD-GRASS, n.** [*sword* and *grass*.] A general name for sedgy plants, on account of their sword-shaped leaves.

**SWORD-KNOT, n.** [*sword* and *knot*.] A ribbon tied to the hilt of a sword.

**SWORD-LAW, n.** [*sword* and *law*.] Violence; government by force.

**SWORDESS, a.** Destitute of a sword.

**SWORD LILY, n.** The English name of plants of the genus *Gladiolus*,—which see.

**SWORD-MAN, or SWORDS-MAN, n.** [*sword* and *man*.] A soldier; a fighting man.

**SWORD-PLAY, n.** A combat of gladiators.

**SWORD-PLAYER, n.** [*sword* and *player*.] A fencer; a gladiator; one who exhibits his skill in the use of the sword.

**SWORD-SHAPED, a.** [*sword* and *shape*.] Ensiform; shaped like a sword.

—*Sword-shaped leaf*, a leaf that is laterally flattened, erect, and resembling the blade of a sword; as in *Iris*.

**SWORDSMANSHIP, n.** Skilful use of the sword.

**SWORE, pret. of Swear.**

**SWORN, pp. of Swear.** The officers of government are *sworn* to a faithful discharge of their duty.—*Sworn friends* is a phrase equivalent to determined, close, or firm friends.

I am *sworn* brother, sweet,  
To grim necessity. *Shak.*

*Sworn enemies* are determined or irreconcilable enemies.—*Sworn brothers*, soldiers of fortune, who used to engage themselves by mutual oaths to share the rewards of their services.—*To be sworn in*, to take an oath, as the oath of allegiance, previous to admission into any office under the government, or before receiving a commission in the army or navy.

**SWOUND, † v. i.** To swoon.

**SWUM, pret. and pp. of Swim.**

**SWUNG, pret. and pp. of Swing.**

**SY'ALITE, n.** In *bot.*, a plant; the *Dilenia speciosa*.

**SYB, } † a. [Sax.]** Related by blood.

**SIB, } [See SIB.]**

**SYB'ARITE, n.** [*from Sybaris*.] A person devoted to luxury and pleasure.

**SYBARIT'IC, } a. [*from Sybarite*,  
**SYBARIT'ICAL, }** inhabitants of Sybaris, in Italy, who were proverbially voluptuous.] Luxurious; wanton.**

**SYCAMINE.** See SYCAMORE.

**SYC'AMORE, n.** [*Gr. συκαμινος, συκαμινος, from συκος, a fig, and μινος, lot*] A tree of the genus *Ficus*, the *F. Sycomorus*, or sycamore of Scripture. It



Sycamore (*Ficus sycomorus*).

is very common in Palestine, Arabia, and Egypt, growing large, and to a great height, and, though the grain is coarse, much used in building, and very durable. Its wide-spreading branches afford a grateful shade in those hot climates, and its fruit, which is produced in clustered racemes upon the trunk and the old limbs, is sweet and delicate. It bears fruit several times in the year.—*Sycamore maple*, the *Acer pseudo-platanus*, Linn., a well known large timber-tree, long naturalized in England, and much used in ornamental planting. The timber is used for certain parts of musical instruments, and various other purposes. There are several varieties. The *sycamore*, [falsely so called,] or plane tree of North America, is the *Platanus occidentalis*, Linn., commonly called button wood, or cotton tree.

**SYC'AMORE-MOTH, n.** A large and beautiful moth or night butterfly; so called because its caterpillar feeds on the leaves of the sycamore.

**SYCE, n.** In *India*, a native groom.

**SYCEE', } n. In *China*, silver  
**SYCEE'-SILVER, }** in the form of small half globes, or balls, bearing the**

official stamp to testify its purity; and used as the only silver currency of the Chinese, of native make.

**SYCHEE', n.** The Chinese name for black tea.

**SY'ITE, n.** [*Gr. συζος, a fig*.] Figstone; a name which some authors give to nodules of flint or pebbles which resemble a fig.

**SYCO'MA, n.** [*from Gr. συκος, a fig*.] A wart or excrescence, resembling a fig, on the eyelid, the anus, or any other part.

**SYCO'NUS, n.** In *bot.*, a fleshy, hollow receptacle, containing numerous flowers which are combined in the fruit, as in the fig.

**SYC'OPHANCY, n.** [*infra*.] Originally, information of the clandestine exportation of figs; hence, mean talebearing; obsequious flattery; servility.

**SYC'OPHANT, n.** [*Gr. συκοφαντη: συκος, a fig, and φανω, to discover*.] Originally, an informer against those who stole figs, or exported them contrary to law, &c., at Athens. Hence in time it came to signify a talebearer or informer, in general; hence, a parasite; a mean flatterer; especially a flatterer of princes and great men; hence, a deceiver; an impostor. Its most general use is in the sense of an obsequious flatterer or parasite.

**SYC'OPHANT, } v. t. To play the  
**SYC'OPHANTIZE, }** sycophant; to flatter meanly and officiously; to inform or tell tales for gaining favour.**

[*Inelegant words*.]

**SYCOPHANT'IC, a.** Talebearing; more generally, obsequiously flattering; parasitic; courting favour by mean adulation.—2. *Sycophantic plants*, or *parasites*, are such as adhere to other plants, and depend on them for support.

**SYCOPHANT'ICAL, a.** Sycophantic.

[*Little used*.]

**SYC'OPHANTRY, n.** Mean and officious talebearing or adulation.

**SYCO'SIS, n.** [*Gr. συκοσις from συκος, a fig*.] A cutaneous disease, which consists of an eruption of inflamed but not very hard tubercles, occurring on the bearded portion of the face, and on the scalp, and usually clustering together in irregular patches.

**SYDNE'AN, } a. Denoting a species of  
**SYDNE'IAN, }** white earth brought from Sydney cove in South Wales.**

**SYENITE.** See SIENITE.

**SYLLAB'IC, } a. [*from syllable*.]**

**SYLLAB'ICAL, }** Pertaining to a syllable or syllables; as, *syllabic* accent.—2. Consisting of a syllable or syllables; as, a *syllabic* augment.

**SYLLAB'ICALLY, adv.** In a syllabic manner.

**SYLLABICA'TION, n.** The act of forming syllables; the act or method of dividing words into syllables.

**SYLL'ABLE, n.** [*L. syllaba; Gr. συλλαβη, from συλλαμβανω, to comprehend; συ, and λαμβανω, to take*.] 1. A letter, or a combination of letters, uttered together, or at a single effort or impulse of the voice. A vowel may form a syllable by itself, as *a*, the definite, or in *amen*; *e* in *even*; *o* in *over*, and the like. A syllable may also be formed of a vowel and one consonant, as in *go, do, in, at*; or a syllable may be formed by a vowel with two articulations, one preceding, the other following it, as in *can, but, tun*; or a syllable may consist of a combination of consonants, with one vowel or diphthong, as *strong, short, camp, voice*.

A syllable sometimes forms a word, and is then significant, as, in *go, run, write, sun, moon*. In other cases, a syllable is merely a part of a word, and by itself is not significant. Thus *ac*, in *active*, has no signification. At least one vowel or open sound is essential to the formation of a syllable; hence in every word there must be as many syllables as there are single vowels, or single vowels and diphthongs. A word is called according to the number of syllables it contains; viz., monosyllable, a word of one syllable; dissyllable, a word of two syllables; trisyllable, a word of three syllables; polysyllable, a word of many syllables.—2. A small part of a sentence or discourse; something very concise. This account contains not a *syllable* of truth.

Before a *syllable* of the law of God was written. *Hooker.*

**SYLLABLE**, † *v. t.* To utter; to articulate.

**SYLLABUB**, *n.* A compound drink made of wine and milk; a different orthography of *Sillabub*.

**SYLLABUS**, *n.* [L. from the same source as *syllable*.] An abstract; a compendium containing the heads of a discourse; a course of lectures, a book, &c.

**SYLLEP'SIS**, *n.* [Gr. συλληψις. See SYLLABLE.] 1. In *gram.*, a figure by which we conceive the sense of words otherwise than the words import, and construe them according to the intention of the author; or otherwise called *substitution*.—2. The agreement of a verb or adjective, not with the word next to it, but with the most worthy in the sentence; as, *rex et regina beati*.

**SYLLEPTICAL**, *a.* Relating to or implying syllepsis.

**SYLLEPTICALLY**, *adv.* By way of syllepsis.

**SYLLOGISM**, *n.* [L. *sylogismus*; Gr. συλλογισμος; *συ*, with, and *λογω*, to speak; *λογισμος*, to think.] A form of reasoning or argument, consisting of three propositions, of which the two first are called the *premises*, and the last the *conclusion*. In this argument, the conclusion necessarily follows from the premises; so that if the two first propositions are true, the conclusion must be true, and the argument amounts to demonstration. Thus, a plant has not the power of locomotion; an oak is a plant; therefore an oak has not the power of locomotion. These propositions are denominated the *major*, the *minor*, and the *conclusion*. The three propositions of a syllogism are made up of three ideas or terms, and these terms are called the *major*, the *minor*, and the *middle*. The subject of the conclusion is called the *minor term*; its predicate is the *major term*, and the middle term is that which shews the connection between the major and minor term in the conclusion; or it is that with which the major and minor terms are respectively compared. Syllogisms are divided by some into single, complex, conjunctive, &c., and by others into categorical, hypothetical, conditional, &c. The figure of a syllogism is the proper disposition of the middle term with reference to the major and minor terms. The figures are generally reckoned three. The mood of a syllogism is the designation of its three propositions, according to their quantity and quality. The quantity and quality of propositions, in logic, are marked by arbitrary symbols, as A, E, I, O. Every

assertion may be reduced to one of four forms—the universal affirmative, marked by A; the universal negative, marked by E; the particular affirmative, marked by I; and the particular negative, marked by O. From these, by combination, all syllogisms are derived. In order to remember the figures, certain words have been long used by writers on logic, which make a grotesque appearance; but which nevertheless are of considerable use. Thus, under the first figure, we have Barbara, Celarent, Darii, Ferio; under the second, Cesare, Camestres, Festino, Baroko; and under the third, Darapti, Disamis, Datisi, Felapton, Bokardo, Feriso. Each of these words designates a particular mood. The rules of syllogism may be thus briefly expressed: 1. One at least of the premises must be affirmative, and one at least universal; 2. The middle term must enter universally in one of the premises; and, 3. The conclusion must not speak of any term in a wider sense than it was spoken of in the premise in which it entered. A term universally spoken of is either the subject of a universal affirmative, or the predicate of any negative. Syllogisms are nothing else than reasoning reduced to form and method, and all that passes under the name of reasoning, unless it can be made syllogistic, is no reasoning at all, but a mass of words without meaning. The syllogism is the instrument of self-examination, and the last weapon of resort in dispute; and a bad syllogism, with one of the premises implied only, and not expressed, is the first resource of fallacy. To bring forward the suppressed premise, is the visible destruction of every argument which is logically bad.

**SYLLOGIS'TIC**, } a. Pertaining to a  
**SYLLOGIS'TICAL**, } syllogism; consisting of a syllogism; or of the form of reasoning by syllogisms; as, *syllogistic* arguments or reasoning.

**SYLLOGIS'TICALLY**, *adv.* In the form of a syllogism; by means of syllogisms; as, to reason or prove *syllogistically*.

**SYLLOGIZ'ATION**, *n.* A reasoning by syllogisms.

**SYLLOGIZE**, *v. i.* To reason by syllogisms.

Men have endeavoured to teach boys to *syllogize*, or to frame arguments and refute them, without real knowledge. *Watts.*

**SYLLOGIZER**, *n.* One who reasons by syllogisms.

**SYLLOGIZING**, *ppr.* Reasoning by syllogisms.

**SYLPH**, *n.* [Fr. *syphide*; Gr. σίφη, a moth, a beetle.] An imaginary being inhabiting the air, so named by the Rosicrucians and Cabalists.

**SYLPH'ID**, *n.* A diminutive of sylph.

**SYLPH-LIKE**, *a.* Resembling a sylph.

**SYLVA**, *n.* [L., a wood or forest.] In *poetry*, a poetical piece composed in a start or kind of transport.—2. A collection of poetical pieces of various kinds.—3. A work containing a botanical description of the forest trees of any region or country.—4. The forest trees themselves of any region or country.

**SYLVAN**. See SILVAN.

**SYLVAN**, *n.* A fabled deity of the wood; a satyr; a faun; sometimes perhaps, a rustic.

Her private orchards, wall'd on ev'ry side,  
To lawless *syllans* all access deny'd. *Pope.*

**SYLVANITE**, *n.* Native tellurium, a metallic substance discovered in Transylvania.

**SYLVATE**, *n.* A compound of sylvic acid with a base.

**SYLVATIC**, *a.* Sylvan; relating to woods.

**SYLVES'TRIAN**, *a.* Sylvan; inhabiting the woods.

**SYLVIA**, *n.* A genus of slender-billed song-birds, including the Black-cap, *S. atricapilla*, and Garden Warbler, *S. hortensis*. They are, next to the Nightingales, the most distinguished for the variety and modulation of their notes.

**SYLVIADÆ**. The name given by Vigors to a family of dentostrual birds, comprehending the warblers of British ornithologists.

**SYLVIC ACID**, *n.* An acid extracted from common resin or rosin by weak alcohol, and purified by stronger alcohol. It crystallizes in minute prisms, and consists of 20 atoms of carbon, 16 of hydrogen, and 2 of oxygen.

**SYMBAL**. See CYMBAL.

**SYMBOL**, *n.* [L. *symbolum*; Gr. συμβολη; *συν*, with, and *βαλλω*, to throw; *συμβαλλω*, to compare.] 1. The sign or representation of any moral thing by the images or properties of natural things. Thus the lion is the *symbol* of courage; the lamb is the *symbol* of meekness or patience. Symbols are of various kinds, as types, enigmas, parables, fables, allegories, emblems, hieroglyphics, &c.

—2. An emblem or representation of something else. Thus in the eucharist, the bread and wine are called *symbols* of the body and blood of Christ.—3. A letter or character which is significant. The Chinese letters are most of them *symbols*. The *symbols* in algebra are arbitrary.—4. In medals, a certain mark or figure representing a being or thing, as a trident is the *symbol* of Neptune, the peacock of Juno, &c.—5. Among Christians, an abstract or compendium, the creed or a summary of the articles of religion.—6. † Lot; sentence of adjudication.—*Mathematical symbols*, letters and characters which represent quantities or magnitudes, and point out their relations. The symbols generally recognized by mathematicians, consist of the capitals of the Roman alphabet, and the small letters of the Italic; the small letters of the Greek alphabet, and such capitals as are distinguishable from the corresponding Roman ones; the Arabic numerals and occasionally the Roman ones; accents, figures and letters, superfixed and

suffixed; as,  $a'$ ,  $a_{11}$ ;  $a^2$ ,  $a_2$ ;  $a^m$ ,  $a_v$ ; the signs, +, -, ×, ÷, √; the integral sign  $\int$  with its limits expressed; as, in  $\int_a^b$ ; the symbols of nothing and infinity, 0 and  $\infty$ ; brackets and parentheses, &c., [ ], ( ), { }, &c.; the sign of equality =; the signs of greater and less, > <.—*Chemical symbols*. [See under CHEMICAL.] In *Scots law*, heritable property is transferred by the delivery of symbols. Thus, lands are resigned by a vassal to his superior by the symbol of *staff and baton*. In giving sashine of lands, the symbols are *earth and stone* of the lands; of an annual rent out of lands, *earth and stone, with a penny money*; of fishings, *net and cobble*; of mills, *clap and hopper*; of houses within a burgh, *hasp*

and staple; of patronage teinds, a sheaf of corn; of patronage, a psalm-book, and the keys of the church; of jurisdictions, the book of court. The law, however, regarding the transference of heritable property, has recently been much simplified, and many of these symbolical acts are no longer requisite. [See SASINE.]

**SYMBOLIC,** } *a.* Representative; **SYMBOLICAL,** } exhibiting or expressing by resemblance or signs; as, the figure of an eye is *symbolical* of sight and knowledge. The ancients had their *symbolical* mysteries.

The sacrament is a representation of Christ's death, by such *symbolical* actions as he appointed. *Taylor.*

*Symbolical philosophy*, is the philosophy expressed by hieroglyphics.—*Symbolical books*, the name given by the Lutherans to their standard books of faith and discipline, and now by extension applied to the standards of other bodies of Christians.—*Symbolical attributes*, certain symbols, by which artists distinguish the various evangelists, apostles, saints, &c., in their representations.

**SYMBOLICALLY,** *adv.* By representation or resemblance of properties; by signs; typically. Courage is *symbolically* represented by a lion.

**SYMBOLICES,** *n.* The name given by the Germans to the study of the symbols and mysterious rites of antiquity; and also the study of the history and contents of christian creeds and confessions of faith.

**SYMBOLISM,** *n.* Among chemists, consent of parts.

**SYMBOLIZATION,** *n.* [See **SYMBOLIZE**.] The act of symbolizing; resemblance in properties.

**SYMBOLIZE,** *v. t.* [Fr. *symboliser*.] To have a resemblance of qualities or properties.

The pleasing of colour *symbolizeth* with the pleasing of a single tone to the ear; but the pleasing of order doth *symbolize* with harmony. *Bacon.*

They both *symbolize* in this, that they love to look upon themselves through multiplying glasses. *Howell.*

**SYMBOLIZE,** *v. t.* To make to agree in properties.—2. To make representative of something.

Some *symbolize* the same from the mystery of its colours. *Brown.*

**SYMBOLIZED,** *pp.* Made to agree in properties.

**SYMBOLIZING,** *ppr.* Representing by some properties in common; making to agree or resemble in properties.

**SYMBOLÓGY,** *n.* The art of expressing by symbols.

**SYMMETRICAL,** *a.* [from *symmetry*.] Commensurable.

**SYMMETRIAN,** } *n.* [from *symmetry*.]  
**SYMMETRIST,** } One eminently studious of proportion or symmetry of parts.

**SYMMETRICAL,** *a.* [from *symmetry*.] Proportional in its parts; having its parts in due proportion, as to dimensions; as, a *symmetrical* body or building; having that obvious relation of equal and similar figures, which refers to their position merely, and consists in their corresponding portions being placed on different sides of the same straight line.—2. In *bot.*, flowers are *symmetrical* when the segments of the calyx, the petals and the stamens are regular, equal, and alike.—3. In *ancient geometry*, commensurable; thus, two

magnitudes, which admitted of a common measure, were said to be *symmetrical*.—*Symmetrical solids*, a name given by Legendre to those solids which, though equal and similar, cannot be made to coincide, or to fill the same space, as is the case with equal and similar plane figures. If a regular pyramid, having for its base an isosceles triangle, be cut by a plane passing through its vertex, and bisecting the base of the isosceles triangle, and also passing through the opposite angle of the same triangle, the figures on each side of the cutting plane will be *symmetrical solids*. The two hands furnish an example of *symmetrical solids*; they give the idea of equality of size, similarity of form, and symmetry of disposition, but yet they cannot be made to coincide or occupy the same space; so as, for instance, to fit exactly the same glove. In *alge*, a function is said to be *symmetrical* with respect to any two letters, when it would undergo no change if these letters were interchanged, or if each were made to take the place of the other. Also, an expression is said to be *symmetrical* with respect to any number of letters, when any two of them whatsoever may be interchanged without alteration of the function.

**SYMMETRICALLY,** *adv.* With due proportion of parts.

**SYMMETRICALNESS,** *n.* State or quality of being *symmetrical*.

**SYMMETRIZE,** *v. t.* To make proportional in its parts; to reduce to *symmetry*.

**SYMMETRIZED,** *pp.* Made proportional.

**SYMMETRIZING,** *ppr.* Reducing to *symmetry*.

**SYMMETRY,** *n.* [Gr. *συμμετρία*: *συν*, with, together, and *μετρον*, measure; *μετρον*, to measure; Fr. *symetrie*.] A due proportion of the several parts of a body to each other; adaptation of the dimensions of the several parts of a thing to each other; or the union and conformity of the members of a work to the whole.—2. That relation of equal and similar figures which refers to their position merely, and consists in their uniformity as regards the answering of one portion to another, or in their corresponding portions being similarly placed on different sides of the same straight line, so that coincidences cannot be obtained without turning one figure round that straight line. If the front of a building be *symmetrical*, and a vertical line be drawn through the middle of the elevation, then the two lateral portions are not only equal and similar, but also *symmetrical*; the right hand side stands in the right hand portion of space with respect to the dividing line, and in exactly the same manner as the left-hand side stands in the left-hand portion of space. In the letter W there is a want of *symmetry*, but not in O: to make W *symmetrical*, both the inner lines should be made thin, and both the outer ones thick.—3. In the *fine arts generally*, proportion; harmony; the most proper relation of the measure of parts to each other, and to the whole. In the same sense we speak of the *symmetry* of animal bodies.—*Uniform symmetry*, in architecture, is where the same ordonnance reigns throughout the whole.—*Respective symmetry*, is where only the opposite sides are equal to each other.

**SYMPATHETIC,** } *a.* [Fr. *sym-*  
**SYMPATHETICAL,** } *pathique*. See

**SYMPATHY.**] 1. Pertaining to sympathy.—2. Having common feeling with another; susceptible of being affected by feelings like those of another, or of feelings in consequence of what another feels; as, a *sympathetic* heart.—3. In *med.*, the term *sympathetic* is applied to symptoms and affections, which occur in parts more or less remote from the primary seat of disease, and are occasioned by some nervous connection of the parts. A disease which is immediately preceded and occasioned by another disease, is sometimes said to be *sympathetic*, in contradistinction from *idiopathic*, which is applied to a disease not preceded or occasioned by any other; but, in this case, the term *sympomatic* is not only more appropriate, but more commonly employed.—4. Among *alchemists*, an epithet applied to a kind of powder, possessed of the wonderful property that if spread on a cloth dipped in the blood of a wound, the wound will be healed, though the patient is at a distance. This opinion is discarded as charlatany.—5. In *anat.*, the term *sympathetic* is applied to that system of nerves, which takes its origin from the semilunar ganglion in the centre of the epigastrium, and is sent to the whole nutritive system, and also to the organs of reproduction.—*Sympathetic ink*, a species of ink or liquor with which, when a person writes upon paper, the writing is invisible until heat or some re-agent is applied. Most of the acids or saline solutions, being diluted and used to write with, become visible by heating before the fire. A diluted solution of cobalt affords an ink which becomes green when held before the fire. If a weak solution of galls be used, the writing will be invisible till the paper is moistened with a weak solution of sulphate of iron. The diluted solutions of gold and silver remain colourless upon the paper till exposed to the sun's light.—*Sympathetic sounds*, sounds produced in one musical instrument by sounding another near it. The harmonies of the Æolian harp are *sympathetic sounds*, being produced by the communication of motion from one string to another, through the medium of intervening air.—*Sympathetic disease*, one which is produced by a remote cause, as when a fever follows a local injury.—*Sympathetic cures*, cures pretended or real, the operation of which is attributed to a certain sympathy of the sufferer with other individuals, or with spirits, animals, stars, plants, &c. A full belief in the efficacy of such means of cure, has a great effect in such diseases as are seated in the nervous system.—*Sympathetic powder*, a powder chemically prepared from green or blue vitriol.

**SYMPATHETICALLY,** *adv.* With sympathy or common feeling; in consequence of sympathy; by communication from something else.

**SYMPATHIST,** *n.* One who feels sympathy.

**SYMPATHIZE,** *v. i.* [Fr. *sympathiser*. See **SYMPATHY**.] 1. To have a common feeling, as of bodily pleasure or pain.

The mind will *sympathize* so much with the anguish and debility of the body, that it will be too distracted to fix itself in meditation. *Buckminster.*

2. To feel in consequence of what another feels; to be affected by feelings similar to those of another, in consequence of knowing the person to be thus affected. We *sympathize* with our friends in distress; we feel some pain when we see them pained, or when we are informed of their distresses, even at a distance. It is generally and properly used of suffering or pain, and not of pleasure or joy. It may be sometimes used with greater latitude.—3. † To agree; to fit.

**SYMPATHEZING**, *ppr.* Feeling mutually, or in consequence of what another feels.

**SYMPATHY**, *n.* [Gr. *συμπαθια*, *συμπαθω*: *συ*, with, and *παθος*, passion.] 1. Fellow feeling; the quality of being affected by the affection of another, with feelings correspondent in kind, if not in degree. We feel *sympathy* for another when we see him in distress, or when we are informed of his distresses. This *sympathy* is a correspondent feeling of pain or regret. Sympathy is often an imitative faculty, sometimes exercised involuntarily, frequently without consciousness. Thus we yawn when we see others yawn, and are made to laugh by the laughing of another.

*Sympathy* is produced through the medium of organic impression. *Chipman.*

I value myself upon *sympathy*; I hate and despise myself for envy. *Kames.*

2. An agreement of affections or inclinations, or a conformity of natural temperament, which makes two persons pleased with each other.

To such associations may be attributed most of the *sympathies* and antipathies of our nature. *Anon.*

3. In *med.*, a correspondence of various parts of the body in similar sensations or affections; or an affection of the whole body or some part of it, in consequence of an injury or disease of another part, or of a local affection. Thus, a contusion on the head will produce nausea and vomiting. This is said to be by *sympathy*, or consent of parts.—4. In *nat. hist.*, a propension of inanimate things to unite, or to act on each other. Thus we say, there is a *sympathy* between the lodestone and iron.—5. In the *fine arts*, conformity of the parts to each other; but in *painting*, it usually signifies the effective union of colours.

**SYMPEP'SIS**, *n.* In *med.*, a ripening of inflammatory humours.

**SYMPHO'NIA**, *n.* [L.] A symphony.

**SYMPHO'NIOS**, *a.* [from *sympphony*.] Agreeing in sound; accordant; harmonious.

#### Sounds

*Symphonious* of ten thousand harps. *Milton.*

**SYMPHONIST**, *n.* A composer of symphonies or instrumental music.

**SYMPHONIZE**, *v. i.* To agree with; to harmonize.

**SYMPHONY**, *n.* [L. *symphonia*; Fr. *symphonie*; Gr. *συμφωνια*: *συ*, with, and *φωνη*, voice.] 1. A consonance or harmony of sounds, agreeable to the ear, whether the sounds are vocal or instrumental, or both.

The trumpets sound,

And warlike *sympphony* is heard around.

*Dryden.*

2. An ancient musical instrument, supposed by some to be of the lyre kind, and by others a sort of drum, used as an accompaniment.—3. In *modern usage*, a musical composition for a full band of instruments, and formerly

called an overture. It generally consists of four movements; a brilliant allegro, which is commonly preceded by a short, serious, slow introductory movement; an andante varied, or an expressive adagio; a minuet with its trio; and a finale of rapid motion. The term *sympphony* is also applied to an instrumental passage which usually introduces a piece of vocal music, or is brought in at the close, or occurs during some pause of the voice. Haydn, Mozart, and Beethoven, are the greatest modern composers of symphonies.

**SYMPHORICAR'POS**, } *n.* A genus of  
**SYMPHO'RIA**, } plants, nat.  
order Caprifoliaceæ, the species of which are natives of North and South America. They are elegant bushy shrubs, with small white or rose-coloured flowers. *S. vulgaris* is known by the name of common St. Peter's wort, and *S. racemosus* by that of snow-berry. This latter has become very common in our gardens.

**SYMPHYSIS**, *n.* [Gr. *συμφυσις*: *συ*, together, and *φυω*, to grow.] 1. In *anat.*, the union of bones by cartilage; a connection of bones without a movable joint.—2. In *sur.*, a coalescence of a natural passage; also, the first intention of cure in a wound.

**SYMPHY'TUM**, *n.* A genus of plants, nat. order Boraginaceæ. The species are rough herbaceous plants, with broad leaves and terminal twin racemes of flowers. They inhabit chiefly Europe and Asia. *S. officinalis*, or common comfrey, is found in Britain on the banks of rivers and ditches. Its root abounds in a mucilage, which is useful in irritations of the throat, intestines, and bladder. There are several other species.

**SYMPELO'METER**, *n.* [Gr. *συμμετρον*, to compress, and *μετρον*, measure.] A kind of barometer, contrived by Mr. Adie of Edinburgh, for measuring the weight of the atmosphere by the compression of a column of gas. It consists of a glass tube about 18 inches long, having the lower end bent up like the tube of the wheel barometer, each end being terminated by an elongated bulb. The upper end is hermetically sealed, but the lower end is left open. The upper part of the tube is filled with hydrogen gas, and the lower part with some fixed oil. The pressure of the atmosphere is exerted upon the surface of the oil, which is exposed to it in the turned up open end of the tube. This pressure causes the oil to stand at a certain height in the tube, and to produce a certain compression in the column of hydrogen gas. As the atmospheric pressure becomes greater, the oil will rise, and the gas will be compressed into less space. The change in the bulk of the gas caused by a change in the atmospheric pressure is measured by a scale. The *sympiesometer* is a useful instrument, but inferior in accuracy to the common barometer.

**SYMPLESITE**, *n.* In *min.*, a mineral of an indigo colour.

**SYMPLOCAR'POS**, *n.* A genus of plants belonging to the nat. order Araceæ. The *S. fetida*, skunk cabbage, is a powerful antispasmodic, and also an expectorant. It has a considerable reputation in North America as a palliative in paroxysms of asthma.

**SYMPLOCE**, *n.* [Gr. *συμπλοκη*: from *συ*, together, and *πλοκη*, a twisting or

folding.] In *rhet.*, a figure where several sentences or clauses have the same beginning and the same end.

**SYMPLOCOS**, *n.* A genus of plants belonging to the nat. order Styracææ. The species are trees inhabiting North and South America, and tropical Asia. They all possess an astringent principle in their leaves, and some, as *S. tinctoria*, dyer's *symplocos*, sweet leaf or yellow leaf, are used in dyeing.

**SYMPO'SIA**, *n. plur.* [συμπόσιον, a feast.] The feasts of the ancient Greeks.

**SYMPOSIAC**, *a.* (*sympo'ziac*.) [Gr. *συμπωσια*, a drinking together; *συ*, together, and *πινω*, to drink.] Pertaining to computations and merry-making; happening where company is drinking together; as, *symposiac* meetings.

*Symposiac* disputations. [Not much used.] *Arbutnot.*

**SYMPO'SIAC**, *n.* A conference or conversation of philosophers at a banquet.

**SYMPO'SIARCH**, *n.* [Gr. *συμπωσιω*, a feast, and *αρχης*, a ruler.] In *antiquity*, the director or manager of a feast, who was sometimes appointed by the person at whose charge the entertainment was made, or selected by the suffrages of the party.

**SYMPOS'IAST**, *n.* One who drinks or makes merry with others.

**SYMPOSIUM**, *n.* (*sympo'zium*.) [supra.] A drinking together; a merry feast.—2. A banquet among philosophers.

**SYMPTOM**, *n.* [Fr. *symptome*; Gr. *συμπτωσια*, a falling or accident, from *συ*, with, and *πτωω*, to fall.] 1. Properly, something that happens in concurrence with another thing, as an attendant. Hence in *med.*, any affection which accompanies disease; a perceptible change in the body or its functions, which indicates disease. The causes of disease often lie beyond our sight, but we learn the nature of them by the *symptoms*. Particular *symptoms*, which more uniformly accompany a morbid state of the body, and are characteristic of it, are called *pathognomonic*, or *diagnostic symptoms*. Symptoms are best divided into *essential*, which are peculiar to certain diseases; *accidental*, produced by some circumstance of unusual occurrence; and *common*, which are met with alike in various complaints.—2. A sign or token; that which indicates the existence of something else; as, open murmurs of the people are a *symptom* of disaffection to law or government.

**SYMPTOMATIC**, } *a.* Pertaining  
**SYMPTOMATIC**, } to symptoms;  
happening in concurrence with something; indicating the existence of something else.—2. In *med.*, a *symptomatic* disease is one which proceeds from some prior disorder in some part of the body. Thus a *symptomatic* fever may proceed from local injury or local inflammation. It is opposed to *idiopathic*.—3. According to symptoms; as, a *symptomatical* classification of diseases.

**SYMPTOMATICALLY**, *adv.* By means of symptoms; in the nature of symptoms.

**SYMPTOMATO'L'OGY**, *n.* [Gr. *συμπτωσια*, and *λογος*, discourse.] The doctrine of symptoms; that part of the science of medicine which treats of the symptoms of diseases.

**SYN**, A Greek preposition or prefix (*συν*), corresponding to the Latin prefix *con*, and signifying with, together, a uniting, a joining or agreeing. Before

certain consonants it is changed into *syll*, *sym*, &c., and sometimes the final consonant is dropped.

**SYNÆRESIS**, *n.* [Gr. *συναίρεσις*.] In *gram.*, the contraction of two syllables or two vowels into one, by suppressing one of the syllables, or by the formation of a diphthong; as, *nēr* for *never*, *Atrides* for *Atréides*.

**SYNAGOG'ICAL**, *a.* [from *synagogue*.] Pertaining to a synagogue.

**SYNAGOGUE**, *n.* (syn'agog.) [Fr. from Gr. *συναγωγή*: *συν*, together, and *αγωγή*, to drive; properly an assembly.] 1. A congregation or assembly of Jews, met for the purpose of worship or the performance of religious rites.—2. The house appropriated to the religious worship of the Jews. Authors are not agreed about the time when the Jews first began to have synagogues. Some suppose them as old as the ceremonial law, and others fix their beginning after the return of the Jews from the Babylonish captivity. Synagogues were erected not only in towns and cities, but also in the country, especially near rivers, that they might have water for their purifications and ceremonies. Jerusalem is said to have contained 480 synagogues. The synagogue was governed by a council or assembly, over whom was a president called the ruler of the synagogue. The service consisted of prayers, reading the Scriptures, and preaching and expounding of them. The chief ruler, or one of the council, gave permission to read and expound the law, and appointed who should do it. The synagogue service was at first confined to the Sabbath days and festivals, but was latterly extended to Mondays and Thursdays.—3. The court of the seventy elders among the Jews, called the great synagogue or sanhedrim.

**SYN'AGRIS**, *n.* A fish caught in the Archipelago, resembling the dentex. It has a sharp back, and is reckoned a species of Sparus.

**SYNALE'PHA**, } *n.* [Gr. *συναλοιφή*.]  
**SYNALE'PHA**, } In *gram.*, a contraction of syllables by suppressing some vowel or diphthong at the end of a word, before another vowel or diphthong; as, *he'll run*, for *he will run*.

**SYNALLAGMATIC**, *a.* In *civil law*, an epithet applied to a contract imposing reciprocal obligations.

**SYNAN'THEROUS**, *a.* In *bot.*, a name applied to syngenesian or composite plants, with the anthers united so as to form a tube round the style.

**SYNAPTASE**, *n.* In *chem.*, a peculiar compound discovered in certain oily seeds, as in almonds, and named emulsine by Wohler and Liebig.

**SYN'ARCHY**, *n.* [Gr. *συναρχία*.] Joint rule or sovereignty.

**SYNARTHROSIS**, *n.* [Gr. *συν*, with, and *αρθρωσις*, to articulate.] Union of bones without motion; close union; as in sutures, symphysis, and the like.

**SYNAX'IS**, *n.* [Gr., from *συναγωγή*, to congregate; *συν*, with, and *αγωγή*.] A congregation; also, a term formerly used for the Lord's supper.

**SYNCARPOUS**, *a.* [Gr. *συν*, and *καρπός*, fruit.] In *bot.*, having the carpels of a compound fruit completely united; as in the apple and pear.

**SYNCATEGORYEMATIC**, *n.* In *logic*, a word which cannot be used as a term by itself; as an adverb or preposition.

**SYNCHONDROSIS**, *n.* [Gr. *συν*, and *χόνδρος*, cartilage.] The connection of

bones by means of cartilage or gristle, as in the vertebræ.

**SYNCHORE'SIS**, *n.* [Gr. *συνχρησις*, concession.] In *rhet.*, a figure wherein an argument is scoffingly conceded, for the purpose of retorting more pointedly.

**SYN'CHRONAL**, *a.* [Gr. *συν*, with, and *χρονος*, time.] Happening at the same time; simultaneous.

**SYN'CHRONAL**, *n.* [supra.] That which happens at the same time with something else, or pertains to the same time.

**SYNCHRON'ICAL**, *a.* [See **SYNCHRONISM**.] Happening at the same time; simultaneous.

**SYNCHRON'ICALLY**, *adv.* In a synchronical manner.

**SYN'CHRONISM**, *n.* [Gr. *συν*, with, and *χρονος*, time.] Concurrence of two or more events in time; simultaneousness.—2. A tabular arrangement of history by which contemporary persons and things in different countries are brought together.

**SYNCHRONIS'TIC**, *a.* Synchronous; pertaining to synchronism; as, *synchronistic tables*.

**SYNCHRONIZA'TION**, *n.* The concurrence of events in respect of time.

**SYN'CHRONIZE**, *v. i.* To concur at the same time; to agree in time.

**SYNCHRONO'LOGY**, *n.* Knowledge of, or reference to, contemporaneous events or things.

**SYN'CHRONOUS**, *a.* Happening at the same time; simultaneous.

**SYN'CHRONOUSLY**, *adv.* [supra.] At the same time.

**SYN'CHYSIS**, *n.* [Gr. *συν* and *χυσω*.] Confusion; derangement; confusion of words in a sentence; derangement of humours in the eye.

**SYN'CIPTU**, *n.* Sinciput,—*which see*.

**SYNCLINAL LINE OR AXIS**. [Gr. *συνκλίσις*, to bend down.] In *geol.*, where the strata dip downward in opposite directions, as in a valley, the imaginary line of their junction towards which the strata on each side descend, is called the *synclinal line* or *axis*, in opposition to *anticlinal line* or *axis*. [See **ANTICLINAL**.]

**SYN'COPE**, *v. t.* [See **SYNCOPE**.] To contract, as a word, by taking one or more letters or syllables from the middle.—2. In *music*, to prolong a note begun on the unaccented part of a bar, to the accented part of the next bar; or to connect the last note of a bar with the first of the following; or to end a note in one part, in the middle of a note of another part.

**SYN'COPE**, *pp.* Contracted by the loss of a letter from the middle of the word.—2. Inverted, as the measure in music.

**SYN'COPE**, *pp.* Contracting by the loss of a letter in the middle of a word.

**SYNCOPEA'TION**, *n.* The contraction of a word by taking a letter, letters, or a syllable from the middle.—2. In *music*, an interruption of the regular measure; an inversion of the order of notes; a prolonging of a note begun on the unaccented part of a bar, to the accented part of the next bar; also, a driving note, when a shorter note at the beginning of a measure is followed by two or more longer notes before another short note occurs, equal to that which occasioned the driving, to make the number even.

**SYN'COPE**, *n.* [Gr. *συνκοπή*, from *σύνκοπος*: *συν*, and *κόπτω*, to cut off.] 1. In

*music*, the same as *syncope*; the division of a note introduced when two or more notes of one part answer to a single note of another.—2. In *gram.*, an elision or retrenchment of one or more letters or a syllable from the middle of a word.—3. In *med.*, a fainting or swooning; a diminution or interruption of the motion of the heart, and of respiration, accompanied with a suspension of the action of the brain and a temporary loss of sensation, volition, and other faculties.

**SYN'COPIST**, *n.* One who contracts words.

**SYN'COPIZE**, *v. t.* To contract by the omission of a letter or syllable.

**SYN'CRATISM**, *n.* Syncretism,—*which see*.

**SYN'CRETISM**, *n.* [Gr. *συνκρησις*.] In *philosophy*, the blending of the tenets of different schools into one system, so as to produce a union among different sects.—2. In *religion*, a comprehensive scheme of Christian doctrines designed to unite different religious parties or sects.

**SYNCRETIS'TIC**, *a.* Pertaining to the Syncretists.

**SYN'CRETISTS**, *n.* In *eccles. history*, the followers of Callixtus, a Lutheran divine, and professor of theology at Helmstädt, who, about the beginning of the 17th century, endeavoured to frame a religious system which should unite together the different professors of Christianity.

**SYN'CRISIS**, *n.* In *rhet.*, a figure by which opposite things or persons are compared.

**SYNDACTYLES**, *n.* [Gr. *συν*, and *δακτύλος*, a finger or toe.] A group of perching birds, including those which have the external toe nearly as long as the middle one, and united to it as far as the second joint. This group contains the bee-eaters, motmots, kingfishers, todies, and hornbills.

**SYNDACTYLIC**, } *a.* Having the  
**SYNDACTYLOUS**, } characteristics of the syndactyles.

**SYNDESMO'SIS**, *n.* [Gr. *συνδεσμος*, a ligament.] A species of symphysis, or mediate connection of bones, in which they are united by ligament; as the radius with the ulna.

**SYN'DIC**, *n.* [L. *syndicus*; Gr. *συνδικος*: *συν*, with, and *δικη*, justice.] An officer of government, invested with different powers in different countries; a kind of magistrate intrusted with the affairs of a city or community. In Geneva, the *syndic* was the chief magistrate. Almost all the companies in Paris, the university, &c., had their *syndics*. The university of Cambridge has its *syndics*.

**SYN'DICATE**, *n.* In some countries on the European Continent, a council; a branch of government.

**SYN'DICATE**, *v. t.* To judge, or to censure.

**SYN'DROME**, *n.* [Gr. *σύνδρομη*, a running together.] 1. Concurrence.—2. In *med.*, the concurrence or combination of symptoms in a disease.

**SYNEC'DOCHE**, *n.* [Gr. *συνεκδοχή*: *συν* and *εκδοχή*, to take.] In *rhet.*, a figure or trope by which the whole of a thing is put for a part, or a part for the whole; as the genus for the species, or the species for the genus, &c.

**SYNECDOCH'ICAL**, *a.* Expressed by *synecdoche*; implying a *synecdoche*.

**SYNECDOCH'ICALLY**, *adv.* According to the *synecdochical* mode of speaking.



**SYNE'CHIA**, *n.* [Gr. *συνεχία*, continuity; adherence.] A concretion of the iris with the cornea, or with the capsule of the crystalline lens.

**SYNECPHON'E'SIS**, *n.* [Gr.] A contraction of two syllables into one.

**SYN'EPY**, *n.* [Gr. *συνεπία*, union of sounds.] The interjunction of words in uttering the clauses of sentences.

**SYNERGET'IC**, } *a.* Coöperating.

**SYNERGIST'IC**, }  
**SYNERGISTS**, *n.* [Gr. *συνεργιστάς*, coöperation.] A party in the Lutheran church, who, about the end of the 16th century, denied that God was the sole agent in the conversion of sinners, and affirmed that man coöperated with divine grace in the accomplishment of this work.

**SYNGENE'SIA**, *n.* [Gr. *σύν*, with, and *γενεή*, generation.] The name of the nineteenth class of plants in the sexual system of Linnæus, consisting of those plants of which the anthers are united



Syngenesia (Senecio Jacobææ).

1. Floret magnified. 2. Section of floret magnified.

into a tube, the filaments on which they are supported being mostly separate and distinct. The flowers are compound. There are five orders, namely, *Polygamia equalis*, *Polygamia superflua*, *Polygamia frustranea*, *Polygamia necessaria*, and *Polygamia segregata*. The thistle, tansy, daisy, southernwood, sunflower, and marigold, are examples.

**SYNGENE'SIAN**, } *a.* Pertaining to  
**SYNGENE'SIOUS**, } the class Syngenesia.

**SYNGNA'THA**, *n.* [Gr. *σύν*, with, and *γεννάω*, a jaw.] The name given by Dr. Leach to an order of insects, belonging to the class Myriapoda, comprehending the species of that class which were included by Linnæus under the head Scolopendra.

**SYNGNA'THIANS**, *n.* A family of fishes belonging to the order Lophobranchii, characterized by having the mouth drawn out into a sort of tube or pipe. The type of the family is the genus *Syngnathus*, or pipe-fish.

**SYNGRAPH**, } *n.* [Gr. *σύν* and *γραφω*.]  
**SYNGRAPHIA**, } A writing signed by both parties to a contract or bond.

**SYNIZE'SIS**, *n.* [Gr. *συνίζω*, to meet.] A closed pupil; an obliteration of the pupil of the eye, causing a total loss of vision.

**SYNNEURO'SIS**, *n.* [Gr. *σύν* and *νεύρον*, a nerve.] In *anat.*, the connection of parts by means of ligaments, as in the movable joints.

**SYN'OCHA**, *n.* [Gr.] A simple continuous phlogistic fever, not becoming atonic or asthenic, in its course and progress.

**SYN'OCHUS**, *n.* [Gr.] A simple continuous fever, commonly said to be

phlogistic in its early stage, and atonic or asthenic in its progress; a mixed fever.

**SYN'OD**, *n.* [Gr. *συνόδος*, a convention, *σύν* and *ἄδω*, way.] 1. In *church history*, a council or meeting of ecclesiastics to consult on matters of religion. Synods are of four kinds, 1. *General* or *ecumenical*, which are composed of bishops from different nations. 2. *National*, in which the bishops of one nation only meet, to determine points of doctrine or discipline. 3. *Provincial*, in which the bishops of one province only meet. This is called a convocation. 4. *Diocesan*. In the established church of Scotland, a provincial synod is one of the church courts, composed of the several presbyteries within the bounds prescribed by the general assembly, or of the ministers and elders who stand on the roll as constituent members of such presbyteries. The synod is a court of review immediately above the presbytery. Its meetings are generally held twice a year, though in some remote districts only once. Every ecclesiastical question which has been under the consideration of a presbytery within the provincial district, may be competently brought under the review of the synod. It has, besides, an original jurisdiction, as well on subjects of general interest, as with regard to the conduct of its own members, and can both give authoritative directions to the presbyteries, and originate propositions to the general assembly on any subject which seems to require its influence or authority. On the other hand, every judgment of a synod as an inferior court, may be brought under the review of the general assembly by reference, complaint, or appeal. But in every question, not carried to the general assembly, the judgment of the synod (if it has not gone beyond its jurisdiction) is final. Synods whose boundaries are contiguous correspond with one another, by sending one minister and one elder, who are entitled to sit and vote with the other members of the synod to which they are sent. The number of synods is sixteen. The synod is opened by the moderator of the preceding synod, and after the roll is made up, a new moderator, who must be a minister, is elected. Other presbyterian bodies have synods, which are similarly constituted. The convocations of the English clergy are provincial synods, but they have virtually expired.—2. A meeting, convention, or council; as, a *synod* of gods.

Let us call to *synod* all the best. *Milton*.

3. In *astron.*, a conjunction of two or more planets or stars in the same optical place of the heavens.

**SYN'ODAL**, *n.* Anciently, a pecuniary rent, paid to the bishop or archdeacon at the time of his Easter visitation, by every parish priest; a procuration.

*Synodals* are due of common right to the bishop only. *Gibson*.

2. Constitutions made in provincial or diocesan synods, are sometimes called *synodals*.

**SYN'ODAL**, } *a.* Pertaining to a  
**SYNOD'IC**, } synod; transacted in  
**SYNOD'ICAL**, } a synod; as, *synodical*  
 proceedings or forms; a *synodical*  
 epistle.—*Synodical month*, in *astron.*,  
 is the period from one conjunction of

the moon with the sun to another. This is called also a *lunation*, because in the course of it the moon exhibits all its phases. This month consists of 29 days, 12 hours, 44 minutes, 2'37 seconds.—*Synodic revolution of a planet*, with respect to the sun, is the period which elapses between two consecutive conjunctions or oppositions. The duration of this period is easily determined when the difference between the mean motion of the planet and sun, in a given interval of time, is known; for this difference is to 360° as the given interval to the synodic revolution.

**SYNOD'ICALLY**, *adv.* By the authority of a synod.

**SYNOM'OSY**, *n.* [Gr. *συνωμοσία*: *σύν*, with, and *ὁμωμι*, to swear.] Sworn brotherhood; a society in ancient Greece, nearly resembling a modern political club.

**SYNONYMA**, *n. plur.* Words having the same signification. But *synonyms* is a regular English word.

**SYNONYMAL**, } *a.* Synonymous.

**SYNONYMALLY**, } *adv.* Synonymously.

**SYN'ONYME**, } *n.* [Gr. *συνωνυμία*: *σύν*,  
**SYN'ONYM**, } with, and *ὄνομα*, name.] A name, noun, or other word having the same signification as another, is its *synonym*. Thus valour and courage, are regarded as synonyms; so also, virtue and goodness; vice and wickedness. Strictly speaking, words having exactly the same signification do not exist in any language. Different dialects of the same language may indeed have different words of the same meaning, but as soon as these pass from the dialect into the literary or generally adopted language, they either take the place of some other word of the same signification, or receive themselves a new shade of meaning, and are then added to the others. Still, it is true, that the similarity in the meaning of words is often so great, that much discrimination is required to ascertain the different shade of each word. Such words may be frequently used for one another, and this interchange produces a pleasing variety in composition, and is necessary in poetry. Synonyms form an important object of philological study, and demand, on the part of the inquirer, great knowledge of the principles of language. Blair, Booth, and Crabb have written on English synonyms.

He has extricated the *synonyms* of former authors. *Coxe's Russ.*

**SYNONYMI'ST**, *n.* One who synonymizes. Specially, among *botanists*, a person who collects the different names or synonyms of plants, and reduces them to one another.

**SYNONYMI'ZE**, *v. t.* To express the same meaning in different words.

**SYNONYMI'ZED**, *pp.* Expressed in different words.

**SYNONYMI'ZING**, *ppr.* Expressing the same thing in different words.

**SYNONYMOUS**, *a.* Expressing the same thing; conveying the same idea. We rarely find two words precisely *synonymous*. *Wave* and *billow* are sometimes *synonymous*, but not always. When we speak of the large rolling swell of the sea, we may call it a *wave* or a *billow*; but when we speak of the small swell of a pond, we may call it a *wave*, but we may not call it a *billow*.

**SYNONYMOUSLY**, *adv.* In a synonymous manner; in the same sense; with the same meaning. Two words may be used *synonymously* in some cases and not in others.

**SYNONYMY**, *n.* The quality of expressing the same meaning by different words.—2. In *rhet.*, a figure by which synonymous words are used to amplify a discourse.

**SYNOPSIS**, *n.* [Gr. *σύνολος*: *σύν*, with, and *ολος*, view.] A general view, or a collection of things or parts so arranged as to exhibit the whole or the principal parts in a general view.

**SYNOPTIC**, } *a.* Affording a general view of the whole, or of the principal parts of a thing; as, a *synoptic table*.

**SYNOPTICALLY**, *adv.* In such a manner as to present a general view in a short compass.

**SYNORHIZOUS**, *a.* [Gr. *σύν*, with, and *ρίζα*, a root.] *Synorhizous plants* are those of which the seeds have the point of the radicle incorporated with the albumen; as the pines, firs, conifera, and other polycotyledonous plants.

**SYNOVIA**, *n.* [Gr. *σύν*, with, and *ὄστρον*, an egg.] In *anat.*, the fluid secreted into the cavities of joints, for the purpose of lubricating them, and to facilitate their motions. It is glairy, and resembles the white of an egg; hence the name.

**SYNOVIAL**, *a.* [supra.] Pertaining to synovia; secreting a lubricating fluid; as, the *synovial membrane*; *synovial gland*.

**SYNTACTIC**, } *a.* [See **SYNTAX**.]  
**SYNTACTICAL**, } Pertaining to syntax, or the construction of sentences.

—2. According to the rules of syntax or construction.

**SYNTACTICALLY**, *adv.* In conformity to syntax.

**SYNTAX**, } *n.* [L. *syntaxis*; Gr. *σύνταξις*, together, and *τάσσειν*, to put.] 1. In *gram.*, the construction of sentences, the due arrangement of words and sentences, according to established usage. Syntax includes concord and regimen, or the agreement and government of words. Words, in every language, have certain connections and relations, as verbs and adjectives with nouns, which relations must be observed in the formation of sentences. A gross violation of the rules of syntax is a *solecism*.—2. † Connected system or order; union of sentences.

**SYNTERE'SIS**, *n.* [Gr. *σύν* and *τέρεσις*.] Remorse of conscience.

**SYNTERETIC**, *a.* Preserving health.

**SYNTETIC**, *a.* Wasting with consumption.

**SYNTEX'IS**, *n.* [Gr.] A deep consumption.

**SYNTHESIS**, *n.* [Gr. *σύνθεσις*: *σύν*, and *τίθημι*, to put or set.] 1. Composition, or the putting of two or more things together, as in compound medicines.—2. In *logic*, composition, or that process of reasoning in which we advance by a regular chain from principles before established or assumed, and propositions already proved, till we arrive at the conclusion. Synthesis is also called the direct method or *composition*, and is the reverse of *analysis* or *resolution*. It is the method followed in Euclid's Elements of Geometry, and most demonstrations of the ancient mathematicians, which proceed from definitions and axioms, to

prove propositions, &c., and from those propositions proved, to prove others. Synthesis and analysis are much blended together in the exact sciences, and it may be doubted whether pure synthesis or pure analysis exists in large quantities, in an unmixed state in any science whatever. [See **ANALYSIS**.]—3. In *sur.*, the operation by which divided parts are united.—4. In *chem.*, the uniting of elements into a compound; the opposite of *analysis*, which is the separation of a compound into its constituent parts. That water is composed of oxygen and hydrogen, is proved both by analysis and *synthesis*. The terms *synthesis* and *analysis* in chemistry are synonymous with *composition* or *combination*, and *decomposition*.

**SYNTHETIC**, } *a.* Pertaining to  
**SYNTHETICAL**, } synthesis; consisting in synthesis or composition; as, the *synthetic method* of reasoning, as opposed to the *analytical*.

**SYNTHETICALLY**, *adv.* By synthesis; by composition.

**SYNTHETIZE**, *v. t.* To unite in regular structure. [Not much used.]

**SYNTOMY**, *n.* [Gr. *σύντομία*.] Brevity; conciseness.

**SYNTONIC**, *a.* [Gr. *σύν*, with, and *τόνος*, tone.] In *music*, sharp; intense.

**SYIPHERING**, *n.* In *ship-building*, the lapping of the edge of one plank over the edge of another in constructing the bulk-heads.

**SYPHILIS**, *n.* [A term coined by Fracastorius, and introduced into nosology by Sauvages. Its etymology is unknown.] *Lues venerea*, or the venereal disease, a disease characterized by ulcers of a peculiar character on the genitals, succeeded by inguinal buboes. So far, the disease is local. The indications of a constitutional affection are ulcers in the throat, copper-coloured eruptions on the skin, pains in the bones, nodes, &c. This malady is exclusively contagious.

**SYPHILITIC**, *a.* Pertaining to syphilis.  
**SYPHILOID**, *a.* [syphilis, and Gr. *ειδής*, resemblance.] Resembling syphilis; as, *siphiloid affections*.

**SYPHON**, *n.* [Gr. *σίφων*.] A tube or pipe. More correctly *Siphon*,—*which see*.

**SYREN**. See **SIREN**.

**SYRIA**, *n.* The language of Syria, especially the ancient language of that country. It differs very little from the Chaldee or Eastern Aramaic.

**SYRIAC**, *a.* [from *Syria*.] Pertaining to Syria, or its language; as, the *Syriac version* of the Pentateuch; *Syriac Bible*.

**SYRIACISM**, *n.* A Syrian idiom.

**SYRIAN**, *a.* Pertaining to Syria.

**SYRIAN**, *n.* A native or inhabitant of Syria.

**SYRIANISM**, *n.* A Syrian idiom, or a peculiarity in the Syrian language.

**SYRIASM**, *n.* The same as *Syrianism*.

**SYRINGA**, *n.* [Gr. *συγίξ*, *συγγίξ*, a pipe.] The lilac, a genus of plants, nat. order Oleaceæ. The species are deciduous shrubs, natives of Europe, and the colder parts of Asia. The leaves are simple, the flowers are purple or white, very fragrant, and arranged in thyrsoid terminal panicles.—*S. vulgaris*, the common lilac, is one of the commonest ornaments of our shrubberies, blossoming together with the laburnum in May. [See **LILAC**.] Other species are, *S. josihea*, the

Josikas lilac, a native of Transylvania; *S. persica*, the Persian lilac; *S. chinensis*, the Chinese lilac; *S. emodi*, a native of Kumaon, near the Himalaya; and *S. villosa*, found on mountains about Pekin in China. The name syringa is improperly applied to the species of Philadelphus or Mock-orange.

**SYRINGE**, *n.* (syr'inj.) [supra.] A portable hydraulic instrument of the pump kind, commonly employed to draw in a quantity of water or other fluid, and to squirt or eject the same with violence. In its simplest form it consists of a small cylindrical tube with an air-tight piston or sucker, to the rod of which a ring or other convenient handle is attached. The lower end of the cylinder terminates in a small tube, which being immersed in any fluid, and the piston then drawn up, the fluid is forced into the body of the cylinder by the atmospheric pressure. By pushing back the piston to the bottom of the cylinder, the contained fluid is expelled in a small jet, and with a force proportioned to the power applied to the piston. The syringe acts on the principle of the sucking pump, and is used by surgeons, &c., for washing wounds, for injecting fluids into animal bodies, and other purposes. It is also employed as a pneumatic machine for condensing or exhausting the air in a close vessel, but for this purpose two valves are necessary. In the condensing syringe the valves open downwards and close upwards; but in the exhausting syringe they open upwards, and close downwards, as in the common air-pump.

**SYRINGE**, *v. t.* To inject by means of a pipe or syringe; to wash and cleanse by injections from a syringe.

**SYRINGED**, *pp.* Injected by means of a pipe or syringe.

**SYRINGODEA**, *n.* A genus of plants, nat. order Ericaceæ. The species are natives of the Cape of Good Hope; they are erect shrubs, with loose leaves and large showy flowers, which are crowded at the tops of the branches on every side, and form a spike-like inflorescence. In their cultivation they are treated the same way as heaths.

**SYRINGODENDRON**, *n.* [Gr. *συγγίξ*, a pipe, and *δένδρον*, a tree.] The name given by Count Sternberg to many species of Sigillaria, (a genus of extinct fossil trees), on account of the parallel pipe-shaped flutings, which extend from the top to the bottom of their trunks. These trunks are without joints, and many of them attain the size of forest trees.

**SYRINGOTOMY**, *n.* [Gr. *συγγίξ*, a pipe, and *τομή*, to cut.] The operation of cutting for the fistula.

**SYRIX**, *n.* [Gr. *συγγίξ*, a pipe.] In *sur.*, a fistula.—2. In *music*, a wind instrument composed of reeds of different lengths, tied together. It is also known by the name of *Pandean pipes*, its invention having been ascribed to Pan.

**SYRMA**, *n.* [Gr.] A long dress, reaching to the ground, worn by tragic actors.

**SYRPHIDÆ**, *n.* A family of dipterous insects of the section Brachystoma of Macqart. The species frequent flowers and woods. Some of them inhabit the nests of the humble bees, to which they bear a striking resem-

blance. The genus *syrphus* is the type of the family.

**SYRT**, *n.* [*L. syrtis*.] A quicksand; a bog.

**SYRTIC**, *a.* Relating to a syrt; sandy; boggy.

**SYRTIS**, *n. plur. Syrtēs.* [*L.*] A quicksand. [*Not English.*] The Greeks and Romans gave the name *syrtēs* to the two gulfs on the northern coast of Africa, one of which they called *Syrtis major*, and the other *Syrtis minor*. Both were the terror of the ancient mariners from their drawing in ships, and swallowing them up in their sandy shoals. The greater syrtis is now called the gulf of Sidra, and the lesser the gulf of Khabs.

**SYR'UP**, or **SIR'UP**, *n.* [*Fr. syrop*; *Low L. sirupus*, or *syrupus*; from *Gr. συριος σιρος, succus syriacus*, because the use of syrups originated with the Syrians. But perhaps the word is derived from Arab. *sirab*, a drink, a potion, a medicated drink; *Ar. sherāb*, a beverage; *sharābah*, a draught.] Syrups are medicinal solutions of sugar, either in water alone, as in simple syrup, or in liquids charged with some peculiar principle of an active kind, such as senna or buckthorn, or merely grateful from their colour or fragrance, or both; such as syrup of violets. There is almost an endless variety of syrups, but few of them possess medicinal properties to any important extent.

**SYR'UPED**, or **SIR'UPED**, *a.* Moistened or tinged with syrup.

**SYR'UPY**, or **SIR'UPY**, *a.* Like syrup, or partaking of its qualities.

**SYSSARCO'SIS**, *n.* [*Gr. συρ, with, and σαξ, flesh.*] A species of union of bones, in which one bone is united to another by means of an intervening muscle.

**SYSTAL'TIC**, *a.* In *med.*, having alternate contraction and dilatation.

**SYST'ASIS**, *n.* [*Gr. συστασις.*] The consistence of a thing; constitution. [*Little used.*]

**SYSTEM**, *n.* [*Fr. système*; *L. systema*; *Gr. συστημα: συν andστημα, to set.*] 1. Any combination of things acting together; an assemblage of things adjusted into a regular whole; or a whole plan or scheme consisting of many parts connected in such a manner as to create a chain of mutual dependences; or a regular union of principles or parts forming one entire thing; or an assemblage of facts, or of principles and conclusions scientifically arranged, or disposed according to certain mutual relations, so as to form a complete whole. Thus we say, a *system* of logic, a *system* of philosophy, a *system* of government, a *system* of principles, the solar *system*, the Copernican *system*, a *system* of divinity, a *system* of law, a *system* of morality, a *system* of husbandry, a *system* of botany or of chemistry. *System* is sometimes nearly synonymous with *classification*, and sometimes with *hypothesis* or *theory*. Thus we speak of a *mythological system*, or a *chronological system*, in the historical sciences; of a *botanical system*, or a *mineralogical system*, in natural science; and of the Copernican, Ptolemaic, or Tychoenic *system*, in astronomy. The purpose of a *system* is to classify the individual subjects of our knowledge in such a way as to enable us readily to retain and employ them, and at the same time to illustrate each by showing its connection with all. The constituent

parts of a *system* are a fundamental principle which serves as a basis for the whole, and a large collection of facts, from which the various laws are to be deduced, which themselves all flow together into the common principle.—2. Regular method or order.—3. In *astron.*, any hypothesis or theory of the disposition and arrangements of the heavenly bodies, by which their phenomena, their motions, changes, &c., are explained. When such a theory embraces only the sun and the planetary bodies connected with him, it is termed the *solar* or *planetary system*; but when it embraces the fixed stars also, or the whole material creation generally, it is termed a *system of the universe*, or of the *world*. The most celebrated systems of the world are the following:—1. The *Ptolemaic system*, framed by the Greek astronomer Ptolemy. According to this system, the earth is an absolutely fixed centre, and the heavens are considered as revolving about it from east to west, and carrying along with them all the heavenly bodies, the stars and planets, in the space of twenty-four hours. 2. The *Copernican system*, taught by Copernicus in the beginning of the 16th century. According to this system, the sun is supposed to be at rest in the centre of the universe, and the earth and the several planets to revolve about him as a centre, while the moon and the other satellites revolve about their primaries in the same manner. The heavens and fixed stars are here supposed to be at rest, and their apparent diurnal motions are imputed to the earth's motion from west to east. 3. The *Tychoenic system*, proposed by Tycho de Brahe, towards the latter end of the 16th century. According to this system, the sun is a centre of motion to all the planets which revolve round it, while the sun and planetary orbits are carried together round the earth as a fixed centre. 4. The *Newtonian system*, so named as being adopted by Sir Isaac Newton. In this system there is no fixed centre, the sun only approximating to that character from its greater magnitude. The orbits of the planets, which all revolve round the sun, are approximately represented by ellipses, exactly by ellipses of which the elements vary. The Newtonian system, which is the only one admitted in modern astronomy, is frequently called the Copernican, from its rejecting what Copernicus rejected, but it is far from receiving all that Copernicus received. The term *system* is frequently applied to the subdivisions of the solar system; thus we have the terrestrial, Jovial, Saturnian, Uranian systems.—4. In *anat.* and *phys.*, an assemblage of parts or organs which are essentially necessary to the performance of some animal function, as the absorbent *system*, the nervous *system*, the vascular *system*. The whole human body, as an assemblage of parts, is also often termed the *system*.—5. In the *fine arts*, a collection of the rules and principles upon which an artist works.—6. In *music*, an interval compounded or supposed to be compounded of several lesser intervals, as the fifth, octave, &c., the elements of which are called *diastems*.

**SYSTEMAT'IC**, } *a.* Pertaining to  
**SYSTEMAT'ICAL**, } system; consisting in system; methodical; formed

with regular connection and adaptation or subordination of parts to each other, and to the design of the whole; as a *systematic* arrangement of plants or animals; a *systematic* course of study.—2. Proceeding according to system or regular method; as, a *systematic* writer.

**SYSTEMAT'ICALLY**, *adv.* In the form of a system; methodically.

**SYSTEMAT'ISM**, *n.* Reduction of facts to a system.

**SYSTEMATIST**, *n.* One who forms a system, or reduces to system.

**SYSTEMATIZE**, or **SYSTEMIZE**, *v. t.* To reduce to system or regular method; as, to *systematize* the principles of moral philosophy; to *systematize* plants or fossils.

**SYSTEMATIZED**, } *pp.* Reduced to  
**SYSTEMIZED**, } system or method.

**SYSTEMATIZER**, } *n.* One who re-  
**SYSTEMIZER**, } duces things to system.

**SYSTEMATIZING**, } *ppr.* Reducing  
**SYSTEMIZING**, } to system or method.

**SYSTEMATOLO'GY**, *n.* A treatise or discourse on the various systems.

**SYSTEM'IC**, *a.* Pertaining to a system.—*Systemic circulation*, the circulation of the blood through the body generally, as distinguished from that other circulation which is confined to the respiratory organs and the heart, or the respiratory circulation.

**SYSTEM-MAKER**, *n.* One who forms a system.

**SYSTEM-MÖNGER**, *n.* One given to the forming of systems.

**SYS'TOLE**, *n.* [*Gr. συστολή, from συστέλλω, to contract; συν and στέλλω, to send.*] 1. In *gram.*, the shortening of a long syllable.—2. In *anat.*, the contraction of the heart and arteries, for expelling the blood, and carrying on the circulation. [*See* DIASTOLE.]

**SYSTOL'IC**, *a.* Relating to systole; contracting.

**SYS'TYLE**, *n.* [*Gr. συν, with or together, and στυλος, a column.*] In *arch.*, an intercolumniation of two diameters.

**SYTHE**. *See* SCYTHE.

**SYHEN'DEMAN**,† *n.* A man, in Anglo-Saxon times, worth six hundred shillings.

**SYZY'GIUM**, *n.* A genus of plants, nat. order Myrtaceæ. The species inhabit tropical countries; they are trees or shrubs of a highly ornamental appearance from their smooth shining leaves, which are opposite and entire.—*S. guineense*, which grows on the coast of Guinea and Senegal, has been employed as a remedy in rheumatism.—*S. jambolanum* is extensively cultivated in the East Indies on account of its edible fruit, sometimes called Java plum by Europeans, but Jamoon by the natives. It is of a rich purplish colour, but of a subastringent sweetish taste, which is more agreeable to the native than to the European palate. The bark is astringent, and dyes of a brown colour; the wood is hard and durable, and much employed.

**SYZ'YG'Y**, *n.* [*Gr. συζυγία: συν and ζυγω, to join.*] The conjunction or opposition of a planet with the sun, or of any two of the heavenly bodies. On the phenomena and circumstances of the *syzygies*, depends a great part of the lunar theory.—2. [*L. syzygia.*] In *gram.*, the coupling of different feet together in Greek or Latin verse.

T

T

TABBY

TABERNACLE

**T**, IS the twentieth letter of the English Alphabet, and a close consonant. It represents a close joining of the end of the tongue to the root of the upper teeth, as may be perceived by the syllable *at, et, ot, ut*, in attempting to pronounce which, the voice is completely intercepted. It is therefore numbered among the mutes, or close articulations, and it differs from *d* chiefly in its closeness; for in pronouncing *ad, ed*, we perceive the voice is not so suddenly and entirely intercepted, as in pronouncing *at and et*. *T* by itself has one sound only, as in *take, turn, bat, bolt, smite, bitter*. So we are accustomed to speak; but in reality, *t* can be hardly said to have any sound at all. Its use, like that of all mute articulations, is to modify the manner of uttering the vocal sound which precedes or follows it. When *t* is followed by *h*, as in *think* and *that*, the combination really forms a distinct sound for which we have no single character. This combination has two sounds in English; aspirated, as in *think*, and vocal, as in *that*. The letters *t*, before a vowel, and unaccented, usually pass into the sound of *sh*, as in *nation, motion, partial, substantiate*; which are pronounced *nashon, moshon, parsha!*, *substanshate*. In this case, *t* loses entirely its proper sound or use, and being blended with the subsequent letter, a new sound results from the combination, which is in fact a simple sound. In a few words, the combination of *ti* has the sound of the English *ch*, as in *Christian, mixtion, question*. *T* is convertible with *d*. Thus the Germans write *tag*, where we write *day*, and *gut*, for *good*. It is also convertible with *s* and *z*, for the Germans write *wasser*, for *water*, and *zahn*, for *tame*. *T*, as an abbreviation, stands for *theologia*; as, S. T. D. *sanctæ theologiae doctor*, doctor of divinity. In ancient monuments and writings, *T* is an abbreviation which stands for *Titus, Tilius, or Tullius*. As a numeral, *T*, among the Latins, stood for 100, and with a dash over the top, *T*, for 100,000. In *music*, *T* is the initial of tenor, vocal and instrumental; of *tacet*, for silence, as *adagio tacet*, when a person is to rest during the whole movement. In concertos and symphonies, it is the initial of *tutti*, the whole band, after a solo. It sometimes stands for *tr.* or *trillo*, a shake. — *T-bandage*, a bandage so named from its figure. It is principally used for supporting the dressings after the operation for fistula in the anus, in diseases of the perinæum, and those of the groin, anus, &c. — *T-square*, an instrument much used in drawing plans of architectural and mechanical objects. It consists simply of two slips of hard wood or mahogany, *a* and *b*, whose edges are dressed truly straight and parallel; the former, called the *blade*, is much thinner than the *stock*, *b*, into which one of its ex-

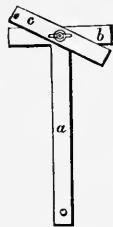

trimities is fixed firmly at right angles; consequently, when the stock is applied to the edges of a rectangular board on which the paper is stretched, a pen or pencil pressed tightly against the blade will trace straight lines parallel or at right angles to each other, as may be required. Sometimes a *shifting stock*, *c*, is also applied in the manner represented in the figure for the convenience of drawing oblique lines parallel to each other.

**TAB, n.** The latchet of a shoe fastened with a string, or otherwise. [*Local.*]  
—2. The end of a lace; a tag. [*Local.*]  
—3. A cap border, worn in the inside of a lady's bonnet.—4. A cup. [*Local.*]

**TABA'NIDÆ, n.** A family of dipterous insects. The genus *Tabanus*, which is the type of the family, comprehends the gad-flies.

**TABA'NUS, n.** The horse-fly or gad-fly.  
**TAB'ARD, n.** [Fr. *tabarre*, from *TAB'ERD, n.* [*tabardum*, low Latin.]  
**TAB'ERT, n.** An ancient close-fitting garment, open at the sides, with wide sleeves, or flaps, reaching to the elbows. It was worn over the body armour, and generally emblazoned. At first the *tabard* was very long, reaching to the mid-leg, but it



Tabard, Sir John Cornwall, Amptill church, Beds.

was afterwards made shorter. It was at first chiefly worn by the military, but afterwards became an ordinary article of dress among other classes in France and England in the middle ages. In this country the *tabard* is now only worn by heralds.

**TAB'ARDER, n.** One who wears a tabard.

**TABARDEERS, n.** A name formerly given to the scholars at Oxford, who wore the *tabard*.

**TAB'ARET, n.** A stout satin-striped silk, used for furniture.

**TABASHEER, n.** A Persian word signifying a concretion found in the joints of the bamboo, said by Dr. Russel to be the juice of the plant thickened and hardened; by others, to be pure silex. It is highly valued in the East Indies as a medicine, for the cure of bilious vomitings, bloody flux, piles, &c.; but its medicinal virtues seem to be more imaginary than real.

**TAB'BIED, pp.** Watered; made wavy.

**TAB'BINET, n.** A more delicate kind of tabby; a taffety.

**TAB'BY, a.** [See the noun.] Brindled;

brindled; diversified in colour; as, a *tabby* cat.

**TAB'BY, n.** [Fr. *tabis*; It. Sp. and Port. *tabi*; G. *lobin*; Arm. *taftas*, taffeta. Qu. Fr. *taveler*, to spot.] 1. The name formerly given to a kind of rich silk and other stuffs watered or figured, by being passed through a calender, the rollers of which are variously engraved. The engraved parts, pressing unequally upon the stuff, renders the surface unequal, so as to reflect the rays of light differently, and produce the appearance of waves. The same effect may be produced by folding the stuffs in a particular manner, and subjecting them to pressure.—2. A mixture of lime with shells, gravel, or stones in equal proportions, with an equal proportion of water, forming a mass, which when dry, becomes as hard as rock. This is used in Morocco instead of bricks for the walls of buildings.—3. A cat. [*Collog.*].—4. An old maiden lady; an ancient spinster. [*Trivial, and used in contempt.*]

**TAB'BY, v. i.** To water or cause to look wavy; as, to *tabby* silk, mohair, ribbon, &c. This is done by a calender without water.

**TAB'BYING, n.** The passing of stuffs under a calender to give them a wavy appearance, called also *watering*.

**TABFAC'TION, n.** [L. *tabeo*, to waste, and *facio*, to make. See *TABERV.*] A wasting away; a gradual losing of flesh by disease.

**TAB'EFY, v. i.** [Heb. and Ch. *דאב*, *daab*, to pine; or Ar. *tabba*, to be weakened, to perish.] To consume; to waste gradually; to lose flesh. [*Little used.*]

**TABEL'LION, n.** [Fr.; L. *tabellio*, from *tabula*, a tablet.] A kind of secretary or notary. Such a functionary existed under the Roman empire; and, during the old system, in France.

**TAB'ERN.** See *TABARD*.

**TAB'ERN, n.** A provincial name for a cellar.

**TAB'ERNACLE, n.** [L. *tabernaculum*, a tent, from *taberna*, a shop or shed, from *tabula*, a board; or rather from its root. See *TABLE*.] 1. A tent; Numb. xiv.; Matt. xvii.—2. A temporary habitation.—3. Among the *Jews*, a movable building, so contrived as to be taken to pieces with ease and reconstructed, for the convenience of being carried during the wanderings of the Israelites in the wilderness. It was of a rectangular figure, thirty cubits long, ten broad, and ten high. The interior was divided into two rooms or compartments by a veil or curtain, and it was covered with four different spreads or carpets. The outer or larger compartment was called the holy place, being that in which incense was burned, and the shew-bread exhibited; and the inner the most holy place, or holy of holies, in which was deposited the ark of the covenant. The word *tabernacle* is also applied to the temple; Ps. xv.—*Feast of tabernacles*, the last of the three great annual festivals of the Israelites, which required the presence of all the people in Jerusalem. Its object was to commemorate the dwelling of the people in tents during their journeys in the wilderness, and it was also a feast of thanks-

giving for the harvest and vintage. It was celebrated in autumn at the conclusion of the vintage, and lasted eight days, during which the people dwelt in booths made in the streets, in courts, or on the tops of their houses, of the leafy branches of certain trees. These booths were intended to represent the tents in which the Israelites dwelt in the wilderness. [See Lev. xxiii.]—4. A small temple; a place of worship; a sacred place. The meeting houses of the Methodists are often called tabernacles.—5. Our natural body; 2 Cor. v.; 2 Pet. i.—6. God's gracious presence, or the tokens of it; Rev. xxi.—7. An ornamented chest placed on Roman catholic altars as a receptacle of the ciborium and pyxis.—8. In *Goth. arch.*, a canopied stall or niche; a cabinet or shrine ornamented with open-worked tracery, &c.; an arched canopy over a tomb; also, a tomb or monument.

**TABERNAÇLE**, *v. i* To dwell; to reside for a time; to be housed; as we say, Christ *tabernacled* in the flesh.

**TABERNAÇLE**, *a.* In *arch.*, like a tabernacle; richly and quaintly ornate; as, *tabernacle* work.

**TABERNACULAR**, *a.* Latticed.

**TABERNEMONTANA**, *n.* A genus of plants, nat. order Apocynaceæ. *T. utilis* is the Hya-Hya or Cow-tree of Demerara, the thick juice of which is used as milk.

**TABES**, *n.* [L.] A dysthetic or cachectic disease, characterized by a gradually progressive emaciation of the whole body, accompanied with languor, depressed spirits, and, for the most part, imperfect or obscure hectic, without any topical affection of any of the viscera of the head, chest, or belly. *Tabes* and consumption are different diseases. The name *tabes* is now retained for only two forms of disease: 1. *Tabes mesenterica*, that wasting of the body which follows scrofulous inflammation of the mesenteric glands; and, 2. *Tabes dorsalis*, which denotes an impairment of general health, attended by emaciation, muscular debility, and signs of nervous exhaustion, occasioned by an inordinate indulgence of the sexual appetite. It is so called from the weakness which it causes in the back and loins.

**TABETIC**, *a.* *Tabid*; affected with *tabes*.

**TABID**, *a.* [Fr. *tabide*; L. *tabidus*, from *tabeo*, to waste.] Wasted by disease.

In *tabid* persons, milk is the best restorative. *Arbuthnot.*

**TABIDNESS**, *n.* State of being wasted by disease.

**TABINET**. See **TABBINET**.

**TABITUDE**, *n.* [L.] The state of one affected with *tabes*.

**TABLATURE**, *n.* [From *table*.] Painting on walls and ceilings; a single piece comprehended in one view, and formed according to one design.—2. In *music*, the expression of sounds or notes of composition by letters of the alphabet or ciphers, or other characters not used in modern music. In a stricter sense, the manner of writing a piece for the lute, theorbo, guitar, bass viol, or the like; which is done by writing on several parallel lines, (each of which represents a string of the instrument,) certain letters of the alphabet, referring to the frets on the

neck of the instrument, each letter directing how some note is to be sounded. This mode of writing music has long been disused.—3. In *anat.*, a division or parting of the skull into two tables.

**TABLE**, *n.* [Fr. from L. *tabula*; It. *tavola*; W. *tavell*, a flat mass, a tablet, a slice, a spread; *táb, táv*, a spread, an extended surface; *tavlu*, to throw, to project; *tavu*, to spread or overspread; Sax. *taefl*, a die; a table-man; D. *tafel*, a board, a table, whence in ships, *tafferel*; G. and Sw. *tafel*, a board or table; Russ. *id.*; Fr. *tableau*, a picture.] 1. A flat surface of some extent, or a thing that has a flat surface; as, a *table* of marble.—2. An article of furniture, consisting usually of a frame with a surface of boards or of marble, supported by legs, and used for a great variety of purposes, as for holding dishes of meat, for writing on, &c.

The nymph *the table spread*. *Pope*.  
3. Fare or entertainment of provisions; as, he keeps a good *table*.—4. The persons sitting at table or partaking of entertainment.

I drink to th' general joy of the whole *table*. *Shak.*

5. A tablet; a surface on which anything is written or engraved. The ten commandments were written on two *tables* of stone; Exod. xxxii.

Written...not on *tables* of stone, but on fleshy *tables* of the heart; 2 Cor. iii.

6. A picture, or something that exhibits a view of anything on a flat surface.

Saint Anthony has a *table* that hangs up to him from a poor peasant. *Addison*.

7. Among *Christians*, the table, or Lord's table, is the sacrament, or holy communion of the Lord's supper.—

8. The altar of burnt-offering; Mal. i.—

9. In *arch.*, a tablet; a flat surface, generally rectangular, charged with some ornamental figure. When it projects from the naked of the wall it is termed a *raised* or *projecting table*; when it is not perpendicular to the horizon, it is called a *raking table*; and when the surface is rough, frosted, or vermiculated, it is called a *rustic table*.

10. In *persp.*, a plain surface, supposed to be transparent and perpendicular to the horizon. It is called also *perspective plane*.—11. In *anat.*, a division of the cranium or skull. The cranium is composed of two tables or laminae, with a cellular structure between them, called the *meditullium* or *diplœa*.—12. In *the glass manufacture*, a circular sheet of finished glass, usually about four feet in diameter. Twenty-four tables make a *case*.—13. In *literature*, an index; a collection of heads or principal matters contained in a book, with reference to the pages where each may be found; as, a *table* of contents.—14. A synopsis; many particulars brought into one view.—15. The palm of the hand.

Mistress of a fairer *table*  
Hath not history nor fable. *B. Jonson*.

16. Draughts; small pieces of wood shifted on squares.

We are in the world like men playing at *tables*. *Taylor*.

17. In *math.* and *physics*, tables are systems of numbers calculated to be ready for expediting operations, or for exhibiting the measures or values of some property common to a number of different bodies, in reference to some common standard; as, *tables* of logarithms, *tables* of annuities, *tables*

of rhumbs, *tables* of the powers or roots of the different numbers, *tables* of multiplication, *tables* of specific gravity, of refractive powers, of the expansions of bodies by heat, &c.—18. *Astronomical tables* are computations of the motions, places and other phenomena of the planets, both primary and secondary.—19. In *chem.*, a list or catalogue of substances or their properties; as, a *table* of known acids; a *table* of acidifiable bases; a *table* of binary combinations; a *table* of specific gravities.—20. In *general*, any series of numbers formed on mathematical or other correct principles. Thus we have chronological *tables*, *tables* of mortality, &c.—21. A division of the ten commandments; as, the first and second *tables*. The first table comprehends our more immediate duties to God; the second table, our more immediate duties to each other.—22. Among *jewellers*, a table diamond or other precious stone, is one whose upper surface is quite flat, and the sides only cut in angles.—23. A list or catalogue; as, a *table* of stars.—*Raised table*, in *sculp.*, an embossment in a frontispiece for an inscription or other ornament, supposed to be the abacus of Vitruvius.—*Round table*. Knights of the round table were a military order instituted by Arthur, the first king of the Britons, A. D. 516.—*Twelve tables*, the laws of the Roman republic, so called because they were cut in tablets of bronze, and set up in a public place. These laws were drawn up by the Decemvirs, B. C. 451, and hence they were at first called the *laws of the Decemvirs*. They were originally only ten in number, but two more were added to them B. C. 450. The twelve tables are called by Livy the source of public and private law; and the text of them was preserved down to the latest age of Roman literature. They formed the basis of the greater part of Roman jurisprudence.—*To turn the tables*, to change the condition or fortune of contending parties; a metaphorical expression taken from the vicissitudes of fortune in gaming.—*To serve tables*, to provide for the poor; or to distribute provisions for their wants; Acts vi.

**TABLE**, *v. i* To board; to diet or live at the table of another. Nebuchadnezzar *tabled* with the beasts.

**TABLE**, *v. t* To form into a table or catalogue; as, to *table* files. In England, the chirographer *tables* the fines of every county, and fixes a copy in some open place of the court.—2. To board; to supply with food.—3. To let one piece of timber into another by alternate scores or projections from the middle.—4. To lay or place upon a table.—5. To enter upon the record; as, to *table* charges against some one, to *table* a motion to be considered at a subsequent meeting. [Used exclusively of business meetings, whether public or private.]

**TABLE**, *a.* Appertaining to, or provided for a table; as, *table-flaps*, or *table-beer*.—2. Plane; level; as, *table land*.

**TABLEAU**, *n.* [Fr.] A picture; a striking and vivid representation.—2. Performers grouped in a dramatic scene.

**TABLEAUX VIVANTS**. [Fr. living pictures.] An amusement in which groups of persons are so dressed and

placed, as to represent some interesting scene in the works of distinguished painters or authors. Such representations are frequently resorted to in Germany and France, on festive occasions.

**TA'BLE-BED**, *n.* [*table* and *bed*.] A bed in the form of a table.

**TA'BLE-BEER**, *n.* [*table* and *beer*.] Beer for the table, or for common use; small beer.

**TA'BLE-BELL**, *n.* A small bell to be used at table for calling servants.

**TA'BLE-BOOK**, *n.* [*table* and *book*.] A book on which any thing is engraved or written without ink; tablets.

Put into your *table-book* whatever you judge worthy. *Dryden.*

**TA'BLE-CLOTH**, *n.* [*table* and *cloth*.] A cloth for covering a table, particularly for spreading on a table before the dishes are set for meals.

**TA'BLE-COVER**, *n.* [*table* and *cover*.] A cloth, made of wool, flax, cotton, &c., usually woven or stamped with a pattern, and laid on a table between meal-times.

**TA'BLEMED**, *pp.* Formed into a table; placed upon a table.

**TA'BLE D'HOTE**. (täbl döt.) [*Fr.*] A common table for guests at a French hotel. The same phrase is used in Belgium, Germany, Switzerland, &c.; an ordinary.

**TA'BLE-LANDS**, *n.* [*table* and *land*.] The name given to extensive plains which are much elevated above the level of the sea, and have steep acclivities on every side, and therefore differ from other plains, which are either not much elevated, or attain their elevation by imperceptible degrees. The chief table-lands are those among the Andes, those of Mexico, those of Southern Africa, and the immense plains in Central Asia, to the north and north-east of Hindostan. A table-land is also frequently called a *plateau*.

**TA'BLE-LINEN**, *n.* Table-cloths, napkins, &c. [*In Scotland*, formerly called *nappery*, *Fr.*]

**TA'BLE-MAN**, *n.* [*table* and *man*.] A man at draughts; a piece of wood.

**TA'BLE-MONEY**, *n.* *In mar. affairs*, an allowance to flag-officers in addition to their pay, as a compensation for the necessary expenses which they are put to in furnishing their tables.

**TA'BLER**, *n.* One who tables or boards.

**TA'BLE-RENTS**, *n.* Rents paid to bishops, &c., reserved and appropriated to their table or housekeeping.

**TA'BLÉS**, *n. plur.* An old game resembling backgammon.—2. *In Scottish eccles. hist.*, the designation given to the permanent council held in Edinburgh for managing the affairs of the covenanted, during the reign of Charles I. This council is said to have been so named from a *green table* at which the members sat.

**TA'BLE-SHORE**, *n.* *In mar. lan.*, a low level shore.

**TA'BLE-SPAR**. See **TABULAR-SPAR**.

**TA'BLE-SPOON**, *n.* A large spoon used at table.

**TA'BLE-SPOONFUL**, *n.* The full, or once filling, of a table-spoon. Plural, *table-spoonfuls*.

**TA'BLE-SPORT**, † *n.* Amusement at table.

**TAB'LET**, *n.* A small table or flat surface.—2. Something flat on which to write, paint, draw, or engrave.—*In antiquity*, tablets covered with wax,

paper, or parchment, were used as ordinary writing materials. Tablets of ivory, metal, stone, or other substance were also used in judiciary proceedings, and all public acts and monuments were in early ages preserved on such materials.

Through all Greece the young gentlemen learned to design on *tablets* of boxen wood. *Dryden.*

The pillar'd marble, and the *tablet brass*. *Prior.*

3. *In arch.*, a word synonymous with *table*. [*See TABLE*, No. 9.] Some writers use it to designate a horizontal projection from the surface of a wall; as, *earth-tablet*, *base-tablet*, &c.—4. A medicine in a square form. *Tablets* of arsenic were formerly worn as a preservative against the plague. A solid kind of electuary or confection, made of dry ingredients, usually with sugar, and formed into little flat squares; called also *lozenge* and *troche*; also applied to anything made up in a flat square shape, as a *tablet* of soap.

**TAB'LE-TALK**, *n.* [*table* and *talk*.] Conversation at table or at meals.

He improves by the *table-talk*. *Guardian.*

**TAB'LE-TALK'ER**, *n.* A conversationist; one who studies to lead or outshine others in table-talk; a verbal monopolist.

**TAB'LING**, *ppr.* Boarding; forming into a table; letting one timber into another by scores; placing upon a table.

**TAB'LING**, *n.* A forming into tables; a setting down in order.—2. The letting of one timber into another by alternate scores or projections, as in ship-building.—3. *In sail-making*, a broad hem made on the skirts of sails by turning over the edge of the canvas, and sewing it down.—4. Among *Scotch builders*, a term used to designate the coping of very common houses.—*Tabling of fines*, *in law*, the forming into a table or catalogue the fines, acknowledged in the court of common pleas. This is done by an officer called the *chirographer*. [*See CHIROGRAPH*, *CHIROGRAPHER*.]—*Tabling of a summons*. *In Scots law*, it was the practice in former times to set down in a table all summonses, to be called in their turns; those from each quarter into which Scotland was divided, having a particular quarter of the year allotted to them. The setting down of a summons in such a table, was called *tabling of the summons*. [*See SUMMONS*, *CALLING OF A SUMMONS*, *under CALLING*.]

**TABLINUM**, *n.* [*L.*] An apartment in a Roman house in which records were kept and the hereditary statues placed. It entered immediately from the Atrium.

**TABOO'**, *n.* *In the isles of the Pacific*, a word denoting prohibition or religious interdiction, which is of great force among the inhabitants.

**TABOO'**, *v. t.* To forbid, or to forbid the use of; to interdict approach or use; as, to *taboo* the ground set apart as a sanctuary for criminals. *Tabooed* ground is held sacred and inviolable.

**TA'BOR**, } *n.* [*W. taburz*; *Ir. tabar*; *TA'BOUR*, } *Old Fr. tabour*. This, in some languages, is written *tambour*, and *timbrel*. The *atabal* of the Spaniards is probably of the same family. It is probably named from striking, beating; *Eng. tap*, *Gr. τυττω*, *Syr. tabal*, *Ar. tabaa*.] A small drum used as an accompaniment to a pipe or fife.

**TA'BOR**, } *v. i.* To strike lightly and **TA'BOUR**, } frequently.

Her maids shall lead her as with the voice of doves, *taboring* upon their breasts; *Nah. ii.*

2. To play on a tabor or little drum.

**TA'BORER**, } *n.* One who beats the **TA'BOURER**, } tabor.

**TAB'ORET**, } *n.* [*from tabor*.] A **TAB'OURET**, } small tabor.

**TAB'ORINE**, } *n.* [*Fr. tabourin*; from **TAB'OURINE**, } *tabor*.] A tabor; a small drum, in form of a sieve; also called a *tambourine*.

**TA'BORITTE**, *n.* A name given to certain Hussites, or Bohemian reformers, in the 15th century: so named from Tabor, a hill-fort, which was their stronghold, called after Mount Tabor, in Palestine.

**TAB'OURET**, *n.* [*Fr.*] A convex seat without arms or back, made of gilt wood, cushioned and stuffed, covered with silk cloth, and ornamented with silk lace, fringe, tassels, &c.

**TAB'RERE**, † *n.* A taborer.

**TAB'RET**, *n.* [*See TABOR*.] A tabor; 1 Sam. xviii.

**TAB'ULAR**, *a.* [*L. tabularis*, from *tabula*, *table*.] 1. In the form of a table; having a flat or square surface.

—2. Having the form of laminae or plates.—3. Set down in tables; as, a *tabular list* of substances.—4. Set in squares.—*Tabular crystal*, one in which the prism is very short.—*Tabular spar*, *in mineral*, a silicate of lime, generally of a greyish white colour. It occurs either massive or crystallized, in rectangular four-sided tables. *Tabular spar* is the schaalstein of Werner, and the prismatic angite of Jameson. It occurs in primary rocks in Norway and other places.—*Tabular structure*, *in mineral*, a form of structure consisting of parallel plates, separated by regular seams. It is the consequence of crystallization, and is not uncommonly confounded with stratification.—*Tabular differences*, in logarithmic tables of numbers, a column of numbers marked D, consisting of the differences of the logarithms taken in succession, each number being the difference between the successive logarithms in the same line with it. When the difference is not the same between all the logarithms in the same line, the number which answers most nearly to it, one part taken with another, is inserted. In the common tables of logarithms, the logarithms of all numbers from 1 to 10,000 can be found by inspection, but by the aid of the tabular differences, the logarithms of numbers between 10,000 and 1,000,000 may be found. Also, by the aid of the same differences, the number corresponding to any given logarithm can be found to 5 or 6 places. In logarithmic tables of sines, tangents, secants, cosines, cotangents, and cosecants, there are three columns of tabular differences in each page. The first of these is placed between the sines and cosecants, the second between the tangents and cotangents, and the third between the secants and cosines. These numbers are the differences between the logarithms on the left hand, against which they are placed, and the next lower, increased in the proportion of 100 to 60. The use of these differences is to facilitate the finding of the logarithmic sine, tangent, secant, &c., for any given degrees, minutes, and

seconds, or the degrees, minutes, and seconds corresponding to any given logarithmic sine, tangent, secant, &c.

**TAB'ULA RA'SA.** [L.] A smoothed tablet. A term applied, figuratively, to the mind; and said of that of an infant, &c.

**TAB'ULATE, v. t.** To reduce to tables or synopses.—2. To shape with a flat surface.

**TAB'ULATED, pp.** Having a flat or square flat surface; as, a *tabulated* diamond.

**TABULA'TION, n.** In *stat. science*, the art or act of forming tables; or throwing data into a tabular form.

**TACAMAHACA, n.** The popular name of *Icica tacamahaca*, a tree of South America; also of *Calophyllum tacamahaca*, a tree of Madagascar and the Isle of Bourbon; and, according to the younger Michaux (but probably by mistake), of *Populus balsamifera*, a tree of North America.—2. A resin, the produce of *Calophyllum tacamahaca* or *calaba*; and of *Elaphrium tomentosum*, sometimes called *Fagara octandra*, a tree of the island of Curaçoa, and other islands in its neighbourhood.

**TAC'CA, n.** A genus of plants, the type of the nat. order Taccaceæ. The species inhabit the hotter parts of India, and the South Sea Islands. From the tubers of *T. pinnatifida*, *dubia*, and



*Tacca pinnatifida.*

*montana*, a white, highly nutritious substance, like arrow-root, is separated, which is employed as an article of diet by the inhabitants of the Malayan Peninsula, and the Moluccas. The petioles and stalks of *T. pinnatifida*, boiled for some time, are also employed as articles of diet in China and Cochinchina. In Singapore, *T. cristata* is called water-lily.

**TAC'CE.** [L. *taceo*.] A term used in Italian music, directing to be silent.

**TAC'CES, n.** [Etymol. uncertain.] In *archæology*, armour for the thigh. [See **TASSES.**]

**TAC'CE, in music,** is used when a vocal or instrumental part is to be silent during a whole movement.

**TACH, n.** [See **TACK.**] Something **TACHE,** } used for taking hold or holding; a catch; a loop; a button. It is found in Scripture; Exod. xxvi.

**TACHO'METER, n.** [Gr. *ταχυς*, quick, and *μετρος*, measure.] A contrivance for the purpose of indicating small variations in the velocity of machines. A cup, partly filled with mercury, and attached to a spindle, is whirled round by the machine, and the centrifugal

force produced by this whirling, causes the mercury to recede from the centre and rise upon the sides of the cup. As this effect is produced by the velocity of the machine, so it is proportionate to that velocity, and subject to corresponding variations.

**TACHYDIDAX'Y, n.** [Gr. *ταχυς*, quick, and *διδασκω*, teaching.] A short method of imparting knowledge.

**TACHYDROM'IAN, n.** A bird of the genus *Tachydromus*; one of a tribe of Saurians, of the same name.

**TACHY'DROMUS, n.** According to Illiger, a genus of wading birds, the cursorius of Lacepede. The same name is given by Fitzinger to a subgenus of Saurian reptiles, found in the Indian islands and China.

**TACHYGRAPH'IC, n.** Written in **TACHYGRAPHICAL, n.** short hand. **TACHYG'RAPHY, n.** [Gr. *ταχυς*, quick, and *γραφω*, to write.] The art or practice of quick writing. Sometimes written *tacheography*. [We now use *stenography*, and *short hand writing*.]

**TACHYLITE, n.** A mineral resembling obsidian, supposed also to be similar to isopyre. It is found in small masses at Säsabühl, near Göttingen, in basalt and wacke.

**TACHYPETES, n.** Vieillot's generic name for the frigate bird; the *Pelecanus aquilus*, Linn.

**TACIT, a.** [Fr. *tacite*; L. *tacitus*, from *taceo*, to be silent, that is, to stop, or to close. See **TACK.**] Silent; implied, but not expressed. *Tacit* consent is consent by silence, or not interposing an objection. So we say, a *tacit* agreement or covenant of men to live under a particular government, when no objection or opposition is made; a *tacit* surrender of a part of our natural rights; a *tacit* reproach, &c.—*Tacit relocation*. [See **RELOCATION.**]

**TACITLY, adv.** Silently; by implication, without words; as, he *tacitly* assented.

**TACITURN, a.** [L. *taciturnus*.] Habitually silent; not free to converse; not apt to talk or speak.

**TACITURN'ITY, n.** [Fr. *taciturnité*; from L. *taciturnitas*, from *taceo*, to be silent.] Habitual silence or reserve in speaking.

Too great loquacity, and too great *taciturnity* by fits. *Arbutnot.*

2. In *Scots law*, a mode of extinguishing an obligation in a shorter period than by the forty years' prescription. This mode of extinguishing obligations is by the silence of the creditor, and arises from a presumption that in the relative situations of himself and creditor, he would not have been so long silent, if the debt had not been paid, or the obligation implemented.

**TACITURNLY, adv.** Silently; without conversation.

**TACK, v. t.** [Gr. *τασσα*, to set, place, ordain, the root of which was *ταγω*, as appears from its derivatives, *ταγος*, *ταγμα*. Hence Fr. *attacher*, It. *attaccare*, Sp. *atacar*, W. *tagu*, to stop, Sp. *taco*, a stopper. See **ATTACH.** The primary sense is probably to thrust or send.] 1. To fasten; to attach. In the solemn or grave style, this word now appears ludicrous; as, to get a commendam *tached* to his ears.

And *tack* the centre to the sphere. *Herbert.*

2. To unite by stitching together; as, to *tack* together the sheets of a book;

to *tack* one piece of cloth to another. [In the familiar style, this word is in good use.]—3. To fasten slightly; to fasten by tacks or small nails; as, to *tack* cloth on a board.

**TACK, n.** } † n. [Fr. *tache*.] A spot.

**TACHE, n.** } † n. [Fr. *tache*.] A spot.

**TACK, n.** [Ir. *taca*; Arm. *tach*.] 1. A small nail. Tacks are of various kinds, but they are too well known to require description. They are used for various purposes, but principally for stretching cloth upon a board, and fastening slightly any covering.—2. A rope used to confine the foremost lower corners of the courses and stay-sails, when the wind crosses the ship's course obliquely; also, a rope employed to pull the lower corner of a studding sail to the boom. Hence,—3. The part of a sail to which the tack is usually fastened; the foremost lower corner of the courses. Hence,—4. The course of a ship in regard to the position of her sails; as, the starboard *tack*, or larboard *tack*; the former when she is close-hauled with the wind on her starboard, the latter when close-hauled with the wind on her larboard.—*To hold tack*, to last or hold out.—*Tack of a flag*, a line spliced into the eye at the bottom of the tabling, for securing the flag to the halliards.

**TACK, v. t.** To change the course of a ship by shifting the tacks and position of the sails from one side to the other.

**TACK, n.** In *rural economy*, a shelf on which cheese is dried. [Local.]—2. The technical name in Scotland for a lease, whether of lands or edifices. [See **LEASE.**]

**TACK-DU'TY, n.** In *Scots law*, rent reserved on a tack or lease.

**TACKER, n.** One who tacks or makes an addition.

**TACK'ET, n.** A small nail; a tack. [Scotch.]

**TACK'ING, ppr.** Changing a ship's course.

**TACK'ING, n.** An operation by which, when a ship is proceeding in a course making any acute angle with the direction of the wind on one of her bows, her head is turned towards the wind, so that she may sail on a course making nearly the same angle with its direction on the other bow. This is effected by means of the rudder and sails.

**TACK'LE, n.** [D. *takel*, a pulley and tackle; *takelen*, to rig; G. *takel, takeln*; W. *tactu*, to put in order, to dress, deck, set right; *tacklau*, tackling; *accountments*; *tacyl*, a tool. This seems to belong to the family of *tack*, Gr. *τασσα*. The primary sense is to put on, or to set or to put in order.] 1. In *mar. lan.*, a pulley composed of two or more blocks, and a rope termed the *fall*. Tackles are used in a ship to raise, remove, or secure weighty bodies, to support the masts, or to extend the sails and rigging. They are more or less complicated, in proportion to the effects which they are intended to produce. [See **PULLEY.**]—2. Instruments of action; weapons.

She to her *tackle* fell. *Hudibras.*

3. An arrow.—4. All the ropes of a ship and other furniture of the masts.—5. Harness for horses. [Provincial.]—*Tackle-fall*, the rope, or rather the end of the rope of a pulley, which falls and by which it is pulled.—*Ground-tackle*, anchors, cables, &c.—*Gun-tackle*, the apparatus for hauling cannon in or out.—*Tack-tackle*, a small

tackle to pull down the tacks of the principal sails.

**TACKLE**, *v. t.* 1. To supply with tackle. —2. To harness a horse. [*Provincial.*] —3. † To seize; to lay hold of.

**TACKLED**, *pp.* Supplied with tackle; made of ropes tacked together; accoutred; fitted for action; seized.

**TACKLING**, *pp.* Supplying with tackle; accoutering; fitting for action; seizing.

**TACKLING**, *n.* Furniture of the masts and yards of a ship, as cordage, sails, &c. —2. Instruments of action; as, fishing *tackling*. —3. Harness; the instruments of drawing a carriage. [*Provincial.*]

**TACKSMAN**, *n.* One who holds a tack or lease of land from another; a tenant or lessee. [*Scotch.*]

**TACT**, *n.* [*L. tactus*, from *tango*, [for *tago*], to touch; *Fr. tact*.] 1. Touch; feeling; formerly, the stroke in beating time in music. [*Dan. tagt.*] —2. Peculiar skill or faculty; nice perception or discernment. Skill or adroitness in adapting to circumstances, words, or actions.

**TACTABLE**, *a.* That may be touched or felt by the sense of touch. [*See TACTILE.*]

**TACTIC**, } *a.* [*See TACTICS.*] PER-  
**TACTICAL**, } taining to the art of  
military and naval dispositions for  
battle, evolutions, &c.

**TACTICIAN**, *n.* [*See TACTICS.*] One versed in tactics; an adroit manager or contriver.

**TACTICS**, *n.* [*Gr. τακτικῆς*, from *τακτω*, *τακτω*, to set, to appoint; *ταξ*, order; *Fr. tactique.* *See TACK.*] 1. The science and art of disposing military and naval forces in order for battle, and performing military and naval evolutions. That branch which relates to land forces is termed *military tactics*, and that which relates to naval forces, *naval tactics*. The first treats of the mode of disposing troops for battle, of directing them during its continuance, the conduct of a retreat, and the exercises, arms, &c., necessary to fit troops for action; and the latter treats of the art of arranging fleets or squadrons in such an order or disposition as may be most convenient for attacking the enemy, defending themselves, or of retreating with the greatest advantage. [*See STRATEGY.*] In the most extensive sense, *tactics*, *la grande tactique* of the French, comprehends every thing that relates to the order, formation, and disposition of armies, their encampments, &c. — *Elementary tactics*, that branch which treats of the drilling and formation of soldiers, and all the modes of training them for action. —2. The art of inventing and making machines for throwing darts, arrows, stones, and other missile weapons.

**TACTILE**, *a.* [*Fr. tactile*, from *L. tactilis*, from *tango*, to touch.] Tangible; susceptible of touch; that may be felt; as, *tactile sweets*; *tactile qualities*.

**TACTILITY**, *n.* Tangibleness; perceptibility of touch.

**TACTION**, *n.* [*Fr.* from *L. tactio*, *tango*, to touch.] The act of touching; touch. —2. In *geom.*, the same as tangency or touching.

**TACTLESS**, *a.* Destitute of tact.

**TACTUAL**, *a.* Pertaining to touch; consisting in or derived from touch.

**TADORNA**, *n.* [*Sp. tadorno.*] A genus of ducks, which includes the sheldrake, *T. vulpanser*.

**TADPOLE**, *n.* [*Sax. tade*, toad, with *pola*, coinciding with *L. pullus*, young.] A frog in its first state from the spawn; a porwiggle; a powhead.

**TÆDIUM**, *n.* [*L.*] Weariness; irksomeness. [*See TÆDIUM.*]

**TÆDIUM VITÆ**. [*L.*] Weariness of life; a mental disorder.

**TÆL**, *n.* In *China*, a denomination of money, worth nearly seven shillings sterling; also a weight of one ounce and a third.

**TÆN**. (*tane*.) The poetical contraction of *tanen*.

**TÆNIA**, } *n.* [*Gr. ταινία*, a fillet or  
**TE'NIA**, } ribbon.] The tape-worm; a genus of Entozoa, belonging to the order Parenchymata, and family Tænioidea, *Cuv.* It is characterized by a long, flat, and jointed body. [*See TAPE-WORM.*] —2. In *arch.*, the fillet or band which separates the Doric frieze from the architrave.

**TÆNIOIDEA**, *n.* A family of parenchymatous intestinal worms, of which the genus *Tænia* is the type.

**TÆNIOIDS**, *n.* A family of acanthopterygious fishes, comprehending those which have an elongated body flattened on the sides, and very small scales. It is closely connected with the scomberoids.

**TAF'ELSPATH**, *n.* A lamellar mineral of a yellowish grey or rose white, forming masses of prisms interlaced in the gang, chiefly lime and silice.

**TAF'FETA**, } *n.* [*Fr. tafetas*, *taffetas*;  
**TAF'FETY**, } *It. taffetta*; *G. taffet.*] A fine smooth stuff of silk, having usually a remarkable wavy lustre, imparted by pressure and heat with the application of an acidulous fluid, to produce the effect called *watering*. It is much used on the Continent for window curtains. *Taffetas* are of all colours.

**TAF'FRAIL**, } *n.* [*D. tiferel*, from  
**TAF'FEREL**, } *tafel*, table.] In *ships*, the rail over the heads of the stern timbers, extending across the stern from one quarter-stanchion to the other.

**TAF'IA**, *n.* A variety of rum, so called by the French.

**TAG**, *n.* [*Sv. tagg*, a point or prickle; *Ice. tag*; *Dan. tagger*, *takker*.] The primary sense is probably a shoot, coinciding with the first syllable of *L. digitus* [*see TOE*]; or the sense is from putting on, as in *tackle*. In *Goth.* *taga* is hair, the hair of the head, that which is shot out, or that which is thick. The latter sense would show its alliance to the *W. tagu*, to choke.] 1. A metallic point to put to the end of a string; anything attached or affixed to another; as, the *tag* of a lace. —2. Any worthless appendage; something mean and paltry; as, *tag-rag* people. [*Vulgar.*] —3. A young sheep; often written *Tag*. [*Local.*]

**TAG**, *v. t.* To fit with a point; as, to *tag* lace. —2. To fit one thing to another; to append to.

His courteous host  
*Tags* every sentence with some fawning  
word. *Dryden.*

3. To join or fasten.

**TAG**, *n.* [*L. tago*, *tango*, I touch; probably *A.-Sax. ic teoge*, I pull.] A kind of boy's play, in some localities; the sport of which is, that the last person who is touched, or *tagged*, is put to a disadvantage. In *Scotland*, it is called *tip-tag*.

**TAG'GED**, *pp.* Fitted with a point; appended to.

**TAG'GER**, *n.* One who tags, or attaches one thing to another; as, a *tagger* of verses. [*Familiar.*]

**TAG'GING**, *pp.* Fitting with a point; fitting one thing to another.

**TAGLIACOTIAN OPERATION**. [*See TALIACOTIAN.*]

**TAG'-RAG**, *n.* In *low lan.*, a term applied to the lowest class of people; the rabble.

**TAG'-SORE**, } *n.* A disease in sheep  
**TAG'-BELT**, } in which the tail be-  
comes excoriated, and adheres to the  
wool in consequence of diarrhoea.

**TAG'-TAIL**, *n.* [*tag* and *tail*.] A worm which has its tail of another colour.

**TAG'UA**, *n.* A name given to the palm which yields the vegetable ivory. It is the *Phytelephas macrocarpa*, and is sometimes denominated *Cabeza de negro* or negro-head. The ivory is the hard albumen of the seed. [*See IVORY-NUT.*]

**TAIL**, *n.* [*Sax. tægl*; *Ice. tagl*; dim. of *tag*, a shoot, or from *Goth. taga*, hair.] 1. The part of an animal which terminates its body behind. In many quadrupeds, the tail is a shoot or projection covered with hair. In fowls, the tail consists of feathers, or is covered with them, which serve to assist in the direction of their flight. In fishes, the tail is formed usually by a gradual sloping of the body, ending in a fin. The tail of a fish may assist the animal in steering, but its principal use is to propel the fish forward. It is the instrument of swimming. —2. The lower part, noting inferiority.

The Lord will make thee the head, and not the tail; *Deut. xxviii.*

3. Anything hanging long; a catkin. —4. The hinder part of anything. —5. In *anat.*, that tendon of a muscle which is fixed to the movable part. —6. In *bot.*, the tail of a seed, is a downy or feathery appendage to certain seeds, formed of the permanent elongated style. —7. *Horse's tail*, among the *Tartars* and *Chinese*, is an ensign or flag; among the *Turks*, a standard borne before the grand vizier, pachas, and the sangiaes. For this purpose, it is fitted to a half-pike with a gold button, and is called *toug*. There are pachas of one, two, and three tails. —8. In *her.*, the tail of a hart. —9. In *music*, the part of a note running upward or downward. —10. The extremity or last end; as, the tail of a storm. —11. In *arch.*, the lower end of any member; as of a slate or tile. —12. In *mar. lan.*, the long end of a block-strap. — *Tail of the trenches*, in *fort.*, the post where the besiegers begin to break ground, and cover themselves from the fire of the place. — *Tail of a comet*, a luminous train which extends from the nucleus in a direction opposite to the sun. — *To turn tail*, is to run away; to flee. — *Tail of a canal lock*, the lower end, or entrance into the lower pond. — *Tail bay of a canal lock*, the exterior portion below the lower gate.

**TAIL**, or **FEE-TAIL**, *n.* [*Fr. tailier*, *It. tagliare*, *Ir. tallam*, to cut off; *W. tok*, to curtail, to separate, to deal out, from *tawl*, a sending or throwing, a cast or throw, a separation, diminution, interruption. This is from the same root as *deal*. *See DEAL.*] In *law*, an estate in tail is a limited fee; an estate limited to certain heirs, and from which the other heirs are precluded. Estates tail are *general* or *special*; *general*, where lands and tenements are given to one, and to the heirs of his body begotten; *special*, where the gift is re-



strained to certain heirs of the donee's body, as to his heirs by a particular woman named. If the lands be given or conveyed to a man and the heirs male of his body, this is called *tail-male general*; but if to a man and the heirs female of his body, on his present wife begotten, it is called *tail-female special*. Copyholds are not conveyed in this manner, unless by special custom of the manor. [See **ENTAIL**.]

**TAIL**, *v. t.* To pull by the tail.—*To tail in*, in *arch.*, to fasten any thing by one of its ends into a wall.—*To tail upon*, to lie or rest upon, as the end of a timber upon a wall.

**TAILAGE**, } † *n.* [Fr. *tailer*, to cut  
**TAILIAGE**, } off.] Literally, a portion cut out of a whole; a share; a share of a man's substance paid away by way of tribute; hence, a tax or toll.

**TAIL-BLOCK**, *n.* In *ships*, a single block having a short piece of rope attached to it, by which it may be fastened to any object at pleasure.

**TAIL-BOARDS**. The carved work between the cheeks that is fastened to the knee of the head.

**TAIL-DRAIN**, *n.* In *agriculture*, a drain forming a receptacle for all the water that runs out of the other drains of a field or meadow.

**TAILED**, *a.* Having a tail.

**TAILING**, *n.* In *arch.*, the part of a projecting stone or brick inserted into a wall.

**TAILINGS**, *n. plur.* [from *tail*.] The lighter parts of grain blown to one end of the heap in winnowing. [Local.]

**TAILLE**, *n.* [Fr.] In *ancient French jurisprudence*, a tax, tallage, or subsidy; any imposition levied by the king, or any other lord, on his subjects.—2. [Fr. *tailleur*, to clip.] In *English law*, the fee or holding which is opposite to fee simple.

*Taille* is thus called, because it is so minced, or pared, that it is not in his free power to be disposed of who owns it; but it is, by the first giver, cut or divided from all other, and tied to the issue of the donee. Cowell.

**TAILLESS**, *a.* Having no tail.

**TAIL'LOIR**, *n.* [Fr.] In *arch.*, the French name for the abacus.

**TAILOR**, *n.* [Fr. *tailleur*; from *tailleur*, to cut, *it. tagliare*, *fr. tallam*.] One whose occupation is to cut out and make men's garments.

**TAILOR**, *v. i.* To practise making men's clothes.

**TAILORESS**, *n.* A female who makes garments for men.

**TAILORING**, *n.* The business of a tailor.

**TAIL-PIÈCE**, *n.* A piece at the end, as of a series of engravings.—2. In a *violin*, a piece of ebony attached to the end of the instrument, to which the strings are fastened.

**TAIL-RACE**, *n.* The stream of water which runs from the mill, after it has been applied to produce the motion of the wheel. [Provincial.]

**TAIL TRIMMER**, *n.* In *arch.*, a trimmer next to the wall, into which the ends of joists are fastened to avoid flues.

**TAIL'ZIE**, } *n.* [Fr. *tailleur*, to cut off.]  
**TAIL'YIE**, } In *Scots law*, the technical term corresponding with the English word *Entail*, which now generally supersedes it in colloquial use, even in Scotland. The term, in its largest acceptation, signifies any deed, by which the legal course of succession is cut

off, and an arbitrary one substituted. But it is usually applied to a deed framed in terms of the statute 1685, c. 22, and intended for the purpose of securing the descent of an heritable estate to the series of heirs or substitutes called to the succession by the maker of the tailzie. Any person is allowed to tailzie his lands and estates, and to prescribe to the heirs such conditions as he pleases. But to constitute an effectual entail he must prohibit the institute, or person to whom the estate is conveyed, in the first place, and the substitutes, who are afterwards to succeed, from selling, alienating, or disposing the estate, altering the order of succession, or contracting debt, and thereby causing the estate to be adjudged. The clauses essentially necessary to give effect to an entail are, 1st, Prohibitions against altering the order of succession, against alienating the land, and against contracting debts, whereby the lands may be burdened or affected by diligence; 2d, Irritant clauses, declaring that all deeds executed, whereby the course of succession may be altered, or the lands sold or conveyed away, and all debts contracted, contrary to the above prohibitions, shall be void and null; and, 3d, Resolutive clauses, declaring that if any of the heirs of entail shall act contrary to all or any of the prohibitions, he shall forfeit his right to the lands entailed, sometimes for himself only, and in other cases for all the heirs who may take the succession as his descendants. But in the deed of entail, as now in use, a variety of other clauses are usually added. An entail is not effectual till recorded in the register of entails at Edinburgh, and followed by infestment.

**TAINT**, *v. t.* [Fr. *teindre*, to dye or stain; *L. tingo*; *Gr. τίνω*, to dye, literally to dip, primarily to thrust, the sense of *L. tango*; and *n* not being radical, the real word is *tego* or *tago*, coinciding with *Eng. duck*; hence its sense in *extinguo*. See **DYE**, **ATAINT**, and **TINGE**.] 1. To imbue or impregnate, as with some extraneous matter which alters the sensible qualities of the substance.

The spaniel struck  
Stiff by the tainted gale. Thomson.  
2. More generally, to impregnate with something odious, noxious, or poisonous; as, putrid substances taint the air.—3. To infect; to poison. The breath of consumptive lungs is said to taint sound lungs.—4. To corrupt, as by incipient putrefaction; as, tainted meat.—5. To stain; to sully; to tarnish.

We come not by the way of accusation  
To taint that honour every good tongue  
blesses. Shak.

6. † To corrupt, as blood; to attain. [See **ATAINT**.]  
**TAINT**, *v. i.* To be infected or corrupted; to be touched with something corrupting.

I cannot taint with fear. Shak.  
2. To be affected with incipient putrefaction. Meat soon taints in warm weather.

**TAINT**, *n.* Tincture; stain.—2. Infection; corruption; depravation. Keep children from the taint of low and vicious company.—3. A stain; a spot; a blemish on reputation.—4. An insect;

**TAINTED**, *pp.* Impregnated with

something noxious, disagreeable to the senses or poisonous; infected; corrupted; stained.

**TAINTFREE**, *a.* [taint and free.] Free from taint or guilt.

**TAINTING**, *ppr.* Impregnating with something foul or poisonous; infecting; corrupting; staining.

**TAINTLESS**, *a.* Free from taint or infection; pure.

**TAINTLESSLY**, *adv.* Without taint.

**TAINTURE**, *n.* [*L. tinctura*.] Taint; tinge; defilement; stain; spot. [Not much used.]

**TAIT**, **TATE**, or **TEAT**, *n.* A small portion of anything; as, a *tail* of wool; a *tail* of hay. [Scotch.]

**TAJA'CU**, } *n.* The peccary or Mexi-  
**TAJAS'U**, } can hog; the *Dicotyles torquatus*, a pachydermatous mammal inhabiting the eastern side of South America.

**TAKE**, *v. t.* pret. *Took*; *pp. Taken*. [Sax. *tæcan*, to take, and to teach; also *thigan*, to take, as food; Sw. *taga*; Dan. *tager*; Ice. *taka*; Gr. *δέχομαι*: *L. doceo*. This word seems to be allied to *think*, for we say, *I think* a thing to be so, or *I take* it to be so. It seems also to be allied to Sax. *teogan*, to draw, to *tug*, *L. duco*; for we say, to *take* a likeness, and to *draw* a likeness. We use *taking* also for engaging, attracting. We say, a child *takes* to his mother or nurse, and a man *takes* to drink; which seem to include *attaching* and holding. We observe that *take* and *teach* are radically the same word.] 1. In a general sense, to get hold or gain possession of a thing in almost any manner, either by receiving it when offered, or by using exertion to obtain it. *Take* differs from *seize*, as it does not always imply haste, force, or violence. It more generally denotes to gain or receive into possession in a peaceable manner, either passively or by active exertions. Thus,—2. To receive what is offered.

Then I took the cup at the Lord's hand; Jer. xxv.

3. To lay hold of; to get into one's power for keeping.

No man shall take the nether or the upper millstone to pledge; Deut. xxiv.

4. To receive with a certain affection of mind. He *takes* it in good part; or he *takes* it very ill.—5. To catch by surprise or artifice; to circumvent.

Men in their loose unguarded hours they take,

Not that themselves are wise, but others weak. Pope.

6. To seize; to make prisoner. The troops entered, slew, and took three hundred janizaries.

This man was taken by the Jews; Acts xxiii.

7. To captivate with pleasure; to engage the affections; to delight.

Neither let her take thee with her eyelids; Prov. vi.

Cleombrotus was so taken with this prospect, that he had no patience. Wake.

8. To get into one's power by engines or nets; to entrap; to insnare; as, to *take* foxes with traps; to *take* fishes with nets, or with hook and line.—9. To understand in a particular sense; to receive as meaning. *I take* your meaning.

You take me right. Bacon.  
Charity, taken in its largest extent, is nothing else but the sincere love of God and our neighbour. Wake.

10. To exact and receive.

*Take* no usury of him or increase; Lev. xxv.

11. To employ; to occupy. The prudent man always *takes* time for deliberation, before he passes judgment.—12. To agree to; to close in with; to comply with.

*I take* thee at thy word.

*Rowe.*

13. To form and adopt; as, to *take* a resolution.—14. To catch; to embrace; to seize; as, to *take* one by the hand; to *take* in the arms.—15. To admit; to receive as an impression; to suffer; as, to *take* a form or shape.

Yet thy moist clay is pliant to command;  
Now *take* the mould.

*Dryden.*

16. To obtain by active exertion; as, to *take* revenge or satisfaction for an injury.—17. To receive; to receive into the mind.

They *took* knowledge of them that they had been with Jesus; Acts iv.

It appeared in his face that he *took* great contentment in this our question. *Bacon.*

18. To swallow, as meat or drink; as, to *take* food; to *take* a glass of wine.

—19. To swallow, as medicine; as, to *take* pills; to *take* stimulants.—20. To choose; to elect. *Take* which you please. But the sense of *choosing*, in this phrase, is derived from the connection of *take* with *please*. So we say, *take* your choice.—21. To copy. Beauty alone could beauty *take* so right.

*Dryden.*

22. To fasten on; to seize. The frost has *taken* the corn; the worms have *taken* the vines.

Wheresoever he *take*th him, he teareth him, and he foameth; Mark ix.

23. To accept; not to refuse. He offered me a fee, but I would not *take* it.

Ye shall *take* no satisfaction for the life of a murderer; Numb. xxxv.

24. To adopt.

I will *take* you to me for a people; Exod. vi. 25. To admit.

Let not a widow be *taken* into the number under threescore; 1 Tim. v.

26. To receive, as any temper or disposition of mind; as, to *take* shame to one's self; to *take* delight; to *take* pride or pleasure.—27. To endure; to bear without resentment; or to submit to without attempting to obtain satisfaction. He will *take* an affront from no man. Cannot you *take* a jest?—28. To draw; to deduce.

The firm belief of a future judgment is the most forcible motive to a good life, because *taken* from this consideration of the most lasting happiness and misery.

*Tillotson.*

29. To assume; as, I *take* the liberty to say.—30. To allow; to admit; to receive as true, or not disputed; as, to *take* a thing for granted.—31. To suppose; to receive in thought; to entertain in opinion; to understand. This I *take* to be the man's motive.

He *took* that for virtue and affection which was nothing but vice in disguise.

*South.*

You'd doubt his sex, and *take* him for a girl.

*Tate.*

32. To seize; to invade; as, to be *taken* with a fever.—33. To have recourse to; as, the sparrow *takes* a bush; the cat *takes* a tree. [In this sense, we usually say, the bird *takes* to a bush, the squirrel *takes* to a tree.]—34. To receive into the mind.

Those do best, who *take* material hints to be judged by history.

*Locke.*

35. To hire; to rent; to obtain possession on lease; as, to *take* a house or farm for a year.—36. To admit in copulation.—37. To draw; to copy; to paint a likeness; as, a likeness *taken* by Reynolds.—38. To conquer and cause to surrender; to gain possession of by force or capitulation; as, to *take* an army, a city, or a ship.—39. To be discovered or detected. He was *taken* in the very act.—40. To require or be necessary. It *takes* so much cloth to make a coat.—*To take away*, to deprive of; to bereave; as, a bill for *taking away* the votes of bishops.

By your own law I *take* your life away.

*Dryden.*

2. To remove; as, to *take away* the consciousness of pleasure.—*To take care*, to be careful; to be solicitous for.

Doth God *take care* for oxen? 1 Cor. ix.

2. To be cautious or vigilant. *Take care* not to expose your health.—*To take care of*, to superintend or oversee; to have the charge of keeping or securing.—*To take a course*, to resort to; to have recourse to measures.

The violence of storming is the *course* which God is forced to *take* for the destroying of sinners. *Hammond.*

*To take one's own course*, to act one's pleasure; to pursue the measures of one's own choice.—*To take down*, to reduce; to bring lower; to depress; as, to *take down* pride, or the proud. 2. To swallow; as, to *take down* a position.—3. To pull down; to pull to pieces; as, to *take down* a house or a scaffold.—4. To write; as, to *take down* a man's words at the time he utters them.—*To take from*, to deprive of.

I will smite thee, and *take* thine head from thee; 1 Sam. xvii.

2. To deduct; to subtract; as, to *take* one number from another.—3. To detract; to derogate.—*To take heed*, to be careful or cautious.

*Take heed* what doom against yourself you give.

*Dryden.*

*To take heed to*, to attend to with care. *Take heed* to thy ways.—*To take hold*, to seize; to fix on.—*To take in*, to enclose; to fence.—2. To encompass or embrace; to comprise; to comprehend.—3. To draw into a smaller compass; to contract; to brail or furl; as, to *take in* sail.—4. To cheat; to circumvent; to deceive. [Not elegant.]—5. To admit; to receive; as, a vessel will *take in* more water. The landlord said he could *take in* no more lodgers.—6.† To win by conquest.—7. To receive into the mind or understanding.

Some bright genius can *take in* a long train of propositions. *Watts.*

*To take in hand*, to undertake; to attempt to execute any thing; Luke i.—*To take notice*, to observe; or to observe with particular attention.—2. To show by some act that observation is made; to make remark upon. He heard what was said, but *took* no notice of it.—*To take oath*, to swear with solemnity, or in a judicial manner.—*To take off*, to remove, in various ways; to remove from the top of any thing; as, to *take off* a load; to *take off* one's hat, &c.—2. To cut off; as, to *take off* the head or a limb.—3. To destroy; as, to *take off* life.—4. To remove; to invalidate; as, to *take off*

the force of an argument.—5. To withdraw; to call or draw away.

Keep foreign ideas from *taking off* the mind from its present pursuit. *Locke.*

6. To swallow; as, to *take off* a glass of wine.—7. To purchase; to take from in trade.

The Spaniards having no commodities that we will *take off*.

*Locke.*

8. To copy.

*Take off* all their models in wood.

*Addison.*

9. To imitate; to mimic.—10. To find place for; as, more scholars than preferments can *take off*.—*To take off from*, to lessen; to remove in part. This *takes off* from the deformity of vice.—*To take order with*, to check. [Not much used.]—*To take out*, to remove from within a place; to separate; to deduct.—2. To draw out; to remove; to clear or cleanse from; as, to *take out* a stain or spot from cloth; to *take out* an unpleasant taste from wine.—*To take part*, to share. *Take part* in our rejoicing.—*To take part with*, to unite with; to join with.—*To take place*, to happen; to come, or come to pass.—2. To have effect; to prevail.

Where arms *take place*, all other pleas are vain.

*Dryden.*

*To take effect*, to have the intended effect; to be efficacious.—*To take root*, to live and grow; as a plant.—2. To be established; as principles.—*To take up*, to lift; to raise.—2. To buy or borrow; as, to *take up* goods to a large amount; to *take up* money at the bank.—3. To begin; as, to *take up* a lamentation; Ezek. xix.—4. In *sur.*, to fasten with a ligature.—5. To engross; to employ; to engage the attention; as, to *take up* the time.—6. To have final recourse to.

Arnobius asserts that men of the finest parts *took up* their rest in the Christian religion. *Addison.*

7. To seize; to catch; to arrest; as, to *take up* a thief; to *take up* vagabonds.—8. To admit.

The ancients *took up* experiments upon credit. *Bacon.*

9. To answer by reproof; to reprehend.

One of his relations *took* him up roundly.

*L'Estrange.*

10. To begin where another left off.

Soon as the evening shades prevail,  
The moon *takes up* the wondrous tale.

*Addison.*

11. To occupy; to fill; as, to *take up* a great deal of room.—12. To assume; to carry on or manage for another; as, to *take up* the quarrels of our neighbours.—13. To comprise; to include.

The noble poem of Palemon and Arcite *takes up* seven years. *Dryden.*

14. To adopt; to assume; as, to *take up* current opinions.

They *take up* our old trade of conquering.

*Dryden.*

15. To collect; to exact a tax.—16. To pay and receive; as, to *take up* a note at the bank.—*To take up arms*, or to *take arms*, to begin war; to begin resistance by force.—*To take up the gauntlet*. [See GAUNTLET.]—*To take the field*, in *milit. lan.*, to quit camp; to commence the operations of a campaign.—*To take on* or *upon*, to assume; to undertake. He *takes upon* himself to assert that the fact is capable of proof.—2. To appropriate to; to admit to be imputed to; as, to *take*

upon one's self a punishment.—*To take on*, to mourn; to fret.—[*Obsolete, or trivial.*—*To take side*, to join one of two differing parties; to take an interest in one party.—*To take to heart*, to be sensibly affected by; to feel any thing sensibly.—*To take heart*, to resume lost courage; to cheer up.—*To take advantage of*, to catch by surprise; or to make use of a favourable state of things, to the prejudice of another.—*To take the advantage of*, to use any advantage offered.—*To take air*, to be divulged or made public; to be disclosed; as a secret.—*To take the air*, to expose one's self to the open air.—*To take a course*, to begin a certain direction or way of proceeding.—*To take leave*, to bid adieu or farewell; to claim permission, or make bold, to; as, *I take leave* to differ from you.—*To take breath*, to rest; to be recruited or refreshed.—*To take aim*, to direct the eye or a weapon to a particular object.—*To take along*, to carry, lead, or convey.—*To take a way*, to be in a particular course or direction.

**TAKE**, *v. i.* To move or direct the course; to resort to, or to attach one's self; to betake one's self. The fox being hard pressed, *took* to the hedge. My friend has left his music, and *taken* to books.

The defuxion *taking* to his breast, wasted his lungs. *Bacon.*

2. To please; to gain reception. The play will not *take*, unless it is set off with proper scenes.

Each wit may praise it for his own dear sake,

And hint he writ it, if the thing should *take*. *Addison.*

3. To have the intended or natural effect.

In impressions from mind to mind, the impression *taketh*. *Bacon.*

4. To catch; to fix, or be fixed. He was inoculated, but the infection did not *take*.

When flame *taketh* and openeth, it giveth a noise. *Bacon.*

*To take after*, to learn to follow; to copy; to imitate; as, he *takes after* a good pattern.—2. To resemble; as, the son *takes after* his father.—*To take in with*, to resort to.—*To take for*, to mistake; to suppose or think one thing to be another.

The lord of the land *took us for* spies; Gen. xlii.

*To take to*, to apply to; to be fond of; to become attached to; as, to *take to* books; to *take to* evil practices.—2. To resort to; to betake to.

Men of learning who *take to* business, discharge it generally with greater honesty than men of the world. *Addison.*

*To take up*, to stop.

Sinners at last *take up* and settle in a contempt of all religion.† *Tillotson.*  
2.† To reform.—*To take up with*, to be contented to receive; to receive without opposition; as, to *take up with* plain fare.

In affairs which may have an extensive influence on our future happiness, we should not *take up with* probabilities. *Watts.*

2.† To lodge; to dwell.—*To take with*, to please. The proposal *takes well with* him.

**TAKE-IN**, *n.* Fraud; a cheating act.—2. The party cheating. [*In both senses familiar.*]

**TAKEN**, (ta'kn.) *pp.* of *Take*. Received; caught; apprehended; captivated, &c.

**TAKER**, *n.* One that takes or receives;

one who catches or apprehends.—2. One that subdues and causes to surrender; as, the *taker* of captives or of a city.

**TAKING**, *ppr.* Receiving; catching; getting possession; apprehending.—2. *a.* Alluring; attracting; engaging; pleasing.—3. Infectious; as, the itch is very *taking*. [*Familiar and Local.*]

**TAKING**, *n.* The act of gaining possession; a seizing; seizure; apprehension.

—2. Agitation; distress of mind.

What a *taking* was he in, when your husband asked what was in the basket? *Shak.*

**TAK'INGLY**, *adv.* In a taking or attractive manner.

**TAKINGNESS**, *n.* The quality of pleasing, or of being engaging.

**TAL'APOIN**, } *n.* In Siam and Burmah,  
**TEL'APOIN**, } a name given, by some European nations, to a priest. Also, a species of monkey.

**TALA'RIA**, *n.* [L.] In antiquity, the small wings attached to the ankles of Mercury, and reckoned among his attributes.

**TAL'BOT**, *n.* A kind of hound, and probably the oldest of our slow hounds. He had a broad mouth; very deep chops; very long and large pendulous ears; was fine coated and usually pure white. This was the hound formerly known as St. Hubert's breed, and it is probably the origin of the present blood-hound.

**TAL'BOTYPE**, *n.* A photogenic process invented by Mr. H. Fox Talbot, in which paper, prepared in a particular manner, is used instead of the silvered plates of M. Daguerre. The process has also been termed *calotype*. [See **DAGUERREOTYPE**, **PHOTOGENIC DRAWINGS**.]

**TALÉ**, *n.* [G. *talk*, isinglass; *talg*, tallow; Sw. *talk*, *talg*, id.; Dan. *talg*, *talg*, tallow; and *talk*, *talgsteen*, tallow-stone; D. *talk*, tallow; Port. and Sp. *talco*.]

A magnesian mineral, consisting of broad, flat, smooth laminae or plates, unctuous to the touch, of a shining lustre, translucent, and often transparent. By the action of fire, the laminae open a little, the fragment swells, and the extremities are with difficulty fused into a white enamel. When rubbed with resin, talc acquires positive electricity. Its prevailing colours are white, apple-green, and yellow. There are three principal varieties of talc, *common*, *earthy*, and *indurated*. Its constituents are silicæ and magnesia, with small quantities of potash, alumina, oxide of iron, and water. It is used in many parts of India and China, as a substitute for window glass; indurated talc is used for tracing lines on wood, cloth, &c., instead of chalk. Talc is met with in several parts of Scotland, chiefly in connection with serpentine, and on the Continent. Several varieties are found in India and Ceylon.

**TALC'TE**, *n.* In *mineral*, the same as *natrite*,—*which see*.

**TALCKY**. See **TALCOSE**.

**TALC'OSE**, **TALC'OUS**, **TALC'Y**, or **TALCK'Y**, *a.* Like talc; consisting of talc; containing talc.

**TALE**, *n.* [See **TELL**.] A story; a narrative; the rehearsal of a series of events or adventures, commonly some

trifling incidents; or a fictitious narrative; as, the *tale* of a tub; Marmon-tel's *tales*; idle *tales*; Luke xxiv. In general, tales may be considered as simple fictitious narratives, in prose or verse, which hardly extend beyond a single adventure; or group of incidents; without the variety of plot and character which characterize the novel and the romance.

We spend our years as a *tale* that is told; Ps. xc.

2. Oral relation.—3. Reckoning; account set down; Exod. v.

In packing, they keep a *just tale* of the number. *Cicero.*

4. Number reckoned.

The ignorant who measure by *take*, not by weight. *Hooker.*

5. A telling; information; disclosure of any thing secret.

Birds are aptest by their voice to tell *tales* what they find. *Baron.*

In thee are men that carry *tales* to shed blood; Ezek. xxii.

6. In *law*, a count or declaration. [*Tale*, in this sense, is obsolete.]—7. In *com.*, a weight for gold and silver in China and other parts of the East Indies; also, a money of account. In China, each tale is 10 maces=100 candareens=1000 cash.

**TALE**, *† v. i.* To tell stories.

**TALEBEARER**, *n.* [*tale* and *bear*.] A person who officiously tells tales; one who impertinently communicates intelligence or anecdotes, and makes mischief in society by his officiousness.

Where there is no *talbearer*, the strife ceaseth; Prov. xxvii.

**TALEBEARING**, *a.* Officiously communicating information.

**TALEBEARING**, *n.* The act of informing officiously; communication of secrets maliciously.

**TA'LED**, *n.* A sort of habit worn by the Jews.

**TALEFUL**, *a.* Abounding with stories.

**TALENT**, *n.* [L. *talentum*; Gr. *ταλαντον*, from *ταλαω*, to bear, allied to L. *tollo*. The word is said to have originally signified a balance or scales.] 1. Among the ancients, a weight, and a coin. The true value of the talent cannot well be ascertained, but it is known that it was different among different nations. The Attic talent, the weight, contained 60 Attic minæ, or 6000 Attic drachmæ, equal to 56 pounds, eleven ounces, English troy weight. The mina being reckoned equal to £3 4s. 7d. sterling, the talent was of the value of £193 15s. sterling. Other computations make it £243 15s. sterling. The Romans had the great talent and the little talent; the great talent is computed to be equal to £99 6s. 8d. sterling, and the little talent to £75 sterling.—2. *Talent*, among the Hebrews, was also a gold coin, the same with a shekel of gold; called also *stater*, and weighing only four drachmas. But the Hebrew talent of silver, called *ciccar*, was equivalent to three thousand shekels, or ninety-three pounds, twelve ounces avoirdupois, and its value as silver money, £396 5s. 10d.—3. Faculty; natural gift or endowment; a metaphorical application of the word, said to be borrowed from the Scriptural parable of the talents; Matth. xxv.

He is chiefly to be considered in his three different *talents*, as a critic, a satirist, and a writer of odes. *Dryden.*

†Is not my *talent* to conceal my thoughts. *Addison.*

4. Eminent abilities; superior genius; as, he is a man of *talents*. [*Talent*, in the singular, is sometimes used in a like sense.]—5. Particular faculty; skill. He has a *talent* at drawing.—6. [Sp. *talante*, manner of performing any thing, will, disposition.] Quality; disposition.

**TALENTED**, *a.* Furnished with talents; possessing skill or talents. [This word is formed like a participle, but without a verb, like *bigoted*, *turreted*, *targeted*.]

**TALLES**, *n.* [L. *talis*, plur. *tales*.] In law, *tales de circumstantibus*, spectators in court, from whom the sheriff is to select men to supply any defect of jurors who are impanneled, but who may not appear, or may be challenged. In practice, this seldom occurs, except in the case of special jury trials, when the talesmen are taken from the common jury panel in the same court.—*Talesmen*, persons selected to fill up a jury in the case above stated. *Tales book*, a book containing the names of such as are admitted of the *tales*.

**TALESMAN**, *n.* In *English law*, a person summoned to act as a juror from among the by-standers in open court.

**TALTELLER**, *n.* One who tells tales or stories.

**TALE-WISE**, *a.* Being in the manner of a tale.

**TALIAOTIAN OPERATION**. A surgical operation for the restoration of lost noses. It is so named from the discoverer Taliacotius or Tagliacozzi, professor of anatomy and surgery at Bologna, towards the end of the 16th century. The operation, according to the discoverer's method, is effected by partially detaching a portion of the skin of the arm, moulding it into the proper shape, causing adhesion, and, after a time, finally detaching it from the arm, so that it remains in its new situation. Of late years several successful operations for new noses have been performed, and this is now always done by turning down a flap of integument from the forehead.

**TALIERA**, } *n.* The *Corypha*  
**TALLIERA PALM**, } *talliera*, an elegant stately species of palm inhabiting Bengal. It has gigantic fan-shaped leaves, which are used by the natives of India to write upon with their steel stiles, and for other purposes.

**TALIO, LEX TALIONIS**. [L.] The law of retaliation, according to which the punishment inflicted is the same in kind and degree as the injury; as an eye for an eye, a tooth for a tooth, &c. This mode of punishment was established by the Mosaic law; Lev. xxiv. 20.

**TALION**, *n.* Law of retaliation.  
**TALIPAT**, } *n.* The *Corypha*  
**TALIPUT PALM**, } *umbraculifera*; a gigantic palm, inhabiting Ceylon, with immense fan-shaped leaves resembling those of the Talliera Palm. [See *FAN PALM*.]

**TALIPED**, *n.* [L. *talus*, an ankle, and *pes*, a foot.] The disease called *club-foot*; also, a person affected with this disease.

**TALISMAN**, *n.* [Gr. *τάλισμα*, tribute, or *εἰδωμόν*, accomplishment, both from *τάλιω*, to terminate. A term introduced into medicine by Apollonius of Lydiana.] 1. A magical figure cut or engraved under certain superstitious observances of the configuration of the heavens, to

which wonderful effects are ascribed; or it is the seal, figure, character, or image of a heavenly sign, constellation, or planet, engraven on a sympathetic stone, or on a metal corresponding to the star, in order to receive its influence. The talismans of the Samothracians were pieces of iron, formed into images and set in rings, &c. They were held to be preservatives against all kinds of evils. Talismans are of three kinds, *astronomical*, *magical*, and *mixed*. Hence,—2. Something that produces extraordinary effects; as, a *talisman* to destroy diseases.

**TALISMAN'IC**, } *a.* Magical; hav-  
**TALISMAN'ICAL**, } ing the properties of a talisman or preservative against evils by secret influence.

**TALK**, *v. i.* (tauk.) [Dan. *tolker*; Sw. *tolha*, to interpret, translate, explain; D. *tolken*, id.; Russ. *tolkuyti*, id. This is probably the same word differently applied. The word is formed from *tell*. See *TELL*, for the Danish and Swedish.] 1. To converse familiarly; to speak, as in familiar discourse, when two or more persons interchange thoughts.

I will buy with you, sell with you, *talk* with you, but I will not eat with you.

*Shak.*

In Æsop's time

When all things *talk'd*, and *talk'd* in rhyme.  
*Trumbull.*

I will come down and *talk* with thee;  
Numb. xi.

Did not our hearts burn within us, while he *talked* with us by the way? Luke xxiv. 2. To prate; to speak impudently.—3. To *talk of*, to relate; to tell; to give account. Authors *talk of* the wonderful remains of Palmyra.

The natural histories of Switzerland *talk* much of the fall of these rocks, and the great damage done.  
*Addison.*

So shall I *talk of* thy wondrous works;  
Ps. cxix.

4. To speak; to reason; to confer.  
Let me *talk* with thee of thy judgments;  
Jer. xii.

To *talk to*, in familiar language, to advise or exhort; or to reprove gently. I will *talk to* my son respecting his conduct.

**TALK**, *n.* (tauk.) Familiar converse; mutual discourse; that which is uttered by one person in familiar conversation, or the mutual converse of two or more.

Should a man full of *talk* be justified?  
Job xi.  
In various *talk th'* instructive hours they  
past.  
*Pope.*

2. Report; rumour.  
I hear a *talk* up and down of raising money.  
*Locke.*

3. Subject of discourse. This noble achievement is the *talk* of the whole town.—4. Among the *Indians of North America*, a public conference, as respecting peace or war, negotiation and the like; or an official verbal communication made from them to another nation or its agents, or made to them by the same.

**TALKATIVE**, *a.* (tauk'ativ.) Given to much talking; full of prate; loquacious; garrulous. One of the faults of old age is to be *talkative*.

**TALKATIVELY**, *adv.* In a talkative manner.

**TALKATIVENESS**, *n.* (tauk'ativeness.) Loquacity; garrulity; the practice or habit of speaking much in conversation.

**TALKER**, *n.* (tauk'er.) One who talks;

also, a loquacious person, male or female; a prattler.—2. A boaster.

**TALKING**, *ppr.* (tank'ing.) Conversing; speaking in familiar conversation; Matth. xvii.—2. *a.* Given to talking; loquacious; *as, talking* age.

**TALKING**, *n.* (tank'ing.) The act of conversing familiarly; *as, foolish talking*; Eph. v.

**TALKY**, *a.* (tank'y.) Talkative. [*Vulgar.*]

**TALL**, *a.* [W. *tal*; *tallu*, to grow tall. The primary sense is to stretch or extend; W. *telhu*, to stretch; Sp. *talla*, raised work, also stature; *talle*, shape, size; *tallo*, a shoot or sprout; *talludo*, tall, slender; *talon*, the heel, that is, a shoot; Port. *talo*, a stalk; *taludo*, stalky; Ar. *talla*, to be long, to spread, to be extended, to defer or delay, that is, to draw out in time, Eng. *dally*, allied probably to L. *tallo*, Gr. *τάλλω*. In Sw. *tall* is a pine-tree.] 1. High in stature; long and comparatively slender; applied to a person, or to a standing tree, mast, or pole. *Tall* always refers to something erect, and of which the diameter is small in proportion to the height. We say, a *tall* man or woman, a *tall* boy for his age; a *tall* tree, a *tall* pole, a *tall* mast; but we never say, a *tall* house or a *tall* mountain. The application of the word to a palace or its shadow, in Waller, is now improper.

Dark shadows cast, and as his palace *tall*.  
*Waller.*

2. Sturdy; lusty; bold. [*Unusual.*]

**TALLAGE**, } *n.* [Fr. *tailleur*, to cut off.  
**TALLIAGE**, } See *TALL*.] Anciently, a general word including all subsidies, taxes, tenths, fifteenths, or other burdens or charges laid upon any person. It was generally, however, confined in its sense to taxes received by the king. When it was paid out of knight's fees, it was called *scutage*; when by cities and burghs, *talliage*; when upon lands not held by military tenure, *hidage*.

**TALLAGE**, *v. t.* To lay an impost.  
**TALLIED**, *pp.* Scored with corresponding notches; fitted; suited.

**TALLIER**, *n.* One who keeps a tally. From this word is derived our modern word *teller*. [See *TALLY*.]

**TALLNESS**, *n.* Height of stature. [See *TALL*.]

**TALLOW**, *n.* [Dan. *tælg*; D. *talk*; G. and Sw. *talg*; Eth. *talal*, to be fat; Ar. *talla*, to be moist.] The fat of oxen, sheep, deer, and goats, melted and separated from the fibrous, or membranous matter which is naturally mixed with it. When pure, tallow is white and nearly tasteless; but the tallow of commerce usually has a yellow tinge. All the different kinds of tallow consist chiefly of stearine with a little oleine; but that of the goat contains also hircine in small quantity. In *com.*, tallow is divided into various kinds according to its qualities, of which the best are used for the manufacture of candles, and the inferior for making soap, greasing machinery, and several other purposes. Tallow is also much used in the dressing of leather. It is imported in large quantities from Russia. The fat of swine we never call *tallow*, but *lard*. The fat of bears we call bear's grease.—*Mineral tallow*, the same as hatchetina,—*which see*.

**TALLOW**, *v. t.* To grease or smear with tallow.

**TALLOW-CANDLE**, *n.* A candle made of tallow.

**TAL/LOW-CATCH**, † *n.* A receptacle for tallow.

**TAL/LOW-CHÄNDLER**, *n.* [*chandler* is generally supposed to be from the Fr. *chandelier*, and the word to signify *tallow-candler*, a maker of candles; for in Fr. *chandelier* is a tallow-chandler. See **CORN-CHANDLER**.] One whose occupation is to make, or to make and sell tallow candles.

**TAL/LOWED**, *pp.* Greased or smeared with tallow.

**TAL/LOW-FACED**, *a.* Having a sickly complexion; pale.

**TAL/LOW-GREASE**, *n.* Tallow, especially candle-fat. [*Familiar*, and *local*.]

**TAL/LOWING**, *ppr.* Greasing with tallow.

**TAL/LOWISH**, *a.* Having the properties or nature of tallow.

**TAL/LOW-TREE**, *n.* A tree of the genus *Stillingia*, the *S. sebifera*, growing in China. [See **STILLINGIA**.]

**TAL/LOWY**, *a.* Greasy; having the qualities of tallow.

**TAL/LY**, *n.* [Fr. *tailleur*, Port. *talhar*, Sp. *tallar*, to cut. See **TAIL**.] 1. A piece of wood on which notches or scores are cut, as the marks of number. In purchasing and selling, it was customary for traders to have two sticks, or one stick cleft into two parts, and to mark with scores or notches on each, the number or quantity of goods delivered, or what was due between debtor and creditor, the seller or creditor keeping one stick, and the purchaser or debtor, the other. Before the use of writing, or before writing became general, this or something like it, was the usual method of keeping accounts, and it is still customary among small publicans, milk-men and others, to keep the account or score of a debt by notches. In the Exchequer, *tallies* were formerly used, which answered the purpose of receipts as well as simple records of matters of account. Hence the origin of exchequer *bills*. In former times of financial difficulty, (from the period of the Norman conquest,) the practice had been to issue exchequer *tallies*. An exchequer tally was an account of a sum of money lent to the government, or of a sum for which the government would be responsible. The tally itself consisted of a squared rod of hazel or other wood, having on one side notches, indicating the sum for which the tally was an acknowledgment. On two other sides opposite to each other, the amount of the sum, the name of the payer, and the date of the transaction, were written by an officer called the writer of the tallies. This being done the rod was then cleft longitudinally in such a manner that each piece retained one of the written sides, and one half of every notch cut in the tally. One of these parts was kept in the exchequer, and the other only issued. When the part issued was returned to the exchequer (usually in payment of taxes), the two parts were compared, as a check against fraudulent imitation. Hence our corresponding practice with cheques, and the origin of the term we employ when we say, that a cheque should *tally* with its counterpart. Hence also the terms "Bill," Norman French, *bille*, a baton; *billet*, a short piece of wood, and the origin of the phrase, being on the "staff," as applied to officers in the pay of the crown. The size of the notches made on the tallies varied with the

amount. The notch for £100 was the breadth of a thumb; for £1 the breadth of a barley corn. A penny was indicated by a slight slit. Clumsy as this contrivance may appear, it was effectual in the prevention of forgery. Tallies were finally discontinued in the exchequer in 1834. The *tellers* of the exchequer derived their name from the word *tally*, teller being originally written *tallier*. Many different kinds of tally are used in gardens and arbo-retums, for the purpose of bearing either numbers referring to a catalogue, or the names of the plants near which they are placed. It is quite an error to suppose that promissory notes, supported by the credit of government, are a modern invention. They existed for six centuries in this country before the introduction of paper-money; the only difference between the modern and the ancient system is, that the promissory notes which are now made of paper, were formerly made of wood.—2. One thing made to suit another. They were framed the *tallies* for each other.

*Dryden.*

**TAL/LY**, *v. t.* To score with corresponding notches; to fit; to suit; to make to correspond.

They are not so well *tallied* to the present juncture. *Pope.*

2. In *seamanship*, to pull aft the sheets or lower corners of the main and fore sail.

**TAL/LY**, *v. i.* To be fitted; to suit; to correspond.

I found pieces of tiles that exactly *tallied* with the channel. *Addison.*

**TAL/LY**, † *adv.* Stoutly; with spirit.

**TAL/LY HO**, the huntsman's cry to his hounds.

**TAL/LYING**, *ppr.* Fitting to each other; making to correspond.—2. Agreeing; corresponding.—3. Hauling aft the corners of the main and fore sail.

**TAL/LYMAN**, *n.* [*tally* and *man*.] One who sells for weekly payment.—2. One who keeps the tally, or marks the sticks.

**TAL/LY-SHOP**, *n.* A shop or store at which goods or articles are sold on the tally system. [See **TALLY TRADE**.]

**TAL/LY TRADE**, *n.* A system of dealing carried on in London and other large towns, by which shopkeepers furnish certain articles on credit to their customers, the latter agreeing to pay the stipulated price by certain weekly or monthly instalments. The goods thus furnished are usually of inferior quality, and the prices exorbitant. The system is fraught with much mischief to those (chiefly mechanics, labourers, porters, &c.) who resort to tally-shops.

**TAL/MUD**, *n.* [Ch. from לָמַד *lamad*, to teach.] The body of the Hebrew laws, traditions, and explanations; or the book that contains them. The Talmud contains the laws, and a compilation of expositions of duties imposed on the people, either in scripture, by tradition, or by authority of their doctors, or by custom. It consists of two parts, the *Mishna* and the *Gemara*; the former being the *written* law, and the latter a collection of traditions and comments of Jewish doctors.

**TAL/MUDIC**, } *a.* Pertaining to the  
**TAL/MUDICAL**, } Talmud; contained in the Talmud; as, *Talmudic* fables.

**TAL/MUDIST**, *n.* One versed in the Talmud.

**TALMUDIST'IC**, *a.* Pertaining to the Talmud; resembling the Talmud.

**TAL/ON**, *n.* [Fr. and Sp. *talón*, the

heel, that is, a shoot or protuberance. See **TALL**.] 1. The claw of a fowl.—2. In *arch.*, the name given by the French to the ogee moulding.

**TALOOK'DARS**, *n.* In *India*, petty zemindars, some of whom pay their rent through a superior zemindar, while others pay it directly to government.

**TAL/PA**, *n.* [L.] The mole, a genus of insectivorous mammalia. The common mole (*T. europæa*, Linn.) is well known from its subterranean habits, and its vexatious burrowings in cultivated grounds. Another species, *T. caeca*, inhabits the south of Europe.

**TAL/PID'Æ**, *n.* The family of moles.

**TAL/LUS**, *n.* [L. *talus*, the ankle.] 1. In *anat.*, the astragalus, or that bone of the foot which is articulated to the leg.—2. In *arch.*, a slope; the inclination of any work.—3. In *fort.*, the slope of a work, as a bastion, rampart, or parapet. The upper surface of a parapet is called the *superior talus* or slope; and that surface of a rampart or parapet which is towards the country, or towards the town, is called the *exterior*, or the *interior talus* of the work. In this signification the word is also written *Talut*.—4. In *geol.*, a sloping heap of broken rocks and stones, at the foot of any cliff.

**TAMABILITY**, *n.* Tamableness,—which see.

**TAMABLE**, *a.* [from *tame*.] That may be tamed; capable of being reclaimed from wildness or savage ferociousness; that may be subdued.

**TAMABLENESS**, *n.* The quality of being tamable.

**TAM'ARACK**, *n.* Hackmatack; the American larch.

**TAMARICA'CEÆ**, *n.* A small nat. order of polypetalous exogens. The species are either shrubs or herbs, inhabiting chiefly the basin of the Mediterranean. They are all more or less astringent; and their ashes, after burning, are remarkable for possessing a large quantity of sulphate of soda. [See **TAMARISK**.]

**TAMARIN**, *n.* A small monkey of South America with large ears; the great eared monkey, *Simia midas*.

**TAMARIND**, *n.* [Sp. *tamarindo*; Port. *plur. tamarindos*; It. *tamarino*, *tamarindi*; Fr. *tamarin*; said to be a compound of תָּמָר *tamar*, the palm-tree, and *indus* or *ind*, the root of *India*.] *Tamarindus*, a genus of plants belonging to the nat. order Leguminosæ.



Tamarind (*Tamarindus indica*).

There are only two species, both of which are trees having abruptly pinnate leaves, and bearing many pairs of

small leaflets and racemes of flowers. The *T. indica*, or East Indian tamarind, is a native of various districts of the East Indies, and also of the tropical parts of Africa. It forms a handsome tree, with spreading branches. The *T. occidentalis*, or West Indian tamarind, is distinguished from the other by possessing short legumes. It is a native of South America and the West India islands, forming also a large spreading tree. Both species are cultivated for the sake of their shade, and their cooling, grateful acid fruit, which is a one-celled legume, with from three to six seeds, the valves being filled with pulp between the endocarp and epicarp. The pulp, dried or packed with sugar or syrup, is imported into European countries. [See TAMARINDS.]

**TAMARINDS**, *n. plur.* The preserved fruit of the East and West Indian tamarind trees; that of the former being much larger than that of the latter. In the East Indies the pulp is dried either in the sun or artificially with salt added, which latter kind is sent to Europe. The West Indian tamarinds are put into jars, with layers of sugar between them, or with boiling syrup poured over them, and are called prepared tamarinds; but the East Indian tamarinds are most esteemed. Tamarinds have a sharp, penetrating, and agreeable acid taste, softened by a sweetish one. The pulp is frequently employed in medicine; it is cooling and gently laxative, and is peculiarly grateful in fevers and inflammatory diseases.

**TAMARISK**, *n.* Tamarix, a genus of plants, the type of the nat. order Tamaricaceae. The species are shrubs or small trees, clothed with very small green leaves, and long spikes of pink flowers. *T. gallica* is a native of



Tamarisk (Tamarix gallica).

France and of the Mediterranean, and is also found in England. Its ashes contain a large quantity of sulphate of soda. *T. indica*, or the Indian tamarisk, produces galls which are used in dyeing. The largest and most elegant species is the *T. orientalis*, a native of Arabia, Persia, and the East Indies. The bark of *T. africana* is used in medicine as a tonic, and its ashes, like those of *T. gallica*, yield a large quantity of sulphate of soda.

**TAMBAC**, } *n.* The white copper of  
TOMBAC, } the Chinese, which is a mixture of copper, nickel, and zinc, with a small proportion of iron. It is malleable, and very sonorous.—2. Agalochum, or aloes wood.

**TAMBOUR**, *n.* [Sp. and Port. *tambor*, a drum; It. *tamburo*. The *m* is probably casual. See TABOUR.] 1. A small drum, used by the Biscayaans as an accompaniment to the flageolet; a tambourine.—2. In *arch*, a term applied to the naked part of Corinthian and Composite capitals, which bear some resemblance to a drum. It is also called the vase, and campana, or the bell. Also, the wall of a circular temple surrounded with columns, and the circular vertical part of a cupola, both below and above it.—3. A little box of timber work covered with a ceiling, within the porches of certain churches.—4. A cylindrical stone, such as one of the courses of the shaft of a column.—5. In the arts, a species of embroidery, in which threads of silk, gold, or silver, are worked by needles of a peculiar form into leaves, flowers, &c., upon a stuff of silk, linen, or muslin, stretched over a circular frame, which is properly the *tambour*, and so named from its resemblance to a drum. Machines have, of late years, been constructed for tambour-working.—6. In *fort*, a kind of work formed of palisades, or pieces of wood ten feet long planted closely together, and driven firmly into the ground.

**TAMBOUR**, *v. t.* To embroider with a tambour.

**TAMBOURINE**, *n.* (tambureen.) [Fr. *tambourin*, from *tambour*, tabor; Sp. *tamboril*. See TABOR.] 1. A musical instrument of the drum species. It is much used among the Biscayaans, and hence is known by the name of *tambour de Basque*. It consists of a piece of parchment stretched over the top of a broad hoop, which is furnished with little bells. It is sounded by sliding the fingers along the parchment, or by striking it with the back of the hand, or with the fist or the elbow. The same name is given to a kind of drum much used in Provence. Its case is longer and somewhat narrower than that of the common drum. It is beaten with a drumstick, while the performer at the same time plays with his left hand upon a small flute.—2. A lively French dance, formerly in vogue in operas.

**TAMBOURNE**, *n.* [Ital.] The Italian name for the military bass-drum. [See TIMBREL.]

**TAMBOUR-WORK**, *n.* A kind of embroidery. [See TAMBOUR.]

**TAME**, *a.* [Sax. *tam*; Sw. *tam*, *tamd*; G. *zahn*. See the verb.] 1. That has lost its native wildness and shyness; mild; accustomed to man; domestic; as, a tame deer; a tame bird.—2. Crushed; subdued; depressed; spiritless.

And you, tame slaves of the laborious plough. Roscommon.

3. Spiritless; unanimated; as, a tame poem. [Not elegant nor in use.]

**TAME**, *v. t.* [Sax. *tamian*, *getemian*; Goth. *ga-tamyan*; D. *tammen*; G. *zahn*; M. *domo*; Gr. *domos*; Fr. *dampier*; It. *domare*; Ch. and Heb.  $\text{דָּמַם}$ , *dum*, to be silent, dumb; or Ar. *kathama*, to restrain, to stop, shut, silence, subdue, tame.] 1. To reclaim; to reduce from a wild to a domestic state; to make gentle and familiar; as, to tame a wild beast.—2. To civilize; as, to tame the ferocious inhabitants of the forest.—3. To subdue; to conquer; to depress; as, to tame the pride or passions of youth.—4. To subdue;

to repress; as wildness or licentiousness.

The tongue can no man tame; James iii. **TAMED**, *ppr.* Reclaimed from wildness; domesticated; made gentle; subdued.

**TAMELESS**, *a.* Wild; untamed; untamable. [Not much used.]

**TAMELY**, *adv.* With unresisting submission; meanly; servilely; without manifesting spirit; as, to submit tamely to oppression; to bear reproach tamely.

**TAMENESS**, *n.* The quality of being tame or gentle; a state of domestication.—2. Unresisting submission; meanness in bearing insults or injuries; want of spirit.

**TAMER**, *n.* One that tames or subdues; one that reclaims from wildness; as, Messrs. Van Amburgh and Carter are famed for being lion tamers.

**TAMIAS**, *n.* The generic name of the ground-squirrels.

**TAMINE**, } *n.* A strainer or bolter of  
TAMMY, } hair.—2. A tamis,—which  
see.—3. A thin woollen or worsted stuff, highly glazed.

**TAMING**, *ppr.* Reclaiming from a wild state; civilizing; subduing.

**TAMIS**, *n.* [Fr.] A worsted cloth, used for the purpose of straining sauces.

**TAMIS-BIRD**, *n.* A Guinea fowl.

**TAMKIN**, *n.* The stopper of a cannon. [See TAMPION.]

**TAMP**, *v. t.* To fill up a hole bored in a rock, for the purpose of blasting it.

**TAMPER**, *v. i.* To meddle; to be busy; to try little experiments; as, to tamper with a disease.—2. To meddle; to have to do with without fitness or necessity.

'Tis dangerous tam'ring with a muse. Roscommon.

3. To deal; to practise secretly.

Others tampered  
For Fleetwood, Desborough, and Lambert.  
Hudibras.

**TAMPING**, *ppr.* Meddling; dealing; practising secretly.

**TAMPERING**, *n.* The act of meddling or practising secretly.

**TAMP'ING**, *n.* [Fr. *tampion*?] A term used by miners to express the operation of filling up the hole bored in a rock, for the purpose of blasting it with gunpowder. The powder being first put into the hole, and a tube for a conductor of the fire, the hole is rammed to fulness with brick-dust or other matter. The same name is given to the matter thus employed.

**TAMPION**, } *n.* [Fr. *tampion*; Arm.  
TOMPION, } *tapon*.] The stopper of a cannon or other piece of ordnance, consisting of a cylinder of wood placed in its muzzle to prevent the admission of water.

**TAMPOE**, } *n.* The fruit of the *He-*  
TAMPUI, } *dycarpus malayanus*, a sapidaceous plant, found plentifully in the islands of the Indian Archipelago. Tampoe is much esteemed in the East as an edible fruit.

**TAMPOON**, } *n.* A tampion.—2. The  
bung of a vessel.

**TAM-TAM**, } *n.* A kind of native  
TOM-TOM, } drum used in the East Indies and in Western Africa. The *tam-tam* is of various shapes; but, generally, it is made of a hollow cylinder, formed of fibrous wood, such as palm-tree, or of earthen ware, each end covered with skin. It is beat upon with the fingers, and also with the open hand, and produces a hollow monotonous sound. Public notices,

when proclaimed in the bazaar or public parts of Eastern towns, are generally



Various forms of Indian Tam-tams.

accompanied by the tam-tam. This is called proclamation by tam-tam.

**TAMUS**, *n.* A genus of plants, nat. order Dioscoreaceæ. The *T. communis*, or common black bryony, is a very common plant in hedges and thickets throughout Europe, and is very frequent in England. It is a climbing herbaceous plant, having very large tubers and red berries. The whole plant contains a bitter acrid principle, which renders it unwholesome.

**TAN**, *v. t.* [Fr. *tanner*, to tan; *tanne*, a little black spot on the face; *It. tane*, tawny colour. Gregoire, in his *Armoric Dictionary*, suggests that this may be from *tan* or *dan*, which in Leon signifies an oak. But this is very doubtful. In *Ir. tianus* signifies a *tan-house*, and *tionsonaim*, is to drop or distil. *Spotting* is often from sprinkling, and *dyeing* from dipping. In Gaelic, *dean* is colour. It seems to be allied to *tawny*, and perhaps to *dun*.] 1. In the arts, to convert animal skins into leather by steeping them in an infusion of oak or some other bark, by which they are impregnated with tannin or tannic acid, an astringent substance which exists in several species of bark, and thus rendered firm, durable, and in some degree impervious to water.—2. To make brown; to imbrown by exposure to the rays of the sun; as, to *tan* the skin.

His face all *tann'd* with scorching sunny rays. *Spenser.*

**TAN**, *n.* The bark of the oak, willow, chestnut, larch, and other trees abounding in tannin, bruised and broken by a mill, and used for tanning hides. It bears this name before and after it has been used. *Tan*, after being used in tanning, is used in gardening for making hot-beds; and it is also made into cakes and used as fuel. In some places, such cakes are commonly, but improperly, called *turf*; thus confounding it with peat fuel, which, however, it somewhat resembles.

**TANACE'TINE**, *n.* A non-azotized compound obtained from *Tanacetum vulgare*. It is very bitter, and soluble in alcohol, but its nature has not yet been ascertained.

**TANACE'TUM**, *n.* A genus of plants, nat. order Compositæ, sub-order Corymbifera. *T. vulgare*, or common tansy, is a well-known plant, being abundant in Britain, and throughout Europe, on the borders of fields and road sides. Every part of the plant is bitter, and it is considered as tonic and cordial, and has been administered in medicine in cases of worms and hysteria. The young shoots yield a green colouring-matter, used by the Finlanders for

dyeing their cloth of that colour. It is said that if meat be rubbed with the fresh leaves, the flesh-fly will not touch it.

**TAN'AGRA**, } *n.* A genus of passerine  
**TAN'AGERS**, } birds of the dentirostral family, placed, in Cuvier's system, between the fly-catchers and thrushes.

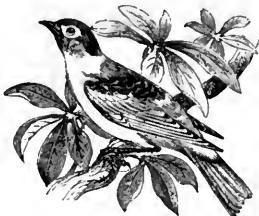

Tanager (*Tanagra cyanocephala*).

There are several species, all resembling the finches in their habits. They are remarkable for their bright colours. They are chiefly inhabitants of the tropical parts of America.

**TANAGRINÆ**, *n.* The family of the tanagers.

**TAN'-BED**, *n.* [*tan* and *bed*.] In gardening, a bed made of tan; a bark bed or stove.

**TAN'-HOUSE**, *n.* A building in which tanner's bark is stored.

**TAN'-PIT**, *n.* [*tan* and *pit*.] A bark pit; a vat in which hides are laid in tan.

**TAN'-SPUD**, *n.* [*tan* and *spud*.] An instrument for peeling the bark from oak and other trees. [*Local*.]

**TAN'-STOVE**, *n.* [*tan* and *stove*.] A hot-house with a bark stove. Also the stove itself.

**TAN'-VAT**, *n.* [*tan* and *vat*.] A vat in which hides are steeped in liquor with tan.

**TAN'-YARD**, *n.* An inclosure where the tanning of leather is carried on.

**TAN'DEM**. [*Horseman's Latin*.] Horses are harnessed *tandem* when they are placed single, one before another. But *tandem* properly refers to *time* and not to *length of line*.

**TÂNE**, † *pp.* for *t'ên*, taken.

Two trophies *tane* from th' east and western shore,

And both these nations twice triumphed o'er. *May, Virg.*

**TANG'**, *n.* [Gr. *ταγγη*, rancour; *ταγγος*, rancid; *It. tanfo*.] 1. A strong taste; particularly, a taste of something extraneous to the thing itself; as, wine or cider has a *tang* of the cask.—2. Relish; taste. [*Not elegant*.]—3. Something that leaves a sting or pain behind. She had a tongue with a *tang*. *Shak.*

4. † Sound; tone.—5. In *carpentry*, the part of chisels and similar tools which is inserted into the handle.

**TANG**, † *v. t.* To ring with; to have the twang or sound of. [This may be allied to *ding, dong*.]

**TAN'GENCIES**, *n.* Among the ancient geometers, the *problem of tangencies* was a branch of the geometrical analysis, the general object of which was to describe a circle passing through given points, and touching straight lines or circles given in position, the number of data being always limited to three.

**TAN'GENCY**, *n.* A contact or touching.

**TAN'GENT**, *n.* [Fr. *tangente*; *L. tangens*, touching. See *TOUCH*.] In *geom.*,

a straight line which touches or meets a circle or curve in one point, and which being produced, does not cut it. Euclid has shown, that the straight line drawn at right-angles to the diameter of a circle, from the extremity of it, is a tangent to the circle. In *trigonometry*, the tangent of an arc or angle is a straight line touching the circle of which the arc is a part, at one extremity of the arc, and meeting the diameter passing through the other extremity. Thus, in the figure let

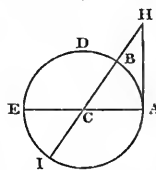

A H be a straight line drawn touching the circle ADE at A, one extremity of the arc A B, and meeting the diameter I B produced, which passes through the other extremity B in the

point H; then A H is the tangent of the arc A B, or of the angle A C B, of which A B is the measure. The tangent of an arc or angle is also the tangent of its supplement. Thus, A H is the tangent of the supplement A I, or of the angle A C I; for it is easy to see, that the definition above given applies equally to the arc A B and to the arc A I. The arc and its tangent have always a certain relation to each other; and when the one is given in parts of the radius, the other can always be computed by means of an infinite series. For trigonometrical purposes tangents for every arc from 0 degrees to 90 degrees, as well as sines, cosines, &c., have been calculated with reference to a radius of a certain length, and these or their logarithms formed into tables. In the higher geometry, the word tangent is not limited to straight lines, but is also applied to curves in contact with other curves, and also to surfaces.—*Method of tangents*, the name given to the calculus in its early period. When the equation of a curve is given, and it is required to determine the tangent at any point, this is called the *direct method of tangents*; and when the subtangent to a curve, at any point, is given, and it is required to determine the equation of the curve, this is termed the *inverse method of tangents*. The above terms are synonymous with the differential and integral calculus.—*Tangent plane*, a plane which touches a curved surface; as a sphere, cylinder, &c.—*Natural tangents*, tangents expressed by natural numbers.—*Artificial tangents*, tangents expressed by logarithms.—*Line of tangents*, a line usually placed on the sector and Gunter's scale, by means of which the length of the tangent to any arc having a certain radius may be determined.—*Tangent screw*, a screw which acts in the direction of a tangent to an arc or circle. Such screws are used to adjust theodolites and other circular instruments. [See *WORM-WHEEL*.]

**TANGEN'TIAL**, *a.* Pertaining to a tangent; in the direction of a tangent.—*Tangential force*, in circular motion, the same as centrifugal force.

**TANGEN'TIALLY**, *adv.* In the direction of a tangent.

**TAN'GHIN**, *n.* A deadly poison obtained from the seeds of *Tanghinia venenifera*,—which see.—*Trial by tanghin*, a kind of ordeal in Madagascar, to determine the guilt or innocence

of an accused person, by taking the tanghin poison. The result is entirely in the power of the administrators, who kill or favour the party, according to circumstances.

**TANGHINIA**, *n.* A genus of plants belonging to the nat. order Apocynaceæ. *T. venenifera* is a tree which



*Tanghinia venenifera.*

produces the celebrated *tanghin* poison of Madagascar. The poisonous quality resides in the kernel, and one seed is said to be sufficient to kill twenty persons.

**TANGHININE**, } *n.* A non-azotized  
**TANGUINE**, } principle obtained  
from the seeds of *Tanghinia venenifera*.  
It is crystallizable, very bitter and  
acid, and also poisonous.

**TANGIBILITY**, } *n.* [from *tangible*.]  
**TANGIBLENESS**, } The quality of  
being perceptible to the touch or sense  
of feeling.

**TANGIBLE**, *a.* [from *L. tango*, to touch.] 1. Perceptible by the touch; tactile.—2. That may be possessed or realized.

**TANGIBLY**, *adv.* So as to be perceptible to the touch.

**TANGLE**, *v. t.* [This word, if *n* is casual, seems to be allied to the *W. tagu*, to choke, Goth. *taga*, hair; from crowding together. In *Ar. dagaa* signifies to involve.] 1. To implicate; to unite or knit together confusedly; to interweave or interlock, as threads, so as to make it difficult to unravel the knot.—2. To ensnare; to entrap; as, to be tangled in the folds of dire necessity.

*Tangled* in amorous nets. *Milton.*

3. To embroil; to embarrass.  
When my simple weakness strays,  
*Tangled* in forbidden ways. *Crashaw.*

[*Entangle*, the compound, is the more elegant word.]

**TANGLE**, *v. i.* To be entangled or united confusedly.

**TANGLE**, *n.* A knot of threads or other things united confusedly, or so interwoven as not to be easily disengaged; as, hair or yarn in *tangles*.—2. *Laminaria*, a genus of sea-weeds. [See LAMINARIA.]

**TANGLED**, *pp.* United confusedly.  
**TANGLING**, *ppr.* Uniting without order.

**TANGLINGLY**, *adv.* In a tangling manner.

**TANGLY**, *a.* Knotted; intertwined; intricate.

**TANGUM**, } *n.* The primeval stock of  
**TANGAN**, } the piebald horse, found  
in Thibet, of which it is a native. It  
appears to be related to the Tartar

horse, and to the Kiang, or wild horse of the Himalayas.



Tangum or Thibet Horse.

**TANIST**, *n.* [Gaelic, *tanaiste*, a lord, the governor of a country; in Ireland, the heir apparent of a prince; probably from *tan*, a region or territory, or from the Gr. *δυναστος*, a lord, which is from *δυναμις*, to be powerful or able, the root of the Gaelic *duine*, a man. But both may be of one family, the root *tan*, *ten*, Gr. *τενω*, *L. teneo*, *W. tannu*, to stretch, strain, or hold.] Among the descendants of the Celts in Ireland, a lord, or the proprietor of a tract of land; a governor or captain. This office or rank was elective, and often obtained by purchase or bribery.

**TANISTRY**, *n.* [Gaelic, *tanaisteachd*.] In Ireland, a tenure of lands by which the proprietor had only a life estate, and to this he was admitted by election. The primitive intention seems to have been that the inheritance should descend to the oldest or most worthy of the blood and name of the deceased. This was in reality giving it to the strongest, and the practice often occasioned bloody wars in families.

**TANK**, *n.* [Fr. *etang*, a pond; Sp. *estanque*; Port. *tanque*; Sans. *tanghi*; Japan, *tange*. This seems to be from the root of *stanch*, to stop, to hold.] A large basin or cistern; a reservoir for water or other fluids. Tanks are generally formed by making excavations in the earth, and lining the sides and bottom with bricks, stone, timber, cast-iron, or sheet-lead, or puddling them with clay. They are covered over, and used to collect and retain water and liquid manure, for domestic and agricultural purposes. In high mountainous pastures, tanks for collecting rain-water are indispensable to supply both men and cattle with water. The same name is sometimes applied to large open receptacles or ponds, formed by excavating the ground, and disposing the removed earth in the form of banks to retain the water.—2. In the *navy*, a case of sheet-iron for the stowage of the ship's water. It is generally about four feet square, and contains about two tons of water. Bilge tanks of various forms are also employed.

**TANKARD**, *n.* [Ir. *tancard*; Gaelic, *tancard*; *tank* and *ard*.] A large vessel for liquors, or a drinking vessel, with a cover.

Marius was the first who drank out of a silver *tankard*, after the manner of Bacchus. *Arbuthnot.*

**TANKE**, *n.* In *her.*, a kind of deep round cap, called also a *cap-tanke*. It was used by the ancient servile Romans.  
**TANLING**, *n.* One tanned or scorched by the heat of the sun.

**TANNA**, *n.* In *India*, a police station; also a military post.

**TANNADAR**, *n.* In *India*, the keeper or commandant of a *tanna*.

**TANNATE**, *n.* A salt formed by the union of tannic acid with a base; as, the *tannate* of potash or of magnesia. The tannates are characterized by striking a deep bluish black colour with the persalts of iron.

**TANNED**, *pp.* [from *tan*.] Converted into leather. [See *TAN*.]—2. Darkened by the rays of the sun.

**TANNER**, *n.* One whose occupation is to tan hides, or convert them into leather by the use of *tan*.

**TANNER'S-BARK**, *n.* The bark of the oak, chestnut, willow, and other trees, which abounds in tannic acid, and is employed by tanners in the preparation of leather. [See *TAN*.]

**TANNERERY**, *n.* The house and apparatus for tanning.

**TANNIC ACID**, or **TANNIN**, *n.* A peculiar acid which exists in every part of all species of oak, especially in the bark, but is found in greatest quantity in gall-nuts. Tannic acid, when pure, is nearly white, and not at all crystalline. It is very soluble in water, and has a most astringent taste without bitterness. It combines with animal gelatine, forming an insoluble curdy precipitate, which has been called *tannogelatin*. It derives its name from its property of combining with the skins of animals, and converting them into leather, or *tanning* them. Its ultimate elements are 30 atoms of carbon, 18 of hydrogen, and 24 of oxygen. It is the active principle in almost all astringent vegetables.

**TANNIER**, *n.* One of the popular names of the *Arum esculentum*, an esculent root.

**TANNIN**, *n.* The name formerly applied to the tannic acid, before its acid character was known and understood.—*Artificial tannin*, the name given by Mr. Hatchett to a brown substance obtained by digesting powdered charcoal in nitric acid, and evaporating the solution. It has an astringent taste, and forms an insoluble compound with gelatine.

**TANNING**, *ppr.* Converting raw hides into leather.

**TANNING**, *n.* The practice, operation, and art of converting the raw hides and skins of animals into leather, by effecting a chemical combination between the gelatine of which they principally consist, and the astringent vegetable principle called *tannic acid*, or *tannin*. The object of the tanning process is, to produce such a chemical change in skins as may render them unalterable by those agents which tend to decompose them in their natural state; and in connection with the subsequent operations of currying, or dressing, to bring them into a state of pliability and impermeability to water, which may adapt them for the many useful purposes to which leather is applied. The larger and heavier skins subjected to the tanning process, as those of buffaloes, bulls, oxen, and cows, are technically called *hides*; while those of smaller animals, as calves, sheep, and goats, are called *skins*. After being cleared of the hair, wool, and fleshy parts, by the aid of lime, scraping, and other means, the skins are usually steeped in an infusion of ground oak bark, which supplies the



astringent or tanning principle, and thus converts them into leather. Different tanners, however, vary much in the mode of conducting the process of tanning, and also the skins intended for different kinds of leather require to be treated differently. Various improvements have been made in the process of tanning, by which time and labour are much reduced, but it is found that the slow process, followed by the old tanners, produces leather far superior to that produced by quick processes.

**TAN'REC,** } *n.* The popular name of  
**TEN'REC,** } the several species of  
**TEN'DRAC,** } the insectivorous mam-  
malian genus *Centeres*, of which there  
are three species. They are small  
quadrupeds, inhabiting Madagascar  
and the Isle of France.

**TAN'SY,** *n.* (*s* as *z*.) [*Fr. tanaisie*; *It.*  
and *Sp. tanacetio*; *L. tanacetum*.] The  
popular name of a genus of plants.  
[See **TANACETUM**.]

**TANT,** *n.* A small spider with two eyes  
and eight long legs, and of an elegant  
scarlet colour.

**TANTALIDÆ,** *n.* A family of wading  
birds, of which the genus *Tantalus* of  
*Linn.* is the type. The *Tantalus reli-*  
*gius* is the celebrated Ibis wor-  
shipped by the ancient Egyptians.

**TANTALISM,** *n.* [See **TANTALIZE**.]  
The punishment of *Tantalus*; a teasing  
or tormenting by the hope or near ap-  
proach of good which is not attain-  
able.

Is not such a provision like *tantalism* to  
this people? *J. Quincy.*

**TANTALITE,** *n.* Another name for  
the mineral called columbite, which is  
found in New England and in Europe.

**TANTALIZAT'ION,** *n.* The act of  
tantalizing.

**TANTALIZE,** *v. t.* [from *Tantalus*,  
in fable, who was condemned for his  
crimes to perpetual hunger and thirst,  
with food and water near him which  
he could not reach.] To tease or tor-  
ment by presenting some good to the  
view and exciting desire, but contin-  
ually frustrating the expectations  
by keeping that good out of reach; to  
tease; to torment.

Thy vain desires, at strife  
Within themselves, have *tantaliz'd* thy life.  
*Dryden.*

**TANTALIZED,** *pp.* Teased or tor-  
mented by the disappointment of the  
hope of good.

**TANTALIZER,** *n.* One that tantalizes.

**TANTALIZING,** *ppr.* Teasing or tor-  
menting by presenting to the view some  
unattainable good.

**TANTALIZINGLY,** *adv.* By tantaliz-  
ing.

**TANTALUM,** *n.* A name once used  
for columbium, the metallic basis of  
the mineral called tantalite or colum-  
bite.

**TANTALUS,** *n.* [*L.* from *Gr.*] In *fab.*  
*hist.*, a Lydian king who was con-  
demned to be plunged in water, with  
choice fruits hanging over him, with-  
out the power of reaching them, to  
satisfy his hunger or his thirst. Hence  
the English word *tantalize*.

**TANTALUS'S CUP,** *n.* A philosophical  
toy. It consists of a siphon so  
adapted to a cup, that the short leg  
being in the cup, the long leg may go  
down through the bottom of it. When  
water is poured into the cup, it rises  
in the shorter leg of the siphon until it  
reaches up to the top of the bend of the

siphon, when it flows over into the  
longer leg, and escapes through the  
bottom of the cup, so  
that if water is not  
supplied to the cup as  
fast as it escapes by the  
siphon, the cup will  
soon be emptied. In  
the toy the siphon is  
concealed within the  
figure of a man, whose  
chin is on a level with  
the bend of the siphon.  
Hence, as soon as the  
water rises up to the  
chin of the image, it  
begins to subside, so  
that the figure, like *Tantalus* in the  
fable, is unable to quench his thirst.



Tantalus Cup.

**TANTAMOUNT,** *a.* [*L. tantus*, so  
much, and *amount*.] Equal; equiva-  
lent in value or signification; as, a sum  
*tantamount* to all our expenses. Silence  
is sometimes *tantamount* to consent.

**TANTATIVY,** *adv.* [said to be from the  
note of a hunting horn; *L. tanta vi*.]  
To ride *tantivy*, is to ride with great  
speed.

**TANTIVY,** *† n.* [Possibly an application  
of the preceding word as a nickname  
to a rustic country gentleman.] A  
devoted adherent of the court, in the  
time of Charles II.; a royalist; an  
opponent of the bill of Exclusion.

Those who took the king's side were  
anti-Birminghams, abhorers, and *tantivies*.  
These appellations soon became obsolete.

*Macaulay.*

**TANTLING,** *n.* [See **TANTALIZE**.]  
One seized with the hope of pleasure  
unattainable.

**TANT'RUMS,** *n. plur.* In *colloq. lan.*,  
childish ill humour; high airs; as to  
be in the *tantrums*.

**TAP,** *v. t.* [*Fr. taper*; *Arm. tapa*,  
*tapein*; *Dan. tapper*, to throb; *Gr.*  
*ταπειν, ταπειν*.] To strike with something  
small, or to strike a very gentle blow;  
to touch gently; as, to *tap* one with  
the hand; to *tap* one on the shoulder  
with a cane.

**TAP,** *v. i.* To strike a gentle blow. He  
*tapped* at the door.

**TAP,** *v. t.* [*Sax. tæppan*; *D. tappen*;  
*G. zapfen*.] 1. To pierce or broach a  
cask, and insert a tap.—2. To open a  
cask and draw liquor.—3. To pierce  
for letting out fluid; as, to *tap* a  
tumour; to *tap* a dropsical person.—  
4. To box or bore into; as, to *tap* a  
maple tree to obtain the *sap* for making  
sugar.

**TAP,** *n.* A gentle blow; a slight blow  
with a small thing.

She gives her right hand woman a *tap*  
on the shoulder. *Addison.*

2. A pipe for drawing liquor from a  
cask. [But in *Sp. tapar* is to stop, and  
a *tap* may be a stopper. In this case,  
the verb to *tap* should follow the noun.]  
—3. A tap-house, or tap-room.

**TAP,** *In mech.*, an instrument employed  
for cutting the threads of internal  
screws or *nuts*. It consists simply of  
an external or male screw of the re-  
quired size, formed of steel, and more  
or less tapered, portions of the threads  
being filed away in order to present a  
series of cutting edges. This being  
screwed into the nut in the manner of  
an ordinary bolt, forms the thread re-  
quired.

**TAPE,** *n.* [*Sax. tappe*.] A narrow  
fillet or band; a narrow piece of woven  
work, used for strings and the like;  
as, curtains tied with *tape*.

**TAPE LINE,** *n.* A painted tape, marked  
with inches, &c., and inclosed in a case,  
used by engineers, &c., in measuring.

**TAPER,** *n.* [*Sax. taper, tapur*. *Qu. It.*  
*doppiere*, a torch, *W. tampyr*.] A  
small wax candle; a small lighted wax  
candle, or a small light.

Get me a *taper* in my study, *Lucius*.

*Shak.*

**TAPER,** *a.* [supposed to be from the  
form of a taper.] Regularly narrowed  
toward the point; becoming small to-  
ward one end; conical; pyramidal;  
as, *taper* fingers.

**TAPER,** *v. i.* To diminish or become  
gradually smaller toward one end; as,  
a sugar loaf *tapers* toward a point.

**TAPER,** *v. t.* To make gradually  
smaller in diameter.

**TAPERING,** *ppr.* Making gradually  
smaller.—2. *a.* Becoming regularly  
smaller in diameter toward one end;  
conical or pyramidal; gradually di-  
minishing toward a point.—*Tapering*  
*root*, in *bot.*, a root generally fleshy, and  
of an elongated conical form, either un-  
divided or branched at its lowest extre-  
mity. The most common example is  
afforded by the garden carrot. In the  
radish it is spindle-shaped, or tapering  
toward both ends.

**TAPERINGLY,** *adv.* In a tapering  
manner.

**TAPERNESS,** *n.* The state of being  
*taper*.

**TAPER SHELL BIT,** *n.* A species of  
boring-bit used by joiners. It is con-  
ical both within and without, and its  
horizontal section is a crescent, the  
cutting edge being the meeting of the  
interior and exterior conical surfaces.  
Its use is for widening holes in wood.

**TAP'ESTRIED,** *pp.* Ornamented with  
tapestry.

**TAP'ESTRY,** *n.* [*Fr. tapis*, a carpet;  
*tapisserie*, hangings, tapestry; *L. tapes*,  
tapestry; *Fr. se tapis*, to crouch, to  
lie flat; *Sp. tapis*, tapestry, and a grass-  
plot; *It. tappeto*, a carpet; *tappezzeria*,  
tapestry; *Arm. tapigz*, a carpet; *tapig-*  
*zirz*, tapestry. *Qu.* from weaving or  
spreading.] A kind of woven hang-  
ings of wool and silk, often enriched  
with gold and silver, representing  
figures of men, animals, landscapes, &c.,  
and used formerly for lining or cover-  
ing the walls of elegant apartments,  
churches, &c. The French ascribe the  
invention to the Saracens, but it  
was known among Eastern nations  
from a very remote era. A manufac-  
tury of tapestry was established at  
Paris in 1606 or 1607, which was con-  
ducted by Flemish artists; but the  
manufactory of the Gobelins, instituted  
in France under Louis XIV., be-  
came the most celebrated for the  
beauty and strength of the cloth, for  
elegance of design, and happy choice  
of colours. The finest paintings were  
copied, and eminent painters employed  
to furnish designs. In *painting*, ta-  
pestry is applied to a representation of  
a subject in wool or silk, or both, worked  
on a woven ground of hemp or flax.

**TAP'ESTRY,** *v. t.* To adorn with ta-  
pestry.

**TAP'ET,** *n.* [*supra*.] Worked or figured  
stuff.

**TAP'ETI,** *n.* An animal of the hare  
kind; the *Lepus Brasiliensis*, a rodent  
mammal inhabiting South America.

**TAP'ETLESS,** *a.* Heedless; foolish.  
[*Scotch*.]

**TAPE-WORM,** *n.* [*tape* and *worm*.] A  
worm bred in the human intestines.

The popular name of various worms infesting the alimentary canal of different animals. They are parenchymatous entozoa, of the tenoid family. The broad tape-worm is the *Bothrioccephalus latus*; the common tape-worm is the *Tænia solium*. Both of these infest the human species, and are destroyed by the oil of turpentine in cathartic doses. [See *TENIA*.]

**TAP'-HOUSE**, *n.* [*tap* and *house*.] A house where liquors are retailed; a house where beer is served from the *tap*.

**TAPIO'CA**, *n.* A farinaceous substance prepared in South America, from the root of Janipha, or Jatropha manihot, the bitter Cassada or Manioc plant. This root presents the union of a deadly poison with highly nutritive qualities. The former appears to reside exclusively in the juice. In preparing cassava or manioc flour, the principal product yielded by the manihot, the roots, after having undergone the preliminary process of grating, &c., are subjected in bags to pressure in a screw press. The poisonous juice thus expressed, after being allowed to stand and settle for a short time, deposits a fine floury substance, which constitutes the tapioca of commerce. Tapioca is very nutritious and easy of digestion, being free from stimulating qualities. A spurious kind of tapioca is prepared from gum and potato flour.

**TAPIR**, *n.* A genus of pachydermatous, or thick-skinned mammals, of which three existing species, and several extinct ones, have been determined. The nose resembles a small fleshy proboscis; there are four toes to the fore feet, and three to the hind ones. The South American tapir, *T. Americanus*, is the size of a small ass, with a brown skin, nearly naked. The flesh is eaten. Another American species has been discovered in the Cordilleras, the back of which is covered with hair, and the bones of the nose more elongated, and approximating somewhat to the palæotherium. The *T. Malayanus*, or *indicus*, is found in the forests of Malacca

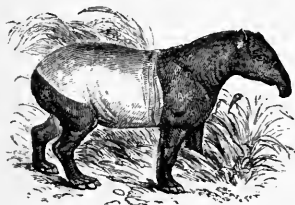

Malay Tapir (*T. Malayanus*).

and Sumatra. It is larger than the American species. The tapirs are allied both to the hog and to the rhinoceros, but they are much smaller than the latter. Fossil tapirs are scattered throughout Europe, and among them is a gigantic species, *T. giganteus*, Cuv., which in size must have nearly equalled the elephant.

**TAP'PIS**, *n.* [Fr.] Tapestry. Formerly tapestry was used to cover the table in a council chamber; hence, to be on or upon the *tapis*, is to be under consideration, or on the table.

**TAP'LASH**, *n.* [from *tap*.] Poor beer. **TAP'PED**, *pp.* Broached; opened. **TAP'PET**, *n.* A small lever connected with the valve of the cylinder of a steam-engine.

**TAP'PING**, *ppr.* Broaching; opening for the discharge of a fluid.

**TAP'PING**, *n.* In *surgery*, paracentesis, or the operation of removing fluid from any of the serous cavities of the body, in which it has collected in large quantity; as in cases of ascites, hydrothorax, and hydrocele. It is performed by means of a trocar and a tube, in which it exactly fits.

**TAP'PIT HEN**, *n.* A colloquial phrase, denoting a tin measure containing a quart, so named from the knob on the lid, as being supposed to resemble a crested hen. [Scotch.]

**TAP' ROOM**, *n.* A room in which beer is served from the *tap*.

**TAP'-ROOT**, *n.* [*tap* and *root*.] The main root of a plant, which penetrates the earth directly downward to a considerable depth.

**TAP'-ROOTED**, *a.* Having a tap-root. **TAPSALTEE'RIE**, *adv.* Topsy turvy. [Scotch.]

**TAP'STER**, *n.* One whose business is to draw ale or other liquor.

**TÁ'PUL**, *n.* In *ancient armour*, the sharp projecting ridge down the centre of some breastplates.

**TÁR**, *n.* [Sax. *tare*, *tyr*, *tyrwa*; D. *teer*; G. *theer*; Gael. *tearr*. In D. *teeren* signifies to smear with tar or pitch, and to pine, waste, consume, digest, prey, subsist, feast, and *teer* is tender, as well as tar. The D. *teeren* is the G. *zehren*, Dan. *tærer*, Sw. *tåra*, to fret, gnaw, consume; Eng. *tare*, in commerce. *Tar* then is from flowing, or from wasting, perhaps in combustion.] 1. A thick, impure, resinous substance, of a dark brown or black colour, obtained from pine and fir trees, by burning the wood with a close smothering heat, or by distilling it in close vessels, or ovens. It is prepared in great quantities in Norway, Sweden, Russia, Germany, North America, and in other countries where the fir and pine abound. It is also manufactured from pit coal. Tar is soluble in alcohol, ether, and in the fixed and volatile oils. It consists of resin, empyreumatic oil, and acetic acid, or vinegar. According to Reichenbach it contains the following proximate principles: *paraffine eupion*, *creasote picamar*, *capnomar*, and *pittacal*. The most important of these is creasote. *Oil of tar* is a brown liquid obtained by distilling tar with water. *Mineral tar*, a variety of bitumen resembling petroleum. Tar inspissated is called pitch, and is much used in ships and cordage.—2. A sailor; so called from his tarred clothes.

**TÁR**, *v. t.* To smear with tar; as, to tar ropes.—2. † [Sax. *tiran*, *tyrian*.] To tease; to provoke.

**TARÁBE**, *n.* A large parrot with a red head.

**TAR'ANIS**, *n.* A Celtic divinity, regarded as the evil principle, but confounded by the Romans with Jupiter.

**TARANTISM**. See *TARENTISM*.

**TARANTISMUS**. See *TARENTISM*.

**TARAN'TULA**, *n.* [See *TARENTULA*, which is the more correct orthography.]

**TAR'AQUIRA**, *n.* A species of American lizard.

**TÁRDA'TION**, † *n.* [L. *tardo*. See *TARDY*.] The act of retarding or delaying. [We use for this *Retardation*.]

**TÁRDIGRADE**, } *a.* [L. *tardigradu-*  
**TÁRDIGRADES**, } *gradus*; *tardus*,  
slow, and *gradus*, step.] Slow-paced; moving or stepping slowly.

**TÁRDI'GRADES**, } *n.* Cuvier's name  
**TÁRDI'GRADA**, } for the first fam-  
ily of Edentate mammals or quad-  
rups, comprising, of living genera,  
the sloth only. [See *SLOTH*.]

**TÁRDILY**, *adv.* [from *tardy*.] Slowly; with slow pace or motion.

**TÁRDINESS**, *n.* [from *tardy*.] Slowness, or the slowness of motion or pace.—2. Unwillingness; reluctance manifested by slowness.—3. Lateness; as, the *tardiness* of witnesses or jurors in attendance; the *tardiness* of students in attending prayers or recitation.

**TÁRDITY**, † *n.* [*tarditas*.] Slowness; tardiness.

**TÁR'DO**, *a.* [Ital.] In *music*, a term signifying that the piece to which it is affixed is to be performed slowly.

**TÁR'DY**, *a.* [Fr. *tardif*; Sp. and It. *tardo*, from L. *tardus*; from W. *tariaw*, to strike against, to stop, to stay, to tarry, whence *target*; *tar*, a shock; *taran*, that gives a shock, a clap of thunder; *taranu*, to thunder. We see the word is a derivative from a root signifying to strike, to clash, to dash against, hence to retard or stop.] 1. Slow; with a slow pace or motion. And check the *tardy* flight of time.

*Sandys*.  
2. Late; dilatory; not being in season. The *tardy* plants in our cold orchards plac'd.  
*Waller*.

You may freely censure him for being *tardy* in his payments.  
*Arbutnot*.

3. Slow; implying reluctance. *Tardy* to vengeance, and with mercy brave.  
*Prior*.

4. † Unwary.—5. † Criminal.—6. In colleges, late in attendance on a public exercise.

**TÁR'DY**, † *v. i.* [Fr. *tarder*.] To delay.

**TÁR'DY-GÁITED**, *a.* [*tardy* and *gait*.] Slow-paced; having a slow step or pace.

The mellow horn  
Chides the *tardy-gaited* morn. *Clifton*.

**TARE**, *n.* [Sax. *tiran*, to prey upon; to consume, because it destroys the corn. See the next word.] The common name of different species of *Vicia*, a genus of leguminous plants, and which are also known by the name of vetch. There are numerous species and varieties of tares or vetches, many of which have been proposed to be introduced into general cultivation, but that which is found best adapted for agricultural purposes is the common tare, *Vicia sativa*, of which there are two principal varieties, the summer and winter tare. They afford excellent food for horses and cattle, and hence are extensively cultivated throughout Europe. [See *VETCH*.] The name *tare* is also given to two British leguminous plants of the genus *Ervum*, the *E. hirsutum*, or hairy tare, and *E. tetraspermum*, or smooth tare. Both are annuals, and are found growing in fields and hedges. The *tare*, (*Ziz-anion*), mentioned in scripture, is supposed to be the *Lolium temulentum*, or darnel,—*which see*.

**TARE**, *n.* [Fr. *id.*; It. and Sp. *tara*; D. *tarra*; It. *tarare*, to abate; Dan. *tærer*, to waste, G. *zehren*.] In *com.*, deficiency in the weight or quantity of goods by reason of the weight of the cask, bag, or other thing containing the commodity, and which is weighed with it; hence, the allowance or abatement of a certain weight or quantity from the weight or quantity of a commodity

sold in a cask, chest, bag, or the like, which the seller makes to the buyer on account of the weight of such cask, chest, or bag. Tare is distinguished into *real tare*, *customary tare*, and *average tare*. The first is the absolute weight of the package; the second, its supposed weight according to the practice among merchants; and the third is the medium tare deduced from weighing a few packages and taking it as the standard for the whole. In this country the prevailing practice, as to all goods that can be unpacked without injury, is to ascertain the real tare. Sometimes, however, the buyer and seller make a particular agreement about it. When the tare is deducted, the remainder is called the *net* or *neat* weight.—*Tare and tret*, a rule in arithmetic by which the neat weight of a quantity of goods is ascertained, the gross weight and the allowances for the tare and the tret being given. [See TRET.]

TARE, *v. t.* To ascertain or mark the amount of tare.

TARE, *oldpret.* of *Tear*. We now use *tore*.  
TARED, *pp.* Having the tare ascertained and marked.

TAREN'TISM, } *n.* [L. *tarentismus*,  
TARAN'TISM, } from *tarentum*.] A feigned or imaginary disease endemic in the environs of Tarentum. It was characterized by an extreme desire to dance to the sound of musical instruments, and was popularly supposed to be caused by the bite of the Tarentula. According to others, this disease consisted in a state of somnolency, which could not be overcome except by music and dancing.—2. A disease in its effects resembling St. Vitus's dance and leaping ague.

TAREN'TULA, } *n.* [L. diminutive of  
TARAN'TULA, } *Tarentum*, now *Taranto*, in the kingdom of Naples.] A kind of spider, the *Lycosa tarantula*,



Tarantula (*Lycosa tarantula*).  
a, position of the eyes.

found in some of the warmer parts of Italy. When full grown it is about the size of a chestnut, and is of a brown colour. Its bite was at one time supposed to be dangerous, and to cause the disease called tarentism,—*which see*; it is now known not to be worse than that of a common wasp.—2. A dance practised in the neighbourhood of Tarentum, and named from the spider already referred to.—3. An air of a light gay character, played to the dance of the same name.

TARGE, for *Target*, is obsolete.

TARG'ET, *n.* [Sax. *targ*, *targa*; Fr. *targe*; It. *targa*; W. *targel*, from *tarau*, to strike, whence *tariad*, a striking against or collision, a stopping, a staying, a *tarrying*; *tariaw*, to strike against, to stop, to *tarry*. We see that *target* is that which stops; hence, a defence; and from the root of *tarry* and *tardy*.] 1. A shield or buckler of a small kind, used as a de-

fensive weapon in war. It was formerly much used in Scotland.—2. A

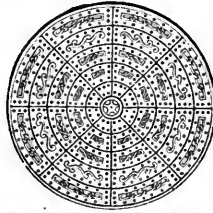

Leather-covered Highland Target.

mark for the artillery to fire at in their practice.

TARG'ETED, *a.* Furnished or armed with a target.

TARG'ET'EER, } *n.* One armed with  
TARG'ET'IER, } a target.

TARGUM, *n.* [Ch. תַּרְגוּם, *targum*, interpretation.] A translation or paraphrase of the sacred scriptures in the Chaldee language or dialect. There are ten targums extant; of which the most ancient, and the most valued by the Jews, are those of Onkelos and Jonathan Ben Uzziel. The targum of Onkelos is a paraphrase, or rather a Chaldee version of the Pentateuch, and is supposed to have been written in the first century of the Christian era. The targum of Jonathan is a paraphrase upon the greater and lesser Prophets, and is said to have been written in the third century. The targum of the Pseudo-Jonathan, and the Jerusalem targum, are both on the Pentateuch, and are of considerable antiquity. The remaining six are comparatively modern. All the targums taken together form a paraphrase of the whole of the Old Testament, except Nehemiah, Ezra, and Daniel.

TARGUMIST, *n.* The writer of a Targum.

TAR'IAN, *n.* The earliest form of the British shield. It was round and flat, and its exterior coating, made sometimes of bronze, was ornamented frequently with concentric circles surrounding the umbo, and studded over with little knobs beaten up from beneath.

TAR'IFF, *n.* [Fr. *tarif*; It. *tariffa*; Sp. *tarifa*, a town in Spain, at the entrance of the Straits of Gibraltar, where duties were formerly collected, hence the proper spelling would be *tarif*.] 1. Properly, a list or table of goods with the duties or customs to be paid for the same, either on importation or exportation, whether such duties are imposed by the government of a country, or agreed on by the princes or governments of two countries holding commerce with each other. The principle of a tariff depends upon the commercial policy of the state by which it is framed, and the details are constantly fluctuating with the change of interests and the wants of the community, or in pursuance of commercial treaties with other states. The British tariff has recently undergone several important alterations.—2. A list or table of duties or customs to be paid on goods imported or exported.

TAR'IFF, *v. t.* To make a list of duties on goods.  
TAR'IN, *n.* [Fr.] A bird of the genus Fringilla, kept in cages for its beauty and fine notes; the citrinella.  
TARING, *ppr.* Ascertaining or marking the amount of tare.

TARN, *n.* [Ice. *tiorn*.] 1. A small mountain, lake, or pool.—2. A bog; a marsh; a fen. [Local.]

TARNISH, *v. t.* [Fr. *ternir*, *ternissant*.] 1. To sully; to soil by an alteration induced by the air, or by dust, and the like; to diminish or destroy lustre; as, to *tarnish* a metal; to *tarnish* gilding; to *tarnish* the brightness or beauty of colour.—2. To diminish or destroy the purity of; as, to *tarnish* reputation or honour.

TARNISH, *v. i.* To lose lustre; to become dull; as, polished substances or gilding will *tarnish* in the course of time. Metals *tarnish* by oxidation.

TARNISH, *n.* A spot; a blot; soiled state.  
TARNISHED, *pp.* Sullied; having lost its brightness by oxidation, or by some alteration induced by exposure to air, dust, and the like.

Gold and silver, when *tarnished*, resume their brightness by setting them over certain lyes. Copper and pewter, &c., *tarnished*, recover their lustre with tripoli and potashes. *Cyc.*

TARNISHING, *ppr.* Sullyng; losing brightness.

TAR'O, *n.* A plant of the genus Arum, the *A. esculentum*, or *Colocasia esculenta*,



Taro (*Colocasia esculenta*).

cultivated in the Polynesian islands for the sake of its esculent root, which, although pungent and acrid in its natural state, becomes mild and palatable by baking or boiling.

TAR'OC, *n.* A game at cards.

TAR'PAN, } *n.* The wild horse, the  
TAR'PANY, } original stock of the bay horse. Tarpans are found pure



Tarpan of northern Asia.

only in Northern Asia, or the borders of China. They are not larger than

an ordinary mule, are migratory, and have a tolerably acute sense of smell. Their colour is invariably tan or mouse. During the cold season their hair is long and soft, lying so close as to feel like a bear's fur, and then it is grizzled; in summer it falls much away, leaving only a certain quantity on the back and loins.

**TARPAULIN,** } *n.* [from *tar.*] A  
**TARPAULING,** } piece of canvas  
**TARPAWLING,** } well daubed with  
tar, and used to cover the hatchways  
of a ship to prevent rain or water from  
entering the hold.—2. A sailor's hat  
covered with painted or tarred cloth;  
a painted or tarred canvas cover  
generally.—3. A sailor; in *contempt*.

**TARQUINISH,** *a.* Like Tarquin, a king  
of Rome; proud; haughty.

**TAR'RACE,** } *n.* A volcanic earth re-  
**TAR'RASS,** } sembling puzzolana,  
**TER'RASS,** } used as a cement; or a  
**TRASS,** } coarse sort of plaster  
or mortar, durable in water, and used  
to line cisterns and other reservoirs of  
water. The Dutch *tarras* is made of  
a soft rock stone found near Colleen,  
on the lower part of the Rhine. It is  
burnt like lime, and reduced to powder  
in mills. It is of a grayish colour.

**TAR'RAGON,** *n.* A plant of the genus  
*Artemisia*, (*A. dracunculus*), celebrated  
for perfuming vinegar in France.

**TARRE,** † *v. t.* To stimulate; to urge  
on; to provoke. [See **TO TAR.**]

**TARRED,** *pp.* Smear'd with tar.

**TAR'RIANCE,** † *n.* [from *tarry.*] A  
tarrying; delay; lateness.

**TAR'RIED,** *pp.* Waited for; staid;  
delayed.

**TAR'RIER,** *n.* A dog. [See **TERRIER.**]  
—2. [from *tarry.*] One who tarryies or  
delays.

**TAR'RING,** *ppr.* Smearing with tar;  
impregnating with tar; as, *tarring*  
ropes; *tarring* yarn.

**TAR'ROCK,** *n.* A name given to the  
young of the *Larus tridactylus*, or  
Kittiwake gull, while in their first  
year. The birds in this state were at  
one time supposed to be a distinct  
species.

**TAR'ROW,** *v. i.* To delay; to hesitate;  
to feel reluctance; to loathe; to re-  
fuse. [*Scotch.*]

**TAR'RY,** *v. i.* [W. *tariaw*, to strike  
against any thing, to stop, to stay, to  
tarry; Ir. and Gael. *tairism*. It is of  
the same family as *tardy* and *target*.  
The primary sense is to thrust or  
drive, hence to strike against, to stop;  
W. *tarw*, L. *taurus*, a bull, is from the  
same root.] 1. To stay; to abide; to  
continue; to lodge.

*Tarry* all night and wash your feet;  
Gen. xix.

2. To stay behind; Exod. xii.—3. To  
stay in expectation; to wait.

*Tarry* ye here for us, till we come again  
to you; Exod. xxiv.

4. To delay; to put off going or com-  
ing; to defer.

Come down to me, *tarry* not; Gen. xlv.

5. To remain; to stay.

He that telleth lies shall not *tarry* in my  
sight; Ps. ci.

**TAR'RY,** *v. t.* To wait for.

I cannot *tarry* dinner. † *Shak.*

**TAR'RY,** [from *tar.*] Consisting of tar,  
or like tar; smear'd with tar.

**TAR'RYING,** *ppr.* Staying; delaying.

**TAR'RYING,** *n.* Delay; Ps. xl.

**TAR'SAL,** *a.* Pertaining to the tarsus  
or instep; as, the *tarsal* bones.

**TARSE,** the same as *tarsus*,—*which*  
*see.*

**TARSEL,** *n.* A kind of hawk; a tiercel.

**TAR'SIER,** *n.* A quadruped; the  
woolly jerboa.

**TARSUS,** *n. pl.* *Tarsi.* [Gr. *ταρσος*: Fr.  
*tarse.*] The instep, or that part of the  
foot which is between the leg and me-  
tatarsus. It is composed of seven  
bones, viz., the *astragalus*, *os calcis*,  
*os naviculare*, *os cuboides*, and three  
others, called *ossa cuneiformia*.—2.  
The thin cartilage situated at the edges  
of the eyelids to preserve their firm-  
ness and shape.—3. In *entom.*, the last  
segment of the leg. It is divided into  
several joints, which have been sup-  
posed to represent the toes of quadru-  
peds. The last joint of the tarsus is  
generally terminated by a claw, which  
is sometimes single and sometimes  
double. In *birds*, the word *tarsus* is  
sometimes applied to the third segment  
of the leg, which corresponds with the  
*tarsus* and *metatarsus* conjoined.

**TART,** *a.* [Sax. *teart*; D. *taartig*. See  
the next word.] 1. Acid; sharp to the  
taste; acidulous; as, a *tart* apple.  
—2. Sharp; keen; severe; as, a *tart*  
reply; *tart* language; a *tart* rebuke.

**TART,** *n.* [D. *taart*; Sw. *tart*; Fr.  
*tarte*; It. *torta*; G. *torte*. The Italian  
and German orthography seem to con-  
nect this word with *torto*, L. *tortus*,  
twisted; and this may be the primary  
sense of *tart*, acid, sharp, and hence  
this noun, something acid or made of  
acid fruit. But *qu.*] A species of  
pie or pastry, consisting of fruit baked  
on paste.

**TARTAN,** *n.* [Sp. and It. *tartana.*] A  
vessel used in the Mediterranean, both  
for commercial and other purposes.  
It is furnished with a single mast on  
which is rigged a large lateen sail;  
and with a bowsprit and fore-sail.

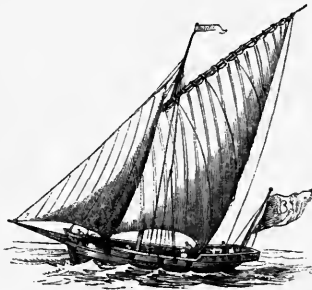

Tartan.

When the wind is aft, a square-sail is  
generally hoisted like a cross-jack.

**TARTAN,** *n.* A well-known species of  
cloth, checkered or cross-barred with  
threads of various colours. It was  
originally made of wool or silk, and  
constituted the distinguishing badge  
of the Scottish Highland clans, each  
clan having its own peculiar pattern.  
An endless variety of fancy tartans  
are now manufactured for ladies'  
dresses, some of wool, others of silk,  
others of wool and cotton, or of silk  
and cotton. The word *tartan* is sup-  
posed to be derived from the Fr.  
*tiretaine*, which signified a kind of  
linsey-woolsey anciently worn by the  
peasants of France, and which was  
most probably particoloured. The  
name, along with the manufacture

itself, seems to have been imported  
into Scotland from France or Germany.

**TARTAR,** *n.* [Fr. *tartre*; Sp. *tartaro*;  
from *tart*, acid.] 1. An acid concrete  
salt, called also *argal* or *argol*, de-  
posited from wines completely fer-  
mented, and adhering to the sides of  
the casks in the form of a hard crust.  
It is white or red, according to the  
wine from which it is obtained, the  
white being most esteemed. It is a  
bitartrate of potash, and when puri-  
fied, it is quite white, and forms *cream*  
*of tartar*, which is much used in dye-  
ing, and also in medicine as a laxative  
and diuretic. [See **CREAM.**]—*Salt of*  
*tartar*, carbonate of potash obtained  
by calcining cream of tartar,—*Soluble*  
*tartar*, a neutral or bibasic salt, ob-  
tained by adding cream of tartar to a  
hot solution of carbonate of potash  
till all effervescence ceases. It has a  
mild saline, somewhat bitter taste, and  
is used as a laxative.—*Tartar-emeti-*  
*c*, tartrate of potash and antimony, an  
important compound, used in medicine  
as an emetic, purgative, diaphoretic,  
sedative, febrifuge, and counter-irri-  
tant.—*Tartar of the teeth*, an earthy-  
like substance which occasionally con-  
cretes upon the teeth, and is deposited  
from the saliva. It consists of salivary  
mucus, animal matter, and phosphate  
of lime.—2. A person of a keen irrita-  
ble temper.—3. A native of Tartary;  
a corruption of *Tatar*.—*To catch a*  
*tartar*, in *ludicrous style*, to lay hold  
of or encounter a person who proves  
too strong for the assailant.

**TARTAR,** † *n.* [L. *Tartarus.*] Hell.

**TARTAR'EAN,** } *a.* Hellish; pertain-  
**TARTAR'EOUS,** } ing to Tartarus.

**TARTAR'EOUS,** *a.* Consisting of tar-  
tar; resembling tartar, or partaking  
of its properties.

**TARTAR'IC,** } *a.* Pertaining to Tar-  
**TARTAR'ICAN,** } tary, in Asia.

**TARTAR'IC ACID,** *n.* The acid of  
tartar. It exists in grape juice, in  
tamarinds, and several other fruits;  
but principally in bitartrate of pot-  
ash, or cream of tartar, from which it  
is usually obtained. It crystallizes in  
large rhombic prisms, transparent and  
colourless, and very soluble in water.  
It is inodorous and very sour to the  
taste. A high temperature decom-  
poses it, giving rise to several new  
products. The solution of tartaric  
acid acts with facility upon those  
metals which decompose water, as  
iron and zinc; it combines readily with  
alkalis, earths, and metallic oxides,  
forming salts called *tartrates*. Tartaric  
acid has a most remarkable dispo-  
sition to form double salts, as the tar-  
trate of potash and soda or Rochelle  
salts; the tartrate of potash and anti-  
mony, or tartar-emeti. In a crystal-  
lized state it is composed of 8 atoms  
of carbon, 4 of hydrogen, 10 of oxygen,  
and 2 of water; and in its dry state it  
is composed of 8 atoms of carbon, 2 of  
hydrogen, and 8 of oxygen. Tartaric  
acid is largely employed as a discharge  
in calico-printing, and for making  
soda powders. In medicine it is used  
in small doses as a refrigerant.

**TARTARIN,** } *n.* [from *tartar.*] A  
**TARTARINE,** } name given by Kir-  
wan to fixed vegetable alkali or  
potassa.

**TARTARINATED,** *a.* Combined with  
tartarin.

**TARTARIZA'TION,** *n.* The act of  
forming tartar.

**TARTARIZE**, *v. t.* To impregnate with tartar; to refine by means of the salt of tartar.

**TARTARIZED**, *pp.* Impregnated with tartar; refined by tartar.—*Tartarized iron*, tartrate of potash and peroxide of iron, used in medicine.—*Tartarized antimony*, another name for tartar-emetic.

**TARTARIZING**, *ppr.* Impregnating with tartar; refining by means of the salt of tartar.

**TARTAROUS**, *a.* Containing tartar; consisting of tartar, or partaking of its qualities.

**TARTARUM**, *n.* A preparation of tartar, called petrified tartar.

**TARTARUS**, *n.* [Gr. *ταρταρος*.] In Greek and Roman mythol., the name of the infernal regions, in which the Titans were confined, and the shades of the wicked were punished. In the earliest mythology of the Greeks, it denoted the regions of the dead in general, or the realm of Pluto.

**TARTISH**, *a.* [from *tart*.] Somewhat tart.

**TARTLY**, *adv.* Sharply; with acidity.—2. Sharply; with poignancy; severely; as, to reply or rebuke *tartly*.—3. With sourness of aspect.

**TARTNESS**, *n.* Acidity; sharpness to the taste; as, the *tartness* of wine or fruit.—2. Sharpness of language or manner; poignancy; keenness; severity; as, the *tartness* of rebuke.

**TARTRALATE**, *n.* A salt formed by the union of tartaric acid with a base; as, the *tartrate* of lime, or of baryta.

**TARTRALIC ACID**, *n.* An acid formed by the action of heat on tartaric acid. It forms a transparent mass not crystalline, deliquescent and soluble in alcohol. Its composition is the same as that of crystallized tartaric acid deprived of one-fourth of its water.

**TARTRATE**, *n.* [from *tartar*.] A salt formed by the combination of tartaric acid with a base; as, *tartrate* of potassa; *tartrate* of soda. Some of the tartrates are neutral; as the tartrates of ammonia, potash, soda, and lime; others are acid, as the acid tartrate of ethyle, the acid tartrate of potash, or tartar. Tartaric acid also forms a number of double tartrates; as the tartrate of potash and ammonia, of potash and oxide of ethyle, of potash and boracic acid, of potash and soda, &c. The tartrates are amongst the most interesting of organic salts.

**TARTRELATE**, *n.* A salt formed by the union of tartrellic acid with a base; as, the *tartrulate* of lime, or of baryta.

**TARTRELIC ACID**, *n.* An acid formed by the action of heat on tartaric acid. Its composition is the same as that of crystallized tartaric acid deprived of one-half of its water.

**TARTROVINIC ACID**, *n.* Acid tartrate of ethyle, a crystallizable compound obtained by the reaction of tartaric acid and alcohol on each other. It has a fine white colour, and a sweetish agreeable acidulous taste, but is destitute of smell.

**TARTSCHE**, *n.* A round shield formerly much in use with the Turks.

**TARTUFFE**, *n.* [Fr.] A hypocrite, a pretender to devotion.

**TARTUFFISH**, *† a.* [Fr. *tartuffe*, a hypocrite.] Precise; formal; hypocritical.

**TAR-WATER**, *n.* [*tar* and *water*.] A cold infusion of tar, which was formerly a celebrated remedy for many

chronic affections, especially of the lungs.

**TASCES**. See **TASSES**.

**TASCO**, *n.* In *mineral*, a sort of clay for making melting-pots.

**TASK**, *n.* [Fr. *tache*; W. *tasg*, a bond, a pledge, that which is settled or agreed to be done, a job, a *task*; Gael. and Ir. *tasg*, task, and *tasgair*, a slave; It. *tassa*. The sense is that which is set or fixed, from throwing or putting on.] 1. Business imposed by another, often a definite quantity or amount of labour; something to be learned or studied. Each man has his *task*. When he has performed his *task*, his time is his own; Exod. v.—2. Business; employment.

His mental powers were equal to greater *tasks*. *Atterbury*.

3. Burdensome employment.—*To take to task*, to reprove; to reprimand; as, to *take one to task* for idleness.

**TASK**, *v. t.* [W. *tasgu*, to bind, to rate, to task, to spring, start, leap back, to urge.] 1. To impose a task; to assign to one a definite amount of business or labour.—2. To burden with some employment; to require to perform. There *task* thy maids, and exercise the loom. *Dryden*.

**TASKED**, *pp.* Required to perform something.

**TASKER**, *n.* One that imposes a task.

**TASKING**, *ppr.* Imposing a task on; requiring to perform.

**TASKMASTER**, *n.* [*task* and *master*.] One who imposes a task, or burdens with labour. Sinful propensities and appetites are men's most unrelenting *taskmasters*. They condemn us to unceasing drudgery, and reward us with pain, remorse and poverty. Next to our sinful propensities, fashion is the most oppressive *taskmaster*.—2. One whose office is to assign tasks to others; Exod. i. iii.

**TASK-WORK**, *n.* Work imposed or performed as a task.

**TASLET**, *n.* A piece of armour for the thigh.

**TASSEL**, *n.* [W. *tasel*, a sash, a bandage, a fringe, a tassel; *tasaw*, to tie; *tas*, that binds or hems in; It. *tassello*, the collar of a cloak.] 1. A sort of pendent ornament, consisting of a bunch of silk or gold fringe, attached to the corners of cushions, to curtains, the strings of mantles, robes of state, &c., and ending in loose threads.—2. In *arch.*, tassels are the pieces of boards that lie under the mantle-tree; they are otherwise called *torsels*.—3. A bur. [See **TEASEL**.]—4. A male hawk; properly *terzol*; It. *terzuolo*.—5. The flower ribbons, or head of plants; as, of maize.

**TASSEL**, *v. i.* To put forth a tassel, or flower; as, maize.

**TASSELLED**, *a.* Furnished or adorned with tassels; as, the *tasselled* horn.

**TASSEL-GRASS**, *n.* A British plant of the genus *Ruppia*, the *R. maritima*. [See **RUPPIA**.]

**TASSES**, or **TASSETS**, *n. plur.*

Armour for the thighs; appendages to the ancient corselet, consisting of skirts of iron that covered the thighs. They were fastened to the cuirass with hooks.

**TAS'SIE**, *n.* [Fr. *tasse*.] A cup or vessel. [*Scotch*.]

**TASTABLE**, *a.* [from *taste*.] That may be tasted; savoury; relishing.

**TASTE**, *v. t.* [Fr. *tâter*, to feel; It. *tastare*; Norm. *taster*, to touch, to try; G. and D. *tasten*; Dan. *tasser*. The Dutch has *toetsen*, to touch, to try, to test; Dan. *taster* and *at*, to attack or assault. This shows that the primary sense is to thrust or drive; allied perhaps to *dash*; hence to strike, to touch, to bring one thing in contact with another.] 1. To perceive by means of the tongue; to have a certain sensation in consequence of something applied to the tongue, the organ of taste; as, to *taste* bread; to *taste* wine; to *taste* a sweet or an acid.—2. To try the relish of by the perception of the organs of taste.—3. To try by eating a little; or to eat a little.

Because I *tasted* a little of this honey; 1 Sam. xiv.

4. To essay first.—5. To have pleasure from.—6. To experience; to feel; to undergo.

That he by the grace of God should *taste* death for every man; Heb. ii.

7. To relish intellectually; to enjoy. Thou, Adam, wilt *taste* no pleasure.

8. To experience by shedding, as blood. When Commodus had once *tasted* human blood, he became incapable of pity or remorse.

*Gilbon*. **TASTE**, *v. i.* To try by the mouth; to eat or drink; or to eat or drink a little only; as, to *taste* of each kind of wine.—2. To have a snack; to excite a particular sensation, by which the quality or flavour is distinguished; as, butter *tastes* of garlic; apples boiled in a brass-kettle, sometimes *taste* of brass.—3. To distinguish intellectually.

Scholars, when good sense describing, Call it *tasting* and imbibing. *Swift*.

4. To try the relish of anything. *Taste* of the fruits; *taste* for yourself.—5. To be tintured; to have a particular quality or character.

Ev'ry idle, nice and wanton reason Shall, to the king, *taste* of this action. *Shak*.

6. To experience; to have perception of. The valiant never *taste* of death but once. *Shak*.

7. To take to be enjoyed. Of nature's bounty men forbore to *taste*. *Waller*.

8. To enjoy sparingly. For age but *tastes* of pleasures, youth devours. *Dryden*.

9. To have the experience or enjoyment of. They who have *tasted* of the heavenly gift, and the good word of God; Heb. vi.

**TASTE**, *n.* The act of tasting; gustation.—2. A particular sensation excited in an animal by certain bodies, which are called *sapid*, applied to the tongue and palate, and moistened with saliva; as, the *taste* of an orange or an apple; a bitter *taste*; an acid *taste*; a sweet *taste*. This is the original and proper meaning of the word *taste*; but as the qualities of bodies which produce these sensations are unknown, they have obtained the names of the sensations themselves, by substituting the cause for the effect. We possess very few words to designate the endless variety of tastes, of which we are very sensible. Tastes have been divided into simple and compound, and philosophers have

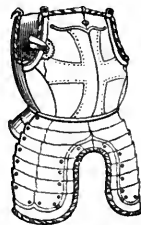

Corselet with Tassets, A. D., 1525.

endeavour to ascertain the number of each species.—3. The sense by which we perceive the relish of a *tasting*. The organs of this special sense, are certain parts within the cavity of the mouth, obviously so disposed as to take early cognizance of matters about to be swallowed, and to act as sentinels for the remainder of the alimentary canal, at the entrance of which they are situated. They serve to give timely notice of any acrid, caustic, or nauseous quality; of any undue temperature; of any inconvenient hardness, irregularity, size, or sharpness in the material submitted to them; and thus to protect the stomach against the intrusion of many hurtful agents. They, moreover, establish for our appetites a scale of liking and disliking. The organs of taste are confined to a portion of the tongue and a portion of the palate. The tip and sides of the tongue, and a small space at the root of it, together with a small surface at the anterior and superior part of the roof of the palate, are the only portions of surface in the cavity of the mouth and throat that can distinguish taste or sapidity from mere touch.—4. Intellectual relish, or discernment; as, he had no *taste* of true glory.

I have no *taste*

Of popular applause. *Dryden.*

*Note.*—In this use, the word is now followed by *for*. "He had no *taste for* glory." When followed by *of*, the sense is ambiguous, or rather it denotes experience, trial.—5. Judgment; discernment; nice perception, or the power of perceiving and relishing excellence in human performances; the faculty of discerning beauty, order, congruity, proportion, symmetry, or whatever constitutes excellence, particularly in the fine arts and belles lettres. Or it may be defined, that faculty of the mind by which we both perceive and enjoy whatever is beautiful and sublime in the works of nature and art, the perception of these two qualities being attended with an emotion of pleasure, distinguishable from every other pleasure of our nature. This faculty relishes some things, is disgusted with others, and to many is indifferent. *Taste* is not wholly the gift of nature, nor wholly the effect of art. It depends much on culture. It is the joint result of natural sensibility, of a good judgment, and an intimate acquaintance with the best productions of art. We say, a good *taste*, or a fine *taste*.—6. Style; manner, with respect to what is pleasing; the pervading air, the choice of circumstances, and the general arrangement in any work of art, by which taste in the artist or author is evinced; as, a poem or music composed in good *taste*.—7. The choice, whether good or bad, of ornaments, of pleasures, or pursuits, by which a person is distinguished.—8.† Essay; trial; experiment.—9. A small portion given as a specimen.—10. A bit; a little piece tasted or eaten.—11. A kind of narrow ribbon. **TASTED**, *pp.* Perceived by the organs of taste; experienced. **TASTEFUL**, *a.* Having a high relish; savoury; as, *tasteful* herbs.—2. Having good taste; having or showing intellectual taste. **TASTEFULLY**, *adv.* With good taste. **TASTEFULNESS**, *n.* The state of being tasteful.

**TASTELESS**, *a.* Having no taste; insipid; as, *tasteless* fruit.—2. Having no power of giving pleasure; as, *tasteless* amusements.—3.† Having no power to perceive taste.—4. Having no intellectual gust. [*Little used.*]

**TASTELESSLY**, *adv.* In a tasteless manner.

**TASTELESSNESS**, *n.* Want of taste or relish; insipidness; as, the *tastelessness* of fruit.—2.† Want of perception of taste.—3.† Want of intellectual relish.

**TASTER**, *n.* One who tastes.—2. One who first tastes food or liquor.

Thy tutor be thy *taster* ere thou eat.

*Dryden.*

3. A dram cup.

**TASTILY**, *adv.* With good taste.

**TASTING**, *ppr.* Perceiving by the tongue.—2. Trying; experiencing; enjoying or suffering.

**TASTING**, *n.* The act of perceiving by the tongue.—2. The sense by which we perceive or distinguish savours; or the perception of external objects through the instrumentality of the tongue or organs of taste.

**TASTO SO'LO**, in *music*, denotes that the passage should be performed with no other chords than unisons and octaves, or that the instruments that can accompany by chords are only to play single sounds. The Italian word *tasto* signifies the touch of an instrument.

**TASTY**, *a.* Having a good taste, or nice perception of excellence; *applied to persons*; as, a *tasty* lady.—2. Being in conformity to the principles of good taste; elegant; as, *tasty* furniture; a *tasty* dress.

**TATA**, *n.* In *Western Africa*, the name given to a native fortification, or wall, with posts surrounding a village or cluster of houses. It is usually constructed of glazed earth.

**TATCH**. See **TACHE**.

**TATCH**, } † *n.* [Fr. *tache*, *tacher*, a  
**TATCHE**, } spot, stain, or blemish.] A  
trick; a contrivance or plot.

**TATE**, } *n.* A small portion of any-  
**TEAT**, } thing; as, a *tate* of wool, or of  
flax. [*Scotch.*]

**TATH**, } *n.* [Islandic, *tad*, dung, ma-  
**TAITH**, } nure.] The dung of black  
cattle. [*Scotch.*]

**TAT'TER**, *v. t.* [Qu. Sax. *totæran*; compounded of *tæran*, to *tear*, and the prefix *to*, or D. *tod*, Scot. *dud*, a rag.] To rend or tear into rags. [*Not used except in the participle.*]

**TAT'TER**, *n.* A rag, or a part torn and hanging to the thing; chiefly used in the plural, *Tatters*.

**TATTERDEMALION**, *n.* A ragged fellow.

**TATTERED**, *pp. or a.* Rent; torn; hanging in rags; as, a *tattered* garment.

Where war'd the *tatter'd* ensigns of Rag-fair. *Pope.*

**TATTER-WALLOPS**, *n. plur.* *Tatters*; rags in a fluttering state. [*Scotch.*]

**TAT'TIE**, *n.* In the *E. Indies*, a thick mat or screen, usually made of the sweet-scented cuscus-grass, and fastened upon a bamboo frame, for closing a chamber doorway. It is usually kept moist, so as to cool the apartment by evaporation.

**TAT'TLE**, *v. i.* [D. *tateren*; It. *tattamellare*.] 1. To prate; to talk idly; to use many words with little meaning.

Excuse it by the *tattling* quality of age, which is always narrative. *Dryden.*

2. To tell tales; to communicate secrets; as, a *tattling* girl.

**TAT'TLE**, *n.* Prate; idle talk or chat; trifling talk.

They told the *tattle* of the day. *Swift.*

**TAT'TLER**, *n.* One who *tattles*; an idle talker; one that tells tales.

**TAT'TLERY**, *n.* Idle talk or chat.

**TAT'TLING**, *ppr.* Talking idly; telling tales.—2. *a.* Given to idle talk; apt to tell tales.

**TAT'TLINGLY**, *adv.* In a *tattling* tell tale manner.

**TATTOO**, *n.* [If this word was originally *taptoo* or *tapto*, it is from the Fr. *tapoter*, to beat; *tapotez tous*, beat, all of you; from *taper*, Gr. *τάρω*, Eng. *tap*.] A beat of drum at night, giving notice to soldiers to retreat, or to repair to their quarters in garrison, or to their tents in camp.

**TATTOO**, *v. t.* [In the South Sea islands.] To prick the skin, and stain the punctured spots with a black substance, forming lines and figures upon the body. In some islands, the inhabitants *tattoo* the face, in others only the body. The same practice exists among other rude nations.

**TATTOO**, *n.* Figures on the body made by punctures and stains in lines and figures.

**TATTOO'ED**, *pp.* Marked by stained lines and figures on the body.

**TATTOO'ING**, *ppr.* Marking with various figures by stained lines.

**TATTOO'ING**, *n.* The name given to a practice common to several uncivilized nations, which consists in marking the skin with punctures or incisions, and introducing into the wounds coloured liquids or gunpowder, so as to produce an indelible stain, and also



Tattooing.

Head of Ko-towa-towa, a New Zealand chief.

a variety of figures, on the face and other parts of the body. This practice is very prevalent among the South-sea islanders, and the word *tattoo* appears to be formed by a reduplication of a Polynesian verb *ta*, meaning to strike, in allusion to the method of performing the operation. The instruments generally used in tattooing, among the south-sea islanders, are edged with small teeth, somewhat resembling those of a fine comb. These are applied to the skin, and being repeatedly struck with a small mallet, the teeth make the incisions required, while the colouring tincture is introduced at the same time. In some cases, however, various instruments are employed, and the operation is very tedious and painful. Degrees of rank are indicated by the greater or less surface of tattooed skin. Some-

times the whole body, the face not excepted, are tattooed; as among the New Zealanders. The age for performing the operation appears to vary from eight or ten years, up to about twenty.

**TAU**, *n.* The toad fish of Carolina, a species of *Gadus*, (*G. tau*).—2. A species of beetle; also, a species of moth, (*Phalena*); also, a kind of fly, (*Musca*).—3. In *her.*, the *cross-tau*, or cross of St. Anthony. It is nearly the same as the *cross-potent*, and derives its name from the Greek letter *tau*, which it resembles exactly.

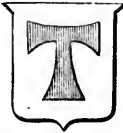

Cross-Tau.

**TAUGHT**, *a.* (*taut.*) [from the root of *tight*.] In *marine lan.*, tight; stretched out; not slack; applied to a rope or sail. As applied to a sail, it also implies a great quantity of sail set. It is sometimes written *taut*.

**TAUGHT**, *pret.* and *pp.* of *Teach*, pron. *taut.* [*L. doctus*.] Experience taught him wisdom. He has been taught in the school of experience.

**TAUNT**, *a.* In *mar. lan.*, high or tall; an epithet particularly applied to the masts when they are of an unusual length.

**TAUNT**, *v. t.* [*Qu. Fr. tancer*, to rebuke or chide; *W. tantiaw*, to stretch; or *Pers. taunidan*, to pierce with words.] 1. To reproach with severe or insulting words; to revile; to upbraid.

When I had at my pleasure *taunted* her. *Shak.*

2. To exprobate; to censure.

Rail thou in Fulvia's phrase, and *taunt* my faults. *Shak.*

**TAUNT**, *n.* Upbraiding words; bitter or sarcastic reproach; insulting invective.

With scoffs and scorns, and contumelious taunts. *Shak.*

With sacrilegious *taunt* and impious jest. *Prior.*

**TAUNTED**, *pp.* Upbraided with sarcastic or severe words.

**TAUNTER**, *n.* One who taunts, reproaches, or upbraids with sarcastic or censorious reflections.

**TAUNTING**, *ppr.* Treating with severe reflections; upbraiding.

**TAUNTINGLY**, *adv.* With bitter and sarcastic words; insultingly; scoffingly.

**TAUPIE**, *n.* [*Suio-Goth. tapig*, *TAWPIE*,] simple, silly, foolish.] A foolish, thoughtless young woman. [*Scotch.*]

**TAURICORNOUS**, *a.* [*L. taurus*, a bull, and *cornu*, horn.] Having horns like a bull.

**TAURIFORM**, *a.* [*L. taurus*, a bull and *form*.] Having the form of a bull.

**TAURINE**, *a.* [*L. taurus*, a bull.] 1. Relating to a bull.—2. Relating to the *Taurus Urus*, the species to which the common bull or ox and cow belong; and for which there is no peculiar name in English.

**TAURINE**, *n.* One of the products of the decomposition of bile. When pure it forms large prisms; it is neutral, has a cooling taste, and is soluble in water. It contains the elements of binoxalate of ammonia and of water.

**TAUROCOLL**, *n.* [*L. taurus*, a bull, and *Gr. κolla*, glue.] A gluey substance made from a bull's hide.

**TAUROMACHIA**, *n.* [*Gr. ταυρομαχία*.]

A public bull-fight; such as are common in Spain.

**TAUROMACHIAN**, *a.* Relating to public bull-fights; as, the Spanish taste is *taurumachian*.

**TAURUS**, *n.* [*L.*; *W. taric*.] 1. The Bull; one of the twelve signs of the zodiac, and the second in order, or that next to Aries. This constellation, according to the British catalogue, contains 141 stars. Several of these are remarkable; as Aldebaran of the first magnitude in the eye, the Hyades in the face, and the Pleiades in the neck. Taurus is denoted by the character ♂.—2. The Linnean name of the species to which the common bull or ox and cow belong; and for which there is no peculiar name in English.

**TAUT**, *a.* Tight. [*See TAUGHT.*]

**TAUTED**, *a.* [*Ir. tath*, gluten.]

**TAUTED**, *a.* Matted together; spoken **TAUTIE**, *a.* of hair or wool. [*Scotch.*]

**TAUTOCHROME**, *n.* [*Gr. ταυρος*, the same, and *χρονος* time.] In *mech.*, a curve line such, that a heavy body descending along it by gravity, will, from whatever point in the curve it begins to descend, always arrive at the lowest point in the same time. The cycloid possesses this property. Also, when any number of curves are drawn from a given point, and another curve is so drawn as to cut off from every one of them an arc, which is described by a falling particle in one given time, that arc is called a *tautochrone*.

**TAUTOCHRONOUS**, *a.* Pertaining to a tautochrone; isochronous.

**TAUTOG**, *n.* A fish, (*Labrus Americanus*) found on the coast of New England, and valued for food, called also Black-fish.

**TAUTOLITE**, *n.* A velvet-black mineral existing in volcanic feldspathic rocks. It is supposed to be a silicate of protoxide of iron, and silicate of magnesia.

**TAUTOLOGIC**, *a.* [*See TAUTOLOGICAL*, *LOGY*.] Repeating the same thing; having the same signification; as, a *tautological* expression or phrase.—*Tautological echo*, an echo that repeats the same sound or syllable many times.

**TAUTOLOGICALLY**, *adv.* In a tautological manner.

**TAUTOLOGIST**, *n.* One who uses different words or phrases in succession to express the same sense.

**TAUTOLOGIZE**, *v. i.* To repeat the same thing in different words.

**TAUTOLOGOUS**, *a.* Tautological.

**TAUTOLOGY**, *n.* [*Gr. ταυτολογία*; *ταυτος*, the same, and *λογος*, word or expression.] A repetition of the same meaning in different words; needless repetition of a thing in different words or phrases; or a representation of anything as the cause, condition, or consequence of itself, as in the following lines—

The dawn is overcast, the morning low'rs,  
And heavily in clouds brings on the day. *Addison.*

**TAUTOPHONICAL**, *a.* Repeating the same sound.

**TAUTOPHONY**, *n.* [*Gr. ταυτος*, the same, and *φωνη*, voice.] Repetition of the same sound.

**TAUTOUSIAN**, *a.* In *theol.*, having **TAUTOUSIOUS**, *a.* absolutely the same essence.

**TAVERN**, *n.* [*Fr. taverne*; *W. tavarn*; *L. taberna*; *tab*, the root of *table*, a

board, and *Sax. ærn*, place.] A house where wines and other liquors are sold, and where entertainment is provided for large parties.

**TAVERNER**, *n.* One who **TAVERN-KEEPER**, *n.* keeps a tavern. Taverner is obsolete.

**TAVERN-HUNTER**, *n.* [*tavern* and *hunt*.] One who frequents taverns; one who spends his time and substance in tipping in taverns.

**TAVERNING**, *n.* A feasting at taverns.

**TAVERN-MAN**, *n.* [*tavern* and *man*.] The keeper of a tavern.—2. A tippler.

**TAW**, *v. t.* [*Sax. tawian*; *D. touwen*. In *Sax. teagan* has the like signification. In *Pers. tawidan*, is to scrape and curry hides.] To dress white leather or alum leather; to dress and prepare skins in white, as the skins of sheep, lambs, goats, and kids, for gloves and the like.—2. To beat. [*See TEW.*]

**TAW**, *n.* A marble to be played with; a game at marbles.

**TAWDRILY**, *adv.* In a tawdry manner.

**TAWDRINESS**, *n.* [*from tawdry*.] Tinsel in dress; excessive finery; ostentatious finery without elegance.

A clumsy person makes his ungracefulness more ungraceful by *tawdriness* of dress. *Richardson.*

**TAWDRY**, *a.* Very fine and showy in colours without taste or elegance; having an excess of showy ornaments without grace; as, a *tawdry* dress; *tawdry* feathers; *tawdry* colours.

He rails from morning to night at essenced fops and *tawdry* courtiers. *Spectator.*

**TAWDRY**, *n.* A slight ornament.

**TAWED**, *pp.* Dressed and made white, as leather.

**TAWER**, *n.* A dresser of white leather.

**TAWERY**, *n.* A place where skins are tawed.

**TAWIE**, *a.* Tame; tractable. [*Scotch.*]

**TAWING**, *ppr.* Dressing as white leather.

**TAWING**, *n.* The art and operation of preparing skins and forming them into white leather by imbuing them with alum, salt, and other matters.

**TAWNINESS**, *n.* The quality of being tawny.

**TAWNY**, *a.* [*Fr. tanné*, from *tanner*, to tan.] Of a yellowish dark colour, like things tanned, or persons who are sun-burnt; as, a *tawny* Moor or Spaniard; the *tawny* sons of Numidia; the *tawny* lion.

**TAWS**, *n.* A whip; a lash; the **TAWSE**, *n.* ferula used by a schoolmaster. [*Scotch.*]

**TAX**, *n.* [*Fr. taxe*; *Sp. tasa*; *It. tassa*; from *L. taxo*, to tax. If from the *Gr. ταξις*, *τασσω*, the root was *tago*, the sense of which was to set, to thrust on. But this is doubtful. It may be allied to *task*.] 1. A rate or duty, laid by government on the incomes or property of individuals, or on the products consumed by them; the produce of such duty or rate being placed at the disposal of government, for the public good. *Tax* is a term of general import, including almost every species of imposition on persons or property for supplying the public treasury, as tolls, tribute, subsidy, excise, impost, or customs. But more generally, *tax* is limited to the sum laid upon incomes, lands, houses, horses, cattle, professions, and occupations. So we speak of a land *tax*, an income *tax*, a window *tax*, a *tax* on carriages, &c. A *tax* may be either *direct* or *indirect*. It is said to

be *direct*, when it is imposed on the incomes or property of individuals; and *indirect*, when it is imposed on the articles on which such incomes or property are expended. A tax may also be either *general* or *particular*; that is, it may either affect all classes indiscriminately, or only one or more classes. All taxes must ultimately be paid from the revenue of a country, or from its capital or stock. *Assessed taxes*, those duties imposed by government on windows, carriages, horses, dogs, men-servants, &c.—2. A sum imposed on individuals or on their property for local or civic purposes. Of this nature are county rates, taxes for the repair of roads or bridges, taxes for the support of the poor, usually called *poor rates*; borough tolls and dues; light dues, harbour dues; police taxes, &c. So a private association may lay a *tax* on its members for the use of the association.—3. That which is imposed; a burden. The attention that he gives to public business is a heavy *tax* on his time.—4. Charge; censure.—5. Task.

**TAX**, *v. t.* [L. *taxo*; Fr. *taxer*; It. *tassare*.] 1. To lay, impose, or assess upon individuals a certain sum of money or amount of property, to be paid to the public treasury, or to the treasury of a corporation or company, to defray the expenses of the government or corporation, &c.

We are more heavily *taxed* by our idleness, pride and folly, than we are *taxed* by government. *Franklin*.

2. To load with a burden or burdens. The narrator... never *taxes* our faith beyond the obvious bounds of probability.

*J. Spinks*.  
3. To assess, fix or determine judicially, as the amount of cost on actions in court; as, the court *taxes* bills of cost.—4. To charge; to censure; to accuse; usually followed by *with*; as, to *tax* a man *with* pride. He was *taxed with* presumption.

Men's virtues I have commended as freely as I have *taxed* their crimes. *Dryden*.  
[To *tax* of a crime, is now in use, nor to *tax for*. Both are not improper.]

**TAXABILITY**, *n.* The state of being taxable.

**TAXABLE**, *a.* That may be taxed; liable by law to the assessment of taxes; as, *taxable* commodities.—2. That may be legally charged by a court against the plaintiff or defendant in a suit; as, *taxable* costs.

**TAXABLENESS**, *n.* The state of being taxable.

**TAXABLY**, *adv.* In a taxable manner.

**TAXACEÆ**, *n.* A nat. order of gymnospermous plants, inhabiting chiefly the temperate parts of Europe, Asia, Africa, and America. The plants of this order are trees or shrubs, having a woody tissue marked with circular disks, with evergreen, and mostly narrow, rigid, entire, and veinless leaves. The order yields trees which are valued for their timber, and, like the coniferæ, possess resinous properties. The *Dacrydium taxifolium* or *Kahaterro* of New Zealand acquires a height of 200 feet. [See **TAXUS**.]

**TAXATIO ECCLESIASTICA**. [L.] The name formerly given to the assessment and levy of taxes upon the property of the church, and of the clergy.

**TAXATION**, *n.* [Fr. from L. *taxatio*.] 1. A taxing; the act of laying a tax, or of imposing taxes on the subjects of

a state by government, or on the members of a corporation or company by the proper authority. *Taxation* is probably the most difficult subject of legislation.—2. Tax; sum imposed; the aggregate of particular taxes.

He daily such *taxations* did exact. *Daniel*.  
3. That branch of political economy which explains the mode in which the revenue required for the public service may be most advantageously raised.—

4. Charge; accusation. [Little used.]  
—5. The act of taxing or assessing a bill of costs.

**TAX'ED**, *pp.* Rated; assessed; assessed.

**TAX'ER**, *n.* One who taxes.—2. In Cambridge, two officers chosen yearly to see the true gauge of weights and measures observed. [See **TAXOR**.]

**TAX'-FREE**, *a.* Exempt from taxation.

**TAX'-GATHERER**, *n.* A collector of taxes.

**TAX'ARCH**, *n.* [Gr. *ταξιάρχης*: *ταξις*, order, and *αρχος*, chief.] An Athenian military officer commanding a taxis or battalion.

**TAX'ICORNS**, } *n.* These second family  
**TAX'ICOR'NES**, } of the heteromero-

ous coleoptera in Latreille's arrangement of insects. They live on fungi, beneath the bark of trees, or on the ground under stones.

**TAX'IDERMIC**, *a.* Belonging to the art of preparing and preserving the skins of animals.

**TAX'IDERMIST**, *n.* A person skilled in preparing and preserving the skins of animals, so as to represent their natural appearance.

**TAX'IDERMY**, *n.* [Gr. *ταξις*, order, and *δερμα*, skin.] The art of preparing and preserving the skins of animals, for cabinets, so as to represent their natural appearance.

**TAX'ING**, *ppr.* Imposing a tax; assessing, as a bill of costs; accusing.

**TAX'ING**, *n.* The act of laying a tax; taxation; Luke ii.

**TAX'IS**, *n.* [Gr. *ταξις*, order.] In *surg.*, an operation by which those parts which have quitted their natural situation are replaced by the hand without the assistance of instruments; as, in reducing hernia, &c.—2. In *ancient arch.*, a term used to signify that disposition which assigns to every part of a building its just dimensions. It is synonymous with *ordonnance* in modern architecture.

**TAXO'DIUM**, *n.* A genus of plants, nat. order Coniferæ. It has been dis-



*Taxodium distichum*.

tinguished from the genus *cupressus*, principally on account of the arrange-

ment of the male catkins in racemose panicles, the small number of flowers in the female catkins, and the numbers of cotyledons possessed by the embryo. The *T. distichum*, or deciduous cypress, is a native of North America, where its wood is used for all the purposes to which timber is applied. The bark exudes a resin which is used by the negroes for dressing wounds. The roots are remarkable for the production of large conical knobs, hollow inside. In America they are called *cypress knees*, and are used by the negroes for bee-hives.

**TAXON'OMY**, *n.* [Gr. *ταξις*, order, and *νομος*, law.] 1. That department of natural history which treats of the laws and principles of classification.—2. The laws or principles themselves of classification.

**TAX'OR**, *n.* In the *university of Cambridge*, an officer appointed to regulate the assize of bread, the true gauge of weights, &c.

**TAX'US**, *n.* The yew; a genus of evergreen plants, the type of the natural order Taxaceæ. The species are natives of Europe and North America. [See **YEW**.]

**TAYLOR'S THEOREM**. In the *higher mathematics*, a very elegant formula, of most extensive application in analysis, discovered by Dr. Brook Taylor, and published by him in 1715. It is to the following effect. Let *u* represent any function whatever of the variable quantity *x*; then if *x* receive any increment, as *h*, let *u* become *u'*; then we shall have  $u' = u + \frac{du}{dx} \cdot h +$

$$\frac{d^2 u}{dx^2} \cdot \frac{h^2}{1 \cdot 2} + \frac{d^3 u}{dx^3} \cdot \frac{h^3}{1 \cdot 2 \cdot 3} + \frac{d^4 u}{dx^4} \cdot \frac{h^4}{1 \cdot 2 \cdot 3 \cdot 4} + \text{&c.}$$

where *d* represents the differential of the function *u*. The great value of this theorem was overlooked till it was made the basis of the differential and integral calculus by Lagrange, in 1772.

**TA'ZEL**, *n.* A plant; teasel,—*which see*.

**TAZ'ZA**, *n.* [It.] In *antiquities*, a large basin or reservoir of water, set apart for the various lustrations which were in general use among the ancients.

**TEA**, *n.* [Chinese, *tcha* or *tha*. Grosier. Russ. *tshai*; Sp. *te*; It. *tè*; Fr. *thé*.] 1. The dried leaves of different species of plants of the genus *Thea*, extensively cultivated in China. All the teas of China are in commerce brought under two distinct terms, *green teas* and *black teas*. These are produced from *thea*



Black Tea (*Thea bohea*).

*viridis*, and *thea bohea*, both of which species yield the two kinds of tea. The



difference between green and black tea is attained by means of some peculiarity in the manipulation during the process of manufacture. The black teas include *bohea*, *congou*, *souchong*, and *peko*; the green teas, *twanhai*, *hyson-skin*, *young hyson*, *hyson*, *imperial*, and *gunpowder*. *Paraguay tea* is yielded by *Ilex paraguayensis*. [See ILEX.] Tea, taken in moderation, is strengthening and exhilarating. It also has the effect of a very mild narcotic. The green varieties are more exhilarating than the black, and a strong infusion of the former, generally produces considerable excitement and wakefulness. Tea was first introduced into this country about the middle of the seventeenth century. [See THEA.]—2. A decoction or infusion of tea leaves in boiling water. *Tea* is a refreshing beverage.—3. Any infusion or decoction of vegetables; as, sage *tea*; chamomile *tea*, &c.

TEA, v. i. To take or drink tea. [Provincial.]

TEA-BOARD, n. [*tea* and *board*.] A board to put tea furniture on.

TEA-CADDY, n. A box for holding the tea used in a household; a tea-canister.

TEA-CANISTER, n. [*tea* and *canister*.] A canister or box in which tea is kept.

TEA-CHEST, n. A slightly formed wooden package, covered with Chinese characters and devices, and lined with thin sheet-lead, used for sending tea in from China.

TEA-CUP, n. [*tea* and *cup*.] A small cup in which tea is drunk.

TEA-DEALER, n. A merchant who sells teas.

TEA-DRINKER, n. [*tea* and *drinker*.] One who drinks much tea.

TEA-KETTLE, n. A portable boiler, made of copper, of brass, or of tinned or cast iron, in which water is boiled for making tea.

TEA-LEAD, n. Thin sheet-lead, used in lining tea-chests, sent from China.

TEA-PLANT, n. The tea-shrub. [See THEA.]

TEA-POT, n. [*tea* and *pot*.] A vessel with a spout, in which tea is made, and from which it is poured into tea-cups.

TEA-SAUCCER, n. [*tea* and *saucer*.] A small saucer in which a tea-cup is set.

TEA-SPOON, n. [*tea* and *spoon*.] A small spoon used in drinking tea and coffee.

TEA-TABLE, n. [*tea* and *table*.] A table on which tea-furniture is set, or at which tea is drunk.

TEA-TREE, n. [*tea* and *tree*.] The shrub or plant that produces the leaves which are imported and called *tea*. [See THEA.]

TEA-TRAY, n. A tea-board, made of japanned sheet-iron, pasteboard, papier maché, &c.

TEA-URN, n. A vessel in the form of a vase, placed on the tea-table, for supplying heated water for tea.

TEACH, v. t. pret. and pp. *Taught*. [Sax. *tæcan*, to teach, and to take; L. *doceo*; Ir. *deachtaim*, to teach, to dictate; Gaelic, *deachtam*, which seems to be the L. *dico*, *dicto*, and both these and the Gr. *δεικναι*, to show, may be of one family; all implying sending, passing, communicating, or rather leading, drawing.] 1. To instruct; to inform; to communicate to another the knowledge of that of which he was before ignorant.

He will *teach* us of his ways, and we will walk in his paths; Is. ii.

Lord, *teach* us to pray, as John also *taught* his disciples; Luke ix.

2. To deliver any doctrine, art, principles, or words for instruction. One sect of ancient philosophers *taught* the doctrines of stoicism, another those of epicureanism.

In vain they worship me, *teaching* for doctrines the commandments of men; Matt. xv.

3. To tell; to give intelligence.—4. To instruct, or to practise the business of an instructor; to use or follow the employment of a preceptor; as, a man *teaches* a school for a livelihood.—5. To show; to exhibit so as to impress on the mind.

If some men *teach* wicked things, it must be that others may practise them. *South*.  
6. To accustom; to make familiar.

They have *taught* their tongue to speak lies; Jer. ix.

7. To inform or admonish; to give previous notice to.

For he *taught* his disciples, and said... Mark ix.

8. To suggest to the mind.

For the Holy Spirit shall *teach* you in that same hour what ye ought to say; Luke xii.

9. To signify or give notice.

He *teacheth* with his fingers; Prov. vi.

10. To counsel and direct; Hab. ii.  
TEACH, v. i. To practise giving instruction; to perform the business of a preceptor.

The heads thereof judge for reward, and the priests thereof *teach* for hire; Mic. iii.

TEACH, n. [Ir. and Gaelic, *teagham*, to heat.] In sugar works, the last boiler.

TEACHABLE, a. That may be taught; apt to learn; also readily receiving instruction; docile.

We ought to bring our minds free, unbiased and *teachable*, to learn our religion from the word of God. *Watts*.

TEACHABLENESS, n. The quality of being capable of receiving instruction; more generally, a willingness or readiness to be informed and instructed; docility; aptness to learn.

TEACHER, n. One who teaches or instructs.—2. An instructor; a preceptor; a tutor; one whose business or occupation is to instruct others.—3. One who instructs others in religion; a preacher; a minister of the gospel.

The *teachers* in all the churches assembled themselves. *Raleigh*.

4. One who preaches without regular ordination.

TEACHING, ppr. Instructing; informing.

TEACHING, n. The act or business of instructing.—2. Instruction.

TEACHLESS, a. Unteachable; indocile.

TEAD, } + n. [L. *tæda*.] A torch; a  
TEDE, } flambeau.

TEAGUE, n. (teeg.) An Irishman; in contempt.

TEAK, n. A tree of the East Indies, which furnishes an abundance of ship timber. It is the *Tectona grandis*. [See TECTONA.]

TEAL, n. [D. *taling*.] An aquatic fowl of the genus *Anas*, the *A. crecca*, Linn., the smallest and most beautiful of the European anatidæ, or duck kind. The common teal makes its appearance in England about the end of September, and remains till spring has made considerable progress, when it generally returns again to more northern localities to breed. In many parts of Scot-

land, however, it remains all the year. Teals frequent fresh-water lakes, and



Common Teal (*Anas crecca*).

feed on seeds, grasses, water-plants, and insects. Their flesh is much prized.

TEAM, n. [Sax. *team*, offspring, progeny, race of descendants, hence a suit or long series; *tyman*, to *teem*, to bear, to bring forth, also to call, to summon. The primary sense is to shoot out or extend.] 1. Two or more horses, oxen or other beasts, harnessed together to the same vehicle for drawing, as to a coach, chariot, waggon, cart, plough, and the like. It has been a great question whether *teams* of horses or oxen are most advantageously employed in agriculture. Wherever the land is only partially cultivated, and a portion of it remains in coarse pasture, which costs little or nothing to the occupier, or where extensive open commons afford cheap food for oxen, these ought to be employed in farm labour; but where- ever arable land is the chief object of the farmer's attention, and the tillage of the soil is brought to any degree of perfection, horses should be employed.

—2. Any number passing in a line; a long line.  
Like a long *team* of snowy swans on high. *Dryden*.

[This is the primary sense, but is rarely used.]

TEAM-RAILWAY, n. A railway on which horses are used as the motive power.

TEAMSTER, n. [*team* and *ster*.] One who drives a team.

TEANY, *In her*. [See TENNE.]

TEAR, n. [Gaelic, *dear*, *deur*; Goth. *tagr*, contracted in Sax. *tear*; W. *zähre*; Sw. *tar*; Dan. *taare*; G. *daigyr*; Gr. *δακρυ*: from flowing or pouring forth; Ar. *tauha*, to burst forth, as tears, or *wadaha*, to drop or distil.] 1. Tears are the limpid fluid secreted by the lacrymal gland, and appearing in the eyes, or flowing from them. A *tear*, in the singular, is a drop or a small quantity of that fluid.

Tears are excited by passions, particularly by grief. This fluid is also called forth by any injury done to the eye. It serves to moisten the cornea and preserves transparency, and to remove any dust or fine substance that enters the eye and gives pain. Tears are a little heavier than water; they have a saline taste and an alkaline reactivity, owing to the presence of free soda.—2. Something in the form of a transparent drop of fluid matter; as gums or resins exuding in the form of tears from the eye.

TEAR, v. t. pret. *Tore*; pp. *Torn*; old pret. *Tare*, obs. [Sax. *tearan*, to tear; *tiran*, *tyran*, *tyrian*, *tyrigan*, to fret,

gnaw, provoke; Russ. *deru*, to tear. In Sw. *tåra* is to fret, consume, waste; Dan. *terer*, id.; D. *teeren*, G. *zehren*, id. These are probably the same word varied in signification, and they coincide with L. *tero*, Gr. *τεροω*. In W. *tori*, Arn. *torri*, Corn. *terhi*, is to break; Ch. and Syr. *terā*, to tear, to rend.] 1. To separate by violence or pulling; to rend; to lacerate; as, to *tear* cloth; to *tear* a garment; to *tear* the skin or flesh. We use *tear* and *rip* in different senses. To *tear* is to rend or separate the *texture* of cloth; to *rip* is to open a *seam*, to separate parts sewed together.—2. To wound; to lacerate.

The women beat their breasts, their cheeks they *tear*. *Shak.*

3. To rend; to break; to form fissures by any violence; as, torrents *tear* the ground.—4. To divide by violent measures; to shatter; to rend; as, a state or government *turn* by factions.—5. To pull with violence; as, to *tear* the hair.—6. To remove by violence; to break up.

Or on rough seas from their foundation *turn*. *Dryden.*

7. To make a violent rent. In the midst, a *tearing* groan did break The name of Antony. *Shak.* To *tear from*, to separate and take away by force; as, an island *torn from* its possessor.

The hand of fate

Has *torn* thee from me. *Addison.* To *tear off*, to pull off by violence; to strip.—To *tear out*, to pull or draw out by violence; as, to *tear out* the eyes.—To *tear up*, to rip up; to remove from a fixed state by violence; as, to *tear up* a floor; to *tear up* the foundations of government or order.

TEAR, v. i. To rave; to rage; to rant; to move and act with turbulent violence; as a mad bull.

TEAR, n. A rent; a fissure. [*Lit. us.*] TEARER, n. One who tears or rends any thing.—2. One that rages or raves with violence.

TEAR-FALLING, a. [*tear* and *fall*.] Shedding tears; tender; as, *tear-falling* pity.

TEAR-FILLED, a. Filled with tears.

TEARFUL, a. [*tear* and *full*.] Abounding with tears; weeping; shedding tears; as, *tearful* eyes.

TEARING, ppr. [*from tear*, to rend.] Rending; pulling apart; lacerating; violent; raging.

TEARLESS, a. Shedding no tears; without tears; unfeeling.

TEAR-STAINED, a. Having traces of the passage of tears; as, *tear-stained* cheeks.

TEASE, v. t. (s as z.) [*Sax. teasan*, to pull or tear.] 1. To comb or card, as wool or flax.—2. To scratch, as cloth in dressing, for the purpose of raising a nap.—3. To vex with importunity or impertinence; to harass, annoy, disturb, or irritate by petty requests, or by jests and railery. Parents are often *teased* by their children into unreasonable compliances.

My friends *tease* me about him, because he has no estate. *Spectator.*

TEASED, pp. Carded.—2. Vexed; irritated; annoyed.

TEASEL, } n. (tee'z'l.) [*Sax. teast*.] 1. TEAZEL, } The English name of TEAZLE, } several plants of the genus *Dipsacus*, belonging to the nat. order Dipsacæ. Common teasel or fuller's thistle, (*D. fullorum*), is a plant which

grows wild in hedges, but it is cultivated in those districts of England where



Common Teasel (*Dipsacus fullorum*).

a, Hooked scale of the Receptacle; b, Corolla slit open.

cloth is manufactured, for the sake of the awns of the head, which are employed to raise the *nap* of woollen cloths. For this purpose the heads are fixed round the circumference of a large broad wheel or drum, so as to form a kind of brush. The wheel is made to turn round, while the cloth is held against the brush thus formed, and the fine hooked awn of the teasel readily insinuates itself into the woollen web, and draws out with it some of the fine fibres of the wool. These are afterwards shorn smooth, and leave the cloth with the fine velvet-like nap which is its peculiar appearance. Teasels, before being used, are sorted into *kings*, *middlings*, and *scrubs*, according to their size. Every piece of fine broad cloth requires from 1500 to 2000 teasels to bring out the proper nap, after which they are useless.

TEASEL, TEAZLE, or TEAZEL, v. t. To cut and gather teasels.

TEASELER, } n. One who uses the TEAZLER, } teasel for raising a nap on cloth.

TEASELING, } ppr. Gathering teasels; TEAZLING, } as a *noun*, the cutting and gathering of teasels.

TEASER, n. One that teases or vexes. TEASING, ppr. Combing; carding; scratching for the purpose of raising a nap; vexing with importunity.

TEAT, n. [*Sax. tit, titt*; G. *zitze*; D. *tet*; W. *têth*; Corn. *titi*; Ir. *did*; Gaelic, *did*; Fr. *teton*, breast, It. *tetta*; Gr. *τετοσ*. It coincides with *tooth*, *teeth*, in elements, and radical sense, which is a shoot.] The projecting part of the female breast; the dug of a beast; the pap of a woman; the nipple. It consists of an elastic erectile substance, embracing the lactiferous ducts, which terminate on its surface, and thus serves to convey milk to the young of animals.

TEATED, a. Having teats; having protuberances resembling the teats of animals.

TEATHE, n. The soil or fertility left on lands by feeding cattle on them. [*Scotch.*]

TEATHE, v. t. To feed and enrich land by feeding cattle on it. [*Scotch.*]

TEATHING, n. In *Scotland*, the practice of carrying provender to the field to be consumed there by cattle during winter, for the purpose of enriching the soil by the dung of the cattle. This practice is considered to be very objectionable. [*See TATH.*]

TEAZE TENON, n. In *arch.*, a tenon on the top of a tenon, with a double shoulder and tenon from each, for supporting two level pieces of timber at right angles to each other.

TEAZEL, or TEAZLE. *See* TEASEL. TE'BETH, n. [*Heb.*] The tenth month of the Jewish ecclesiastical year, and fourth of the civil. It answers to our December.

TECH'ILY, adv. [*from techy*, so written for *touchy*.] Peevishly; fretfully; frowardly.

TECH'INESS, n. Peevishness; fretfulness.

TECH'NIC, } a. [*L. technicus*; Gr. TECHNICAL, } *τεχνικός*, from *τεχνειν*, art, artifice, from *τεχνη*, to fabricate, make or prepare. This word and *τεσσα* have the same elements.] 1. Pertaining to art or the arts. A *technical* word is a word that belongs properly or exclusively to an art; as, the verb to *smelt*, belongs to metallurgy. So we say, *technical* phrases, *technical* language. Every artificer has his *technical* terms.—2. Belonging to a particular profession; as, the words of an indictment must be *technical*.

It is of the utmost importance clearly to understand the *technical* terms used by the eastern theologians. *Prof. Lee.*

TECH'NICALLY, adv. In a technical manner; according to the signification of terms of art or the professions.

TECH'NICALNESS, } n. The quality TECHNICALITY, } or state of being technical or peculiar to the arts.

TECH'NICS, n. The doctrine of arts in general; such branches of learning as respect the arts.

TECHNOLOG'ICAL, a. [*See* TECHNOLOGY.] Pertaining to technology.—2. Pertaining to the arts; as, *technological* institutes.

TECHNOL'OGIST, n. One who discourses or treats of arts, or of the terms of arts.

TECHNOL'OGY, n. [*Gr. τεχνη*, art, and *λογος*, word or discourse.] 1. A description of arts; or a treatise on the arts.—2. An explanation of the terms of the arts.

TECH'Y, a. [*so written for touchy*.] Peevish; fretful; irritable. [*More correctly touchy*.]

TECOMA, n. A genus of plants, nat. order Bignoniaceæ. The species are erect trees or shrubs or climbing plants,



Tecoma impetiginosa.

with unequally pinnate or digitate simple leaves, with terminal panicles

of yellow or flesh-coloured flowers. They are natives of the Old and New World, in tropical and sub-tropical climates. A climbing species, *T. radicans*, a native of North and South Carolina, of Florida, and Virginia, is a favourite in this country as an ornamental plant. From the shape of its corolla, the plant has received the name of trumpet-flower. Some of the species of Tecoma are medicinal, as *T. impetiginosa*, which abounds in tannin, and whose bark is bitter, mucilaginous, and used in lotions, baths, &c., in cases of inflammations of the joints and debility.

**TECTIBRANCHIATA**, *n.* [*L. tectus*, concealed or covered, and *Gr. βραχίον*, gills.] The fourth order of Gastropods in the arrangement of Cuvier, comprehending those species in which the gills are attached along the right side, or on the back, in form of leaves more or less divided. The mantle covers them more or less, and contains nearly always in its thickness a small shell. They resemble the Pectinibranchiata in the form of the organs of respiration, and live like them in the sea, but they are all hermaphrodites. The order contains the following genera: *pleurobranchus*, *pleurobranchæa*, *aplysia*, *dolabella*, *notarachus*, *ahera*, *gasteroptron*, *gastroplax*, *umbrella*.

**TECTONA**, *n.* The teak, a genus of plants; nat. order Verbenaceæ. *T. grandis*, the teak-tree, is a native of



Teak (*Tectona grandis*).

different parts of India, as well as of Burmah, and of the islands from Ceylon to the Moluccas. It grows to an immense size, and is remarkable for its very large leaves, which are from 12 to 24 inches long, and from 8 to 16 broad. Teak timber is found to be excellent for ship-building, and has been called the oak of the East. It works easily, and though porous, is strong and durable; is easily seasoned, and shrinks but little; and from containing a resinous oil, it resists the action of water, as well as insects of all kinds. Besides being employed in ship-building, teak timber is extensively used in the East, in the construction of houses and temples. The tree which yields the African teak is not known. It belongs to the nat. order Euphorbiaceæ.

**TECTONIC**, *a.* [*Gr. τεκτονικός*, from *τεκνω*, to fabricate.] Pertaining to building.

**TECTORIUM OPUS**, *n.* [*Lat.*] In ancient arch., the name given to a species of plastering used on ceilings and interior walls.

**TECTRYCES**, *n.* [from *L. tego*, to cover.] In ornith., the same as *coverts*,—*which see*.

**TED**, *v. t.* [*W. téd* and *têz*, [*teth*], a spread; *tedu*, to distend.] Among farmers, to spread; to turn new mowed grass or hay from the swath, and scatter it for drying.

**TED'DED**, *pp.* Spread from the swath; as, *tedded* grass.

**TED'DER**, *n.* [*W. tid*, a chain; *Ir. tead*, *teidin*; Gaelic, *tead*, *teidin*, *teud*, a chain, cord, or rope; *Sw. tiuder*; probably from extending. See **TED**.] 1. A rope or chain by which an animal is tied, that he may feed on the ground to the extent of the rope and no further. Hence the popular saying, a person has gone to the length of his *tedder*.—2. That by which one is restrained. [See **TETHER**.]

**TED'DER**, *v. i.* To tie with a tedder; to permit to feed to the length of a rope or chain.—2. To restrain to certain limits.

**TED'DERED**, *pp.* Tied with a tedder; restrained to certain limits.

**TED'DING**, *ppr.* Spreading from the swath, as hay.

**TED'DING**, *n.* In agriculture, the operation of scattering, spreading, turning, and, in short, of making hay.

**TE DE UM**, *n.* The title of a celebrated hymn or song of thanksgiving, so called from the first words, "*Te Deum laudamus*." We praise thee, O God. It is sung on particular occasions, as on the news of victories, and on high festival days in catholic and also in some protestant churches. In the English church, *Te Deum* is sung in the morning service between the two lessons.

*Te Deum* was sung at St. Paul's after the victory. *Bacon.*

**TE'DIOUS**, *a.* [*Sp.* and *It. tedioso*, from *tedio*, *L. tedium*; probably connected with *W. ted*, tedder, from the sense of drawing out.] 1. Wearisome; tiresome from continuance, prolixity, or slowness which causes prolixity. We say, a man is *tedious* in relating a story; a minister is *tedious* in his sermon. We say also, a discourse is *tedious* when it wearies by its length or dullness.—2. Slow; as, a *tedious* course.

**TE'DIOUSLY**, *adv.* In such a manner as to weary.

**TE'DIOUSNESS**, *n.* Wearisomeness by length of continuance or by prolixity; as, the *tediousness* of an oration or argument.—2. Prolixity; length.—3. Tiresomeness; quality of wearying; as, the *tediousness* of delay.—4. Slowness that wearies.

**TE'DIUM**, *n.* [*L. tedium*.] Irksomeness; wearisomeness.

**TE'DIUM-STRICKEN**, *a.* Struck with irksomeness.

**TEE**, *n.* In India, an umbrella in general; also, an umbrella of open iron-work, covering the Buddhist pagodas of Ava and Pegu.

**TEEM**, *v. i.* [*Sax. tyman*, to bring forth, to bear; *team*, offspring; also *tyman*, *teaman*, to call, to summon; *D. teemon*, to whine, to cant, that is, to throw.] 1. To bring forth, as young.

If she must *teem*,  
Create her child of spleen. *Shak.*

2. To be pregnant; to conceive; to engender young.

*Teeming* buds and cheerful greens appear. *Dryden.*

3. To be full; to be charged; as a breeding animal; to be prolific. Every

head *teems* with politics.—4. To bring forth; to produce, particularly in abundance. The earth *teems* with fruits; the sea *teems* with fishes.

**TEEM**, *v. t.* To produce; to bring forth.

What's the newest grief?  
Each minute *teems* a new one. *Shak.*

[*This transitive sense is not common.*]  
—2. † To pour.

**TEEMER**, *n.* One that brings forth young.

**TEEMFUL**, *a.* Pregnant; prolific.—2. Brimful.

**TEEMING**, *ppr.* Producing young; fruitful; prolific; replete with.

**TEEMLESS**, *a.* Not fruitful or prolific; barren; as, the *teemless* earth.

**TEEN**, † *n.* [*infra.*] Grief; sorrow.

**TEEN**, † *v. t.* [*Sax. teonan*, to tyrann, to irritate.] To excite; to provoke.

**TEENS**, *n.* [from *teen*, *ten*.] The years of one's age reckoned by the termination *teen*. These years begin with *thirteen*, and end with *nineteen*. Miss is in her *teens*.

**TEESDA'LIA**, *n.* A genus of cruciferous plants, so named after Mr. Teesdale, an English botanist. Class Tetradynamia, order Siliculosa, Linn. The species, which are not important, are small annual smooth herbs, with stalked expanded vertical leaves, and flowers usually small and white. *T. nudicaulis* is a British species, found in sandy and gravelly places.

**TEETH**, *plur.* of *Tooth*,—*which see.*—In the *teeth*, directly; in direct opposition; in front.

Nor strive with all the tempest in my *teeth*. *Pope.*

*Teeth*, or *cogs* of a wheel, in *mech.*, are projecting pieces which may be either formed on, or inserted into, the rim of a wheel which is intended to transmit motion from one axis to another, by the intervention of a similar wheel. The teeth being disposed at equal distances on the rims of both, when one wheel is turned its teeth enter successively the spaces between those of the other, thereby imparting motion to it. Toothed wheels are most frequently employed in machinery to transmit motion from one axis to another, and to regulate the relative velocities of two shafts; the larger one being termed the *wheel*, and the smaller the *pinion*. The velocities of revolution of every wheel and pinion which work in one another, have the same proportion as their number of teeth taken in a reverse order; so that by this means the relative velocities of wheels and pinions may be accurately determined according to any proposed rate, and consequently the relative velocities of the shafts which they turn. The teeth of wheels require to be formed with the utmost accuracy, according to certain mathematical curves, as that of the epicycloid, in order that the motion may be transmitted with the requisite smoothness and uniformity. [See **WHEEL**.]

**TEETH**, *v. i.* [from the noun.] To breed teeth.

**TEETHING**, *ppr.* Breeding teeth; undergoing dentition.

**TEETHING**, *n.* The operation or process of the first growth of teeth, or the process by which they make their way through the gums, called *dentition*.

**TEE-TOTAL**, *a.* Pertaining to teetallers, or to abstinence societies; as, a *tee-total* meeting; a *tee-total* pledge.

**TEE-TO-TALISM**, *n.* The principles or practice of tee-totalers.

**TEE-TO-TALLERS**, *n.* The name assumed by those who form themselves into societies, pledging themselves to abstain not only from ardent spirits, but from wines, and all fermented liquors. The professed object of such societies is to repress drunkenness, and to introduce a habit of total abstinence from all intoxicating liquors among all classes. [See **TEMPERANCE**.]

**TEE-TOTUM**, *n.* A top-shaped toy for children, put in motion by twirling. It is usually made of ivory, and has letters cut upon the thickest part, which is polygonal, not round.

**TEG**, } *n.* A female fallow-deer; a  
**TEGG**, } doe in the second year.—2. A young sheep, older than a lamb.

**TEG'MEN**, *n.* plur. *Tegmina*, [L.] A covering. [See **TEGUMENT**.]

**TEGMENTUM**, plur. *Tegmenta*, *n.* [L.] In *bot.*, the scaly coat which covers the leaf buds of deciduous trees.

**TEG'ULAR**, *a.* [L. *tegula*, a tile, from *tego*, to cover or make close.] Pertaining to a tile; resembling a tile; consisting of tiles.

**TEG'ULARLY**, *adv.* In the manner of tiles on a roof.

**TEGUMENT**, } *n.* [L. *tegumentum*,  
**TEG'MEN**, } from *tego*, to cover.] A cover or covering. In *anat.*, common teguments is the general name given to the cuticle, rete mucosum, skin, and adipose membrane, as being the covering of every part of the body except the nails.—2. In *bot.* [See **TEGUMENTUM**.]—3. In *entom.*, a term applied to the coverings of the wings of the order Orthoptera, or straight-winged insects. [See **INTEGUMENT**.]

**TEGUMENT'ARY**, *a.* Pertaining to teguments, or consisting of teguments.

**TEHEE**, *n.* A laugh, so named from the sound.

**TEHEE**, *interj.* Expressing a laugh.

**TEHEE**, *v. i.* To laugh contemptuously or insolently; to titter. [A *cant word*.]

**TEIL**, } *n.* [L. *tika*; Ir. *teile*.]  
**TEIL-TREE**, } The lime-tree, otherwise called the linden.

**TEINDS**, *n. plur.* [Suio-Goth. *tiende*, the tenth part.] In *Scotch law*, the name for tithes. After the reformation, the whole teinds of Scotland were transferred to the *crown*, or to private individuals, called *titulars*, to whom they had been granted by the crown, or to *feuars*, or renters from the church, or to the original founding patrons, or to colleges or pious institutions. By a succession of decrees and enactments these tithes were generally rendered redeemable at a fixed valuation, but the clergy have now no right to the teinds beyond a suitable provision, called a stipend; so that teinds may now be described as that portion of the estates of the laity which is liable to be assessed for the stipend of the clergy. As a fund for the stipends of clergymen, teinds are under the administration of the court of session.—*Court of teinds*, a court in Scotland, otherwise called *Commissioners of teinds*. The powers conferred on this court are exercised by the judges of the court of session, as a parliamentary commission; but the court is distinct from the court of session, having a special jurisdiction, and a separate establishment of clerks and officers. Its jurisdiction extends to all matters respecting valuations and sales of

teinds, augmentations of stipends, pro-rations of tacks, and of teinds, and (with consent of three-fourths of the heritors of the respective parishes) the disjunction or annexation of parishes, and the building of new churches, &c. An appeal lies from this court to the house of lords.

**TEIN'OSCOPE**, *n.* [Gr. *τεινω*, to extend, and *σκοπος*, to see.] The name given by Sir David Brewster to an optical instrument, formed by combining prisms of the same kind of glass in such a manner that the chromatic aberration of the light is corrected. Dr. Brewster has proposed the construction of the object-glasses of telescopes on this principle.

**TEINT**, *n.* [Fr. *teint*, from *teindre*, L. *tingo*, to dye.] Colour; tinge. [See **TINT**.]

**TELAMO'NES**, *n.* [Gr. from *ταλαμ*, to support.] In *arch.*, figures of men employed as columns or pilasters to support an entablature, in the same manner as caryatides. They were called *Atlantes* by the Greeks. [See **ATLANTES**.]

**TEL'ARY**, *a.* [L. *tela*, a web.] 1. Pertaining to a web.—2. Spinning webs; as, a *telary spider*. [Little used.]

**TELEGRAPH**, *n.* [Gr. *τηλε*, at a distance, and *γραφω*, to write.] A machine for communicating intelligence from a distance by various signals or movements previously agreed on; which signals represent letters, words, or ideas which can be transmitted from one station to another, as far as the signals can be seen. The name *semaphore* is applied to some of the machines used for effecting telegraphic communication [see **SEMAPHORE**], and this term, in an extended signification, may be considered to embrace every means of conveying intelligence by gestures and visible signals, as flags, lanterns, rockets, blue lights, beacon fires, &c.; or by audible signals, as the firing of guns, the blowing of trumpets, the beating of drums, &c.; as well as by the machines called telegraphs or semaphores. For day signals the telegraph usually consists of a post of sufficient height, with two arms movable on the same pivot on the top of it, and a short arm, called the indicator, attached to one side of the upright post. The signals are made by varying the position of two arms, while the indicator shews the order or direction in which the signals are to be reckoned; that is, whether from right to left, or from left to right. To adapt the telegraph for night signals, a lantern is fixed to the pivot on which the arms move, and one is also attached to the extremity of each arm. In the management of a fleet at sea, telegraphic communication is indispensable. In the British navy, the signals are generally made by flags. The common or optical telegraph, which is always useless in hazy weather, is now superseded by the application of electricity or galvanism to the rapid communication of intelligence.—*Electric telegraph*, an apparatus for transmitting intelligence by means of voltaic electricity. Telegraphs of this kind are very various in the mechanical details of their construction; but they all depend on the electro-magnetic influence which a voltaic current is capable of exercising in its passage between the poles of the generating battery. The course

through which the current proceeds from, and returns to, the battery, is its *circuit*, and may be indefinitely prolonged by a conducting medium. A first and necessary, and, therefore, a general condition of the application of this agency to telegraphic purposes, consists consequently in the establishment of a connection between the telegraphic stations by at least one wire. This wire must likewise communicate at each extremity with an apparatus adapted to render the dynamical effects of the current visible in a definite and intelligible manner, and must likewise have communication with a voltaic generator. The common arrangement is such, that by turning a small handle at either station, complete metallic connection is obtained between the apparatus at the two stations, through the wire passing between them. The batteries are connected by wires with plates of metal at some depth in the ground, the moisture of which serves instead of a second wire to return the current to the generating battery. This circuit can be completed and broken, and the direction of the current reversed in the operation of telegraphing, by simply turning the handles before-mentioned; and the electric force, acting simultaneously on the apparatus at the respective stations, produces in them, in obedience to the will of the operator, those movements to which the species of mechanism is adapted, and which, having all preconcerted significations, are readily interpreted by the observer at the station to which the signals are transmitted. These features are common to all electric telegraphs; and the signalling apparatus, though subject to indefinite variations of mechanical detail, is reducible to two modes of action, depending on the two fundamental laws of electro-magnetism. In the *needle-telegraph*, which is that most commonly employed in this country, the movements depend on the famous discovery of Ørsted (1819), that a magnet placed within the influence of a voltaic current is invested with an artificial polarity, and being freely poised, is deflected tangentially to the direction of the current, as exemplified in the galvanometer,—*which see*. The essential part of the apparatus, therefore, consists of a movable magnet placed within a coil of the circuit-wire: the axis of the magnet is horizontal, and, projecting through a dial-plate, carries a pointer to indicate the movements of the magnet concealed in the wire-coil behind the dial. So long as the circuit is *open*, the pointer remains in a vertical position, but the moment the circuit is *closed*, it is deflected to the right or left, according to the direction of the current, and as the circuit can be opened and closed, and the current reversed many times in a minute, a corresponding number of movements of the magnet, and, consequently, also of the pointer in front of the dial, can be effected, and all that is requisite to render these movements significant is an agreement as to the symbol which each position and combination of positions of the pointer shall indicate. And as the apparatus at each station is precisely a counterpart of that at the other, the movements in both are exactly alike, and the attendants see their respective pointers deflect ex-

actly in the same way, in the same direction, the same number of times, and virtually at the same instant. But there being only two kinds of movements afforded by the *single-needle-telegraph*, that is, a movement to the right and another to the left, it is usually necessary to combine repetitions of these to denote a single letter of the alphabet, and, therefore, the rate of telegraphing is slow. To obviate this, the *double-needle-telegraph* is employed. In this there are two coils of wire, two magnets, having each a pointer or index-hand visible in front of the dial-face, and two wires to convey the electric current and its message between the stations. The circuits are closed and opened, and the currents reversed, by two small handles which communicate with the mechanism behind the dial. These handles can be worked simultaneously, alternately, and in any order of succession, and all these movements and combinations of movements being indicated by the pointers and made to represent signals, the rapidity of telegraphing is much increased. The principle of action is, however, in every respect the same as in the single instrument; the passage of the impulse from station to station is equally instantaneous in both, but there being fewer movements of the handles necessary to produce a given number of signals, the rate of telegraphing is correspondingly greater with the double instrument. Both instruments also agree in having a bell, by which the attention of the attendant is called to the instrument when a message is about to be transmitted to him from the distant station. The bell is made to ring by an arrangement in which the second electro-magnetic law is brought into action, viz., that a galvanic current, passing through a wire twisted round a piece of soft iron, renders the iron powerfully magnetic, a property which it instantly loses when the current is stopped. The applications of this principle are exceedingly numerous; in the present case, the arrangement is such that the current causes the movement of a small lever connected with the bell-hammer, which accordingly strikes, and thereby gives the requisite notice to the attendant. A separate wire extends between the two stations, to connect these apparatus, and to allow of their being worked independently of the signalling instruments. The second class of electric telegraphs all depend fundamentally on the principle here brought into action. When the iron is magnetic, it exerts an attractive force on another piece of iron; and this force ceasing with the interruption of the current—which may take place many times in a minute—this second piece of iron receives a movement to and fro, according as the attracting force is created and destroyed. This alternation of movement being generated, there are abundant means of transforming it so as to indicate symbols; and, in some cases, it is successfully applied to record its own indications in a permanent form, at a minimum rate of 100 letters a minute. Even very promising attempts have been made to transmit fac-similes of printed and written documents and drawings by adaptation of this principle. Time is also telegraphed by ana-

logous mechanism; and any number of clocks, at any distances apart, in the same voltaic circuit, may be worked synchronously with a standard clock. Telegraphs on the electro-magnetic principle may be indefinitely extended over a country, and may all be so connected one with another, that intelligence can be transmitted, through the same apparatus, from any number of stations with which it may be put in communication. The expense of their establishment consists chiefly in the connecting wires, which must necessarily be insulated from the ground, and protected against atmospheric influence. *Electric telegraphs* have of late years been brought into extensive use in this country, in the United States of America, and on the continent of Europe.

**TELEGRAPH**, *v. t.* To transmit intelligence by means of an electric telegraph; as, to telegraph the queen's speech.

**TELEGRAPHIC**, *a.* Pertaining to the telegraph; made by a telegraph; as, telegraphic movements or signals; telegraphic art.—2. Communicated by a telegraph; as, telegraphic intelligence.

**TELEGRAPHICALLY**, *adv.* By the telegraph.

**TELEGRAPHY**, *n.* The art or practice of communicating intelligence by a telegraph.

**TELEOLOGICAL**, *a.* Pertaining to teleology.

**TELEOLÓGY**, *n.* [Gr. *τελος*, end, and *λογος*, discourse.] The science of the final causes of things.

**TELOSÁURUS**, *n.* [Gr. *τελος*, perfect, complete, and *σαυρος*, a lizard.] A genus of fossil *Saurians*, with long and narrow snouts. They are confined to the oolitic division of the secondary rocks.

**TELEPHONIC**, *a.* [Gr. *τηλε*, at a distance, and *φωνη*, sound.] Far-sounding; that propels sound to a great distance.

**TELESCOPE**, *n.* [Fr. from Gr. *τελος*, end, or *τηλε*, at a distance, probably the latter, and *σκοπειν*, to see; It. and Sp. *telescopio*.] An optical instrument by which distant objects are brought within the range of distinct vision. The *terrestrial* telescope enables the mariner to survey the ocean to the limits of the horizon, and discovers to the traveller inaccessible objects and distant scenery lying around and beyond his line of route. The *celestial* telescope unfolds the wonders of the universe, and the science of astronomy has advanced with the gradual improvement of this instrument. The *modus operandi*, or law of action, by which the telescope assists human vision, is two-fold, and that under all the varieties of its construction. A distant object, viewed by the unaided eye, is placed in the circumference of a large circle, having the eye for its centre; and, consequently, the angle under which it is seen is measured by the minute portion of the circumference which it occupies. Now, when the distance is great, it is found that this angle is too small to convey to the retina any sensible impression—all the light proceeding from the object is too weak to affect the optic nerve. This limit to distinct vision results from the small aperture, or pupil, of the eye. The telescope substitutes its large object

lens, or reflector, for the human eye, and consequently receives a quantity of light proportioned to its area or surface; hence, a distant point, inappreciable by the eye alone, is rendered visible by the aid of the telescope. The rays of light, after transmission or reflection, converge to a point, as they at first proceeded from a point; and thus an image of the object is formed, which, when viewed by the eye-piece, or lens, is more or less magnified. The telescope therefore assists the eye in these two ways: it gathers up additional light, and it magnifies the object—that is to say, its image. The *refracting* telescope is constructed of lenses alone, which, by successive refractions, produce the desired effect. This instrument was formerly very cumbersome and inconvenient, inasmuch as its length had to be increased considerably with every accession of power; and though the substitution of achromatic for ordinary lenses has rendered it more portable, its construction even at the present day does not enable it to compete with the reflecting telescope as an astronomical investigator. The *reflecting* telescope is composed of specula or concave reflectors, aided by a refracting eye-piece. To this instrument we owe the most wondrous discoveries in astronomical science. The names of Newton, Gregory, and Herschel are connected with its history; and in our own day, Lord Rosse has extended its powers as far, probably, as they can be carried with utility. The following diagrams exhibit the principles of construction and action in both sorts of telescopes.

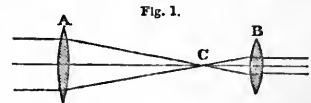

In fig. 1. A and B are two lenses of different focal lengths. Rays of light from a distant object falling upon the object-glass, A, are converged to a focus at C. The eye-glass, B, placed at its focal distance from the point of convergence, gathers up the diverging rays and carries them parallel to the eye. The magnifying power of the instrument is as AC : CB, or as the focal length of one lens to that of the other. In this construction the object is inverted by the intersection of the rays, and hence it is unsuitable for terrestrial purposes. To render the image erect, a more complicated eye-piece, consisting of two additional lenses, is necessary. Fig. 2. shows the structure

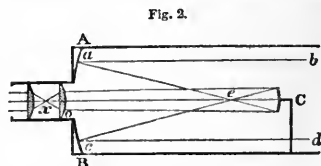

of the reflecting telescope as constructed by Dr. Gregory. AB is a large speculum perforated in the centre; upon this fall the rays *a, b*, and *c, d*, which are reflected to convergence at *e*. A smaller speculum, C, takes up the diverging rays, and reflects them,

slightly converging, through the aperture  $\alpha$ , where they are received by a lens, and, after transmission, they intersect at  $x$ , and proceed to the eye-glass, whence they emerge parallel. The magnifying power of this instrument is great for its length, being as  $\frac{oe}{eC} \times \frac{x}{\alpha}$ . The Herschelian

telescope, invented by Sir William Herschel, is the one now generally used for astronomical purposes, as being the best and most powerful. In this construction there is no second speculum, and no perforation in the centre of the larger one placed at the bottom of the tube. The latter is fixed in an inclined position, so that the image formed by reflection falls near the lower side of the tube at its open end or mouth, where it is viewed directly by an eye-piece without greatly interfering with the light. This arrangement, in the case of large reflectors, is imposed by their great weight and difficult management; were it otherwise the ordinary construction would be preferred. The inclination of the speculum is a disadvantage.

TELESCOPE-SHELL, *n.* In *inchoel.*, a species of Turbo with plane, striated, and numerous spires.

TELESCOP'IC, } *a.* Pertaining to TELESCOP'ICAL, } a telescope; performed by a telescope; as, a *telescopic* view.—2. Seen or discoverable only by a telescope; as, *telescopic* stars.

TELESCOP'ICALLY, *adv.* By the telescope.

TELESCOPIUM, *n.* The telescope, a constellation in the southern hemisphere, situated south of the Centaur and Sagittarius. It contains nine stars, all, except one, of less than the fourth magnitude.—*Telescopium Herscheli*, Herschel's telescope, a new asterism inserted in honour of Sir William Herschel the astronomer. It is surrounded by Lynx, the Twins, and Auriga; seventeen stars have been assigned to it.

TELES'IA, *n.* Sapphire.

TELES'M, *n.* [Ar.] A kind of amulet or magical charm.

TELESMATIC, } *a.* Pertaining to TELESMAT'ICAL, } telemas; magical.

TELES'TICH, *n.* [Gr. *τελος*, end, and *στιχος*, a verse.] A poem in which the final letters of the lines make a name.

TELC'IC, *a.* [Gr. *τελος*, end.] Denoting the final end or purpose.

TELL, *v. t.* pret. and pp. *Told.* [Sax. *tellan*; G. *zahlen*; D. *tellen*, to count, number, or tell; Dan. *tæler*, to count; *taler*, to talk, speak, reason; Sw. *tala*, to speak, to talk; *tal*, talk, discourse, speech, number; Dan. *tale*; Ice. *tala*, id. The primary sense is to throw or drive, L. *telum*, Ar. *dalla*. So L. *appello* and *peal*, L. *pello*, Gr. *βαλλω*.] 1. To utter; to express in words; to communicate to others.

I will not eat till I have *told* my errand; Gen. xxiv.

2. To relate; to narrate; to rehearse particulars; as, to *tell* a story; Gen. xxxvii.

And not a man appears to *tell* their fate. Pope.

3. To teach; to inform; to make known; to show by words. *Tell* us the way.

Why didst thou not *tell* me that she was thy wife? Gen. xii.

4. To discover; to disclose; to betray. They will *tell* it to the inhabitants of this land; Num. xiv.

5. To count; to number.

Look now toward heaven, and *tell* the stars; Gen. xv.

6. To relate in confession; to confess or acknowledge.

*Tell* me now what thou hast done; Josh. vii.

7. To publish.

*Tell* it not in Gath; 2 Sam. i.

8. To unfold; to interpret; to explain; Ezek. xxiv.—9. To make excuses.

Tnsh, never *tell* me.

Shak.

10. To make known.

Our feelings *tell* us how long they ought to have submitted. Junius.

11. To discover; to find; to discern. The colours are so blended that I cannot *tell* where one ends and the other begins.—*To tell off*; to count; to enumerate; to divide. *Tell*, though equivalent in some respects to *speak* and *say*, has not always the same application. We say, to *tell* this, that, or what, to *tell* a story, to *tell* a word, to *tell* truth or falsehood, to *tell* a number, to *tell* the reasons, to *tell* something or nothing; but we never say, to *tell* a speech, discourse, or oration, or to *tell* an argument or a lesson. It is much used in commands. *Tell* me the whole story; *tell* me all you know, or all that was said. *Tell* has frequently the sense of *narrate*; which *speak* and *say* have not.

TELL, *v. i.* To give an account; to make report.

That I may publish with the voice of thanksgiving, and *tell* of all thy wondrous works; Ps. xxvi.

2. To take effect; as, every shot *tells*.

—3. To produce some effect; as, every expression *tells*.—*To tell of*, or, *To tell on*, to inform. You must not disobey; I will *tell* of you if you do. This is a common popular use of the word. *To tell on*, is quite vulgar as well as improper.

TELL'ER, *n.* One that tells, relates, or communicates the knowledge of something.—2. One who numbers; as, one who numbers, *tells*, or records votes. The *tellers* in the house of commons are parties appointed, when a division takes place, to note the votings, and report which side has the majority, and how great that majority is.—3. An officer of the exchequer, in ancient records called *tallier*. [See TALL.]

The *tellers* of the exchequer were four in number; their duties were to receive money payable into the exchequer on behalf of the king, to give the clerk of the pells a bill of receipt for the money, to pay all money according to the warrant of the auditor of receipts, and to make weekly and yearly books of receipts and payments for the lord treasurer. The office was abolished by 4 and 5 Will. IV., c. 15, and the duties of the four tellers are now performed by a comptroller-general of the receipt and issue of the exchequer.—4. A functionary in a banking establishment, whose business is to receive and pay money for bills, orders, &c.

TELL'ERSHIP, *n.* The office or employment of a teller.

TELL'YNA, *n.* A genus of marine and fresh-water bivalves, characterized by the hinge of the shell having one tooth on the left, and two teeth on the right valve, often bifid. In the right valve there is a plate which does not enter a cavity in the opposite valve. About 100 species are known, upwards of 20 of which inhabit the seas of our coasts.

The tellina is remarkable for the quickness and agility with which, when on



Tellina radiata.

the surface of the sands, it can spring to considerable distances. Many species are found fossil.

TELL'ING, *ppr.* Uttering; relating; disclosing; counting.

TELL'INITE, *n.* [from *tellina*, a genus of testaceous animals.] Petrified or fossil shells of the genus *Tellina*.

TELL'-TALE, *a.* Telling tales; babbling.

TELL'-TALE, *n.* [*tell* and *tale*.] One who officiously communicates information of the private concerns of individuals; one who tells that which prudence should suppress, and which if told, often does mischief among neighbours.—2. A movable piece of ivory or lead on a chamber organ, that gives notice when the wind is exhausted.—3. In *seamanship*, a small piece of wood, traversing in a groove across the front of the poop deck, and which, by communicating with a small barrel on the axis of the steering wheel, indicates the situation of the helm.

TELL'LURALE, *a.* [L. *tellus*.] Pertaining to the earth.

TELL'LURATE, *n.* A compound of telluric acid and a base.

TELL'LURET'ED, *a.* *Telluretted hydrogen* is the name formerly given to *Hydrotelluric acid*. It is a gaseous compound, obtained by the action of hydrochloric acid on an alloy of tellurium. It is a feeble acid, analogous in composition, smell, and other characters to sulphuretted hydrogen.

TELL'URIC, *a.* [L. *tellus*, the earth.] Pertaining to the earth or proceeding from the earth; as, a disease of *telluric* origin.

TELL'URIC ACID, *n.* An oxide of tellurium which is formed when tellurium is deflagrated with nitre. It is a soluble and crystallizable acid, composed of 1 atom of tellurium and 3 of oxygen.

TELL'URION, *n.* [from L. *tellus*.] An instrument for showing in what manner the causes operate which produce the succession of day and night, and the changes of the seasons; a kind of orrery.

TELL'LURITE, *n.* A compound of tellurous acid and a base.

TELL'URIUM, *n.* A metal discovered by Müller, in 1782, combined with gold and silver in the ores, and received from the Bannat of Temeswar. The ores are denominated *native*, *graphic*, *yellow*, and *black*. The native tellurium is of a colour between tin and silver, and sometimes inclines to a steel gray. The *graphic* tellurium is steel gray; but sometimes white, yellow, or lead gray. These ores are found massive or crystallized. Tellurium is very brittle, and has a specific gravity of 6.26. It is very fusible, and volatile at a red heat. It sometimes gives forth an odour of decayed horse-radish during combustion, which Berzelius ascribes to the presence of minute portions of selenium.

**TEL/LUROUS AC'ID, n.** An oxide of tellurium, analogous to selenious acid, and like it formed by the action of nitric acid on the metal. It is a white insoluble powder, forming with alkalies crystallizable salts.

**TEM'ACHIS, † n.** [Gr. *τεμαχης*, a piece.] A genus of fossils of the class of gypsums, softer than others, and of a bright glittering hue.

**TEMERA'RIOUS, a.** [Fr. *teméraire*; *L. temerarius*; from the root of *time*, *tempest*,—which see. The sense is rushing or advancing forward.] 1. Rash; headstrong; unreasonable; adventurous; despising danger; as, *temerarious folly*.—2. Careless; heedless; done at random; as, the *temerarious dash* of an unguided pen. [*This word is not much used.*]

**TEMERA'RIOUSLY, adv.** Rashly; with excess of boldness.

**TEMER'ITY, n.** [*L. temeritas*; properly a rushing forward. See *TIME*.] 1. Rashness; unreasonable contempt of danger; as, the *temerity* of a commander in war.—2. Extreme boldness. The figures are bold even to *temerity*.

Cowley.

**TEM'IN, n.** A money of account in Algiers, equivalent to 2 carubes, or 29 aspers, about 17d. sterling.

**TEMPER, v. t.** [*L. tempero*, to mix or moderate; *It. temperare*; *Sp. templar*, to temper, to soften, or moderate, to anneal, as glass, to tune an instrument, to trim sails to the wind; *Fr. temperer*, to temper, alloy, or abate; *W. tymperu*, to temper, to mollify; *tym*, space; *tym*p, enlargement, birth, season. The latter unites this word with *time*. The sense of this word is probably from making seasonable, or timely; hence, to make suitable.] 1. To mix so that one part qualifies the other; to bring to a moderate state; as, to *temper justice with mercy*.—2. To compound; to form by mixture; to qualify; as, by an ingredient; or, in general, to mix, unite, or combine two or more things so as to reduce the excess of the qualities of either, and bring the whole to the desired consistence or state.

Thou shalt make it a perfume, a confection after the art of the apothecary, *tempered* together, pure and holy; Exod. xxx. 3. To unite in due proportion; to render symmetrical; to adjust, as parts to each other.

God hath *tempered* the body together, 1 Cor. xii.

4. To accommodate; to modify.

Thy sustenance serving to the appetite of the eater, *tempered* itself to every man's liking. *Widom.*

5. To soften; to mollify; to assuage; to soothe; to calm; to reduce any violence or excess.

Solon...laboured to *temper* the warlike courages of the Athenians with sweet delights of learning. *Spenser.*

Woman! nature made thee  
To *temper* man; we had been brutes without you. *Ottaway.*

6. To form to a proper degree of hardness; as, to *temper iron or steel*. [See *TEMPERING*.]

The *temper'd* metals clash, and yield a silver sound. *Dryden.*

7.† To govern; a *Latinism*.—8. In *music*, to modify or amend a false or imperfect concord by transferring to it a part of the beauty of a perfect one, that is, by dividing the tones.

**TEMPER, n.** Due mixture of different qualities; or the state of any com-

pond substance which results from the mixture of various ingredients; as, the *temper of mortar*.—2. Constitution of body. [In this sense we more generally use *temperament*.]—3. Disposition of mind; the constitution of the mind, particularly with regard to the passions and affections; as, a *calm temper*; a *hasty temper*; a *fretful temper*. This is applicable to beasts as well as to man.

Remember with what mild

And gracious *temper* he both heard and judg'd. *Milton.*

4. Calmness of mind; moderation.

Restore yourselves to your *tempers*, fathers. *B. Jonson.*

To fall with dignity, with *temper* rise. *Pope.*  
5. Heat of mind or passion; irritation. The boy showed a great deal of *temper* when I reproved him. So we say, a man of violent *temper*, when we speak of his irritability. [*This use of the word is common, though a deviation from its original and genuine meaning.*]—6. The state of a metal, particularly as to its hardness; as, the *temper of iron or steel*.—7. Middle course; mean or medium.—8. In *sugar works*, white lime or other substance stirred into a clarifier filled with cane-juice, to neutralize the superabundant acid.

**TEMPERAMENT, n.** [Fr. from *L. temperamentum*.] 1. Constitution; state with respect to the predominance of any quality; as, the *temperament of the body*. In *physiol.*, temperament has been defined as a peculiar organization of the system common to several individuals, which to a certain extent influences the thoughts and actions. There is besides in each individual a further peculiarity of organization, which serves to distinguish his temperament from that of any other person, to whom, however, he may in other respects bear a great resemblance. This individual temperament is called an *idiosyncrasy*. The ancient physicians enumerated four temperaments, viz., the *sanguine*, the *choleric*, the *phlegmatic*, and the *melancholic*. These terms are still in use among medical writers, and modern physiologists add a fifth, viz., the *nervous temperament*.—2. Medium; due mixture of different qualities.

The common law...has reduced the kingdom to its just state and *temperament*.

*Hale.*

3. In *music*, temperament is the accommodation or adjustment of the imperfect concords in musical instruments, by transferring a part of their defects to the more perfect ones, to remedy in part the false intervals of instruments of fixed sounds, as the organ, harpsichord, piano-forte, &c. To those acquainted with the theory of the musical scale, it is well known that all the concords cannot be made perfect. The interval of a tone is not always the same; for instance, that lying between the fourth and fifth of the scale contains nine small parts called *commas*; whereas that between the fifth and the sixth of the major scale, contains only eight *commas*. Again, the diatonic semitone contains five *commas*, and the chromatic semitone three or four, according to the magnitude of the tone. These inequalities in the intervals of the scale are a source of imperfection in musical instruments whose sounds are fixed, and it is impossible altogether to

remedy the imperfection. If, for example, a piano-forte be tuned by a series of perfect octaves from the lowest C to the highest, and if another piano-forte be tuned from the same pitch by a series of perfect 6ths, ending

with B $\sharp$ , it will be found that this last note is not in tune with the upper C of the first piano-forte, being higher by

a comma; but on the piano-forte B $\sharp$  being played on the same key as C, should be identically the same sound; therefore this discrepancy must be removed by a proper adjustment. Again, on the piano-forte three successive major thirds form an octave. Now, should these three successive thirds be tuned perfect to each other, it will be found that they fall short of the perfect octave by a comma, so that one, two, or all of the thirds must be altered and tuned sharper than perfect thirds, to compensate for the deficiency. Four successive minor thirds will, on the other hand, be found to exceed the octave by a comma, which defect must be removed by flattening. These slight alterations, which are made in order that any one of the twelve semitones which compose an octave may be fit to be used as a key note, without any shock to the ear, constitute what is termed the *temperament of the scale*; and the altered consonances are said to be *tempered*. There are in use two modes of temperament, the *equal* and the *unequal*. *Equal temperament* is that mode in which the necessary defects of the scale are distributed equally throughout it; and *unequal temperament*, that in which the defects are unequally distributed, so as to make some keys feel them less than others. The most common practice among tuners of the present day is to aim at equal temperament, but this is very difficult to accomplish; whereas the unequal temperament is easily obtained in tuning, and has the additional advantage of giving to every one of the twelve major and minor scales a particular character.

The harshness of a given concord increases with the *temperament*. *Prof. Fisher.*

**TEMPERAMENTAL, a.** Constitutional. [*Not much used.*]

**TEMPERANCE, n.** [Fr. from *L. temperantia*, from *tempero*.] 1. Moderation; particularly, habitual moderation in regard to the indulgence of the natural appetites and passions; restrained or moderate indulgence; as, *temperance in eating and drinking*; *temperance in the indulgence of joy or mirth*. *Temperance in eating and drinking* is opposed to *gluttony and drunkenness*, and in other indulgences, to *excess*.—2. Patience; calmness; sedateness; moderation of passion. He calm'd his wrath with goodly *temperance*. [*Unusual.*]

*Spenser.*  
*Temperance societies* are associations formed for the purpose of repressing drunkenness, and banishing it from society. The basis on which these associations have generally been formed, has been that of an engagement on the part of each member to abstain from the use of ardent spirits, except for medicinal purposes, and to forbear to provide them for the entertainment of friends or the supply of dependents. Many such associations exist in this country, and also in the United States

of America, and although considerable difference of opinion exists as to the soundness of the principle on which they are based, it must nevertheless be allowed by all that they have been productive of much good. They are, however, more appropriately designated *abstinence* or *abstinent societies*, than *temperance societies*. [See *ABSTINENCE*.]

**TEMPERANCE**, *a.* Belonging to temperance, or moderation in the use of strong drinks, almost or quite to the extent of abstinence; as, the *temperance* movement.

**TEMPERATE**, *a.* [L. *temperatus*.] 1. Moderate; not excessive; as, *temperate* heat; a *temperate* climate; *temperate* air.—2. Moderate in the indulgence of the appetites and passions; as, *temperate* in eating and drinking; *temperate* in pleasures; *temperate* in speech.

Be sober and *temperate*, and you will be healthy. *Franklin*.

3. Cool; calm; not marked with passion; not violent; as, a *temperate* discourse or address; *temperate* language.—4. Proceeding from temperance; as, *temperate* sleep.—5. Free from ardent passion.

She is not hot, but *temperate* as the morn. *Shak.*

*Temperate zones*, the spaces on the earth between the tropics and the polar circles, where the heat is less than in the tropics, and the cold less than in the polar circles. The *North temperate zone*, is the space included between the tropic of Cancer and the arctic circle; and the *South temperate zone*, that between the tropic of Capricorn and the antarctic circle. [See *ZONE*.]

**TEMPERATELY**, *adv.* Moderately; without excess or extravagance.—2. Calmly; without violence of passion; as, to reprove one *temperately*.—3. With moderate force.

Winds that *temperately* blow. *Addison*.

**TEMPERATENESS**, *n.* Moderation; freedom from excess; as, the *temperateness* of the weather or of a climate.—2. Calmness; coolness of mind.

**TEMPERATIVE**, *a.* Having the power or quality of tempering.

**TEMPERATURE**, *n.* [Fr. from L. *temperatura*.] 1. In *physics*, the state of a body with regard to heat or cold, as indicated by the thermometer, or generally by its effects on other bodies; or the degree of free caloric which a body possesses, when compared with other bodies. When a body applied to another, expands that body, we say it is of a *higher temperature*; that is, it possesses more free caloric. When it contracts another body, it is said to be of a *lower temperature*. Thus we speak of the *temperature* of air, of water, of a climate, &c.; two countries of the same *temperature*.—*Mean temperature of a place*, a mean of all the temperatures observed at that place at regular intervals during a certain space of time. The mean annual temperature of any place is obtained by taking a mean of all the temperatures indicated by the thermometer each day throughout the year. Springs in which the water does not considerably change its heat from one season of the year to another, afford an expeditious and accurate way of ascertaining the mean temperature of a place. Every place on the earth's surface has a mean temperature, which remains always nearly the same, and

which decreases from the equator to either pole, according to a certain law. The mean temperature at the equator is estimated at 81°. The temperature of a place depends not only on its latitude, but also on its elevation above the level of the sea, and various other local causes, such as the nature of the soil, the prevailing winds, the quantity of moisture, the electric state of the atmosphere, and the physical character of the adjacent countries and seas. But no cause has such an effect in lowering the temperature of a place as elevation above the level of the sea; and hence near the equator and tropics there are mountains which, owing to their great elevation, are covered with snow all the year round. [See *SNOW-LINE*.] The temperature of the sea is more uniform and moderate than that of the land. For ascertaining temperatures below 600° the thermometer is used, but for temperatures above 600°, instruments called pyrometers are employed.—2. Constitution; state; degree of any quality.

Memory depends upon the consistence and *temperature* of the brain. *Watts*.

3. Moderation; freedom from immoderate passions.

In that proud port, which her so goodly graceth,

Most goodly *temperature* you may descry. [Not in use.] *Spenser*.

**TEMPERED**, *pp.* Duly mixed or modified, as mortar; reduced to a proper state; softened; alloyed; hardened, as steel.—2. Adjusted by musical temperament.—3. *a.* Disposed; as, a well *tempered*, good *tempered*, or bad *tempered* man.

**TEMPERING**, *ppr.* Mixing and qualifying; qualifying by mixture; softening; mollifying; reducing to a state of moderation; hardening.

**TEMPERING**, *n.* The process of giving iron or steel, especially the latter, the different degrees of hardness required for the various purposes to which it is applied. The excellence of all cutting steel instruments depends on the degree of temper given to them. Different degrees of temper are indicated by different colours which the steel assumes. Thus, steel heated to 450°, and suddenly cooled, assumes a pale straw colour, and is employed for making razors and surgical instruments. [See *STEEL*.]

**TEMPEST**, *n.* [Fr. *tempête*; L. *tempestas*; Sp. *tempestad*; It. *tempesta*; from L. *tempus*, time, season. The primary sense of *tempus*, time, is a falling, or that which falls, comes, or happens, from some verb which signifies to fall or come suddenly, or rather to drive, to rush. *Time* is properly a coming, a season, that which presents itself, or is present. The sense of *tempest* is from the sense of rushing or driving. See *TEMERITY* and *TEMERARIOUS*.] 1. An extensive current of wind, rushing with great velocity and violence, and commonly attended with rain, hail, or snow; a storm of extreme violence. We usually apply the word to a steady wind of long continuance; but we say also of a tornado, it blew a *tempest*. The currents of wind are named, according to their respective degrees of force or rapidity, a *breeze*, a *gale*, a *storm*, a *tempest*; but *gale* is also used as synonymous with *storm*, and *storm* with *tempest*. *Gust* is usually applied to a sudden blast of short

duration. A *tempest* may or may not be attended with rain, snow, or hail. We, caught in a fiery *tempest*, shall be hurld Each on his rock transfixed. *Milton*.

2. A violent tumult or commotion; as, a popular or political *tempest*; the *tempest* of war.—3. Perturbation; violent agitation; as, a *tempest* of the passions. **TEMPEST**, *v. t.* To disturb, as by a *tempest*. [Little used.]

**TEMPEST**, *† v. i.* [Fr. *tempester*.] To storm.—2. To pour a tempest on.

**TEMPEST-BEATEN**, *a.* [tempest and beat.] Beaten or shattered with storms.

**TEMPESTIVE**, *† a.* Seasonable.

**TEMPESTIVELY**, *adv.* Seasonably. **TEMPESTIVITY**, *† n.* [L. *tempestivus*.] Seasonableness.

**TEMPEST-TOST**, *a.* [tempest and tost.] Tossed or driven about by tempests.

**TEMPESTUOUS**, *a.* [Sp. *tempestuoso*; It. *tempestoso*; Fr. *tempêteux*.] 1. Very stormy; turbulent; rough with wind; as, *tempestuous* weather; a *tempestuous* night.—2. Blowing with violence; as, a *tempestuous* wind.

**TEMPESTUOUSLY**, *adv.* With great violence of wind or great commotion; turbulently.

**TEMPESTUOUSNESS**, *n.* Storminess; the state of being tempestuous or disturbed by violent winds; as, the *tempestuousness* of the winter or of weather.

**TEMPLAR**, *n.* [from the *Temple*, a house near the Thames, which originally belonged to the knights Templars. The latter took their denomination from an apartment of the palace of Baldwin II. in Jerusalem, near the temple.] 1. *Templars*, *knights of the Temple*, a religious military order, first established at Jerusalem in favour of



Templars.

1. Jean de Dreux, Church of St. Yved, at Braine. 2. Geoffrey de Magnville, Temple Church, London.

pilgrims travelling to the Holy Land. The order originated with some persons who, in 1118, devoted themselves to the service of God, promising to live in perpetual chastity, obedience, and poverty, after the manner of canons. In 1228, this order was confirmed in the council of Troyes, and subjected to a rule of discipline. It flourished, became immensely rich, and its members became so insolent and vicious, that the order was suppressed by the council of Vienne, in 1312.—2. A student of the law.

**TEMPLE**, *n.* In *arch.*, a short piece of timber laid under the end of a beam or girder, resting on a wall, to distribute the weight over a large space.

**TEMPLE**, *n.* [Fr.; L. *templum*; It. *tempio*; W. *temyl*, temple, that is, ex-



tended, a seat; *temlu*, to form a seat, expanse, or temple; Gaelic, *teampul*.] 1. A public edifice erected in honour of some deity. Among pagans, a building erected to some pretended deity, and in which the people assembled to worship. Originally, temples were open places, as the Stonehenge in England. In Rome, some of the temples were open, and called *sacella*; others were roofed, and called *ædes*. The most celebrated of the ancient pagan temples were that of Belus in Babylon, that of Vulcan at Memphis, that of Jupiter at Thebes, that of Diana at Ephesus, that of Apollo in Miletus, that of Jupiter Olympius in Athens, and that of Apollo at Delphi. The most celebrated and magnificent temple erected to the true God, was that built by Solomon in Jerusalem. The form most generally given to the ancient temples was that of a rectangle, but sometimes the construction was circular. Vitruvius divides temples into eight kinds, according to the arrangement of their columns, viz., temples in *antis* [see ANTE], *prostyle*, *amphiprostyle*, *peripteral*, *dipteral*, *pseudo-dipteral*, *hypæthral*, and *monopteral*. [See these terms.] In regard to intercolumniation, they were farther distinguished into *pyncostyle*, *systyle*, *eustyle*, *diastyle*, and *araostyle*. [See these terms.] Of circular temples there are two species, the *monopteral*, without a cell, and the *peripteral*, with a cell.—In *Scripture*, the tabernacle is sometimes called by this name; 1 Sam. i.—iii.—2. A church; an edifice erected among Christians as a place of public worship.

Can he whose life is a perpetual insult to the authority of God, enter with any pleasure a temple consecrated to devotion and sanctified by prayer? *Buckminster.* 3. A place in which the divine presence specially resides; the church as a collective body; Eph. ii.—4. The name of two semi-monastic establishments of the middle ages, one in London, the other in Paris, inhabited by the knights Templars. The Temple Church, London, is the only portion of either establishment now existing. On the site of both, modern edifices have been erected, those in London forming the two Inns of Court, called the Middle Temple and Inner Temple.

TEMPLE, *n.* [L. *tempus*, *tempora*. The primary sense of the root of this word is to fall. See TIME.] 1. Literally, the fall of the head; the part where the head slopes from the top.—2. In *anat.*, the *temples* are anterior and lateral parts of the head, where the skull is covered by the temporal muscles.

TEMPLE, *v. t.* To build a temple for; to appropriate a temple to. [Lit. us.]

TEMPLET, *n.* A mould used in masonry and brickwork, for cutting or setting out the work; and, generally among artizans, a mould or pattern for shaping any thing.

TEMPO, *n.* [It.] In *music*, a word used to express time, or the degree of quickness with which a piece of music is to be executed. The degrees of time, generally speaking, are five, and are designated by the terms *largo*, *adagio*, *andante*, *allegro*, and *presto*; and the intermediate degrees are expressed by additions to these terms. A *tempo*, denotes that the former time is to be resumed, or a more distinct time observed.

O TEMPORA, O MORES. [L.] Oh the times, oh the manners.

TEMPORAL, *a.* [Fr. *temporel*; from L. *temporalis*, from *tempus*, time.] 1. Pertaining to this life or this world, or the body only; secular; as, *temporal* concerns; *temporal* affairs. In this sense, it is opposed to *spiritual*. Let not *temporal* affairs or employments divert the mind from *spiritual* concerns, which are far more important. In this sense also it is opposed to *ecclesiastical*; as, *temporal* power, that is, secular, civil, or political power; *temporal* courts, those which take cognizance of civil suits. *Temporal* jurisdiction is that which regards civil and political affairs.—2. Measured or limited by time, or by this life or this state of things; having limited existence; opposed to *eternal*.

The things which are seen are *temporal*, but the things which are not seen are eternal; 2 Cor. iv.

3. In *gram.*, relating to a tense.—*Temporal augment*, the short initial vowel of a verb, lengthened, in certain tenses, into the corresponding long one.—4. [Fr. *temporal*.] Pertaining to the temple or temples of the head; as, the *temporal* bone; a *temporal* artery or vein; *temporal* muscle. The *temporal bones* are two bones situated one on each side of the head, of a very irregular figure. They are connected with the occipital, parietal, sphenoid, and cheek bones, and are articulated with the lower jaw. The *temporal artery* is a branch of the external carotid, which runs on the temple, and gives off the frontal artery. The *temporal muscle* of the lower jaw, situated in the temple, serves to draw the lower jaw upwards, as in the action of biting.

TEMPORALITIES, } *n.* Secular pos-  
TEMPORALS, } sessions; re-  
venues of an ecclesiastic proceeding from lands, tenements, or lay-fees, tithes, and the like. It is opposed to *spiritualities*. The *temporalities*, or *temporals*, of bishops, are the revenues, lands, tenements, and lay-fees, belonging to bishops, as they are barons and lords of parliament. The *temporality of benefices*, in *Scots law*, consists in such lands or other property (except tithes, manses, and glebes) as may have accrued to the church, by gifts to, or purchases by, its members as such. This temporality has been annexed to the crown.

TEMPORALITY, *n.* A secular possession.

TEMPORALLY, *adv.* With respect to time or this life only.

TEMPORALNESS, } *n.* Worldliness.  
TEMPORALTY, } the laity; secular people. [Little used.]—2. Secular possessions. [See TEMPORALITIES.]

TEMPORANEOUS, *a.* Temporary. [Little used.]

TEMPORARILY, *adv.* For a time only; not perpetually.

TEMPORARINESS, *n.* [from *temporary*.] The state of being temporary; opposed to *perpetuity*.

TEMPORARY, *a.* [L. *temporarius*.] Lasting for a time only; existing or continuing for a limited time; as, the patient has obtained *temporary* relief. There is a *temporary* cessation of hostilities. There is a *temporary* supply of provisions. In times of great danger, Rome appointed a *temporary* dictator.

TEMPORIZATION, *n.* The act of temporizing.

TEMPORIZE, *v. i.* [Fr. *temporiser*; from L. *tempus*, time.] 1. To comply with the time or occasion; to humour or yield to the current of opinion or to circumstances; a *conduct that often indicates obsequiousness*. They might their grievance inwardly complain,

But outwardly they needs must *temporize*. *Danick.*

2. To delay; to procrastinate. Well, you will *temporize* with the hours. [Little used.] *Shak.*

3. To comply.

TEMPORIZER, *n.* One who yields to the time, or complies with the prevailing opinions, fashions, or occasions; a trimmer.

TEMPORIZING, *ppr.* Complying with the time, or with the prevailing humours and opinions of men; time-serving.

TEMPORIZING, *n.* A yielding to the time; a complying with the prevailing opinions, fashions, or occasions.

TEMPORIZINGLY, *adv.* In a temporizing manner.

TEMPT, *v. t.* [Arm. *tempti*; L. *tento*; Fr. *tenter*. It is from the root of L. *teneo*, Gr. *τενω*, and the primary sense is to strain, urge, press.] 1. To incite or solicit to an evil act; to entice to something wrong by presenting arguments that are plausible or convincing, or by the offer of some pleasure or apparent advantage as the inducement.

My lady Gray *tempts* him to this harsh extremity. *Shak.*

Every man is *tempted*, when he is drawn away by his own lust and enticed; James i.

2. To provoke; to incite. *Tempt* not the brave and needy to despair. *Dryden.*

3. To solicit; to draw; *without the notion of evil*. Still his strength conceal'd,

Which *tempted* our attempt, and wrought our fall. *Milton.*

4. To try; to venture on; to attempt. E'er leave be giv'n to *tempt* the nether sky. *Dryden.*

5. In *Scripture*, to try; to prove; to put to trial for proof. God did *tempt* Abraham; Gen. xxii. Ye shall not *tempt* the Lord your God; Deut. vi.

TEMP'TABLE, *a.* Liable to be tempted.

TEMP'TABILITY, *n.* Quality of being temptable.

TEMP'TATION, *n.* The act of tempting; enticement to evil by arguments, by flattery, or by the offer of some real or apparent good.

When the devil had ended all the *temptation*, he departed from him for a season; Luke iv.

2. Solicitation of the passions; enticements to evil proceeding from the prospect of pleasure or advantage.—3. The state of being tempted or enticed to evil. When by human weakness you are led into *temptation*, resort to prayer for relief.—4. Trial. Lead us not into *temptation*. *Lord's Prayer.*

5. That which is presented to the mind as an inducement to evil. Dare to be great without a guilty crown, View it, and lay the bright *temptation* down. *Dryden.*

6. In *colloq. lan.*, an allurements to any thing indifferent, or even good.

TEMP'TATIONLESS, *a.* Having no temptation or motive. [Little used.]

TEMPT'ED, *pp.* Enticed to evil; provoked; tried.

**TEMPTER**, *n.* One that solicits or entices to evil.

Those who are bent to do wickedly, will never want *tempters* to urge them on.

*Tillotson.*

2. The great adversary of man; the devil; *Matth. iv.*

**TEMPTING**, *ppr.* Enticing to evil; trying.—2. *a.* Adapted to entice or allure; attractive; as, *tempting* pleasures.

**TEMPTINGLY**, *adv.* In a manner to entice to evil; so as to allure.

**TEMPTINGNESS**, *n.* The state of being tempting.

**TEMPTRESS**, *n.* A female who entices.  
**TEMSE-BREAD**, } *n.* [*Fr. tamiser*;  
**TEMSED-BREAD**, } *It. tamisare*,  
*tamigiare*, to sift; *Fr. tamis*; *It. tamiso*,  
*tamigio*, a sieve.] Bread made of flour better sifted than common flour.

*Temse*, or *temsed*, signifies searched, strained, sifted. As a noun, *temse* signifies a sieve.

**TEMULENCE**, } † *n.* [*L. temulentia*.]  
**TEMULENCY**, } Intoxication; inebriation; drunkenness.

**TEMULENT**, † *a.* [*L. temulentus*.] Intoxicated.

**TEMULENTIVE**, † *a.* Drunken; in a state of inebriation.

**TEN**, *a.* [*Sax. tyn*; *D. tien*; *G. zehn*. We suppose this word to be contracted from the Gothic *tiguns*, *ten*, from *tig*, *ten*. If so, this is the Greek *δέκα*: *L. decem*; *W. deg*; Gaelic, *deich*; *Fr. dix*; *It. dieci*; *Sp. diez*.] 1. Twice five; nine and one.

With twice *ten* sail I cross'd the Phrygian sea.

*Dryden.*

2. It is a kind of proverbial number.

There's a proud modesty in merit,  
Averse to begging, and resolv'd to pay  
*Ten* times the gift it asks. *Dryden.*

The meaning in this use is, a great deal more, indefinitely.

**TENABLE**, *a.* [*Fr.*, from *L. teneo*, to hold. See **TENANT**.] That may be held, maintained, or defended against an assailant, or against attempts to take it; as, a *tenable* fortress. The works were not deemed *tenable*. The ground taken in the argument is not *tenable*.

**TENABLENESS**, } *n.* The state of  
**TENABILITY**, } being tenable.

**TENACETUM**. See **TANACETUM**.

**TENACIOUS**, *a.* [*L. tenax*, from *teneo*, to hold; *Fr. tenace*.] 1. Holding fast, or inclined to hold fast; inclined to retain what is in possession; as, men *tenacious* of their just rights. Men are usually *tenacious* of their opinions, as well as of their property.—2. Retentive; apt to retain long what is committed to it; as, a *tenacious* memory.

—3. Adhesive; apt to adhere to another substance; as oily, glutinous, or viscous matter. Few substances are so *tenacious* as tar.—4. Niggardly; close fisted.—5. In *physics*, tough; having great cohesive force among the particles, so that they resist any effort to pull or force them asunder. Iron and steel are the most *tenacious* of all known substances.

**TENACIOUSLY**, *adv.* With a disposition to hold fast what is possessed.—2. Adhesively; with cohesive force.—3. Obstinate; with firm adherence.

**TENACIOUSNESS**, *n.* The quality of holding fast; unwillingness to quit, resign, or let go; as, a man's *tenaciousness* of his rights or opinions.—2. Adhesiveness; stickiness; as, the *tenaciousness* of clay or glue.—3. Retentive-

ness; as, the *tenaciousness* of memory.—4. In *physics*, the same as *tenacity*, but less used. [See **TENACITY**.]

**TENACITY**, *n.* [*Fr. tenacité*; *L. tenacitas*, from *teneo*, to hold.] 1. Adhesiveness; that quality of bodies which makes them stick or adhere to others; glutinousness; stickiness; as, the *tenacity* of oils, of glue, of tar, of starch, and the like.—2. In *physics*, that property of material bodies by which their parts resist an effort to force or pull them asunder; cohesive force; in common language, toughness. It is opposed to *brittleness*, or *fragility*. *Tenacity* results from the attraction of cohesion which exists between the particles of bodies, and the stronger this attraction is in any body, the greater is the *tenacity* of the body. *Tenacity* is consequently different in different materials, and in the same material it varies with the state of the body in regard to temperature and other circumstances. The *tenacity* of different kinds of wood and metal is ascertained by taking rods of them, fixing these immovably at one end, and finding what weight suspended at the other is sufficient to overcome the cohesive force, and break or pull asunder the rods; the weights being considered as the measures of *tenacity* in the different kinds of materials. Of the different kinds of wood the most *tenacious* is fir; but of all substances, iron and steel are the most *tenacious*, and steel much more so than iron. The *tenacity* of iron is a subject of the greatest importance, as the stability and strength of suspension bridges depend upon it.

**TENACULUM**, *n.* [from *L. teneo*, to hold; to seize.] A surgical instrument for seizing and drawing out the mouths of bleeding arteries in operations, so that they may be secured by ligaments. For this purpose it has a hooked extremity with a fine sharp point.

**TENACITY**, † *n.* *Tenaciousness.*

**TENAIL**, } *n.* [*Fr. tenaille*, from  
**TENAILLE**, } *tenir*; *L. teneo*, to hold.]

In *fort.*, an outwork or rampart raised in the main ditch, immediately in front of the curtain, between two bastions. In its simplest form, it consists of two faces forming with each other a re-entering angle; but generally it consists of three faces forming two re-entering angles, in which case it is called a *double tenaille*. Any work belonging either to permanent or field fortification, which, on the plan, consists of a succession of lines forming salient and re-entering angles alternately, is said to be à *tenaille*. [See **RAVELIN**.]

**TENAILLON**, *n.* In *fort.*, *tenillons* are works constructed on each side of the ravelins, like the lunettes, but differing in this, that one of the faces of the tenailon is in the direction of the ravelin, whereas that of the lunette is perpendicular to it. Works of this kind, however, are seldom adopted.

**TENANCY**, *n.* [*Sp. tenencia*; *Fr. tenant*; *L. tenens*.] In *law*, a holding or possession of lands or tenements from year to year, for a term of years, for a life or lives, or at will; tenure; as, *tenancy* in fee simple; *tenancy* in tail; *tenancy* by the courtesy; *tenancy* at will. *Tenancy* in common happens where there is a unity of possession merely.

**TENANT**, *n.* [*Fr. tenant*, from *tenir*, to

hold; *L. teneo*; *Gr. τίνω*, to strain, stretch, extend; *W. tanu*, to stretch; *tynu*, to pull; *tyn*, a stretch; *ten*, drawn; *It. tenere*; *Sp. tener*, to hold.]

1. A person who holds or possesses lands or tenements by any kind of title, either in fee, for life, for years, or at will. The word in English law is used with several additions. Thus, *tenant in dower*, is she that possesses land by virtue of her dower; *tenant by the courtesy*, he that holds for his life, by reason of a child begotten of him by his wife, being an heirress; *tenant in mortgage*, he that holds by means of a mortgage; *tenant by the verge in ancient demesne*, one who is admitted by the rod in the court of ancient demesne. [See **VERGE**.]—*Tenant by copy of court roll*, one who is admitted tenant of any lands, &c., within a manor;

*tenant in fee simple*, one who has lands or tenements to hold to him and his heirs for ever; *tenant in fee-tail*. [See **TAIL**.]

*Tenant at will*, is where lands or tenements are let by one man to another, to have, and to hold to him at the will of the lessor, by force of which letting the lessee is in possession, but the lessor may put him out at whatever time he pleases; *tenant from year to year*, is where one lets lands or tenements to another without limiting any certain or determinate estate; *tenant by lease*. [See **LEASE**.] *Tenant upon sufferance*, he who enters by lawful letting or title, and afterwards wrongfully continues in possession; *joint-tenants* are such as have equal rights in lands and tenements by virtue of one title; *tenants in common*, those who have equal rights, but held by divers titles. The word *tenant*, in the most ordinary acceptance, signifies one who holds lands or houses under another, to whom he is bound to pay rent, and who is called his landlord. In *Scotland*, the term *tenant* is used only for the lessee or party to whom a lease is granted.—2. One who has possession of any place; a dweller.

The happy *tenant* of your shade. *Cowley.*

*Tenant in capite*, or *tenant in chief*, by the laws of England, is one who holds immediately of the king. According to the feudal system, all lands in England are considered as held immediately or mediately of the king, who is styled lord paramount. Such tenants, however, are considered as having the fee of the lands and permanent possession.

**TENANT**, *v. t.* To hold or possess as a tenant.

Sir Roger's estate is *tenanted* by persons who have served him or his ancestors.

*Addison.*

**TENANT**, *ppr.* [*Fr.*] In *her.*, a French term for *holding*, but met with in English blazon.

**TENANTABLE**, *a.* Fit to be rented; in a state of repair suitable for a tenant.

**TENANTABLENESS**, *n.* State of being tenantable.

**TENANTED**, *a.* In *her.*, tallied or let into another thing; as a cross *tenanted*, having rings let into its extremities.

**TENANTED**, *ppr.* Held by a tenant.

**TENANTING**, *ppr.* Holding as a tenant.

**TENANTLESS**, *a.* Having no tenant; unoccupied; as, a *tenantless* mansion.

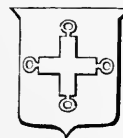

Cross Tenanted.

**TEN'ANTRY**, *n.* The body of tenants; as, the *tenantry* of a manor or a kingdom.—2.† Tenancy.

**TENCH**, *n.* [Fr. *tenche*; Sp. *tenca*; L. *tinca*.] A fish of the carp family, (*Cyprinidae*), the *Cyprinus tinca*, Linn., and *Tinca vulgaris*, Cuvier. It inhabits most of the lakes of the European continent, and in this country it is frequent in ornamental waters and ponds. The

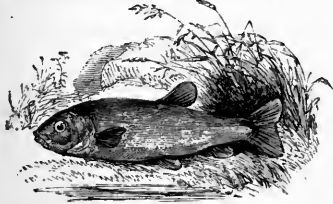

Tench (*Tinca vulgaris*).

tench is remarkable for its tenacity of life; it is readily distinguished from the carp by the small size of its scales, and also the small extent of the dorsal fin. Tenches are in great repute as delicious and wholesome food.

**TEND**, *v. t.* [contracted from *attend*, L. *attendo*; *ad* and *tendo*, to stretch; W. *tannu*. Attention denotes a straining of the mind.] 1. To watch; to guard; to accompany as an assistant or protector.

And flaming ministers to watch and tend Their earthly charge. *Milton*.

There is a pleasure in that simplicity, in beholding princes tending their flocks.

*Pope*.

2. To hold and take care of; as, to tend a child.—3. To be attentive to. Unsuck'd of lamb or kid that tend their play. *Milton*.

4. To tend a vessel, is to cause her to swing at single anchor, so as not to foul the cable round the stock or flukes of the anchor.

**TEND**, *v. i.* [L. *tendo*; Fr. *tendre*; It. *tendere*; formed on L. *teneo*; Gr. *τενω*; Sans. *tan*.] 1. To move in a certain direction.

Having overheard two gentlemen tending toward that sight. *Wolton*.

Here Dardanus was born, and hither tends. *Dryden*.

2. To be directed to any end or purpose; to aim at; to have or give a leaning.

The laws of our religion tend to the universal happiness of mankind. *Tillotson*.

3. To contribute. Our petitions, if granted, might tend to our destruction.

4. [for attend.] To attend; to wait as attendants or servants.

He tends upon my father. *Colloquial*.

*Shak*.

5.† To attend as something inseparable.—6.† To wait; to expect.—7. To swing round an anchor, as a ship.

**TEND'ANCE**, *n.* Attendance; state of expectation.—2. Persons attending.—3. Act of waiting; attendance.—4. Care; act of tending. [This word is entirely obsolete in all its senses. We now use *Attendance*.]

**TEND'ED**, *pp.* Attended; taken care of; nursed; as an infant, or a sick person.

**TEND'ENCY**, *n.* [from *tend*; L. *tendens*, tending.] Drift; direction or course toward any place, object, effect, or result. Read such books only as have a good moral tendency. Mild language has a tendency to allay irritation.

Writings of this kind, if conducted with candour, have a more particular tendency to the good of their country. *Addison*.

II.

**TEND'ER**, *n.* [from *tend*.] One that attends or takes care of; a nurse.—2. In *mar*, a small vessel employed to attend a larger one for supplying her with provisions and other stores, or to convey intelligence and the like.—3. In *railways*, a carriage attached to the locomotive, for carrying the coke, water, &c.—4. [Fr. *tendre*, to reach.] In *law*, an offer, either of money to pay a debt, or of service to be performed, in order to save a penalty or forfeiture, which would be incurred by non-payment or non-performance; as, the tender of rent due, or of the amount of a note or bond with interest. In practice it generally consists in an offer to pay money on behalf of a party indebted, or who has done some injury to the creditor or to the party injured. To constitute a legal tender, such money must be offered as the law prescribes. A tender to the amount of 40s. may be made in silver; but beyond that amount it must be made in gold. If a tender be made of a larger amount in silver or in bank notes, and no objection be taken at the time to the medium in which it is made, the tender will be held good to the full amount to which it is made. There is also a tender of issue in pleadings, a tender of an oath, &c. In an action of damages in *Scots law*, a tender is a judicial offer made by the defender, of a specific sum in name of damages, and of expenses down to the date of the tender.—5. Any offer for acceptance. The gentleman made me a tender of his services.—6. An offer in writing made by one party to another, to execute some specified work, or to supply certain specified articles, at a certain sum or rate.—7. The thing offered. This money is not a legal tender.—8.† Regard; kind concern.

**TEND'ER**, *v. t.* [Fr. *tendre*, to reach or stretch out; L. *tendo*.] 1. To offer in words; or to exhibit or present for acceptance. All conditions, all minds tender down Their service to lord Timon. *Shak*. 2. To hold; to esteem. Tender yourself more dearly.† *Shak*. 3. To offer in payment or satisfaction of a demand, for saving a penalty or forfeiture; as, to tender the amount of rent or debt.

**TENDER**, *a.* [Fr. *tendre*; It. *tenero*; Ir. and Gaelic, *tin*; W. *tyner*; L. *tener*; allied probably to *thin*; L. *tenuis*; W. *tenau*; Ar. *wadana*, to be soft or thin.] 1. Soft; easily impressed, broken, bruised, or injured; not firm or hard; as, tender plants; tender flesh; tender grapes; Deut. xxvii; Cant. ii.—2. Very sensible to impression and pain; easily pained.

Our bodies are not naturally more tender than our faces. *L'Estrange*.

3. Delicate; effeminate; not hardy or able to endure hardship. The tender and delicate woman among you; Deut. xxviii.

4. Weak; feeble; as, tender age; Gen. xxxiii.—5. Young and carefully educated; Prov. iv.—6. Susceptible of the softer passions, as love, compassion; kindness; compassionate; pitiful; easily affected by the distresses of another, or anxious for another's good; as, the tender kindness of the church; a tender heart.—7. Compassionate; easily excited to pity, forgiveness, or favour.

The Lord is pitiful, and of tender mercy; James v; Luke i.

8. Exciting kind concern.

I love Valentine;

His life's as tender to me as his soul. *Shak*.

9. Expressive of the softer passions; as, a tender strain.—10. Careful to save inviolate, or not to injure; with *of*. Be tender of your neighbour's reputation.

The civil authority should be tender of the honour of God and religion. *Tillotson*.

11. Gentle; mild; unwilling to pain.

You that are so tender o'er his follies, Will never do him good. *Shak*.

12. Apt to give pain; as, that is a tender subject; things that are tender and unpleasing.—13. Adapted to excite feeling or sympathy; pathetic; as, tender expressions; tender expostulations.

**TENDERED**, *pp.* Offered for acceptance.

**TENDER-HEARTED**, *a.* [tender and heart.] Having great sensibility; susceptible of impressions or influence.

When Rehoboam was young and tender-hearted, and could not withstand them; 2 Chron. xiii.

2. Very susceptible of the softer passions of love, pity, or kindness.

Be ye kind one to another, and tender-hearted; Eph. iv.

**TENDER-HEARTEDLY**, *adv.* With tender affection.

**TENDER-HEARTEDNESS**, *n.* Susceptibility of the softer passions.

**TENDER-HEFTED**, † *a.* Having great tenderness.

**TENDERING**, *ppr.* Offering for acceptance.

**TENDERLING**, *n.* A fondling; one made tender by too much kindness.—2. The first horns of a deer.

**TENDERLOIN**, *n.* A tender part of flesh in the hind quarter of beef, the psaos muscle.

**TENDERLY**, *adv.* With tenderness; mildly; gently; softly; in a manner not to injure or give pain.

Brutus tenderly reproves. *Pope*.

2. Kindly; with pity or affection.

**TENDER-MINDED**, † *n.* Compassionate.

**TENDER-MOUTHED**, *a.* Having a tender mouth.

**TENDERNESS**, *n.* The state of being tender or easily broken, bruised, or injured; softness; brittleness; as, the tenderness of a thread; the tenderness of flesh.—2. The state of being easily hurt; soreness; as, the tenderness of flesh when bruised or inflamed.—3. Susceptibility of the softer passions; sensibility.

Well we know your tenderness of heart. *Shak*.

4. Kind attention; anxiety for the good of another, or to save him from pain.—

5. Scrupulousness; caution; extreme care or concern not to give or to commit offence; as, tenderness of conscience.—

6. Cautious care to preserve or not to injure; as, a tenderness of reputation.—

7. Softness of expression; pathos.

**TENDERS**, *n. plur.* Proposals for performing a service.

**TENDING**, *ppr.* Having a certain direction; taking care of.

**TENDING**, *n.* The act of attending.

**TENDING**, *n.* In *seamen's language*, a swinging round or movement of a ship upon her anchor.

**TENDINOUS**, *a.* [Fr. *tendineux*; It. *tendinoso*; from L. *tendines*, tendons, from *tendo*, to stretch.] 1. Pertaining to a tendon; partaking of the nature of tendons.—2. Full of tendons; sinewy; as, nervous and tendinous parts.

**TEND'MENT,** † *n.* Attendance; care. **TEND'Ō,** *n.* [L.] A tendon. *Tendo Achilles*, the large tendon, which connects the calf of the leg with the heel. It was so named, because, as fable reports, Thetis the mother of Achilles held him by that part, when she dipped him in the river Styx, to render him invulnerable, and so the only part about him which was vulnerable was his heel.

**TEND'ŌN,** *n.* [L. *tendo*; Gr. *τενω*: from *τενω*: L. *teneo*, to hold.] In anat., a hard, insensible cord or bundle of fibres, by which a muscle is attached to a bone or other part which it serves to move. The name *tendons*, however, is generally applied only to those which are thick and rounded, and which serve for the attachment of the long round muscles; those which are broad and flat being commonly called *aponeuroses*. Tendons are white and shining tissues, composed of bundles of delicate fibres, united by cellular tissue.

**TEN'DRAC,** } *n.* The popular name  
**TEN'REC,** } of three insectivorous  
**TAN'REC,** } mammals, of the genus  
Centetes Illiger, viz., *C. caudatus*, *C.*



Tenrec (*Centetes caudatus*).

*setosus*, and *C. semispinosus*. The tenrecs are considered as hedgehogs, without the power of rolling themselves up into a ball; the body is spiny, the muzzle elongated, there are five toes on each foot, separated and armed with crooked claws. The three species are found in Madagascar, and the first, which is the Tenrec, properly so called, and the largest, is naturalized in the Isle of France.

**TEN'DRIL,** *n.* [Fr. *tendron*, from *tenir*, to hold.] A filiform spiral shoot of a plant that winds round another body for the purpose of support. *Tendrils* or *cirri*, are only found on those plants which are too weak in the stem to enable them to grow erect; they twist themselves in a spiral form around other plants or neighbouring bodies, and thus the plants on which they grow are enabled to elevate themselves. In most cases, tendrils are prolongations of the petioles; but in some cases they are altered stipules, as in the cucumber, and in other cases they are transformed branches or flower-stalks; as in the vine.

**TEN'DRIL,** *a.* Clasping; climbing; as a tendril.

**TEN'DRY,** *n.* Proposal to acceptance; a tender. [*Rarely used.*]

**TEND'SOME,** *a.* Requiring much attendance; as, a *tendsome* child. [*Obs. or fam.*]

**TENEBR'IFIC,** *a.* [L. *tenebræ*, darkness, *fero*, to bring or produce.] Producing darkness; as, a whimsical philosopher once asserted that night succeeded to day through the influence of tenebrific stars.

**TENEBRIONIDÆ,** *n.* A family of coleopterous insects, belonging to the

section Heteromera, distinguished by having the body furnished with wings. The species of the typical genus *Tenebrio* are very numerous; they frequent dark and obscure situations, as the lower rooms of houses, cellars, &c. Hence the name from L. *tenebræ*, darkness. The larvæ of *T. molitor*, or meal worms, form the favourite food of the nightingale in its captive state. They are very destructive to biscuits and other cereal food kept in store.

**TENE'BROUS,** } *a.* [L. *tenebrosus*,  
**TENE'BRIOUS,** } from *tenebræ*, dark-  
ness.] Dark; gloomy.

**TENE'BROUSNESS,** } *n.* Darkness;  
**TENE'BROS'ITY,** } gloom.

**TENEMENT,** *n.* [Fr.; Low L. *tenementum*, from *teneo*, to hold.] 1. In common acceptation, a house; a building for a habitation; or an apartment in a building, used by one family.—2. A house or lands depending on a manor; or a fee farm depending on a superior.—3. In law, any species of permanent property that may be held, as land, houses, rents, commons, an office, an advowson, a franchise, a right of common, a peerage, &c. These are called free or frank tenements.

The thing held is a *tenement*, and the possessor of it a *tenant*, and the manner of possession is called *tenure*. *Blackstone.*

**TENEMENT'AL,** *a.* Pertaining to tenanted lands; that is or may be held by tenants.

*Tenemental* lands they distributed among their tenants. *Blackstone.*

**TENEMENT'ARY,** *a.* That is or may be leased; held by tenants.

**TENEN'DAS,** *n.* [L. from *teneo*, to hold.] In *Scots law*, that clause of a charter by which the particular tenure is expressed.

**TENER'ITY,** † *n.* Tenderness.

**TENES'MUS,** *n.* [L.; literally, a straining or stretching.] A continual inclination to void the contents of the bowels, accompanied by straining, but without any discharge. It is caused by an irritation of the muscles of the *sphincter ani*, produced generally by acrimonious substances.

**TENET,** *n.* [L. *tenet*, he holds.] Any opinion, principle, dogma, or doctrine which a person believes or maintains as true; as, the *tenets* of Plato or of Cicero. The *tenets* of Christians are adopted from the Scriptures; but different interpretations give rise to a great diversity of *tenets*.

**TEN'FOLD,** *a.* [*ten* and *fold*.] Ten times more.

Fire kindled into *tenfold* rage. *Milton.*

**TENIOIDS.** See *TÆNIOIDS*.

**TEN'NANTITE,** *n.* [from *Tennant*.] A subspecies of gray copper ore, a mineral of a lead colour, or iron black, massive or crystallized, found in Cornwall, England. It is an arsenical sulphuret of copper and iron, and so named in honour of Smithson Tennant, a celebrated chemist.

**TENNE', n.** [Sp. *tanetto*.] A colour in heraldry, the same as tawney, and by some heralds called *brusk*. It is composed of red, yellow, and brown, which, mixed together, make a kind of chestnut colour. It is seldom used in coat armour, and never as a field. In engraving, it is expressed by diagonal lines, drawn from the sinister chief point, and traversed by horizontal ones.

**TEN'NIS,** *n.* [If this word is from L. *teneo*, Fr. *tenir*, it must be from the

sense of holding on, continuing to keep in motion.] A play in which a ball is driven continually or kept in motion to and fro, by several persons striking it alternately with a small bat, called a racket, the object being to keep the ball in motion as long as possible without allowing it to fall to the ground. This game was introduced into England in the thirteenth century; it was very popular with the nobility in the sixteenth century, and continued to be so down to the reign of Charles II.

**TEN'NIS,** *v. t.* To drive a ball.

**TEN'NIS BALL,** *n.* The ball used in the game of tennis.

**TEN'NIS COURT,** *n.* An oblong edifice in which the game of tennis was played.

**TEN'NISED,** *pp.* Driven as a ball.

**TEN'NISING,** *ppr.* Driving as a ball.

**TEN'ON,** *n.* [Fr. from *tenir*, L. *teneo*, to hold.] In arch., the end of a piece of wood cut into the form of a rectangular prism, which is received into a cavity in another piece, having the same shape and size, called a *mortise*. This is a mode of joining or fastening two pieces of timber together. [*See* *MORTISE*.]

**TEN'ON-SAW,** *n.* A small saw, with a brass or steel back, used for cutting *tenons*. It is often corrupted into *tenor-saw*.

**TEN'OR,** *n.* [L. *tenor*, from *teneo*, to hold; that is, a holding on in a continued course; Fr. *teneur*; It. *tenore*; Sp. *tenor*.] 1. Continued run or currency; whole course or strain. We understand a speaker's intention or views from the *tenor* of his conversation; that is, from the general course of his ideas, or general purport of his speech.

Does not the whole *tenor* of the divine law positively require humility and meekness to all men? *Sprat.*

2. Stamp; character. The conversation was of the same *tenor* as that of the preceding day.

This success would look like chance, if it were not perpetual and always of the same *tenor*. *Dryden.*

3. Sense contained; purport; substance; general course or drift; as, close attention to the *tenor* of the discourse. Warrants are to be executed according to their form and *tenor*.

Bid me tear the bond,

When it is paid according to the *tenor*.

*Shak.*

4. [Fr. *tenor*.] In music, the natural pitch of a man's voice in singing, or that which is between the extremes of highest and lowest, or *contra-tenor* and base; hence, the part of a tune adapted to a man's voice, the second of the four parts, reckoning from the base; and originally the air, to which the other parts were auxiliary. The compass of the *tenor* is from C, the second space in the bass, to G, the second line in the treble. Hence, the *tenor* and *treble* are reciprocally at the distance of an octave.—5. The persons who sing the *tenor*, or the instrument that plays it, which latter is a larger sort of violin. *Tenor-clef*, the C clef, placed on the fourth line, for the use of the *tenor-voice*: Thus, 

**TENOT'OMY,** *n.* [Gr. *τενω* a tendon; and *τομη*, a cutting.] In *surgery*, the division, or act of dividing a tendon.

**TENREC.** See *TENDRAC*.

**TENSE,** *a.* (teus.) [L. *tensus*, from *tendo*, to stretch.] Stretched; strained to

stiffness; rigid; not lax; as, a *tense* fibre.

For the free passage of the sound into the ear, it is requisite that the tympanum be *tense*.

*Holder.*

**TENSE**, *n.* (tens.) [corrupted from Fr. *temps*, *L. tempus*.] In *gram.*, time, or a particular form of a verb, or a combination of words, used to express the time of action, or of that which is affirmed; or tense is an inflection of verbs, by which they are made to signify or distinguish the time of actions or events. The primary simple tenses are three; those which express time *past*, *present*, and *future*; but these admit of modifications, which differ in different languages. In the English language, six tenses are recognized; viz., the *present*, the *past* or *imperfect*, the *perfect*, the *pluperfect*, the *future*, and the *future perfect*.

**TENSELY**, *adv.* With tension.

**TENSENESS**, *n.* (tens'ness.) The state of being tense or stretched to stiffness; stiffness; opposed to *laxness*; as, the *tenseness* of a string or fibre; *tenseness* of the skin.

**TENSIBILITY**, *n.* The state that admits tension.

**TENSIBLE**, *a.* Capable of being extended.

**TENSIBLE**, *a.* Capable of extension.

**TENSILITY**, *n.* The quality of being tensile.

**TENSION**, *n.* [Fr. from *L. tensio*, *tendo*.] 1. The act of stretching or straining; as, the *tension* of the muscles.

—2. The state of being stretched or strained to stiffness; as a chord, string, bar, rod, &c.; or the state of being bent or strained; as, different degrees of *tension* in chords give different sounds; the greater the *tension*, the more acute the sound.—3. In *mech.*, strain, or the force by which a bar, rod, or string is pulled, when forming part of any system in equilibrium or in motion. Thus, when a cord supports a weight, the tension of the string is the weight suspended to it.—4. Distension.

**TENSIVE**, *a.* Giving the sensation of tension, stiffness, or contraction; as, a *tensive* pain.

**TENSOME**. See **TENSOME**.

**TENSOR**, *n.* In *anat.*, a muscle that extends or stretches the part to which it is fixed; as, the *tensor palati*, the *tensor tympani*, &c.

**TENSURE**, the same as *Tension*, and not used.

**TENT**, *n.* [W. *tent*, from *ten*, *tyt*, stretched; Fr. *tente*; Sp. *tienda*; *L. tentorium*, from *tendo*, to stretch.]

1. A pavilion or portable lodge consisting of canvas or other coarse cloth, stretched and sustained by poles; used for sheltering persons from the weather, particularly soldiers in camp. The wandering Arabs and Tartars lodge in *tents*. The Israelites lodged in *tents* forty years, while they were in the desert. The military tent is made of canvas, which is supported by one pole or more, and distended by means of cords, which are made fast to pickets driven into the ground. Tents are set up when an army is encamped in the field, either for actual service, or for the purpose of performing military exercises.—2. In *sur.*, a roll of lint or linen, used to dilate an opening in the flesh, or to prevent the healing of an opening from which matter or other fluid is discharged. A piece of sponge,

dipped in hot melted wax, so as to be thoroughly imbued with it, is called a *sponge-tent*.—3. A term among lapidaries for what they put under table-diamonds when they set them.

**TENT**, *n.* [Sp. *tinto*, deep coloured, from *L. tinctus*.] A kind of wine of a deep red colour, chiefly from Galicia or Malaga in Spain.

**TENT**, *v. i.* To lodge as in a tent; to tabernacle.

**TENT**, *v. t.* To probe; to search as with a tent; as, to *tent* a wound.

I'll *tent* him to the quick.

*Shak.*

2. To keep open with a tent.

**TENT**, *n.* [from *L. attendere*.] Care; notice; attention.—2. A kind of pulp of wood, erected in the open fields, in which clergymen used to preach to multitudes who had assembled from different places to attend the dispensation of the Lord's supper, and who could not be accommodated within doors. This practice is still retained in some parts of Scotland. [*Scotch*.]

**TENT**, *v. i.* To attend; to observe attentively; generally followed by *to*. [*Scotch*.]

**TENT**, *v. t.* To observe; to remark; to regard. [*Scotch*.]

**TENTACLE**, } *n. plur. Tentacula.*

**TENTACULUM**, } [Tech. *L. tentaculum*.] A feeler; a filiform process or organ, simple or branched, on the bodies of various animals of the Linnean class Vermes, and of Cuvier's Mollusca, Annelides, Echinodermata, Actinia, Medusae, Polypti, &c., either an organ of feeling, exploration, prehension, or motion, sometimes round the mouth, sometimes on other parts of the body.

**TENTACULAR**, *a.* Pertaining to tentacles.

**TENTACULATED**, *a.* Having tentacles.

**TENTACULIFEROUS**, *a.* [*L. tentaculum* and *fero*, to bear.] Producing tentacula or tentacles.

**TENTACULITES**, *n.* A beautiful group of small annulated, pointed shells, fossil in the silurian strata. They have been referred to the Annullosa.

**TENTAGE**, *n.* An encampment. [*Unusual*.]

**TENTATION**, *n.* [Fr. from *L. tentatio*; *tento*, to try.] Trial; temptation. [*Little used*.]

**TENTATIVE**, *a.* [Fr.] Trying; essaying.

**TENTATIVE**, *n.* An essay; trial.

**TENT-BED**, *n.* A high post bedstead, having curtains in a tent form above.

**TENTED**, *a.* Covered or furnished with tents; as soldiers.—2. Covered with tents; as, a *tented* field.

**TENTER**, *n.* [*L. tendo*, *tentus*, to stretch.] A machine or frame used in the cloth manufacture, to stretch out the pieces of cloth, stuff, &c., and make them even and square. It consists of several long pieces of wood, placed like those which form the barriers of a menage, but the lower piece admits of being raised or lowered, and fixed at any height required. Along the cross-pieces, both the upper and lower one, are numerous sharp-hooked nails, called *tenter-hooks*, on which the salvages of the cloth are hooked.—2. The individual who attends the machine of the same name.—3. A *tenter-hook*.—*To be on the tenters*, to be on the stretch; to be in distress, uneasiness, or suspense.

**TENTER**, *v. t.* To hang or stretch on tenters.

**TENTER**, *v. i.* To admit extension.

Woolen cloths will *tenter*. [*Becon.*]

**TENTERED**, *ppr.* Stretched or hung on tenters.

**TENTER-GROUND**, *n.* Ground on which tenters are erected.

**TENTER-HOOK**, *n.* A hook for stretching cloth on a frame. [*See TENTER*.]

**TENTERING**, *ppr.* Stretching or hanging on tenters.

**TENTH**, *a.* [from *ten*.] The ordinal of ten: the first after the ninth.

**TENTH**, *n.* The tenth part.—2. Tithe; the tenth part of annual produce or increase. [*See TITHRE*.] Tenths are the yearly value of all ecclesiastical livings in England, which were anciently paid to the pope. At the Reformation, the revenue arising from tenths was transferred to the crown; but afterwards various benefices were exempted from the payment of tenths.—3. In *music*, the octave of the third; an interval comprehending nine conjoint degrees, or ten sounds, diatonically divided.

**TENTHLY**, *adv.* In the tenth place.

**TENTHREDO**, *n.* A genus of hymenopterous insects, popularly known by the name of *saw-fly*, because the female uses her ovipositor, which is serrated like a saw, to cut out spaces in the bark of trees, for the purpose of depositing her eggs, as the *T. rosea*,

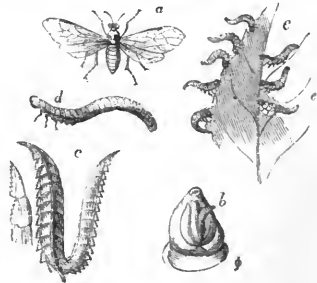

Tenthredo, Saw-fly.

upon the leaves of the rose bush. The *Tenthredo*, Linn., is regarded in modern systems as constituting a family named *Securifera* by Latreille, and *Tenthredinide* by Leach. Several species are found in this country. In the larva state they feed upon the leaves of plants and trees. In the accompanying figure, *a* is the saw-fly of the turnip, *Athalia spinarum*; *b*, ovipositor of saw-fly magnified; *c*, the same still more magnified to show the saw; *d*, the caterpillar of the saw-fly of the rose, *Tenthredo rosea*; *e, e*, caterpillars of the saw-fly of the willow, *Nematus caprea*.

**TENTIE**, *a.* Attentive; cautious; careful. [*Scotch*.]

**TENTIGINOUS**, } *a.* [*L. tentigo*, a stretching.] Stiff; stretched.

**TENTING**, *ppr.* Probing; keeping open with a tent.

**TENTLESS**, *a.* Inattentive; heedless. [*Scotch*.]

**TENTORIUM**, *n.* [*L.*] In *anat.*, a process of the *dura mater*, which separates the cerebrum from the cerebellum.

**TENTORY**, *n.* [*L. tentorium*.] The awning of a tent.

**TENTWORT**, *n.* [*tent* and *wort*.] A

plant of the genus *Asplenium*, the *A. ruta-muraria*. It is also called wall-rue. **TENUATE**, *v. t.* [*L. tenuo.*] To make thin.

**TENUATED**, *pp.* Made thin.

**TENUATING**, *pp.* Making thin.

**TENUIFOLIUS**, *a.* [*L. tenuis* and *folium.*] Having thin or narrow leaves.

**TENUIOUS**, *a.* Rare or subtle; opposed to *dense*.

**TENUIROSTRAL**, *a.* Slender-beaked; pertaining to the family of birds called Tenuirostres.

**TENUIROSTRES**, *n.* [*L. tenuis*, slender, and *rostrum*, a beak.] The fourth family of passerine birds in the arrangement of Cuvier. It comprehends those birds which have the beak slender,

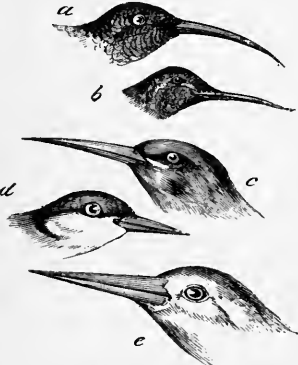

Heads of Tenuirostres.

*a*, Sun bird (*Nectarinea afra*); *b*, Humming bird (*Trochilus recurvirostris*); *c*, Fork-tailed blue-vented Bee-Eater (*Merops caeruleo-cephalus*); *d*, European Nuthatch (*Sitta Europaea*); *e*, Rufous-vented King-fisher (*Alcedo rufigentus*).

elongated, sometimes straight, and sometimes more or less arcuated, and without any emargination; as the nuthatches, creepers, humming-birds, bee-eaters, king-fishers, hornbills, &c. **TENUITY**, *n.* [*Fr. tenuité*; *L. tenuitas*, from *tenuis*, thin. See **THIN**.] 1. Thinness; smallness in diameter; exility; thinness, applied to a broad substance, and slenderness, applied to one that is long; as, the *tenuity* of paper or of a leaf, the *tenuity* of a hair or filament. —2. Rarity; rareness; thinness; as of a fluid; as, the *tenuity* of the air in the higher regions of the atmosphere; the *tenuity* of the blood.—3. Poverty.

**TENUOUS**, *a.* [*L. tenuis*.] 1. Thin; small; minute.—2. Rare.

**TENURE**, *n.* [*Fr.* from *tenir*, *L. teneo*, to hold.] 1. A holding. In *English law*, the manner of holding lands and tenements of a superior, or the feudal relation which subsists between lord and vassal in respect of lands and tenements. All land is held of the king, either mediately or immediately; and ultimately all land is held of the king. The ownership of land is therefore never unlimited as to extent, for he who is the owner of land in fee, which is the largest estate that a man can have in land, is not absolute owner: he owes services in respect of his fee (or fief), and the lordship of the land always subsists. All land in the hands of any layman is held of some lord, to whom the holder or tenant owes some service; but in the case of church lands, although they are held by tenure, no temporal services are due, but the lord of whom these lands are held must be considered the owner, although the

beneficial ownership can never revert to the lord. All the species of ancient tenures may be reduced to four, three of which subsist to this day. 1. Tenure by knight service, which was the most honourable. This is now abolished. 2. Tenure in free socage, or by a certain and determinate service, which is either free and honourable, or villain and base. 3. Tenure by copy of court roll, or copyhold tenure. 4. Tenure in ancient demain. There was also tenure in frankalmoine, or free arms. The tenure in free and common socage has absorbed most of the others. [See **TENANT**, **COPYHOLD**, **SOCAGE**, **VILLEINAGE**.]—In *Scots law*. [See **HOLDING**.] —2. The consideration, condition, or service which the occupier of land gives to his lord or superior for the use of his land.—3. Manner of holding in general. In absolute governments, men hold their rights by a precarious tenure.

**TEOCALTE**, *n.* [Literally, God's house.] A pyramid for the worship of the gods, among the Mexicans and other aborigines of America.

**TEPEFACTIO**, *n.* [*L. tepefacio*; **TEPIFACTIO**, } *tepidus*, warm, and *factio*, to make.] The act or operation of warming, making tepid, or moderately warm.

**TEPEFIED**, *pp.* Made moderately tepid, } warm.

**TEPEFY**, *v. t.* [*L. tepefacio.*] To tepidify, } make moderately warm.

**TEPEFY**, *v. i.* To become moderately tepidify, } warm.

**TEPHRAMANCY**, *n.* [*Gr. τεφρα*, ashes, and *μαντια*, divination.] Augury depending on the inspection of the ashes of a holocaust.

**TEPHRODORNIS**, *n.* Swainson's name for a genus of Drongo-shrikes, inhabiting the warm latitudes of the Old World.

**TEPHROSIA**, *n.* A genus of plants, nat. order Leguminosae, papilionaceous division. It consists of shrubs, undershrubs, or herbs scattered over every quarter of the globe. *T. toxicaria* is

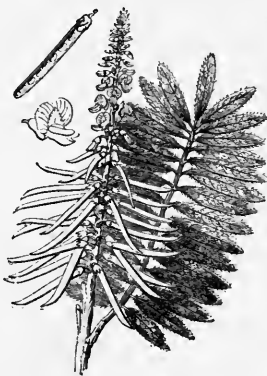

*Tephrosia toxicaria.*

a native of the West Indies, and of Cayenne. The whole plant affords a narcotic poison, and the leaves are used for intoxicating fish. *T. virginiana* is considered in America a powerful vermifuge. *T. emarginata* is a native of South America. Its root is used for poisoning fish. *T. tinctoria*, the Ceylon indigo, yields a blue colouring

matter, which is used in Ceylon for the same purposes as indigo. *T. piscatoria*, the fisher's Tephrosia, is found in the East Indies. It contains the narcotic principle of the genus, and is used for poisoning fish. *T. senna*, Buga senna, grows on the banks of the river Cauca, near Buga, in Popayan. Its leaves are used by the natives for the same purposes as senna.

**TEPID**, *a.* [*L. tepidus*, from *tepeo*, to be warm; *Russ. toplyu.*] Moderately warm; lukewarm; as, a *tepid* bath; *tepid* rays; *tepid* vapours.—*Tepid mineral waters* are such as have less sensible cold than common water.

**TEPIDARIUM**, *n.* [*L.*] In the ancient Roman baths; the name given to the apartment in which the tepid bath was placed. Also, the boiler in which the water was warmed for the tepid bath.

**TEPIDNESS**, *n.* Moderate warmth; **TEPIDITY**, } lukewarmness.

**TEPOR**, *n.* [*L.*] Gentle heat; moderate warmth.

**TERAPI**, *n.* [*Heb.*] A household deity or image. [See **TERAPHIM**.]

**TERAPHIM**, *n.* [*Heb.*, supposed to be derived from *Terah*, the father of Abraham.] Household deities or images. The teraphim seem to have been either wholly or in part of human form and of small size. They appear to have been superstitiously revered as *penates* or household gods, and in some shape or other to have been used as domestic oracles. They are mentioned several times in the Old Testament Scriptures.

**TERATOLÓGY**, *n.* [*Gr. τερας*, a prodigy, and *λογος*, discourse.] Bombast in language; affectation of sublimity. —2. A branch of physiology, which treats of the various malformations and monstrosities in the animal kingdom.

**TERCE**, *n.* (ters.) [*Sp. tertia*; *Fr. tiers tierce*, a third.] A cask whose contents are 42 gallons, the third of a pipe or butt. [See **TIERCE**.]

**TERCE**, *n.* In *Scots law*, a real right whereby a widow, who has not accepted any special provision, is entitled to a life-rent of one-third of the heritage in which her husband died infert, provided the marriage has endured for a year and a day, and has produced a living child. No widow is entitled to her terce until she is regularly *henned* to it. [See under **KEN**.]

**TERCEL**, *n.* [*Fr. tiers*, third; so named from his smallness.] The male of the common falcon, *Falco peregrinus*. [See **TIERCEL**.]

The name *tercel* is given, also, to the male of every species of falcon or hawk, when he has no other individual designation.

*Booth.*

**TERCE-MAJOR**, *n.* A sequence of the three best cards.

**TERCENTENARY**, *a.* Comprising three hundred years.

**TERCET**, *n.* In *music*, a third.

**TERCINE**, *n.* [*L. tertius*.] In *bot.*, the innermost coat of the ovule of a plant.

**TERBEL'UM**, *n.* [*L. terebro*, to bore.] A genus of testaceous molluscs, placed by Cuvier among his Pectinibranchiate gastropods. All the species are fossil but one, the *T. subulatum*.

**TEREBINTH**, *n.* [*Fr. terebinthe*; *Gr. τεργινθος*.] The turpentine tree, *Pistacia terebinthus*. [See **PISTACIA**.] —2. The common name for various resinous exudations, both of a fluid and solid nature, such as common turpen-

tine, produced from *Pinus sylvestris*; frankincense and Burgundy pitch from *Pinus abies*; Canada balsam from *Abies balsamica*. The volatile oil of various of these resins is called oil of terebinth, or oil of turpentine.

**TEREBIN'THINATE**, *a.* Terebinthine; impregnated with the qualities of turpentine.

**TEREBIN'THINE**, *a.* [*L. terebinthinus*, from *terebinthina*, turpentine.] Pertaining to turpentine; consisting of turpentine, or partaking of its qualities.

**TEREBRA**, *n.* [*L. terebro*, to bore.] A genus of tarreted, subulated marine univalves. Several species are fossil.

**TEREBRA'LIA**, *n.* Swainson's name for a genus of testaceous gastropods, arranged by him under the *Certhinae*.

**TEREBRAN'TIA**, *n.* [*L. terebro*, to bore.] A section of hymenopterous insects, provided with an anal instrument for making perforations in the bodies of animals, or in plants.

**TEREBRATE**, *v. t.* [*L. terebro, tero.*] To bore; to perforate with a gimlet. [*Little used.*]

**TEREBRATING**, *a.* Boring; perforating; applied to those testaceous animals which form holes in rocks, wood, &c., and reside therein.

**TEREBRA'TION**, *n.* The act of boring. [*Little used.*]

**TEREBRAT'ULA**, *n.* A genus of acéphalous bivalve molluscs, found moored to rocks, shells, &c. One of the valves is perforated to permit the passage of a fleshy peduncle, by means of which the animal attaches itself to rocks, shells, &c. There are few recent species, but the fossil ones are numerous, and are found most abundantly in the secondary and tertiary formations.

**TEREBRAT'ULITE**, *n.* Fossil terebratula, a kind of shell.

**TEREDINA**, *n.* A genus of testaceous molluscs, belonging to the family Tubicolæ of Lamarck. The genus is fossil only.

**TEREDINE**, *n.* A borer; the teredo. **TEREDO**, *n.* [*L.* from *Gr. τρέω*, to pierce, to bore.] A genus of acéphalous testaceous molluscs, belonging to the family Tubicolæ of Lamarck. The *T. navalis*, or ship-worm, is celebrated

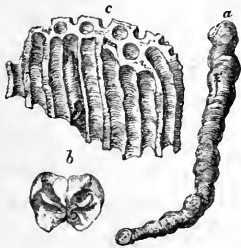

*a.* *Teredo navalis*; *b.* Valves; *c.* Wood perforated by the *Teredo*.

on account of the destruction which it occasions to ships and submerged wood, by perforating them in all directions in order to establish a habitation. It is said to have been originally imported from tropical climates, but it has now become an inhabitant of most of the harbours of this country.

**TERENITE**, *n.* A kind of solid argillaceous schist, parting into thick exfoliations.

**TERES**, *a.* [*L.*] Round; cylindrical. Applied in anatomy to some muscles and ligaments on account of their shape; as, *teres major*; *ligamentum teres*, &c.

**TERETE**, *a.* [*L. teres.*] Cylindrical and tapering; columnar; as some stems of plants.

**TER'GANT**, } *ppr.* [from *L. tergum*,  
**TER'GIANT**, } the back.] In *her.*, showing the back part; as, an eagle *tergiant*, displayed, an eagle displayed, showing the back; called also recurrent.

**TERGEM'INAL**, } *a.* [*L. tergeminus.*]  
**TERGEM'INATE**, } Thrice double. Applied to a leaf having a forked petiole which is subdivided.

**TERGEM'INOUS**, *a.* [*supra.*] Threefold.

**TERGIF'EROUS**, *a.* [*L. tergum*, the back, and *fero*, to bear.] *Tergiferous plants* are such as bear their seeds on the back of their leaves, as ferns.

**TER'GIVERSATE**, *v. i.* [*L. tergum*, the back, and *verso*, to turn.] To shift; to practise evasion. [*Little used.*]

**TER'GIVERSA'TION**, *n.* A shifting; shift; subterfuge; evasion.

Writing is to be preferred before verbal conferences, as being more free from passion and tergiversation. *Bramhall*. 2. Change; fickleness of conduct.

The colonel, after all his tergiversation, lost his life in the king's service.

*Clarendon.*

**TER'GIVERSATOR**, *n.* One who practises tergiversation.

**TER'GUM**, *n.* [*L.*, the back.] In *entom.*, the upper surface of the abdomen.

**TERM**, *n.* [*Gr. τέρμα*; *Fr. terme*; *It. termine*; *Sp. termino*; *L. terminus*, a limit or boundary; *W. terv, tervyn*, from *terv*, extreme.] 1. A limit; a bound or boundary; the extremity of any thing; that which limits its extent.

Corruption is a reciprocal to generation, and they two are as nature's two terms or boundaries. *Bacon*.

2. The time for which any thing lasts; any limited time; as, the *term* of five years; the *term* of life.—3. In *geom.*, a point, line, or superficies that limits. A line is the *term* of a superficies, and a superficies is the *term* of a solid.—4. In *law*, the limitation of an estate; or rather the whole time or duration of an estate; as, a lease for the *term* of life, for the *term* of three lives, &c. A *term* of years signifies the estate and interest which pass to the person to whom an estate for years is granted by the owner of the fee.—5. The *law terms* are those portions of the year during which the superior courts of common law and equity sit for the despatch of business. They are four in number, viz., Hilary term, which begins on the 11th, and ends on the 31st January; Easter term, which begins on the 15th April, and ends on the 8th May; Trinity term, which begins on the 22d May, and ends on the 12th June; Michaelmas term, which begins on the 2d, and ends on the 25th November. The other portions of the year are termed *vacation*. In all cases the Monday is substituted for the Sunday, when the first day of term falls on the latter day. The courts of common law are empowered, upon giving notice, to hold sittings out of term. In *England*, there are also four days in the year which are called terms, and which are appointed for the settling of rents, viz., Lady Day, March

25; Midsummer, June 24; Michaelmas Day, September 29; Christmas, December 25. The terms in Scotland corresponding to these are Candlemas, February 2; Whitsunday, May 15; Lammas, August 1; Martinmas, November 11. The legal terms in Scotland for the payment of rent, or interest, are Whitsunday, 15th May, and Martinmas, November 11th.—*Conventional terms* are any terms agreed upon between the contracting parties. In *judicial procedure*, in *Scots law*, the word term signifies a certain time fixed by authority of a court, within which a party is allowed to establish by evidence his averment.—6. In *universities* and *colleges*, the time during which instruction is regularly given to students, who are obliged by the statutes and laws of the institution to attend to the recitations, lectures, and other exercises.—7. In *gram.*, a word or expression; that which fixes or determines ideas.

In painting, the greatest beauties cannot be always expressed for want of terms. *Dryden*.

8. In *the arts*, a word or expression that denotes something peculiar to an art; as, a technical term.—9. In *logic*, the expression in language of the notion obtained in an act of apprehension. A term may consist of one word, or of several, but every word is not capable of being employed by itself as a term. Terms are divided into *simple, singular, universal, common, univocal, equivocal, analogous, abstract, concrete*, &c. A syllogism consists of three terms, the major, the minor, and the middle. The predicate of the conclusion is called the major term, because it is the most general, and the subject of the conclusion is called the minor term, because it is less general. These are called the extremes; and the third term, introduced as a common measure between them, is called the mean or middle term. Thus, in the following syllogism: Every vegetable is combustible; every tree is a vegetable; therefore every tree is combustible. *Combustible* is the predicate of the conclusion, or the major term; every tree is the minor term; *vegetable* is the middle term.—10. In *arch.*, a kind of statues or columns adorned on the top with the figure of a head, either of a man, woman, or satyr. Terms are sometimes used as consoles, and sustain entablatures; and sometimes as statues to adorn gardens. [*See TERMINUS.*]

11. Among *the ancients*, terms, *termini miliares*, were the heads of certain divinities placed on square land-marks of stone, to mark the several stadia on roads. These were dedicated to Mercury, who was supposed to preside over highways.—12. In *alge.*, a member of a compound quantity; as, *a*, in  $a + b$ ; or *ab*, in  $ab + cd$ . Hence, the terms of any compound quantity are the several members of which it is composed, separated from one another by the signs  $+$ , plus, or  $-$ , minus. Thus,  $a^2 b^3 x^2 - 2 a b x^3 + \sqrt{ab} x^4$ , is a compound quantity, consisting of three terms. Terms of an equation, the several parts of which it is composed, connected by the signs of addition and subtraction. Thus,  $x^3 - 6x^2 + 11x - 6 = 0$ , is an equation consisting of four terms.—13. Among *physicians*, the monthly uterine secretion of females is called *terms*.—14. In *contracts*, terms, in the plural, are condi-

tions; propositions stated or promises made, which, when assented to or accepted by another, settle the contract and bind the parties. A. engages to build a house for B. for a specific sum of money, in a given time; these are his *terms*. When B. promises to give to A. that sum for building the house, he has agreed to the *terms*; the contract is completed and binding upon both parties.—15. In *ship-building*, a piece of carved wood, placed under each end of the taffrail.—*Terms of proportion*, in *math.*, are such numbers, letters, or quantities as are compared one with another.—*To make terms*, to come to an agreement.—*To come to terms*, to agree; to come to an agreement.—*To bring to terms*, to reduce to submission or to conditions.

TERM, v. t. To name; to call; to denominate.

Men *term* what is beyond the limits of the universe, imaginary space. *Locke.*

TERMAGANCY, n. [from *termagant*.] Turbulence; tumultuousness; as, a violent *termagancy* of temper.

TERMAGANT, a. [In Sax. *tir* or *tyr* is a deity, Mars or Mercury, and a prince or lord. As a prefix, it augments the sense of words, and is equivalent to *chief* or *very great*. The Sax. *magan*, Eng. *may*, is a verb denoting to be able, to prevail; from the sense of straining, striving, or driving. Qu. the root of *stir*.] Tumultuous; turbulent; boisterous or furious; quarrelsome; scolding.

The eldest was a *termagant*, imperious, prodigal, profligate wench. *Arbutnot.*

TERMAGANT, n. A boisterous, brawling, turbulent woman; a shrew; a virago. It seems in Shakespeare to have been used of men. In ancient farces and puppet-shows, *termagant* was a vociferous, tumultuous deity. She threw his periwig into the fire. Well, said he, thou art a brave *termagant*.

*Taller.*

The sprites of fiery *termagants* in flame. *Pope.*

TERMED, pp. Called; denominated.

TERMER, n. One who travels to attend a court term.

TERMER, } n. One who has an estate  
TERMER, } for a term of years or life.

TERMES. See TERMITES.

TERM-FEE, n. Among lawyers, a fee or certain sum charged to a suitor for each term his cause is in court.

TERMINABLE, a. [from *term*.] That may be bounded; limitable.

TERMINABLENESS, n. The state of being terminable.

TERMINAL, a. [from L. *terminus*.]

In *bot.*, growing at the end of a branch or stem; terminating; as, a *terminal* peduncle, flower, or spike.—*Terminal stigma*, a stigma placed at the end of the style.—2. Forming the extremity; as, a *terminal* edge.—3. In *arch.* and *sculp.*, of or belonging to a *terminus*,—*which see*.—*Terminal velocity*, in the theory of projectiles, the greatest velocity which a ball can acquire by descending vertically in air, and with which, when attained, it would continue to descend uniformly, if no obstacle delayed the motion.—*Terminal value*, and *terminal form*, in *math.*, the last and most complete value or form given to an expression.

TERMINALIA, n. plur. Among the Romans, festivals celebrated annually in honour of *Terminus*, the god of

boundaries. They took place on the 23d of February.—2. A genus of plants, nat. order Combrataeae. The species consist of trees and shrubs, with alternate leaves, inhabiting the tropical parts of Asia and America. *T. angustifolia*, a native of the East Indies, yields a gum-resin similar to benzoin. *T. vernix*, a native of the Moluccas, abounds in a resinous juice used as a varnish. The bark and leaves of *T. catappa*, a West Indian species, yield



Terminalia catappa.

a black pigment. Indian ink is manufactured from the juice of this tree. The fruit of *T. bellerica*, an East Indian species, is reputed to possess tonic, astringent, and attenuant properties. The fruit of *T. chebula*, also an East Indian species, is used for the purposes of dyeing. Both this and the last species produce gall nuts, which are also used in dyeing. Some of the species of this genus are called myrobalsans.

TERMINATE, v. t. [Fr. *terminer*; L. *termino*; Sp. *terminar*; It. *terminare*; from L. *terminus*, W. *tervyn*.] 1. To bound; to limit; to set the extreme point or side of a thing; as, to *terminate* a surface by a line.—2. To end; to put an end to; as, to *terminate* a controversy.

TERMINATE, v. i. To be limited; to end; to come to the furthest point in space; as, a line *terminates* at the equator; the torrid zone *terminates* at the tropics.—2. To end; to close; to come to a limit in time. The session of the American congress, every second year, must *terminate* on the third of March.

The wisdom of this world, its designs and efficacy, *terminate* on this side heaven. *South.*

TERMINATED, pp. Limited; bounded; ended.

TERMINATING, pp. Limiting; ending; concluding.

TERMINATION, n. The act of limiting or setting bounds; the act of ending or concluding.—2. Bound; limit in space or extent; as, the *termination* of a line.—3. End in time or existence; as, the *termination* of the year or of life; the *termination* of happiness.—4. In *gram.*, the end or ending of a word; the syllable or letter that ends a word. Words have different *terminations* to express number, time, and sex.—5. End; conclusion; result.—6. Last purpose.—7. † Word; term.

TERMINATIONAL, a. Forming the end or concluding syllable.

TERMINATIVE, a. Directing termination.

TERMINATIVELY, adv. Absolutely; so as not to respect any thing else.

TERMINATOR, n. In *astron.*, a name sometimes given to the circle of illumination, from its property of terminating the boundaries of light and darkness.

TERMINER, n. A determining; as, in *oyer* and *terminer*. [See *OYER*.]

TERMING, pp. Calling; denominating.

TERMINISM, n. In *German philosophy*, the doctrine that all things happen through a necessary connection of causes and effects, extending through all nature.—2. In *theol.*, the doctrine that God has assigned to every one a term of repentance, during which his salvation must be wrought out.

TERMINIST, n. In *eccles. hist.*, a sect of Christians who maintain that God has fixed a certain term for the probation of particular persons, during which time they have the offer of grace, but after which God no longer wills their salvation.

TERMINOL'OGY, } n. [Gr. *terminos* and  
TERMONOL'OGY, } *λογος*.] 1. The doctrine of terms; that branch of science or art which defines and explains the words, phrases, and technical terms peculiar to that science or art. It is also called *orismology* and *glossology*.

TERMIN'THUS, n. [Gr. *terminos*, a pine nut.] In *med.*, a sort of *carbuncle*, spreading in the shape, and assuming the figure and blackish green colour of the fruit of the pine, called *pine-nut*.

TERMINUS, n. plur. *Termini*. [L.] A boundary; a limit; a stone raised for marking the boundary of a property. Among the Romans, the deity that presided over boundaries or land-marks. He was represented with a human head, without feet or arms, to intimate that he never moved, wherever he was placed.—2. In *arch.* and *sculp.*, a *terminus*, or *term*, is a pillar statue;

Fig. 1.



Fig. 1. Antique Terminal Bust.

Fig. 2.



Fig. 2. Terminal Statue of Pan in the British Museum.

that is, either a half statue, or bust, not placed upon, but incorporated with, and, as it were, immediately springing out of, the square pillar, which serves as its pedestal. The pillar part is generally made to taper downwards, or made narrower at its base than above. *Termini* are employed not as insulated pillars, but as pilasters, forming a small order or attic, or a decoration to gateways, doors, &c.—3. The extreme point at either end of a rail-



way, the intervals along its course being called *stations*. Also, the buildings for offices, &c., at the extremity of a railway.

**TERMITES,** } *n.* A family of neuropterous insects, known by the name of white ants. It includes the genus *Termes*, Linn. These insects have little affinity with the true ants, although they resemble them in their mode of life. They are chiefly confined to the tropics; and are found very plentifully in western Africa; they unite in societies, each composed of an immense number of individuals, living in the ground and in trees, devouring all vegetable and animal substances within their reach, and often attacking the wood-work of houses. The white ants build their dwellings in the ground, in the form of pyramids or cones, ten or twelve feet high, resembling native villages in extent, and for which indeed they may readily be mistaken. These dwellings, which are so firmly cemented as to be capable of bearing the weight of three or four men, are divided off into several apartments as magazines, chambers, galleries, &c. When assaulted, the ants make their attack and defence with system and desperate courage. After impregnation, the abdomen of the female extends to an enormous size, exceeding the rest of her body nearly 2000 times; in which state it is filled with an immense number of eggs, protruded to the amount of about 8000 in 24 hours.

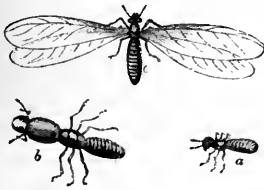

*Termes bellicosus.*

a, Larva or worker; } Natural size.  
b, Pupa or soldier; }  
c, Perfect winged insect reduced in size.

On emerging from the egg, the insects, in their larva state, are furnished with a great hard head and strong toothed jaws, but destitute of eyes. These are the labourers, *a*, who, although not more than a quarter of an inch long, build their edifices, procure provisions for the community, and take care of the eggs. On changing to the pupa state, *b*, they become larger and more powerful; the head is nearly as big as the body, while the jaws project beyond the head, and are very sharp, but without teeth. They now become soldiers and never work themselves, but superintend the labourers, and act as guards to defend the common habitation from violence and intrusion. The next change brings the pupæ or soldiers to their perfect state, as male or female winged insects, *c*. These emerge into the air during the night, or on a damp and cloudy day; in a few hours, however, the solar heat causes their wings to wither and become dry; the insects then fall to the ground, and are eagerly sought after by hosts of birds, lizards, and even negroes themselves, who roast and eat them.

**TERMITI'NÆ,** *n.* Latreille's name for

a section of neuropterous insects, comprehending the genera *Mantispa*, *Raphidia*, *Termes*, and *Pocous*.

**TERM'LESS,** *a.* Unlimited; boundless; as, *termless* joys.

**TERM'LY,** *a.* Occurring every term; as a *termly* fee.

**TERM'LY,** *adv.* Term by term; every term; as, a fee *termly* given.

**TER'MON,** *n.* Formerly, in *Ireland*, an ecclesiastical district exempt from regal imposts.

**TER'MOR,** *n.* One who has an estate for a term of years, or for life. [*See* **TERMER.**]

**TERN,** *n.* [*L. sterna.*] A common name of certain aquatic fowls of the genus *sterna*; as the great tern or sea-swallow, (*S. hirundo*), the black tern, the lesser tern, or hooded tern, and the

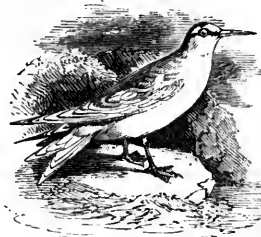

Lesser Tern (*Sterna minuta*).

foolish tern, or noddy, (*S. stotida*.) The brown tern, or brown gull, (*S. obscura*), is considered as the young of the pewit gull or sea-crow, before moulting.

**TERN,** *a.* [*L. ternus.*] Threefold; consisting of three.—*Tern leaves*, (*folia terna*), leaves in threes, or three by three; expressing the number of leaves in each whorl or set.—*Tern peduncles*, three growing together from the same axil.—*Tern flowers*, growing three and three together.

**TERN'ARY,** *a.* [*L. ternarius*, of three.] Proceeding by threes; consisting of three. Applied to things arranged in order by threes; thus a flower is said to have a ternary division of its parts, when it has three sepals, three petals, three stamens, or twice or thrice as many. The *ternary* number, in antiquity, was esteemed a symbol of perfection and held in great veneration.

**TERN'ARY,** } *n.* [*L. ternarius, ternio.*]  
**TERN'ION,** } The number three.

**TERN'ATE,** *a.* [*L. ternus, terni.*] In *bot.*, a *ternate* leaf is one that has three leaflets on a petiole, as in trefoil, strawberry, bramble, &c. There are leaves also *biterminate* and *triterminate*, having three ternate or three biterminate leaflets. These leaves must not be confounded with *folia terna*, which are leaves that grow three together in a whorl, on a stem or branch. These are, however, more correctly called *verticillate-ternate*.—*Ternate bat*, a species of bat of a large kind, found in the isle Ternate, and other East India isles. [*See* **VAMPIRE.**]

**TERN'ION.** *See* **TERNARY.**

**TERNSTRÖMIA'CEÆ,** *n.* A nat. order of polypetalous dicotyledonous plants, consisting of trees or shrubs, with alternate coriaceous leaves, without stipules. The flowers are generally white, and are arranged in axillary or terminal peduncles, articulated at the base. This order is one of great

economical importance, as it includes the genus *thea*, from which the teas of commerce are obtained. The plants belonging to the order are principally inhabitants of Asia and America.

**TERPO'DION,** *n.* The name of a modern musical keyed instrument, invented by John David Buschmann of Friedrichsrode, near Gotha. The interior mechanism consists of wooden staves, which are made to vibrate by the friction of a wooden cylinder, set in motion by a wheel. It is said to produce very sweet notes, and to be particularly fine as an accompaniment to vocal music.

**TERPSI'CHORE,** *n.* [*Gr. τέρψω*: to delight, and χορός, a dance.] In *Grecian myth.*, one of the muses, who presided over dancing and lyrical poetry. She is generally represented with a lyre,



Terpsichore, from an antique statue.

having seven strings, or a plectrum in the hand, in the act of dancing, and crowned with flowers.

**TERPSICHORE'AN,** *a.* Relating to Terpsichore, the muse who presided over dancing and lyrical poetry.

**TER'RA,** *n.* The Latin word for earth or the earth. In *min.*, it is used to signify an earth, or earthy substance. *Terra cotta*, baked clay, or burned earth, frequently used at an early period for the architectural decoration of a building. Many statues of the deities, bassi-relievi, lamps, vessels, &c., were also formed of this material. In modern times, it has also been much used for architectural decorations. It consists of potter's clay, and fine white sand, as that from Ryegate, with pulverized potsherds.—*Terra firma*, solid land, main land, a continent, in opposition to insular territories.—*Terra cultural*, denoting culture or tillage of the earth.—*Terra culture*, cultivation of the earth.—*Terra incognita*, an unknown or unexplored region.—*Terra japonica*, catechu, so called.—*Terra ponderosa*, barytes, or heavy spar,—*which see.*—*Terra sienna*, an ochreous earth, so named from its being brought from Sienna. It is a sort of brown bole, and is used as a pigment.—*Terra sigillata*, or *Terra lemnia*, Lemnian earth,—*which see.*—*Terra a terra*, in the *menage*, a series of low leaps which a horse makes forwards, bearing sideways, and working upon two treads.

**TER'RACE,** *n.* [*Fr. terrasse*; *It. terrazzo*; *Sp. terrado*]; from *L. terra*, the earth.] 1. In *gardening*, a raised level space or platform of earth, supported on one or more sides, by a wall or bank of turf, &c., used either for cultivation

or for a promenade.—2. A balcony or open gallery.—3. The flat roof of a house. All the buildings of the Oriental nations are covered with terraces, where people walk or sleep.—4. In *arch.*, an area raised before a building, above the level of the ground, to serve as a promenade. The same name is given to a street in a town, having a row of buildings on one side, and sloping ground on the other.

**TERR'ACE**, *v. t.* To form into a terrace.—2. To open to the air and light.

**TERR'ACED**, *pp.* Formed into a terrace; having a terrace.

**TERR'RACING**, *ppr.* Forming into a terrace; opening to the air.

**TERRÆ-FILIUS**, *n.* [L.] In classical Latin, a humorous designation of persons of obscure birth, or of low origin; *teræ filii*, sons of the earth.—2. In former times, a scholar at the university of Oxford, appointed to make jesting satirical speeches, and who often indulged in considerable licence in his treatment of the authorities of the university.

**TERR'RAPIN**, *n. sing. and plur.* A kind of tide-water tortoise, common in some of the states of North America, and esteemed as food.

**TERRA'QUEOUS**, *a.* [L. *terra*, earth, and *aqua*, water; W. *tir*, Sans. *dara*, earth.] Consisting of land and water, as the globe or earth. This epithet is given to the earth in regard to the surface, of which more than three fifths consist of water, and the remainder of earth or solid materials.

**TERR'AR**, *† n.* A register of lands.

**TERRAS**, *n.* [Fr. *terasse*.] In *her.*, the representation of a piece of ground at the bottom of the base, and generally vert.

**TERR'E**, *† v. t.* To provoke. [See *TARRE*.]

**TERR'E-BLUE**, *n.* [Fr. *terre*, earth, and *bleu*.] A kind of earth.

**TERR'E-MOTE**, *† n.* [L. *terra*, earth, and *motus*, motion.] An earthquake.

**TERR'E-PLEIN**, *n.* [Fr. *terre*, earth, and *plein*, full.] In *fort.*, the top, platform, or horizontal surface of a rampart, on which the cannon are placed.

**TERR'E-TEN'ANT**, *n.* [Fr. *terre-tenant*, *ant.*] One who has the actual possession of land; the occupant.

**TERR'E-VERTE**, *n.* [Fr. *terre*, earth, and *verd*, *verte*, green.] A species of olive-green earth, used by painters. It is an indurated clay, found in the earth in large flat masses, imbedded in strata of other species of earth. It is of a fine regular structure, and of a smooth glossy surface. According to Klaproth, it is a hydrated silicate of oxide of iron, and potash, with a little magnesia, and alumina. It is found in Germany, France, Italy, and North America.

**TERR'ÉEN**, *n.* [Fr. *terrine*, from Lat. *terra*, earth.] An earthen or porcelain vessel for table furniture, used often for containing soup. [See *TUREEN*, the word used.]

**TERR'EL**, } *n.* [from *terra*.] Little  
**TERR'EL'LA**, } earth, a magnet of a just spherical figure, and so placed that its poles, equator, &c., correspond exactly to those of the world.

**TERR'ÈNE**, *a.* [L. *terrenus*, from *terra*, W. *tir*, earth.] 1. Pertaining to the earth; earthy; as, *terrene substance*.—2. Earthly; terrestrial.

God set before him a mortal and immortal life, a nature celestial and *terrene*. *Raleigh*.

**TERR'ÉOUS**, *a.* [L. *terreus*, from *terra*, earth.] Earthy; consisting of earth; as, *terreous substances*; *terreous particles*.

**TERR'ES'TRIAL**, *a.* [L. *terrestris*, from *terra*, the earth.] 1. Pertaining to the earth; existing on the earth; as, *terrestrial animals*; *bodies terrestrial*; 1 Cor. xv.—2. Consisting of earth; as, the *terrestrial globe*.—3. Pertaining to the world, or to the present state; sublunary. Death puts an end to all *terrestrial* scenes.

**TERR'ES'TRIALLY**, *adv.* After an earthly manner.

**TERR'ES'TRIFY**, *† v. t.* To reduce to earth.

**TERR'ES'TRIOUS**, *a.* Earthy. [Little used.]—2. Pertaining to the earth; being or living on the earth; terrestrial.

**TERR'RIBLE**, *a.* [Fr. from L. *terribilis*, from *terreo*, to frighten.] 1. Frightful; adapted to excite terror; dreadful; formidable.

Prudent in peace, and *terrible* in war. *Prior*.

The form of the image was *terrible*; Dan. ii.

2. Adapted to impress dread, terror, or solemn awe and reverence.

The Lord thy God is among you, a mighty God and *terrible*; Deut. vii.

Let them praise thy great and *terrible* name, for it is holy; Ps. xcix.

He hath done for thee these great and *terrible* things, which thine eyes have seen; Deut. x.

3. *adv.* Severely; very; so as to give pain; as, *terrible cold*; a *colloquial phrase*.

**TERR'IBLENESS**, *n.* Dreadfulness; formidableness; the quality or state of being terrible; as, the *terribleness* of a sight.

**TERR'RIBLY**, *adv.* Dreadfully; in a manner to excite terror or fright.

When he ariseth to shake *terribly* the earth; Is. ii.

2. Violently; very greatly.

The poor man squaled *terribly*. *Swift*.

**TERR'IER**, *n.* [Fr. from *terra*, earth.] 1. A dog or little hound that follows his game into holes; the *canis familiaris terrarius*, remarkable for the eagerness and courage with which it goes to earth, and attacks all those quadrupeds which gamekeepers call *vermin*, as foxes, badgers, cats, rats, &c. There are two kinds of terriers, the one rough and wire-haired, the other smooth haired and generally more delicate in appearance. The pepper and mustard breeds, rendered famous by Sir Walter Scott, are highly valued.—2. A lodge or hole where certain animals, as foxes, rabbits, badgers and the like secure themselves.—3. *Originally*, a collection of acknowledgments of the vassals or tenants of a lordship, containing the rents and services they owed to the lord, &c.; at present, a book or roll in which the lands of private persons or corporations are described by their site, boundaries, number of acres, &c.—4. A wimble, auger, or borer. [L. *tero*.]

**TERR'IFIC**, *a.* [L. *terrificus*, from *terror*, and *facio*.] Dreadful; causing terror; adapted to excite great fear or dread; as, a *terrific* form; *terrific* sight.

**TERR'IFIED**, *pp.* Frightened; affrighted.

**TERR'IFY**, *v. t.* [L. *terror* and *facio*,

to make.] To frighten; to alarm or shock with fear.

They were *terrified* and affrighted; Luke xxiv.

When ye shall hear of wars and commotions, be not *terrified*; Luke xxi; Job vii.

**TERR'RIFYING**, *ppr.* Frightening; affrighting.

**TERRI'G'ÉNOUS**, *a.* [L. *terrigena*, one born of the earth; *terra* and *gigno*.] Earthborn; produced by the earth.

**TERRIT'O'RIAL**, *a.* [from *territory*.] Pertaining to territory or land; as, *territorial limits*; *territorial jurisdiction*.—2. Limited to a certain district. Rights may be personal or *territorial*.

—*Territorial economy*, whatever relates to the valuation, purchase, sale, exchange, arrangement, improvement by roads, canals, drainage, &c., of territorial surface, including interposing waters, as rivers, lakes, and also mines and minerals.

**TERRIT'O'RIALIZE**, *v. t.* To enlarge or extend by addition of territory.

**TERRIT'O'RIALLY**, *adv.* In regard to territory; by means of territory.

**TERR'ITORIED**, *a.* Possessed of territory.

**TERR'ITORY**, *n.* [Fr. *territoire*; It. and Sp. *territorio*; L. *territorium*, from *terra*, earth.] 1. The extent or compass of land within the bounds or belonging to the jurisdiction of any state, city, or other body.

Linger not in my *territories*. *Shak.*  
They erected a house within their own *territory*. *Hayward*.

Arts and sciences took their rise and flourished only in those small *territories* where the people were free. *Swift*.

2. A tract of land belonging to and under the dominion of a prince or state, lying at a distance from the parent country or from the seat of government; as, the *territories* of British India—*Territory of a judge* in *Scots law*, the district over which his jurisdiction extends, in causes, and in judicial acts proper to him, and beyond which he has no judicial authority.

**TERR'OR**, *n.* [L. *terror*, from *terreo*, to frighten; Fr. *terreur*; It. *terrore*.] 1. Extreme fear; violent dread; fright; fear that agitates the body and mind.

The sword without and *terror* within; Deut. xxxii.

The *terrors* of God do set themselves in array against me; Job vi.  
Amaze and *terror* seiz'd the rebel host. *Milton*.

2. That which may excite dread; the cause of extreme fear.

Rulers are not a *terror* to good works, but to the evil; Rom. xiii.

Those enormous *terrors* of the Nile.

3. In *scrip.*, the sudden judgments of God are called *terrors*; Ps. lxxiii.—4. The threatenings of wicked men, or evil apprehended from them; 1 Pet. iii.—5. A wful majesty, calculated to impress fear; 2 Cor. v.—6. Death is emphatically styled the *king of terrors*.—*Reign of terror*, in the history of the first French Revolution, a term generally applied to that period during which the country was under the sway of those ferocious and blood-thirsty governors, who made the slaughter of persons of all ages, sexes, and conditions, who were considered obnoxious to their measures, the avowed principle of their authority. The reign of terror,

properly so called, seems to have commenced in October 1793, when the revolutionary tribunal was put in permanent action, and to have ended in July 1794, on the overthrow of Robespierre and his accomplices.

**TER'RORISM, n.** A state of being terrified, or a state impressing terror.

**TER'RORIST, n.** One who prematurely or needlessly proclaims danger.—2. The name given to an agent and partizan of the French Revolution during the reign of terror.

**TER'RORILESS, a.** Free from terror.

**TER'ROR-SMITTEN, a.** Smitten with terror.

**TER'ROR-STRUCK, a.** Stricken with terror.

**TERSE, a. (ters.)** [L. *tersus*, from *tergo*, to wipe.] Cleanly written; neat; elegant without pomposness; as, *terse language*; a *terse style*.  
Diffus'd yet *terse*, poetical, though plain.  
Harte.

**TERSELY, adv. (ters'ly.)** Neatly.

**TERSENESS, n. (ters'ness.)** Neatness of style; smoothness of language.

**TERSULPHURET, n.** A sulphuret containing three equivalents of sulphur.

**TER-TEN'ANT, n.** [Fr. *terre*, and *tenant*.] The occupant of land.

**TER'TIAL, a.** A term applied to the quills growing on the last or innermost joint of a bird's wing.

**TER'TIALS, n.** In *ornithology*, the large feathers near the junction of the wing with the body.

**TER'TIAN, a.** [L. *tertianus*, from *tertius*, third.] Occurring every other day; as, a *tertian fever*.

**TER'TIAN, n.** A disease or fever whose paroxysms return every other day; an intermittent whose paroxysms occur after intervals of a little less than forty-eight hours.—2. † A measure of 84 gallons, the third part of a tun.

**TER'TIARY, a.** Third; of the third formation. *Tertiary* mountains are such as result from the ruins of other mountains promiscuously heaped together.—*Tertiary formation*, or *tertiary strata*, in *geol.*, the uppermost great group of strata, a series of horizontal strata, more recent than chalk beds, consisting chiefly of sand and clay, and frequently embracing vast quantities of organic remains of the larger animals. It comprehends the *alluvial formation*, which embraces those deposits only which have resulted from causes still in operation; and the *diluvial formation*, which is constituted of such deposits as are supposed to have been produced by the deluge. In almost every part of the globe, strata of the tertiary series prevail, and yield astonishing numbers of shells, corals, crustacea, and other remains of marine, freshwater, and terrestrial invertebrata, and more locally, abundant layers of fishes, and rich deposits of bones of mammalia, &c. The tertiary strata have been subdivided into four principal groups, to which Mr. Lyell has assigned the terms *eocene*, *miocene*, *older pliocene*, and *newer pliocene*, each group being characterized by the relative proportion of recent and extinct species of shells therein contained. [See *these terms*.]

**TER'TIATE, v. t.** [L. *tertius*, third; *tertio*, to do every third day.] 1. To do any thing the third time.—2. To examine the thickness of the metal at the muzzle of a gun; or in general, to

examine the thickness to ascertain the strength of ordnance.

**TER'TIATED, pp.** Done the third time.

**TERTIUM QUID. [L.]** A third something.

**TER'TIUM SAL, n.** A name given by the old chemists to a neutral salt, as being the product of an acid and an alkali, making a third substance different from either.

**TERUN'CIUS, n.** [L. *ter*, three times, and *uncia*, an ounce.] An ancient Roman coin, being the fourth part of the *as*, and containing three ounces.

**TER'ZA RI'MA, n.** [It. third or triple rhyme.] A complicated system of versification, borrowed by the early Italian poets from the Troubadours. Byron adopted it in his *Prophesy of Dante*.

**TERZET'TO, n. [It.]** In *music*, a piece for three voices; a composition in three parts.

**TES'SELAR, a.** Formed in squares.

**TES'SELATE, v. t.** [L. *tessela*, a little square stone.] To form into squares or checkers; to lay with checkered work.

**TES'SELATED, pp.** Checkered; formed in little squares or mosaic work. *Tessellated pavement*, in *ancient arch.*, a pavement of mosaic work, composed of small square marbles, bricks, tiles, or pebbles of different colours.—2. In *bot.*, spotted like a chess board; as, a *tessellated leaf*.

**TES'SELATING, ppr.** Forming in little squares.

**TESSELLA'TION, n.** Mosaic work, or the operation of making it.

**TES'SERA, } n. [L.]** A small cube or  
**TES'SELA, }** square resembling our dice, and consisting of different materials, as marble, precious stones, ivory, glass, wood, or mother of pearl. These *tesserae* or *tesselae*, were used by the ancients to form the mosaic floors or pavements in houses, and for several other purposes.

**TESSERA'IC, a.** [L. *tessera*, a square thing.] Diversified by squares; tessellated.

**TES'SERAL, a.** Pertaining to or containing tesserae.—2. In *crystallography*, a term applied to crystals having equal axes, like the cube.

**TES'SULAR, a.** [L. *tessela*, a little square stone; a die.] A term applied to a system of crystals. The cube, tetraëdron, and several other forms belong to the *tessular system*.

**TEST, n.** [L. *testa*, an earthen pot; It. *testa* or *testo*; Fr. *têt*.] In *metallurgy*, a large cupel, or a vessel in the nature of a cupel, formed of wood ashes and finely powdered brick dust, in which metals are melted for trial and refinement. [See *CUPEL*.]—2. Trial; examination by the cupel; hence, any critical trial and examination.

Thy virtue, prince, has stood the *test* of fortune  
Like purest gold. Addison.

3. Means of trial.

Each *test* and every light her muse will bear.  
Dryden.

4. That with which any thing is compared for proof of its genuineness; a standard.

Life, force, and beauty must to all impart,  
At once the source, the end and *test* of art.  
Pope.

5. Discriminative characteristic; standard.

Our *test* excludes your tribe from benefit.  
Dryden.

6. Judgment; distinction.  
Who would excel, when few can make a *test*  
Betwixt indifferent writing and the best?  
Dryden.

7. In *chem.*, a re-agent; a substance which is employed to detect the presence of any ingredient in a compound, by causing it to exhibit some known property; or it is a substance which, being added to another, indicates the chemical nature of that other substance, by producing certain changes in appearance and properties: Thus, infusion of galls is a *test* of the presence of iron, which it renders evident by the production of a black colour in water and other liquids, containing that metal; litmus is a *test* for determining the presence of acids when uncombined or in excess, as its blue colour is turned red by acids. *Test-liquid*, a solution of a substance employed as a test. In qualitative analysis, the presence of any particular ingredient in the substance under examination, is generally ascertained by mixing a test-liquid with the solution of the substance operated upon, and observing by the occurrence, or non-occurrence of a precipitate, whether the suspected substance is present or not.—*Test-tube*, a kind of tube for holding the mixtures of the solution of a substance to be analyzed with the test-liquid.

**TEST, n.** [L. *testis*, a witness, properly one that affirms.] An oath and declaration against transubstantiation, which all officers, civil and military, were obliged to take within six months after their admission. They were formerly obliged also to receive the sacrament, according to the usage of the Church of England. These requisitions were made by Stat. 25 Charles II. which is called the *test-act*. This act is usually conjoined with another called the *corporation-act*. The Test and Corporation acts were repealed in 1828, and a declaration set forth in the act substituted. [See *CORPORATION*.]

**TEST, v. t.** To compare with a standard; to try; to prove the truth or genuineness of any thing by experiment or by some fixed principle or standard; as, to *test* the soundness of a principle; to *test* the validity of an argument.

The true way of *testing* its character, is to suppose it [the system] will be persevered in.  
Edin. Review.

Experience is the surest standard by which to *test* the real tendency of the existing constitution. Washington's Address.

To *test* this position. Hamilton, Rep.

In order to *test* the correctness of this system. Adams' Lect.

This expedient has been already *tested*.  
Walsh, Rev.

2. To attest and date; as, a writing *tested* on such a day.—3. In *metallurgy*, to refine gold or silver by means of lead, in a test, by the destruction, vitrification, or scorification of all extraneous matter.

**TESTA, n.** [L.] A shell; commonly applied to the shelly covering of testaceous animals.—2. In *bot.*, the outer coat or integument of a seed.

**TESTABLE, a.** [L. *testor*. See *TESTAMENT*.] That may be devised or given by will; capable of witnessing.

**TESTA'CEA, } n. plur.** Shelled ani-  
**TESTA'CEANS, }** mals. The third order of Vermeis, in the Linnean system. This order is composed of conchiferous molluscs and ascidias, arranged by Linn., under thirty-six genera. The *testacea*

differ from the *crustacean* in their composition, the calcareous part of the shells of testacea being carbonate of lime, whereas in the shells of crustacea it is phosphate of lime. The testacea also retain their shells as long as they live; the crustacea cast them annually, or at least periodically. The term testacea is applied by Cuvier to an order of his class *Acephala*. [See VERMES.]

**TESTACEAN**, *n.* One of the testacea.

**TESTACEAN**, *a.* Relating to the testacea.

**TESTACEOLUS**, *n.* A genus of testaceous pulmoniferous molluscs, which are furnished with a diminutive shell, forming a shield or protection to the heart. Two or three species have been enumerated; they infest gardens and nurseries.

**TESTACEOGRAPHY**. See **TESTACEOLOGY**.

**TESTACEOLÓGY**, *n.* [L. *testacea* or *testa*, and Gr. *λογία*.] The science of testaceous molluscs, or of those soft and simple animals which have a testaceous covering. The term is synonymous with *conchology*.

**TESTACEOUS**, *a.* [L. *testaceus*, from *testa*, a shell. The primary sense of *testa*, *testis*, *testor*, &c., is to thrust or drive; hence the sense of hardness, compactness, in *testa* and *testis*; and hence the sense of *attest*, *contest*, *detest*, *testator*, *testament*, all implying a sending, driving, &c.] Pertaining to shells; consisting of a hard shell, or having a hard continuous shell. *Testaceous animals* are such as have a strong thick entire shell, as oysters and clams; and are thus distinguished from *crustaceous animals*, whose shells are more thin and soft, and consist of several pieces jointed, as lobsters.—*Testaceous medicines*, are all preparations of shells and like substances, as the powders of crabs' claws, pearl, &c.

**TESTAMENT**, *n.* [Fr. from L. *testamentum*, from *testor*, to make a will.] 1. A solemn authentic instrument in writing, by which a person declares his will as to the disposal of his estate and effects after his death. This is otherwise called a *will*, but in strictness of language, the term *will* is limited to land, and *testament* to personal estate. A *testament*, to be valid, must be made when the testator is of sound mind, and it must be written, subscribed, &c., in such manner as the law prescribes. In *Scots law*, the word *testament*, in the strictly legal acceptation, signifies a deed in writing, by which the grantor appoints an executor, that is, a person to administer his movable estate after his death, for the behoof of all who may be interested in it. A testament may thus consist merely of the nomination of an executor, or it may contain, along with such a nomination, clauses bequeathing, in the form of legacies, either the whole or part of the movable estate. In its more common meaning, however, a testament is a declaration of what a person will to be done with his movable estate, after his death. Any person has power to execute an effectual testament who is of sound mind at the time, although he be labouring under bodily sickness, or even be on death-bed. A testament is effectual only with regard to the movable estate of the testator, and even in regard to things strictly movable, a person cannot dispose by testament of more than

that share of them which is termed the dead's part; he must not encroach upon the *jus relictae*, or *legitim*. [See *these terms*.] A testament may be revoked at any time during the life of the testator. All testaments containing the nomination of an executor, or the bequest of a legacy of greater value than £100 Scots, must be in writing, and properly tested and signed before witnesses, but if it be in the testator's own handwriting, witnesses are not required. [For more information respecting testaments and wills in English and Scots law, see WILL. See also NUNCUPATIVE.]—2. The name of each general division of the canonical books of the sacred Scriptures; as, the Old Testament; the New Testament. The name is equivalent to *covenant*, and in our use of it, we apply it to the books which contain the old and new dispensations; that of Moses, and that of Jesus Christ.

**TESTAMENTARY**, *a.* Pertaining to a will or to wills; as, *testamentary* causes in law.—2. Bequeathed by will; given by testament; as, *testamentary* charities.—3. Done by testament or will.—*Testamentary guardian*, of a minor, is one appointed by the deed or will of a father, until the child becomes of age.

**TESTAMENTATION**, *n.* The act or power of giving by will. [Little used.]

**TESTATE**, *a.* [L. *testatus*.] Having made and left a will; as, a person is said to die *testate*.

**TESTATION**, *n.* [L. *testatio*.] A witnessing or witness.

**TESTATOR**, *n.* [L.] A man who makes and leaves a will or testament at death.

**TESTATRIX**, *n.* A woman who makes and leaves a will at death.

**TESTE**, *n.* [L. *testor*, to witness.] In law, that part of a writ wherein the date is contained, beginning with the words *teste meipso*, if it be an original writ; or *teste, the lord chief*, if it be judicial. [See WARR.]

**TESTED**, *pp.* Tried or approved by a test; witnessed.

**TESTER**, *n.* [Fr. *tête*, head.] The top covering of a bed, consisting of some species of cloth, supported by the bedstead.

**TESTER**, } *n.* An old coin, originally

**TESTON**, } French, and named from the head upon it. As an English coin, its value from the time of Edward VI. was about sixpence.

**TESTERN**, *n.* A sixpence.

**TESTERN**, *v. t.* To present with a sixpence.

**TESTES**, *n. plur.* [L. *testis*.] In anat., the testicles.

**TESTICLE**, *n.* [L. *testiculus*; literally a hard mass, like *testa*, a shell.] The testicles are the glands which secrete the seminal fluid in males.

**TESTICULATE**, *a.* In bot., shaped like a testicle. A *testiculate root* is one which has one or two rounded egg-shaped tubercles; as in Jerusalem artichoke.

**TESTIFICATION**, *n.* [L. *testificatio*. See **TESTIFY**.] The act of testifying or giving testimony or evidence; as, a direct *testification* of our homage to God.

**TESTIFICATOR**, *n.* One who gives witness or evidence.

**TESTIFIED**, *pp.* [from *testify*.] Given in evidence; witnessed; published; made known.

**TESTIFIER**, *n.* [from *testify*.] One who testifies; one who gives testimony or bears witness to prove anything.

**TESTIFY**, *v. i.* [L. *testificor*; *testis* and *facio*; *i. t.* *testificare*; Sp. *testificar*.] 1. To make a solemn declaration, verbal or written, to establish some fact; to give testimony for the purpose of communicating to others a knowledge of something not known to them.

Jesus needed not that any should testify of man, for he knew what was in man; John ii.

2. In *judicial proceedings*, to make a solemn declaration under oath, for the purpose of establishing or making proof of some fact to a court; to give testimony in a cause depending before a tribunal.

One witness shall not testify against any person to cause him to die; Numb. xxxv.

3. To declare a charge against one.

O Israel, I will testify against thee; Ps. l.

4. To protest; to declare against.

I testified against them in the day wherein they sold provisions; Neh. xiii.

**TESTIFY**, *v. t.* To affirm or declare solemnly for the purpose of establishing a fact.

We speak that we do know, and testify that we have seen; John iii.

2. In law, to affirm or declare under oath before a tribunal, for the purpose of proving some fact.—3. To bear witness to; to support the truth of by testimony.

To testify the gospel of the grace of God; Acts xx.

4. To publish and declare freely.

Testifying both to the Jews, and also to the Greeks, repentance toward God and faith toward our Lord Jesus Christ; Acts xx.

**TESTIFYING**, *ppr.* Affirming solemnly or under oath, for the purpose of establishing a fact; giving testimony; bearing witness; declaring.

**TESTILY**, *adv.* [from *testy*.] Fretfully; peevishly; with petulance.

**TESTIMONIAL**, *n.* [Fr. from L. *testimonium*.] A writing or certificate in favour of one's character or good conduct. *Testimonials* are required on many occasions. A person must have *testimonials* of his learning and good conduct, before he can obtain license to preach. *Testimonials* are to be signed by persons of known respectability of character.

**TESTIMONIAL**, *a.* Relating to, or containing testimony.

**TESTIMONY**, *n.* [L. *testimonium*.] 1. A solemn declaration or affirmation made for the purpose of establishing or proving some fact. Such affirmation, in judicial proceedings, may be verbal or written, but must be under oath. *Testimony* differs from *evidence*; *testimony* is the declaration of a witness, and *evidence* is the effect of that declaration on the mind, or the degree of light which it affords. [See EVIDENCE.]—2. Affirmation; declaration. These doctrines are supported by the uniform *testimony* of the fathers. The belief of past facts must depend on the evidence of human *testimony*, or the *testimony* of historians.—3. Open attestation; profession.

Thou for the *testimony* of truth hast borne Universal reproach. Milton.



Testiculate root  
(Orchis morio).

4. Witness; evidence; proof of some fact.

Shake off the dust under your feet, for a *testimony* against them; Mark vi.

5. In *scrip.*, the two tables of the law.

Thou shalt put into the ark the *testimony* which I shall give thee; Exod. xxv.

6. The book of the law.

He brought forth the king's son...and gave him the *testimony*; 2 Kings xi.

7. The gospel, which testifies of Christ and declares the will of God; 1 Cor. ii.; 2 Tim. i.—8. The ark; Exod. xvi.—9. The word of God; the scriptures.

The *testimony* of the Lord is sure, making wise the simple; Ps. xix.

10. The laws or precepts of God. "I love thy *testimonies*." "I have kept thy *testimonies*."—11. That which is equivalent to a declaration; manifestation.

Sacrifices were appointed by God for a *testimony* of his hatred of sin. Clarke.

12. Evidence suggested to the mind; as, the *testimony* of conscience; 2 Cor. i.—13. Attestation; confirmation.—Perpetuation of *testimony*. [See PERPETUATION.]

TESTIMONY, † v. t. To witness.

TESTINESS, n. [from *testiv.*] Fretfulness; peevishness; petulance.

*Testiness* is a disposition or aptness to be angry. Locke.

TESTING, ppr. [from *test.*] Trying for proof; proving by a standard or by experiment.

A plan for *testing* alkalies. Ure.

*Testing clause.* In *Scots law*, the testing clause is the technical name given to the clause in a formal written deed or instrument, by which it is authenticated according to the forms of the law. It consists essentially of the name and designation, or addition of the writer, the mention of the number of pages of which the deed consists, and the names and designations of the witnesses.

TESTING, n. The act of trying for proof.—2. In *metallurgy*, the operation of refining large quantities of gold or silver by means of lead, in the vessel called a *test*. In this process the extraneous matter is vitrified, scorified, or destroyed, and the metal left pure. This operation is performed in the manner of cupellation.

TESTON, } n. Old names for a six-  
TESTER, } pence, in England. [Dean Swift is among the last writers who have used either term.]

TESTOON', or TESTONE, n. A silver coin in Italy and Portugal. In Florence, the *testoon* is worth two lire or three paoli, about seventeen pence sterling. At Lisbon, the *testoon*, as a money of account, is valued at 100 rees, about seven pence sterling.

TEST-PAPER, n. A paper impregnated with a chemical re-agent, as litmus, &c.

TESTUDINAL, a. Pertaining to the tortoise, or resembling it.

TESTUDINATA, n. An order of Chelonian reptiles comprehending the tortoises. [See TORTOISE.]

TESTUDINATED, } a. [L. *testudo*, a  
TESTUDINATE, } tortoise.] Roofed  
back; arched; vaulted; resembling the back of a tortoise.

TESTUDINEOUS, a. Resembling the shell of a tortoise.

TESTUDO, n. [L.] A tortoise. Among the Romans, a cover or screen which

a body of troops formed with their shields or targets, by holding them over their heads when standing close to each other. This cover resembled

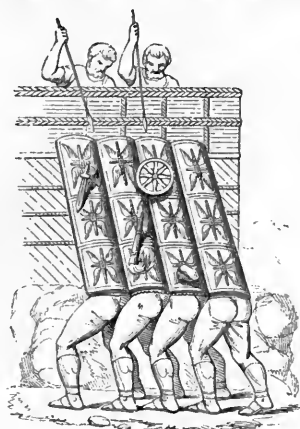

Roman Testudo from Trajan's Pillar.

the back of a tortoise, and served to shelter the men from darts, stones, and other missiles. A similar defence was sometimes formed of boards and moved on wheels.—2. In *med.*, a broad soft tumour between the skull and the skin, called also *talpa* or mole, as resembling the subterraneous windings of the tortoise or mole.—3. In *zool.* [See TORTOISE.]

TESTY, a. [from Fr. *teste*, *tête*, the head, or from the same root.] Fretful; peevish; petulant; easily irritated. Pyrrhus cured his *testy* courtiers with a kick.

Must I stand and crouch under your *testy* humour? Shak.

TETANIC, a. Pertaining to, or denoting tetanus; as, *tetanic* spasm.

TETANUS, n. [Gr. *τετανος*, stretched.] Spasm with rigidity; a disease characterized by a more or less violent and rigid spasm of many, or all, of the muscles of voluntary motion. The varieties of this disease are: 1. *Trismus*, the locked jaw; 2. *Opisthotonos*, where the body is thrown back by spasmodic contractions of the muscles; 3. *Emprosthotonos*, where the body is bent forwards; 4. *Pleurosthotonos*, where the body is bent to one side. These affections arise more frequently in warm climates than in cold. They are occasioned either by exposure to cold, or by some irritation of the nerves, in consequence of local injury by puncture, incision, or laceration; hence, the distinction of tetanus into *idiopathic* and *traumatic*. Lacerated wounds of tendinous parts prove, in warm climates, a never-failing source of these complaints. In cold climates as well as in warm, the locked jaw (in which the spasms are confined to the muscles of the jaw or throat,) frequently arises in consequence of the amputation of a limb, or from lacerated wounds. Tetanic affections, which arise in consequence of a wound or local injury, usually prove fatal.

TETARTO-PRISMATIC, a. [Gr. *τεταρτος*, fourth.] One fourth prismatic; applied to oblique rhombic prisms.

TETAUG', n. The name of a fish on the coast of New England; called also black fish, or rock fish.

TETCHINESS, or TETCHY. See

TECHINESS, TETCHY. [Corrupted from *touchy*, *touchiness*.]

TETE, n. [Fr. head.] False hair; a kind of wig or cap of false hair.

TETE'-A-TETE', adv. [Fr.] Head to head; cheek by jowl; in private; in close confabulation.

TETE'-A-TETE', n. An interview; a friendly or close conversation.

TETE'-DU-PONT', n. [Fr.] In *fort.*, a work that defends the head or entrance of a bridge.

TETH'ER, n. [See TEDDER.] A rope or chain by which a beast is confined for feeding within certain limits.

TETH'ER, v. t. To confine, as a beast, with a rope or chain for feeding within certain limits.

TETH'ERED, ppr. Confined with a rope.

TETHYDANS, n. [See TETHYS.] A tribe of tunicated acephalous molluscs, having for its type the ancient genus *Tethys*.

TETHYS, n. [Gr. *τιθης*, an ascidian.] The name given by Linnæus to a genus of *Vermes testacea*, characterized by having two rows of branchiæ, resembling branching tufts along the back, and a very large membranous and fringed veil on the head, which shortens as it curves under the mouth; on the base of the veil are two compressed tentacula, from whose margin projects a small conical point. In the system of Cuvier, these animals form a genus of nudibranchiate Gastropods. They inhabit the Mediterranean.

TETRABRANCHIATA, n. [Gr. *τετρας*, four, and *βραγχια*, gills.] The name given by Owen to his second order of the class Cephalopoda. Of this order the pearly nautilus may be regarded as the type.

TETRACAUL'ODON, n. A fossil extinct animal of the miocene period, allied to the mastodon.

TETRA'CHORD, n. [Gr. *τετρας*, four, and *χορδη*, a chord.] In *ancient music*, a diatessaron; a series of four sounds, of which the extremes, or first and last, constituted a fourth. These extremes were immutable; the two middle sounds were changeable.

TETRACHO'TOMOUS, a. [Gr. *τετραχος*, in a fourfold manner, and *τομοσ*, to cut or divide.] In *bot.*, an epithet for a stem that ramifies in fours.

TETRACOL'ON, n. In *prosody*, a stanza, or division of lyric poetry, consisting of four verses.

TETRAD, n. [Gr. *τετρας*, the number four.] The number four; a collection of four things.

TETRADAC'TYL, n. [Gr.] An animal having four toes.

TETRADAC'TYLOUS, a. [Gr. *τετρας* and *δακτυλος*.] Having four toes.

TETRA'DIAPASON', n. [Gr. *τετρας*, four, and *diapason*.] Quadruple diapason or octave; a musical chord, otherwise called a quadruple eighth or twenty-ninth.

TETRADRACH'MA, n. [Gr. *τετρας* and *δραχμα*.] In *ancient coinage*, a silver coin worth four drachmas, 2s. 7d. sterling; the drachma being estimated at 71d. sterling.

TETRADYNAM'IAN, n. [Gr. *τετρα δυναμις*, power, strength.] In *bot.*, a plant having six stamens, four of which are longer than the others.—*Tetradynamia* is the name of the 15th class of plants in the Linnæan system, comprehending those plants which bear hermaphrodite flowers, with six sta-

mens, four of them longer than the other two. It contains two orders, *siliculosus*, of which colewort is an



Tetradymanian (Wallflower).

example; and *siliquosa*, of which the mustard and cabbage are examples. All the plants of this class belong to the nat. order Cruciferae.

**TETRADYNAMIAN**, } *a.* Having six  
**TETRADYNAMOUS**, } stamens, four  
of which are uniformly longer than the others.

**TETRAE'DRON**. See **TETRAHEDRON**.

**TETRAGON**, *n.* [Gr. *τετραγωνος*: *τετρα*, for *τεσσαρις*, four, and *γωνια*, an angle.] 1. In *geom.*, a figure having four angles; a quadrangle; as a square, a rhombus, &c. But the term is usually applied to the square only, when used, which it seldom is.—2. In *astrol.*, an aspect of two planets with regard to the earth, when they are distant from each other ninety degrees, or the fourth of a circle.

**TETRAGONAL**, *a.* Pertaining to a tetragon; having four angles or sides. Thus a square, a parallelogram, a rhombus, and a trapezium, are *tetragonal* figures.—2. In *bot.*, having prominent longitudinal angles.—*Tetragonal leaf*, a leaf having four edges, as in *Iris tuberosa*.—*Tetragonal ovary*, one that is four sided.—*Tetragonal stem*, one that has four sides; as, in *Lamium purpureum*.

**TETRAGONIA'CEÆ**, *n.* A nat. order of plants, placed by Lindley in his curcembryose group of incomplete dicotyledons, and having the genus *Tetragonia*, Linn. as its type. The plants of this order have thick succulent leaves.—*Tetragonia expansa* is a native of New Zealand and Japan, and is used by the natives of those countries as a remedy for scorbutic complaints. The genera *Aizoon*, *Sesuvium*, and *Miltus*, are also included in this order.

**TETRAGONISM**, } *n.* The quadrature  
of the circle.

**TETRAGONOL'OBUS**, *n.* A genus of plants nat. order Leguminosæ, papilionaceous division. The species are natives of Europe, and consist of herbs with broad leafy stipules, trifoliate leaves, and flowers seated on axillary peduncles, furnished with a bract. They have a close resemblance to bird's foot trefoil, and in gardens are well adapted for ornamenting rock work.—*T. purpureus*, or purple winged pea, is a native of the south of Europe. There is a variety of this species (*T. p. minor*), the legumes of which are cooked and eaten in southern regions, in the same manner as French beans.

**TETRAGRAMMATON**, *n.* [Gr. *τετρα*,

four, and *γραμμα*, a letter.] The Hebrew name יהוה, Jehovah, so called because it consists of four letters. Among several ancient nations besides the Jews, the name of the supreme deity was expressed by four letters; as, the Assyrian Adad, the Egyptian Amon, the Persian Syre, the Greek Θεοι, the Roman Deus. Hence, four became a mystic number, and was often symbolized to represent the supreme deity.

**TETRAGYN**, *n.* [Gr. *τετρα*, four, and *γυνη*, a female.] In *bot.*, a monoclinous or hermaphrodite plant having four pistils.—*Tetragynia* is the name of an order of plants in several of the classes in the Linnæan system. It comprehends those plants which have four pistils. The flex, grass of Parnassus, *Parnassia palustris*, &c., furnish examples.

**TETRAGYN'IAN**, } *a.* Relating to a  
**TETRAGYNOUS**, } monoclinous or  
hermaphrodite plant which has four pistils.

**TETRAHE'DRAL**, } *a.* [See **TETRA-**  
**TETRAE'DRAL**, } **HEDRON**.] Hav-  
ing four equal triangles.—2. In *bot.*,  
having four sides.

**TETRAHE'DRON**, } *n.* [Gr. *τετρα*,  
**TETRAE'DRON**, } four, and *ιδρα*,  
side.] In *geom.*, a figure comprehended under four equilateral and equal triangles; or it is a triangular pyramid, having four equal and equilateral faces. It is one of the five regular Platonic bodies of that figure.

**TETRAHEXAHE'DRAL**, *a.* [Gr. *τετρα*, four, and *hexahedral*.] In *crystallography*, exhibiting four ranges of faces, one above another, each range containing six faces.

**TETRAHEXAHE'DRON**, *n.* [Gr. *τετρα*, four, and *hexahedron*.] A solid bounded by twenty-four equal faces, four corresponding to each face of the cube.

**TETRA'MERA**, *n.* [Gr. *τετρα*, and *μερος*, a thigh.] Latreille's name for a section of coleopterous insects, distinguished by having all the tarsi four-jointed; as in the Rhynchophora.

**TETRAM'EROUS**, *a.* In *bot.*, consisting of four parts. A flower is said to be tetramerous when the different whorls, as calyx, corolla, and stamens, have each four parts.

**TETRAM'ETER**, *n.* [Gr. *τετρα*, four, and *μετρος*, measure.] In *ancient poetry*, a verse consisting of four measures, or eight feet, which may be iambic, trochaic, or anapestic.

**TETRAN'DER**, *n.* [Gr. *τετρα*, four, and *ανδρς*, a male.] In *bot.*, a monoclinous or hermaphrodite plant, having four stamens.—*Tetrandria* is the name of



Tetrand (Ludwigia justimoides).

the fourth class of plants in the Linnæan system, comprehending such as

have four stamens. The orders belonging to this class are Monogynia, Digynia, and Tetragynia. The teasel, dodder, and pond-weed, furnish examples.

**TETRAN'DRIAN**, } *a.* Being mono-  
**TETRAN'DROUS**, } clinous or her-  
maphrodite, and having four stamens.

**TETRAO**, *n.* [L. a bastard.] The name given by Linnæus to an extensive genus of gallinaceous birds, characterized by a naked and most generally red band, which occupies the place of the eye-brow. It includes all the various species of grouse, the francolins, partridges, and quails. Latham, however, has restricted the genus *Tetrao* to those species of which the feet are covered with feathers, and are without spurs, with naked toes, and a round or forked tail. These are the true grouse, but the term grouse is also extended to the ptarmigans.

**TETRAO'NIDÆ**, *n.* The grouse family, the third family of the Rasores in the arrangement of Swainson. It is composed of the partridges, grouse, and quails, all of which agree in the extreme shortness of their tails, and of their hind-toe. Nearly all the grouse have the toes and legs more or less covered with soft feathers, but this character disappears in the partridges. In the quails we have a miniature resemblance of partridges, but the tail is so short as to be scarcely perceptible. Grouse inhabit Europe, Asia, Africa, and America, and abound chiefly in heathy mountains and plains, and piny forests, at a distance from mankind. The black cock (*Tetrao tetrix*); the red grouse (*Lagopus scoticus*); and the common ptarmigan (*Lagopus mutus*) are British species. The capercaillie, the largest and most noble grouse of Europe, although once plentiful in Scotland, has altogether disappeared from that country; but the marquis of Breadalbane and other noblemen have recently attempted to reintroduce it, with every prospect of success.

**TETRAPET'ALOUS**, *a.* [Gr. *τετρα*, four, and *πεταλος*, leaf.] In *bot.*, containing four distinct petals or flower leaves; as, a *tetrapetalous* corolla.

**TETRAPHAR'MACON**, *n.* [Gr.] A combination of wax, resin, lard, and pitch, composing an ointment.

**TETRAPHYLLOUS**, *a.* [Gr. *τετρα*, four, and *φυλλος*, leaf.] In *bot.*, having four leaves; consisting of four distinct leaves or leaflets.

**TETRAPLA**, *n.* [Gr. *τετρα*, four, and *απλοσ*, to unfold or explain.] The name given to an edition of the Bible, arranged by Origen in four columns, containing four Greek versions; viz., the Septuagint, that of Aquila, that of Symmachus, and that of Theodosian.

**TETRAP'ODY**, *n.* A series of four feet.

**TETRAP'TERANS**, *n.* Insects which have four wings.

**TETRAP'TEROUS**, *a.* Having four wings.

**TETRAP'TOTE**, *n.* [Gr. *τετρα*, four, and *πρωσις*, case.] In *gram.*, a noun that has four cases only; as, *L. astus*, &c.

**TETRARCH**, *n.* [Gr. *τετραρχος*: *τετρα*, four, and *αρχος*, rule.] A Roman governor of the fourth part of a province; a subordinate prince. In time, this word came to denote any petty king or sovereign.

**TETRARCHATE**, *n.* The fourth part of a province under a Roman tetrarch;

or the office or jurisdiction of a tetrarch.

**TETRARCHICAL**, *a.* Pertaining to a tetrarchy.

**TETRARCHY**, *n.* The same as *Tetrarchate*.

**TETRASEPALOUS**, *a.* [Gr. *τετρα*, four, and *σπαλ*, the leaf of a calyx.] In *bot.*, a term applied to a calyx which is composed of four sepals.

**TETRASPASTON**, *n.* [Gr. *τετρα*, four, and *σπασ*, to pull.] A machine in which four pulleys all act together.

**TETRASPERMOUS**, *a.* [Gr. *τετρα*, four, and *σπέρμα*, seed.] In *bot.*, having four seeds. A *tetrasperous plant* is one which produces four seeds in each flower, as the rough-leaved or verticillate plants.

**TETRASTIC**, *n.* [*τετραστιχος*: *τετρα*, four, and *στιχος*, verse.] A stanza, epigram, or poem consisting of four verses.

**TETRASTYLE**, *n.* [Gr. *τετρα*, four, and *στυλος*, column.] In *ancient arch.*, a colonnade or portico, consisting of four columns.

**TETRASYLLABIC**, } *a.* Consist-  
**TETRASYLLABICAL**, } ing of four syllables.

**TETRASYLLABLE**, *n.* [Gr. *τετρα*, four, and *συλλαβη*, syllable.] A word consisting of four syllables.

**TETRIE**, } *a.* [*L. tricus.*]  
**TETRICAL**, } Froward; perverse;  
**TETRICOUS**, } harsh; sour; rugged;  
**TETRIICALNESS**, } *n.* Frowardness; perverseness.

**TETRICITY**, } *n.* Crabbedness; perverseness.

**TETRODON**, *n.* [Gr. *τετρα*, four, and *οδου*, a tooth.] A genus of fishes of the order Plectognathi, distinguished by the possession of four large teeth, the jaws being each divided by a central suture. They have the power of inflating the body with wind, which causes them to float on the surface of the water, and gives them an almost spherical form. These fishes are confined to the seas of warm climates. Some of them are called Globe-fish. [See **GLOBE-FISH**.]

**TETTER**, *n.* [Sax. *teter*, *tetr*; allied perhaps to *L. titillo*.] 1. In *med.*, a vague name of several cutaneous diseases.—2. In *furriery*, a cutaneous disease of animals, which spreads on the body in different directions, and occasions a troublesome itching.

**TETTER**, *v. t.* To affect with the disease called *tetters*.

**TETTER-TOTTER**, } *n.* A balancing  
play of children, similar to see-saw.  
Called, also, *titter-cum-totter*.

**TETTISH**, } *a.* [Qu. Fr. *tête*, head.]  
Captious; testy.

**TEUCRUM**, *n.* A genus of plants. [See **GERMANDER**.]

**TEUTHIDÆ**, or **TEUTHIDANS**, *n.* Owen's name for his fourth family of decapodous Cephalopods. The common calamary or pen-fish (*Loligo vulgaris*), abundant on our coasts, is an example.

**TEUTONIC**, *a.* Pertaining to the Teutones or Teutons, a people of Germany, or to their language; as a noun, the language of the Teutons, the parent of the German, Dutch, and Anglo-Saxon or native English.—*Teutonic order*, a military religious order of knights, established toward the close of the twelfth century, in imitation of the Templars and Hospitalers. It was composed chiefly of Teutons or Ger-

mans, who marched to the Holy Land in the crusades, and was established in that country for charitable purposes. It increased in numbers and strength till it became master of all Prussia, Livonia, and Pomerania. It was abolished by Napoleon in 1809.—*Teutonic nations*, the different nations of the Teutonic race. These are divided into three branches: 1. The High Germans, including the Teutonic inhabitants of Upper and Middle Germany; those of Switzerland, and the greater part of the Germans of Hungary. 2. The Saxon branch, including the Frisians, the Old Saxons or Low Germans, the Dutch, the Flemings, the Saxons of Transylvania, the English, the Scotch, and the greater part of the inhabitants of North America. 3. The Scandinavian branch, including the Icelanders, the Norwegians, the Danes, and the Swedes. Upwards of eighty-two millions of inhabitants belong to the Teutonic race.

**TEW**, } *v. t.* To work; to soften; to  
beat in order to soften, as hemp; to  
press, push, drag, or tumble about.  
[See **TAW**.]—2. To work; to pull or  
tease; among seamen.

**TEW**, *v. i.* To labour.

**TEW**, } *n.* [probably *tow*.] Materials  
for any thing.—2. } An iron chain.

**TEWEL**, *n.* [Fr. *tuyau*.] A pipe; a funnel, as for smoke; an iron pipe in a forge to receive the pipe of a bellows.

**TEW'TAW**, } *v. t.* To beat; to break.  
[See **Tew**.]

**TEXT**, *n.* [Fr. *texte*; *L. textus*, woven; *It. testo*. See **TEXTURE**.] 1. A discourse or composition on which a note or commentary is written. Thus we speak of the *text* or original of the scripture, in relation to the comments upon it. Infinite pains have been taken to ascertain and establish the genuine original *text*.—2. A verse or passage of scripture which a preacher selects as the subject of a discourse.

How oft, when Paul has served us with a *text*,  
Has Epictetus, Plato, Tully preach'd.

*Cowper.*

3. Any particular passage of scripture, used as authority in argument for proof of a doctrine. In modern sermons, *texts* of scripture are not as frequently cited as they were formerly.—4. In *ancient law authors*, the four Gospels, by way of eminence.—5. A particular kind of handwriting; as, large *text*; small *text*; middle *text*.

**TEXT**, *v. t.* To write, as a text. [*Not much used*.]

**TEXT-BOOK**, *n.* In *universities* and *colleges*, a classic author written with wide spaces between the lines, to give room for the observations or interpretation dictated by the master or regent.—2. A book containing the leading principles or most important points of a science or branch of learning, arranged in order for the use of students.

**TEXT-HAND**, *n.* A large hand in writing; so called because it was the practice to write the text of a book in a large hand, and the notes in a smaller hand.

**TEXTILE**, *a.* [*L. textilis*.] Woven, or capable of being woven; as, *textile fabrics*; *textile materials*, such as wool, flax, silk, cotton.

**TEXTILE**, *n.* That which is or may be woven.

**TEXT-MAN**, *n.* A man ready in the quotation of texts.

**TEXTORIAL**, *a.* [*L. textor*.] Pertaining to weaving.

**TEXTURINE**, *a.* Pertaining to weaving; as, the *texturine art*.

**TEXTUAL**, *a.* Contained in the text.—2. Serving for texts.

**TEXTUALIST**, } *n.* [Fr. *textuaire*,  
**TEXTUARIST**, } from *texte*.] 1. One  
**TEXTUARY**, } who is well versed  
in the scriptures, and can readily quote  
texts.—2. One who adheres to the text.  
*Among the Jews*, the Karaites have  
been called *Textuaries*, from their ad-  
herence to the text of the Jewish  
scriptures.

**TEXTUALLY**, *adv.* Placed in the text or body of a work.

**TEXTUARY**, *a.* Textual; contained in the text.—2. Serving as a text; authoritative.

**TEXTUIST**, *n.* One ready in the quotation of texts.

**TEXTURE**, *n.* [*L. textura*, *textus*, from *texo*, to weave.] 1. The act of weaving.—2. A web; that which is woven.

Others, far on the grassy dale,  
Their humble texture weave. *Thomson.*

3. The disposition or connection of threads, filaments, or other slender bodies interwoven; as, the *texture* of cloth or of a spider's web.—4. The disposition of the several parts of any body in connection with each other; or the manner in which the constituent parts are united; as, the *texture* of earthy substances or fossils; the *texture* of a plant; the *texture* of paper, of a hat, or skin; a loose *texture*; or a close compact *texture*.—5. In *anat.* [See **TISSUE**.]

**THACK**, for *Thatch*, is Scotch, but is used as a local term in several parts of England.—*Thack-tiles*, an old term for tiles or slates used for covering a roof. [See **THATCH**.]

**THALAMIFLORÆ**, *n.* A subclass of exogenous or dicotyledonous plants in which the sepals and petals are distinct, and the stamens are inserted on the thalamus or receptacle, being thus hypogynous.

**THALAMUS**, *n.* [Gr. *θαλαμος*, a bed.] In *anat.*, a part of the brain from which the optic nerve derives one of its origins.—2. In *bot.*, the part on which the ovary is situated, as the core in the fruit of a raspberry. Some botanists call it the receptacle of the fruit.

**THALASSEMA**, *n.* [Gr. *θαλασσα*, the sea.] The name given by Cuvier to a genus of footless Echinoderms, having the body oval or oblong, with the proboscis in form of a reflected lamina or spoon, but not forked.

**THALASSIDROMA**, *n.* [Gr. *θαλασσα*, the sea, and *δρομος*, the act of running.] The generic name of the Petrels. [See **PETREL**.]

**THALASSINIANS**, *n.* A family of burrowing macrurous Decapods, remarkable for the extreme elongation of their abdomen, and the small degree of consistence of their integuments.

**THALER**, *n.* [*L. thalerus*.] A German coin, value about three shillings sterling. It is the *dollar* of Germany.

**THALYA**, *n.* [Gr. *θαλυα*, from *θαλλω*, to flourish, to bloom.] In *antiquity*, one of the nine muses, who presided over husbandry and planting, and was also regarded as the patroness of pas-

toral and comic poetry. She is represented leaning on a column, with a



Thalia, after an antique statue.

comic mask in her right hand, and a shepherd's crook in her left.

**THALICTRUM**, *n.* Meadow-rue, a genus of plants. [See MEADOW-RUE.]

**THALIDANS**, *n.* [Gr. *θαλασσα*, bloom.] That group of segregate naked acephalous molluscs, of which *Thalia* is the type. They have a small crest or vertical fin near the posterior extremity of the back.

**THALITE**, *n.* [Gr. *θαλασσα*, a green twig.] In *min.*, a substance variously denominated by different authors. It is the epidote of Haiiy, the delphinite of Saussure, and the pistacite of Werner. It occurs both crystallized and in masses.

**THALLOGEN**, } *n.* A name given  
**THALLOPHYTE**, } to cellular plants  
which have a thallus, as lichens.

**THALLUS**, *n.* [Gr. *θαλασσα*, an olive bud, or green bough.] In *bot.*, a term generally applied to that part of a cryptogamic plant which bears the reproductive organs, and constitutes the principal part of its vegetation. In lichens, the thallus or *frond* constitutes the great bulk of the plant. In mosses it is a leafy branched tuft, with the cellular tissue particularly large. In the algae, the term *thallus* is applied to the whole plant, whilst in the fungi it is used synonymously with *Thalamus*.

**THIAMUZ**, *n.* The tenth month of the Jewish civil year, containing 29 days, and answering to a part of June and a part of July.—2. The name of a deity among the Phenicians.

**THAN**, *adv.* or *conj.* [Sax. *thane*; Goth. *than*; D. *dan*. This word signifies also *then*, both in English and Dutch. The Germans express the sense by *als*, as.] This word is placed after some comparative adjective or adverb, to express comparison between what precedes and what follows. Thus Elijah said, I am not better *than* my fathers. Wisdom is better *than* strength. Israel loved Joseph more *than* all his children. All nations are counted less *than* nothing. I who am less *than* the least of all saints. The last error shall be worse *than* the first. He that denies the faith is worse *than* an infidel. It also often follows *other*, and even *else*. After *more*, or an equivalent termination, the following word implies *less*, or *worse*; after *less*, or an equivalent termination, it implies *more* or *better*.

**THANAGE**, *n.* The land granted to a thane; the district in which the thane anciently presided.

**THANE**, *n.* [Sax. *thegn*, *thægn*, a minister or servant; *thegnian*, *thenian*, to serve; D. and G. *diener*, to serve; Sw. *tiener*, to serve; *tiener*, a servant; Dan. *tiener*, to serve; *tiener*, a servant.] In early *Eng. hist.*, a title of honour belonging to the Anglo-Saxon nobility. In its original meaning, it signified a minister or honourable retainer, and was applied to the followers of kings and chieftains. The thanes in England were formerly persons of some dignity; of these there were two orders, the king's thanes, who attended the Saxon and Danish kings in their courts, and held lands immediately of them; and the ordinary thanes, who were lords of manors, and who had a particular jurisdiction within their limits. In a later age of the Anglo-Saxon power, the term *thane* seems to have been applied to all landed proprietors who were below the rank of earl, and above that of alderman, and had the privilege of assisting in framing the laws. The rank of thane implied the possession of a certain amount of landed property, and five hides of land is supposed to have been the amount required for a thane of the highest order. After the Conquest, this title was disused, and *baron* took its place. In *Scotland*, *thane* was a recognised title down to the end of the 15th century, and it appears to have implied from the first a higher dignity than in England, and to have been, for the most part, synonymous with *earl*, which title was generally annexed to the territory of a whole county.

**THANEDOM**, *n.* The property or jurisdiction of a thane.

**THANE-LANDS**, *n.* Lands granted to thanes.

**THANESHIP**, *n.* The state or dignity of a thane; or his seignory.

**THANK**, *v. t.* [Sax. *thancian*; G. and D. *thanen*; Ice. *thacha*; Sw. *tacka*; Dan. *takker*. We see by the Gothic dialects that *n* is not radical. To ascertain the primary sense, let us attend to its compounds; G. *abdanhen*, [which in English would be *off-thank*,] to dismiss, discharge, discard, send away, put off, to disband or break, as an officer; *verdanken*, to owe or be indebted; D. *afdanhen*, to cashier or discharge. These senses imply a sending. Hence, *thank* is probably from the sense of giving, that is, a render or return.] 1. To express gratitude for a favour; to make acknowledgments to one for kindness bestowed.

We are bound to *thank* God always for you; 2 Thess. i.

Joab bowed himself and *thanked* the king; 2 Sam. xiv.

2. It is used ironically.

Weigh the danger with the doubtful bliss, And *thank* yourself, if aught should fall amiss. *Dryden.*

**THANK**, } *n.* generally in the plural.  
**THANKS**, } [Sax. *thane*; Gael. *tainc*.] Expression of gratitude; an acknowledgment made to express a sense of favour or kindness received. Gratitude is the feeling or sentiment excited by kindness; *thanks* are the expression of that sentiment; Luke vi.

*Thanks* be to God who giveth us the victory; 1 Cor. xv.

*Thanks* be to God for his unspeakable gift; 2 Cor. ix.

He took bread and gave *thanks* to God; Acts xxvii.

**THANKED**, *pp.* Having received expressions of gratitude.

**THANKFUL**, *a.* [Sax. *thancfull*; Gael. *taincal*.] Grateful; impressed with a sense of kindness received, and ready to acknowledge it. The Lord's supper is to be celebrated with a *thankful* remembrance of his sufferings and death.

Be *thankful* to him and bless his name; Ps. c.

**THANKFULLY**, *adv.* With a grateful sense of favour or kindness received.

If you have liv'd, take *thankfully* the past. *Dryden.*

**THANKFULNESS**, *n.* Expression of gratitude; acknowledgment of a favour.—2. Gratitude; a lively sense of good received.

The celebration of these holy mysteries being ended, retire with all *thankfulness* of heart for having been admitted to that heavenly feast. *Taylor.*

**THANK'ING**, *ppr.* Expressing gratitude for good received.

**THANK'LESS**, *a.* Unthankful; ungrateful; not acknowledging favours.

That she may feel

How sharper than a serpent's tooth it is To have a *thankless* child. *Shak.*

2. Not deserving thanks, or not likely to gain thanks; as, a *thankless* office.

**THANK'LESSNESS**, *n.* Ingratitude; failure to acknowledge a kindness.

**THANK-OFFERING**, *n.* [*thank* and *offering*.] An offering made in acknowledgment of mercy.

**THANKSGIVE**, } *v. t.* (thanks/giv.)  
[*thanks* and *give*.] To celebrate or distinguish by solemn rites.

**THANKS GIVER**, *n.* One who gives thanks or acknowledges a kindness.

**THANKS'GIVING**, *ppr.* Rendering thanks for good received.

**THANKS'GIVING**, *n.* The act of rendering thanks or expressing gratitude for favours or mercies.

Every creature of God is good, and nothing to be refused, if received with *thanks-giving*; 1 Tim. iv.

2. A public celebration of divine goodness; also, a day set apart for religious services, specially to acknowledge the goodness of God, either in any remarkable deliverance from calamities or danger, or in the ordinary dispensation of his bounties.

**THANK-WORTH'INESS**, *n.* The state of being thank-worthy.

**THANK'-WORTHY**, *a.* [*thank* and *worthy*.] Deserving thanks; meritorious; 1 Pet. ii.

**THANUS**, *n.* [Law Latin.] A thane.

**THAP'SIA**, *n.* A genus of plants, nat. order Umbellifere. The species are known under the name deadly carrot, and are mostly inhabitants of the countries of the Mediterranean. They are perennial herbs, with doubly or trebly pinnate leaves, large compound umbels, and yellow flowers. The roots possess acrid and corrosive properties. The root of *T. villosa*, when applied to the skin, causes inflammation and vesication.—*T. silphium*, a native of the north of Africa, is supposed to be the plant which produced the juice called Silphium, which was much prized by the ancients.

**THAR**, *n.* A species of antelope.  
**THARM**, *n.* [Sax. *thærm*; G. and D. *darm*.] Intestines twisted into a cord. [*Local*.]



**THAT**, *an adjective, pronoun, or substitute.* [Sax. *that, that*; Goth. *thattu*; D. *dat*; G. *das*. Qu. Gr. *ταυτες*. This word is called, in Saxon and German, an article, for it sometimes signifies *the*. It is called also, in Saxon, a pronoun, equivalent to *id, istud*, in Latin. In Swedish and Danish it is called a pronoun of the neuter gender. But these distinctions are groundless and of no use. It is probably from the sense of setting.] 1. *That* is a word used as a definitive adjective, pointing to a certain person or thing before mentioned, or supposed to be understood. "Here is *that* book we have been seeking this hour." "Here goes *that* man we were talking of."

It shall be more tolerable for Sodom and Gomorrah in the day of judgment, than for *that* city; Matt. x.

2. *That* is used definitively, to designate a specific thing or person emphatically.

The woman was made whole from *that* hour; Matt. ix.

In these cases, *that* is an adjective. In the two first examples, *the* may be substituted for it. "Here is *the* book we have been seeking." "Here goes *the* man we were talking of." But in other cases, *the* cannot supply its place, and *that* may be considered as more emphatically definitive than *the*.—3. *That* is used as the representative of a noun, either a person or a thing. In this use it is often a pronoun and a relative. When it refers to persons, it is equivalent to *who*, and when it refers to a thing, it is equivalent to *which*. In this use, it represents either the singular number or the plural.

He *that* reproveh a scornor, getteth himself shame; Prov. ix.

They *that* hate me without a cause, are more than the hairs of my head; Ps. lxxiii.

A judgment *that* is equal and impartial, must incline to the greater probabilities.

*Wilkins.*

They shall gather out of his kingdom all things *that* offend; Matt. xiii.

4. *That* is also the representative of a sentence or part of a sentence, and often of a series of sentences. In this case, *that* is not strictly a pronoun, a word standing for a noun; but is, so to speak, a *pro-sentence*, the substitute for a sentence, to save the repetition of it.

And when Moses heard *that*, he was content; Lev. x.

*That* here stands for the whole of what Aaron had said, or the whole of the preceding verse.

I will know your business, *that* I will.

*Shak.*

Ye defraud, and *that* your brethren; 1 Cor. vi.

*That* sometimes in this use, precedes the sentence or clause to which it refers.

*That* be far from thee, to do after this manner, to slay the righteous with the wicked; Gen. xviii.

*That* here represents the clause in italics.—5. *That* sometimes is the substitute for an adjective. You allege that the man is *innocent*; *that* he is not.—6. *That*, in the following use, has been called a conjunction. "I heard that the Greeks had defeated the Turks." But in this case, *that* has the same character as in No. 4. It is the representative of the part of the sentence which follows, as may be seen by inverting the order of the clauses.

"The Greeks had defeated the Turks: I heard *that*." "It is not *that* I love you less." *That* here refers to the latter clause of the sentence, as a kind of demonstrative.—7. *That* was formerly used for *that which*, like *what*.

We speak *that* we do know, and testify *that* we have seen; John iii.

[This use is no longer held legitimate.]

—8. *That* is used in opposition to *this*, or by way of distinction.

If the Lord will, we shall live, and do *this* or *that*; James iv.

9. When *this* and *that* refer to foregoing words, *this*, like the Latin *hic* and French *ceci*, refers to the latter, and *that* to the former. It is the same with *these* and *those*.

*Self-love* and *reason* to one end aspire, Pain their aversion, pleasure their desire; But greedy *that*, its object would devour, *This* taste the honey, and not wound the flower. *Pope.*

10. *That* sometimes introduces an explanation of something going before. "Religion consists in living up to those principles; *that* is, in acting in conformity to them." Here *that* refers to the whole first clause of the sentence.

—11. "Things are preached, not in *that* they are taught, but in *that* they are published." Here *that* refers to the words which follow it. So when *that* begins a sentence. "*That* we may fully understand the subject, let us consider the following propositions." *That* denotes purpose, or rather introduces the clause expressing purpose, as will appear by restoring the sentence to its natural order. "Let us consider the following propositions, *that*, [for the purpose expressed in the following clause,] we may fully understand the subject."

"Attend *that* you may receive instruction." Here also *that* expresses purpose elliptically; "Attend for the purpose *that* you may receive instruction," *that* referring to the last number. This elliptical use of *that* is very frequent; the preposition *for* being understood. "A man travels *that* he may regain his health." He travels *for that* purpose, he may regain his health. The French often retains the preposition in such cases, *pour que*. "Do all things without murmurings and disputings, *that* ye may be blameless and harmless;" Phil. ii. 14. Do all things without murmurings, *for that* purpose; *to that* effect, ye may be blameless.—*In that*, a phrase denoting consequence, cause, or reason; *that* referring to the following sentence.

**THATCH**, *n.* [Sax. *thac*, connected with *theccan, thecan*, to cover; L. *tego*, Eng. *deck*; G. *dach*, a roof; D. *dak*; Sw. *tak*; Dan. *tag, takke*; Gaelic, *tughe, tuighe*. The primary sense is to put on, to spread over or make close.] Straw, rushes, reeds, heath, &c., used to cover the roofs of buildings, or stacks of hay or grain, for securing them from rain, &c.

**THATCH**, *v. t.* To cover with straw, reeds, or some similar substance; as, to *thatch* a house or a stable, or a stack of grain.

**THATCH'ED**, *pp.* Covered with straw or thatch.

**THATCH'ER**, *n.* One whose occupation is to thatch houses.

**THATCH'ING**, *ppr.* Covering with straw or thatch.

**THATCH'ING**, *n.* The act or art of covering houses, barns, cattle-sheds, &c., and also stacks or ricks of hay and

corn, with straw, reeds, &c., in such a manner as to exclude rain. The materials used for thatching are the straw of wheat, rye, and oats, reeds (those of the *Arundo donax*, Linn.), common heath or ling, rushes, the spray of birch, &c.

**THATCH'ING KNIFE**, *n.* An implement used in thatching houses for trimming the eaves.

**THAUGHTS**, *n.* [A corruption of *Thwartis*.] The benches of a boat on which the rowers sit. [See **TUWARD**.]

**THAUMATROPE**, *n.* [Gr. *θαυμα*, a wonder, and *τροπος*, to turn.] An optical toy contrived by Dr. Paris, the principle of which depends on the persistence of vision, or on the well-known fact, that when a person whirls a burning stick rapidly round, a complete circle of light is seen marking out the path described by the burning end. It consists of a circular card, having two silk strings fixed to it at the extremities of a diameter. By twisting the silk strings with the finger and thumb of each hand, it may be twirled round with considerable rapidity. On one side of the card there is drawn any object, such as a chariot, and on the other, the charioteer in the attitude of driving, so that when the card is twirled round, the charioteer is seen driving the chariot.

**THAUMATUR'GIC**, or **THAUMATUR'GICAL**, *a.* [See **THAUMATURGY**.] Exciting wonder.

**THAUMATUR'GIST**, } *n.* One who  
**THAUMATUR'GUS**, } deals in wonders, or believes in them. It is sometimes used by Roman Catholics to signify a miracle-worker; as Gregory *Thaumaturgus*.

**THAUMATUR'GY**, *n.* [Gr. *θαυμα*, a wonder, and *τροπος*, work.] The act of performing something wonderful.

**THAW**, *v. i.* [Sax. *thawan*; G. *thauen*; Dan. *tøer*; Sw. *tåa*; Gr. *ταυω*.] 1. To melt, dissolve, or become fluid, as ice or snow. [It is remarkable that this word is used only of things that congeal by frost. We never say, to *thaw* metal of any kind.]—2. To become so warm as to melt ice and snow; *used of weather*.

**THAW**, *v. t.* To melt; to dissolve; as ice, snow, hail, or frozen earth.

**THAW**, *n.* The melting of ice or snow; the resolution of ice into the state of a fluid; liquefaction by heat, of any thing congealed by frost.

**THAW'ED**, *pp.* Melted, as ice or snow.

**THAW'ING**, *ppr.* Dissolving; resolving into a fluid; liquefying; as, any thing frozen.

**THE**, *an adjective, or definitive adjective.* [Sax. *the*; D. *de*. Qu. Ch. *ἡ, da*.] 1. This adjective is used as a definitive, that is, before nouns which are specific or understood; or it is used to limit their signification to a specific thing or things, or to describe them; as, the laws of the twelve tables. The independent tribunals of justice in our country, are the security of private rights, and the best bulwark against arbitrary power. The sun is the source of light and heat.

This he calls *the* preaching of the cross.

*Simeon.*

2. *The* is also used rhetorically before a noun in the singular number, to denote a species by way of distinction; a single thing representing the whole. The fig-tree putteth forth her green figs; the almond-tree shall flourish;

the grasshopper shall be a burden.—3. In *poetry*, the sometimes loses the final vowel before another vowel.

*Th'* adorning thee with so much art,  
Is but a barbo'ous skill. *Cowley.*

4. *The* is used before adjectives in the comparative and superlative degree. *The longer* we continue in sin. *the more difficult* it is to reform. *The most strenuous* exertions will be used to emancipate Greece. *The most* we can do is to submit; *the best* we can do; *the worst* that can happen. *The* is generally pronounced with the *e* short; but when used emphatically, it is pronounced as *thee*.

THE'A, *n.* [See TEA.] A genus of plants, nat. order Ternstroemiaceæ, which includes the plants yielding the tea of commerce. The species are few, at most three, *T. viridis*, *T. bohea*, and *T. assamica*, and some botanists assert that even these are varieties of a single species. *T. viridis* is a large,



*Thea viridis.*

hardy, evergreen plant, with spreading branches, its leaves three to five inches long, thin, very broadly lanceolate, light green and wavy, with large and irregular serratures, the flowers large, usually solitary, and of a white colour. It is found both in China and Japan. *T. bohea* is a smaller plant than *T. viridis*, and differs from it in several particulars. From either species, however, by means of a different process of manipulation in the manufacture, both black and green tea are produced. Tea is cultivated in China over a great extent of territory; it is also extensively cultivated in Japan, Tonquin, Cochinchina, and Assam. In China, the climate most congenial to it seems to be that between the 27th and 31st degree of north latitude. In the husbandry of China, the tea-plant may be said to take the same place which the vine occupies in the southern countries of Europe. Its growth is chiefly confined to hilly tracts, not suited to the growth of corn, and the rearing of it requires great skill and attention, as well as the preparation of the leaves. [See TEA.]

THEAN'DRIC, *a.* [Gr. *θεός*, God, and *άνθρωπος*, a man.] Designating the union of divine and human operation in Christ, or the joint agency of the divine and human nature.

THEAN'THROPISM, *n.* [Gr. *θεός*, and *άνθρωπος*.] A state of being God and man.

THE'ARCHY, *n.* [Gr. *θεός*, God, and *αρχή*, rule.] Government by God; more commonly called *Theocracy*.

THE'ATINS, } *n.* An order of monks  
TE'ATINS, } founded at Rome in

1524, principally by Gianpietro Caraffa, archbishop of Chieti in Naples, the Latin name of which is *Teate*, hence the name given to the order. Besides taking the usual monastic vows, they bound themselves to preach against heretics, to take upon them the cure of souls, to attend the sick and criminals, to abstain from possessing property, and not even to ask for alms, but to trust to Providence for support, expecting, however, that this support would be derived from the voluntary alms of the charitable. There were also Theatin nuns (called in French *Theatines*) who spent their whole time in solitude and prayer. The Theatins were principally established in Italy and France, in which latter country they subsisted till the revolution in 1789. In Italy the order is still numerous and influential.

THE'ATRAL,† *a.* Belonging to a theatre.

THE'ATRE, *n.* [Fr. *theatre*; L. *theatrum*; Gr. *θεατρον*, from *θεαομαι*, to see.] 1. Among the ancients, an edifice in which spectacles or shows and dramatic representations were exhibited for the amusement of spectators. Among the Greeks and Romans, theatres were the chief public edifices next to the temples, and in point of magnitude they surpassed the most spacious of the temples. The Greek and Roman theatres very closely resemble each other in their general form and principal parts. The building was of an oblong, semicircular form, resembling the half of an amphitheatre. The space appropriated to the seats of the spectators was termed *cavea* by the Romans, and *κολων* by the Greeks. The seats were all concentric with the orchestra, and were intersected in one direction by ascents or flights of steps, dividing the seats into so many compartments. The place for the players, in front of the seats, was called *scena* (*σκηνη*). The semicircular space between the *scena* and the seats of the spectators was called *orchestra* (*ορχηστρα*), appropriated by the Greeks to the chorus and musicians, and by the Romans to the senators. Besides these essential parts there were the *pulpitum* or stage, the *proscenium*, and *postscenium*, with regard to which parts the Greek and Roman theatres differed considerably. —2. In *modern times*, a house for the exhibition of dramatic performances, as tragedies, comedies, and farces; a playhouse; comprehending the stage, the pit, the boxes, galleries, and orchestra. —3. Among the *Italians*, an assemblage of buildings, which by a happy disposition and elevation, represents an agreeable scene to the eye. —4. A place rising by steps or gradations like the seats of a theatre.

Shade above shade, a woody theatre  
Of stateliest view. *Milton.*

5. A place of action or exhibition; as, the *theatre* of the world. —6. A building for the exhibition of *scholastic* exercises, as at Oxford, or for other exhibitions. —*Anatomical theatre*, a hall with several rows of seats, disposed in the manner of an amphitheatre, and a table turning on a pivot in the middle, for anatomical demonstrations.

THEAT'RIC, } *a.* Pertaining to a  
THEAT'RICAL, } theatre or to scenic  
representations; resembling the manner of dramatic performers; as, *theatrical* dress; *theatrical* performances;

*theatrical* gestures.—2. Calculated for display; pompous; as, *theatrical* airs; a *theatrical* manner.

THEAT'RICALLY, *adv.* In the manner of actors on the stage; in a manner suiting the stage.

THEAT'RICALS, *n.* Dramatic performances.

THEAVE, } *n.* An ewe of the first year.  
THAVE, } [Local.]

THEBA'IA, } *n.* An alkaline base  
THE'BAINE, } found in opium. [See  
PARAMORPHIA.]

THE'BAN, *n.* A native of Thebes.—2. *a.* Relating to Thebes.

THE'BAN YEAR. In *chronology*, the same as the Egyptian year, which consisted of 365 days, 6 hours.

THE'CA, *n.* [L. from Gr. *θηνη*.] A sheath or hollow case. In *bot.*, the term *thecæ* is used to indicate the reproductive organs of ferns, or those minute capsules, which are aggregated into little masses called *sori*. In the Equisetaceæ it expresses the assemblage of cases which are attached to scales arranged in a conical manner; in Lycopodiaceæ, it is used to indicate the kidney-shaped two-valved cases that contain the reproductive matter; and in mosses, it expresses the organs that enclose the sporules.—2. In *anat.*, *thecæ* is applied to the strong fibrous sheaths in which certain soft parts of the body are enclosed; as the canal of the vertebral column, and the canals in which many of the long tendons of the muscles of the hand and foot run.

THE'CAPHORE, *n.* [Gr. *θηνη*, a case or cover, and *φερω*, to bear or carry.] In *bot.*, the roundish stalk upon which the ovary of some plants is elevated; as in the caper bush. It is also called podogynium and gynophore.

THECODAC'TYLS, *n.* [Gr. *θηνη*, and *δακτυλος*, a digit.] The name given by Cuvier to those geckos which have the toes widened throughout, and furnished beneath with transverse scales, divided by a deep longitudinal furrow, in which the claw may be entirely concealed.

THE'CODONTS, *n.* [Gr. *θηνη*, and *δων*, a tooth.] A tribe of extinct Saurian reptiles, distinguished by having the teeth implanted in sockets, either loosely, or confluent with the bony walls of the cavity. The thecodonts are the most ancient of all the squamate or scaly Saurians. The name Thecodontosaurus has been given to one of the genera belonging to this tribe; its remains were found in the dolomitic conglomerate of Redland, near Bristol.

THEECOSTOMES, *n.* [Gr. *θηνη*, and *στωμα*, a mouth.] Latreille's name for those insects which have a suctorial mouth enveloped in a sheath.

THEE, *pron. obj.* case of *Thou*. [Contracted from Sax. *thee*; Cimb. *thig*; Franc. *thee*; Goth. *thuk*. See THOU.]

THEE,† *v. i.* [Goth. *thihan*; Sax. *thean*.] To thrive; to prosper.

THEFT, *n.* [Sax. *thyfthe*. See THIEF.]

1. The act of stealing. In *jurisprudence*, the general name for the most ordinary class of offences against property, for which English law uses the term larceny. Simple larceny, or theft, is committed by wrongfully taking, against the will of the owner, and carrying away the goods of another, with the fraudulent and felonious intent wholly to deprive him of his property therein. Hence it requires an actual taking, and an actual carrying away for some distance, to constitute the

offence. Compound larceny, or theft, is when the theft is accompanied by aggravating circumstances; as, when it is committed upon the person, or consists in stealing from a dwelling house. Taking from the person in a violent manner is *robbery*, and stealing in a dwelling house after having broken therein is *burglary*. [See LARCENY.] In *Scots law*, theft is defined, "the intentional and clandestine taking away of the property of another, from its legitimate place of deposit, or other *locus tenendi*, with the knowledge that it is another's, and the belief that he would not consent to its abstraction; and with the intention of never restoring it to the owner." This distinction between the *infang thief*, or one taken while yet in sight, and the *outfang thief*, is now done away. But a distinction is still made between trifling theft or *pickery*, which is punishable with corporal punishment, imprisonment in bridewell, or fine, and theft properly so called. Simple theft is not punishable capitally unless of an aggravated character; as, theft under trust, when of a black description; the stealing of the larger animals, sheep included; theft to a great extent; theft by one habit and repute a thief; theft by breaking lockfast places, or by housebreaking.—2. The thing stolen; Exod. xxii.

**THEFT-BOTE**, *n.* [*theft* and Sax. *bote*, compensation.] In *law*, the receiving of a man's goods again from a thief; or a compensation for them, by way of composition, and to prevent the prosecution of the thief. This subjects a person to fine and imprisonment, as by this means the punishment of the criminal is prevented.

**THE'FORM**, *a.* Having the form of tea.  
**THE'INE**, *n.* [from *thea*, the generic name of the tea-plant.] A bitter crystallizable principle found in tea, and also in coffee, and some other plants. It forms fine white prisms of a silky lustre, which are soluble in water, alcohol, and ether, bitter, fusible, and volatile. It is considered to be the principle which gives to tea its refreshing and gently stimulating qualities, and is composed of 8 atoms carbon, 2 nitrogen, 5 hydrogen, and 2 oxygen. [See CAFFEINE.]

**THEIR**, *a. pronom.* [Sax. *hiora*; Ice. *theirra*.] 1. *Their* has the sense of a pronominal adjective, denoting of them, or the possession of two or more; as, *their voices*; *their garments*; *their houses*; *their land*; *their country*.—2. *Theirs* is used as a substitute for the adjective and the noun to which it refers, and in this case it may be the nominative to a verb. "Our land is the most extensive, but *theirs* is the best cultivated." Here *theirs* stands as the representative of *their land*, and is the nominative to *is*. Nothing but the name of zeal appears, 'Twixt our best actions and the worst of *theirs*. Denham.

In this use, *theirs* is not in the possessive case, for then there would be a double possessive.

**THE'ISM**, *n.* [from Gr. *θεος*, God.] The belief or acknowledgment of the existence of a God, as opposed to *atheism*. *Theism* differs from *deism*, for although *deism* implies a belief in the existence of a God, yet it signifies in modern usage a denial of revelation, which *theism* does not.

11.

**THE'IST**, *n.* One who believes in the existence of a God.

**THEIST'IC**, } a. Pertaining to  
**THEIST'ICAL**, } theism, or to a  
theist; according to the doctrine of  
theists.

**THELPHU'SIANS**, *n.* The name given by Milne Edwards to a tribe of brachyurous crustaceans, forming the passage between the cancerians and the land crabs. All the known species live in the earth near the banks of rivers, or in humid forests, bearing a strong analogy to the land crabs.

**THEM**, *pron.* the objective case of *They*, and of both genders. [In our mother tongue, *them* is an adjective, answering to *the*, in the dative and ablative cases of both numbers. The common people continue to use it in the plural number as an adjective, for they say, bring *them* horses, or *them* horses are to be led to water.]

Go ye to *them* that sell, and buy for yourselves; Matth. xxv.

Then shall the king say to *them* on his right hand, Come, ye blessed of my Father; Matth. xxv.

**THEME**, *n.* [L. *thema*; Gr. *θεμα*, from *τιθημι*, to set or place.] 1. A subject or topic on which a person writes or speaks; any thing proposed as a subject of discourse or discussion; a position or proposition. The preacher takes a text for the *theme* of his discourse.

When a soldier was the *theme*, my name Was not far off. Shak.

2. A short dissertation composed by a student on a given subject.—3. In *gram.*, a radical verb, or the verb in its primary absolute sense, not modified by inflections; as, the infinitive mode in English. But a large portion of the words called *themes* in Greek, are not the radical words, but are themselves derivative forms of the verb. The fact is the same in other languages.—4. In *music*, a series of notes selected as the text or subject of a new composition.

**THE'MIS**, *n.* [Gr.] In *Grecian myth.*, the goddess of law and order.

**THEM'SELVES**, a compound of *them* and *selves*, and added to *they* by way of emphasis or pointed distinction. Thus we say, *they themselves* have done the mischief; they cannot blame others. In this case, *themselves* is in the nominative case, and may be considered as an emphatical pronoun. In some cases, *themselves* is used without *they*, and stands as the only nominative to the following verb. *Themselves* have done the mischief. This word is used also in the objective case after a verb or preposition. Things in *themselves* innocent, may under certain circumstances cease to be so.

They open to *themselves* at length the way. Milton.

**THEN**, *adv.* [Goth. *thanne*; Sax. *thane*; G. *dann*; D. *dan*. See THENCE.] 1. At that time, referring to a time specified, either past or future.

And the Canaanite was *then* in the land; Gen. xii.

That is, when Abram migrated and came into Canaan.  
Now I know in part, but *then* shall I know even as I am known; 1 Cor. xii.

2. Afterward; soon afterward or immediately.

First be reconciled to thy brother, and *then* come and offer thy gift; Matth. v.

3. In that case; in consequence; Gal. iii.; Job iii.

If all this be so, *then* man has a natural freedom. Locke.

4. Therefore; for this reason.

Now *then* be all thy weighty cares away. Dryden.

5. At another time; as, now and *then*, at one time and another.—6. That time. Till *then* who knew

The force of those dire arms? Milton.  
*Then* is often used elliptically for the *then existing*; as, the *then* administration.

**THE'N'ARDITE**, *n.* Anhydrous sulphate of soda. It occurs in crystalline coatings at the bottom of some lakes about five leagues from Madrid. It is used in the preparation of carbonate of soda.

**THE'N'ARD'S BLUE**, *n.* Cobalt blue; a blue pigment prepared by digesting oxide of cobalt with nitric acid, and adding phosphate of soda, by which phosphate of cobalt is formed. This is mixed with gelatinous alumina, and the paste so formed is dried, and subjected to a cherry red heat, by which means the pigment is produced. [See COBALT.]

**THENCE**, *adv.* (thens.) [Sax. *thanan*, *thanon*; G. *dannen*; from *than*, *dann*, *then*, *supra*. *Then* signifies properly place, or set time, from *setting*, and *thence* is derived from it. So the Germans say, *von dannen*, from *thence*.] 1. From that place.

When you depart *thence*, shake off the dust of your feet; Mark vi.  
It is more usual, though not necessary, to use *from* before *thence*.

Then will I send and fetch *them* from *thence*; Gen. xxvii.

2. From that time.

There shall be no more *thence* an infant of days; Is. lxv.

3. For that reason.  
Not to sit idle with so great a gift  
Useless, and *thence* ridiculous about him. Milton.

**THENCEFORTH**, *adv.* (thens'forth.) [*thence* and *forth*.] From that time.

If the salt hath lost its savour, it is *thenceforth* good for nothing; Matth. v.

This is also preceded by *from*, though not from any necessity.

And from *thenceforth* Pilate sought to release him; John xix.

**THENCEFORWARD**, *adv.* [*thence* and *forward*.] From that time onward.

**THENCEFROM**,† *adv.* [*thence* and *from*.] From that place.

**THEOBROMA**, *n.* A genus of plants, nat. order Sterculiaceæ, the species of which yield the cacao, or cocoa, of commerce. They are trees with large simple leaves, and with the flowers in clusters, and are all of them natives of South America. The most important species is the *T. cacao*, the common cacao, or chocolate nut tree, which is indigenous in South America, but is extensively cultivated in the West Indies, and in the tropical parts of Asia and Africa. The capsules of the fruit are large, and contain each about 25 seeds; the pulp in which these are enveloped, has a sweet and not unpleasant taste, and is eaten by the natives. The cotyledons of the seeds contain a large quantity of oily albumen, which has an agreeable flavour, and on this account they are not only used as a principal article of diet by the natives of the countries in which they grow, but are now used for the

6 K

same purpose throughout the civilized world. The oil contained in the seeds is sometimes obtained separately, and called *cacao butter*. The seeds, reduced to a paste, and flavoured with honey, sugar, and certain other ingredients, constitute chocolate. [See CACAO.]

**THEOBROMINE**, *n.* A crystalline compound found in the seeds of *Theobroma cacao*. In composition it is analogous to theine or caffeine.

**THEOCRACY**, *n.* [Fr. *theocracie*; It. *teocrazia*; Sp. *teocracia*; Gr.  $\Theta\epsilon\omicron\varsigma$ , God, and  $\kappa\rho\alpha\tau\omicron\varsigma$ , power;  $\kappa\rho\alpha\tau\iota\omega$ , to hold.] Government of a state by the immediate direction of God; or the state thus governed. Of this species the Israelites furnish an illustrious example. The *theocracy* lasted till the time of Saul.

**THEOCRASY**, *n.* [Gr.  $\Theta\epsilon\omicron\varsigma$ , God, and  $\kappa\rho\alpha\sigma\iota\varsigma$ , mixture.] In ancient philosophy, the intimate union of the soul with God in contemplation, which was considered attainable by the newer Platonists.

**THEOCRATIC**, } *a.* Pertaining to  
**THEOCRATICAL**, } a theocracy;  
administered by the immediate direction of God; as, the *theocratical* state of the Israelites. The government of the Israelites was *theocratic*.

**THEODICÆA**, } *n.* [Gr.  $\Theta\epsilon\omicron\varsigma$ , and  
**THEODICY**, }  $\delta\iota\kappa\alpha\iota\omicron\varsigma$ , just.] A vindication of the dealings of Divine Providence with man; the title of a work published by Leibnitz in 1710, in which the doctrine of Optimism is maintained.

**THEODOLITE**, *n.* [Qu. Gr.  $\Theta\epsilon\omicron\delta\omicron\lambda\iota\tau\eta\varsigma$ , to view, and  $\delta\epsilon\lambda\epsilon\iota\varsigma$ , stratagem.] A most important surveying instrument for measuring horizontal angles, or the angular distances between objects projected on the plane of the horizon. This instrument is variously constructed, and provided with subordinate apparatus, according to the price, or the particular purposes to which it is to be applied. One of the most generally useful, consists of two concentric horizontal circular plates A and B, which turn freely on each other.

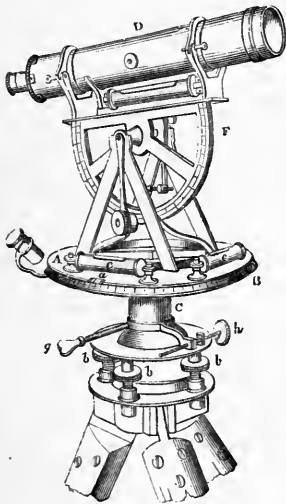

Theodolite.

The lower or graduated plate B, contains the divisions of the circle, and the

upper or vernier plate has two vernier divisions *a*, diametrically opposite, only one of which is shown in the cut. The vertical axis C, consists of two conical parts, the one working within the other. The external part is attached to the graduated plate B, and the internal to the vernier plate A. The plane of the circle is adjusted to the horizon by the screws *b*, *b*, *b*, acting against a plate of metal resting on the staff-head supporting the instrument. The vernier plate carries two spirit levels *c*, *c*, at right angles to each other, with their proper adjusting screws, by which the circle is brought accurately into the horizontal plane indicated by the levels. The horizontal axis of the vertical limb of the instrument is supported by a frame attached to the vernier plate, and turning along with it about the vertical axis. To the horizontal axis D, a telescope, with cross wires in its focus, is attached, which moves in the vertical plane, by the graduated circle E, and is used for observing the objects whose angular distance is to be measured, and also for taking altitudes, or measuring vertical angles, a spirit level is fixed beneath the telescope for its adjustment. F is a microscope for reading off the vernier divisions. The screws *g*, *h*, are for regulating and fixing the external part of the vertical axis C. To measure the angular distance between any two objects, the telescope is turned round along with the vernier circle, (the graduated circle remaining fixed,) until it is brought to bear exactly upon one of the objects; it is then turned round until it is brought to bear on the other object, and the arc which the vernier has described on the graduated circle, measures the angle required. The observation may be repeated any number of times in order to insure accuracy, by means of a repeating stand which turns round concentrically with the vertical axis of the theodolite. The theodolite is not only a most essential instrument in trigonometrical surveying for determining stations, and running base-lines, but also in geodetical operations, for assisting in determining the length of an arc of the meridian. For this latter purpose it requires to be constructed on a large scale.

**THEODO'SIAN**, *a.* Belonging to the emperor Theodosius; relating to his code of laws.

**THEOG'ONISM**,† *n.* Theogony, — which see.

**THEOG'ONIST**, *n.* A writer on theogony.

**THEOG'ONY**, *n.* [Fr. *theogonie*; Gr.  $\Theta\epsilon\omicron\gamma\omicron\gamma\iota\alpha$ :  $\Theta\epsilon\omicron\varsigma$ , God, and  $\gamma\omicron\gamma\eta$ , or  $\gamma\omicron\gamma\iota\mu\alpha\iota$ , to be born.] In *myth.*, the generation of the gods; or that branch of heathen theology which taught the genealogy of their deities. Hesiod composed a poem concerning that theogony, or the creation of the world and the descent of the gods.

**THEOL'OGASTER**, *n.* A kind of quack in divinity; as, a quack in medicine is called *medicaster*.

**THEOL'OGER**,† *n.* A theologist.

**THEOLO'GIAN**, *n.* [See THEOLOGY.] A divine; a person well versed in theology, or a professor of divinity.

**THEOLOG'IC**, } *a.* [See THEO-  
**THEOLOG'ICAL**, }  $\lambda\omicron\gamma\omicron\varsigma$ .] Pertaining to divinity, or the science of God and of divine things; as, a *theological* treatise; *theological* criticism.

**THEOLOG'ICALLY**, *adv.* According to the principles of theology.

**THEOL'OGICS**, *n. plur.* Theology, — which see. [A cant term.]

**THEOL'OGIST** *n.* A divine; one studious in the science of divinity, or one well versed in that science.

**THEOL'OGIZE**, *v. t.* To render theological.—2. *v. i.* To frame a system of theology. [Little used.]

**THEOL'OGIZED**, *pp.* Rendered theological.

**THEOL'OGIZER**, *n.* A divine, or a professor of theology. [Unusual.]

**THEOL'OGIZING**, *ppr.* Rendering theological.

**THE'OLOGUE**, for *Theologist*, is not in use.

**THEOL'OGY**, *n.* [Fr. *theologie*; It. and Sp. *teologia*; Gr.  $\Theta\epsilon\omicron\lambda\omicron\gamma\iota\alpha$ :  $\Theta\epsilon\omicron\varsigma$ , God, and  $\lambda\omicron\gamma\omicron\varsigma$ , discourse.] Divinity; the science of God and divine things; or the science which teaches the existence, character, and attributes of God, his laws and government, the doctrines we are to believe, and the duties we are to practise. Theology consists of two branches, *natural* and *revealed*. *Natural theology* is the knowledge we have of God from his works, by the light of nature and reason. Such as his existence and unity; that he is possessed of certain perfections, the signatures of which are perceptible upon his works; that he governs the world; that it is our duty to honour and please him, by the practice of piety, justice, and benevolence; that the soul of man is immortal; and that there is a future state, in which the righteous will be rewarded, and the wicked punished. The doctrines and truths, however, which natural theology professes to teach, are, when taken by themselves, unsuitable to the present circumstances of mankind, and altogether inadequate for those purposes for which such knowledge is needed by man. Natural theology holds forth no certain hope of pardon to the guilty, and in the present enfeebled and corrupt state of our moral powers, the duties which it prescribes are absolutely impracticable. Hence, the grand foundation of theology is revelation, to which natural religion is a valuable, but not necessary, auxiliary. *Revealed theology*, or *supernatural theology*, as it is sometimes called, is that which is to be learned only from revelation, or that which is founded entirely upon the canonical books of the Old and New Testament. It is also sometimes called *positive theology*, as being founded upon the expressed will of God. Theology is variously divided, according to the method of treating the subject, and the part of the subject which is treated.—*Popular* or *Biblical theology*, that which is derived from the obvious meaning of the letter of Scripture, without any external aid, having for its fundamental principle that the Scriptures are to be interpreted by each individual reader, according to the ordinary laws by which the meaning of any other book is ascertained. This is the Protestant system, and stands opposed to the Roman Catholic system, or the *positive system* as it is called.—*Systematic theology*, that which reduces the scattered truths of revelation to the scientific form of a connected system; it also comprehends the investigation and discussion of those truths.—*Essegetical*

*theology*, that which consists in the knowledge of the documents which contain the revelation, the proof of their authority, and the explanation of their meaning.—*Historical theology*, that which exhibits a history of the workings and changes of religion among those who have professed it.—*Practical theology*, that which has for its subject the duties of practical religion, and the various modes of enforcing them. It comprehends *Homiletics*, *Catechetics*, *Liturgics*, and *Pastoral theology*.—*Dogmatic theology*, the science of exhibiting clearly, and of tracing to their results, the doctrines taught by revelation. It aims at forming a system which shall be accepted as binding by a large body of religionists, and then views all religious truth in the light of that system. The term is chiefly employed by German writers.—*Moral theology* teaches us the divine laws relating to our manners and actions, that is, our moral duties.—*Speculative theology* teaches or explains the doctrines of religion, as objects of faith.—*Scholastic theology* is that which proceeds by reasoning, or which derives the knowledge of several divine things from certain established principles of faith.

**THEOM'ACHIST**, *n.* [Gr. *θεός*, God, and *μαχη*, combat.] One who fights against the gods.

**THEOM'ACHY**, *n.* [supra.] A fighting against the gods, as the battle of the giants with the gods.—2. Opposition to the divine will.

**THE'OMANCY**, *n.* [Gr. *θεός*, and *μαντια*, prophecy.] A species of prophecy in which a god himself was believed to reveal future events, as when any one consulted an oracle, among the heathen nations, the god himself was supposed to answer the inquirer.

**THEOPAS'CHITES**, *n.* [Gr. *θεός*, and *πασχω*, to suffer.] The name given to certain heretics of the fifth century, who maintained that Christ had but one nature, which was the divine, and consequently that divine nature suffered.

**THEOPATHET'IC**, *a.* Pertaining to theopathy.

**THEOPATH'IC**, *a.* Relating to theopathy.

**THEOP'ATHY**, *n.* [Gr. *θεός*, God, and *παθος*, passion.] Religious suffering; suffering for the purpose of subduing sinful propensities.

**THEOPH'ANY**, *n.* [Gr. *θεός*, and *φαινομαι*, to appear.] A term applied to signify the manifestations of God to man by actual appearance.

**THEOPHILANTHROP'IC**, *a.* [Gr.] Uniting love to God with that to man.

**THEOPHILANTHROPISM**, *n.* The love of God and man.

**THEOPHILANTHROPIST**, *n.* [Gr. *θεός*, God, and *φιλοανθρωπος*, a lover of men.] One who practises or professes theophilanthropism.—2. In *modern history*, the title *theophilanthropists* was assumed by a society formed at Paris during the first French revolution. It had for its object to establish a new religion in place of Christianity, which had been abolished by the convention. The system of belief thus attempted to be established was pure deism, and, as was to be expected, proved a failure.

**THE'OPNEUSTY**, *n.* [Gr. *θεός*, God, and *πνευσις*, breathing.] Divine inspiration.

**THEOR'BO** *n.* [It. *torba*; Fr. *tourbe*

or *teorbe*.] A musical instrument made like a large lute, except that it has two necks or juga, the second and longer of which sustains the four last rows of chords which are to give the deepest sounds. The theorbo has eight base or thick strings, twice as long as those of the lute, which excess of length renders the sound exceedingly soft, and continues it a great length of time. It was also called the *archlute*, and was used chiefly, if not only, as an accompaniment to the voice. It has long fallen into disuse.

**THE'OREM**, *n.* [Fr. *theoreme*; Sp. and It. *teorema*; Gr. *θεωρημα*, from *θεωρειν*, to see.] In *math.*, a proposition to be proved by a chain of reasoning; any proposition which states its conclusion or makes any affirmation or negation; as distinguished from a *problem*, which requires a conclusion to be arrived at, without so much as stating whether that conclusion is even possible. A *theorem* wants demonstration only; a *problem* requires solution, or the discovery both of method and demonstration.—2. A speculative truth; a position laid down as an acknowledged truth.—3. In *alge*, or *analysis*, it is sometimes used to denote a rule, particularly when that rule is expressed by symbols or formulæ; as, the binomial *theorem*, Taylor's *theorem*, &c.—A *universal theorem* extends to any quantity without restriction.—A *particular theorem* extends only to a particular quantity.—A *negative theorem* expresses the impossibility of any assertion.—A *local theorem* is that which relates to a surface.—A *solid theorem* is that which considers a space terminated by a solid, that is, by any of the three conic sections.

**THEOREMATIC**, } *a.* Pertaining  
**THEOREMATICAL**, } to a theorem;  
**THEOREM'IC**, } comprised in  
a theorem; consisting of theorems; as, *theoremic truth*.

**THEORET'IC**, } *a.* [Gr. *θεωρητικος*.  
**THEORETICAL**, } See **THEORY**.] Pertaining to theory; depending on theory or speculation; speculative; terminating in theory or speculation; not practical; as, *theoretical learning*; *theoretic sciences*. The sciences are divided into *theoretical*, as, theology, philosophy, and the like, and *practical*, as medicine and law.

**THEORETICALLY**, *adv.* In or by theory; in speculation; speculatively; not practically. Some things appear to be *theoretically* true, which are found to be practically false.

**THEORET'ICS**, *n. plur.* The speculative parts of a science.

**THE'ORIC**, *† n.* Speculation; theory.

**THEOR'IC**, *† n.* For *Theoretic*, is not now used. [See **THEORETIC**.]

**THEOR'ICA**, *n. plur.* [Gr. *θεορεικος*.] A term applied to the public moneys expended at Athens on festivals and in largesses.

**THEOR'ICAL**, *† a.* Theoretical.

**THEOR'ICALLY**, *† adv.* Speculatively.

**THEOR'IST**, *n.* One who forms theories; one given to theory and speculation.

The greatest *theorists* have given the preference to such a government as that of this kingdom. *Addition.*

**THE'ORIZE**, *v. i.* To form a theory or theories; to speculate; as, to *theorize* on the existence of phlogiston.

**THE'ORIZER**, *n.* A theorist.

**THE'ORIZING**, *ppr.* Forming a theory.

**THE'ORY**, *n.* [Fr. *theorie*; It. *teoria*;

L. *theoria*; Gr. *θεωρια*, from *θεωρειν*, to see or contemplate.] 1. Speculation; a doctrine or scheme of things, which terminates in speculation or contemplation, without a view to practice. It is here taken in an unfavourable sense, as implying something visionary.—2. An exposition of the general or abstract principles of any science; as, the *theory* of music.—3. The science distinguished from the art; as, the *theory* and practice of medicine.—4. In the *arts*, the rules of an art as distinguished from the practice; or the knowledge of an art, so far as results from speculation on its nature, on the end which it proposes to attain, on the means which it is necessary to employ in order to attain the end proposed, &c., without being occupied with its practice.—5. A collected view of all that is known on any speculative subject; a connected body of truths having a dependence on one another, and belonging to one or more common principles; or it is a connected arrangement of facts, according to their bearing on some real or hypothetical law.—In *physical science*, a theory is defined, "An explanation of natural phenomena, founded on facts known to be true from evidence independent of those phenomena or appearances. Thus, we have the *theory* of gravitation, the *atomic theory*, *theories* of light, *theories* of heat, *theory* of combustion, *lunar theory*, *theory* of dew, *theories* of the earth, &c. A theory is often nothing else but a contrivance for comprehending a certain number of facts under one expression. Many theories are founded entirely on analogy, and such theories may have all degrees of evidence from the least to the greatest. The evidence of a theory increases with the number of facts which it explains, and the precision with which it explains them. It diminishes with the number of facts which it does not explain, and with the number of different suppositions that will afford explanations equally precise. A theory may not deserve to be rejected because it does not explain all the phenomena, if it explains a great number, and be not absolutely inconsistent with any one, but a single fact inconsistent with any theory may be sufficient to overturn it. *Theory* is distinguished from *hypothesis* thus: a theory is founded on inferences drawn from principles which have been established on independent evidence; a hypothesis is a proposition assumed to account for certain phenomena, and has no other evidence of its truth, than that it affords a satisfactory explanation of those phenomena. It is necessary to keep this distinction in view, as the terms *theory* and *hypothesis* are very frequently confounded both in speaking and writing. The terms *theory* and *practice* are also often used in a very loose and inaccurate manner, and are liable to a very common fallacy, namely, that of applying to one sense of a word, ideas or associations derived from another. By *practice*, as distinguished from *theory*, is often meant the application of that knowledge which comes from experience only, and is not sufficiently connected with any general principles to be entitled to the name of a theory; but as there is no theorist whose knowledge is all theory, so there is no practical man whose skill is all derived from experience. [See **Sig. 1.**]

—*Theory of couples*, by couples in *physic* is meant a pair of equal and opposite forces not equilibrating each other, and the explanation or investigation of the phenomena or effects resulting from such forces is termed the *theory of couples*.—*Theory of equations*, that part of algebra which treats of the properties of rational and integral functions of a single variable, its great object being to develop the properties, and to evolve the values of the real and imaginary roots of equations of every degree.—*Theory of numbers*. [See NUMBER.]

**THEOSOPHIC**, } *a.* Pertaining to  
**THEOSOPHICAL**, } theosophism or  
to theosophists; divinely wise.

**THEOSOPHISM**, *n.* [Gr. *θεος*, God, and *σοφισμα*, comment; *σοφος*, wise.] Pretension to divine illumination; enthusiasm.

**THEOSOPHIST**, *n.* One who pretends to divine illumination; one who pretends to derive his knowledge from divine revelation.

**THEOSOPHIZE**, *v. i.* To treat of God or of divine things.

**THEOSOPHY**, *n.* Divine wisdom; godliness.—2. Knowledge of God derived from divine illumination; a supposed intercourse with God and superior spirits, by which a person acquires not only an intimate knowledge of God and of all divine truth, but obtains access to the most sublime secrets of nature, by physical processes. Such notions have been held by Jacob Böhme, Swedenborg, and others.

**THERAPEUTÆ**, *n.* [Gr. *θεραπευω*, to worship.] A Jewish sect of devotees, of the first century after Christ; so called from the extraordinary purity of their religious worship. They withdrew into solitary places, where they devoted themselves to a life of religious contemplation.

**THERAPEUTIC**, *a.* [Gr. *θεραπευτικος*, from *θεραπευω*, to nurse, serve, or cure.] Curative; that pertains to the healing art; that is concerned in discovering and applying remedies for diseases.

Medicine is justly distributed into prophylactic, or the art of preserving health, and *therapeutic*, or the art of restoring it.

*Watts.*

**THERAPEUTICS**, *n.* That part of medicine which relates to the composition, the application, and the modes of operation of the remedies for diseases. It not only includes medicines properly so called, but also hygiene and dietetics, or the application of diet, and atmospheric and other non-medical influences, to the preservation or recovery of health.—2. The Therapeutæ,—*which see.*

**THERAPY**, *n.* [Gr. *θεραπεια*.] Therapeutics.

**THERE**, *adv.* [Sax. *thar*; Goth. *thar*; D. *daar*; Sw. *där*; Dan. *der*.] This word was formerly used as a pronoun, as well as an adverb of place. Thus in Saxon, *thærto was to him, to her, or to it.* 1. In that place.

The Lord God planted a garden eastward in Eden, and *there* he put the man whom he had formed; Gen. ii.

2. It is sometimes opposed to *here*; *there* denoting the place most distant. Darkness *there* might well seem *twilight here*.

*Milton.*

3. *Here* and *there*, in one place and another; as, *here* a little and *there* a little.—4. It is sometimes used by way

of exclamation, calling the attention to something distant; as, *there, there*; see *there*; look *there*.—5. *There* is used to begin sentences, or before a verb; sometimes pertinently, and sometimes without signification; but its use is so firmly established that it cannot be dispensed with.

Wherever *there* is sense or perception, there some idea is actually produced.

*Locke.*

*There* have been that have delivered themselves from their ills by their good fortune or virtue. *Suckling.*

And *there* came a voice from heaven, saying, Thou art my beloved Son; Mark i. 6. In composition, *there* has the sense of a pronoun, as in Saxon; as *therēby*, which signifies by *that*.

**THEREABOUT**, } *comp.* [*there* and  
**THEREABOUTS**, } *about.* The latter is less proper, but most commonly used.]

1. Near that place.—2. Nearly; near that number, degree or quantity; as, ten men or *thereabouts*.—3. Concerning that. [*Not much used.*] Luke xxiv. **THEREAFTER**, *comp.* [*there* and *after*.] Sax. *thær-æfter*, after that.] 1. According to that; accordingly.

When you can draw the head indifferently well, proportion the body *thereafter*.

*Peachment.*

2. After that. **THEREAT**, *comp.* [*there* and *at*.] At that place.

Wide is the gate, and broad is the way, that leadeth to destruction, and many there are who go in *thereat*; Matth. vii.

2. At that; at that thing or event; on that account.

Every error is a stain to the beauty of nature; for which cause it blushest *thereat*.

*Hooker.*

**THEREBY**, *comp.* [*there* and *by*.] By that; by that means; and in consequence of that.

Acquaint now thyself with him, and be at peace; *thereby* good shall come to thee; Job xxii.

**THEREFOR**, *comp.* [*there* and *for*.] For that or this, or it.

**THEREFORE**, *comp.* (ther'fore.) [*there* and *for*.] 1. For that; for that or this reason, referring to something previously stated.

I have married a wife, and *therefore* I cannot come; Luke xiv.

2. Consequentially. He blushes; *therefore* he is guilty.

*Spectator.*

3. In return or recompense for this or that.

What shall we have *therefore*? Matt. xix.

**THEREFROM**, *comp.* [*there* and *from*.] From this or that.

Turn not aside *therefrom* to the right hand or to the left; Josh. xxiii.

**THEREIN**, *comp.* [*there* and *in*.] In that or this place, time, or thing.

Bring forth abundantly in the earth and multiply *therein*; Gen. ix.

Ye shall keep the sabbath...whosoever doeth any work *therein*...that soul shall be cut off; Exod. xxxi.

*Therein* our letters do not well agree.

*Shak.*

**THEREINTO**, *comp.* [*there* and *into*.] Into that.

**THEREOF**, *comp.* [*there* and *of*.] Of that or this.

In the day thou eatest *thereof*, thou shalt surely die; Gen. ii.

**THEREOLOGIST**, *n.* One versed in thereology. **THEREOLOGÏY**, *n.* [Gr. *θεω*, to meditate, and *λογος*, knowledge.] The study

of diseases, and the practice of medicine; the art of healing; therapeutics. **THEREON**, *comp.* [*there* and *on*.] On that or this.

Then the king said, Hang him *thereon*; Esth. vii.

**THEREOUT**, *comp.* [*there* and *out*.] Out of that or this; Lev. ii.

**THERETO**, } *comp.* [*there* and *to*.]  
**THEREUNTO**, } 'To that or this.

Add the fifth part *thereto*; Lev. v.

**THERETOFORE**, *adv.* Before that time; the counterpart of *heretofore*, or before this time. [*American, but useful.*]

**THEREUN'DER**, *comp.* [*there* and *under*.] Under that or this.

**THEREUPON**, *comp.* [*there* and *upon*.] Upon that or this.

The remnant of the house of Judah, they shall feed *thereupon*; Zeph. ii.

2. In consequence of that. He hopes to find you forward,

And *thereupon* he sends you this good news. *Shak.*

3. Immediately. **THEREWHILE**, } *comp.* [*there* and  
**WHILE**, } *while.*] At the same time.

**THEREWITH**, *comp.* [*there* and *with*.] With that or this.

I have learned in whatever state I am, *therewith* to be content; Phil. iv.

**THEREWITHAL**, *comp.* [*there* and *withal*.] Over and above.—2. At the same time.—3. With that. [*This word is obsolete.*] [The foregoing compounds of *there* with the prepositions, are for the most part deemed inelegant and obsolete. Some of them however are in good use, and particularly in the law style.]

**THERE'BREAD**, } *n.* (therf'bred. [Sax.  
**thærf**, **thærf**, unfermented.] Unleavened bread.

**THERIAC**, } *n.* [L. *theriaca*, Gr.  
**THERIACA**, } *θεριακον*, treacle.] A name given by the ancients to various compositions esteemed efficacious against the effects of poison, but afterward restrained chiefly to what has been called *Theriaca Andromachi*, or *Venice treacle*, which is a compound of sixty-four drugs, prepared, pulverized, and reduced by means of honey to an electuary.

**THERIAC**, } *a.* Pertaining to  
**THERIACAL**, } theriac; medicinal.

**THERM**, *n.* In *arch.*, a pedestal increasing upwards, for the reception of a bust.

**THERMÆ**, *n. plur.* [L. from Gr. *θερμο*, warm.] In ancient *arch.*, the name given to the public baths, which contained not only the warm baths, but also the cold.

**THERMAL**, *a.* [L. *thermæ*, warm baths; Gr. *θερμαι*, from *θεω*, to warm.] Pertaining to heat; warm.—*Thermal waters*, or springs, are warm or tepid mineral waters, which occur in various parts of the world. The range of temperature of the thermal springs in Europe is from 66° to 165°.

**THERMIDOR**, *n.* [Fr. from G. *θερμο*, warm.] The name of the 11th month of the year, in the first French republic. It commenced on the 19th of July, and ended on the 17th of August.

**THERMO-ELECTRIC**, *a.* Pertaining to thermo-electricity; as, *thermo-electric currents*.

**THERMO-ELECTRICITY**, *n.* Electricity developed by heat; a branch of electro-magnetism. When wires or bars of metal of different kinds are placed in close contact, end to end, and

disposed so as to form a periphery or continuous circuit, and heat there applied to the ends or junctions of the bars, electric currents are produced. The electricity thus developed is termed *thermo-electricity*.

**THERMOGEN**, *n.* [Gr. *θεῖον*, heat, and *γενεῖν*, *γενναῖν*, to generate.] The elementary matter of heat; calorific.

**THERMO LAMP**, *n.* [Gr. *θεῖον*, warm, from *θεῖον*, heat, and *lamp*.] An instrument for furnishing light by means of inflammable gas.

**THERMOMETER**, *n.* [Gr. *θεῖον*, warm, from *θεῖον*, heat, and *μετρον*, measure.] An instrument for measuring heat, or by which the temperatures of bodies are ascertained; founded on the property which heat possesses of expanding all bodies, the rate or quantity of expansion being supposed proportional to the degree of heat applied, and hence indicating that degree. The thermometer consists of a slender glass tube, with a small bore, containing in general mercury or alcohol, which expanding or contracting by variations in the temperature of the atmosphere, or on the instrument being brought into contact with any other body, or immersed in a liquid or gas, which is to be examined, the state of the atmosphere, the body, liquid, or gas, with regard to heat, is indicated by a scale either applied to the tube, or engraven on its exterior surface. There are several kinds of thermometers, but the one in common use in this country is Fahrenheit's, so called from the name of the inventor. It consists of a small tube, terminating in a ball containing mercury, the air having been expelled, and the tube hermetically sealed. There are two points on the scale, corresponding to fixed and determinate temperatures; the first corresponds to the temperature of freezing water, and is marked 32°, the other corresponds to the temperature of boiling water, and is marked 212°; hence, the zero of the scale, or that point marked 0°, is 32° below the freezing point, and the interval or space between the freezing and boiling points consists of 180°. On the Continent, particularly in France, the centigrade thermometer is used. The space between the freezing and boiling points is divided into 100 equal parts or degrees, the zero being at freezing, and the boiling point at 100°.

Reaumur's thermometer, which is in use in Germany, has the space between the freezing and boiling points divided into 80 equal parts, the zero being at freezing. The following formulae, deduced from the manner in which the three scales are divided, will serve to convert any given number of degrees of Fahrenheit's scale into the corresponding number of degrees on Reaumur's, and the centigrade scales, and vice versa: Let F, R, and C, represent any corresponding numbers of degrees on the three scales respectively, then;  $(F - 32°) \times \frac{4}{9} = R$ , and  $(F - 32°) \times \frac{9}{5} = C$ ;  $\frac{4}{9} \times R + 32° = F$ , and  $\frac{9}{5} \times C + 32 = F$ ; Also,  $\frac{4}{9} \times C = R$ , and  $\frac{5}{9} \times R = C$ . For extreme degrees of cold, thermometers filled with spirit of wine must be employed, as no degree of cold known is capable of freezing that liquid, whereas mercury freezes at about 39° below zero. On the other hand, spirit of wine is not adapted to high temperatures, as it is soon converted into vapour, whereas mercury

does not boil till its temperature is raised to 660°. Of all fluids, mercury is the best adapted for thermometers employed for indicating all ordinary temperatures.—*Register thermometer*. [See REGISTER.]—*Differential thermometer*. [See DIFFERENTIAL.] The thermometer indicates only the *sensible* heat of bodies, and gives us no information respecting the quantity of latent heat, or of combined heat, which those bodies may contain.

**THERMOMETRICAL**, *a.* Pertaining to a thermometer; as, the *thermometrical* scale or tube.—2. Made by a thermometer; as, *thermometrical* observations.

**THERMOMETRICALLY**, *adv.* By means of a thermometer.

**THERMOSCOPE**, *n.* [Gr. *θεῖον*, heat, and *σκοπεῖν*, to see.] An instrument showing the temperature of the air, or the degree of heat and cold; a thermometer contrived by Count Rumford, for measuring minute differences of temperature. The same name was at first given to Leslie's differential thermometer.

**THERMOSCOPIC**, *a.* Pertaining to the thermoscope.

**THERMOSTAT**, *n.* [*θεῖον*, and *στατος*, standing.] An apparatus contrived by Dr. Ure, for regulating temperature in the processes of distillation and vaporization, in baths, hot houses, in adjusting the heat of stoves and furnaces, &c. It operates upon the principle that when two thin metallic bars of different degrees of expansibility are riveted or soldered face ways together, any change of temperature will cause the compound bar to bend, the side on which the least expansible bar is becoming concave, and the other convex. These flexures are made to operate in regulating valves, stop-cocks, stove registers, &c., and thereby to regulate the flow of heated liquids, or the admission or emission of air.

**THERMOSTATIC**, *a.* Pertaining to the thermostat.

**THERMOTENSION**, *n.* [Gr. *θεῖον*, hot, and *L. tensio*, a stretching.] *Literally*, a stretching by heat. This word is applied by Professor Johnson to a process of increasing the direct cohesion of wrought iron. It consists in heating the metal to a determinate temperature, generally from 500° to 600°, of Fahrenheit, and in that state giving to it, by appropriate machinery, a mechanical strain or tension, in the direction in which the strain is afterwards to be exerted. The degree of tensile force applied is determined beforehand by trials on the same quality of metal at the ordinary temperature, in order to ascertain what force would, in that case, have been sufficient to break the piece which is to be submitted to thermotension.

**THESAURUS**, } *n.* [Lat.] A  
**THESAURARIUM**, } treasury. *Thesaurus verborum*, a treasury of words; a lexicon.

**THESE**, *pron. plur. of This*: pronounced *theez*, and used as an adjective or substitute. *These* is opposed to *those*, as *this* is to *that*, and when two persons or things or collections of things are named, *these* refers to the things or persons which are nearest in place or order, or which are last mentioned.

Some place the bliss in action, some in ease; *These* call it pleasure, and contentment *these*. Pope.

Here *these* is a substitute for *these persons*, and for the persons last mentioned, who place their bliss in ease.

**THE'SIS**, *n.* [L. *thesis*; Gr. *θεσις*, a position, from *τιθεῖν*, to set.] 1. A position or proposition which a person advances and offers to maintain, or which is actually maintained by argument; a theme; a subject propounded for a school or college exercise; the exercise itself.—2. In *logic*, every proposition may be divided into *thesis* and *hypothesis*. *Thesis* contains the thing affirmed or denied, and hypothesis the conditions of the affirmation or negation.—3. In *music*, the unaccented part of the measure, which the Greeks expressed by the downward beat.

**THE'SIUM**, *n.* A genus of plants of the class Pentandria, and order Monogynia, Linn, nat. order Santalaceæ. The species are small weeds, scentless, and slightly astringent. *T. linophyllum*, or bastard toad-flax, is a British plant, which grows in elevated pastures.

**THES' MOTHETE**, *n.* [Gr.] A lawyer.

**THESPE'SIA**, *n.* A genus of plants, nat. order Malvaceæ. The species are trees with large entire leaves. *T. populnea*, or the umbrella tree, is a



*Thespesia populnea*.

native of the East Indies, Guinea, and the Society Islands. It grows to the height of about 40 feet, and has large yellow flowers, with a dark red centre. In tropical countries it is planted about monasteries and convents, and hence it is looked upon with a sort of religious regard.

**THES'PIAN-ART**, *n.* A name given to tragedy or tragic acting, from *Thespis*, an Athenian, who first introduced tragedy on the stage, about 600 years before Christ.

**THE'TA**, *n.* [Gr. θ.] The unlucky letter of the Greek alphabet, so called from being used by the judges in passing condemnation on a prisoner, it being the first letter of the Greek *θανατος*, death.

**THET'ICAL**, *a.* [from Gr. *θεσις*. See *THESIS*.] Laid down.

**THE'TIS**, *n.* In *Grecian myth*, the daughter of Nereus, and Doris, and hence one of the Nereids. She was married to Peleus, king of the Myrmidons, and became the mother of Achilles. *Thetis* was a symbol of water in the ancient cosmogonies.

**THEUR'GIC**, } *a.* [from *theurgy*.]  
**THEUR'GICAL**, } Pertaining to the power of performing supernatural things.—*Theurgic hymns*, songs of incantation.

**THE'URGIST, n.** One who pretends to or is addicted to theurgy.  
**THE'URGY, n.** [Gr. *θεουργία*: *θεός*, God, and *εργον*, work.] The art of doing things which it is the peculiar province of God to do; or the power or act of performing supernatural things by invoking the names of God or of subordinate agents; magic. This has been divided by some writers into three parts; *theurgy*, or the operation by divine or celestial means; *natural magic*, performed by the powers of nature; and *necromancy*, which proceeds by invoking demons.  
**THEW, n.** [Sax. *theow*; Gr. *θεός*.] 1. † Manner; custom; habit; form of behaviour.—2. † Brawn; muscle; sinew; strength.  
**THEW'ED, † a.** Accustomed; educated.  
**THEWS, n. pl.** Bodily robustness; proportions indicating corporeal strength.  
**THEY, pron. plur.** objective case, *Them*. [Sax. *thæge*; Goth. *thai*, *thaim*.] 1. The men, the women, the animals, the things. It is never used adjectively, but always as a pronoun referring to persons, or as a substitute referring to things.  
*They* and their fathers have transgressed against me; Ezek. ii.  
*They* of Italy salute you; Heb. xiii.  
 Blessed are *they* who hunger and thirst after righteousness; Matth. v.  
 2. It is used indefinitely, as our ancestors used *man*, and as the French use *on*. *They* say, [on dit], that is, it is said by persons, indefinitely.  
**THI'A, n.** The name given by Leach to a genus of crustaceans, belonging to the family Oxystomes. They live buried in the sand at a small distance from the sea-shore. *T. polia*, is found in the British channel, and the Mediterranean.  
**THI'BET, } a. Of or belonging to**  
**THI'BE'TIAN, } Thibet, in Asia; as,**  
*Thibet shawls*.  
**THI'BLE, † n.** A slice; a skimmer; a spatula. It is the same as the Scottish *thibel*, a stick for stirring a pot of broth, pottage, &c.  
**THICK, a.** [Sax. *thick*, *thicca*; G. *dick*, *dicht*; Sw. *tioch*; Dan. *tyk* and *dygt*, thick, tight; Gael. and Ir. *tugh*; W. *tew*, contracted. The sense is probably taken from driving, forcing together, or pressing.] 1. Dense; not thin; as, *thick vapours*; a *thick fog*.—2. Inspissated; as, the paint is *too thick*.—3. Turbid; muddy; feculent; not clear; as, the water of a river is *thick* after a rain.—4. Noting the diameter of a body; as, a piece of timber seven inches *thick*.  
 My little finger shall be *thicker* than my father's loins; 1 Kings xii.  
 5. Having more depth or extent from one surface to its opposite than usual; as, a *thick plank*; *thick cloth*; *thick paper*.—6. Close; crowded with trees or other objects; as, a *thick forest* or wood; *thick grass*; *thick corn*.  
 The people were gathered *thick* together. *Locke*.  
 7. Frequent; following each other in quick succession. The shot flew *thick* as hail.  
 Favours came *thick* upon him. *Wotton*.  
 Not *thicker* billows beat the Libyan main. *Dryden*.  
 8. Set with things close to each other; not easily pervious.  
 Black was the forest, *thick* with beech it stood. *Dryden*.  
 9. Not having due distinction of syllables or good articulation; as, a *thick utter-*

*ance*. He speaks *too thick*.—10. Dull; somewhat deaf; as, *thick* of hearing.—11. Intimate; [various dialects.]  
**THICK, n.** The thickest part, or the time when any thing is thickest.  
 In the *thick* of the dust and smoke he presently entered his men. *Knolles*.  
 2. † A thicket. *Thick* and *thin*, whatever is in the way.  
 Through *thick* and *thin* she follow'd him. *Hudibras*.  
**THICK, adv.** Frequently; fast.  
 I hear the trampling of *thick* beating feet. *Dryden*.  
 2. Closely; as, a plat of ground *thick* sown.—3. To a great depth, or to a thicker depth than usual; as, a bed covered *thick* with tan; land covered *thick* with manure. *Thick* and *three-fold*, in quick succession, or in great numbers. [Not in use.]  
**THICK, † v. i.** To become thick or dense.  
**THICKEN, v. t.** (thik' n.) [Sax. *thiccian*.] 1. To make thick or dense.—2. To make close; to fill up interstices; as, to *thicken* cloth.—3. To make concrete; to inspissate; as, to *thicken* paint, mortar or a liquid.—4. To strengthen; to confirm.  
 And this may help to *thicken* other proofs. † *Shak*.  
 5. To make frequent, or more frequent; as, to *thicken* blows.—6. To make close, or more close; to make more numerous; as, to *thicken* the ranks.  
**THICKEN, v. i.** (thik' n.) To become thick or more thick; to become dense; as, the fog *thickens*.—2. To become dark or obscure.  
 Thy lustre *thickens*  
 When he shines by. *Shak*.  
 3. To concrete; to be consolidated; as, the juices of plants *thicken* into wood.—4. To be inspissated; as, vegetable juices *thicken*, as the more volatile parts are evaporated.—5. To become close, or more close or numerous.  
 The press of people *thickens* to the court. *Dryden*.  
 6. To become quick and animated.  
 The combat *thickens*. *Addison*.  
 7. To become more numerous; to press; to be crowded. Proofs of the fact *thicken* upon us at every step.  
**THICK'ENED, pp.** Made dense, or more dense; made more close or compact; made more frequent; inspissated.  
**THICK'ENING, ppr.** Making dense or more dense, more close, or more frequent; inspissating.  
**THICK'ENING, n.** Something put into a liquid or mass to make it more thick.  
**THICK'ER, a. comp.** More thick.  
**THICK'EST, a. superl.** Most thick.  
**THICK'ET, n.** A wood or collection of trees or shrubs closely set; as, a ram caught in a *thicket*; Gen. xxii.  
**THICK'HEAD, } a. Having a thick**  
**THICK'HEADED, } skull; dull; stupid.**  
**THICK'ISH, a.** Somewhat thick.  
**THICK'LY, adv.** Deeply; to a great depth.—2. Closely; compactly.—3. In quick succession.  
**THICK'NESS, n.** The state of being thick; denseness; density; as, the *thickness* of fog, vapour, or clouds.—2. The state of being concrete or inspissated; consistency; spissitude; as, the *thickness* of paint or mortar; the *thickness* of honey; the *thickness* of the blood.—3. The extent of a body from side to side, or from surface to surface; as, the *thickness* of a tree; the *thickness* of a board; the *thickness* of the hand; the *thickness* of a layer of earth.

—4. Closeness of the parts; the state of being crowded or near; as, the *thickness* of trees in a forest; the *thickness* of a wood.—5. The state of being close, dense or impervious; as, the *thickness* of shades.—6. Dulness of the sense of hearing; want of quickness or acuteness; as, *thickness* of hearing.  
**THICK-RIBBED, † a.** Closely run together, or close ridged; as, *thick-ribbed* ice.  
**THICK'SET, a.** [*thick* and *set*.] Close planted; as, a *thicket* wood.—2. Having a short thick body.  
**THICK'SKIN, n.** [*thick* and *skin*.] A coarse gross person; a blockhead.  
**THICK'SKULL, n.** [*thick* and *skull*.] Dulness; or a dull person; a blockhead.  
**THICK'SKULLED, a.** Dull; heavy; stupid; slow to learn.  
**THICK'SPRUNG, a.** [*thick* and *sprung*.] Sprung up close together.  
**THIEF, n. plur. Thieves.** [Sax. *theaf*; Sw. *tiuf*; D. *dief*; G. *dieb*; Goth. *thiubs*; Dan. *tyv*.] A person guilty of theft. 1. One who secretly, unlawfully, and feloniously takes the goods or personal property of another. The *thief* takes the property of another privately; the robber by open force.—2. One who takes the property of another wrongfully, either secretly or by violence; Job xxx.  
 A certain man went down from Jerusalem to Jericho, and fell among *thieves*, who stripped him of his raiment; Luke x.  
 3. One who seduces by false doctrine; John x.—4. One who makes it his business to cheat and defraud; as, a den of *thieves*; Matth. xxi.—5. An excrescence or waster in the snuff of a candle.  
**THIEF-CATCHER, n.** [*thief* and *catch*.] One who catches thieves, or whose business is to detect thieves and bring them to justice.  
**THIEF-LEADER, n.** [*thief* and *lead*.] One who leads or takes a thief. [Not much used.]  
**THIEF-TAKER, n.** [*thief* and *taker*.] One whose business is to find and take thieves and bring them to justice.  
**THIEVE, v. i.** [from *thief*.] To steal; to practice theft.  
**THIEVE'LESS, } a. Unprofitable, in-**  
**THEW'LESS, } active; cold; dry;**  
 insipid; spoken of a person's demeanour. [*Scotch*.]  
**THIEVERY, n.** The practice of stealing; theft. [See *THEFT*.]  
 Among the Spartans, *thievery* was a practice morally good and honest. *South*.  
 2. That which is stolen.  
**THIEVISH, a.** Given to stealing; addicted to the practice of theft; as, a *thievish* boy.  
 Or with a base and boist'rous sword enforce  
 A *thievish* living on the common road. *Shak*.  
 2. Secret; sly; acting by stealth; as, *thievish* minutes.—3. Partaking of the nature of theft; as, a *thievish* practice.  
**THIEVISHLY, adv.** In a thievish manner; by theft.  
**THIEVISHNESS, n.** The disposition to steal.—2. The practice or habit of stealing.  
**THIG, v. t.** [Ancient German, *thigen*, to ask.] To ask; to beg; to go about receiving supply, not as a mendicant, but rather as affording others an opportunity of manifesting their liberality. [*Scotch*.]  
**THIGH, n.** [Sax. *thegh*, *theo* or *theoh*; D. *dye*; G. *dich-bein*, thick-bone. The



## THIN

German explains the word; *thigh* is *thick*.] The *femur*, that part of men, quadrupeds, and fowls, which is between the leg and the trunk. As the word signifies, it is the thick part of the lower limbs.

**THIGH-BONE**, *n.* The *femoris os*, a long cylindrical bone which is situated between the pelvis and tibia.

**THILK**, † *pron.* [Sax. *thilk*.] The same.

**THILL**, *n.* [Sax. *thil* or *thill*.] The shaft of a cart, gig, or other carriage. The thills are the two pieces of timber extending from the body of the carriage on each side of the last horse, by which the carriage is supported in a horizontal position.

**THILLER**, } *n.* The horse which  
**THILL-HORSE**, } goes between the  
thills or shafts, and supports them.  
In a team, the last horse.

**THIMBLE**, *n.* [Originally *thumb-bell* or *cover*, having been first worn on the thumb, as the sailor's *thimble* still is; Scotch, *thumle*.] 1. A kind of cap or cover for the finger, usually made of metal, used by tailors and seamstresses for driving the needle through cloth.—2. In sea language, an iron ring with a hollow or groove round its whole circumference, to receive the rope which is spliced about it.

**THIMBLEFUL**, *n.* [*thimble* and *full*.] As much of any thing as a thimble would hold.—2. A very small quantity. [Familiar.]

**THIMBLERIG**, *n.* A sleight of hand trick played with three small cups, shaped like thimbles, and a small ball.

**THIMBLE RIGGER**, *n.* One who practises the game of thimbleric.—2. In cant language, a low trickster.

**THIME**. See **THYME**.

**THIN**, *a.* [Sax. *thinn*, *thynn*; *G. dünn*; Sw.  *tunn*; W. *tenau*, *teneu*; L. *tenuus*; Gaelic, *tanadh*; Russ. *tonket*. Qu. Gr. *στενω*, narrow. It appears to be connected with W. *ten*, *tan*, stretched, extended, Gr. *τενω*. Qu. Ar. *wadana*.] In sense it is allied to Syr. Heb. Ch. and Eth. קטן, *katan*, but we know not whether the first consonant of this word is a prefix. 1. Having little thickness or extent from one surface to the opposite; as, a *thin* plate of metal; *thin* paper; a *thin* board; a *thin* covering.—2. Rare; not dense; applied to fluids or soft mixtures; as, *thin* blood; *thin* milk; *thin* air.

In the day when the air is more *thin*.

Bacon.

3. Not close; not crowded; not filling the space; not having the individuals that compose the thing in a close or compact state; as, the trees of a forest are *thin*; the corn or grass is *thin*. A *thin* audience in church is not uncommon. Important legislative business should not be transacted in a *thin* house.—4. Not full or well grown.

Seven *thin* ears; *Slender*.

5. Slim; small; slender; lean. A person becomes *thin* by disease. Some animals are naturally *thin*.—6. Exile; small; fine; not full.

*Thin* hollow sounds, and lamentable screams.

Dryden.

7. Not thick or close; of a loose texture; not impervious to the sight; as, a *thin* veil.—8. Not crowded or well stocked; not abundant.

Ferrara is very large, but extremely *thin* of people.

Addison.

9. Slight; not sufficient for a covering; as, a *thin* disguise.

## THING

**THING**, *adv.* Not thickly or closely; in a scattered state; as, seed sown *thin*.

Spain is *thin* sown of people. Bacon.

**THING**, *v. t.* [Sax. *thinnian*; Russ. *tonyu*; L. *tenuo*. See **ATTENUATE**.] 1. To make thin; to make rare or less thick; to attenuate; as, to *thin* the blood.—2. To make less close, crowded, or numerous; as, to *thin* the ranks of an enemy; to *thin* the trees or shrubs of a thicket.—3. To attenuate; to rarefy; to make less dense; as, to *thin* the air; to *thin* the vapours.—*Thin* out, in *geol.*: when strata gradually diminish in thickness until they disappear, they are said to *thin* out.

**THIN-CLAD**, *a.* Lightly dressed.

**THINE**, *pronominal adj.* [Goth. *theins*, *theina*; Sax. *thin*; G. *dein*; Fr. *tien*; probably contracted from *thigen*. See **THOU**.] *Thy*; belonging to thee; relating to thee; being the property of thee. It was formerly used for *thy*, before a vowel.

Then thou mightest eat grapes *thy* fill, at *thine* own pleasure; Deut. xxxii.

But in common usage, *thy* is now used before a vowel in all cases. The principal use of *thine* now is when a verb is interposed between this word and the noun to which it refers. I will not take any thing that is *thine*. *Thine* is the kingdom, and the glory. In the following passage *thine* is used as a substitute for *thy righteousness*.

I will make mention of *thy righteousness*, even of *thine* only; Ps. lxxi.

In some cases it is preceded by the sign of the possessive case, like nouns, and is then also to be considered as a substitute.

If any of *thine* be driven out to the utmost parts of heaven; Deut. xxx.

It is to be observed that *thine*, like *thou*, is used only in the solemn style. In familiar and common language, *your* and *yours* are always used in the singular number as well as the plural.

**THIN-FACED**, *a.* Having a meagre or attenuated visage.

**THING**, *n.* [Sax. *thing*, a thing, a cause; for his *thingon*, for his cause or sake; also, *thing* and *gething*, a meeting, council or convention; *thingan*, *thingian*, to hold a meeting, to plead, to supplicate; *thingere*, an intercessor; *thingung*, intercession; G. *ding*, a thing, a court; *dingen*, to go to law, to hire or haggle; Dingstag, Tuesday, [*thing's day*]; *beding*, condition, clause; *bedingen*, to agree, to bargain or contract, to cheapen; D. *ding*, thing, business; *dingen*, to plead, to attempt, to cheapen; *dingbank*, the bar; *dingdagen*, session-days; *dingen*, *dingster*, a pleader; *dingtaal*, plea; *Dingsdag*, Tuesday; *beding*, condition, agreement; *bedingen*, to condition; Sw. *ting*, thing, cause, also a court, assizes; *tinga*, to hire, bargain, or agree; Dan. *ting*, a thing, affair, business, case, a court of justice; *tinger*, to strike up a bargain, to haggle; *tingbog*, records of a court, [*thing-book*]; *tingdag*, the court day, the assizes; *tinghold*, jurisdiction; *tingmænd*, jurors, jury, [*thing-men*]; *tingsag*, a cause or suit at law, [*thing-sake*]. The primary sense of *thing* is that which comes, falls, or happens, like *event*, from L. *evento*. The primary sense of the root, which is *tig* or *thig*, is to press, urge, drive, or strain, and hence its application to courts, or suits at law; a seeking of right. We observe that *Dingsdag*, *Dingdag*, in some of the dialects

## THINK

signifies *Tuesday*, and this from the circumstance that that day of the week was, as it still is in some states, the day of opening courts; that is, *litigation day*, or *suitors' day*, a day of striving for justice; or perhaps *combat-day*, the day of trial by battle. This leads to the unfolding of another fact. Among our ancestors, *Tig* or *Tiig*, was the name of the deity of combat and war, the Teutonic Mars; that is, strife, combat deified. This word was contracted into *tie* or *tu*, and hence *Tiwes-dæg* or *Tues-dæg*, Tuesday, the day consecrated to *Tiig*, the god of war. But it seems this is merely the day of commencing court and trial; *litigation day*. This *Tiig*, the god of war, is *strife*, and this leads us to the root of *thing*, which is to drive, urge, strive. So *res*, in Latin, is connected with *res*, accused. For words of like signification, see **SAKE** and **CAUSE**.] 1. An event or action; that which happens or falls out, or that which is done, told, or proposed. This is the general signification of the word in the Scriptures; as, after these *things*, that is, events.

And the *thing* was very grievous in Abraham's sight, because of his son; Gen. xxi.

Then Laban and Bethuel answered and said, The *thing* proceedeth from the Lord; Gen. xxiv.

And Jacob said, All these *things* are against me; Gen. xlii.

I will tell you by what authority I do these *things*; Matth. xxi.

These *things* said Esaias when he saw his glory; John xii.

In learning French, choose such books as will teach you *things* as well as language.

Jay to Littlepage.

2. Any substance; whatever is distinct, or conceived to be distinct, from one's self, and from other intelligent beings; that which is created; any particular article or commodity.

He sent after this manner; ten asses laden with the good *things* of Egypt; Gen. xlii.

They took the *things* which Micah had made; Judges xviii.

3. An animal; as, every living thing; every creeping thing; Gen. i. [*This application of the word is improper, but common in popular and vulgar language*.]—4. A portion or part; something.

Wicked men who understand any thing of wisdom. Tillotson.

5. In contempt.

I have a *thing* in prose. Swift.

6. Used of persons in contempt.

See, sons, what *things* you are. Shak.

The poor *thing* sigh'd. Addison.

I'll be this abject *thing* no more. Granville.

7. Used in a sense of honour.

I see thee here,

Thou noble *thing*! Shak.

8. *Things*, in colloq. lan., clothes; accoutrements; what one carries about with him.

**THINK**, *v. i.* pret. and pp. *Thought*, pron. *thaut*. [Sax. *thincan*, *thencan*; Goth. *thaghtyan*; D. *denken*, to think, and *gedagt*, thought; G. *denken*, to think, and *gedächtniss*, remembrance; *gedanke*, thought; *nachdenken*, to ponder or meditate; Gr. *δύω*: Syr. and Ch. *ܕܝܟ*, allied to L. *duco*. We observe *n* is casual, and omitted in the participle *thought*. The sense seems to be to set in the mind, or to draw out, as in meditation.] 1. To have the

mind occupied on some subject; to have ideas, or to revolve ideas in the mind.

For that I am  
I know, because I think. *Dryden.*  
These are not matters to be slightly thought on. *Tillotson.*

2. To judge; to conclude; to hold as a settled opinion. I think it will rain tomorrow. I think it not best to proceed on our journey.

Let them marry to whom they think best; Numb. xxxvi.  
3. To intend.

Thou thought'st it to help me. *Shak.*  
I thought to promote thee to great honour; Numb. xxiv.

4. To imagine; to suppose; to fancy.  
Edmund, I think, is gone  
In pity of his misery, to dispatch  
His nighted life. *Shak.*  
Let him that thinketh he standeth, take heed lest he fall; 1 Cor. x.

5. To muse; to meditate.  
While Peter thought on the vision; Acts x.  
Think much, speak little. *Dryden.*

6. To reflect; to recollect or call to mind.  
And when Peter thought thereon, he wept; Mark xiv.

7. To consider; to deliberate. Think how this thing could happen.  
He thought within himself, saying, What shall I do? Luke xii.

To presume.  
Think not to say within yourselves, We have Abraham to our father; Matth. iii.

9. To believe; to esteem.—To think on or upon, to muse on; to meditate on.  
If there be any virtue, if there be any praise, think on these things; Phil. iv.

2. To light on by meditation. He has just thought on an expedient that will answer the purpose.—3. To remember with favour.

Think upon me, my God, for good; Neh. v.  
To think of, to have ideas come into the mind. He thought of what you told him. I would have sent the books, but I did not think of it.—To think well of, to hold in esteem; to esteem.

THINK, v. t. To conceive; to imagine. Charity thinketh no evil; 1 Cor. xiii.

2. To believe; to consider; to esteem. Nor think superfluous others' aid. *Milton.*

3. To seem or appear, as in the phrases, *me thinketh* or *methinks*, and *methought*. These are genuine Saxon phrases, equivalent to *it seems to me*, *it seemed to me*. In these expressions, *me* is actually in the dative case; almost the only instance remaining in the language. Sax. "*genoh thukt*," *satis visum est*, it appeared enough or sufficient; "*me thincth*," *mihi videtur*, it seems to me; I perceive.—To think much, to grudge. He thought not much to clothe his enemies. *Milton.*

To think much of, to hold in high esteem.—To think scorn, to disdain; Esth. iii.

THINK'ER, n. One who thinks; but chiefly, one who thinks in a particular manner; as, a close thinker; a deep thinker; a coherent thinker.

THINK'ING, ppr. Having ideas; supposing; judging; imagining; intending; meditating.—2. a. Having the faculty of thought; cogitative; capable of a regular train of ideas. *Mau* is a thinking being.

THINK'ING, n. Imagination; cogitation; judgment.

I heard a bird so sing,  
Whose music, to my thinking, pleas'd the king. *Shak.*

THINK'INGLY, adv. By thought.  
THIN'-LIPPED, a. Having thin lips.

THIN'LY, adv. [from *thin*.] In a loose, scattered manner; not thickly; as, ground thinly planted with trees; a country thinly inhabited.

THIN'NED, ppr. Made thin; made rare or less thick.

THIN'NER, a. comp. of *Thin*.—n. One who thins, or makes thin.

THIN'NESS, n. The state of being thin; smallness of extent from one side or surface to the opposite; as, the thinness of ice; the thinness of a plate; the thinness of the skin.—2. Tenuity; rareness; as, the thinness of air or other fluid.—3. A state approaching to fluidity, or even fluidity; opposed to *spissitude*; as, the thinness of honey, of white wash, or of paint.—4. Exility; as, the thinness of a point.—5. Rareness; a scattered state; paucity; as, the thinness of trees in a forest; the thinness of inhabitants.

THIN'NING, ppr. Making thin, rare, or less thick; attenuating.

THIN'NING, n. In arboriculture, the operation of reducing the number of plants or trees which have been sown or planted, in order that those which remain may attain a more mature growth. Natural woods are also thinned for the same purpose. It is a principle in *thinning*, that the branches of no tree should be allowed to touch those of another tree.

THIN'-SKINNED, a. Having a thin skin; hence, unduly sensitive.

THIONU'RATE, n. A compound formed by the union of thionuric acid with a base; as *thionurate* of ammonia; *thionurate* of lime.

THIONU'RIC ACID, n. An acid discovered by Wöhler and Liebig. It is formed by the action of sulphurous acid on Alloxan. It is a bibasic acid, crystallizable, but very soluble, and contains the elements of 1 equivalent of alloxan, 1 of ammonia, and 2 of sulphurous acid. Its most striking character is, that when its solution is heated, it becomes turbid from the deposition of a new compound *uramile*; and in the liquid there is found sulphuric acid, which was not previously present.

THIOSIN'NAMINE, n. An organic base obtained from oil of mustard, when mixed with ammonia. It is crystalline, bitter, soluble in hot water, alcohol, and ether. It combines with acids, but its salts do not crystallize.

THIR, pron. These. [Scotch.]

THIRD, a. (thurd.) [Sax. *thrida*; Goth. *thridya*; G. *dritte*; D. *derde*; Sw. and Dan. *trede*; Fr. *tiers*; L. *tertius*; Gr. *εγρος*: W. *trydy*.] The first after the second; the ordinal of three. The third hour in the day, among the ancients, was nine o'clock in the morning.—*Third estate*, in the British nation, is the commons; or in the legislature, the house of commons.—*Third order*, among the Romanists, is a sort of religious order that observes the same rule and the same manner of life, in proportion as some other two orders previously instituted; as, the *third order* of Franciscans, instituted by St. Francis in 1221.—*Third point* or *terce point*, in architecture, the point of section in the vertex of an equilateral triangle.—*Third coat*, in arch., the stucco when painting is to be used, or the setting for the reception of paper.—*Third rate*, in navies. A

third rate ship carries from 64 to 72 guns.—*Third sound*, in music. [See the noun, *Third*.]

THIRD, n. (thurd.) The third part of any thing. A man takes land and tills it for one third of the produce; the owner taking two thirds.—2. The sixtieth part of a second of time.—3. In music, an interval containing three diatonic sounds; the major composed of two tones, called by the Greeks diatone, and the minor called hemiditone, consisting of a tone and a half; or, the major third comprises inclusively five semitones; the minor, only four.

THIRDBOROUGH, n. (thurd'burro.) [third and borough.] An under constable.

THIRD'INGS, n. The third year of the corn or grain growing on the ground at the tenant's death, due to the lord for a heriot, within the manor of Turfat in Herefordshire.

THIRD'LY, adv. In the third place.

THIRL, v. t. (thurl.) [Sax. *thirlan*.] To bore; to perforate. It is now written *drill* and *thrill*. [See these words, and see *NOSTRIL*.]

THIRL, v. t. [Sax. *thrael*; Suio-Goth. *trael*; a bond servant.] To enslave; to thrall; to bind or subject to; to bind or restrict by the terms of a lease or otherwise; to grind at a certain mill.—2. To thrill. [Scotch.]

THIRL, n. In Scots law, a term used to denote those lands the tenants of which were bound to bring all their grain to a certain mill.

THIRLAGE, n. (thurl'age.) [See *THIRL*.] In Scots law, a species of servitude, formerly very common in Scotland, and also prevalent in England, by which the proprietors or other possessors of lands were bound to carry the grain produced on the lands to a particular mill to be ground, to which mill the lands were said to be *thirled* or *stricted*, and also to pay a certain proportion of the grain, varying in different cases, as a remuneration for the grinding, and for the expense of the erection and maintenance of the mill. The principal duty chargeable in thirlage was *multure*, which consisted of a proportion varying from about  $\frac{1}{8}$  to about  $\frac{1}{2}$  of the grain carried, or of the meal or flour ground, deliverable to the miller or other possessor of the mill under the proprietor, or to the proprietor or superior himself. There were also smaller duties of *knaveship*, *bannock*, *lock* and *gowpen*, called *scuels*, [see these terms.] which fell to the servants of the mill, according to the particular usage of each mill. This kind of servitude having become, in many cases, exceedingly oppressive, has fallen into disuse, an annual payment in grain or in money being substituted for it.

THIRST, n. (thurst.) [Sax. *thurst*, *thyrst*; G. *durst*; Dan. *törst*, from *tör*, dry; *törrest*, to dry, L. *torreo*, Sw. *torka*.]

1. A painful sensation of the throat or fauces, occasioned by the want of drink. Water is the proper object of this sensation or desire, although man, owing to disposition or his artificial mode of life, often satisfies it with other liquids. By satisfying thirst the body is provided with the quantity of water necessary for the repair of its tissues, and the maintenance of their proper moisture, and for the replacement of the fluid constantly lost by perspiration and other discharges. If

thirst be long unallayed it produces one of the most dreadful states which man can be compelled to endure. Thirst is a common symptom of febrile and other diseases.

Wherefore is it that thou hast brought us out of Egypt, to kill us and our children and our cattle with *thirst*? Exod. xvii.

2. A vehement desire of drink; Ps. civ.—3. A want and eager desire after any thing.

- |                                |                   |
|--------------------------------|-------------------|
| <i>Thirst of worldly good.</i> | <i>Fairfax.</i>   |
| <i>Thirst of knowledge.</i>    | <i>Milton.</i>    |
| <i>Thirst of praise.</i>       | <i>Granville.</i> |
| <i>Thirst after happiness.</i> | <i>Cheyne.</i>    |

But *for* is now more generally used after *thirst*; as, a *thirst* for worldly honours; a *thirst* for praise.—4. Dryness; drought.

The rapid current, through veins  
Of porous earth with kindly *thirst* uprawn,  
Rose a fresh fountain. *Milton.*

THIRST, v. i. (thurst.) [Sax. *thyrstan*; G. *dursten*; Sw. *törsta*.] 1. To experience a painful sensation of the throat or fauces, for want of drink.

The people *thirsted* there for water; Exod. xvii.

2. To have a vehement desire for any thing.

My soul *thirsteth* for the living God; Ps. xlii.

THIRST, v. t. To want to drink; as, to *thirst* blood. [Not English.]

THIRST'ER, n. One who thirsts.

THIRST'ILY, adv. In a thirsty manner.

THIRST'INESS, n. [from *thirsty*.] The state of being thirsty; thirst.

THIRSTING, *ppr.* Feeling pain for want of drink; having eager desire.

THIRST'Y, a. [from *thirst*.] Feeling a painful sensation of the throat or fauces, for want of drink.

Give me a little water, for I am *thirsty*; Judges iv.

I was *thirsty*, and ye gave me no drink. Matt. xxv.

2. Very dry; having no moisture; parched.

The *thirsty* land shall become springs of water; Is. xxxv.

3. Having a vehement desire of any thing; as, in blood-*thirsty*; Is. xlii, lxv.

THIRTEEN, a. (thur'teen.) [Sax. *threotigne*; *three* and *ten*; Sw. *tretton*; G. *dreyzehn*; D. *dertien*.] Ten and three; as, *thirteen* times.

THIR'TEEN, n. The number which consists of ten and three.

THIRTEENTH, a. (thur'teenth.) [supra.] The third after the tenth; the ordinal of thirteen; as, the *thirteenth* day of the month.

THIRTEENTH, n. (thur'teenth.) In music, an interval forming the octave of the sixth, or sixth of the octave.

THIRTIETH, a. (thur'tieth.) [from *thirty*; Sax. *thrittigotha*.] The tenth threefold; the ordinal of thirty; as, the *thirtieth* day of the month.

THIRTY, a. (thur'ty.) Sax. *thrittig*; G. *dreissig*; D. *dertig*.] Thrice ten; ten three times repeated; or twenty and ten. The month of June consists of *thirty* days. Joseph was *thirty* years old when he stood before Pharaoh.—*Thirty years' war*, in *hist.*, a series of wars carried on between the Protestant and Roman Catholic leagues in Germany in the first half of the 17th century.

THIR'TY, n. The number which consists of three times ten.

THIS, *definitive adjective, or substitute.*

plur. *These*. [Sax. *this*; Dan. plur. *disse*; G. *das, dessen*; D. *deez, dit*.] 1. *This* is a definitive, or a definitive adjective, denoting something that is present or near in place or time, or something just mentioned. Is *this* your younger brother? What trespass is *this* which ye have committed?

Who did sin, *this* man or his parents, that he was born blind? John ix.

When they heard *this*, they were pricked to the heart; Acts ii.

In the latter passage, *this* is a substitute for what had preceded, viz., the discourse of Peter just delivered. In like manner, *this* often represents a word, a sentence, or clause, or a series of sentences or events. In some cases, it refers to what is future, or to be immediately related.

But know *this*, that if the good man of the house had known in what watch the thief would come, he would have watched, and would not have suffered his house to be broken up; Matt. xxiv.

Here *this* refers to the whole subsequent member of the sentence.—2. *By this*, is used elliptically for *by this time*; as, *by this* the mail has arrived.—

3. *This* is used with words denoting time past; as, I have taken no snuff for *this* month; and often with plural words. I have not wept *this* forty years. In this case, *this*, in the singular, refers to the whole term of time, or period; *this period* of forty years.—

4. *This* is opposed to *that*.

*This* way and *that* the wav'ring sails they bend. *Pope.*

A body of *this* or *that* denomination is produced. *Boyle.*

*This* and *that*, in this use, denote difference indefinitely.—5. When *this* and *that* refer to different things before expressed, *this* refers to the thing last mentioned, and *that* to the thing first mentioned. [See THESE.]

Their judgment in *this* we may not, and in *that* we need not, follow. *Hooker.*

6. *This* is sometimes opposed to *other*.

Consider the arguments which the author had to write *this*, or to design the *other*, before you arraign him. *Dryden.*

THISTLE, n. (this'l.) [Sax. *thistel*; G. and D. *distel*; Sw. *tistel*.] The common name of prickly plants of the genus *Carduus*, a genus belonging to the class Syngenesia, and order Polygamia equalis, Linn.; nat. order Compositæ. It consists of upwards of 30 species, most of which are inhabitants of Europe; as the musk thistle (*C. nutans*); milk thistle (*C. marianus*); walted thistle (*C. acanthoides*); slender-flowered thistle (*C. tenuiflorus*).

The name thistle is also given to numerous prickly plants belonging to other genera; as the spear-thistle (*Cnicus lanceolatus*); field thistle (*Cnicus arvensis*), a well-known plant, very troublesome to the farmer. The cotton thistle belongs to the genus *Onopordum*; the common cotton-thistle (*O. acanthium*) attains a height of from four to six feet. It is cultivated in Scotland as the Scotch thistle, but it is doubtful whether the thistle which constitutes the national badge has any existing type. The carline thistle belongs to the genus *Carlina*; the blessed thistle is the *Centaurea benedicta*; and the star-thistle is the *Centaurea calcitrapa*. The sow-thistle belongs to the genus *Sonchus*, and the globe-thistle to the genus

*Echinops*. Some species of the thistle are admitted into gardens, where they form a pretty variety for borders. Thistles sow themselves extensively by means of their winged seeds, and hence they are great pests to the farmer.—*Order of the Thistle*, an ancient Scottish order of knighthood, sometimes called the order of St. Andrew. The date of its institution is not known, but it was revived by James V. of Scotland in 1540, again by James VII. of Scotland and II. of England in 1687, and a third time in 1703 by Queen Anne, who increased the number of knights to twelve, and placed the order on a permanent footing. In 1827, the number of knights was permanently extended to sixteen. The decorations of the order consist of a collar of enamelled gold, composed of sixteen thistles, interlaced with sprigs of rue, fastened to the mantle by a white riband; a small golden image of St. Andrew suspended from the collar; a gold medal having an image of St. Andrew within a circle, containing the motto of the order, "*Nemo me impune lacessit*," (no one provokes me with impunity); a thistle; a green riband to which the medal is attached, and a star which is worn on the left shoulder. The thistle, as is well known, is the national emblem of Scotland, and the national motto is the same as that of the order of the thistle.

THIS'TLE-CROWN, n. A gold coin of James I. king of England.

THIS'TLE-FINCH, † n. The goldfinch.

THISTLY, a. (this'ly.) Overgrown with thistles; as, *thistly* ground.

THITHER, adv. [Sax. *thider*, *thider*.] 1. To that place; opposed to *hither*.

This city is near, O let me escape *thither*; Gen. xix.

Where I am, *thither* ye cannot come; John vii.

2. To that end or point.—*Hither and thither*, to this place and to that; one way and another.

THITHERTO, † adv. To that point; so far.

THITHERWARD, adv. [*thither* and *ward*.] Toward that place.

They shall ask the way to Zion with their faces *thitherward*; Jer. i.

THIT'LING, † n. A hamlet.

THLAS'PI, n. Shepherd's purse, or bastard cress, a genus of European plants. The common shepherd's purse of the waysides belongs to the genus *Capsella*.

THLASPID'EÆ, n. A tribe of plants of the nat. order Cruciferae, having for its type the genus *Thlaspi*.

THO', a contraction of *Though*. [See THOUGH.]—2. † *Tho*, for Sax. *thonne*, then.

THOLE, n. [Sax. *thol*; Ir. and Gael. *dula*, a pin or peg.] 1. A pin inserted into the gunwale of a boat, to keep the oar in the rowlock, when used in rowing.—2. The pin or handle of a scythe.

THOLE, v. t. [Sax. *tholian*; G. and D. *dulden*; Sw. *töla*; L. *tollo, tolero*.] To bear; to endure; to undergo; to allow; to wait; to expect. [Scotch.]

THOLE, v. i. [supra.] To wait. [Scotch.]

THOLE, } n. [L. *tholus*.] In ancient THOLUS, } *arch.*, a dome or cupola; any circular building.

THOL'OBATE, n. [Gr. *tholos*, a covered roof, and *basis*, basis.] In *arch.*, the substructure on which a dome rests.

THOMÆAN, } *n.* One belonging to  
THOMITE, } a church of early  
Christians, said to have been founded,  
on the Malabar coast of India, by St.  
Thomas.

THOMASISM, } *n.* The doctrine of St.  
THOMISM, } Thomas Aquinas with  
respect to predestination and grace.

THOMIST, *n.* A follower of Thomas  
Aquinas, in opposition to the Scotists.

THOMSONITE, *n.* [from *Thomson*.]  
A mineral of the zeolite family, from  
Dumbarton, occurring generally in  
masses of a radiated structure, and of  
a glassy or vitreous structure. It  
consists of silica, alumina, and lime,  
with some soda, and 14 per cent. of  
water.

THONG, *n.* [Sax. *thwang*.] A strap of  
leather, used for fastening any thing.  
And nails for loosened spears, and *thongs*  
for shields provide. *Dryden*.

THOR, *n.* In *Scandinavian myth*, the  
son of Odin and Freya, and the divinity  
who presided over all mischievous  
spirits that inhabited the elements.  
He was also the Jupiter of the ancient  
Germans, and worshipped as the god  
of thunder. He was represented as  
an old man with a long beard, a crown  
with diverging rays, dressed in a long  
garment, holding in his right hand a  
sceptre with a lily, and having around  
his head a circle of stars. *Thursday*  
(day of Thor) has its name from him.

THORACIC, *a.* [L. *thorax*, the breast.]  
Pertaining to the breast; as, the *tho-  
racic* arteries. The *thoracic duct* is  
the trunk of the absorbent vessels. It  
runs up along the spine from the re-  
ceptacle of the chyle to the left sub-  
clavian vein, in which it terminates.

THORACICS, *n. plur.* In *ichthyology*,  
the name given by Linnæus to an order  
of bony fishes, respiring by means of  
gills only, the character of which is  
that the bronchia are ossiculated, and  
the ventral fins are placed underneath  
the *thorax*, or beneath the pectoral  
fins. It comprehends the flounders,  
turbot, mackerel, &c.

THORAL, *a.* [L. *torus*.] Pertaining to  
a bed.

THORAX, *n.* [L.] In *anat.*, the chest  
or that part of the body situated be-  
tween the neck and the abdomen,  
which contains the pleura, lungs,  
heart, œsophagus, thoracic duct, &c.  
The thorax or chest is divided by ima-  
ginary lines into certain regions, viz.,  
the right and left *humeral*, the right  
and left *subclavian*, the right and left  
*mammary*, the right and left *axillary*,  
the right and left *sub-axillary*, the  
right and left *scapulary*, the right and  
left *intra-scapulary*, and the right and  
left *subscapulary*.—2. In *entom.*, the  
second segment of insects; that part of  
the body between the head and the  
abdomen.—3. A breastplate, cuirass, or  
corselet.

THORIA, } *n.* A white earthy sub-  
THORINA, } stance, obtained by  
Berzelius, in 1828, from the mineral  
called thorite, of which it constitutes  
53 per cent. It is an oxide of *thori-  
num*; and when pure is a white pow-  
der, without taste, smell, or alkaline  
reaction on litmus. Its specific gravity  
is 9.4. It is insoluble in all acids  
except the sulphuric.

THORITE, *n.* [from *Thor*, the Scan-  
dinavian deity.] A massive and com-  
pact mineral, found in Norway, in  
syenite, and resembling gadolinite. It  
is of a black colour, and contains

about 53 per cent. of thorina, mixed  
with 13 metallic and other bodies.

THORIUM, } *n.* The metallic base  
THORIUM, } of thoria, discovered  
by Berzelius. It is in the form of a  
heavy metallic powder, and has an  
iron-grey tint. It burns in air or oxy-  
gen, when heated, with great splendour,  
and is converted into thorina or oxide  
of thorium. It unites energetically  
with chlorine, sulphur, and phosphorus.  
Hydrochloric acid readily dissolves it,  
with the evolution of hydrogen gas.

THORN, *n.* [Sax. *thorn*; G. *dorn*;  
Dan. *torne*; Slav. *tern*; W. *draen*.  
Qu. is not the latter contracted from  
the Gaelic *draegham*?] 1. A tree or  
shrub armed with sharp ligneous  
shoots, which consist of abortive and  
indurated twigs; as the black-thorn,  
white-thorn, saw-thorn, buck-thorn,  
&c. [See CRATÆGUS.] The word is  
sometimes incorrectly applied to a  
bush with prickles; as, a rose on a  
thorn.—2. A sharp ligneous or woody  
shoot from the stem of a tree or shrub;  
a sharp process from the woody part  
of a plant; an abortive or imperfectly  
developed twig, which has assumed a  
hard texture and terminates in a sharp  
point. *Thorns* or *spines* must not be  
confounded with *prickles*; the former  
are continuous with the woody tissue  
of the plant, while the latter are  
merely attached to the surface of the  
bark. Thorns are in fact modified  
branches or leaves, while prickles are  
indurated hairs. In common usage,  
thorn is applied to the prickle of the  
rose, and in fact the two words are  
used promiscuously.—3. Any thing  
troublesome. St. Paul had a *thorn* in  
the flesh; 2 Cor. xii.; Num. xxxiii.—  
4. In *scrip.*, great difficulties and im-  
pediments.

I will hedge up thy way with *thorns*;  
Hos. ii.

5. Worldly cares; things which pre-  
vent the growth of good principles;  
Matt. xiii.

THORN-APPLE, *n.* [*thorn* and *apple*.]  
A plant of the genus *Datura*; a popu-  
lar name of the *Datura Stramonium*.  
[See DATURA.]

THORN-BACK, *n.* [*thorn* and *back*.]  
A fish, a species of Ray, the *Raja cla-  
vata*. It is distinguished by the short

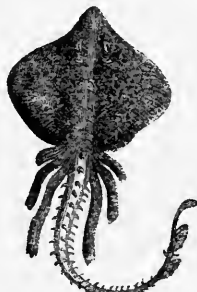

Thornback (*Raja clavata*).

and strong recurved spines, which are  
scattered over the back and tail. It  
grows to about two feet long, is very  
voracious, feeding on small flounders,  
herrings, sand-eels, crabs, lobsters, &c.  
It is common on the British and Irish  
coasts. Great quantities are taken  
every year, and the flesh is considered  
to be excellent food. The female is  
in Scotland called the *maiden-skate*.

THORN-BUSIL, *n.* A shrub that pro-  
duces thorns.

THORN-BUT, *n.* A fish, a but or  
turbot.

THORN-HEDGE, *n.* [*thorn* and  
*hedge*.] A hedge or fence consisting  
of thorn.

THORNLESS, *a.* Destitute of thorns;  
as, a *thornless* shrub or tree.

THORN-SET, *a.* Set with thorns.

THORNY, *a.* Full of thorns or spines;  
rough with thorns; as, a *thorny* wood;  
a *thorny* tree; a *thorny* diadem or  
crown.—2. Troublesome; vexatious;  
harassing; perplexing; as, *thorny*  
care; the *thorny* path of vice.—3.  
Sharp; pricking; vexatious; as, *thorny*  
points.

THORNY REST-HARROW, *n.* A  
plant of the genus *Ononis*, the *O. ar-  
vensis*. [See ONONIS.]

THORNY-TREFOIL, *n.* A plant of  
the genus *Fagonia*, the *F. trifolium*.

THOROUGH, *a.* (thur'ro.) [Sax. *thurh*;  
G. *durch*; D. *door*. In these languages,  
the word is a preposition; but as a pre-  
position we write it *through*. See *this*  
*word*. It is evidently from the root of  
*door*, which signifies a passage, and  
the radix of the word signifies to pass.]  
1. Literally, passing through or to the  
end; hence, complete; perfect; as, a  
*thorough* reformation; *thorough* work;  
a *thorough* translator; a *thorough* poet.  
—2. Passing through; as, *thorough*  
lights in a house.—*Thorough framing*,  
in *arch.*, an old term for the framing  
of doors and windows.—*Thorough*  
*lighted rooms*, rooms which have win-  
dows on opposite sides.

THOROUGH, *prep.* (thur'ro.) From  
side to side, or from end to end.—  
2. † By means of. [See THROUGH.]

THOROUGH, *n.* (thur'ro.) An inter-  
furrow between two ridges.

THOROUGH, *n.* In *British hist.*, a  
word used in the reign of Charles 1.  
by Wentworth, earl of Stafford, in his  
confidential correspondence. He em-  
ployed it to express the scheme he  
meditated for subverting the liberties  
of his countrymen and making Charles  
an absolute monarch.

THOROUGH-BASE, } *n.* (thur'ro-  
THOROUGH-BASS, } base or bass.)  
[*thorough* and *base* or *bass*.] In *music*,  
the art of playing on keyed instru-  
ments and according to the rules of  
harmony, an accompaniment from  
figures being placed either over or  
under the notes of the instrumental  
base staff. The figures used in tho-  
rough base are the nine units. These  
represent certain intervals or sounds.  
The same name is given to the accom-  
paniment itself as well as to the art of  
playing it.

THOROUGH-BRED, *a.* (thur'ro-bred.)  
[*thorough* and *bred*.] 1. Completely  
taught or accomplished.—2. Produced  
by parents of full blood on both sides;  
as, a *thorough-bred* horse.

THOROUGH-FARE, *n.* (thur'ro-fare.)  
[*thorough* and *fare*.] 1. A passage  
through; a passage from one street or  
opening to another; an unobstructed  
way.—2. Power of passing.

THOROUGH-GOING, *a.* Going all  
lengths.

THOROUGHLY, *adv.* (thur'roly.)  
Fully; entirely; completely; as, a  
room *thoroughly* swept; a business  
*thoroughly* performed. Let the matter  
be *thoroughly* sifted. Let every part  
of the work be *thoroughly* finished.

**THOROUGHNESS**, *n.* (thur'roness.) Completeness; perfectness.

**THOROUGH-PACED**, *a.* (thur'ropaced.) [*thorough* and *paced*.] Perfectly trained; perfect in what is undertaken; complete; going all lengths; as, a *thorough-paced* tory or whig.

**THOROUGH-PIN**, *n.* A disease in horses, which consists of enlarged mucous capsules growing on each side of the hocks.

**THOROUGH-SPED**, *a.* (thur'ro-sped.) [*thorough* and *sped*.] Fully accomplished; thorough-paced.

**THOROUGH-STITCH**, *adv.* (thur'ro-stitch.) [*thorough* and *stitch*.] Fully; completely; going the whole length of any business. [*Not elegant*.]

**THOROUGH-WAX**, *n.* (thur'ro-wax.) [*thorough* and *wax*.] A plant of the genus *Bupleurum*, the *B. rotundifolium*, called also hair's ear. [See **HAIR'S EAR**.]

**THOROUGH-WÖRT**, *n.* (thur'ro-wort.) The popular name of a plant, the *Eupatorium perfoliatum*, a native of North America. It is also known by the name of *Boneset*. An infusion of the heads of the flowers, and part of the plant in boiling water, is applied medicinally in cases of rheumatism and rheumatic fevers, and also for relieving colds. It is also employed as an emetic and purgative. [See **EUPATORIUM**.]

**THORPE**, } *Sax. thorpe*; *D. dorp*; *G. Thorpe*, } *dorf*; *Sw. and Dan. torp*; *W. trev*; *Gael. Ir. treabh*; *L. tribus*. The word in Welsh signifies a dwelling place, a homestead, a hamlet, a town. When applied to a single house, it answers to the *Sax. ham*, a house, whence *hamlet* and *home*. In the Teutonic dialects, it denotes a village. The primary sense is probably a house, a habitation, from fixedness; hence a hamlet, a village, a tribe; as in rude ages the dwelling of the head of a family was soon surrounded by the houses of his children and descendants. In our language it occurs now only in names of places and persons.

**THOUS**, } *n.* A name given to the Thoa  
**THOUS**, } group of dogs, which is a kind intermediate between the wolf, the fox, and the jackal, of all of whose natures it somewhat partakes. The thous are larger than a jackal; they do not burrow, and are marked on the back by black and white colours, the



Thous Dog of Senegal.

rest of the fur being in general ochrey buff. Among the different species are the *Thous Anthus*, or *canis anthus*, the wild dog of Egypt, *T. variegatus*, Nubian thous, *T. mesomelas*, Cape jackal, *T. senegalensis*, Senegal thous or jackal, &c.

**THOSE**, *pron.* (*s as z*), plur. of *That*; as, *those men*; *those temples*. When *those* and *these* are used in reference to two

things or collections of things, *those* refers to the first mentioned, as *these* does to the last mentioned. [See **THESE**, and the example there given.]

**THOTH**, *n.* An Egyptian divinity whom the Greeks considered to be identical with Mercury. He was regarded as the inventor of writing and



Thoth, from a bronze in the British Museum.

Egyptian philosophy, and is represented as a human figure with the head of a lamb or ibis.

**THOU**, *pron.* in the obj. *Thee*, plur. *Ye* or *You*. [*Sax. thu*; *G. Sw. and Dan. du*; *L. Fr. It. Sp. Port. and Russ. tu*; *Sans. tuam*. The nominative case is probably contracted, for in the oblique cases it is in *Sw. and Dan. dig*, in *Goth. thuk*, *Sax. thec*. So in Hindoo, *tu* in the nominative, makes in the dative, *tuko*; *Gipsy, tu, tuke*. In *Russ.* the verb is *tukayu*, to thou. The second personal pronoun, in the singular number; the pronoun which is used in addressing persons in the solemn style.

Art thou he that should come; *Matt. xi. I will fear no evil, for thou art with me*; *Ps. xxxiii.*

*Thou* is used only in the solemn style, unless in very familiar language, and by the Quakers. [See **YE** and **YOU**.]

**THOU**, *v. t.* To treat with familiarity. If thou *thouest* him some thrice, it shall not be amiss. *Shak.*

**THOU**, *v. i.* To use *thou* and *thee* in discourse.

**THOUGH**, *v. i.* (tho.) [*Sax. theah*; *Goth. thauh*; *G. doch*; *Sw. dock*; *D. and Dan. dog*. This is the imperative of a verb; *Ir. daighim*, to give, *D. dokhen*.] 1. Grant; admit; allow. "If thy brother be waxen poor—thou shalt relieve him; yea, *though* he be a stranger." *Grant* or *admit* the fact that he is a stranger, yet thou shalt relieve him; *Lev. xxv.*

*Though* he slay me, yet will I trust in him; *Job xlii.*

That is, *grant* or *admit* that he shall slay me, yet will I trust in him.

*Though* hand join in hand, the wicked shall not be unpunished; *Prov. xi.*

That is, *admit* the fact that the wicked unite their strength, yet this will not save them from punishment.

Not that I so affirm, *though* so it seem. *Milton.*

That is, *grant* that it seems so, yet I do not so affirm.—2. Used with *as*.

In the vine were three branches, and it was *as though* it budded; *Gen. xl.*

So we use *as if*; it was *as if* it budded; and *if is given*, give. The appearance was like the real fact *if* admitted or true.—3. It is used in familiar language, at the end of a sentence.

A good cause would do well *though*.

*Dryden.*

This is generally or always elliptical, referring to some expression preceding or understood.—4. It is compounded with *all*, in *although*,—*which see*.

**THOUGHT**, *pret.* and *pp.* of *Think*; pronounced *thaut*.

**THOUGHT**, *n.* (thaut.) [primarily the passive participle of *think*, *supra*; *Sax. theacht*.] 1. Properly, that which the mind thinks. Thought is either the act or operation of the mind, when attending to a particular subject or thing, or it is the idea consequent on that operation. We say, a man's *thoughts* are employed on government, on religion, on trade, or arts, or his *thoughts* are employed on his dress or his means of living. By this we mean that the mind is directed to that particular subject or object; that is, according to the literal import of the verb *think*, the mind, the intellectual part of man, is *set* upon such an object, it holds it in view or contemplation, or it extends to it, it stretches to it.

*Thought* cannot be superadded to matter, so as in any sense to render it true that matter can become cogitative. *Dwight.*

2. Idea; conception. I wish to convey my *thoughts* to another person. I employ words that express my *thoughts*, so that he may have the same ideas; in this case, our *thoughts* will be alike.—3. Fancy; conceit; something framed by the imagination.

*Thoughts* come crowding in so fast upon me, that my only difficulty is to choose or reject. *Dryden.*

4. Reflection; particular consideration. Why do you keep alone?

Using those *thoughts* which should have died with them they think on. *Shak.*

5. Opinion; judgment. Thus Bethel spoke, who always speaks his *thoughts*. *Pope.*

6. Meditation; serious consideration. Pride, of all others the most dangerous fault, Proceeds from want of sense or want of *thought*. *Roscommon.*

7. Design; purpose. All their *thoughts* are against me for evil; *Ps. lvi.*; *xxxiii.*; *Jer. xxxix.*

8. Silent contemplation.—9. Solitude; care; concern.

Hawis was put in trouble, and died with *thought* and anguish before his business came to an end. *Bacon.*

10. Inward reasoning; the workings of conscience.

Their *thoughts* the meanwhile accusing or else excusing one another; *Rom. ii.*

11. † A small degree or quantity; as, a *thought* longer; a *thought* better.—To *take thought*, to be solicitous or anxious; *Matth. vi.*

**THOUGHTFUL**, *a.* Full of thought; contemplative; employed in meditation; as, a man of *thoughtful* mind.—

2. Attentive; careful; having the mind directed to an object; as, *thoughtful* of gain.—3. Promoting serious thought; favourable to musing or meditation.

War, horrid war, your *thoughtful* walks invades. *Pope.*

4. Anxious; solicitous. Around her crowd distrust and doubt and fear,

And *thoughtful* foresight, and tormenting care. *Prior.*

**THOUGHTFULLY**, *adv.* With thought or consideration; with solicitude.

**THOUGHTFULNESS**, *n.* Deep meditation.—2. Serious attention to spiritual concerns.—3. Anxiety; solicitude.

**THOUGHTLESS**, *a.* Heedless; careless; negligent.

*Thoughtless* of the future. *Rogers.*

2. Gay; dissipated.—3. Stupid; dull.

*Thoughtless* as monarch oaks that shade the plain. *Dryden.*

**THOUGHTLESSLY**, *adv.* Without thought; carelessly; stupidly.

**THOUGHTLESSNESS**, *n.* Want of thought; heedlessness; carelessness; inattention.

**THOUGHTSICK**, *a.* [*thought* and *sick*.] Uneasy with reflection.

**THOUSAND**, *a.* (*s* as *z*.) [*Sax. thusend*; *Goth. thusund*; *G. tausend*; *Sw. tusend*.] 1. Denoting the number of ten hundred.

—2. Proverbially, denoting a great number indefinitely. It is a *thousand* chances to one that you succeed.

**THOUSAND**, *n.* The number of ten hundred.

A *thousand* shall fall at thy side, and ten *thousand* at thy right hand; *Ps. xci.*

*Thousand* is sometimes used plurally without the plural termination, as in the passage above, ten *thousand*; but it often takes the plural termination. In former times, how many *thousands* perished by famine!

**THOUSANDFOLD**, *a.* Doubled a thousand times.

**THOUSANDTH**, *a.* The ordinal of thousand; as, the *thousandth* part of a thing; also, proverbially, very numerous.

**THOUSANDTH**, *n.* The thousandth part of any thing; as, two *thousandths* of a tax.

**THOWL**, } *n.* A pin inserted into the  
**THOWLE**, } gunwale of a boat to keep the oar in the rowlock when used in rowing. It is also written *Thole*,—*which see.*

**THOWLESS**, *a.* Slack; inactive; lazy. [*Scotch*.]

**THRACIAN**, *n.* A native of Thrace.—2. *a.* Relating to Thrace.

**THRACK**, † *v. t.* To load or burden.

**THRACK-SEAT**, *n.* Metal remaining in the mine. [*A miner's term*.]

**THRALDOM**, *n.* [*Dan. trældom*.] Slavery; bondage; a state of servitude. The Greeks lived in *thraldom* under the Turks, nearly four hundred years.

He shall rule, and she in *thraldom* live. *Dryden.*

**THRALL**, *n.* [*Sax. thrall*, a slave or servant; *Dan. træl*; *Ice. troel*; *Ir. trail*; *Gaelic, trall*.] 1. A slave.—2. † Slavery; bondage.

**THRALL**, † *v. t.* To enslave. [*Enthrall* is in use.]

**THRALL**, † *a.* Bond; subject.

**THRALLLESS**, *a.* Having no thralls.

**THRANG**, *a.* Crowded; much occupied; busy; intimate; familiar. [*Scotch*.]

**THRANITE**, *n.* [*Gr. θρανιον*.] The uppermost of the three classes of rowers in an Athenian trireme.

**THRAPPLE**, *n.* The windpipe of an animal. It is a corruption of the English *throatle*. [*Scotch*.]

**THRASH**, *v. t.* [*Sax. tharscan*, or *therscan*; *G. dreschen*; *D. dorschen*; *Sw. trösha*; *Ice. therskia*.] It is written *thrash* or *thresh*. The common pronunciation is *thrash*.] 1. To beat out or separate grain or seeds from the straw or haulm, by means of a flail or thrashing machine, or by treading with

oxen; as, to *thrash* wheat, rye, or oats.—2. To beat soundly with a stick or whip; to drub.

**THRASH**, *v. i.* To practise thrashing; to perform the business of thrashing; as, a man who *thrashes* well.—2. To labour; to drudge

Irathier would be Mevius, *thrash* for rhymes. Like his, the scorn and scandal of the times. *Dryden.*

**THRASH'ED**, *pp.* Beaten out of the husk or off the ear.—2. Freed from the grain by beating, or by a machine, or by the feet of oxen.

**THRASH'EL**, *n.* An instrument to thrash with.

**THRASH'ER**, *n.* One who thrashes grain.—2. A species of shark, the *Squalus vulpes*, or sea-fox, called the *thrasher* from the length of its tail. [*See SEA-FOX*.]—*Brown thrasher*, an American singing bird of the thrush family, the *Turdus rufus*.

**THRASH'ING**, *ppr.* Beating out of the husk or off the ear, or separating from the straw; beating soundly with a stick or whip.

**THRASH'ING**, *n.* The operation by which grain is separated from the straw. This operation is performed in various ways; as, by the feet of animals, by a flail, or by a thrashing-machine. The first mode was that employed in the ages of antiquity, and it is still practised in the south of Europe, and in Persia and India. Oxen were generally employed for this purpose, either alone or with the addition of a kind of roller studded with iron knots, which the oxen dragged over the corn sheaves, which latter were spread on a circular floor in the form of a circle, the ends containing the grain being placed towards the centre.

Thrashing by the flail is still practised in various parts of this and other countries, but thrashing machines have been very extensively introduced, which effect a great saving in time and labour to the farmer.—2. A sound drubbing.

**THRASH'ING-FLOOR**, *n.* [*thrash* and *floor*.] A floor or area on which grain is beaten out. In eastern countries, from the earliest ages, thrashing-floors were in the open air; but in colder and moister climates, such as ours, such floors must be under cover. Accordingly, a thrashing-floor with us is a space in a barn-floor, on which the grain is thrashed out by the flail.

**THRASH'ING-MACHINE**, } *n.* A ma-

**THRASH'ING-MILL**, } chine for separating grain, as wheat, oats, barley, &c., from the straw; and in which the moving power is that of horses, oxen, wind, water, or steam. Water and horses are most generally employed. The thrashing-machine was invented in Scotland in 1758, by Michael Stirling, a farmer in Perthshire; it was afterwards improved by Mr. Andrew Meikle, a millwright in East Lothian, about the year 1785. Since that time it has undergone various other improvements. The thrashing-machines mostly employed at farm-houses may be briefly described as consisting of three rotative drums or cylinders, which receive motion from a water-wheel, or from a horizontal wheel driven by horses, or by steam power. The first drum which comes into operation has projecting ribs called beaters on its outer surface, parallel to its axis. This drum receives a very rapid motion on its

axis. The sheaves of corn are first spread out on a slanting table, and are then drawn in between two rollers called *feeding* rollers. The beaters of the drum act on the straw as it passes through the rollers, and beat out the grain. The thrashed corn is then carried forward to two successive drums or *shakers*, which, being armed with numerous spikes, lift up and shake the straw so as to free it entirely from the loose grain lodged in it. The grain is made to pass through a grated floor, and is generally conducted to a winnowing machine, which is driven by the same power which drives the thrashing-machine itself, by which means the grain is separated from the chaff. Thrashing-machines effect a great saving in labour; they do the work speedily, and at the time required; and they do the work better than the flail, separating the corn (particularly wheat) more completely from the straw.

**THRASON'ICAL**, *a.* [*from Thraso*, a boaster in old comedy.] 1. Boasting; given to bragging.—2. Boastful; implying ostentatious display.

**THRASON'ICALLY**, *adv.* Boastingly.

**THRATCH**, *v. i.* To gasp convulsively, as one does in the agonies of death. As a noun, the oppressed and violent respiration of one in the last agonies. [*Scotch*.]

**THRAU'LITE**, *n.* Hydrated silicate of iron, a mineral which occurs in roundish nodules in Westmanland and Bavaria, accompanying iron pyrites.

**THRAVE**, † *n.* [*Sax. draf*, a drove.] A drove; a herd.

**THRAVE**, *n.* [*W. dreva*, twenty-four; *drev*, a bundle or tie.] 1. The number of two dozen.—2. Twenty-four sheaves of grain set up in the field, and forming two *stooks*, or shocks, of twelve sheaves each. It is also written *Threave*. [*Scotch*.]

**THRAW**, *v. t.* [*Sax. thrawian*.] To wreathe; to twist; to wrench; to distort; to wrest; to oppose; to resist. As a verb intrans., to cast; to warp; to twist from agony. [*Scotch*.]

**THRAW**, *n.* A twist; a wrench. [*Scotch*.]

**THRA'WARD**, *a.* Forward; perverse; backward; reluctant. [*Scotch*.]

**THRA'WIN**, † *pp* and *a.* Distorted; **THRAWN**, } having the appearance of ill humour; cross-grained; of a perverse humour. [*Scotch*.]

**THREAD**, *n.* [*Sax. thred, thræd*; *D. draad*; *Sw. tråd*; *Dan. tråd*.] Probably from drawing.] 1. A small line made by twisting together a number of fibres of some vegetable or animal substance, such as flax, cotton, or silk; whence its names of linen, cotton, or silk thread. Sewing thread, and the various kinds of thread used in the manufacture of bobbin-net, lace, and some other kinds of textile fabrics, consist of two or more *yarns*, or simple spun threads, firmly united together by twisting. Thread is spun doubled, tripled, &c., and twisted by machines.—2. In *bot.*, the filament of a flower.—3. The filament of any fibrous substance, as of bark.—4. A fine filament or line of gold or silver.—5. *Air-threads*, the fine white filaments which are seen floating in the air in summer, the production of spiders.—6. Something continued in a long course or tenor; as, the *thread* of a discourse.—7. The prominent spiral part of a screw.

**THREAD**, *v. t.* To pass a thread through the eye; as, to *thread* a needle.

—2 To pass or pierce through, as a narrow way or channel.

They would not *threaten* the gates. *Shak.*  
Heavy trading ships, *threatening* the Bosphorus *Milford.*

**THREAT-BARE**, *a.* [*threat* and *bare*.] Worn to the naked thread; having the nap worn off; as, a *threatbare* coat; *threatbare* clothes. — 2. Worn out; trite; hackneyed; used till it has lost its novelty or interest; as, a *threatbare* subject; stale topics and *threatbare* quotations.

**THREAT-BARENNESS**, *n.* The state of being *threatbare* or trite.

**THREAT-EN**, *a.* Made of thread; as, *threaten* sails. [*Little used.*]

**THREAT-LIKE**, *a.* Resembling thread.

**THREAT-PLANTS**, *n.* Plants whose fibres or filaments may be manufactured into thread; as flax and cotton-plants, various kinds of nettle and broom, the stems of the wild hop, swallow-wort, &c.

**THREAT-SHAPED**, *a.* In *bot.*, filiform.

**THREAT-Y**, *a.* Like thread or filaments; slender. — 2. Containing thread.

**THREAP**, *v. t.* [*Sax. threapian*, or rather *threagan*.] To aver with pertinacity; to contend; to quarrel; to urge with pertinacity; to continue to assert in reply to denial. [*Scotch.*]

**THREAT**, *n.* (*thret*.) [*Sax. threat*. See *the verb*.] A menace; denunciation of ill; declaration of an intention or determination to inflict punishment, loss, or pain on another.

There is no terror, Cassius, in your *threats*. *Shak.*

In *English criminal law*, threats of personal violence, or any other threats by which a man of ordinary firmness may be put in fear, and by means of which money or other property is extorted from him, amount to the crime of robbery. It is also a misdemeanor at common law to threaten another in order to deter him from doing some lawful act, or to compel him to do some unlawful one, or to extort money or goods from him, or to obtain any other benefit to the person who makes the threat. In *Scots law*, threats, when used so as to infer just ground of fear, or even if less violent, when accompanied with importunity, will void a deed granted by any person while under the influence; and using threats of death to any person, or attempting or pretending to carry them into execution, in order to compel a confession of a real or supposed crime, is punishable at common law. [*See THREATENING.*]

**THREAT**, *v. t.* (*thret*.) To threaten,—*whic* see. *Threats* used only in poetry.

**THREATEN**, *v. t.* (*threat'n*.) [*Sax. threatian*, from *threat*.] But *threat* appears to be contracted from *threagan*, which is written also *threawian*; *D. dreigen*; *G. drohen*; *Dan. trette*, to chide, to scold, dispute, wrangle.] 1. To declare the purpose of inflicting punishment, pain, or other evil on another, for some sin or offence; to menace. God *threatens* the finally impenitent with everlasting banishment from his presence. — 2. To menace; to terrify or attempt to terrify by menaces; as for extorting money. To send *threatening* letters is a punishable offence. — 3. To charge or enjoin with menace, or with implied rebuke; or to charge strictly.

Let us straitly *threaten* them, that they speak henceforth to no man in his name; Acts iv.

4. To menace by action; to present the appearance of coming evil; as, rolling billows *threaten* to overwhelm us. — 5. To exhibit the appearance of something evil or unpleasant approaching; as, the clouds *threaten* us with rain or a storm.

**THREAT-ENED**, *pp.* (*thret'nd*.) Menaced with evil.

**THREATENER**, *n.* (*thret'ner*.) One that threatens.

**THREATENING**, *ppr.* (*thret'ning*.) Menacing; denouncing evil. — 2. *a.* Indicating a threat or menace; as, a *threatening* look. — 3. Indicating something impending; as, the weather is *threatening*; the clouds have a *threatening* aspect. — *Threatening* letters. In *English law*, the sending or delivering any letter with menaces, with or without any name or signature, or with a fictitious name or signature, demanding money or any other valuable commodity, or threatening (without any demand) to kill or murder, or set fire to the house, or the like, is a felony. By the common law of Scotland, such offences are punishable arbitrarily, and have been punished by pillory and transportation for life.

**THREATENING**, *n.* (*thret'ning*.) The act of menacing; a menace; a denunciation of evil, or declaration of a purpose to inflict evil on a person or country, usually for sins and offences. The prophets are filled with God's *threatenings* against the rebellious Jews; Acts iv.

**THREATENINGLY**, *adv.* (*thret'ningly*.) With a threat or menace; in a threatening manner.

**THREATFUL**, *a.* (*thret'ful*.) Full of threats; having a menacing appearance; minacious.

**THRAVE**. See **THRAVE**.

**THREE**, *a.* [*Sax. three, thri, thry*, and *thrig*; *Sw. and Dan. tre*; *G. drei*; *Fr. trois*; *Sp. and L. tres*; *Gael. and W. tri*; *Gipsy, tre*; *Gr. tres*; *Sans. treja, tri*.] We know not the last radical, nor the primary sense of *three*. Owen, in his *Welsh Dictionary*, suggests that it signifies *fixed, firm*. But see **EXTRACTATE** and **TRICK**. It is probably contracted from *thrig*.] 1. Two and one.

I offer thee *three* things; 2 Sam. xxiv.  
2. It is often used like other adjectives, without the noun to which it refers.

Abishai...attained not to the first *three*; 2 Sam. xxiii.

3. Proverbially, a small number.

Away, thou *three*-inched fool. *Shak.*

*Rule of three*, in *arith.*, a rule by which three quantities being given (the first and second being of the same kind), a fourth quantity is found, such that the first has the same ratio to the second that the third has to the fourth; or such that the first is the same multiple, part or parts, of the second that the third is of the fourth. This has been called the *golden rule*, on account of its great value. The immense variety of questions which may be solved by finding a fourth proportional defies all classification; but they may all be reduced to one form, viz., A produces B, what will C produce. [*See PROPORTION, RATIO.*]

**THREE**, *n.* The number which consists of two and one.

**THREE-CAP-SULED**, *a.* Tricapsular; having three capsules.

**THREE-CELLED**, *a.* Trilocular; having three cells.

**THREE-CLEFT**, *a.* Trifid; being thrice cleft.

**THREE-COAT WORK**. In *arch.*, plastering which consists of pricking up, or roughing in, floating, and a finishing coat.

**THREE-CORNERED**, *a.* [*three* and *corner*.] Having three corners or angles; as, a *three-cornered* hat. — 2. In *bot.*, having three prominent longitudinal angles, as a stem.

**THREE-EDGED**, *a.* Having three edges.

**THREE-FLOWERED**, *a.* [*three* and *flower*.] Bearing three flowers together.

**THREE-FOLD**, *a.* [*three* and *fold*.] Three-double; consisting of three; or thrice repeated; as, *threefold* justice.

A *threefold* cord is not quickly broken; Eccles. iv.

**THREE-GRAINED**, *a.* Tricoccos; having three kernels.

**THREE-HEADED**, *a.* Having three heads; as, *three-headed* Cerberus. — In *bot.*, triplicate.

**THREE-LEAFED**, *a.* [*three* and *leaf*.] Consisting of three distinct leaflets.

**THREE-LOBED**, *a.* [*three* and *lobe*.] A *three-lobed leaf*, is one that is divided to the middle into three parts, standing wide from each other and having convex margins.

**THREE-NERVED**, *a.* [*three* and *nerve*.] A *three-nerved leaf* has three distinct vessels or nerves running longitudinally without branching.

**THREE-PARTED**, *a.* [*three* and *parted*.] Tripartite. A *three-parted leaf* is divided into three parts down to the base, but not entirely separate.

**THREE-PENCE**, *n.* [*Pronounced colloquially, thrip'ence.*] [*three* and *pence*.] Three copper coins, each a penny. Formerly, a small silver coin of three times the value of a penny.

**THREE-PENNY**, *a.* [*Pronounced colloquially, thri'penny.*] Worth three pence only; mean; vulgar; of little worth.

**THREE-PETALED**, *a.* [*three* and *petal*.] Tripetalous; consisting of three distinct petals; as a corol.

**THREE-PILE**, *n.* [*three* and *pile*.] An old name for good velvet.

**THREE-PILED**, *a.* Set with a thick pile, as velvet; piled one above another to the extent of three.

**THREE-PLY**, *a.* Threefold; consisting of three strands, as cord, yarn, &c.

**THREE-POINTED**, *a.* Tricuspidate; having three lengthened points ending in a bristle.

**THREE-RIBBED**, *a.* Having three ribs.

**THREE-SCORE**, *a.* [*three* and *score*.] Thrice twenty; sixty; as, *threescore* years.

**THREE-SEEDED**, *a.* [*three* and *seed*.] Having three seeds; as, a *three-seeded* capsule.

**THREE-SIDED**, *a.* [*three* and *side*.] Having three plane sides; as, a *three-sided* stem, leaf, petiole, peduncle, scape, or pericarp.

**THREE-STRINGED**, *a.* Having three cords; as, a *three-stringed* musical instrument.

**THREE-TOED**, *a.* In *zool.*, tridigitate.

**THREE-VALVED**, *a.* [*three* and *valve*.] Trivalvular; consisting of three valves; opening with three valves; as, a *three-valved* pericarp.

**THRENE**, *n.* [*Gr. θρηνη*.] Lamentation.

**THRENETIC**, *a.* Sorrowful; mournful.

**THREN'ODY**, *n.* [*Gr. θρηνη*, lamentation, and *ωδη*, ode.] A song of lamentation.

**THRESH**, *v. t.* To thresh. [*See* THRASH.] The latter is the popular pronunciation, but the word is written *thresh* or *thresh*, indifferently. [*See* the derivation and definitions under THRASH.]

**THRESH'ED**. *See* THRASHED.

**THRESH'ER**, *n.* The sea-fox, *Squalus vulpes*, a fish of the shark genus. [*See* THRASHER.]

**THRASH'ING**. *See* THRASHING.

**THRASHING-FLOOR**. *See* THRASHING-FLOOR.

**THRASHING MACHINE**, *n.* *See* THRASHING-MACHINE.

**THRASH'OLD**, *n.* [*Sax.* *thærsewald*; *G.* *thürschwelle*; *Sw.* *tröskel*; *Ice.* *throssulldur*. The Saxon and Swedish words seem by their orthography to be connected with *thresh*, *thresh*, and the last syllable to be *wald*, wood; but the German word is obviously compounded of *thür*, door, and *schwelle*, sill; door-sill.] 1. The door-sill: the plank, stone, or piece of timber which lies at the bottom or under a door, particularly of a dwelling-house, church, temple, or the like; hence, entrance; gate; door.—2. Entrance; the place or point of entering or beginning. He is now at the *threshold* of his argument.

Many men that stumble at the *threshold*.  
*Shak.*

**TREW**, *pret.* of *Thrive*.

**THRICE**, *adv.* [from *three*; perhaps *three* and *L. vice*; or a change of *Fr. tiers*.] 1. Three times.

Before the cock crow, thou shalt deny me *thrice*; *Math.* xxvi.  
2. Sometimes used by way of amplification; very.

*Thrice* noble lord, let me entreat of you.  
To pardon me. *Shak.*

**THRICE-FAVOUR'ED**, *a.* Favoured thrice; highly favoured.

**THRID**, *v. t.* [*W.* *treiziau*, to penetrate; *treidiaw*, to course, to range.] To slide through a narrow passage; to thread; to slip, shoot, or run through, as a needle, bodkin, or the like.

Some *thrid* the mazy ringlets of her hair.  
*Pope.*

**THRID**, † *n.* Thread.

**THRID'DED**, *pp.* Slid through.

**THRID'DING**, *ppr.* Sliding through; causing to pass through.

**THRIF'FALLOW**, *v. t.* To plough or fallow land a third time.

**THRIFT**, *n.* [from *thrive*.] Frugality; good husbandry; economical management in regard to property.

The rest, willing to fall to *thrift*, prove very good husbands. *Spenser.*

2. Prosperity; success and advance in the acquisition of property; increase of worldly goods; gain.

I have a mind presages me such *thrift*.  
*Shak.*

3. Vigorous growth, as of a plant.—4. In *bot.*, the English name of a genus of plants, *Stactea*,—*which see*.

**THRIFT'ILY**, *adv.* Frugally; with parsimony.—2. With increase of worldly goods.

**THRIFT'INESS**, *n.* Frugality; good husbandry; as, *thriftiness* to save; *thriftiness* in preserving one's own.—2. Prosperity in business; increase of property.

**THRIFT'LESS**, *a.* Having no frugality or good management; profuse; extravagant; not thriving.

**THRIFT'LESSLY**, *adv.* Without thriving; extravagantly.

**THRIFT'LESSNESS**, *n.* A state of being thriftless.

**THRIFT'Y**, *a.* Frugal; sparing; using economy and good management of property.

I am glad he has so much youth and vigour left, of which he has not been *thrift*.  
*Swift.*

2. *More generally*, thriving by industry and frugality; prosperous in the acquisition of worldly goods; increasing in wealth; as, a *thrift*y farmer or mechanic.—3. Thriving; growing rapidly or vigorously; as, a plant.—4. Well husbanded.

I have five hundred crowns,  
The *thrift*y hire I sav'd under your father.  
*Shak.*

**THRILL**, *n.* [*See* the *Verb.*] A drill.—2. A warbling. [*See* TRILL.]—3. A breathing place or hole.—4. A thrilling sensation; as, a *thrill* of horror.

**THRILL**, *v. t.* [*Sax.* *thyrlhan*, *thirlian*; *D.* *drillen*, to drill, to bore; *trillen*, to shiver, pant, quaver; *G.* *drillen*, to drill; *triller*, a shake; *trillern*, to trill; *Dan.* *driller*, to bore, to drill; *trilder*, *Sw.* *trilla*, to roll; *Dan.* *trille*, a trill; *W. troliaw*, to troll or roll; all probably of one family, from the root of *roll*. *See* DRILL.] 1. To bore; to drill; to perforate by turning a gimlet or other similar instrument. But in the literal sense, *drill* is now chiefly or wholly used. *Spenser* used it literally in the clause, "with *thrilling* point of iron brand."—2. To pierce; to penetrate; as something sharp.

The cruel word her tender heart so *thrill'd*.  
That sudden cold did run through every vein.  
*Spenser.*

A servant that he bred, *thrill'd* with remorse.  
*Shak.*

**THRILL**, *v. i.* To pierce; to penetrate; as something sharp; particularly, to pierce or wound the ear with a sharp sound; to cause a tingling sensation that runs through the system with a slight shivering; as, a sharp sound *thrills* through the whole frame.

A faint cold fear *thrills* through my veins.  
*Shak.*  
2. To feel a sharp shivering sensation running through the body.

To seek sweet safety out  
In vaults and prisons; and to *thrill* and shake.  
*Shak.*

**THRILL'ED**, *pp.* Penetrated; pierced.

**THRILL'ING**, *ppr.* Perforating; drilling.—2. Piercing; penetrating; having the quality of penetrating; passing with a tingling, shivering sensation.—3. Feeling a tingling, shivering sensation running through the system.

**THRILL'INGLY**, *adv.* With thrilling sensations.

**THRILL'INGNESS**, *n.* The quality of being thrilling.

**THRILL'INGS**, *n. plur.* Thrilling sensations.

**THRIN'CIA**, *n.* A genus of plants, *nat. order* Compositæ. *T. hirta* is a British species, with lanceolate leaves, sinuate, dentate, hispid, or hairy. It is found chiefly in gravelly soil.

**THRING**, † *v. t.* To press, crowd, or throng.

**THRIPS**, *n.* A genus of minute insects, order Hemiptera. They are extremely agile, and seem to leap rather than fly. When irritated beyond a certain point, they turn up the posterior extremity of their body in the manner of the *Staphylini*. They live on flowers, plants, and under the barks of trees.

**THRIS'SA**, *n.* A fish of the shad and herring kind, whose flesh is considered as being sometimes poisonous. It is

found in the waters of intertropical America, India, &c.

**THRIVE**, *v. i.* *pret.* *Throve*; *pp.* *Thriven*, sometimes the regular *pret.* *Thrived* is used. [*Dan.* *trives*, to thrive, to increase; *Sw.* *trivas*. It may belong to the family of *trip*, to hasten, or to that of *drire*.] 1. To prosper by industry, economy, and good management of property; to increase in goods and estate. A farmer *thrives* by good husbandry. When the body of labouring men *thrives*, we pronounce the state prosperous.

Diligence and humility is the way to *thrive* in the riches of the understanding, as well as in gold. *Watts.*

2. To prosper in any business; to have increase or success.

O son, why sit we here, each other viewing  
Idly, while Satan, our great author, *thrives*?  
*Milton.*

They by vices *thrives*.  
*Sundys.*

3. To grow; to increase in bulk or stature; to flourish. Young cattle *thrive* in rich pastures; and trees *thrive* in a good soil.—4. To grow; to advance; to increase or advance in anything valuable.

**THRIVER**, *n.* One that prospers in the acquisition of property.

**THRIVING**, *ppr.* Prospering in worldly goods.—2. *a.* Being prosperous or successful; advancing in wealth; increasing; growing; as, a *thriving* mechanic; a *thriving* trader.

**THRIVINGLY**, *adv.* In a prosperous way.

**THRIVINGNESS**, } *n.* Prosperity;  
**THRIVING**, } growth; increase.

**THRO**. Contraction of *Through*.

**THROAT**, *n.* [*Sax.* *throta*, *throte*; *D.* *strote*; *Russ.* *grad.*] 1. The anterior part of the neck of an animal, in which are the gullet and windpipe, or the passages for the food and breath. In *med.*, the fauces; all that hollow or cavity in the part of the mouth which may be seen when the mouth is wide open.—2. Entrance; main passage.—3. In *bot.*, the mouth of a monopetalous corolla, or the circular line at which the tube and limbus unite.—4. In *seamen's lan.*, that curved end of a gaff which embraces the mast.—5. In *ship-building*, the inside of the knee-timber at the middle or turns of the arms; also, the inner part of the arms of an anchor where they join the shank; and the middle part of a floor-timber.—*Throat-brails*, brails attached to the gaff close to the mast.—*Throat halliards*, are those that raise the throat of the gaff.

—*Throat of a chimney*, in *arch.*, the part between the gathering (or that part of the funnel which contracts as it ascends), and the flue.—*To cut the throat*, to murder by cutting the jugular veins.

**THROAT-BAND**, *n.* A strap to a head-stall; a check-band.

**THROAT-LATCH**, *n.* A strap of a bridle, halter, &c., passing under a horse's throat.

**THROAT-PIPE**, *n.* [*throat* and *pipe*.] The windpipe, weasand, or trachea.

**THROAT-WORT**, *n.* [*throat* and *wort*.] A British plant of the genus *Campanula*, the *C. latifolia*, called also giant bell-flower. It is a perennial with a stem three or four feet high, and large campanulate flowers of a deep blue. It grows in moist woods and thickets.—*Blue throat-wort* is a plant of the genus *Trachelium*, the *T. caeruleum*.



**THROATY**, † *a.* Guttural.  
**THROB**, *v. i.* [perhaps allied to *drive* and to *drub*; at least its elements and signification coincide; Gr. *θροβω*.] To beat, as the heart or pulse, with more than usual force or rapidly; to beat in consequence of agitation; to palpitate. The heart *throbs* with joy, desire, or fear; the violent action of the heart is perceived by a *throbbing* pulse. My heart *throbs* to know one thing. *Shak.*

We apply the word also to the breast. Here may his head live on my *throbbing* breast. *Shak.*

**THROB**, *n.* A beat or strong pulsation; a violent beating of the heart and arteries; a palpitation. Thou talk'st like one who never felt Th' impatient *throbs* and longings of a soul That pants and reaches after distant good. *Addison.*

**THROB'ING**, *ppr. or a.* Beating with unusual force, as the heart and pulse; palpitating.

**THROB'ING**, *n.* The act of beating with unusual force, as the heart and pulse; palpitation.

**THROD'DEN**, *v. i.* To grow; to thrive. [Not in use or local.]

**THRÖE**, *n.* [Sax. *throwian*, to suffer, to agonize; but this is the same word as *throw*, and the sense is to strain, as in twisting, to struggle.] Extreme pain; violent pang; anguish; agony. It is particularly applied to the anguish of travail in child-birth, or parturition. My *throes* came thicker, and my cries increase'd. *Dryden.*

**THRÖE**, *v. i.* To agonize; to struggle in extreme pain.

**THRÖE**, *v. t.* To put in agony.

**THROM'BOLITE**, *n.* In *min.*, an amorphous green phosphate of copper.

**THROMBUS**, *n.* [L. from Gr. *θρομβω*, to clot.] A small tumour which sometimes arises after bleeding, owing to the blood escaping from the vein into the cellular structure surrounding it, and coagulating there.

**THRONE**, *n.* [L. *thronus*; Gr. *θρονος*; Fr. *trône*.] 1. A royal seat; a chair of state. The throne is generally an elegant chair richly ornamented with sculpture and gilding, raised above the floor whereon it stands, and covered with a canopy.—2. The seat of a bishop.—3. In *scrip.*, sovereign power and dignity.

Only in the *throne* will I be greater than thou; Gen. xii.

Thy *throne*, O God, is for ever; Ps. xlv.

4. Angels; Col. i.—5. The place where God peculiarly manifests his power and glory.

The heaven is my *throne*, and the earth my footstool; Is. lxvi.

**THRÖNE**, *v. t.* To place on a royal seat; to enthrone.—2. To place in an elevated position; to give an elevated place to; to exalt.

**THRÖNE**, *pp.* Placed on a royal seat, or on an elevated seat; exalted.

True image of the Father, whether *thröned* in the bosom of bliss and light of light. *Milton.*

**THRÖNELESS**, *a.* Having no throne.

**THRONG**, *n.* [Sax. *thrang*; Ir. *drong*; G. and D. *drang*. See the Verb.] 1. A crowd; a multitude of persons or of living beings pressing or pressed into a close body or assemblage; as, a *throng* of people at a play-house.—2. A great multitude; as, the heavenly *throng*.

**THRÖNG**, *v. i.* [Sax. *thringan*; G. *drängen*; Dan. *trænger*. If *n* is not

radical, this word coincides with Sw. *tryka*, Dan. *trykker*, to press, to print.] To crowd together; to press into a close body, as a multitude of persons; to come in multitudes.

I have seen

The dumb men *throng* to see him. *Shak.*

**THRÖNG**, *v. t.* To crowd or press, as persons; to oppress or annoy with a crowd of living beings.

Much people followed him, and *thronged* him; Mark v.

**THRÖNG**, *a.* Much occupied or engaged; busy. [Local.]

**THRÖNG'ED**, *pp. or a.* Crowded or pressed by a multitude of persons.

**THRÖNG'ING**, *ppr. or a.* Crowding together; pressing with a multitude of persons.

**THRÖNG'ING**, *n.* The act of crowding together.

**THRÖNG'LY**, † *adv.* In crowds.

**THRÖNG'ING**, *ppr.* Placing on a royal seat; enthroning.

**THRÖP'PLE**, *n.* The windpipe; the throttle. [Local.] [See **THRÄPPLE**.]

**THRÖS'TLE**, *n.* (*thros'tl*). [Sax. *thorstle*; G. *drossel*.] The song-thrush, a bird of the genus *Turdus*, the *T. musicus*, Linn. [See **MAVIS** and **THRUSH**.]

—2. In *cotton spinning*, the machine otherwise called the *water-frame*, because it was at first driven by water-wheels. It takes the name *throstle*, from the peculiar noise (resembling the singing of a throistle or thrush), which it makes in working. It is now in a great measure superseded by the *mule*.

**THRÖS'TLING**, *n.* A disease of cattle of the ox kind, occasioned by a swelling under their throats, which, unless checked, will choke them.

**THRÖT'TLE**, *n.* [from *throat*.] The windpipe or trachea.

**THRÖT'TLE**, *v. i.* To choke; to suffocate; or to obstruct so as to endanger suffocation.—2. To breathe hard, as when nearly suffocated.

**THRÖT'TLE**, *v. t.* To utter with breaks and interruptions, as a person half suffocated.

*Throttle* their practised accents in their fears. *Shak.*

**THRÖT'TLED**, *pp.* Uttered with breaks and interruptions.—2. Choked; suffocated.

**THRÖT'TLE VALVE**, *n.* In *steam-engines*, the valve which regulates the supply of steam to the cylinder. It usually consists of a circular plate of metal, which is placed within the steam-pipe, and entirely crosses its area, when shut. It turns upon an axis which passes diametrically through or across it, and also through the sides of the pipe. It is acted upon by the governor in such a way, that when a greater supply of steam is required, the valve is opened to a greater extent, and when less steam is required, the valve is brought into such a position as to intercept more of the steam. [See **GOVERNOR** and **STEAM-ENGINE**.]

**THRÖT'TLING**, *ppr.* Choking; suffocating.

**THRÖUGH**, *prep.* (thru.) [Sax. *thurh*; D. *door*; G. *durch*; W. *trwy* or *true*, whence *trywau*, to pervade; Ir. *treogh-dham*, Gaelic, *treaghaim*, to pierce or bore.] 1. From end to end, or from side to side; from one surface or limit to the opposite; as, to bore *through* a piece of timber, or *through* a board; a ball passes *through* the side of a ship.

—2. Noting passage; as, to pass *through* a gate or avenue.

*Through* the gates of iv'ry he dismiss'd His valiant offspring. *Dryden.*

3. By transmission, noting the means of conveyance.

*Through* these hands this science has passed with great applause. *Temple.*

Material things are presented only *through* the senses. *Cheyne.*

4. By means of; by the agency of; noting instrumentality. This signification is a derivative of the last.

*Through* the scent of water it will bud; Job xiv.

Some *through* ambition, or *through* thirst of gold,

Have slain their brothers, and their country sold. *Dryden.*

Sanctify them *through* thy truth; John xvii.

The gift of God is eternal life *through* Jesus Christ our Lord; Rom. vi.

5. Over the whole surface or extent; as, to ride *through* the country.

Their tongue walketh *through* the earth; Ps. lxxiii.

6. Noting passage among or in the midst of; as, to move *through* water, as a fish; to run *through* a thicket, as a deer.

**THRÖUGH**, *adv.* (thru.) From one end or side to the other; as, to pierce a thing *through*.—2. From beginning to end; as, to read a letter *through*.—3. To the end; to the ultimate purpose; as, to carry a project *through*.—4. To carry *through*, to complete; to accomplish.—5. To go *through*, to prosecute a scheme to the end.—6. To undergo; to sustain; as, to go *through* hardships.

**THRÖUGH-BRED**, should be *Thorough-bred*.

**THRÖUGH-LIGHTED**, should be *Thorough-lighted*,—which see.

**THRÖUGHLY**, *adv.* (thru'ly.) Completely; fully; wholly.—2. Without reserve; sincerely. [For this, *Thoroughly* is now used.]

**THRÖUGHOUT**, *prep.* (thruout') [*through* and *out*.] Quite through; in every part; from one extremity to the other. This is the practice *throughout* Ireland. A general opinion prevails *throughout* England. *Throughout* the whole course of his life, he avoided every species of vice.

**THRÖUGHOUT**, *adv.* (thruout') Every where, in every part. The cloth was of a piece *throughout*.

**THRÖUGH-PACED**. [Not used.] [See **THOROUGH-PACED**.]

**THRÖUGH-STONE**, *n.* In *arch.*, a bond-stone,—which see.

**THRÖVE**, *pret.* of *Throw*.

**THRÖW**, *v. t.* pret. *Threw*; *pp.* *Thrown*. [Sax. *throwan*; perhaps D. *draaijen*, to turn, wind, twist, whirl; G. *drehen*; W. *troi*.] The Saxon word signifies to twist, to turn, to curl, throw, and to revolve. It is contracted, and probably coincides in elements with Gr. *τρομα*, to run, for this was applied primarily to wheels, as we see by its derivatives, *τρομας*, a wheel, *τρομας*, a top, L. *trochilus*.] 1. Properly, to hurl; to whirl; to fling or cast in a winding direction.—2. To fling or cast in any manner; to propel by projectile force; to send; to drive to a distance from the hand or from an engine. Thus we *throw* stones or dust with the hand; a cannon *throws* a ball; a bomb *throws* a shell. The Roman balista *threw* various weapons.

A fire-engine *throws* water to extinguish flames.—3. To wind or twist; as, to *throw* silk.—4. To turn; as, to *throw* balls in a lathe. [*Not in general use.*—5. To venture at dice.

Set less than thou *throwest*. *Shak.*

6. To cast; to divest or strip one's self of; to put off; as, a serpent *throws* his skin.—7. To cast; to send.

I have *thrown*

A brave defiance in king Henry's teeth.

*Shak.*

8. To put on; to spread carelessly. O'er his fair limbs a flow'ry vest he *throws*.

*Pope.*

9. To overturn; to prostrate in wrestling; as, a man *throws* his antagonist.—10. To cast; to drive by violence; as, a vessel or sailors *thrown* upon a rock.—*To throw away*, to lose by neglect or folly; to spend in vain; as, to *throw away* time; to *throw away* money.—2. To bestow without a compensation.—3. To reject; as, to *throw away* a good book, or a good offer.—*To throw by*, to lay aside or neglect as useless; as, to *throw by* a garment.—*To throw down*, to subvert; to overthrow; to destroy; as, to *throw down* a fence or wall.—2. To bring down from a high station; to depress.—*To throw in*, to inject.—2. To put in; to deposit with others; also, to give up or relinquish.—*To throw off*, to expel; to clear from; as, to *throw off* a disease.—2. To reject; to discard; as, to *throw off* all sense of shame; to *throw off* a dependent.—*To throw on*, to cast on; to load.—*To throw out*, to cast out; to reject or discard; to expel.—2. To utter carelessly; to speak; as, to *throw out* insinuations or observations.—3. To exert; to bring forth into act.

She *throws* out thrilling shrieks. *Spenser.*

4. To distance; to leave behind.—5. To exclude; to reject. The bill was *thrown out* on the second reading.—*To throw up*, to resign; as, to *throw up* a commission.—2. To resign angrily. Bad games are *thrown up* too soon.

*Hudibras.*

3. To discharge from the stomach.—*To throw one's self down*, to lie down.—*To throw one's self on*, to resign one's self to the favour, clemency, or sustaining power of another; to repose.—*To throw silk*, is to twist singles into a cord, in a direction contrary to that in which the singles of which it is composed are twisted.

THROW, v. i. To perform the act of throwing.—2. To cast dice.—*To throw about*, to cast about; to try expedients. [*Not much used.*]

THROW, n. The act of hurling or flinging; a cast; a driving or propelling from the hand or from an engine. He heav'd a stone, and rising to the *throw*, He sent it in a whirlwind at the foe.

*Addison.*

2. A cast of dice; and the manner in which dice fall when cast; as, a good *throw*. None but a fool hazards all upon one *throw*.—3. The distance which a missile is or may be thrown; as, a stone's *throw*.—4. A stroke; a blow.

Nor shield defend the thunder of his *throws*.

*Spenser.*

5. Effort; violent sally.

Your youth admires

The *throws* and swellings of a Roman soul.

*Addison.*

6. The agony of travail. [*See* THROE.]—7. A turner's lathe. [*Local.*]

THROWER, n. One that throws; one that twists or winds silk; a throwster. THROWING, ppr. Casting; hurling; flinging.

THROWN, pp. of *Throw*. Cast; hurled; wound or twisted.

THROWN SILK, n. Silk consisting of two or more singles twisted together like a rope in a direction contrary to that in which the singles of which it is composed are twisted.

THROWSTER, n. One that twists or winds silk.

THRUM, n. [*Ice. thraum*; G. *trumm*; D. *drom*, the end of a thing; Gr. *Στρομα*, a fragment; *Στρομα*, to break.] 1. The ends of weaver's threads.—2. Any coarse yarn.—3. *Thrums*, among gardeners, the thread-like internal bushy parts of flowers; the stamens.

THRUM, v. i. [*D. trom*, a drum.] To play coarsely or unskillfully on an instrument with the fingers or otherwise; as, to *thrum* on a guitar; to *thrum* on a fiddle.

THRUM, v. t. To weave; to knot; to twist; to fringe.—2. To dress or work with *thrums*.—3. To thicken or crowd together; to compress; to collect.—4. Among *seamen*, to insert short pieces of rope-yarn or spun-yarn in a sail or mat.

THRUMMING, ppr. Playing coarsely on an instrument.—2. Weaving; knotting; twisting.

THRUMMY, a. Containing or resembling thrums.

THRUMWORT, n. The plant waterplantain.

THRUSH, n. [*Sax. thrisc*; G. *drossel*; W. *tresglen*; Sw. *trast*.] 1. A bird of the genus *Turdus*, or of the family *Turdidæ*; but the name is applied by way of eminence to the song thrush, (*Turdus musicus*). [*See* THROSTLE and MAVIS.] The thrushes (*Turdidæ* or *Merulidæ*) form a family of dentostral passerine birds, having the bill of middle size, sharp edged, compressed, and decurved at the tip, with a notch near the point, and a few loose hairs over the base; the nostrils oval, lateral, half concealed by membrane, the middle toe not so long as the tarsus, and the outer toes joined to it at the base. They resemble the shrikes, but they are more frugivorous, generally feeding upon berries, though they prefer small animals, especially molluscs and worms, when these can be obtained. Their habits are mostly solitary, but several species are gregarious in winter. Thrushes have been celebrated from very remote antiquity on account of their powers of song; they are widely diffused, being found in all the quarters of the globe. Among European thrushes we have the blackbird (*Merula vulgaris*), the black-throated thrush (*Turdus atrogularis*), the missel thrush (*Turdus viscivorus*), the field-fare (*Turdus pilaris*), the song thrush or throistle (*Turdus musicus*), the water-ouzel (*Cinclus aquaticus*), the rock-thrush (*Petrocincla saxatilis*), &c. *Turdus erythrogaster* belongs to Asia; *Turdus striptans*, to Africa; and *Turdus melodus*, or the wood thrush, to America.—2. [*Qu. thrust*.] An affection of the inflammatory and suppurating kind, in the feet of the horse and some other animals. In the horse it is in the frog.—3. In *med.*, (*L. aphthæ*.) A disease characterized by roundish granular vesicles of a pearl colour, affecting the lips and mouth, and some-

times the whole alimentary canal, terminating in curd-like sloughs; occasionally occurring in successive crops. It is common in infants who are ill fed or brought up by hand. In adults, it commonly occurs in the advanced stages of many diseases, as typhoid and other acute fevers; in short, in nearly all cases in which there is great prostration of strength, thrush may occur. THRUSH-PASTE, n. An astringent for curing thrush in the feet of horses. It is composed of calamine, verdigris, white vitriol, alum, and tar.

THRUST, v. t. pret. and pp. *Thrust*. [*L. trudo, trusum, trusito*; Ch. *דָּרַד, terad*; Ar. *tarada*.] 1. To push or drive with force; as, to *thrust* any thing with the hand or foot, or with an instrument.

Neither shall one *thrust* another; Joel ii.; John xx.

2. To drive; to force; to impel.—*To thrust away* or *from*, to push away; to reject; Acts vii.—*To thrust in*, to push or drive in.

*Thrust* in thy sickle and reap; Rev. xiv. *To thrust on*, to impel; to urge.—*To thrust off*, to push away.—*To thrust through*, to pierce; to stab; Numb. xxv; 2 Sam. xviii.—*To thrust out*, to drive out or away; to expel; Exod. xii.—*To thrust one's self*, to obtrude; to intrude; to enter where one is not invited or not welcome.—*To thrust together*, to compress.

THRUST, v. i. To make a push; to attack with a pointed weapon; as, a fencer *thrusts* at his antagonist.—2. To enter by pushing; to squeeze in.

And *thrust* between my father and the god. *Dryden.*

3. To intrude.—4. To push forward; to come with force; to press on.

Young, old, *thrust* there

In mighty concourse. *Chapman.* THRUST, n. A violent push or driving, as with a pointed weapon, or with the hand or foot, or with any instrument; a word much used in fencing.

Polites Pyrrhus with his lance pursues, And often reaches, and his *thrusts* renews. *Dryden.*

2. Attack; assault.

There is one *thrust* at your pure, pretended mechanism. *More*

3. In *mech.*, the force exerted by any body or system of bodies, against another body or system.—*Thrust of an arch*, the force exerted by the arch stones, considered as a combination of wedges, to overturn the abutments or walls from which the arch springs. The force exerted by rafters or beams against the walls which bear them is also termed a *thrust*.

*Note.*—*Push* and *shove* do not exactly express the sense of *thrust*. The two former imply the application of force by one body already in contact with the body to be impelled. *Thrust*, on the contrary, often implies the impulse or application of force by a moving body, a body in motion before it reaches the body to be impelled. This distinction does not extend to every case. THRUSTER, n. One who thrusts or stabs.

THRUSTING, ppr. Pushing with force; driving; impelling; pressing.

THRUSTING, n. The act of pushing with force.—2. In dairies, the act of squeezing curd with the hand, to expel the whey. [*Local.*]

**THRUSTINGS**, *n.* In *cheese-making*, the white whey, or that which is last pressed out of the curd by the hand, and of which butter is sometimes made.

**THRUSTING-SCREW**, *n.* A screw for pressing curd in cheese-making. [*Local.*]

**THRUSTLE**, *n.* The thrush. [*See THROSTLE.*]

**THRY'-FALLOW**, *v. t.* [*thrice and fallow.*] To give the third ploughing in summer.

**THUD**, *n.* [*Sax. thoden; G. duden; Ir. dud.*] Impetus; as of a gust of wind; a stroke; a blow. As a verb, to move with velocity; to beat; to strike. [*Scotch.*]

**THUGS**, *n.* (tugs.) [*Hind. thagna; to deceive.*] A secret and wide spread association of robbers and murderers in the upper provinces of Hindostan. The existence of this association was scarcely known to the British government before the year 1810, and no combined measures were taken to put it down until about 1830. The Thugs are considered to be a degenerate set of Káli worshippers, and are peculiarly superstitious in their observances. To rob and murder is with them a sacred duty, and they are directed in all their proceedings by auguries, supposed to be vouchsafed by their tutelary goddess Behovaneé. They usually move in gangs, consisting of from ten to two hundred or three hundred men, of all races, castes, sects, and religions, yet all joining in the worship of Káli, and sacrificing to their tutelary goddess every victim they can seize, and sharing the plunder among themselves. Still they shed no blood unless when forced by circumstances, but strangle their victims by means of a rope or handkerchief. Particular classes, however, are altogether exempt from their attacks; among whom are dancing girls, minstrels, sikhs, some religious mendicants, tailors, oilmen, blacksmiths and carpenters. In 1830 vigorous measures were adopted for their suppression, and between 1830 and 1837 upwards of 3000 were brought to justice. In consequence of these measures, the numbers of Thugs have rapidly diminished, and it is to be hoped that they will soon be totally extinct. The system practised by the Thugs is termed *Thugee*.

**THU'JA**, } *n.* A genus of plants, nat.  
**THU'YA**, } order Coniferæ. The species are known by the name of *arbor vitæ*, or tree of life; they are evergreens, trees or shrubs, and are inhabitants of Asia, Africa, and North America. *T. occidentalis*, the American arbor vitæ, and *T. orientalis*, the Chinese arbor vitæ, have been introduced into this country as ornamental plants.

**THULE**, *n.* The name given by the ancients to the most northern country with which they were acquainted. This is generally believed to have been Iceland. Hence the Latin phrase *ultima thule*.

**THU'LITE**, *n.* A rare mineral of a peach blossom colour, found in Norway. It consists of silica, alumina, and lime, with minute portions of soda, potash, and the oxides of iron and manganese.

**THUMB**, *n.* [*Sax. thuma; G. daumen; D. duim; Dan. tomme; Sw. tumme.*] The short thick finger of the human hand, or the corresponding member of other animals.

**THUMB**, *v. t.* To handle awkwardly; to play with the fingers; as, to *thumb* over a tune.—2. To soil with the fingers.

**THUMB**, *v. i.* To play on with the fingers.

**THUMB'-BAND**, *n.* [*thumb and band.*] A twist of any thing as thick as the thumb.

**THUMB'ED**, *a.* Having thumbs.

**THUMB'ED**, *pp.* Handled awkwardly; soiled with the fingers.

**THUMB'ING**, *ppr.* Soiling with the fingers.

**THUMBKIN**, *n.* *See* THUMB-SCREW.

**THUMB'-LATCH**, *n.* A kind of door-latch, which receives its name from the thumb being placed on the lever, to raise its latch.

**THUMB'-RING**, *n.* A ring formerly worn on the thumb.

**THUMB'-SCREW**, *n.* A screw which may be turned by the application of the finger and thumb; as a screw for fastening a window sash.—2. An ancient

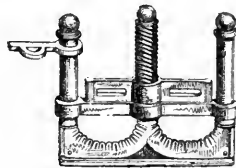

Scotch Thumbkin, time of Charles I.

instrument of torture for compressing the thumb; called also a thumbkin.

**THUMB'-STALL**, *n.* [*thumb and stall.*] A kind of thimble or ferule of iron, horn, or leather, with the edges turned up to receive the thread in making sails. It is worn on the thumb to tighten the stitches.—2. A case or sheath of leather or other substance to be worn on the thumb.

**THUM'ERSTONE**, *n.* A mineral, so called from *Thum*, in Saxony, where it was found. It is called also *axinite*, from the resemblance of its flat sharp edges to that of an axe. It is either massive or crystallized; its crystals are in the form of a compressed oblique rhomboidal prism. It is of the silicious kind, and of a brown gray or violet colour. [*See* AXINITE.]

**THU'MITE**, *n.* In *mineral*, the axinite.

**THUM'MIM**, *n. plur.* A Hebrew word denoting perfections. The *Urim* and *Thummim* were worn in the breastplate of the high priest, but what they were has never been satisfactorily ascertained. [*See* URIM.]

**THUMP**, *n.* [*It. thombo.*] A heavy blow given with any thing that is thick, as with a club or the fist, or with a heavy hammer, or with the breech of a gun.

The watchman gave so great a *thump* at my door, that I awaked at the knock.

*Tatler.*

**THUMP**, *v. t.* To strike or beat with something thick or heavy.

**THUMP**, *v. i.* To strike or fall on with a heavy blow.

A watchman at night *thumps* with his pole. *Swift.*

**THUMP'ED**, *pp.* Struck with something heavy.

**THUMP'ER**, *n.* The person or thing that thumps. In *low lan.*, a person or thing which is huge or great.

**THUMP'ING**, *ppr.* Striking or beating

with something thick or blunt.—2. *n.* Heavy.—3. *Vulgarly*, stout; fat; large.

**THUN'DER**, *n.* [*Sax. thunder, thumor; G. donner; D. donder; Sw. dunder; Dan. dundren; L. tonitru, from tono, to sound; Fr. tonnerre; It. tuono; Pers. thondor or thundur.*] 1. The sound which follows an explosion of electricity or lightning; the report of a discharge of electrical fluid, that is, of its passage from one cloud to another, or from a cloud to the earth, or from the earth to a cloud.—*Thunder* is not lightning, but the effect of it. The character of the sound of thunder varies with the force and the distance of the explosion, the situation of the observer, the nature of the surrounding country, and it is no doubt affected also by the relative situations of the clouds. In general, it is considered that lightning, by its heat, creates a partial vacuum in the atmosphere, and that the sudden rushing of air into the void space produces the sound; but this explanation will not account for the prolongation of the sound. The true cause seems to be the vibration of the air, agitated to a greater or less extent by the passage of the electric fluid with a greater or less degree of intensity. When lightning strikes an object near us in the earth, it produces a noise resembling that of a violent crash, which is not repeated or prolonged by reflection. When the explosion is more distant, a rumbling, irregular, and recurring noise is heard, which gradually dies away in the distance.

Thunder frequently commences with a loud rattle, which may be occasioned by a series of discharges of electric matter in rapid succession, from a highly charged thunder cloud. The distance of a thunder cloud may be ascertained by counting the number of seconds which elapse between the time of seeing the flash, and that of hearing the report, and multiplying 1130 feet by that number of seconds, (1130 feet being the distance which sound travels per second); the result will be the distance of the cloud in feet. When the flash and the sound occur almost simultaneously, the thunder cloud is very near; but when 2 or 3 seconds elapse between the time of seeing the former and that of hearing the latter, the cloud may be considered at a safe distance. In thunder storms the lightning frequently does great mischief, destroying trees, killing men and animals, and even shattering buildings. During a thunder storm, persons should avoid going near any object or thing which acts as a conductor to the fluid; such as trees, hedges, water, fire places, gilt furniture, bell wires, and all large metallic surfaces. In a house, the safest place is in the middle of a room, and the security may be increased by sitting or lying upon a feather bed, a hair mattress, or thick woollen rug. Cellars are dangerous, as the discharge is often from the earth to a cloud, and buildings frequently sustain the greatest damage from lightning in the basement story. Thunder can scarcely ever be heard at the distance of more than 20 or 30 miles from the flash which produces it.

There were *thunders* and lightnings; *Exod. xix.*  
2. Thunder is used for lightning, or for a *thunderbolt*, either originally through ignorance, or by way of metaphor, or

because the lightning and thunder are closely united.

The revenging gods  
'Gainst parricides all the *thunder* bend.  
*Shak.*

3. Any loud noise; as, the *thunder* of cannon.

Sons of *thunder*; Mark iii.

4. Denunciation published; as, the *thunders* of the Vatican.

**THUNDER**, *v. i.* To sound, rattle, or roar, as an explosion of electricity.

Canst thou *thunder* with a voice like him?  
Job xl.

2. To make a loud noise, particularly a heavy sound of some continuance.

His dreadful voice no more

Would *thunder* in my ears. *Milton.*

3. To rattle, or give a heavy rattling sound.

And roll the *thund'ring* chariot o'er the  
ground. *J. Trumbull.*

**THUNDER**, *v. t.* To emit with noise and terror.

Oracles severe

Were daily *thunder'd* in our gen'ral's ear.  
*Dryden.*

2. To publish any denunciation or threat.

An archdeacon, as being a prelate, may  
*thunder* out an ecclesiastical censure.  
*Ayliffe.*

**THUNDER-BLÄSTED**, *a.* Blasted by thunder.

**THUNDERBOLT**, *n.* [*thunder* and *bolt*.] A shaft of lightning; a brilliant stream of the electrical fluid, passing from one part of the heavens to another, and particularly from the clouds to the earth; Ps. lxxviii. In *popular lan.*, when lightning acts with extraordinary violence, and breaks or shatters any thing, it is called a *thunderbolt*, and ignorant people suppose it to be a hard body, otherwise it could not produce such effects.—2. Figuratively, a daring or irresistible hero; as, the Scipios, those *thunderbolts* of war.—3. Fulmination; ecclesiastical denunciation.

He severely threatens such with the  
*thunderbolt* of excommunication. *Hakewill.*

4. In *mineral*, thunder-stone.

**THUNDER-BURST**, *n.* A burst of thunder.

**THUNDER-CLAP**, *n.* [*thunder* and *clap*.] A burst of thunder; sudden report of an explosion of electricity.

When suddenly the *thunder-clap* was heard.  
*Dryden.*

**THUNDER-CLOUD**, *n.* [*thunder* and *cloud*.] A cloud that produces lightning and thunder.

**THUNDERER**, *n.* He that thunders.

**THUNDER-HOUSE**, *n.* An instrument for illustrating the manner in which buildings receive damage by lightning, when not protected by thunder rods or conductors. It is in the form of a small model of a house, having wires connected with it so as to form imperfect conductors.

**THUNDERING**, *ppr.* Making the noise of an electrical explosion; uttering a loud sound; fulminating denunciations. *Thundering barrels*, casks which contain the fire pots in a fire ship.

**THUNDERING**, *n.* The report of an electrical explosion; thunder.

Entreat the Lord that there be no more  
mighty *thunderings* and hail; Exod. ix.

**THUNDERINGLY**, *adv.* With loud noise.

**THUNDEROUS**, *a.* Producing thunder.

How he before the *thunderous* throne doth  
lie. [*Little used.*] *Milton.*

**THUNDER-PROOF**, *a.* Secure against thunder.

**THUNDER-ROD**, *n.* A rod or bar of metal, attached to a building, and having its lower end extending below the level of the ground, and its upper end rising several feet above the highest part of the building, or of the steeple, if the building have one, in order to protect the building from the effects of lightning: the upper extremity of the rod is made to terminate in a point. Extensive buildings, or those which have several pinnacles rising from their tops, require several rods for their protection, as it is found that the influence of a single rod is limited by the circumference of a circle described about the rod, with a radius equal to twice its height above the top of the building. Ships are protected from the effects of lightning by rods in the same manner as buildings. Thunder rods are also termed *conductors*, because they serve to conduct the electric fluid or lightning which strikes them safely and rapidly to the ground, and do not allow it to fall upon any part of the building.

**THUNDER-SHOWER**, *n.* [*thunder* and *shower*.] A shower accompanied with thunder.

**THUNDER-STONE**, *n.* Thunder stones are crystals of iron pyrites, of a cylindrical form, found in chalk beds, and were so named because they were fabulously supposed to be emitted by thunder. The same name is given to fossil echinites of the family *cidaris*.

**THUNDER-STORM**, *n.* [*thunder* and *storm*.] A storm accompanied with lightning and thunder, generally preceded by a tempestuous wind, which soon subsides, and succeeded by violent showers of rain or hail, or both together. Such storms are common in tropical regions, and often cause great damage. In America, the violence of the wind at the commencement of the storm is sometimes equal to that of a hurricane, and then it is the explosions of electricity are the most terrible. This violence of the wind seldom continues longer than a few minutes, and after it subsides, the rain continues, but the peals of thunder are less frequent. These violent showers sometimes continue for hours; more generally, they are of shorter duration.

**THUNDER-STRIKE**, *v. t.* [*thunder* and *strike*.] 1. To strike, blast, or injure by lightning. [*Little used in its literal sense.*]—2. To astonish or strike dumb, as with something terrible. [*Little used except in the participle.*]

**THUNDER-STROKE**, *† n.* A thunder clap.

**THUNDER-STRUCK**, *pp. or a.* Astonished; amazed; struck dumb by something surprising or terrible suddenly presented to the mind or view. [*This is a word in common use.*]

**THUNDERY**, *a.* Accompanied with thunder.

**THUN'NY**, *n.* A fish. [*See TUNNY.*]

**THU'RIBLE**, *† n.* [*L. thuribulum*, from *thus*, *thuris*, frankincense.] A censer; a pan for incense.

**THURIFEROUS**, *a.* [*L. thurifer*; *thus* and *fero*, to bear.] Producing or bearing frankincense.

**THURIFICATION**, *n.* [*L. thus*, *thuris*, and *facio*, to make.] The act of fuming with incense; or the act of burning incense.

**THURLS**, *n.* Among *miners*, the name given to short communications between the adits in mines.

**THURS'DAY**, *n.* [*Dan. Torsdag*, that is, *Thor's day*, the day consecrated to *Thor*, the god of thunder, answering to the Jove of the Greeks and Romans, *L. dies Jovis*; *It. Giovedì*; *Sp. Jueves*; *Fr. Jeudi*. So in *G. donnerstag*, *D. donderdag*, *thunder-day*. This *Thor* is from the root of *W. taran*, *thunder*; *taraw*, to strike, hit, or produce a shock; Gaelic and *Ir. toirn*, a great noise; *toirneas*, *thunder*. The root of the word signifies to drive, to rush, to strike. In *Sw. thórðon* is *thunder*.] The fifth day of the week.

**THUS**, *adv.* [*Sax. thus*; *D. dus*.] 1. In this or that manner; on this wise; as, *thus* saith the Lord; the Pharisee prayed *thus*.

*Thus* did Noah, according to all that God commanded him; Gen. vi.

2. To this degree or extent; as, *thus* wise; *thus* peaceable.

*Thus* far extend, *thus* far thy bounds.  
*Milton.*

3. In the phrase, *thus much*, it seems to be an adjective, equivalent to *this much*.

**THUS**, *n.* [*Gr. θυς*, to sacrifice, because it was used by the ancients in sacrifices.] Frankincense,—*which see*. The same name is given to the resin of the spruce fir.

**THWACK**, *v. t.* [*Qu. Sax. thaccian*, to feel or stroke lightly. It does not well accord with this verb. The word *twit* is the *Sax. athwitian*, or *othwitian*, a compound of *ath* or *oth*, to or at, and *witan*. In like manner, *thwack* may be formed from our vulgar *whack*, which is precisely the *Eth. wahea*, *Ar. wahaa*, to strike.] To strike with something flat or heavy; to bang; to beat or thrash. [*This and the two following words are only used in low or ludicrous language.*]

**THWACK**, *n.* A heavy blow with something flat or heavy; a bang.

**THWACK'ING**, *ppr.* Striking with a heavy blow.

**THWAITE**, *n.* A fish, a variety of the shad, *Alosa finta*.—2. A plain parcel of ground, cleared of wood and stumps, inclosed and converted to tillage. [*Local.*]

**THWART**, *a.* (thwort.) [*D. dwars*; *Dan. tver, tvert, tvers*; *Sw. tvärs, tvart*; probably a compound of *Sax. ath, oth*, to, and the root of *veer*, *L. verito, versus*.] Transverse; being across something else.

Moved contrary with *thwart* obliquities.  
*Milton.*

2. † Perverse.

**THWART**, *v. t.* (thwort.) To cross; to belie; or come across the direction of something.

Swift as a shooting star

In autumn *thwarts* the night. *Milton.*

2. To cross, as a purpose; to oppose; to contravene; hence, to frustrate or defeat. We say, to *thwart* a purpose, design, or inclination; or to *thwart* a person.

If crooked fortune had not *thwarted* me.  
*Shak.*

The proposals of the one never *thwarted*

the inclinations of the other. *South.*

**THWART**, *v. i.* To be in opposition.

A proposition that shall *thwart* at all with these internal oracles. [*Unusual and improper.*] *Locke.*

**THWART** † *adv.* Obliquely; *athwart*.

**THWART**, *n.* The seat or bench of a boat on which the rowers sit, placed athwart the boat.

**THWART'ED**, *pp.* Crossed; opposed; frustrated.

**THWART'ER**, *n.* A disease in sheep, indicated by shaking, trembling, or convulsive motions.

**THWART'ING**, *ppr.* Crossing; contravening; defeating.

**THWART'ING**, *n.* The act of crossing or frustrating.

**THWART'INGLY**, *adv.* In a cross direction; in opposition.

**THWART'NESS**, *n.* Untowardness; perverseness.

**THWART'SHIPS**, *adv.* Across the ship.

**THWHITE**, *v. t.* [Sax. *thwitan*.] To cut or clip with a knife. [Local.]

**THWIT'TLE**, *v. t.* To whittle. [See WHITTLE.]

**THY**, *a.* [contracted from *thine*, or from some other derivative of *thou*.] It is probable that the pronoun was originally *thig*, *thug* or *thuk*, and the adjective *thigen*. See **THOU**. *Thy* is the adjective of *thou*, or a pronominal adjective, signifying of thee, or belonging to thee, like *tuis* in Latin. It is used in the solemn and grave style. These are *thy* works, Parent of good.

*Milton.*

**THY'INE WOOD**, *n.* [Gr. *thyvov*.] A precious wood, mentioned Rev. xviii. It seems to have been the wood of the *thuja articulatus*, or jointed arbor vitæ of Africa, which yields a wood of delightful scent. [See **THUJA**.]

**THY'ITE**, *n.* The name of a species of indurated clay, of the morochthus kind, of a smooth regular texture, very heavy, of a shining surface, and of a pale green colour.

**THYME**, *n.* usually pronounced *time*. [Fr. *thym*; L. *thymus*; Gr. *θυμνος*.] In *bot.*, a genus of plants (*Thymus*), nat. order Lamiaceæ. The species are small undershrubs, most of them inhabitants of Europe; only one species is a native of Britain, viz., wild thyme, (*T. serpyllum*), although the Linnæan genus *Thymus* included other three British plants, but these are now referred to *Acinos* and *Calamintha*. The common or garden thyme, (*T. vulgaris*) has long been a favourite plant on account of its strong, pungent, aromatic odour and taste, and many varieties of it are cultivated in gardens. It is a native of the south-west parts of Europe, and is employed for culinary purposes. It yields an essential oil, which is extremely acrid and pungent. Wild thyme or mother of thyme, (*T. serpyllum*), grows in Britain on hills and in dry pastures, and has the same sensible properties as the garden thyme. Bees are said to be greatly attached to this plant, and it has been alleged to give a fine flavour to mutton. The volatile oil obtained from the wild and garden thyme, is frequently used as an application to carious teeth. It is also much used for culinary purposes.

**THYMELA'CEÆ**, *n.* [from *thymela*, one of the genera.] A nat. order of shrubby exogens, related to *Santalaceæ*, from which it differs in its inferior calyx. It consists of shrubs or small trees, with non-articulated, sometimes spiny branches, having a very tenacious bark. The species are not common in Europe; they are found chiefly in the cooler parts of India and South America, at the Cape of Good Hope,

and in New Holland. The *Daphnes* are valued for their fragrance; the various species of the Australian genus *Pimelea*, and the *Gnidias* and *Struthiolas* of the Cape of Good Hope, are favourite objects of cultivation. The most remarkable property of the order is the causticity which resides in the bark. When applied to the skin it acts as a blister; and when chewed it produces pain in the mouth. The berries of *Daphne laureola*, are poisonous to all animals, except birds. The bark of some species is manufactured into cordage.

**THYMELA'CEOUS**, *a.* In *bot.*, relating to or like the *thymelaceæ*.

**THY'MUS**, *n.* [Gr. *θυμνος*.] In *anat.*, a glandular nody, divided into lobes, situated behind the sternum in the duplicature of the mediastinum. It is largest in the fetus, diminishes after birth, and in adults often entirely disappears. It has no excretory duct, and its use is unknown. In calves and lambs it is called *sweet-bread*; but the term *sweet-bread* is also applied to the *pancreas*, a very different organ.—2. A genus of plants. [See **THYME**.]—3. In *surg.*, a small indolent fleshy tubercle, arising about the anus, or the pudenda, and resembling the flowers of thyme; whence the name.

**THY'MY**, *a.* Abounding with thyme; fragrant.

**THY'N'NUS**, *n.* A subdivision of the genus Scomber, (*mackerel*), to which the fish called the *tunny*, (*Thynnus vulgaris*, Cuvier), belongs. [See **TUNNY**.]

**THY'RIS**, *n.* [Gr. *θυρίς*.] In *entom.*, a genus of butterflies.

**THY'ROID**, } *a.* [Gr. *θυροειδης*, a shield, }  
**THY'REOID**, } and *υδοειδης*, form.] Resembling a shield; applied to one of the cartilages of the larynx, so called from its figure, to a gland situated near that cartilage, and to the arteries and veins of the gland. The *thyroid cartilage* constitutes the anterior, superior, and largest part of the larynx. The *thyroid gland* is situated on the sides and front of the lower part of the larynx, and the upper part of the trachea. It is copiously supplied with blood, but is not known to furnish any secretion. It is the seat of the bronchocele or goitre.

**THY'R'OSE**, } *n.* [L. *thyrsus*; Gr. *θυρσος*.]

**THY'R'SUS**, } 1. In *bot.*, a species of inflorescence; a panicle contracted into an ovate form, or a dense or close panicle, more or less of an ovate figure, as in the lilac, privet, and horse chestnut.—2. A panicle, whose middle branches are longer than those of the base and apex.—3. In *Grecian and Roman antiquities*, one of the most common attributes of Bacchus and his followers. It consisted of a spear or staff wrapped round with ivy and vine branches, or of a lance having the iron part thrust into a cone of pine. The Bacchanals carried *thyrsi* in their hands when they celebrated the orgies of Bacchus.

**THYRS'OID**, *a.* In *bot.*, having some-what the form of a thyrsus.

**THYSANU'RANS**, } *n. plur.* [Gr. **THYSANU'RA**, } *θυσανουρας*, having a long bushy tail.] An order of apterous insects, supported by six feet, that undergo no metamorphosis, and have, in addition, particular organs of motion, either on the sides, or at the extremity of the abdomen.

**THYSELF**, *pron.* [*thy* and *self*.] A

pronoun used after *thou*, to express distinction with emphasis. "*Thou thyself shalt go*;" that is, thou shalt go and no other. It is sometimes used without *thou*, and in the nominative as well as objective case.

These goods *thyself* can on *thyself* bestow. *Dryden.*

**TI'AR**, *n.* A tiara,—which see.

**TIA'RA**, *n.* [Fr. *tiare*; L. Sp. and It. *tiara*; Gr. *τιαρα*; Sax. *tyr*; Syr. *chadar*, and Heb. *תַּרְסָן*, *atar*.] From the former probably the Latins had their *cidaris*, and *tiara* from the latter; the same word with different prefixes.]

1. An ornament or article of dress with which the ancient Persians covered their heads; a kind of turban. As different authors describe it, it must have been of different forms. The kings of Persia alone had a right to wear it straight or erect; the lords and priests wore it depressed, or turned down on the fore side. Xenophon says the tiara was encompassed with the diadem, at least in ceremonials.—2. An ornament worn by the Jewish high priest; Exod. xxviii.—3. The pope's triple crown. The tiara and keys are the badges of the papal dignity; the tiara of his civil rank, and the keys of his jurisdiction. It was formerly a round high cap. It was afterward encompassed with a crown, then with a second and a third rising one above the other. These crowns are covered with precious stones, and ornamented with an orb, on which stands a cross, and on two sides of it a chain of precious stones.—4. Figuratively, the papal dignity.

**TIA'RAED**, *a.* Adorned with a tiara.

**TIA'RIS**, *n.* The name given by Swainson to a genus of Fringillidæ, or finches, and which is placed by him between *Amadina* and *Carduelis*. The birds belonging to this genus belong to South America only.

**TIB'IA**, *n.* [L.] The largest bone of the leg. It is of a long, thick, and triangular shape, and is situated on the internal part of the leg. Its name is said to have reference to its resemblance to the ancient pipe or flute (*tibia*).—2. In *entom.*, the fourth joint of the leg.

**TIB'IAL**, *a.* [L. *tibia*, a flute, and the large bone of the leg.] 1. Pertaining to the large bone of the leg; as, the *tibial artery*; *tibial nerve*. The *tibial arteries* are the two principal branches of the popliteal artery.—2. Pertaining to a pipe or flute.

**TIB'URO**, *n.* A fish of the shark kind.

**TICAL'**, *n.* A Siamese coin, worth about 2s. 6d. sterling.

**TIC DOULOUREUX'**, *n.* [Fr. *tic*, spasm, and *dououreux*, painful.] A very painful affection of a nerve, coming on in sudden and excruciating attacks. It is characterized by acute pain, attended with convulsive twitchings of the muscles, and continuing from a few minutes to several hours. It is a species of neuralgia, and most commonly attacks the facial nerves. The cause of this affection is unknown, and it often baffles the skill of the physician.

**TICE**, } *†* for *Entice*.

**TICH'ORRHINE**, *n.* In *geol.*, a fossil species of rhinoceros.

**TICK**, *n.* [In Gaelic, *doigh* is trust. But *tick* may signify a cut, a notch, *W. tuc*, from the manner of keeping accounts among unlettered men. See **DOCK** and **TICKET**.] Credit; trust;

score; as, to buy upon *tick*. To go on *tick*, to go on trust or credit. [*Vulgar.*]

**TICK, n.** [Fr. *tique*; G. *zecke*; It. *zecca*.] The common name of various parasitical insects of the genus *Acarus*, Linn., and which are otherwise termed *mites*. They are very small animals, of a livid colour, and globose-ovate form, that infest sheep, dogs, goats, cows, &c. The dog-tick is the *A. ricinus*; the domestic tick is the *A. domesticus*; and the itch-tick is the *A. scabiei*. The ticks form the genus *Ixodes* of Latreille.

**TICK, n.** [D. *teek*, *tyk*; probably from covering, L. *tego*, Eng. to *deck*; Russ. *tih*, tent-cloth.] The cover or case of a bed, which contains the feathers, wool, or other material.

**TICK, v. i.** [from *tick*, credit.] To run upon score.—2. To trust.

**TICK, v. i.** [D. *tikken*.] It coincides in elements with L. *tango*, *tago*.] To beat; to pat; or to make a small noise by beating or otherwise; as a watch.

**TICK-BEAN, n.** A variety of the common bean (*Faba vulgaris*), and of a smaller size. It is used for feeding horses and other animals.

**TICKEN, } n.** A sort of strong linen  
**TICKING, }** or cotton for bed-ticks, or cases for beds.

**TICKET, n.** [Fr. *étiquette*; W. *tocyn*, a short piece or slip, a ticket, from *tociao*, to curtail, to clip, to *dock*. We have *dock* and *dochet* from the same root. It denotes a piece or slip of paper.] 1. A piece of paper or a card, which gives the holder a right of admission to some place; as, a *ticket* for the play-house or any other exhibition.—2. A piece of paper or writing, acknowledging some debt, or a certificate that something is due to the holder. Of such a nature is a railway *ticket*, and a pawnbroker's *ticket*; but the latter is more usually called a *duplicate*.—3. A piece of paper bearing some number in a lottery, which entitles the owner to receive such prize as may be drawn against that number. When it draws no prize, it is said to draw a blank, and the holder has nothing to receive.—4. A notice put on a window, or attached to a wall; as, *tickets* of goods to sell, houses, or lodgings to let, &c.

**TICK'ET, v. t.** To distinguish by a ticket.

**TICK'ETED, pp.** Distinguished by a ticket.

**TICK'ETING, ppr.** Distinguishing by a ticket.—2. *a.* Relating to, or by means of tickets attached; as, retailers of wares now deal much on the *ticketing* system.

**TICK'ET-PORT'ER, n.** A licensed porter who wears a ticket, by which he may be identified.

**TICKING, ppr.** Beating; patting.—2. Trusting; scoring.

**TICKING, See TICKEN.**

**TICK'LE, v. t.** [*dim.* of *touch*; perhaps directly from *tich*, to pat, or it is the L. *titillo*, corrupted.] 1. To touch lightly and cause a peculiar thrilling sensation, which cannot be described. A slight sensation of this kind may give pleasure, but when violent it is insufferable.—2. To please by slight gratification. A glass of wine may *tickle* the palate.

Such a nature  
*Tickled* with good success. *Shak.*

**TICK'LE, v. i.** To feel titillation.

He with secret joy therefore  
Did *tickle* inwardly in every vein. *Spenser.*

**TICK'LE, a.** Tottering; wavering, or liable to waver and fall at the slightest touch; unstable; easily overthrown.

Thy head stands so *tickle* on thy shoulders,  
that a milkmaid, if in love, may sigh it off. *Shak.*

The state of Normandy  
Stands on a *tickle* point. *Shak.*

[This word is obsolete. *Ticklish* is the word used.]

**TICK'LE-BRAIN, } n.** He, who, or  
that which tickles or pleases.

**TICK'LENESS, } n.** Unsteadiness.

**TICK'LER, n.** One that tickles or pleases.

**TICK'LING, ppr.** Affecting with titillation.

**TICK'LING, n.** The act of affecting with titillation.

**TICK'LISH, a.** Sensible to slight touches; easily tickled. The bottom of the foot is very *ticklish*, as are the sides. The palm of the hand, hardened by use, is not *ticklish*.—2. Tottering; standing so as to be liable to totter and fall at the slightest touch; unfixed; easily moved or affected.

Ireland was a *ticklish* and unsettled state. *Bacon.*

3. Difficult; nice; critical; as, these are *ticklish* times.

**TICK'LISHLY, adv.** In a ticklish manner.

**TICK'LISHNESS, n.** The state or quality of being *ticklish* or very sensible.—2. The state of being tottering or liable to fall.—3. Criticalness of condition or state.

**TICKS, n.** Tick-beans. [See TICK-BEAN.]

**TICK-SEED, n.** A plant of the genus *Coreopsis*, and another of the genus *Corispermum*.

**TICK'TACK, n.** A word expressive of the sounds produced by the beating of a watch, or of sounds resembling it.—2. A game at tables. [See TRIC-TRAC.]

**TICK'TACK, adv.** With a sound resembling the beating of a watch.

**TID, a.** [Sax. *tydder*.] Tender; soft; nice.

**TIDAL, a.** Pertaining to tides; periodical rising and falling, or flowing and ebbing; as, *tidal* waters.—*Tidal* harbours, harbours into which the tide flows, in distinction from such as are kept at high-water by means of docks with flood-gates.—*Tidal* river, a river into which the tide flows.

**TID'BIT, n.** [*tid* and *bit*.] A delicate or tender piece of anything eatable. It is often written and pronounced *Tibbit*.

**TID'DLE, } v. t.** To use with tender-  
**TID'DEL, }** ness; to fondle.

**TID'DLED, pp.** Fondled.

**TIDE, n.** [Sax. *tidan*, to happen; *tid*, time, season, opportunity, an hour; G. *zeit*; D. *tyd*. This word is from a root that signifies to come, to happen, or to fall or rush, as in *betide*; corresponding in sense with time, season, hour, opportunity. *Tid*, time, is the fall, the occasion, the event. Its original meaning is entirely obsolete, except in composition, as in *Shrovetide*, *Whitsuntide*.] 1. Time; season.

Which, at the appointed *tide*,  
Each one did make his bride. *Spenser.*

[This sense is obsolete.]

2. The alternate rising and falling of the waters of the ocean, and of bays, rivers, &c., connected therewith. The tide appears as a general wave of water, which gradually elevates itself to a certain height, then as gradually

sinks till its surface is about as much below the medium level as it was before above it. From that time the wave again begins to rise; and this reciprocating motion of the waters continues constantly, with certain variations in the height, and in the times of attaining the greatest degree of height and of depression. The alternate rising and falling of the tide wave are observed to take place, generally twice in the course of a lunar day, or of 24h. 49m. of mean solar time, in most of the shores of the ocean, and in the greater part of the bays, firths, and rivers which communicate freely with it. The tides form what are called a *flood* and an *ebb*, a *high* and *low* water. The whole interval between high and low water is called a *tide*; the water is said to *flow* and to *ebb*, and the rising is called the *flood* *tide*, and the falling the *ebb* *tide*. The rise or fall of the waters, in regard to elevation or depression, is exceedingly different at different places, and is also variable everywhere. The different heights of tide succeed each other in a regular series, diminishing from the greatest to the least, and then increasing from the least to the greatest. The greatest is called a *spring* *tide*, and the least a *neap* *tide*. This series is completed in about 15 days, or rather two series are completed in a lunar month. For the spring tide at any place happens at a certain interval of time, generally between one and two days, after new or full moon; and the neap tide, at a certain interval after the first or last quarter. Thus, the whole series of tides appears to be chiefly regulated by the moon, and to be only to a small extent under the influence of the sun. The moon, by her attraction, not only raises the waters of the ocean under her, but also at the same time raises them on the opposite side; the sun also raises similar waves by his attraction, but to a much less extent, owing to his great distance. Hence, the combined actions of the sun and moon, when these bodies are in conjunction, or opposition, that is at new or full moon, may be readily conceived to produce the spring tides, and the diminutions of each other's attractions when in quadratures to produce the neap tides. These tides will also vary, according as the sun or moon is in perigee or apogee, and likewise according to their respective declinations. The interval between two succeeding high waters is variable. It is shortest about new and full moon, being then about 12h. 19m.; and about the time of the moon's quadratures it is 12h. 30m. But these intervals are somewhat different at different places. The tides being of great importance to all commercial nations, it becomes an object of great importance to obtain the means of predicting them, but the subject, in a general point of view, is attended with many difficulties, and each place requires to have its own tide tables. The theory of the tides, considered as a consequence of the attractions of the sun and moon, unites some of the greatest difficulties that occur in the various departments of natural philosophy and astronomy.—*Atmospheric* *tides*, waves produced in the atmosphere similar to those produced in the waters of the ocean, and by the same causes, viz., the attractions of the sun and moon.—

*Priming and lagging of the tides*, an effect of the combination of the solar and lunar tides. In the first and third quarters of the moon, the solar wave is to the westward of the lunar one, and consequently the observed tide, which is the result of the combination of the two waves, will be to the westward of the place it would occupy, if the moon acted alone, and the time of high water will be accelerated. Hence what is termed the *priming* of the tides. In the second and fourth quarters, the general effect of the sun is to produce, for a like reason, a retardation in the time of high water. Hence what is called the *lagging* of the tides. These effects are most remarkable about the time of new and full moon.—3. Stream; course; current; as, the *tide of the times*.

Time's ungentle *tide*. *Byron.*

4. Favourable course.

There is a *tide* in the affairs of men,  
Which, taken at the flood, leads on to fortune.

*Shak.*

5. † Violent confluence; accumulated multitude.—6. Among *miners*, the period of twelve hours.—7. Current; flow of blood.

And life's red *tide* runs ebbing from the wound. *Battle of Frogs and Mice.*

TIDE, *v. t.* To drive with the stream.

TIDE, *v. i.* To work in or out of a river or harbour by favour of the tide, and anchoring when it becomes adverse.—2. To pour a flood; to be agitated by the sea.—*To tide it*, is to pursue a ship's course by means of the tide, with a foul wind, anchoring during the intervals of the contrary tide.—*To tide over*, used metaphorically, is to surmount difficulties by means of a succession of favourable incidents, or by delay merely; as, the unpopular premier managed to *tide over* the parliamentary session.

TIDE, † *v. i.* To betide.

TIDE-DIAL, *n.* A dial for exhibiting the state of the tides at any place.

TIDE-GATE, *n.* A gate through which water passes into a basin when the tide flows, and which is shut to retain the water from flowing back at the ebb.—2. Among *seamen*, a place where the tide runs with great velocity.

TIDE-GAUGE, *n.* A contrivance for registering the state of the tide continuously at every instant of time.

TIDELESS, *a.* Having no tide.

TIDE-LOCK, or GUARD-LOCK, *n.* A lock situated between an entrance-basin and a canal, harbour, or river, and forming a communication between them. It has double gates by which vessels can pass either way, at all times of the tide.

TIDE-MILL, *n.* [*tide* and *mill*.] A kind of water-mill in which the machinery is driven by the alternate flow and ebb of the tide, acting upon a water-wheel. The water required for impelling the machinery may be admitted either from the side of a river into which the tide flows, or immediately from the sea. Tide-mills are employed for grinding corn; but they have never been brought into common use, on account of the great expense of their construction.

TIDES-MAN, *n.* An officer who remains on board of a merchant's ship till the goods are landed, to prevent the evasion of the duties.

TIDE-TABLES, *n.* Tables shewing the time of high-water at any place, or at different places, for each day

throughout the year. Such tables are given in most almanacs.

TIDE-WAITER, *n.* [*tide* and *waiter*.]

An officer who watches the landing of goods, to secure the payment of duties.

TIDE-WAY, *n.* [*tide* and *way*.] The channel in which the tide sets.

TYDIED, *pp.* Made tidy.

TYDILY, *adv.* [from *tidy*.] Neatly; with neat simplicity; as, a female *tidily* dressed.

TYDINESS, *n.* Neatness without richness or elegance; neat simplicity; as, the *tydiness* of dress.—2. Neatness; as, the *tydiness* of rooms.

TYDINGLESS, *a.* Having no tidings.

TYDINGS, *n. plur.* [Sw. *tydning*; Dan. *tydende*, news. It is the participle of Sax. *tydan*, to happen, or some other verb connected with *tide*, and denotes coming, or that which arrives.] News; advice; information; intelligence; account of what has taken place, and was not before known.

I shall make my master glad with these tidings. *Shak.*

Behold, I bring you good tidings of great joy, which shall be to all people; Luke ii.

TYDY, *a.* [from *tide*, time, season; Dan. and Sw. *tydig*, seasonable.] 1. In its primary sense, seasonable; favourable; being in proper time; as, weather fair and *tydy*.—2. Neat; dressed with neat simplicity; as, a *tydy* lass; the children are *tydy*; their dress is *tydy*; that is primarily, proper for the time or occasion.—3. Neat; being in good order. The apartments are well furnished and *tydy*.

TYDY, *v. t.* To make neat; to put in good order.

TYDYING, *ppr.* Making tidy.

TIE, *v. t.* [Sax. *tian*, for *tigan*, to bind; *tig*, *tige*, a tie, a purse. The primary sense is to strain, and hence its alliance to *tug*, to draw, Sw. *tiga*, L. *taceo*, to be silent. The Gr. *δῆω* may be the same word.] 1. To bind; to fasten with a band or cord and knot.

My son, keep thy father's commandments...bind them continually upon thine heart, and tie them about thy neck; Prov. vi. 2. To fold and make fast; as, to tie a knot.—3. To knit; to complicate.

We do not tie this knot with an intention to puzzle the argument. *Burnet.*

4. To fasten; to hold; to unite so as not to be easily parted.

In bond of virtuous love together tied. *Fairfax.*

5. To oblige; to constrain; to restrain; to confine. People, in their jealousy, may tie the hands of their ministers and public agents, so as to prevent them from doing good.

Not tied to rules of policy, you find  
Revenge less sweet than a forgiving mind. *Dryden.*

6. In *music*, to unite notes by a cross line, or by a curve line drawn over them or under them.—7. In *arch.*, to bind together two bodies by means of a piece of timber or metal. [See the *noun*.]—*To tie up*, to confine; to restrain; to hinder from motion or action; as, to tie up the tongue; to tie up the hands.—*To tie down*, to fasten so as to prevent from rising.—2. To restrain; to confine; to hinder from action.

TIE, *n.* A knot; fastening.—2. Bond; obligation, moral or legal; as, the sacred ties of friendship or of duty; the ties of allegiance.—3. A knot of hair.—4. In *arch.*, a timber-string,

chain, or a rod of metal connecting and binding two bodies together which have a tendency to separate or diverge; such as tie-beams, diagonal ties, truss-posts, &c.—*Angle-tie*, angle brace. [See *under ANGLE*.]—5. In *music*, a character used to connect syncopated notes; a ligature.—6. An equality in numbers, as of votes, &c., which prevents either party from being victorious.—*Ride and tie*, a term familiarly used when two persons travel having but one horse to use: each gets up as the other gets down, and thus they are said to *ride and tie*.

TIE-BEAM, *n.* In *arch.*, the beam which connects the bottom of a pair of principal rafters, and prevents them from thrusting out the wall. [See *Roof*.]

TYED, *pp.* Bound; fastened with a knot; confined; restrained; united, as notes.

TIER, *n.* [Heb. *תור*, *tur*. See *TIRE*.] A row; a rank; particularly when two or more rows are placed one above another; as, a tier of seats in a theatre; a tier of casks; a tier of balls, &c. Thus in ships of war, the range of guns on one deck and one side of a ship, is called a tier. Those on the lower deck are called the lower tier, and those above, the middle or upper tiers. Ships with three tiers of guns are three-deckers. The tiers of a cable are the ranges of fakes or windings of a cable, laid one within another when coiled.—*Tier*, in *organs*, is a rank or range of pipes in the front of the instrument, or in the interior, when the compound stops have several ranks of pipes.

TIERCE, *n.* (ters.) [Fr. from *tiers*, third.] 1. Formerly, a liquid measure equal to one-third of a pipe, or 42 gallons, equal to 35 imperial gallons. The same name was given to the cask containing 42 gallons.—2. A weight by which provisions are sold. The tierce of beef for the navy, is 304lb., and for India, 336lb.—3. In *music*, a major or minor third.—4. In *gaming*, a sequence of three cards of the same colour.—5. A thrust in fencing.—6. In *her.*, a term for the field when divided into three equal parts of different colours or metals.—*Tierce point*, in *arch.*, the vertex of an equilateral triangle.

TIER/CEL, } *n.* In *falconry*, a name  
TIER/CELET, } given to the male hawk, as being a third part less than the female.

TIERCE-MA'JOR, *n.* In *gambling*, a sequence of the three best cards.

TIER/CET, *n.* (ter'cet.) [from *tierce*.] In *poetry*, a triplet; three lines, or three lines rhyming.

TIERSES ETAT, *n.* (teerz'a-tā') [Fr.] In *France*, the third branch or estate; the commonalty, answering to the commons in Great Britain. Previous to the first revolution, the French were divided into three classes or estates, the nobles, the clergy, and the commonalty. At present, however, the tiers *etat* may be considered as the nation itself.

TIEUK, *n.* The name given to a kind of upas poison procured from the Strychnos Tieute. It produces tetanic spasms.

TIFF, *n.* [Qu. *tippie tope*.] 1. Liquor; or rather a small draught of liquor. [See *Vulgar*.]—2. A pet or fit of peevishness; a slight altercation.

TIFF, *v. i.* To be in a pet. [See *Low*.]

TIFF, † *v. t.* [F. *tiffer*.] To dress; to deck.

**TIF'FANY, n.** [According to the Italian and Spanish Dictionaries, this word is to be referred to *taffeta*, but it seems rather to be derived from the French *tiffer*, to dress, to adorn.] A species of gauze or very thin silk.

**TIFFEDEMER, n.** A species of sea plant, so called by Count Marsigli, from its resemblance to the heads of the *Typha palustris*, or cat's tail. It has a smooth surface and a velvety look. It grows to two feet in height, and is elegantly branched. It grows on rocks and stones, and when first taken out of the sea, is full of a yellow viscous water, but when this is pressed out and the substance is dried, it becomes of a dusky brown colour.

**TIF'FIN, n.** A word introduced from India, denoting a lunch or slight repast between breakfast and dinner.

**TIG, n.** A play. [See TAG.]

**TIGE, n.** [Fr. a stalk.] The shaft of a column from the astragal to the capital.

**TY'GER, n.** [Fr. *tigre*; It. *tigro*; L. *tigris*; said to be from גיר *gir*, a dart; whence גיר *tiger*.] A fierce and rapacious animal of the genus *Felis*, (*F. tigris*.) The tiger, or royal tiger as it is called, is as large as the lion, but the body is longer, and the head rounder; of a lively fawn colour above; a pure white below, irregularly crossed with black stripes. It is clothed with



Bengal tiger (*Felis tigris*).

short hairs, and has no mane. The tiger is found in Asia only, and is rarely, if ever met with on this side of the Indus. He is the most formidable and cruel of all quadrupeds, and the scourge of the less inhabited parts of India. He is insidious, blood-thirsty, and malevolent, and seems to prefer preying on the human race. The bound with which the ambushed tiger throws himself upon his prey, is as wonderful in its extent, as it is terrible in its effects. Man is a mere puppet in his gripe; and the Indian buffalo is not only borne down by him, but carried off by his enormous strength. The American tiger is the jaguar (*Felis onca*, Linn.) an inhabitant of South America. The jaguar is nearly as large as the royal tiger, and in some districts almost as dangerous. [See JAGUAR.]—*Tiger-cats*, the common name of all those lesser striped and spotted Asiatic, African, and American cats, which do not come under the well understood denomination of Tigers, Leopards, and Panthers; as, the *Felis nepalensis* of Asia, the *Felis serval* of Africa, and the *Felis pardalis* or ocelot of America.—2. A servant in livery who rides with his master or mistress. **TY'GER-BITTERN, n.** A bird of South America, of the genus *Tigrisoma*, of Swainson, belonging to the family Ardeade. It receives its name from the marblings on its body, somewhat resembling those of a tiger.

**TY'GER-FLOWER, n.** *Tigridia*, a genus of bulbous plants, nat. order Iridaceæ. They are natives of Mexico, and bear remarkably curious, though fugitive flowers. *T. pavonia* is frequently cultivated in gardens, on account of the magnificence of its flowers.

**TY'GER-FOOTED, a.** Hastening to devour; furious.—2. † Swift as a tiger.

**TY'GERISH, a.** Like a tiger.

**TY'GER-LILY, n.** A plant of the genus liliun, the *L. tigrina*, having the upper leaves cordate, oval, and the petals spotted.

**TY'GER-MOTH, n.** In *entom.*, a name given by collectors to the individuals of various species of moths, of the genera *Arctia*, *Hypercampa*, and *Nemophila*.

**TY'GER-MOTH, n.** A large moth, with richly streaked wings.

**TY'GER'S-FOOT, n.** A plant of the genus *Ipomœa* or *Convolvulus*.

**TY'GER-SHELL, n.** [*tiger* and *shell*.] A name given to a red shell with large white spots. In the Linnæan system, the *tiger-shell* is a species of *Cypræa*, the *C. tigris*; also called *tiger-cowry*.

**TIGH, n.** In *Kent*, a close or inclosure.

**TIGHT, a.** [G. *dicht*; D. Sw. and Dan. *digt*; allied to *thick* and *tie*, and to Sw. *tiga*, to be silent, L. *taceo*; that is, close, closely compressed; Russ. *tugel*, stuff. See TACK.] 1. Close; compact; not loose or open; having the joints so close that no fluid can enter or escape; not leaky; as, a *tight ship*, or a *tight cask*.—2. Close; not admitting much air; as, a *tight room*.—3. Sitting close to the body; as, a *tight coat* or other garment.—4. Close; not having holes or crevices; not loose; applied to many vessels, &c.—5. Close; hard; as, a *tight bargain*.—6. Close; parsimonious; saving; as, a man *tight* in his dealings.—7. Closely dressed; not ragged.

I'll spin and card, and keep our children *tight*. Gay.

8. Hardy; adroit.—9. Not slack or loose, stretched, applied to a rope, wire, or chain, extended or stretched so as to have a considerable degree of tension.

*Note.* This is the *taut* or *taught* of seamen, applied to a rope stretched. The primary sense is strained.

10. Scarce of something; as, the money market is *tight*; that is, money is hard to be had. [*Colloq.*]

**TIGHTEN, v. t.** (ti'tn.) To draw tighter; to straiten; to make more close in any manner.

**TIGHTENED, pp.** Drawn tighter; straitened.

**TIGHTENING, ppr.** Drawing tighter; making more close in any manner.

**TIGHTER, † n.** A ribbon or string used to draw clothes closer.—2. *a.* More tight.

**TIGHTLY, adv.** Closely; compactly. 2. Neatly; adroitly.

**TIGHTNESS, n.** Closeness of joints; compactness; straitness.—2. Neatness, as in dress.—3. Parsimoniousness; closeness in dealing.—4. Scarcity; as, there is a tightness in the money market. [*Colloquial.*]

**TIGHTS, n. pl.** A close garment; close fitting trowsers or pantaloons. [*Familiar.*]

**TY'GRESS, n.** [from *tiger*.] The female of the tiger.

**TY'GRINE, a.** Like a tiger.

**TY'GRISH, a.** Resembling a tiger; fierce.

**TIKE, n.** A tick. [See TICK.]

**TIKE, n.** [Celtic, *tiah, tiac*, a ploughman; Arm. *tiac*, a housekeeper.] 1. A countryman or clown.—2. A dog; a cur. In *Scotch* this word is usually written *tyke*, and is not only applied to a dog, but is used to signify a selfish, snarling, or obstinate person.

**TIL'BURY, n.** A gig or two wheeled carriage, without a top or cover.

**TILE, n.** [Sax. *tigel*; D. *tegel* or *tichgel*; G. *ziegel*; Dan. and Sw. *tegel*; L. *tegula*; It. *tegola*; Sp. *teja*, contracted. This word is undoubtedly from the root of L. *tego*, to cover, Eng. to *deck*.] 1. A kind of thin brick or plate of baked clay, used for covering the roofs of buildings, and occasionally for paving floors, constructing drains, &c. The best qualities of brick-earth are used for making tiles, and the process is similar to that of brick-making. Roofing tiles are chiefly of two sorts, *plain-tiles* and *pan-tiles*. [See these terms.]

Tiles of a semi-cylindrical form, laid in mortar, with their convex or concave sides uppermost, respectively, are used for covering ridges and gutters.—*Paving-tiles* are usually of a square



Ornamental Paving Tiles.

1 and 3. Haecombe, Devonshire; 2. Woodperry, Oxon; 4. Wherewell, Hants.

form, and thicker than those used for roofing. A fine kind was made in former times, and used for paving the floors of churches and other important buildings. They were generally of two colours, and ornamented with a variety of elegant devices. They were highly glazed, and are often called *encaustic tiles*. They are also sometimes, though erroneously, called *Norman tiles*, for they belong to a much later period than the Norman era.—*Drain-tiles* are usually made in the form of an arch, and laid upon flat tiles, called *soles*.—*Dutch tiles*, for chimneys, are made of a whitish earth, glazed, and painted with various figures. They are seldom used.—2. In *metallurgy*, a small flat piece of dried earth, or earthenware, used to cover vessels in which metals are fused.

**TILE, v. t.** To cover with tiles; as, to *tile* a house.—2. To cover, as tiles.

The muscle, sinew, and vein,  
Which *tile* this house, will come again.  
Donne.

In *freemasonry*, to *tile* a *lodge*, is to close or secure its entry against the uninitiated or disorderly.

**TILE-CREASING, n.** In *arch*, two rows of plain tiles placed horizontally under the coping of a wall, and projecting about an inch and a half over each side to throw off the rain-water.

**TILED, pp.** Covered with tiles; closed in.

**TILE-DRAIN, n.** In *agriculture*, a drain constructed with tiles.

**TILE-FIELD, n.** Ground on which tiles are made; as, the palace of the



Tuilleries is thus named, from standing on what was once a *tile-field*.

**TILE-KILN**, *n.* A kiln for baking tiles.

**TILE-ORE**, *n.* A subspecies of octahedral red copper ore.

**TILER**, *n.* A man whose occupation is to cover buildings with tiles.—2. The door-keeper of a mason-lodge; he is usually armed with a sword.

**TIL/GATE-BEDS**, *n.* In *geol.*, the name given by Dr. Mantell to a portion of the great series of strata in the Weald of Kent and Sussex, interposed between the green-sands and the Portland oolite.

**TIL/IA**, *n.* A genus of plants, nat. order Tiliaceæ, the species of which, in this country, are known by the name of *lime-trees*. [See under **LIME**.]

**TILIA/CEÆ**, *n.* A nat. order of poly-petalous dicotyledonous plants, consisting chiefly of trees or shrubs, with simple, toothed, alternate leaves, furnished with stipules. The flowers are axillary, and usually white or pink. It is nearly allied to Sterculiaceæ and Malvaceæ. The species are generally diffused throughout the tropical and temperate parts of the globe. They have all a mucilaginous wholesome juice, and are remarkable for the toughness of the fibres of their inner bark, which are used for various economical purposes under the name of bast. The most important genera are *Tilia*, *Corchorus*, *Luhea*, *Grewia*, and *Berrya*.

**TILING**, *ppr.* Covering with tiles.

**TILING**, *n.* A roof covered with tiles; Luke v.—2. Tiles in general.—3. The operation of covering roofs with tiles.

**TILL**, } *n.* In *bot.*, the *Sesamum orientale*, } *tale*, an East India oil-plant.

**TILL**, *n.* A money box in a shop; a drawer. It is sometimes written *Tiller*.

**TILL**, *n.* A kind of clayey earth; coarse obdurate land. [Provincial.]

**TILL**, *prep. or adv.* [Sax. *til*, *tille*; Sw. and Dan. *til*; Sax. *atillan*, to reach or come to. This word in Sw. and Dan. as in Scottish, signifies to or at, and is the principal word used where we use *to*. The primary sense of the verb is expressed in the Saxon.] 1. To the time or time of. I did not see the man *till* the last time he came; I waited for him *till* four o'clock; I will wait *till* next week.—*Till now*, to the present time. I never heard of the fact *till now*.—*Till then*, to that time. I never heard of the fact *till then*.—2. It is used before verbs and sentences in a like sense, denoting to the time specified in the sentence or clause following. I will wait *till* you arrive.

He said to them, Occupy *till* I come; Luke xix.

Certain Jews bound themselves under a curse, saying that they would neither eat nor drink *till* they had killed Paul; Acts xxiii.

Meditate so long *till* you make some act of prayer to God. Taylor.

**Note**.—In this use, *till* is not a conjunction; it does not connect sentences like *and*, or *like or*. It neither denotes union nor separation, nor an alternative. It has always the same office, except that it precedes a single word or a single sentence; the time to which it refers being in one case expressed by a single word, as *now*, or *then*, or *time*, with *this*, or *that*, &c., and in the other by a verb with its adjuncts; as, occupy *till* I come, that is, to I come. In the latter use, *till* is a preposition

preceding a sentence, like *against*, in the phrase, *against* I come.

**TILL**, *v. t.* [Sax. *tilian*, *tiligian*, to work, to *til*, to cultivate, to prepare; W. *telu*, to strain. In G. *bestellen*, from *stellen*, to set, to put in order, has the sense of *tilling*, cultivating. These words are doubtless of one family.] 1. To labour; to cultivate; to plough and prepare for seed, and to dress crops. This word includes not only ploughing, but harrowing, and whatever is done to prepare ground for a crop, and to keep it free from weeds.

The Lord God sent him forth from the garden of Eden to *till* the ground from whence he was taken; Gen. iii.

2. In the most general sense, to till may include every species of husbandry, and this may be its sense in Scripture.

**TILL/ABLE**, *a.* Capable of being tilled; arable; fit for the plough.

**TILLÆ/A**, *n.* A genus of plants, class and order Tetrandria tetragynia, Linn.; nat. order Crassulaceæ. *T. muscosa*, or mossy tillæa, is a British plant, with branched stems decumbent at the base. It grows on moist, barren, sandy heaths, in various parts of England, and is a very troublesome weed in gravel walks, in some parts of Norfolk and near London.

**TILL/AGE**, *n.* The operation, practice, or art of preparing land for seed, and keeping the ground free from weeds which might impede the growth of crops. Tillage includes manuring, ploughing, harrowing, and rolling land, or whatever is done to bring it to a proper state to receive the seed, and the operations of ploughing, harrowing, and hoeing the ground, to destroy weeds and loosen the soil after it is planted; culture; a principal branch of agriculture. *Tillage* of the earth is the principal as it was the first occupation of man, and no employment is more honourable.

**TILL/AGE LANDS**, *n.* Lands kept under the plough, and regularly cropped.

**TILLAND/SIA**, *n.* A genus of plants, nat. order Bromeliaceæ. The species are most of them parasitical, and are natives of South America. *T. utriculata* is the wild pine of the colonists of Jamaica. The leaves of most of the species serve as reservoirs for water, and the filaments of the stems of *T. usneoides* are used in America for the same purposes as horse hair.

**TILL/ED**, *pp.* Cultivated; prepared for seed and kept clean.

**TILL/ER**, *n.* One who tills; a husbandman; a cultivator; a ploughman.—2. The bar or lever employed to turn the rudder of a ship.—3. A small drawer; a till.—4. Among farmers, the shoot of a plant, springing from the root or bottom of the original stalk; also, the sprout or young tree that springs from the root or stump, but the term is applied chiefly to culmiferous plants.—5. A young timber tree. [Local.]

**TILL/ER**, *v. i.* To put forth new shoots from the root, or round the bottom of the original stalk; as, we say, wheat or rye *tillers*; it spreads by *tillering*. The common orthography is *tiller*. Sir Joseph Banks writes it *tillow*.

**TILL/ERING**, *ppr.* Sending out new shoots round the bottom of the original stem.

**TILL/ERING**, *n.* The act of sending forth young shoots from the root or around the bottom of the original stalk.

**TILL/ER-ROPES**, *n.* [Naut.] Ropes

leading from the tiller-head round the barrel of the wheel, by which the vessel is steered. They are more usually termed *wheel-ropes*.

**TILLING**, *ppr.* Cultivating.

**TILLING**, *n.* The operation of cultivating land; culture.

**TILL/MAN**, } *n.* A man who tills the earth; a husbandman.

**TILL/Y-FALLY**, } *adv. or a.* A word formerly used when any thing said was rejected as trifling or impertinent.

**TIL/MUS**, *n.* [L. from Gr. *τιλλω*, to pluck.] Floccillation, or picking of bed-clothes. [See **FLOCCILLATION**.]

**TILT**, *n.* [Sax. *teld*; Dan. *telt*; Ice. *tiald*; W. *telu*, to stretch over.] 1. A tent; a covering over head.—2. The cloth covering of a cart or wagon.—3. The cover of a boat; a small canopy or awning of canvas or other cloth, extended over the stern sheets of a boat.

**TILT**, *v. t.* To cover with a cloth or awning.

**TILT**, *n.* [See the Verb.] A thrust; as, a *tilt* with a lance.—2. Formerly, a military exercise on horseback, in which the combatants attacked each other with lances; as, *tilts* and tournaments.—3. A large hammer; a tilt-hammer; used in iron manufactures.—4. Inclination forward; as, the *tilt* of a cask; or a cask is *a-tilt*.

**TILT**, *v. t.* [Sax. *tealtian*, to lean, to incline, to nod; Dan. *tylder*, to pour out, to decant. In D. *tillen* signifies to lift, L. *tollo*. This is probably a derivative verb.] 1. To incline; to raise one end, as of a cask, for discharging liquor; as, to *tilt* a barrel.—2. To point or thrust, as a lance.

Sons against fathers *tilt* the fatal lance. Philip.

3. To hammer or forge with a tilt-hammer or tilt; as, to *tilt* steel to render it more ductile.—4. To cover with a tilt.

**TILT**, *v. i.* To run or ride and thrust with a lance; to practise the military game or exercise of thrusting at each other on horseback.—2. To fight with rapiers.

Swords out and *tilling* one at other's breast. Shak.

3. To rush as in combat.—4. To play unsteadily; to ride, float, and toss. The fleet swift *tilting* o'er the surges flew. Pope.

5. To lean; to fall as on one side.

The trunk of the body is kept from *tilting* forward by the muscles of the back. Grew.

**TILT-BOAT**, *n.* A boat covered with canvas or other cloth.

**TILT/ED**, *pp.* Inclined off the level; as, *tilted* strata; made to stoop.—2. Covered with cloth or awning.—3. Hammered; prepared by beating; as steel.

**TILT/ER**, *n.* One who tilts; one who uses the exercise of pushing a lance on horseback; one who fights.

Let me alone to match your *tiller*. Granville.

2. One who hammers with a tilt.

**TILTH**, *n.* [Sax. *tith*; from *till*.] 1.† That which is tilled; tillage ground.—2. In agriculture, the degree or depth of soil turned by the plough or spade; that available soil on the earth's surface into which the roots of crops strike.—3. The state of being tilled or prepared for a crop. We say, land is in good *tith*, when it is manured, ploughed, broken, and mellowed for receiving the seed. We say also, ground

is in bad *tilth*. When we say, land is in *tilth*, we mean in good condition for the seed; *not in tilth*, in a bad condition.

**TILT-HAMMER**, *n.* [*tilt* and *hammer*.] A heavy hammer used in iron works, which is worked by machinery, impelled either by a water-wheel or a steam-engine. Such hammers are extensively used in the manufacture of iron and steel. The hammer used for hammering the *blooms* of iron, is usually called a *lift* or *helve* hammer, and is sometimes of the enormous weight of six tons. The tilt-hammer, properly so called, is of lighter dimensions, and is worked with greater rapidity; a specimen of the kind usually employed in the manufacture of steel, and in the forging of anchors, axles, &c., is represented in the accompanying engraving.

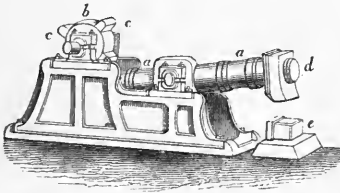

Tilt-hammer.

*a* is the shank or helve, usually formed of timber, and sometimes of wrought iron; it is hung upon an axis at about one-third of its length, and is worked by a series of revolving cams or tappets, *c, c*, fixed into the circumference of the *cam-ring, b*, mounted upon the shaft of a steam-engine or water-wheel. These cams act successively by depressing the shorter limb of the shank, *a*, until, by the continued revolution, it is disengaged, and the opposite extremity, armed with a heavy cast-iron hammer, *d*, descends with considerable force upon the anvil, *e*. Thus a repetition of blows is kept up as long as may be required.

**TILTING**, *ppr.* Inclining; causing to stoop or lean; using the game of thrusting with the lance on horseback; also, hammering with a tilt-hammer.

**TILTING**, *n.* The process of hammering or forging by means of tilt-hammers. The *tilting of steel* is the process by which blistered steel is rendered ductile. This is done by beating with the tilt-hammer.

**TILTING-FILLET**, *n.* A chamfered fillet of wood laid under slating where it joins to a wall, to raise it slightly and prevent the water from entering the joint.

**TILTING-SPEAR**, *n.* A spear or lance used in tilts and tournaments. [See TOURNAMENT.]

**TILT-MILL**, *n.* A name sometimes given to the machinery by which tilt-hammers are worked.

**TILT-YARD**, *n.* A place for tilting; lists for combats.—2. A hippodrome.

**TIMALIA**, *n.* A genus of birds, family Turdidae, or thrushes. *T. pileata* is found in Java.

**TIMBAL**, *n.* A kettle drum.

**TIMBER**, *n.* [Sax. *timber*, wood, a tree, structure; *timbrían*, to build, to edify, in a moral sense; Goth. *timbrýan*, to construct; Sw. *timmer*, wood fit for building; *timra*, to build, to frame; Dan. *tømmer*, timber; *tømrer*, to build; D. *timmer*, an apartment; *timber*, a

crest; *timmeren*, to build; *timmerhout*, timber; G. *zimmer*, an apartment; *zimmer*, to square, fit, fabricate; *zimmerholz*, timber. If *m* is radical, which is probable, this word coincides with Gr. *δῆμα*, L. *domus*, a house, and Gr. *δῆμας*, the body. The primary sense is probably to set, lay, or found.] 1. That sort of wood which is squared, or capable of being squared, and fit for being employed in house or ship-building, or in carpentry, joinery, &c. We apply the word to standing trees which are suitable for the uses above mentioned, as a forest contains excellent *timber*; or to the beams, rafters, boards, planks, &c., hewed or sawed from such trees. But in the language of the customs, when a tree is sawn into thin pieces, not above 7 inches broad, it is called *batten*; when of greater breadth, such thin pieces are called *deal*. Timber is generally sold by the load. A load of rough or unhewn timber is 40 cubic feet, and a load of squared timber 50 cubic feet. In regard to planks, deals, &c., the load consists of so many square feet: thus, a load of 1 inch plank is 600 square feet. The most useful timbers of Europe are the oak, the ash, the Scotch pine, the larch, and the spruce fir; those of North America, are the hickory, the different species of pine, and some species of oak; those of tropical countries, are the teak tree, the different species of bamboo, and the palm. Wood is a general term, comprehending under it timber, dye woods, fancy woods, firewood, &c., but the word timber is often used in a loose sense for all kinds of felled and seasoned wood.—2. The body or stem of a tree.—3. The materials; *in irony*.

Such dispositions are the fittest *timber* to make politics of. Bacon.

4. A single piece or squared stick of wood for building, or already framed; one of the main beams of a fabric.

Many of the *timbers* were decayed.

*Coze's Switzerland.*  
5. In *ships*, a timber is a rib or curving piece of wood, branching outward from the keel in a vertical direction. One *timber* is composed of several pieces united in one frame.—*Timber*, or *timmer of furs*, as of martens, ermines, sables, and the like, denotes forty skins; of other skins, one hundred and twenty; an old mercantile term, used both in England and Scotland.—*Timbers of ermine*, *in her.*, denote the ranks or rows of ermine in noblemen's coats.

**TIMBER**, *v. t.* To furnish with timber. [See TIMBERED.]

**TIMBER**, *† v. i.* To light on a tree.—2. In *falconry*, to make a nest.

**TIMBER-BRICK**, *n.* A piece of timber of the size and shape of a brick, inserted in brickwork to attach the finishings to.

**TIMBERED**, *pp. or a.* Furnished with timber; as, a well *timbered* house.—2. Built; formed; contrived. [Little used.]

**TIMBER-HEAD**, *n.* [*timber* and *head*.] In *ships*, the top end of a timber, rising above the gunwale, and serving for belaying ropes, &c.; otherwise called *hevel-head*.

**TIMBERING**, *ppr.* Furnishing with timber.

**TIMBERLING**, *n.* A small timber tree. [Local.]

**TIMBER-MEASURE**, *n.* The method

employed by artificers in measuring trees, joists, beams, or in ascertaining their solid contents. This is treated of under *Mensuration of solids*.

**TIMBER-MERCHANT**, *n.* A dealer in timber.

**TIMBERS**, *n.* The *timbers* of a ship are the ribs, or curved pieces of wood, branching outward from the keel in a vertical direction. Their use is to give strength, figure, and solidity to the whole fabric.

**TIMBER-SOW**, *† n.* A worm in wood.

**TIMBER-TRADE**, *n.* Commerce in timber; as, the *timber-trade* of Canada.

**TIMBER-TREE**, *n.* [*timber* and *tree*.] A tree suitable for timber. [See **TIMBER**.]

**TIMBER-WÖRK**, *n.* [*timber* and *work*.] Work formed of wood.

**TIMBER-YARD**, *n.* [*timber* and *yard*.] A yard or place where timber is deposited.

**TIMBRE**, *n.* [D. *timber*.] In *her.*, the helmet, mitre, coronet, &c., when placed over the arms in a complete achievement.

**TIMBREL**, *n.* [Sp. *tamboril*, a tabor or drum; It. *tamburo*; Fr. *tambourin*, *tambour*; Ir. *tiompan*; L. *tympānum*; Gr. *τύμβα*.] This is probably the same as *tabor*, or from the same root; *m* being casual. It is from beating; Gr. *τύττω*.] An instrument of music; a kind of drum, tabor, or tabret, which has been in use from the highest antiquity. It is now known under the name of tambourine, or *tambour de basque*. [See **TAMBOURINE**.]

And Miriam took a *timbrel* in her hand... and all the women went out after her with *timbrels* and with dances; Exod. xv.

**TIMBRELLED**, *a.* Sung to the sound of the timbrel.

**TIME**, *n.* [Sax. *tim*, *time*, in general; Dan. *time*, Sw. *timme*, an hour; L. *tempus*; It. and Port. *tempo*; Sp. *tiempo*; Fr. *temps*, time in general; all from the root of the Sw. *tima*, to happen, to come, to befall; but the root, in some of its applications, must have signified to rush with violence. Hence the sense of *temples*, L. *tempora*, the falls of the head, also *tempest*, &c. See **TEMPEST**. *Time* is primarily equivalent to *season*; to the Gr. *ᾠρα* in its original sense, *opportunity*, *occasion*, a fall, an event, that which comes.] 1. A particular portion or part of duration, whether past, present, or future. The *time* was; the *time* has been; the *time* is; the *time* will be.

Lost *time* is never found again.

Franklin.

God, who at sundry times, and in divers manners, spoke in *time* past to the fathers by the prophets; Heb. i.

2. A proper time; a season. There is a *time* to every purpose; Eccles. iii. The *time* of figs was not yet; Mark xi. 3. Duration. The equal and uniform flux of *time* does not affect our senses. Cyc. *Time* is *absolute* or *relative*; *absolute* time is considered without any relation to bodies or their motions. It is conceived by us as unbounded, continuous, homogeneous, unchangeable in the order of its parts, and divisible without end. *Relative* time is the sensible measure of any portion of duration, by means of motion. Thus the diurnal revolution of the sun measures a space of time or duration. Hence,—4. A

space or measured portion of duration. In this sense, time is measured by certain conventional or natural periods, and often marked by particular phenomena; as the revolution of the heavenly bodies, more especially the revolution of the sun, or the rotation of the earth on its axis. Time is divided into years, months, weeks, days, hours, minutes, and seconds, but of these portions the years and days only are marked by celestial phenomena. In order to measure time we employ some equable motion, and we judge those times to be equal, which pass while a moving body proceeding with a uniform motion passes over equal spaces. The machines employed for measuring time are clocks, watches, chronometers, clepsydres, hour-glasses, and dials, but the three former are those chiefly used.—5. Life or duration in reference to occupation. One man spends his *time* in idleness; another devotes all his *time* to useful purposes.

Believe me, your *time* is not your own; it belongs to God, to religion, to mankind.

*Buckminster.*

6. Age; a part of duration distinct from other parts; as, ancient *times*; modern *times*. The Spanish armada was defeated in the *time* of Queen Elizabeth.—7. Hour of travail.

She was within one month of her *time*.

*Clarendon.*

8. Repetition; repeated performance, or mention with reference to repetition. The physician visits his patient three *times* in a day.—9. Repetition; doubling; addition of a number to itself; as, to double cloth four *times*; four *times* four amount to sixteen.—10. In *music*, the relative duration of sounds or the measurement of that duration. The term is also used to signify that which divides a bar into two or three equal parts, and subdivides these; and likewise the movement, that is, the quickness or slowness of a composition. The duration of a single sound is known by the particular note, that is, as minim or crotchet, &c. The semibreve is considered as the measure note, it being the longest. Its average length is about four beats of a healthy man's pulse. In regard to the division of bars, the time is either duple or triple, of which there are several varieties. A variety of terms are employed to indicate the movement, as *andante*, *adagio*, *allegro*, &c. In concerts, it is all important that the performers keep *time*, or exact *time*.—11. The state of things at a particular period; as when we say, good *times*, or bad *times*, hard *times*, dull *times* for trade, &c. In this sense, the plural is generally used.—12. The present life; as, in *time* or eternity.—13. In *gram.*, tense.—14. Among *phrenologists*, one of the perceptive faculties. Its organ is situated on each side of eventuality. This faculty gives the power of judging of time, and of intervals in general. It is essential to music and versification.—In *time*, in good season; sufficiently early. He arrived in *time* to see the exhibition.—2. A considerable space of duration; process or continuation of duration. You must wait patiently; you will in *time* recover your health and strength.—At *times*, at distinct intervals of duration. At *times* he reads; at other *times* he rides.

The Spirit began to move him at *times*; Judges xiii.

11.

*Time enough*, in season; early enough.

Stanley at Bosworth-field, came *time enough* to save his life. *Bacon.*

To *lose time*, to delay.—2. To go too slow; as, a watch or clock *loses time*.—*Apparent time*, in *astron.*, true solar time, regulated by the apparent motions of the sun. It is the same as that shown by a properly adjusted sun-dial.—*Mean time*, equated time, a mean or average of apparent time. It is the same as that shown by a well regulated clock.—*Sidereal time*, is that which is shown by the apparent diurnal revolutions of the stars.—*Astronomical time*, that measured by the motions of the heavenly bodies only.—*Astronomical time of day*, the time past mean noon of that day, and is reckoned into 24 hours in mean time.—*Civil time*, mean time adapted to civil uses, and distinguished into years, months, days, &c.—*Equinoctial time*, a system of reckoning time by mean solar days, and parts of a day, counted from a fixed instant, common to all the world, and determined by no local circumstance such as noon or midnight, but is numerically the same, at the same instant, in every part of the globe.—*Equation of time*. [See under EQUATION.]—*Time of descent*, in *physics*, is the time employed by a material particle in falling down an arc of a curve by the action of gravity. [See DAY, SOLAR, SIDEREAL, YEAR.]

*TIME*, *v. l.* To adapt to the time or occasion; to bring, begin, or perform at the proper season or time; as, the measure is well *timed*, or ill *timed*. No small part of political wisdom consists in knowing how to *time* propositions and measures.

Mercy is good, but kings mistake its *timing*. *Dryden.*

2. To regulate as to time; as, he *timed* the stroke.—3. To measure; as in music or harmony.

*TIME-BARGAIN*, *n.* An illegal bargain between two stockholders, who agree that on a specified future day, the difference in value of a nominal sum in some particular stock, as may be agreed upon, shall be paid over to the individual in whose favour the rise may be determined. Accordingly, when what is termed the *settling day* arrives, the amount of the wager is paid to the winner.

*TIME-BEWASTED*, *† a.* Wasted by time.

*TIME-BOOK*, *n.* A book kept by farmers and others who employ labourers or workmen, for registering the days and parts of days each person has been at his work, and the particular description of work in which he has been employed. Its chief use is to regulate the payment of wages.

*TIMED*, *pp.* Adapted to the season or occasion.

*TIME-ENDURING*, *a.* Lasting as time itself.

*TIMEFUL*, *a.* Seasonable; timely; sufficiently early. [Not much used.]

*TIME-HONOURED*, *a.* Honoured for a long time.

*TIMEIST*, *n.* In *music*, a performer who keeps good time.—2. *†* One who conforms with the times; a time-server.

*TIME-KEEPER*, *n.* [*time* and *keeper*.] A clock, watch, or chronometer.

*TIME-KILLING*, *a.* Adapted to kill time.

*TIMELESS*, *a.* Unseasonable; done at an improper time.

Not fits it to prolong the heav'nly feast *Timeless*. *†* *Pope.*

2. *†* Untimely; immature; done or suffered before the proper time; as, a *timeless* grave.

*TIMELESSLY*, *adv.* Unseasonably.

*TIMELINESS*, *n.* [from *timely*.] Seasonableness; being in good time.

*TIMELY*, *a.* Seasonable; being in good time; sufficiently early. The defendant had *timely* notice of this motion. *Timely* care will often prevent great evils.—2. *†* Keeping time or measure.

*TIMELY*, *adv.* Early; soon; in good season.

*Timely* advised, the coming evil shun.

*Prior.*

*TIMEOUSLY*, *a.* Seasonably; in good time.

*TIME-PIECE*, *n.* [*time* and *piece*.] A clock, watch, or other instrument, to measure or show the progress of time; a chronometer.

*TIME-PLEASER*, *n.* (*s* as *z*.) [*time* and *please*.] One who complies with the prevailing opinions, whatever they may be.

*TIME-SANCTIONED*, *a.* Sanctioned by long use.

*TIME-SCORNER*, *n.* One who scorns time.

*TIME-SERVER*, *n.* [*time* and *serve*.] One who adapts his opinions and manners to the times; one who obsequiously complies with the ruling power.

*TIME-SERVING*, *a.* Obsequiously complying with the humours of men in power.

*TIME-SERVING*, *n.* An obsequious compliance with the humours of men in power, which implies a surrender of one's independence, and sometimes of one's integrity.

*TIME-WASTING*, *a.* Wasting time.

*TIME-WORN*, *a.* Impaired by time.

*TIMEID*, *a.* [Fr. *timide*; L. *timidus*, from *timeo*, to fear; Gaelic, *tim*, *time*, fear; Sp. *temblar*, to shake with fear; *temer*, to fear. The sense is probably to shake, or to fail, fall, recede, or shrink.] Fearful; wanting courage to meet danger; timorous; not bold.

Poor is the triumph o'er the *timid* hare. *Thomson.*

*TIMIDITY*, *n.* [Fr. *timidité*; L. *timiditas*.] Fearfulness; want of courage or boldness to face danger; timorousness; habitual cowardice. *Timidity* in one person may be a good trait of character, while in another it is a deep reproach.

*TIMIDLY*, *adv.* In a timid manner; weakly; without courage.

*TIMIDNESS*, *n.* Timidity.

*TIMING*, *ppr.* Adapting to the season or occasion.

*TIMEIST*. See *TIMEIST*.

*TIMOCRACY*, *n.* [Gr. *τιμος*, honour, worth, and *κρατος*, to hold.] In *Grecian hist.*, government by men of property, who were possessed of a certain income. It also signified a government which formed a sort of mean between aristocracy and oligarchy, when the ruling class, composed of the best and noblest citizens, struggled for pre-eminence among themselves.

*TIMONEER*, *n.* [Fr. *timon*; L. *temo*.] A helmsman.

*TIMOROSO*, *adv.* [It. with dread or fearfulness.] In *music*, a term applied when the style of performance expresses awe and dread.

*TIMOROUS*, *a.* [It. *timoroso*; from

G N

*L. timor.* See TIMID.] 1. Fearful of danger; timid; destitute of courage; as, a *timorous* female.—2. Indicating fear; full of scruples; as, *timorous* doubts; *timorous* beliefs. TIMOROUSLY, *adv.* Fearfully; timidly; without boldness; with much fear.

Let dastard souls be *timorously* wise.

*Philips.*

TIMOROUSNESS, *n.* Fearfulness; timidity; want of courage.

TIMOTHY GRASS, *n.* A valuable fodder-plant, the *Phleum pratense*, or common cat's tail grass. It is extensively cultivated in North America. [See PHLEUM.]

TIMOUS, † *a.* [from *time*.] Early; timely.

TIMOUSLY, † *adv.* In good season.

TIN, *n.* [Sax. *tin*; D. *tin*; G. *zinn*; Dan. *tin*, pewter, and *tinblik*, tin, that is, tin-plate; Ir. *stan*; W. *ystaen*, that is, spread or is sprinkled over, a stain, and tin; Corn. *staen*; Arm. *stean*; Fr. *etain*; L. *stannum*; Sp. *estaño*; Port. *estanho*; It. *stagno*. The latter signifies tin, pewter, and a pond, L. *stagnum*.] 1. A metal of a white brilliant colour, slightly tinged with grey, being one of the simple or elementary bodies. In hardness it is intermediate between gold and lead; it is very malleable, and may be beaten out into leaves less than the thousandth of an inch in thickness. It is more tenacious than lead, and very flexible, and when bent in the fingers it emits a peculiar crackling sound. Its specific gravity is 7.2. It melts at 442°, and if heated to whiteness in air, it takes fire and burns with a white flame, forming peroxide of tin. Tin is rather a scarce metal, being found in few places of the world in any quantity. The mines in Cornwall are its most productive source; it also occurs in Bohemia, Saxony, and Spain; in Malacca and Banca, in Asia; in Mexico and Chili; and in Massachusetts, in North America. There are only two ores of tin: the native peroxide, called *tin-stone*, and the double sulphuret of tin and copper, called *tin pyrites*,—which see. The peroxide of tin is found in Cornwall in two forms: 1. In veins where it is blended with several other metals; as arsenic, copper, zinc, and tungsten; 2. In loose rounded masses, grains, or sand in alluvial soil, in which state it is called *stream tin*. The former, when reduced to the metallic state, yields *block tin*, while the latter yields *grain tin*, which is the purer of the two. What is termed *wood tin* is found in reniform and botryoidal masses, or in wedge-shaped pieces. Oxygen combines with tin, forming the *protoxide*, *sesquioxide*, and *peroxide* of tin. Chlorine unites with tin, forming the *protochloride* and *perchloride* of tin. The compounds of sulphur and tin are the *protosulphuret*, *sesquisulphuret*, and *persulphuret*. The uses of tin are numerous. It is much used as a covering to several other metals, as in tin-plate, and cooking vessels of copper. Combined with copper it forms *bronze*, *bell-metal*, and several other useful alloys. With lead it forms *pewter*, and solder of various kinds. Tin-foil coated with mercury forms the reflecting surface of glass-mirrors. The solutions of tin in the nitric, muriatic, nitro-sulphuric, and tartaric acids, are much used in dyeing. Tin is much

used in the state of very thin leaves or *tin-foil*.—2. Thin plates of iron covered with tin. [See TIN-PLATE].—3. A cant name for money. [Low.]

TIN, *v. t.* To cover with tin, or overlay with tin-foil.

TINAMON, } *n.* A genus of South  
TINAMUS, } American birds, fam-  
ily Tetraonidae. They are remark-  
able for a long slender neck, covered  
with feathers, the tips of the barbs  
being slender and slightly curled.



Great Tinamon (*T. Brazilianis*).

They vary in size from that of a pheasant down to that of a quail, and even smaller. They either perch on low trees or hide among long grass; are easily caught with a running noose, and when cooked the flesh is delicately white.

TINCA, *n.* A genus of fishes founded by Cuvier, and comprising the tenches. [See TENCH.]

TINCAL, *n.* The commercial name of borax in its crude or unrefined state. It is an impure bichlorate of soda, consisting of small crystals of a yellowish colour, and is unctuous to the feel.

TINCHILL, } *n.* [Gael. *tinchioll*, cir-  
TINCH'EL, } cuit, compass.] A circle  
of sportsmen, who, by surrounding a  
great space, and gradually closing in,  
bring immense quantities of deer  
together, by which means they are cap-  
tured or killed.—2. A snare or gin.  
[Scotch.]

TINCT, † *v. t.* [L. *tingo*, *tinctus*.] To stain or colour; to imbue.

TINCT, † *n.* Stain; colour. [We now use *tinge* and *tincture*.]

TINCTORIAL, *a.* Pertaining to colours or dyes; imparting colour. *Tinctorial* matter is colouring matter.

TINCTURE, *n.* [L. *tinctura*; Fr. *teinture*. See TINGE.] 1. † The finer and more volatile parts of a substance, separated by a menstruum; or an extract of a part of the substance of a body, communicated to the menstruum.—2. In *med.*, tinctures are solutions of the active principles, chiefly of vegetables, sometimes of saline medicines, more rarely of animal matters, in certain solvents. They are called tinctures from possessing more or less of colour.

*Alcoholic tinctures* are such as are prepared with alcohol. When sulphuric ether is used as the solvent, they are termed *etherial tinctures*; when ammonia is used, they are termed *ammoniated tinctures*; and when wine is used, they are called *medicated wines*. *Simple tinctures* are such as hold only one substance in solution; and *compound tinctures* are those in which two or more ingredients are submitted to the solvent. The greater number of tinctures are prepared with

proof spirit, and the most important are those which contain highly active ingredients, as the tincture of opium, &c.—3. A tinge or shade of colour; as, a *tincture* of red.—4. Slight taste superadded to any substance; as, a *tincture* of orange peel.—5. Slight quality added to any thing; as, a *tincture* of French manners.

All manners take a *tincture* from our own.

*Pope.*

6. In *her.*, the colour of any thing in coat-armour, including the two metals or and argent, or gold and silver, and furs.

TINCTURE, *v. t.* To tinge; to communicate a slight foreign colour to; to impregnate with some extraneous matter.

A little black paint will *tincture* and spoil twenty gay colours. *Watts.*

2. To imbue the mind; to communicate a portion of any thing foreign; as, a mind *tinctured* with scepticism.

TINCTURED, *pp.* Tinged; slightly impregnated with something foreign.

TINCTURING, *ppr.* Tinging; imbuing; impregnating with a foreign substance.

TIND, *v. t.* [Sax. *tendan*, *tynan*, to kindle; Goth. *tandyan*; Sw. *tända*; Dan. *tænder*; Eng. *tine*; *tinder*, G. *zunder*; probably allied to Ir. and Gael. *teine*, fire, W. Corn. and Arm. *tan*; and perhaps our word *sun* is of the same family.] To kindle; † hence, TINDER, *n.* [Sax. *tyndre*.] Something very inflammable, used for kindling fire from a spark; as scorched linen.

TINDER-BOX, *n.* [*tinder* and *box*.] A box in which tinder is kept.

TINDER-LIKE, *a.* [*tinder* and *like*.] Like tinder; very inflammable.

TINE, † *v. t.* [Sax. *tynan*.] To kindle; to set on fire. [See TIND.]

TINE, *v. t.* [Sax. *tynan*; L. *teneo*.] To shut or inclose; to fill. [Not in use or local.]

TINE, *n.* [Sax. *tinder*; Ice. *tindr*; probably the L. *dens*, G. *zahn*, W. *dant*, a tooth; at any rate, it is a shoot.] 1. The tooth or spike of a fork; a prong; also, the tooth of a harrow or drag.—2. † Trouble; distress.

TINE, † *v. t.* [Sax. *tynan*, from *teine*, *tan*, fire, supra.] To rage; to smart; to fight.

TINE, } *v. t.* To lose; as, to *tyne*  
TYNE, } money. [Scotch.]

TINE, } *v. i.* To be lost; to perish in  
TYNE, } whatever way. [Scotch.]

TIN'EA, *n.* [L. from *teneo*, to hold.] The scald-head; porrigo. In this disease certain cellular plants are met with which have all the appearance of fungi, and are called *porrigiferous*.—2. A genus of nocturnal lepidopterous insects. It comprises the species generally known under the name of *clothes-moths*. In the accompanying figure, *a* is the *Tinea tapetzella*, or



woollen clothes moth; *b*, the case or cloak of the caterpillar of *Tinea pellionella*, which infests furs.

TINED, *a.* Furnished with tines.

TINEMAN, *n.* Anciently an officer of the forest in England, who had the nocturnal care of vert and venison.

**TINNET**, *n.* [*tine*, to shut, *supra.*] In *old writers*, brushwood and thorns for making and repairing hedges.

**TINFLOORS**, *n.* In *tin mines*, the name usually given to small veins, or thin flat masses of tinstone, interposed between certain rocks, and parallel to their beds. The same name is occasionally given to *stock-works*, or the large irregular masses of tin ore.

**TINFOIL**, *n.* [*tin* and *L. folium*, a leaf.] Tin reduced to a thin leaf.

**TING**, *v. n.* A sharp sound. [Children use *ding, dong.* See **TINGLE**.]—2. The room in a Chinese temple containing the idol.

**TING**, *v. i.* To sound or ring.

**TINGE**, *v. t.* [*L. tingo*; Gr. *τιννω*, Sax. *deagan*; Eng. to *dye*; G. *tunken*, to dip; Fr. *teindre*, to stain. See **DYE**. Ar. *taicha*, to perish, to die, to tinge. Tinging is from dipping. The primary sense of the verb is to plunge, or to throw down, to thrust, and intransitively to fall; hence we see the words to die, that is, to fall or perish, and to dye, or colour may be from one root.] To imbue or impregnate with something foreign; to communicate the qualities of one substance, in some degree, to another, either by mixture, or by adding them to the surface; as, to tinge a blue colour with red; an infusion tinged with a yellow colour by saffron; to tinge a decoction with a bitter taste. The jaundice tinges the eyes with yellow.

The virtues of Sir Roger, as well as his imperfections, are tinged with extravagance. *Addison.*

**TINGE**, *n.* Colour; dye; taste; or rather a slight degree of some colour, taste, or something foreign, infused into another substance or mixture, or added to it; tincture; as, a red colour that has a tinge of blue; a dish of food that has a tinge of orange peel in its taste.

**TING'ED**, *pp.* Imbued or impregnated with a small portion of something foreign.

**TING'ENT**, *a.* Having the power to tinge.

As for the white part it appeared much less enriched with the tinging property. [*Little used.*] *Boyle.*

**TING'ING**, *ppr.* Imbuing or impregnating with something foreign.

**TIN'-GLASS**, *n.* Bismuth,—which see.

**TIN''GLE**, *v. i.* [*W. tincial*, *tincian*, or *tinciau*, to tink, to tinkle, or tingle, to ring, to draw, or drain the last drop. Qu. *D. tintelen*, Fr. *tinter*, *L. tinnio*.] 1. To feel a kind of thrilling sound; as in the ears.

At which both the ears of every one that heareth it shall tingle; 1 Sam. iii.

2. To feel a sharp, thrilling pain. The pale boy senator yet tinging stands.

*Pope.*  
3. To have a thrilling sensation, or a sharp, slight penetrating sensation. They suck pollution through their tinging veins. *Tickel.*

**TING''LING**, *ppr.* Having a thrilling sensation.

**TING'LING**, *n.* A thrilling, jarring, tremulous sensation.

**TINK**, *v. i.* [*W. tinciau*, *supra.*] To make a sharp, shrill noise; to tinkle. [*The latter is generally used.*]

**TINK'AL**, *n.* Tincal,—which see.

**TINK'ER**, *n.* [*W. tincerz*, the ringer, from *tinciau*, to ring.] A mender of brass kettles, pans, and the like.

**TINK'ER**, *v. t.* To work as a tinker; to mend; to repair; to cobble.

**TINK'ERING**, *n.* The act or employment of a tinker.

**TINK'ERLY**, *adv.* In the manner of a tinker.

**TINK'LE**, *v. i.* [*W. tincial*, *supra*, under *tingle*.] 1. To make small, quick, sharp sounds, as by striking on metal; to clink; to tingle.

...And have not charity, I am become as sounding brass, or a tinkling cymbal; 1 Cor. xliii.; Is. iii.

The sprightly horse Moves to the music of his tinkling bells. *Doddley.*

The moment the money tinkles in the chest, the soul mounts out of purgatory. *Tetzels in Milner.*

2. To hear a small, sharp sound. And his ears tinkled, and his colour fled. *Dryden.*

**TINK'LE**, *v. t.* To cause to clink or make sharp, quick sounds.

**TINK'LER**, *n.* A tinker. [*Scotland and North of England.*]

**TINK'LING**, *ppr.* Making a small, quick, sharp noise.

The grots that echo to the tinkling rills. *Pope.*

**TINK'LING**, *n.* A small, quick, sharp sound.

Making a tinkling with their feet; Is. iii.

**TIN'MAN**, *n.* [*tin* and *man*.] A manufacturer of tin vessels; a dealer in tin ware.

**TIN'-MINE**, *n.* [*tin* and *mine*.] A mine where tin is obtained.

**TIN'NED**, *pp.* Covered with tin.

**TIN'NER**, *n.* [*from tin*.] One who works in the tin mines.—2. A tinman.

**TIN'NIANT**, *† a.* [*L. tinnio*, to ring; *ppr. Tinniens*.] Emitting a clear sound or tingling noise.

**TIN'NING**, *ppr.* [*from tin*.] Covering with tin or tinfoil.

**TIN'NING**, *n.* The act, art, or process of covering plates of iron, the inner surfaces of iron or copper vessels, &c., with a thin coat or layer of tin, to protect them from oxidation, or from being corroded by rust.—2. The covering or layer thus put on.

**TIN'NITUS AURIUM**, *n.* [*L.*] In *medical pathol.*, a ringing in the ears; a common symptom in many diseases, and especially of organic disease of the auditory nerve.

**TINNUN'EULUS**, *n.* In *ornith.*, a genus of Falconidae, comprising the kestrels, or stonegalls.

**TIN'NY**, *a.* Abounding with tin.

**TIN'PENNY**, *n.* [*tin* and *penny*.] A customary duty in England, formerly paid to tithingmen, for liberty to dig in the tin mines.

**TIN'PLATE**, *n.* Thin sheet iron coated with tin, in order to protect it from oxidation or rust. It is also known by the name of *white-iron*. The uses of tin-plate are well known. It is formed into vessels of all sorts, boxes, trinkets, and a variety of other articles.—*Crystallized tin-plate*, tin-plate having its surface of a crystalline texture. This is effected by washing over the surface of common tin-plate with a weak acid, and then cleaning it with an alkaline ley; after which the surface is covered over with a transparent varnish. It forms an ornamental article, known by the name of *moirée metallique*.

**TIN PYRITES**, *n.* Native sulphuret of tin; a double sulphuret of tin and

copper. It occurs crystallized and massive. The crystallized variety has an uneven fracture with a metallic lustre; is readily scratched and reduced to powder. Its colour is steel-gray mixed with yellow, and its specific gravity is 4.35. Tin pyrites is a rare substance, having been found only in Cornwall.

**TIN'SAW**, *n.* A kind of saw used by bricklayers for sawing bricks.

**TIN'SEL**, *n.* [*Fr. etincelle*, a spark.] 1. Something very shining and gaudy; something superficially shining and showy, or having a false lustre, and more gay than valuable.

Who can discern the tinsel from the gold? *Dryden.*

If the man will too curiously examine the superficial tinsel good, he undecelves himself to his cost. *Norris.*

2. A kind of shining cloth.—3. A kind of lace.

**TIN'SEL**, *n.* In *Scots law*, a term used to signify loss; forfeiture from the Scottish *tine* or *tyne*, to lose.—*Tinsel of the feu*, the loss or forfeiture of a feu-right by failure to pay the feu-duty for two years whole and together.

This is an irritancy incident to every feu-right.—*Tinsel of superiority*, a remedy introduced by statute for unentered vassals whose superiors are themselves uninfert, and therefore cannot effectually enter them. In this case the vassal must charge the superior to obtain himself infert in the superiority within forty days, under certification that, if he fail, he shall lose the tenant for his life time; that is, he shall lose the casualties that may fall to him, through the act or delinquency of the vassal, besides making up the damage sustained by his failure.

**TIN'SEL**, *a.* Gaudy; showy to excess; specious; superficial.

**TIN'SEL**, *v. t.* To adorn with something glittering and showy, without much value; to make gaudy.

She, tinsel'd o'er in robes of varying hues. *Pope.*

**TIN'SELED**, *pp.* Decorated with gaudy ornaments.

**TIN'SELING**, *ppr.* Adorning with tinsel or superficial lustre.

**TIN' STONE**, *n.* A native peroxide of tin; the principal ore of tin found in the mines of Cornwall. It occurs in attached and imbedded crystals, and massive. [*See TIN.*] Tin stone sometimes yields nearly 80 per cent. of its weight in tin.

**TINT**, *n.* [*It. tinta*; Fr. *teint*; from *L. tinctus*, *tingo*. See **TINGE**.] A dye; a colour, or rather a slight colouring or tincture distinct from the ground or principal colour; as, red with a blue tint, or tint of blue. In painting, tints are the colours considered as more or less bright, deep, or thin, by the due use and intermixture of which a picture receives its shades, softness, and variety.

Or blend in beauteous tint the colour'd mass. *Pope.*

Their vigour sickens, and their tints decline. *Harte.*

**TINT**, *v. t.* To tinge; to give a slight colouring to.

**TINT**, *pp.* of the verb to *tine*. Lost. [*Scotch.*]

**TINTAMAR**, *† n.* [*Fr. tintamarre*; *L. tinnitus* and *Mars. Ash*.] A hideous or confused noise.

**TINT'ED**, *pp.* Tinged.

TINT'ING, *ppr.* Giving a slight colouring to.

TINTING, *n.* A forming of tints.

TINTINNAB'ULARY, *a.* [L. *tintinnabulum*, a little bell.] Having or making the sound of a bell.

TIN'-WORM, *n.* [*tin* and *worm*.] An insect; a species of millepede.

TIN'Y, *a.* [from the root of *thin*,—*which see*.] Very small; little; puny. It is often joined with *little*, as an augmentation; as, a little *tiny* thing. [A word used in burlesque.]

When that I was a little *tiny* boy. *Shak.*

TIP, *n.* [D. *tip*, a different orthography of *top*; G. *zipfel*; that is, a shoot or extension to a point. Qu. Eth. *thybe*, the nipple.] 1. The end; the point or extremity of any thing small; as, the *tip* of the finger; the *tip* of a spear; the *tip* of the tongue; the *tip* of the ear.—2. One part of the play at ninepins.—3. In *bot.*, an anther.—4. A gentle stroke; a tap.

TIP, *v. t.* To form a point with something; to cover the tip, top, or end; as, to *tip* any thing with gold or silver. With truncheon *tip'd* with iron head.

*Hudibras.*

*Tip'd* with jet,

Fair ermines spotless as the snows they press. *Thomson.*

2. [for *tap*] To strike slightly, or with the end of any thing small; to tap.

A third rogue *tips* me by the elbow. *Swift.*

3. To cant up a cart or waggon and discharge its load.—4. In *vulgar lan.*, to give.—To *tip over*, to turn over.—To *tip off the liquor*, to turn up the vessel till all is out.—To *tip the winch*, to direct a wink, or to wink to another for notice. [*Vulgar.*]

TIP, *v. i.* In the phrase to *tip off*, that is, to fall headlong; hence, to die. [*Vulgar.*]

TIP'PED, } *pp.* Having the end covered.

TIPT, }

TIP'PET, *n.* [Sax. *tæppet*.] It seems to be formed from *tæppe*, tape.] A narrow garment or covering for the neck, worn by females. It is now generally made of fur, though formerly of some kind of cloth.

TIPPING, *ppr.* Covering the end or tip.—2. In *music*, a distinct articulation given to the flute, by striking the tongue against the roof of the mouth.

TIP'PING WAGGON, *n.* A waggon that can be upset or canted up in order to discharge its load, without requiring the horses to be unyoked.

TIP'PLE, *v. i.* [Qu. D. *zuipen*; Fr. *tope*.] This word and *tope* are probably of one family, and I suspect them to be from the root of *dip*. See DRINK.] To drink spirituous or strong liquors habitually; to indulge in the frequent and improper use of spirituous liquors. When a man begins to *tipple*, let his creditors secure their debts.

TIP'PLE, *v. t.* To drink, as strong liquors, in luxury or excess.

Himself for saving charges

A peel'd, slic'd onion eats, and *tipples* verjuice. *Dryden.*

TIP'PLE, *n.* Drink; liquor taken in tipping.

TIP'PLE, *n.* In *hay-making*, a bundle of hay collected from the swath, and formed into a conical shape. This is tied near the top, so as to make it taper to a point, and set upon its base to dry. [*Lancashire.*]

TIP'PLED, *pp.* Drank in excess.—2. *a.* Intoxicated; inebriated.

TIP'PLER, *n.* One who habitually indulges in the excessive use of spirituous liquors; a drunkard; a sot. It however often signifies a person who habitually drinks strong liquors, without absolute drunkenness.

TIP'PLING, *ppr.* Indulging in the habitual use of strong or spirituous liquors.

TIP'PLING, *n.* The habitual practice of drinking strong or spirituous liquors; a drinking to excess.

TIP'PLING, *n.* A mode of making hay, by forming it into tipples. [See TIPPLE.]

TIP'PLING-HOUSE, *n.* [*tipple* and *house*.] A house in which liquors are sold in drams or small quantities, and where men are accustomed to spend their time and money in excessive drinking.

TIP'SILY, *adv.* In a tipsy manner.

TIP'-STAFF, *n.* [*tip* and *staff*.] An officer who bears a staff tipped with metal; a constable. *Tip-staffs* are officers who attend upon the judges of the King's (Queen's) Bench, with a kind of rod tipped with silver; they also take into custody all persons who are committed by the court.—2. A staff tipped with metal.

TIP'SY, *a.* [from *tipple*.] Fuddled; overpowered with strong drink; intoxicated.

TIP'TOE, *n.* [*tip* and *toe*.] The end of the toe.

Upon his *tiptoes* stalketh stately by.

*Spenser.*

To be or to stand a *tiptoe*, to be awake or alive to any thing; to be roused; as, to be a *tiptoe* with expectation.

TIP'TOP, *n.* The highest or utmost degree.

TIP'ULA, *n.* A genus of dipterous insects, which includes the various species of crane-fly. They have very long legs, as may be seen in *T. sylvestris*, or Father-long-legs. There are nearly fifty British species.

TIP'ULARY, *a.* [L. *tipula*.] Pertaining to insects of the genus *Tipula* or crane fly.

TIPULIDÆ, *n.* Leach's name for a very extensive family of dipterous insects belonging to the section *nomocera*. It corresponds with the genus *Tipula* of Linnaeus.

TIRADE, *n.* [It. *tirata*; Fr. *tirade*, a train or series, from *tirer*, to draw.] 1. Formerly in French music, the filling of an interval by the intermediate diatonic notes.—2. In *modern usage*, a strain or flight; a series of violent declamation; a declamatory flight of censure or reproof.

Here he delivers a violent *tirade* against all persons who profess to know any thing about angels. *Quart. Review.*

TIRAIL'LEUR, *n.* (tirail'-yur.) [Fr.] A French skirmishing soldier, corresponding to the sharpshooters in the British army.

TIRE, *n.* [Heb. טור *tur*, a row or series.] 1. A tier; a row or rank. This is the same word as *tier*, differently written. [See TIER and TOUR.]—2. A head dress; something that encompasses the head. [See TIARA.] Ezek. xxiv; Is. iii.

On her head she wore a *tire* of gold.

*Spenser.*

3. Furniture; apparatus; as, the *tire* of war.—4. Attire. [See ATTIRE.]—5. A band or hoop of iron, used to bind the felloes of wheels, to secure them from wearing and breaking; as, cart-

*tire*; waggon-*tire*. This *tire*, however, is sometimes formed of different pieces, and is not one entire hoop.

TIRE,† *v. t.* To adorn; to attire; to dress; as the head. [See ATTIRE.] 2 Kings ix.

TIRE, *v. t.* [Sax. *teorian*, *ateorian*, *geteorian*, to fail. In D. *teeren* signifies to *tar*, to pine, to waste or consume, to digest; Gr. τάρω; L. *tero*. In Ir. and Gaelic, *tor*, *torus*, *tuirse*, is weariness; *tuirisghim*, to weary, to tire.] 1. To weary; to fatigue; to exhaust the strength by toil or labour; as, to *tire* a horse or an ox. A long day's work in summer will *tire* the labourer. *Tir'd* with toil, all hopes of safety past. *Dryden.*

2. To weary; to fatigue; to exhaust the power of attending, or to exhaust patience with dulness or tediousness. A dull advocate may *tire* the court and jury, and injure his cause.—To *tire out*, to weary or fatigue to excess; to harass.

TIRE, *v. i.* To become weary; to be fatigued; to have the strength fail; to have the patience exhausted. A feeble body soon *tires* with hard labour.

TIRE,† *v. i.* To tear or rend in pieces; to prey upon; as a bird.

TIRED, *pp.* Wearied; fatigued.

TIREDNESS, *n.* The state of being weary; weariness.

TIRE-SMITH, *n.* One who makes iron-work for coaches, &c.

TIRE-SOME, *a.* Wearisome; fatiguing; exhausting the strength; as, a *tiresome* day's work; a *tiresome* journey.—2. Tedious; exhausting the patience; as, a *tiresome* discourse. The debates in parliament are said to be sometimes very *tiresome*.

TIRE-SOMENESS, *n.* The act or quality of tiring or exhausting strength or patience; wearisomeness; tediousness; as, the *tiresomeness* of work or of a dull speaker.

TIREWÖMAN,† *n.* [*tire* and *woman*.] A woman whose occupation is to make head dresses.

TIRING, *ppr.* Wearying; fatiguing; exhausting strength or patience.

TIRING-HOUSE, } *n.* The room or

TIRING-ROOM, } place where players dress for the stage.

TIRL, *n.* A smart tap or stroke. [Scotch.]

TIRL, *v. t.* To uncover; as to *tirl* a house; to strip. As a *verb intrans.*, to touch so as to produce a tremulous motion. [Scotch.]

TIR'Ö, *n.* [L.] A tyro,—*which see*.

TIROCIN'UM, *n.* [L.] The first service of a soldier; the first rudiments of any art; novitiate: hence used by Cowper, as a title for a poem on schools.

TIRO'NIAN NOTES. The short hand of Roman antiquity, said to have been introduced into Rome by Tiro the freedman, and favourite of Cicero. The Tiroonian notes consist of arbitrary signs, substituted for words and phrases. They are still common in marginal notes.

TIRR, *v. t.* [Sax. *tyrwan*, to tear.] To tear; to uncover; to unroof; to strip; to pare off the sward by means of a spade. [Scotch.]

TIR'RA LIR'RA,† *n.* The note of the lark.

TIR'RIT,† *n.* Terror; affright.

TIR'WIT, *n.* One of the names given to the Lapwing, the *Vanelus cristatus*, a well known migratory bird. [See LAPWING.]

**TIS**, a contraction of *it is*, often used in poetry.

**TISAN**. See **PTISAN**.

**TIS'IC**, } *a. (s as z.)* [for *phthisic*,  
**TIS'ICAL**, } *phthisical.*] Consump-  
tive.

**TIS'IC**, *n. (s as z.)* [supra.] Consumption; morbid waste.

**TIS'RI**, *n.* The first Hebrew month of the civil year, and the seventh of the ecclesiastical; answering to a part of our September and a part of October.

**TISSUE**, *n. (tish' u.)* [Fr. *tissu*, woven; *tisser*, to lay the ground-work of lace, to weave.] 1. Cloth interwoven with gold or silver, or with figured colours.

A robe of *tissue*, stiff with golden wire.

*Dryden.*

2. In *anat.*, texture or organization of parts. The peculiar intimate structure of a part is called its *tissue*. A part of a fibrous structure is called a *fibrous tissue*. The organs of the body are made up of simpler elements, some generally diffused through the body, and others peculiar to particular organs. These simpler structures are called the *tissues* of the body; as, the cellular *tissue*; and the mucous *tissue*, &c. The *cellular tissue* is the cellular membrane.

—3. In *bot.*, the minute elementary parts of which the organs of plants are composed. These elementary structures differ from each other, and are so minute as generally to be distinctly visible only with the aid of the microscope. They are named *elementary organs*, *organic tissue*, or *vegetable tissue*. When a leaf or a portion of the stem of one of the higher plants is submitted to the microscope, it is found to consist, 1. of a thin transparent homogeneous membrane, which is arranged in the form of cells or cylindrical tubes; 2. of fibres which are arranged in a spiral form in the interior of the cells or tubes; and, 3. of a fluid, filling the cells, and existing between them, and containing in it globules of various sizes and kinds. These parts constitute what are known respectively as *elementary membrane*, *elementary fibre*, and *organic mucus*. The elementary fibre is only found in the higher forms of plants, the other two are found in all plants. The *tissues* of plants then are composed of elementary membrane and elementary fibre, and the principal forms under which they exhibit themselves constitute the *fibrous tissue*, *cellular tissue*, and *vascular tissue*. *Fibrous tissue* is that in which elementary fibre alone is apparent. *Cellular tissue* is composed of membrane in the form of cells or cavities which are closed on all sides, and are commonly of a spheroidal form, although they often assume various other forms. The pith of plants is entirely composed of cellular tissue, but it enters largely into the structure of other parts, and in many is the only tissue. When the cells are composed of membrane and fibre combined, or of fibre alone, they constitute the *fibro-cellular tissue*. *Vascular or tubular tissue* is composed of very elongated membranous tubes, tapering at each end. It comprehends the *woody* and *laticiferous tissues*. When the tubes have within them a spiral fibre, or their walls marked with broken spiral lines or dots, arranged in a circular or spiral direction, they constitute *fibro-vascular tissue*.—4. A connected series; as, the whole story is a *tissue* of forgeries

or of falsehood.—*Tissue paper*, very thin gauze-like paper, such as is used to protect engravings in books.

**TIS'SUE**, *v. t.* To form tissue; to interweave; to variegate.

The chariot was covered with cloth of gold *tissued* upon blue. *Bacon.*

**TIS'SUED**, *pp.* Interwoven; formed with variegated work.

**TIS'SUING**, *ppr.* Interweaving; forming with variegated work.

**TIT**, *n.* Anything small; a small horse, in *contempt*; a woman, in *contempt*; a small bird; a titmouse or tomtit.

**TIT'AN**, *n.* In *myth.*, a son of *Cælus* and *Terra*, or of Heaven and Earth. The name of *Titans* was given to the children of *Cælus* and *Terra* in general. They are said to have dethroned their father, and waged war with *Jupiter* for the government, but were defeated and thrown into *Tartarus*.

**TIT'ANIAN**, } *a.* Pertaining to tit-  
**TITANIT'IC**, } *anium.*

**TIT'ANIATE**, *n.* A saline compound formed by the union of titanic acid with a salifiable base.

**TIT'ANIC ACID**, *n.* Peroxide of titanium. It is obtained from rutile, which is a native titanate of iron and manganese. It is a snow-white infusible solid, in its relations somewhat analogous to silicic acid. It is used in making the finer kinds of enamel for artificial teeth, from its whiteness and hardness.

**TITANIF'EROUS**, *a.* [titan or titanium, and *L. fero.*] Producing titanium; as, *titaniferous* pyrites.

**TIT'ANITE**, *n.* An ore of titanium, called also *Sphene*,—*which see.*

**TIT'ANIUM**, *n.* In *mineral.*, a metal discovered by Gregor in 1791, in a black sand in Cornwall. It was afterwards discovered by Klaproth in some other minerals, and he gave it the name it now bears. In 1822, Wollaston examined it, and ascertained its properties. It is found oxidized in several minerals; and occurs occasionally in the metallic form, in the slag iron works; as small cubical crystals, exactly similar to bright copper in appearance; of specific gravity 5.3, and very infusible. When heated with nitre they are oxidized, producing titanic acid. Titanium is dissolved in a mixture of nitric and hydrofluoric acid, under a very high temperature. Oxygen and titanium combine, forming the protoxide, which is a deep purple-coloured powder, and the peroxide or titanic acid. Titanium also combines with chlorine forming a bichloride, and with sulphur forming a bisulphuret. The ores of this metal are called *menachanite*, from *Menachan* in Cornwall, where it was originally found; *isereine*, from the river *Iser*, in *Silesia*; *nigrine*, from its black colour; *sphene*, *rutile*, *brookite*, *axotomous iron*, *crichtonite*, *ilmenite*, *mohsite*, *æschyntite*, *greenovite*, and *octahedrite* or *anatase*.

**TIT'BIT**, *n.* A tender piece. [See **TIDBIT**.]

**TIT'HABLE**, *a.* Subject to the payment of tithes.

**TITHE**, *n.* [Sax. *teotha*, probably contracted from *teogetha*, as the verb is *teighthian*, to decimate. See **TEN**.] The tenth part of any thing; but appropriately, the tenth part of the increase annually arising from the profits of land and stock, allotted to the clergy for their support. Tithes are *personal*, *predial*, or *mixed*; *per-*

*sonal*, when accruing from labour, art, trade, and navigation; *predial*, when issuing from the earth, as, hay, wood, grain, and fruit; and *mixed*, when accruing from beasts, which are fed from the ground. Another division of tithes is into *great* and *small*. *Great tithes*, consist of all species of corn and grain, hay, and wood; and *small tithes*, of predial tithes of other kinds, together with mixed and personal tithes. The great tithes belong to the rector, and are hence called *parsonage* tithes; and the latter are due to the vicar, and are hence called *vicarage* tithes. Tithes are either due *de jure* or by custom; to the latter class belong all personal tithes. The exemptions from tithes are composition, a *modus decimandi*, prescription, or act of parliament. *Commutation of tithes*, the conversion of tithes into a rent charge, payable in money, and chargeable on the land. Several acts of parliament have been passed for effecting the commutation of tithes in England and Ireland. In regard to tithes in Scotland, see **TEINDS**.

**TITHE**, *v. t.* To levy a tenth part on; to tax to the amount of a tenth.

When thou hast made an end of *tithing* all the tithes of thine increase; *Deut. xxvi.*

*Ye tithe* mint and rue; *Luke xi.*

**TITHE**, *v. i.* To pay tithes.

**TITHE**, *pp.* Taxed a tenth.

**TITHE-FREE**, *a.* Exempt from the payment of tithes.

**TITHE-GA'THERER**, *n.* One who collects tithes.

**TITHE-PAYING**, *a.* Paying tithes; subjected to pay tithes.

**TITHER**, *n.* One who tithes, or collects tithes.

**TITHING**, *ppr.* Levying a tax on, to the amount of a tenth.

**TITHING**, *n.* [Sax. *tithinga*, from *teothunge*.] A decenary; a number or company of ten householders, who dwelling near each other, were sureties or free pledges to the king for the good behaviour of each other. The institution of tithings in England is ascribed to *Alfred*, and although this institution has long ceased, the name and division are still retained in many parts of England.

**TITHING-MAN**, *n.* [tithing and *man*.]

In former times the chief man of a tithing; a headborough; one elected to preside over the tithing.—2. A peace officer; an under constable.—3. In *New England, America*, a parish officer annually elected to preserve good order in the church during divine service, and to make complaint of any disorderly conduct.

**TITHON'IC**, *a.* [Gr. *Tithonios*.] Pertaining to or denoting those rays of light which produce chemical effects.

**TITHONIC'ITY**, *n.* A name given to that property of light by which it produces chemical effects; supposed by some to be a distinct imponderable agent.

**TITHY'MAL**, *n.* [Fr. *tithymale*; Gr. *τιθυμαλός*, from *τιθημι*, the breast.] A plant of the genus *Euphorbia*, *E. antiqorum*.

**TIT'ILLATE**, *v. i.* [L. *titillo*.] To tickle. The pungent grains of *titillating* dust. *Pope.*

**TIT'ILLATING**, *ppr.* Tickling.

**TITIL'ATION**, *n.* [Fr. from L. *titillatio*.] 1. The act of tickling; or the state of being tickled.—2. Any slight pleasure.

The products of those *titillations* that reach no higher than the senses. *Glanville.*

**TITLARK**, *n.* [*tit* and *lark*.] A small bird, a species of *Alauda* or lark, the *Alauda pratensis*, Linn. According to modern ornithologists, the titlarks form a separate genus (Anthus.) They are slender shaped birds, having the plumage and long hinder toes of the true larks, but with the slender bills of the wagtails. The tree pipit (*A. trivialis*), the meadow pipit (*A. pratensis*), and the rock pipit (*A. obscurus*), are all known by the name of titlark.

**TITLE**, *n.* [*L. titulus*; *It. titolo*. This may belong to the family of *Gr. τῖβλος*, to set or put; *Sax. titilian*, to give.] 1. An inscription put over any thing as a name by which it is known.—2. The inscription in the beginning of a book, containing the subject of the work, and sometimes the author's name.—3. In *the civil and canon laws*, a chapter or division of a book.—4. An appellation of dignity, distinction, or pre-eminence given to persons.—*Titles of honour*, are words and phrases which belong to certain persons as their right in consequence of certain dignities being inherent in them, or conferred upon them; as, Emperor, King, Prince, Duke, Earl, Marquis, Knight, Right Reverend, Reverend, Doctor, Mayor, Provost, &c. &c.—5. A name; an appellation. Ill worthy I such title should belong  
*Milton.*

6. Right; or that which constitutes a just cause of exclusive possession; that which is the foundation of ownership; as, a good *title* to an estate; or an imperfect *title*. The lowest degree of *title* is naked possession, then comes the right of possession, and lastly the right of property, all which united complete the *title*. But *possession* is not essential to a complete *title*. A *title* to personal property may be acquired by occupancy. A *claim* is not a *title*. *Title*, in the *legal sense*, signifies the means by which a man becomes seized of real property, or possessed of personal property; as, *title* by descent, *title* by purchase, *title* by administration, *title* by bankruptcy, *title* by marriage, &c. The term is also used to signify, generally, a right to land. In *Scotland*, a *title* to heritage is regulated by the feudal system, and is therefore called a *feudal title*; also the writings shewing the derivation of the *title* are called a *feudal progress*.—*Active and passive titles*, in Scotch law,—see under *PASSIVE*.—7. The instrument which is evidence of a right; as a *title deed*, a charter, &c.—8. In *the canon law*, that by which a beneficiary holds a benefice. This is true and valid, or colourable. A *valid title* gives a right to the benefice. A *colourable title* appears to be valid, but is not.—9. In *ancient church records*, a church to which a priest was ordained, and where he was to reside.

**TITTLE**, *v. t.* To name; to call; to entitle.

**TITLED**, *pp.* Called; named.—2. *a.* Having a title.

**TITLE-DEEDS**, *n.* In *law*, the writings evidencing a man's right or title to property. [See *DEED*.]

**TITLE-LEAF**, *† n.* The leaf of a book on which the title is printed.

**TITLELESS**, *† a.* Not having a title or name.

**TITLE-PAGE**, *n.* [*title* and *page*.] The page of a book which contains its title.

**TITLING**, *ppr.* Calling; denominating; entitling.

**TITLING**, *n.* One of the names given to a bird of the genus *Saxicola*, the *S. rubicola*; also called moor-titling, stone-chat, stone-smith, &c. It belongs to the family of warblers.

**TITMOUSE**, *n. plur. Titmice.* [*tit*, small, and *mouse*.] The *Parus* of Linn., a passerine genus of birds, having a slender, short, conical, and straight beak, furnished with little hairs at the base, and the nostrils concealed among the feathers. The titmice are very active little birds, continually flitting and climbing from branch to branch, suspending themselves from the sprays in all sorts of positions, rending asunder

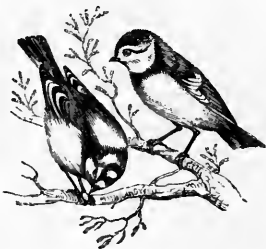

Blue Titmouse, male and female (*Parus caeruleus*).

the seeds on which they feed, devouring insects, wherever they see them; and not sparing even small birds when they happen to find them sick, and are able to put an end to them. Their notes are shrill and wild. They lay up stores of seeds, and build in the holes of old trees. The Great tit, Blue tit, Crested tit, Coal tit, Marsh tit, Long-tailed tit, and Bearded tit, are British species.

**TITTER**, *v. i.* To laugh with the tongue striking against the root of the upper teeth; to laugh with restraint.

**TITTER**, *n.* A restrained laugh.—2. A weed.

**TITTING**, *n.* Restrained laughter.

**TITTLE**, *n.* [from *tit*, small.] A small particle; a minute part; a jot; an iota.

**TITTLE**, *v. i.* To prate idly; to whisper. [*Scotch*.]

**TITTLE-TATTLE**, *n.* [*tattle*, doubled.] Idle trifling talk; empty prattle.—2. An idle trifling talker. [*Less proper*.]

**TITTLE-TATTLE**, *v. i.* To talk idly; to prate.

**TITTLE-TATTLING**, *n.* The act of prating idly.

**TITUBATE**, *v. i.* [*L. titubo*.] To stumble.

**TITUBATION**, *n.* [*L. titubo*, to stumble.] The act of stumbling.—2. In *med.*, restlessness; an inclination to constant change of position.

**TITULAR**, *a.* [*Fr. titulaire*; from *L. titulus*.] 1. Existing in title or name only; nominal; having or conferring the title only; as, a *titular king* or prince.—2. Having the title to an office or dignity without discharging the duties of it. Both Valerius and Austin were *titular bishops*.

**TITULAR**, *n.* A person invested with a title, in virtue of which he holds an office or benefice, whether he performs the duties of it or not. The term is generally applied to one who has the title only without

possession or enjoyment. *Titulars of the tithe*, in Scottish ecclesiastical history the name sometimes given to the *Lords of Election*. [See under *LORD*.]

**TITULARITY**, *n.* The state of being titular.

**TITULARLY**, *adv.* Nominally; by title only.

**TITULARY**, *a.* Consisting in a title.—2. Pertaining to a title.

**TITWARBLERS**, *n.* The name given by Swainson to a subgenus of his subfamily *Parianæ* or *Titmice*.

**TIVER**, *n.* A kind of ochre which is used in marking sheep in some parts of England. [*Local*.]

**TIVER**, *v. t.* To mark sheep with tiver, in different ways and for different purposes. [*Local*.]

**TIVERING**, *ppr.* Marking with tiver. [*Local*.]

**TIVERING**, *n.* The act or practice of marking with tiver. [*Local*.]

**TIVY**, *adv.* [See *TANTIVY*.] With great speed; a huntsman's word or sound.

**TME'SIS**, *n.* [*Gr.*] In *gram.*, a figure by which a compound word is separated into two parts, and one or more words inserted between them; as, of whom *be thou aware*; 2 *Tim. iv. 15*, for of whom *beware* thou also.

**TO**, *prep.* [*Sax. to*; *D. te* or *toe*; *G. zu*; *Ir. and Gaelic, do*; *Corn. tho*. This is probably a contracted word, but from what verb it is not easy to ascertain. The sense is obvious; it denotes passing, moving toward. The pronunciation is *to* or *too*, and this depends much on its application or its emphasis.] 1. Noting motion toward a place; opposed to *from*, or placed after another word expressing motion toward. He is going to church.—2. Noting motion toward a state or condition. He is going to a trade; he is rising to wealth and honour.—3. Noting accord or adaptation; as, an occupation suited to his taste; she has a husband to her mind.—4. Noting address or compulsion, or the direction of a discourse. These remarks were addressed to a large audience.

To you, my noble lord of Westmoreland; I pledge your grace. *Shak.*

5. Noting attention or application. Go, buckle to the law. *Dryden.*

Meditate on these things; give yourself wholly to them; 1 *Tim. iv.*

6. Noting addition. Add to your faith, virtue; 2 *Pet. i.*

Wisdom he has, and to his wisdom, courage. *Denham.*

7. Noting opposition. They engaged hand to hand.—8. Noting amount, rising to. They met us, to the number of three hundred.—9. Noting proportion; as, three is to nine as nine is to twenty-seven. It is ten to one that you will offend by your officiousness.—10. Noting possession or appropriation. We have a good seat; let us keep it to ourselves.—11. Noting perception; as, a substance sweet to the taste; an event painful to the mind.—12. Noting the subject of an affirmation. I have a king's oath to the contrary. *Shak.*

13. Noting the subject of remark or discussion; as, I shall speak to one point only; to speak to the question.—14. In comparison of.

All that they did was piety to this. *B. Jonson.*

15. As far as. Few of the Esquimaux can count to ten. *Quart. Rev.*



## 16. Noting intention.

Marks and points out each man of us to slaughter.

*B. Jonson.*

[In this sense, *for* is now used.]—17. After an adjective, noting the object; as, deaf to the cries of distress; alive to the sufferings of the poor. He was attentive to the company, or to the discourse.—18. Noting obligation; as, duty to God, and to our parents.—19. Noting enmity; as, a dislike to spirituous liquors.—20. Toward; as, she stretched her arms to heaven.—21. Noting effect or end. The prince was flattered to his ruin. He engaged in a war to his cost. Violent factions exist to the prejudice of the state.

Numbers were crowded to death. *Clarendon.*

22. *To*, as a sign of the infinitive, precedes the radical verb. Sometimes it is used instead of the ancient form, *for to*, noting purpose. David in his lifetime intended to build a temple. The legislature assembles annually to make and amend laws. The court will sit in February to try some important causes.—23. It precedes the radical verb after adjectives, noting the object; as, ready to go; prompt to obey; quick to hear, but slow to censure.—24. It precedes the radical verb, noting the object.

The delay of our hopes teaches us to mortify our desires.

*Smallridge.*

25. It precedes the radical verb, noting consequence.

I have done my utmost to lead my life so pleasantly as to forget my misfortunes.

*Pope.*

26. It notes extent, degree, or end. He languishes to death, even to death. The water rises to the height of twenty feet. The line extends from one end to the other.—27. After the substantive verb, and with the radical verb, it denotes futurity. The construction, we are to meet at ten o'clock, every man at death is to receive the reward of his deeds, is a particular form of expressing future time.—28. After *have* it denotes duty or necessity. I have a debt to pay on Saturday.—29. *To-day*, *to-night*, *to-morrow*, are peculiar phrases derived from our ancestors. *To* in the two first, has the sense or force of *this*; *this day*, *this night*. In the last, it is equivalent to *in or on*; *in or on the morrow*. The words may be considered as compounds, *to-day*, *to-night*, *to-morrow*, and usually as adverbs. But sometimes they are used as nouns; as, *to-day* is ours.—*To and fro*, backward and forward. In this phrase, *to* is adverbial.—*To the face*, in presence of; not in the absence of.

I withstood him face to face; Gal. ii.

*To-morrow*, *to-morrow*, and *to-morrow*; Creep in this petty pace from day to day.

*Shak.*

*Note.* In the foregoing explanation of *to*, it is to be considered that the definition given is not always the sense of *to* by itself, but the sense rather of the word preceding it, or connected with it, or of *to* in connection with other words. In general, *to* is used in the sense of moving toward a place, or toward an object, or it expresses direction toward a place, end, object, or purpose. *To* is often used adverbially to modify the sense of verbs; as, *to come to*; *to leave to*. The sense of such phrases is explained under the verbs respectively. In popular phrases like the following, "I will not come; you shall *to*, or *too*," a genuine Saxon

phrase, *to* denotes moreover, besides, *L. insuper.*

**TOAD**, *n.* [*Sax. tade, tadige.*] A paddock; the common name of the batrachian reptiles of the genus *Bufo*. Toads have a thick bulky body covered with warts or papillæ; a thick lump behind the ears, pierced with pores from which issues a milky and fetid fluid. They have no teeth; the hind feet are but slightly elongated. They leap badly, and generally avoid the water. They are hideous and disgusting animals, whose bite, saliva, &c., were formerly considered poisonous, but are now ascertained to be harmless. They have been known to remain whole years in walls, hollow trees, in the earth, and even, it is said, in the heart of a stone. Toads are found in all quarters of the world. The common toad and green toad inhabit not only Europe, but also Asia and Africa. Toads are most abundant in America. There are now several subgenera; such as *Rhinellus*, *Otilophis*, *Pipa*, &c.

**TOAD-EATER**, *n.* A vulgar name given to a fawning, obsequious parasite; a mean sycophant. [This name is said to have been first given to a gluttonous parasite, famous for his indiscriminate enjoyment and praise of all viands whatever set before him. To test his powers of stomach and complaisance, one of his patrons had a toad cooked and set before him, which he both ate and praised in his usual way.]

**TOAD-FISH**, *n.* [*toad and fish.*] A cartilaginous fish of the genus *Lophius*, the *L. europæus*, or *piscatorius*; called also fishing-frog, angler, sea-devil, and wide-gab. [See ANGLER, FISHING-FROG, &c.]

**TOAD-FLAX**, *n.* [*toad and flax.*] The English name of various plants of the genus *Linaria*. The common toad-flax is the *L. vulgaris*, which in its general habit is not unlike flax. The flowers are of a bright yellow, the corolla labiate, and provided with a long spur. It grows in hedges, and at the edges of fields. [See LINARIA.]

**TOADISH**, *† a.* Like a toad.

**TOAD'LET**, *n.* A little toad.

**TOAD'S BACK RAIL**. In *arch.*, a particular kind of hand-rail for stairs, so named from its shape.

**TOAD-STONE**, *n.* [*toad and stone.*] In *mineral.*, a sort of trap-rock, of a brownish grey colour. The *toad-stone* of Derbyshire is generally a dark brown basaltic amygdaloid, composed of basalt and green earth, and containing oblong cavities filled with calcareous spar.

**TOAD-STOOL**, *n.* [*toad and stool.*] A popular name applied to numerous species of fungi.

**TOADY**, *n.* A toad-eater,—*which see.* [*Colloq.*]

**TOAD'YISM**, *n.* Mean sycophancy. [*Colloq.*]

**TOAST**, *v. t.* [*Sp. and Port. tostar, to toast or roast. Qu. are these from the L. tostus?*] 1. To dry and scorch by the heat of a fire; as, *to toast bread or cheese.* [*It is chiefly limited in its application to these two articles.*]—2. To warm thoroughly; as, *to toast the feet.* [*Familiar.*]—3. To name or propose any one, whose health, success, &c., is to be drunk; to drink to the health in honour of; as, *to toast a lady.* Addison writes "to toast the health;" a form of expression we believe not now used.—4. To propose

any sentiment or subject to the honour, success, &c., of which a bumper is to be devoted; to drink in honour of any thing, or to its prosperity, success, &c.

**TOAST**, *v. i.* To give a toast or health to be drunk.

**TOAST**, *n.* Bread dried and scorched by the fire; or such bread dipped in melted butter, or in some liquor. Dry toast is bread scorched, or it is scorched bread with butter spread upon it. Soft toast is made by immersing toasted bread in melted butter, and called dipped toast.—2. A female whose health is drank in honour or respect.

The wise man's passion, and the vain man's toast.

*Pope.*

3. He or that which is named in honour in drinking.

**TOASTED**, *pp.* Scorched by heat; named in drinking the health.

**TOASTER**, *n.* One who toasts.—2. An instrument for toasting bread or cheese.

**TOASTING**, *ppr.* Scorching by fire; drinking to the honour of.

**TOAST-MAS'TER**, *n.* An officer appointed to announce toasts at great public banquets.

**TOBACCO**, *n.* [perhaps from *Tabaco*, a province of Yncatan, in Spanish America, where it was first found by the Spaniards. But this account of its origin is very doubtful. Las Casas says, that in the first voyage of Columbus, the Spaniards saw in Cuba many persons smoking dry herbs or leaves rolled up in tubes called *tabacos*. Charlevoix, in his History of St. Dominique, says that the instrument used in smoking was called *tabaco*.] A plant, a native of America, of the genus *Nicotiana*, the *N. tabacum*, the dried leaves



Tobacco (*Nicotiana tabacum*).

of which are much used for smoking and chewing, and in snuff. As a medicine, it is narcotic, emetic, and cathartic; and it possesses two additional powers at least, if not more. Tobacco has a strong disagreeable smell, and an acrid taste. When first used it sometimes occasions vomiting, &c., but the practice of using it in any form soon conquers distaste, and forms a relish for it that is strong and almost unconquerable. There are many other species of *Nicotiana*, most of which yield tobacco for smoking, and many of these are cultivated in the gardens of Europe. Tobacco is now very extensively cultivated on the European continent, in the Levant, and in India, but the tobacco of the United States is still very generally admitted to be superior to most others. The tobacco plants belong to the nat. order Solanaceæ. [See NICOTIANA.]

**TOBAC'CO-BOX,** } *n.* A recep-  
**TOBAC'CO-POUCH,** } tacle for hold-  
ing tobacco.

**TOBAC'CONING,** † *n.* Using tobacco.

**TOBAC'CONIST,** *n.* A dealer in tobacco; also, a manufacturer of tobacco.

**TOBAC'CO-PIPE,** *n.* [*tobacco* and *pipe*.] A pipe used for smoking tobacco, often made of clay and baked, sometimes of other material.

**TOBAC'CO-PIPE CLAY,** *n.* A species of clay; called also cimolite.

**TOBAC'CO-PIPE FISH,** *n.* A name of the *Syngnathus acus* of Linn.; called also needle-fish.

**TOBAC'CO-STOPPER,** *n.* An instrument for pressing down the tobacco as it is smoked in a pipe.

**TO'BINE,** *n.* A stout twilled silk, used for dresses; it much resembles the Florentine.

**TOCEA'TA,** *n.* [*It.*] In music, a prelude.

**TOCHER,** *n.* [*Ir. tochar,* a dowry.] In *Scots law*, the dowry which a wife brings to her husband by marriage, as provided in her marriage settlement. On the dissolution of the marriage within a year and a day, without a living child, the tocher returns to the contractor of the marriage, not to the wife or her representatives.

**TOCK'AY,** *n.* A species of spotted lizard in India.

**TOCOL'OGY,** *n.* [*Gr. tocolos,* parturition, and *logos,*] The science of obstetrics or midwifery; or that department of medicine which treats of parturition. [*Little used.*]

**TOC'SIN,** *n.* [*Fr.*; Armoric, *toeq,* a stroke, from the root of *touch,* and *sonn* or *seting,* sound.] An alarm bell, or the ringing of a bell for the purpose of alarm.

**TOD,** *n.* [*In Gaelic, tod* is a clod, a mass.] 1. † A bush; a thick shrub.—2. An old weight used chiefly in buying wool. It is equal to twenty-eight pounds, or two stone; but there are several local tods.—3. In *Scotch* and *old English*, a fox from his bushy tail.

**TOD,** † *v. t.* To weigh; to produce a tod.

**TO-DAY,** *n.* [*to* and *day*.] The present day.

**TODD'A'LIA,** *n.* A genus of plants, nat. order Rutaceæ. The species, which are few in number, consist of moderate-sized shrubs, with alternate trifoliate leaves full of pellucid-dots; the flowers in axillary or terminal racemes or panicles. They inhabit the hot parts of India, the Mauritius, and Brazil. The bark and root of *T. aculeata*, which grows at the base of the Himalayan mountains, are said to be used as a cure for the remittent fever of jungly situations. Many of the allied species are possessed of bitter and aromatic properties.

**TODDLE,** *v. i.* To saunter about feebly; to walk with short steps in a tottering way, as a child or an old man. [*Scotch, also an obsol. Eng. word.*]

**TOD'DY,** or **PALM WINE,** *n.* A name given to the juice which flows from the wounded spathes of many palms, such as cocoa-nut, talipot palm, *Raphia vinifera*, and *Mauritia vinifera*. When newly drawn the juice is sweet, and has a peculiar flavour, operating in general as a laxative. It is much in demand as a beverage in the neighbourhood of villages in India, especially where European troops are stationed. When it has undergone fermentation, it is highly intoxicating. The fermented juice distilled with some

other ingredients forms the spirituous liquor called *arrack*, or *rack*.—2. A mixture of spirit and water sweetened; as, whisky *toddy*; rum *toddy*, &c. *Toddy* differs from *grog* in having a less proportion of spirit, and in being sweetened. *Grog* is made with cold water, but *toddy* always with boiling water.

**TODIRAM'PHUS,** *n.* A genus of kingfishers, found in the islands of the South Seas.

**TODD'**, *n.* Ado; bustle; hurry. [*Colloq.*]

**TO'DY,** *n.* The popular name of an insectivorous genus of passerine birds of America, somewhat resembling the kingfishers. They are small birds, living upon insects which they catch in the mud, or in the water. There is only one determined species, the *Todus viridis*, or green tody.

**TOE,** *n.* [*Sax. ta*; *G. zeh*; *Sw. ta*; *Dan. ta*; *Fr. doigt du pied*; *L. digitus*.] *Toe* is contracted from *tog*, the primary word on which *L. digitus* is formed, coinciding with *dug*, and signifying a shoot.] 1. One of the small members which form the extremity of the foot, corresponding to a finger on the hand. The toes in their form and structure resemble the fingers, but are shorter.—2. The fore part of the hoof of a horse, and of other hoofed animals.—3. The member of a beast's foot corresponding to the toe in man.

**TO'ED,** *a.* In compounds, having toes, as narrow-toed; thick-toed; slender-toed.

**TOFA'NA.** See **AQUA TOFANA.**

**TOF'FY,** *n.* A kind of tablet sweetmeat, and usually called *Everton toffy*. It is composed of sugar and butter.

**TOFIEL'DIA,** *n.* A genus of plants, class Hexandria, and order Trigynia, Linn.; nat. order Melanthaceæ. *T. palustris*, Scottish asphodel, the only British species, is a perennial herb, with sword-shaped leaves, and greenish white flowers growing in a dense spike. It grows in wet, spongy mountain bogs in Scotland, the north of England, and Ireland.

**TOFORE,** † *prep.* or *adv.* [*Sax. toforan*; *to* and *fore*.] Before; formerly.

**TOFT,** *n.* [probably from the root of *tuft*.] 1. A grove of trees.—2. [*Dan. tofte* or *tomt*.] In *law books*, a message, or rather a place where a message has stood, but is decayed. It is a word getting into disuse.

**TO'FUS,** *n.* Tufa,—*which see.*

**TO'GA,** *n.* [*L.*] The name given to the



Roman in his Toga.

principal outer garment worn by the Romans. It was a loose flowing gar-

ment made of wool, and sometimes of silk, the usual colour being white. It covered the whole body with the exception of the right arm, and the right of wearing it was the exclusive privilege of every Roman citizen. The *toga virilis*, or manly gown, was assumed by Roman youths when they attained the age of fourteen. The *toga prætexta* was worn by the children of the nobles, by girls until they were married, and by boys until they were fourteen, when they assumed the *toga virilis*. It was also the official robe of the higher magistrates of the city. The *toga picta*, or ornamented toga, was worn by generals in their triumph.

**TO'GATED,** } *a.* [*L. toga*, a gown; *toga*;  
**TO'GED,** } *tus*, gowned.] Gowned; dressed in a gown; wearing a gown; as, *toged consuls*.

**TOGETHER,** *adv.* [*Sax. togethre*; *to* and *gather*.] 1. In company. We walked together to the wood.—2. In or into union.

The king joined humanity and policy together.

*Bacon*. 3. In the same place; as, to live together in one house.—4. In the same time; as, to live together in the same age.—5. In concert; as, the allies made war upon France together.—6. Into junction or a state of union; as, to sew, knit, pin, or fasten two things together; to mix things together.—*Together with*, in union with; in company or mixture with.

Take the bad together with the good.

*Dryden*.

**TOG'GEL,** } *n.* In ships, a pin placed  
**TOG'GLE,** } through the bight or eye of a rope, block-strap, or bolt, to keep it in its place, or to put the bight or eye of another rope upon, and thus secure them both together.—*Toggle-joint*, an elbow or knee-joint, consisting of two bars, so connected that they may be brought into a straight line.

**TOG'GERY,** *n.* [*L. toga*.] Clothes; garments. [*Ludicrous or low*.]

**TOIL,** *v. i.* [*Sax. teolan, tiolan*, to strive, strain, urge, to prepare, to heal, to toil, and *tilian, tiligan*, to prepare or provide, to till, to toil, to study or be solicitous; *Russ. dialayu*.] The primary sense is expressed in the Saxon, to strain, to urge.] To labour; to work; to exert strength with pain and fatigue of body or mind, particularly of the body, with efforts of some continuance or duration.

Master, we have toiled all night and caught nothing; Luke v.

**TOIL,** *v. t.* To toil out, to labour; to work out.

*Toil'd out* my uncouth passage. *Milton*. 2. † To weary; to overlabour; as, *toil'd* with works of war.

**TOIL,** *n.* Labour with pain and fatigue; labour that oppresses the body or mind.

*Toil* may be the labour of the field or the workshop, or of the camp. What *toils* men endure for the acquisition of wealth, power, and honour! *Gen. v.*  
**TOIL,** *n.* [*Fr. toiles*, snare, trap; *Ir. dul*, a snare or gin; *L. tela*, a web; from spreading, extending, or laying.] A net or snare; any thread, web, or string spread for taking prey.

A fly falls into the toils of a spider.

*L'Etrange*.  
**TOIL'ER,** *n.* One who toils, or labours with pain.

**TOILET,** *n.* [*Fr. toilette*, from *toile*, cloth.] 1. A covering or cloth of linen, silk, or tapestry, spread over a table in

a chamber or dressing room. Hence —2. A dressing table.—3. Mode of dressing; as, her *toilet* is perfect.—*To make one's toilet*, to dress; to adjust one's dress with care.

**TOILET-TABLE**, *n.* A dressing table.  
**TOILFUL**, *a.* Toilsome; wearisome.  
**TOILINETTE**, *n.* [Fr.] A cloth, the woft of which is of woollen yarn, and the warp of cotton and silk. It is used for vests.

**TOILING**, *ppr.* Labouring with pain.  
**TOILLESS**, *a.* Free from toil.  
**TOILSOME**, *a.* Laborious; wearisome; attended with fatigue and pain; as, *toilsome* work; a *toilsome* task.

What can be *toilsome* in these pleasant walks? *Milton.*

2. Producing toil; as, a *toilsome* day or journey.

**TOILSOMELY**, *adv.* In a toilsome manner.

**TOILSOMENESS**, *n.* Laboriousness; wearisomeness.

**TOISE**, *n.* (tois.) [Fr.] A fathom or long measure in France, containing six French feet, or 1.94 metres. It is equivalent to 6.395 English feet.

**TOKAY**, *n.* A rich highly prized wine produced at Tokay in Upper Hungary, made of white grapes. It is distinguished from other wines by its aromatic taste. It is not good till it is about three years old, and it continues to improve as long as it is kept. This wine is produced from grapes grown in the vineyards on the side of a low chain of hills, never more than about 700 feet above the sea level, named the Hegyalla. The total annual production is estimated at 200,000 to 240,000 eimer of 12 gallons each. Much wine, the produce of other localities in Hungary, is sold as Tokay.

**TOKEN**, *n.* (to'kn.) [Sax. *tacn*, *tacen*; Goth. *takns*; Sw. *tekn*; G. *zeichen*. This may be the same word as the L. *signum*, dialectically varied, or from the same radix; Gr. *σημα*.] 1. A sign; something intended to represent or indicate another thing or an event. Thus the rainbow was a *token* of God's covenant established with Noah. The blood of the paschal lamb, sprinkled on the doors of the Hebrews, was a *token* of the destroying angel of God's will that he should pass by those houses; Gen. ix.; Exod. xii.

Show me a *token* for good; Ps. lxxxvi.

2. A mark; indication; symptom. In pestilential diseases, tokens are livid spots upon the body, which indicate the approach of death.

They have not the least *token* or show of the arts and industry of China. *Heylin.*

3. A memorial of friendship; something by which the friendship of another person is to be kept in mind.—4. A piece of money current by sufferance, and not coined by authority.

In the reign of Elizabeth, coins, called *tokens*, were struck by the corporations of Bristol, Oxford, and Worcester; others also by private persons, even at a late period. In 1797, 5s. *tokens* were issued by the bank of England; and, in 1811, 2s. and 1s. 6d. *tokens*, which circulated till the year 1816. *Ency.*

5. In *printing*, ten quires of paper; an extra quire is usually added to every other token, when counted out for the press.—6. In *Scotland*, a ticket of admission to the sacrament of the Lord's Supper. These tickets are usually of metal, stamped with the name of the parish or church to which they belong.

**TO'KEN**, *v. t.* To make known.

**TO'KENED**, *a.* Being marked with spots.

**TO'KENING**, *ppr.* Making known; marking with spots.

**TOL**, *v. t.* [L. *tollo*.] To take away; a law term. [See **TOLL**.]

**TOLA**, *n.* In *India*, a weight for gold and silver, but different in different places.  
**TOL-BOOTH**. See **TOLL-BOOTH**.

**TOLD**, *pret.* and *pp.* of *Tell*.

Who told thee that thou wast naked? Gen. iii.

Thou hast mocked me, and *told* me lies; Judges xvi.

Sheep and oxen that could not be *told*; 1 Kings viii.

**TOLÉ**, *v. t.* To draw or cause to follow by presenting something pleasing or desirable to view; to allure by some bait.

**TOLÉD**, *pp.* Drawn; allured; induced to follow.

**TOLEDO**, *n.* A sword-TOLEDO-BLADE, } blade of the finest temper, so named from Toledo in Spain, which, during the 15th and 16th centuries, was famous for manufacturing sword-blades of a superior temper.

You sold me a rapier; you told me it was a *toledo*. *B. Jonson.*

*Tables of Toledo*, a set of astronomical tables, calculated for the meridian of Toledo, about the year 1080, by a Moor of the name of Arzachel. They are found to be very inaccurate.

**TOLERABLE**, *a.* [Fr. from L. *tolerabilis*. See **TOLERATE**.] 1. That may be borne or endured; supportable, either physically or mentally. The cold in Canada is severe, but *tolerable*. The insults and indignities of our enemies are not *tolerable*.

It shall be more *tolerable* for the land of Sodom and Gomorrah in the day of judgment, than for that city; Matth. x.

2. Moderately good or agreeable; not contemptible; not very excellent or pleasing, but such as can be borne or received without disgust, resentment, or opposition; as, a *tolerable* translation; a *tolerable* entertainment; a *tolerable* administration.

**TOLERABLENESS**, *n.* The state of being tolerable.

**TOLERABLY**, *adv.* Supportably; in a manner to be endured.—2. Moderately well; passably; not perfectly; as, a constitution *tolerably* firm. The advocate speaks *tolerably* well.

**TOLERANCE**, *n.* [L. *tolerantia*, from *tolero*, to bear.] The power or capacity of enduring; or the act of enduring.

Diogenes one frosty morning came to the market-place shaking, to show his *tolerance*. [Little used.] *Bacon.*

2. A feeling or habit which disposes a person to be patient and indulgent towards those whose opinions or practices differ from his own, provided such opinions are sincerely maintained, and such practices spring from upright motives. To reprobate and denounce others, merely because their actions, honestly meant, and opinions, sincerely maintained, differ from our own, is *intolerance*.

**TOLERANT**, *a.* Enduring; indulgent; favouring toleration.

**TOLERATE**, *v. t.* [Fr. *tolerer*; L. *tolero*, from *tollo*, to lift; Ch. *לָוַה*, *deal*, to lift or raise.] To suffer to be or to be done without prohibition or hindrance; to allow or permit negatively, by not preventing; not to restrain; as,

to *tolerate* opinions or practices. The Protestant religion is *tolerated* in France, and the Romish in Great Britain.

Crying should not be *tolerated* in children. *Locke.*

The law of love *tolerates* no vice, and patronizes every virtue. *G. Spring.*

**TOLERATED**, *pp.* Suffered; allowed; not prohibited or restrained.

**TOLERATING**, *ppr.* Enduring; suffering to be or to be done; allowing; not restraining.

**TOLERATION**, *n.* [L. *toleratio*.] The act of tolerating; the allowance of that which is not wholly approved; appropriately, the allowance of religious opinions and modes of worship in a state, when contrary to or different from those of the established church or belief. *Toleration* implies a right in the sovereign to control men in their opinions and worship, or it implies the actual exercise of power in such control. Every person is as much entitled to liberty of opinion on religious subjects as on any other, and has a right to adopt any mode of worship, and hold any doctrines which are not inconsistent with the peace and safety of the state, and the moral welfare of its members. The civil magistrate has a right to check the propagation of opinions and doctrines, which tend only to sap the foundations of morality, and to disturb the peace of society; but he has no right to restrain men from publicly professing any system of faith, which comprehends the being and providence of God, the great laws of morality, and a future state of rewards and punishments. There are two kinds of toleration, as laid down by Paley: 1. The allowing to dissenters the unmolested profession and exercise of their religion, but with an exclusion from offices of trust and emolument in the state; this is called a *partial* toleration. 2. The admitting dissenters, without distinction, to all the civil privileges and capacities of other citizens; this is called a *complete* toleration. Where no power exists or none is assumed to establish a creed and a mode of worship, there can be no *toleration*, in the strict sense of the word, for one religious denomination has as good a right as another to the free enjoyment of its creed and worship.—2. In an *eccles. sense*, the allowance which the church grants to its members to differ in certain opinions, not considered fundamental.—*Toleration act*, an act passed in the reign of William and Mary, in favour of dissenters and Roman catholics.

**TOLLING**, *ppr.* Drawing away; inducing to follow.

**TOLL**, *n.* [Sax. *toll*; D. *tol*; G. *zoll*; W. *toll*, a fraction, a toll; *toli* and *tolliau*, to curtail, to diminish, to take away, to spare or save, to deal out, from *tawl*, a throw, a casting off, a separation, a cutting off; *toll*, from *toll*, to subtract, to take toll; Gr. *τολ*, toll, custom, and end, exit, from cutting off; Fr. *tailleur*, to cut off, [see **TAILL**.] Ir. *deilim*, to separate; *dail*, a share, Eng. *dole*; *diolam*, to sell, to exchange, to pay toll. This is from the root of *deal*. See **DEAL**, Sax. *bedalan*.] 1. A tax paid, or duty imposed, for some liberty or privilege. Particularly a payment directed to be made to the proprietors of canals and railways, the trustees of turnpike roads

or bridges, &c., in respect of the passage of passengers, or the conveyance of cattle and goods. The right whether to take toll, or to be exempt from its payment, rests upon prescriptive usage or royal grant.—2. A fixed sum payable to the owner of a fair or market, or to the corporation of a town, from the buyer of tollable articles sold there. Also, the compensation paid for the use of the soil by those who erect stalls in the fair or market, or for the liberty of picking holes for the purpose of temporary erections; but the former payment is more properly called *stallage*, and the latter *picage*.—3. A portion of grain taken by a miller as a compensation for grinding. Also, the portion of mineral which the owner of the soil is entitled by custom or agreement to take, without paying for it, out of the quantity brought to the surface; or, as it is technically called, to *grass*.—*Toll traverse*, the toll taken by a person for beasts or goods passing across his ground.—*Toll thorough*, the toll taken by a town for persons, cattle, or goods going through it, or over a bridge or ferry maintained at its cost.—*Port tolls*, tolls claimed by the owner or owners of a port, in respect of goods shipped or landed there. Such tolls are more commonly called *port-dues*.—*Turn toll*, a toll in some cases demandable for beasts which are driven to the market, and return unsold.

**TOLL**, *v. i.* To pay toll or tallage.—2. To take toll, as by a miller.

**TOLL**, *v. t.* To take from, as a part of a general contribution or tax; to exact, as a tribute.

**TOLL**, *v. i.* [*W. tol, tolo*, a loud sound, a din; *Pers. talidan*, to sound, to ring. We see that *W. tawl*, supra, is a throw or cast, a driving, and this is the radical sense of *sound*.] To sound or ring, as a bell, with strokes uniformly repeated at intervals, as at funerals, or in calling assemblies, or to announce the death of a person.

Now sink in sorrows with a *tolling* bell.

*Pope.*

**TOLL**, *v. t.* [supra.] To cause a bell to sound with strokes slowly and uniformly repeated, as for summoning public bodies or religious congregations to their meetings, or for announcing the death of a person, or to give solemnity to a funeral.

**TOLL**, *v. t.* [*L. tollō*.] 1. To take away; to vacate; to annul; a law term.—2. † To draw. [*See TOLE*.]

**TOLL**, *n.* A particular sounding of a bell.

**TOLLABLE**, *a.* Subject to the payment of toll; as, *tollable* goods.

**TOLLAGÉ**, *n.* Tallage,—*which see*.

**TOLL-BAR**, *n.* [*toll* and *bar*.] A bar, beam, or gate used for stopping boats on a canal at the toll-house, or on a road for stopping passengers.

**TOLL-BOOTH**, *n.* [*toll* and *booth*.] A place where goods are weighed to ascertain the duties or toll.—2. A prison.—3. In *Scotland*, the old word for a burgh-jail, so called because that was the name originally given to a temporary hut of boards erected in fairs and markets, in which the customs or duties were collected, and where such as did not pay, or were chargeable with some breach of the law, in buying or selling, were confined till reparation was made.

**TOLL-BOOTH**, *v. t.* To imprison in a toll-booth.

**TOLL-BRIDGE**, *n.* A bridge where toll is paid for passing it.

**TOLL-DISH**, *n.* A dish for measuring toll in mills.

**TOLLER**, *n.* One who collects taxes; a toll-gatherer.—2. One who tolls a bell.

**TOLL-GATE**, *n.* A gate where toll is taken.

**TOLL-GATHERER**, *n.* The man who takes toll.

**TOLL-HOP**, *n.* In *English law*, a dish to take toll in.

**TOLL-HOUSE**, *n.* A house or shed placed by a road near a toll-gate, or at the end of a toll-bridge, or by a canal, where the man who takes the toll remains.

**TÖLLING**, *ppr.* Causing to sound in a slow grave manner.—2. Taking away; removing.—3. Sounding, as a bell.

**TOLL'-MAN**, *n.* A toll-gatherer.

**TOL'MEN**, or **DOL'MEN**, *n.* [*Celtic dol*, table, and *men*, stone.] A species of druidical monument, composed of a large stone placed horizontally upon other stones, fixed vertically in the earth, about three or four feet high, and not fewer in number than three, nor more than fifteen. In form it is generally a parallelogram. The *tolmen* is also at times composed only of

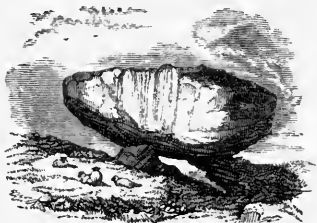

Constantine Tolmen, Cornwall.

Consisting of a vast stone 33 feet long, 14½ deep, and 18½ across. This stone is calculated to weigh 750 tons, and is poised on the points of two natural rocks.

a large stone, one end resting on the ground, and the other end supported by a stone placed under it. The large stone or table has generally a hole pierced through. Some have supposed the *tolmen* to be a kind of druidical oracle, the hole through the stone being an acoustic contrivance, by means of which the priests could return oracular answers. Others suppose the *tolmen* to have been altars on which victims were sacrificed; the hole being used as a means of dispersing the blood of the victim on those who wished such bloody baptism. A third opinion is, that they indicate, or rather constitute, places of sepulture. They are also called *cromlechs*.

**TOL'SEY**, † *n.* A toll-booth; a place where port-tolls were set or assessed, and where merchants usually assembled, and commercial courts were held, as at the modern exchange.

**TOLT**, *n.* [*L. tollit, tollō*.] In *English courts*, the precept of a sheriff, by which a writ of right is removed from the court baron into the county court.

**TOLU**, } *n.* A resin, or oleo-  
**TOLU-BAL'SAM**, } resin, produced by a tree of South America, the *Myrospermum toluiferum*, or *peruiferum*. It is said to have been first brought from a place called *Tolu*. [*See under BAL-*

**SAM**, and also **MYROSPERMUM**.] In *med.*, it is called *Balsam of Tolu*.



Tolu-balsam (*Myrospermum toluiferum*).

**TOLUTA'TION**, † *n.* [*L. toluto*.] A pacing or ambling.

**TOM'AHAWK**, *n.* An Indian hatchet. The tomahawks manufactured by the North American Indians, are headed with stone; but they employ also heads of metal, which are manufactured expressly for their use in civilized countries, with the hammer-head



Tomahawks of the North American Indians.

hollowed out to suit the purpose of a smoking pipe, the mouth-piece being in the end of the shaft. The tomahawk is the most valued of an Indian's weapons. In time of peace he uses it for cutting his firewood, &c., and in time of war it is the deadly weapon which he wields in the hand, or throws with unerring and fatal aim.

**TOM'AHAWK**, *v. t.* To cut or kill with a hatchet called a tomahawk.

**TOM'AHAWKED**, *pp.* Smitten or killed with a tomahawk.

**TOM'AHAWKING**, *ppr.* Striking or killing with a tomahawk.

**TOMATO**, *n.* A plant and its fruit,



Tomato (*Lycopersicum esculentum*).

the *Lycopersicum esculentum* of late botanists, and the *Solanum lycopersi-*

*cum* of the older ones. It is called sometimes the *love-apple*, in allusion to its supposed power of exciting the tender feelings; and it is used as a common ingredient in sauces. [See LOVE-APPLE, and SOLANUM.]

**TÖMB**, *n.* (toom.) [Fr. *tombe, tombeau*; W. *tom, tomen, tum, twmp*, a mound, a heap; Ir. *tuoma*; Sp. *tumba*; L. *tumulus*, a heap or hillock; *tumeo*, to swell; Gr. *τομβος*. This name was given to a place for the dead by men who raised a heap of earth over the dead.] 1. A grave; a pit in which the dead body of a human being is deposited.

As one dead in the bottom of a *tomb*. *Shak.*  
2. A house or vault formed wholly or partly in the earth, with walls and a roof for the reception of the dead.—3. A monument erected to preserve the memory of the dead; any sepulchral structure.

**TÖMB**, *v. t.* To bury; to inter. [See ENTOMB.]

**TOMBAC**, *n.* An alloy formed by mixing and fusing together a large quantity of zinc with a smaller quantity of copper; or a species of brass with excess of zinc. When arsenic is added, it forms *white tombac*.

**TÖMBED**, *a.* Deceased in a tomb.

**TÖMBLESS**, *a.* Destitute of a tomb or sepulchral monument.

**TÖMBNORRY**, *n.* A Shetland bird.

**TÖMB** BOY, *n.* [*Tom, Thomas, and boy*.] 1. † A tumbler; a mountebank; a mean person.—2. A rude boisterous boy; also in sarcasm, a romping girl. [Vulgar.]

**TÖMBSTONE**, *n.* [*tomb and stone*.] A stone erected over a grave, to preserve the memory of the deceased; a monument.

**TÖM-CAT**, *n.* A full-grown male cat. [Called by the older authors a ram-cat.]

**TÖM-CÖD**, *n.* An American fish of the cod kind, about ten or twelve inches long.

**TÖME**, *n.* [Fr. from Gr. *τομος*, a piece or section, from *τομω*, to cut off.] A book; as many writings as are bound in a volume, forming the part of a larger work. It may be applied to a single volume.

**TÖME-LET**, *n.* A small tome or volume.

**TÖMENT**, } *n.* [See TÖMENTÖSE.]

**TÖMENT'UM**, } In *anat.*, a term applied to the small vessels on the surface of the brain, which appear like wool.—2. In *bot.*, a species of pubescence, consisting of longish, soft, entangled hairs, pressed close to the surface.

**TÖMENTÖSE**, } *a.* [L. *tomentum*,  
**TÖMENTÖUS**, } down.] In *botany*, downy; nappy; cottony; or flaky; covered with hairs so close as scarcely to be discernible, or with a whitish down, like wool; as, a *tomentous stem* or leaf.

**TÖM-FÖÖL**, *n.* A great fool; a trifier.

**TÖM-FÖÖL'ERY**, *n.* Foolish; trifling.

**TÖM-NÖDDY**, *n.* A sea-bird, the puffin.

**TÖ-MÖR'RÖW**, *n.* [*to and morrow*.]

The day after the present.

One to-day is worth two to-morrow.

Franklin.

**TÖM-PÖN**, *n.* [Fr. *tampon*, a stopple.]

The stopper of a cannon. [See TAM-PION.]—2. An iron bottom to which grape-shot is fixed.

**TÖM-RIG**, † *n.* A tomboy,—which see.

**TÖM-TIT**, *n.* A little bird, the titmouse.

**TÖM-TÖM**, *n.* See TAMTAM.

**TÖN**, the termination of names of places, is *town*, a hill or fortress. [See TOWN.]

**TÖN**, *n.* [Fr.] The prevailing fashion; high mode.

**TÖN**, *n.* (tun.) [Sax. *tunna*; Fr. *tonne*; Sp. *tonel*, a cask, a tun or butt.] A weight equal to 20 hundred-weight (usually written cwt.), or 2240 pounds avoirdupois. [See AVOIRDUPOIS.]—2. A wine measure of capacity equal to 252 gallons, or two pipes; but in this sense the word is usually written Tun, —which see.

**TÖN-AL-TY**, *n.* [It. *tonalità*; Fr. *tonalité*.] In *music*, a modern term introduced to designate the existence of differences among various musical modes, ancient and modern, and among the elements of melodies and harmonies founded upon these modes.

**TÖN-DYNO**, *n.* [It.] In *arch.*, the same as *Astragal*,—which see.

**TÖNE**, *n.* [Fr. *ton*; Sp. *tono*; Sw. and G. *ton*; L. *tonus*; Gr. *τονος*, sound; L. *tono*, Gr. *τονω*, to sound, from the root of *τενω*, to strain or stretch. The L. *sonus* is probably the same word in a different dialect.] 1. Sound, or a modification of sound; any impulse or vibration of the air which is perceptible by the ear; as, a low *tone*, high *tone*, or loud *tone*; a grave *tone*; an acute *tone*; a sweet *tone*; a harsh *tone*.—2. In *music*, a property of sound by which it comes under the relation of grave or acute; or it is the gravity or acuteness which any sound has, arising from the number of vibrations made by the sonorous body producing it, in a given time. Grave tones are produced by slow vibrations in the sonorous body, and acute tones by quick vibrations. Each particular sound in our musical system is called a *tone*.—3. Accent; or rather, a particular inflection of the voice, adapted to express emotion or passion; a *rhetorical sense of the word*. Eager his *tone*, and ardent were his eyes. *Dryden*.

4. A whining sound; a whine; a kind of mournful strain of voice; as, children often read with a *tone*.—5. An affected sound in speaking.—6. In *music*, an interval of sound; as, the difference between the diapente and diatessarion, is a *tone*. Of tones there are two kinds, major and minor. The *tone major* is in the ratio of 8 to 9, which results from the difference between the fourth and fifth. The *tone minor* is as 9 to 10, resulting from the difference between the minor third and the fourth.—7. The *tone* of an instrument, is its peculiar sound with regard to softness, richness, fullness, evenness, and the like.—8. In *med.*, that state of a body, in which the animal functions are healthy and performed with due vigour. *Tone*, in its primary signification, is *tension*, and tension is the primary signification of strength. Hence its application to the natural healthy state of animal organs. *Tone*, therefore, in medicine, is the strength and activity of the organs, from which proceed healthy functions. So we say, the body is in a *sound state*, the health is *sound* or *firm*.—9. In *painting*, the harmonious relation of the colours of a picture in light and shade. The term is often used to qualify, or as synonymous with, *depth*, *richness*, and *splendour*, in pictures. It has also been more recently used to

denote the characteristic expression of a picture as distinguished by its colour.

**TÖNE**, *v. t.* To utter in an affected tone.—2. To tune. [See TUNE.] In *painting*, to *tone down* a picture, is to soften the colouring, so that a subdued harmony of tint may prevail, and all undue glare be avoided.

**TÖNED**, *a.* Having a tone; used in composition; as, high-toned; sweet-toned.

**TÖNELESS**, *a.* Having no tone; unmusical.

**TÖNE-SYLLABLE**, *n.* An accented syllable.

**TÖNG**, † *n.* [See TONGS.] The catch of a buckle. [See TONGUE.]

**TÖNGS**, *n. plur.* [Sax. *tang*; G. *zange*; Ice. *taung*; Gael. *teangas*. This seems by its orthography to be the same word as *tongue, tongues*, and to signify projections, shoots.] An instrument of metal, consisting of two parts or long shafts joined at one end, used for handling things, particularly fire or heated metals. We say, a pair of *tongs*, a smith's *tongs*.

**TÖNGUE**, *n.* [Sax. *tung, tunga*; Goth. *tung*; Sw. *tunga*; Dan. *tunge*; D. *tong*; G. *zunge*; Ir. and Gael. *teanga*; Ant. L. *tingua*. We see by the Gothic, that *n* is not radical. It signifies a shoot or extension, like L. *digitus* and *dug*.] 1. In man, one of the instruments of taste, and also one of the instruments of speech; and in other animals one of the instruments of taste. It is also an instrument of deglutition. In some animals, the tongue is used for drawing the food into the mouth, as in animals of the bovine genus, &c. Other animals lap their drink, as dogs. The tongue is covered with membranes, and the outer one is full of papillæ of a pyramidal figure, under which lies a thin, soft, reticular coat, perforated with innumerable holes, and always lined with a thick and white or yellowish mucus.—2. Speech; discourse; sometimes, fluency of speech.

Much *tongue* and much judgment seldom go together. *L'Etrange*.

3. The power of articulate utterance; speech.

Parrots imitating human *tongue*. *Dryden*.

4. Speech, as well or ill used; mode of speaking.

Keep a good *tongue* in thy head. *Shak*.

The *tongue* of the wise is health; Prov. xii.

5. A language; the whole sum of words used by a particular nation. The English *tongue*, within two hundred years, will probably be spoken by two or three hundred millions of people in North America.—6. Speech; words or declarations only; opposed to *thoughts* or *actions*.

Let us not love in word, neither in *tongue*, but in deed and in truth; 1 John iii.

7. A nation, as distinguished by their language.

I will gather all nations and *tongues*; Is. lxvi.

8. A point; a projection; as, the *tongue* of a buckle or of a balance.—9. In *arch.*, a projection in the side of a board which fits into a groove. *Egg and tongue*. [See EGG and ANCHOR.]

—10. A point or long narrow strip of land, projecting from the main into a sea or a lake.—11. The taper part of any thing; in the rigging of a ship, a short piece of rope spliced into the upper part of standing backstays, &c.,

to the size of the mast-head.—*To hold the tongue*, to be silent.

**TONGUE**, *v. t.* To chide; to scold.

How might she *tongue* me. *Shak.*

**TONGUE**, *v. i.* To talk; to prate.

**TONGUED**, *a.* Having a tongue.

*Tongued* like the night-crow. *Donne.*

**TONGUE-DOUGHTY**, † *a.* Valiant in word; boastful.

**TONGUE-GRÄFTING**, *n.* A mode of grafting by inserting the end of a scion in a particular manner.

**TONGUELESS**, *a.* Having no tongue.

—2. Speechless; as, a *tongueless* block.

—3. Unnamed; not spoken of.

One good deed dying *tongueless* † *Shak.*

**TONGUE-PAD**, † *n.* A great talker.

**TONGUE-SHAPED**, *a.* In *bot.*, a *tongue-shaped leaf* is linear and fleshy, blunt at the end, convex underneath, and having usually a cartilaginous border, as in *mesembryanthemum linguiforme*.

**TONGUE-TIE**, *v. t.* [*tongue* and *tie*.]

To deprive of speech or the power of speech, or of distinct articulation.

**TONGUE-TIED**, *a.* Destitute of the power of distinct articulation; having an impediment in the speech.—2. Unable to speak freely, from whatever cause.

Love and *tongue-tied* simplicity. *Shak.*

**TONIC**, *a.* [from *Gr. τόνος*, *L. tonus*.

See **TONE**.] 1. Literally, increasing tension; hence, increasing strength, as *tonic* power.—2. In *med.*, increasing strength, or the tone of the animal system; obviating the effects of debility, and restoring healthy functions.

—3. Relating to tones or sounds.—4. † Extended.—*Tonic spasm*, in *med.*,

is a steady and continuous spastic contraction enduring for a comparatively long time. It is opposed to a *chronic spasm*, in which the muscular fibres contract and relax alternately in very quick succession, producing the appearance of agitation. In *tonic spasms*, however, there is always alternate contraction and relaxation. The *spasms* of tetanus are *tonic*.

**TONIC**, *n.* A medicine that increases the strength and gives vigour of action to the system. Such are vegetable bitters, stimulants, astringents, &c.—

2. In *music*, the key-note or principal sound upon which all regular melodies depend. Its octaves, both above and below, are called by the same name.

[*Fr. tonique*.]—3. In *music*, a certain degree of tension, or the sound produced by a vocal string in a given degree of tension.

**TONICITY**, *n.* The elasticity of living parts.

**TO-NIGHT**, *n.* [*to* and *night*.] The present night, or the night after the present day.

**TONKIN**. See **TONQUIN**.

**TONNAGE**, *n.* [from *ton*.] The weight of goods carried in a boat or ship.—

2. The cubical content or burthen of a ship in tons; or the amount of weight which she may carry. Properly speaking, the tonnage of a ship is an expression for the interior capacity by the number of tons of sea water which it could contain; hence, if the interior capacity were found in cubic feet, and this divided by 35 (the number of cubic feet of sea-water which are equal in weight to one ton), the quotient would be the tonnage. The tonnage, however, is frequently understood to express the capacity, by the

number of tons of sea-water which might be contained between a horizontal plane passing through the ship when she floats in still water, with only her equipments and stores on board, and a horizontal plane passing through the ship when laden; that is, between what are called the *light-water* and *load-water* planes; the contents of that part of the ship expressed in cubic feet being divided by 35, as in the former case. The result evidently gives the weight of the ship's cargo merely. As, however, the determination of the tonnage of ships, according to either of the above cases, is very laborious and difficult in practice, several empirical rules have been laid down, by which an approximate value of the tonnage may be more easily found. Tonnage is the only term used to give an idea of the size of merchant ships, which are invariably spoken of according to their tonnage, or as being ships of 100, 500, or 1000 tons. Not only are all dues and customs levied according to the tonnage, but ships are also built, and bought and sold for a certain price per ton of their admeasurement. Sometimes the tonnage of goods and stores is taken by weight and not by measurement.—3. A duty or impost on ships, formerly estimated at 80 much per ton of freight, but now proportioned to the registered size of the vessels.—*Tonnage and Poundage*. [See **POUNDAGE**.]

**TONQUIN BEAN**, † *n.* The fruit of

**TONKA BEAN**, } the *Dipterix odorata* or *Coumarouna odorata*, a



*Dipterix odorata*, yielding Tonquin beans.

shrubby plant of Guiana. The fruit is an oblong dry fibrous drupe, containing a single seed. The odour of the kernel is extremely agreeable. It is used in perfumery. [See **COUMARINE**, **COUMAROUNA ODORATA**.]

**TONSIL**, *n.* [*L. tonsilla*.] This word seems to be formed from *tonsus*, *tondeo*, to clip.] In *anat.*, the *tonsils* are two oblong suboval glands on each side of the throat or fauces. The *tonsils* are called also from their shape, *amygdalæ*, and in popular language, *almonds*.

Their use is to secrete a mucous humour for lubricating the passages; and they have several excretory ducts opening into the mouth.

**TONSILE**, *a.* That may be clipped.

**TONSILLITIS**, *n.* Inflammation of the tonsils; quinsy; malignant sore throat.

**TONSOR**, *n.* [*L.*] A barber; one that shaves. [*Not English*.]

**TONSORIAL**, *a.* Pertaining to a barber, or to shaving. [*Rarely used*.]

**TONSURE**, *n.* [*Fr. from L. tonsura*, from *tonsus*, shaved; *tondeo*, to clip or shave.] 1. The act of clipping the hair, or of shaving the head; or the state of being shorn.—2. In the *Romish church*, tonsure is the first ceremony used for devoting a person to the service of God and the church; the first degree of the clericate, given by a bishop, who with scissors cuts off a part of the candidate's hair, with prayers and benedictions. Hence, *tonsure* is used to denote entrance or admission into holy orders.—3. In the *Romish church*, the corona or crown, a distinguishing mark of the clergy, formed by clipping away the hair from a circular space on the back of the head. This crown is preserved by repeated trimming; and the practice is to enlarge it as the wearer rises in ecclesiastical station and dignity.

**TONTINE**, *n.* [*Fr. tontine*; said to be from its inventor, *Tonti*, an Italian.] An annuity or survivorship; or a loan raised on life annuities, with the benefit of survivorship. Thus, an annuity is shared among a number, on the principle that the share of each, at his death, is enjoyed by the survivors, until at last the whole goes to the last survivor, or to the last two or three, according to the terms on which the money is advanced.

**TONY**, *n.* A simpleton. [*Ludicrous*.]

**TOO**, *adv.* [*Sax. to*.] 1. Over; more than enough; noting excess; as, a thing is *too* long, *too* short, or *too* wide; *too* high; *too* many; *too* much.

His will *too* strong to bend; *too* proud to learn. *Cowley*.

2. Likewise; also; in addition.

A courtier and a patriot *too*. *Pope*.

Let those eyes that view

The daring crime, behold the vengeance *too*. *Pope*.

3. *Too, too*, repeated, denotes excess emphatically; but this repetition is not in respectable use. [The original application of *to*, now *too*, seems to have been a word signifying a great quantity; as, speaking or giving *too* much—that is, *to* a great amount. *To* was thus used by old authors.]

**TOOK**, *pret. of Take*.

Enoch was not, for God *took* him; *Gen. v.*

**TOOL**, *n.* [*Sax. tol*. *Qu. Fr. outil*. In old Law Latin, we find *attile*, *attilia*, stores, tools, implements. *Qu. artillery*, by corruption.] 1. An instrument of manual operation, particularly such as are used by farmers and mechanics; as, the *tools* of a joiner, cabinet-maker, smith, or shoemaker.—2. A person used as an instrument by another person; a *word of reproach*. Men of intrigue always have their *tools*, by whose agency they accomplish their purposes.

**TOOL**, *v. t.* To shape with a tool.

**TOOLING**, *n.* In *masonry*, dressing a stone with a broad pointed chisel, in such a manner that its surface presents the appearance of being regularly furrowed all over with a series of minute flutes or channels.—2. Workmanship performed with a tool.

**TOOL/YE**, } *n.* A broil; a quarrel.

**TOOL/ZIE**, } As a verb, to quarrel. [*Scotch*.]

**TOOM**, *v. t.* [*Dan. tommer*.] To empty; to evacuate. [*Scotch*.]

**TOOM**, *a.* Empty. [*Scotch*.]

**TOON' WOOD**, *n.* The wood of an East Indian tree, the *Cedrela toona* of



Toon wood (*Cedrela toona*).

botanists. It is sometimes called Indian mahogany, and also Indian cedar, and is supposed to be the same as that which yields the so-called cedar wood of New South Wales. Toon wood is extensively employed in India for making furniture and cabinet-work.

**TOOT**, *v. i.* [*Sax. totian*, to shoot, to project; *D. toeten*, to blow the horn; *toet-horn*, a bugle-horn; *G. diten*; *Sw. tiuta*. This word corresponds in elements with *Gr. tibynus* and *W. dodii*, to put, set, lay, give; *L. do, dedi*. The Saxon expresses the primary sense.] 1. † To stand out or be prominent.—2. To make a particular noise with the tongue articulating with the root of the upper teeth, at the beginning and end of the sound; also, to sound a horn in a particular manner.

This writer should wear a *tooting horn*.

*Howell.*

3. † To advertise; to make known; to announce, by the sound of the horn.—4. † To peep; to look narrowly; to search; to seek; to look into; to look out. In Scotch, *teet* or *tete* has the same signification.

**TOOT**, *v. t.* To sound; as, to *toot* the horn.—2. † To look into, to see.

Then turned I agen when I had all *ytoted*.

*Pierce Ph.*

**TOOT**, *n.* A blast; a note or sound blown on a horn; a noise.

**TOOTER**, *n.* One who plays upon a pipe or horn.

**TOOTH**, *n.* plur. *Teeth*. [*Sax. toth*, plur. *teth*. It corresponds with *W. did* and *teth*, a *teat*, Gael. *did*, *dead*, and with *toot*, supra; signifying a shoot. If *n* is not radical in the *L. dens*, *Gr. odens*, *odontes*, this is the same word.] 1. A bony substance growing out of the jaws of animals, and serving as the instrument of mastication. The *teeth* are also very useful in assisting persons in the utterance of words, and when well formed and sound, they are ornamental. Teeth generally consist of three distinct substances, ivory, enamel, and bone. Each tooth is divided into a crown, a neck, and a fang or fangs. The teeth of animals differ in shape, being destined for different offices. The front teeth in men and quadrupeds are called *incisors*, or *incisive*, or *cutting teeth*; next to these are the pointed teeth, called *lanary*, *canine* or *dog teeth*; and on the sides of the jaws are the *molar teeth* or *grinders*.

In the human subject the number of teeth seldom exceeds thirty-two, and is rarely found to be less than twenty-eight.—2. Taste; palate.

These are not dishes for thy dainty tooth.

*Dryden.*

3. A tine; a prong; something pointed and resembling an animal tooth; as, the *tooth* of a rake, a comb, a card, a harrow, a saw, or of a wheel. The teeth of a wheel are sometimes called *cogs*, and are destined to catch corresponding parts of other wheels. [*See TETH.*]—*Tooth and nail*, [by biting and scratching,] with one's utmost power; by all possible means.—*To the teeth*, in open opposition; directly to one's face.

That I shall live and tell him to *his teeth*.

*Shak.*

*To cast in the teeth*, to retort reproachfully; to insult to the face.—*In spite of the teeth*, in defiance of opposition; in opposition to every effort.—*To show the teeth*, to threaten.

When the law *shows her teeth*, but dares not bite.

*Young.*

**TOOTH**, *v. t.* To furnish with teeth; as, to *tooth* a rake.—2. To indent; to cut into teeth; to jag; as, to *tooth* a saw.—3. To lock into each other.

**TOOTHACHE**, *n.* [*tooth* and *ache*.] Pain in the teeth, technically called *odontalgia*.

**TOOTHACHE-TREE**, *n.* The common name of the species of plants which form the genus *Xanthoxylum*, but particularly applied to the *X. fraxineum*, an inhabitant of North America. The bark and capsular fruit of this tree are much used as a remedy for the toothache. [*See XANTHOXYLUM.*]

**TOOTH-BRUSH**, *n.* A small brush for cleaning the teeth.

**TOOTH-DRAWER**, *n.* [*tooth* and *draw*.] One whose business is to extract teeth with instruments.

**TOOTH-DRAWING**, *n.* The act of extracting a tooth; the practice of extracting teeth.

**TOOTH'ED**, *pp.* or *a.* Having teeth or jags. In *bot.*, dentate; having projecting points, remote from each other, about the edge or margin; as, a *toothed calyx*, or leaf.

**TOOTH'EDGE**, *n.* [*tooth* and *edge*.] The sensation excited by grating sounds, and by the touch of certain substances. Tingling uneasiness, almost amounting to pain, in the teeth, from stridulous sounds, vellication, or acid or acrid substances.

**TOOTHFUL**, † *a.* Palatable.

**TOOTH'FUL**, *n.* A small draught of any liquor. [*Vulgar.*]

**TOOTHING**, *n.* In *arch.*, bricks or stones left projecting at the end of a wall, that they may be bonded into a continuation of it when required; also, a tongue or series of tongues.

**TOOTHING PLANE**, *n.* A plane the iron of which, in place of being sharpened to a cutting edge, is formed into a series of small teeth. It is used to roughen a surface intended to be covered with veneer or cloth, in order to give a better hold to the glue.

**TOOTH'LESS**, *a.* Having no teeth.

**TOOTH'LETED**, *a.* In *bot.*, denticulate; having very small teeth or projecting points; as a leaf.

**TOOTH ORNAMENT**, *n.* In *arch.*, one of the peculiar marks of the early English style. It consists of a pyramid, having its sides partially cut out, so as to have the resemblance of an

inverted flower. It is generally inserted in a hollow moulding.

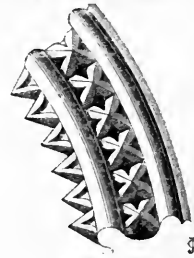

Tooth ornament.

**TOOTH'PICK**, } *n.* [*tooth* and *pick*.]  
**TOOTH'PICKER**, } An instrument for cleaning the teeth of substances lodged between them.

**TOOTH-SHELL**, } *n.* In *conch.*, a  
**TOOTH'ED-SHELL**, } dentate shell.  
**TOOTH'SOME**, *a.* Palatable; grateful to the taste.

**TOOTH'SOMENESS**, *n.* Pleasantness to the taste.

**TOOTH'WORT**, *n.* A plant whose roots resemble human teeth, such as the *Lathraea squamaria*, various species of *Dentaria*, the *Corallorrhiza innata*, &c. This name is also given to the leadwort, of the genus *Plumbago*, from its toothed corolla. [*See LATHRÆA.*]

**TOOTHY**, *a.* Toothed; having teeth.

**TOOTING**, *pp.* Sounding in a particular manner, as a horn.

**TOP**, *n.* [*Sax top*; *Sw. topp*; *W. tob* or *top*; *topiau*, to top, to form a crest.]

1. The highest part of any thing; the upper end, edge, or extremity; as, the *top* of a tree; the *top* of a spire; the *top* of a house; the *top* of a mountain.—2. Surface; upper side; as, the *top* of the ground.—3. The highest place; as, the *top* of preferment.—4. The highest person; the chief.—5. The utmost degree.—6. The highest rank. Each boy strives to be at the *top* of his class, or at the *top* of the school.—7. The crown or upper surface of the head.—8. The hair on the crown of the head; the forelock.—9. The head of a plant.—10. [*G. topf*.] An inverted conoid which children play with by whirling it on its point, continuing the motion with a whip; also called a *spinning top*.—11.

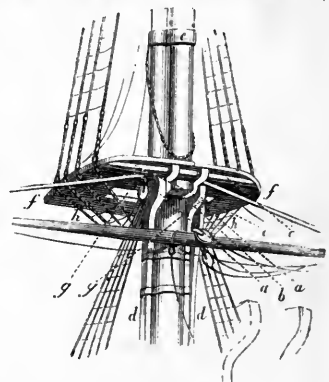

Top in Ships.

*a, a*, Tressel trees. *e, Cap.*  
*b*, Heel of top mast. *f, f*, Top.  
*c, c*, Fid. *g, g*, Coward holes.  
*d, d*, Checks. *h, h*, Futtock shrouds.

In *ship-building*, a sort of platform, surrounding the head of the lower

mast and projecting on all sides. It serves to extend the shrouds, by which means they more effectually support the mast; and in ships of war, the top furnishes a convenient stand for swivels and small arms to annoy the enemy.

**TOP, a.** Being on the top or summit; highest.

**TOP, v. i.** To rise aloft; to be eminent; as, lofty ridges and *topping* mountains.—2. To predominate; as, *topping* passions; *topping* uneasiness.—3. To excel; to rise above others.

But write thy best and *top*. *Dryden.*  
**TOP, v. t.** To cover on the top; to tip; to cap.

A mount

Of alabaster, *topp'd* with golden spires.

*Milton.*

Mountains *topp'd* with snow. *Waller.*

2. To rise above.

A gourd climbing by the boughs twined about them, till it *topp'd* and covered the tree. *L'Estrange.*

*Topping* all others in boasting. *Shak.*

3. To outgo; to surpass.—4. To crop; to take off the top or upper part.

*Top* your rose-trees a little with your knife near a leaf-bud. *Encyclop.*

So in America they say, to *top* corn, that is maize, by cutting off the stalk just above the ear.—5. To rise to the top of; as, he *topped* the hill.—6.† To perform eminently.—*To top a yard, in mar. lan.,* is to draw one of the extremities of the yard higher than the other.

**TOP'AN, n.** A name of the horned Indian rhinoceros bird, the *Buceros rhinoceros*, of the Passerine order.

**TOP'ARCH, n.** [Gr. *τοπος*, place, and *αρχος*, a chief.] The principal man in a place or country.

**TOP'ARCHY, n.** A little state, consisting of a few cities or towns; a petty country governed by a toparch. Judea was formerly divided into ten *toparchies*.

**TOP'-ARMOUR, n.** In *ships*, a railing on the top, supported by stanchions and equipped with netting.

**TOP'PAZ, n.** [Gr. *τοπαζιον*.] A mineral, said to be so called from Topazos, a small isle in the Arabic gulf, where the Romans obtained a stone which they called by this name, but which is the chrysolite of the moderns. The lustre of the topaz is vitreous, transparent, translucent; the streak white; the colour yellow, white, green, blue, pale; fracture subconchoidal, uneven. Specific gravity, 3.499. It is harder than quartz. Its ultimate composition is silicium, aluminum, fluorine, oxygen. It occurs massive, in imbedded and rounded crystals. The primary form of its crystal is a right rhombic prism. Fragments of topaz, exposed to heat, emit a blue, green, or yellowish phosphoric light. Topazes occur generally in primitive rocks, and in many parts of the world, as Cornwall, Scotland, Saxony, Siberia, Brazil, &c. &c. The finest varieties are obtained from the mountains of Brazil and the Uralian mountains. Topazes are used in jewelry, for necklaces, ear-drops, bracelets, &c. The Scotch pebble, called cairngorm stone, is a variety of topaz.

**TOPAZ'OLITE, n.** A variety of precious garnet, of a topaz yellow colour, or an olive green, found in Piedmont. Its constituents are silice, lime, iron, with slight traces of alumine, glucine, and manganese.

**TOP'-BEAM, n.** In *arch.*, the same as collar-beam,—*which see*.

**TOP'-BLOCK, n.** In *ships*, a block hung to an eye-bolt in the cap, used in swaying and lowering the top-mast.

**TOP'-BRIM, n.** The space in the middle of the foot of a top-sail.

**TOP'-CHAIN, n.** In *ships*, a chain to sling the lower yards in time of action, to prevent their falling when the ropes by which they are hung are shot away.

**TOP'-CLOTH, n.** In *ships*, a piece of canvas used to cover the hammocks which are lashed to the top in action.

**TOP'-DRAINING, n.** The act or practice of draining the surface of land.

**TOP'-DRESSING, n.** A dressing of manure laid on the surface of land.

**TOPE, n.** A fish of the shark kind, the *Squalus galeus* of Linnæus, resembling the dog-fish in its general aspect.—2. In India, a grove or clump of trees; as, a *toddy-tope*, a cane-tope.

**TOPE, v. t.** [Fr. *tope*. Qu. *dip.*] To drink hard; to drink strong or spirituous liquors to excess.

If you *tope* in form, and treat. *Dryden.*  
**TOP'ER, n.** One who drinks to excess; a drunkard; a sot.

**TOP'ET, n.** A small bird, the crested titmouse.

N. B. The crested titmouse of Latham, *Parus bicolor*, is the toupet titmouse of Pennant.

**TOP'FUL, a.** [top and full.] Full to the top or brim.

**TOP-GALLANT, a.** Highest; elevated; splendid; as, a *top-gallant* spark.—*Top-gallant mast*, in *ships*, the mast which is above the top-mast. The sail upon it is called the *top-gallant sail*.

**TOPH, } n.** [from the Latin.] In **TOPHIUS, } sur.**, a soft tumour on a bone; also, a concretion in the joints.

—2. In *min.*, a calcareous earth, consisting principally of carbonate of lime, precipitated by water, and porous.

**TOPIA'CEOUS, a.** Pertaining to a toph or tophus; consisting of deposits of calcareous matter from water.

**TOP-HEAVY, a.** (top'-hevy.) [top and heavy.] Having the top or upper part too heavy for the lower.

**TOPHET, n.** [Heb. *תופת* *tophet*, a drum.] Hell; so called from a place east of Jerusalem where the Jews were wont to throw the carcasses of beasts, the dead bodies of men to whom they refused burial, and all kinds of filth, and where a fire was perpetually kept up to consume all that was deposited, in order to prevent any offensive smell. In the earlier periods of the Jewish history, this was also the place where children were burnt to Moloch, and where drums were used to drown their cries.

**TOPHUS, n.** In *min.*, a deposit of porous calcareous matter from water.

—2. In *med.*, a soft tumour upon a bone. [See **TOPH**.]

**TOPIARY, a.** [L. *topiarius*, ornamented.] Shaped by clipping or cutting; as, *topiary work*, which consists in giving all kinds of fanciful forms to arbours and thickets, trees, and hedges.

**TOP'IC, n.** [Gr. *τοπος*, place; L. *topicus, topica*; Sans. *topu*.] 1. Any subject of discourse or argument; a general head. The Scriptures furnish an unlimited number of *topics* for the preacher, and *topics* infinitely interesting.—2. In *rhet.*, a probable argument drawn from the several circumstances and places of a fact. Among the helps

employed by the ancients in their favourite study of rhetoric, was the collection and arrangement of a great variety of general truths or notions, according to the several sciences or subjects to which they belonged. These they called *τοποι*, or places, or common places, and considered that they might be advantageously used by public speakers, in the selection and invention of arguments. Aristotle wrote a book of *topics*. Cicero defines *topics* to be the art of finding arguments.—3. Principle of persuasion.

Coatmaicious persons whom no *topics* can work upon. *Witkins.*

4. In *med.*, an external remedy; a remedy to be applied outwardly to a particular part of the body, as a plaster, a poultice, a blister, and the like.

**TOP'IC, } a.** [supra.] Pertaining to **TOP'ICAL, } a.** place; limited; local; as, a *topical* remedy.—2. Pertaining to a topic or subject of discourse, or to a general head.

**TOP'ICALLY, adv.** Locally; with limitation to a part.—2. With application to a particular part; as, a remedy *topically* applied.

**TOP'-KNOT, n.** [top and knot.] A knot worn by females on the top of the head.

**TOP-LANTERN, n.** A large lantern placed in the after part of the top in any ship, where an admiral or commodore is personally on board.

**TOP'LESS, a.** Having no top; as, a *topless* height.

**TOP'MAN, n.** [top and man.] The man who stands above in sawing.—2. In *ships*, a man standing in the top.

**TOP'MAST, n.** In *ships*, the second mast, or that which is next above the lower mast. Above that is the top-gallant-mast, above which again is the top-royal mast.

**TOP'MOST, a.** [top and most.] Highest; uppermost; as, the *topmost* cliff; the *topmost* branch of a tree.

**TOPOG'RAPHER, n.** [See **TOPOGRAPHY**.] One who describes a particular place, town, city, tract of land, or country.

**TOPOGRAPH'IC, } a.** Pertaining to **TOPOGRAPHICAL, } to topography; descriptive of a place, or country.**  
**TOPOGRAPHICALLY, adv.** In the manner of topography.

**TOPOG'RAPHY, n.** [Gr. *τοπος*, place, and *γραφω*, description.] The description of a particular place, city, town, manor, parish, or tract of land; the description of cities, towns, villages, castles, churches, and other artificial structures in a locality, district, or country, including notices of every thing belonging to the places or connected with them. It enters more minutely into details than *geography* does.

**TOP'PED, } pp. or a.** Covered on the **TOPT, } top; capped; surpassed; cropped; having the top cut off.**

**TOP'PING, ppr.** Covering the top; capping; surpassing; cropping, lopping.—2. a. Fine; gallant; rich; wealthy. [Low style.] [But Johnson's definition is probably incorrect.]

**TOP'PING, n.** In *seamen's language*, the act of pulling one extremity of a yard higher than the other.

**TOP'PING-LIFT, n.** A large strong tackle employed to suspend or top the outer end of a gaff, or of the boom of a main-sail, in a brig or schooner.

**TOP'PINGLY, adv.** Splendidly; nobly.—2. Proudly; with airs of disdain. [Not an elegant word, nor much used.]



**TOP'PLE**, *v. i.* [from *top*.] To fall, as from a top or height; to fall forward; to pitch or tumble down.

Though castles *topple* on their warders' heads. *Shak.*

**TOP'PLING**, *ppr.* Falling forward.

**TOP'-RAIL**, *n.* In *arch.*, the uppermost rail of a piece of framing or wainscotting.

**TOP'-ROPE**, *n.* A rope to sway up a top-mast, &c.

**TOP'-SAIL**, *n.* In *ships*, a sail extended across the top-mast, above which is the top-gallant-sail.

**TOP'-SHAPED**, *n.* In *bot.*, turbinate, *i. e.* inversely conical, with a contraction toward the point; as a *top-shaped* root.

**TOPS'MAN**, *n.* Chief or head cattle-drover. [*Triatal*.]

**TOP'-SOILING**, *n.* The act or art of taking off the top-soil of land, before a canal is begun.

**TOP'-STONE**, *n.* A stone that is placed on the top, or which forms the top.

**TOPSY-TURVY**, *adv.* In an inverted posture; with the top or head downward; as, to turn a carriage *topsy-turvy*.

**TOP'-TACKLE**, *n.* In *ships*, a large tackle hooked to the lower end of the top-mast top-rope and to the deck.

**TOQUE**, (tôk.) } *n.* [Fr. *a. cap.*] A kind of bonnet or head dress for women.

**TOR**, *n.* [Sax. *tor*; *L. turris*.] A tower; a turret; also, a high pointed rock or hill; *used in naves*.

**TORCH**, *n.* [It. *torcia*; Sp. *antorcha*; Fr. *torche*; D. *toorts*; probably a twist; It. *torciare*, to twist, Sp. *torcer*, W. *torci*, *L. torqueo*, *tortus*.] A light or luminary formed of some combustible substance, as of resinous wood, or of twisted flax, hemp, &c., soaked with tallow or other inflammable substance; a large candle; a flambeau.

They light the nuptial torch. *Milton.*

**TORCH**, *v. t.* In *plastering*, to point the inside joints of slating laid on lath with lime and hair.

**TORCH'-BEARER**, *n.* [*torch* and *bear*.] One whose office is to carry a torch.

**TORCH'-DANCE**, *n.* In *ancient times*, a dance connected with the tournaments with which emperors and kings celebrated their marriages. It was performed by torch-light. This species of dance is still used at the marriages of royal personages. It is then performed with great splendour at the conclusion of the wedding, when the royal pair are conducted to their apartment. Torch-dances were used at marriage feasts among the Greeks and Romans.

**TORCH'ER**, *† n.* One that gives light.

**TORCH'-LIGHT**, *n.* [*torch* and *light*.] The light of a torch or of torches.—2. A light kindled to supply the want of the sun.

**TORCH'-RACE**, *n.* A kind of race used among the ancient Greeks at certain festivals. The runners were three youths with lighted torches, and he who reached the goal with his torch still burning was the victor.

**TORCH'-THISTLE**, *n.* A plant of the genus *Cereus*. The common name of a genus of the order *Cactaceæ*, called *cereus*, from *cera*, wax, from the resemblance of the stems to a wax candle. *Torch-thistle* is from the prickly stems, used by the Indians for torches.

**TORCH'-WORT**, *n.* A plant.

**TORCULAR**, *n.* [L. from *torqueo*, to

twist.] A surgical instrument, the tourniquet.—*which see*.

**TORDY'LIUM**, *n.* A genus of plants, nat. order Umbelliferae. The species are herbs with pinnate leaves, and ovate leaflets deeply toothed. The seeds of *T. officinale*, or official hartwort, are said to be diuretic. [See *HART-WORT*.]

**TORE**, *pret. of Tear*. He *tore* his robe.

**TORE**, *n.* [perhaps from *tear*; W. *tori*, to break.] The dead grass that remains on mowing land in winter and spring. [*Local*.]

**TORE**, *n.* [L. *torus*.] In *arch.*, a large round moulding on the base of a column. [See *TORTUS*.]

**TOREUMATOGRAPHY**, *n.* [Gr. *torosus*, sculpture, and *grapho*, description.] A description of ancient sculptures and basso-reliefs.

**TOREUMATOLOGY**, *n.* [Gr. *torosus*, sculpture, and *logos*, discourse.] The science or art of sculpture, or a treatise on sculpture.

**TOREUTIC**, *a.* [Gr. *torosus*, polished.] In *sculp.*, highly finished, executed with delicacy and high polish. A term applied to all figures in hard wood, ivory, stone, marble, &c.

**TORI'NIS**, *n.* A genus of plants, the species of which are known by the name of hedge-parsley.—*which see*.

**TORMENT**, *n.* [Fr. *tourment*; *L. tormentum*; It. and Sp. *tormento*; probably from the root of *L. torqueo*, *torno*, Eng. *tour*; that is, from twisting, straining.] 1. Extreme pain; anguish; the utmost degree of misery, either of body or mind; penal anguish; torture. The more I see

Pleasure about me, so much I feel

*Torment* within me. *Milton.*

Let thy also come into this place of *torment*; Luke xvi; Rev. ix. xiv.

2. That which gives pain, vexation, or misery.

They brought to him all sick people that were taken with divers diseases and *torments*; Matth. iv.

3. An ancient engine of war for casting stones.

**TORMENT'**, *v. t.* To put to extreme pain or anguish; to inflict excruciating pain and misery, either of body or mind.

Art thou come hither to *torment* us before the time? Matth. viii.

He shall be *tormented* with fire and brimstone; Rev. xiv.

2. To pain; to distress.

Lord, my servant lieth at home sick of the palsy, grievously *tormented*; Matth. viii.

3. To tease; to vex; to harass; as, to be *tormented* with importunities, or with petty annoyances.—4. To put into great agitation.

They soaring on main wing

*Tormented* all the air. [*Unusual*.] *Milton.*

**TORMENTED**, *pp.* Pained to extremity; teased; harassed.

**TORMENTER**, *n.* Her or that which *torments*. [See *TORMENTOR*.]

**TORMENTIL**, } *n.* [Fr. *tormentille*;  
**TORMENTIL'LA**, } It *tormentilla*.]

A genus of plants, nat. order Rosaceae. The species are herbaceous plants, with dissected and axillary and terminal flowers. *T. erecta* or *officinalis*, upright tormentil or septfoil, and *T. reptans*, creeping tormentil, are natives of Britain and Europe generally; and *T. humifusa*, trailing tormentil, is a native of North America. *T. officinalis*, is the most powerful of our indigenous astringents. Its root is used in Lapland and the Orkney Islands, both to

tan and to dye leather, and also to dye worsted yarn. It is also employed in



Upright Tormentil (*Tormentilla erecta*).

medicine as a gargle in enlarged tonsils and other diseases of the throat, and for alleviating gripes or *tormina* in cases of diarrhoea, whence its name. This plant is likewise valuable as an agricultural plant; for where it grows abundantly in wet pastures, the rot in sheep is unknown.

**TORMENTING**, *ppr.* Paining to an extreme degree; inflicting severe distress and anguish; teasing; vexing.

**TORMENTING**, *n.* In *agriculture*, an imperfect sort of horse-hoeing.

**TORMENTINGLY**, *adv.* In a manner tending to produce distress or anguish.

**TORMENT'OR**, } *n.* He or that which

**TORMENT'ER**, } *torments*; one who inflicts penal anguish or tortures.—2. In *agriculture*, an instrument for reducing a stiff soil. It is somewhat like a harrow, but runs on wheels, and each time is furnished with a hoe or share that enters and cuts up the ground.

**TORMINA**, *n. plur.* [L. *tormen*.] Severe gripping pains in the bowels.

**TORN**, *pp. of Tear*.

Neither shall ye eat any flesh that is *torn* by the beasts in the field; Exod. xxii.

**TORNA'DO**, *n.* [from the root of *turn*; that is, a whirling wind. The Sp. and Port. *tornado* is a return.] A violent gust of wind, or a tempest, more especially applied to those whirlwind hurricanes prevalent in the West Indies, on the western coast of Africa, about the time of the equinoxes, and in the Indian ocean, about the changes of the monsoons. It is however frequently applied to any tempest or hurricane, and in this sense may be looked upon as signifying, in reference to the localities above named, what typhoon or tyfoong means in the seas of China and the eastern Archipelago. Tornadoes are usually accompanied with severe thunder, lightning, and torrents of rain; but they are of short duration, and narrow in breadth.

**TOROSE**, } *a.* [L. *torosus*.] In *bot.*

**TOROUS**, } protuberant; swelling in knobs, like the veins and muscles; as, a *torous* pericarp. It is also used in zoology to express a surface which swells into protuberances or knobs.

**TORPEDO**, *n.* [L. from *torpeo*, to be numb.] 1. The cramp fish or electric ray. A genus of fishes of the Ray family (Raïidae), distinguished by their having the tail short and moderately thick, and the disk of the body nearly circular, the anterior margin being formed by two produced portions from the head, which, inclining sideways, join

the pectorals. There are several species, which are commonly confounded with each other. These fishes are usually taken in forty fathoms water, on the coasts of France and England, and in the Mediterranean. A touch of them occasions a numbness in the limb, accompanied with an indescribable and painful sensation, and is really an electric shock. The electrical apparatus in the Torpedo, consists of small membranous tubes, which occupy the space



Spotted Torpedo (T. narke).

between the head, the pectoral fins, and the branchiae. They are disposed like a honey comb, and divided by horizontal partitions into small cells, which are filled with a mucous substance, the whole being in many respects analogous to the galvanic pile. The shocks given by the Torpedo are very severe, and are supposed to be used by the animal, both as a means of defence and of disabling its prey. When dead, they lose the power of producing this sensation.—2. A machine invented by Robert Fulton, an American, for destroying ships, by blowing them up. The principal part of the apparatus consisted of a copper box or case, enclosing a certain quantity of gunpowder and combustible matter. These cases were to be applied under the keels of the vessels to be destroyed by means of a kind of submarine boat. The inventor, who was encouraged in his scheme by Bonaparte, attempted, by means of his *infernal machine*, to blow up a British man-of-war in 1801, but providentially failed, owing to the vessel suddenly changing her position.

**TORPENT**, *a.* [*L. torpens, torpeo.*] Numbened; torpid; having no motion or activity; incapable of motion.

A comprehensive expedient to assist the frail and *torpent* memory through so multitanous an employment. *Evelyn.*

**TORPENT**, *n.* In *med.*, that which diminishes the exertion of the irritative motions.

**TORPESCENCE**, *n.* A state of insensibility; torpidness; numbness; stupidity.

**TORPESCENS**, *a.* [*L. torpescens.*] Becoming torpid or numb, or incapable of motion.

Their *torpescens* soul clenches their coin.

**TORPID**, *a.* [*L. torpidus, torpeo;* perhaps *W. torp, a lump.*] 1. Having lost motion or the power of exertion and feeling; numh; as, a *torpid* limb.

Without heat all things would be *torpid*.

2. Dull; stupid; sluggish; inactive. The mind as well as the body becomes *torpid* by indolence. Impenitent sinners remain in a state of *torpid* security.

**TORPIDITY**, *n.* Torpidness.

**TORPIDNESS**, } *n.* The state of being

**TORPIDITUDE**, } torpid; numbness.

Torpidness may amount to total insensibility or loss of sensation.—2. Dullness; inactivity; sluggishness; stupidity.

**TORPIFIED**, *pp.* Rendered torpid.

**TORPIFY**, *v. t.* To make torpid.  
**TORPIFYING**, *ppr.* Rendering torpid.  
**TORPOR**, *n.* [*L.*] Numbness; inactivity; loss of motion, or of the power of motion. Torpor may amount to a total loss of sensation, or complete insensibility. It may however be applied to the state of a living body which has not lost all power of feeling and motion.—2. Dulness; laziness; sluggishness; stupidity.

**TORPORIFIC**, *a.* [*L. torpor* and *facio.*] Tending to produce torpor.

**TORQUED**, *pp.* [*L. torqueo, to wreath, to twist.*] In *her.*, wreathed, said of a dolphin hairient, which forms a figure nearly resembling the letter S. The term *torgant* or *targant*, is used to signify the same thing.



Torqued.

**TORQUES**, *n.* [*L. Brit. torch or dorch.*] In *archæology*, a personal ornament of the Celtic period. It was used by the ancient Britons, and consisted of a chain or



Torques, with manner of wearing it, from the sculptures on the monument of Vigoa Amendola.

collar, formed of a number of small metal ringlets, interlaced with each other, and worn round the neck as a symbol of rank and command.

**TORREFACTION**, *n.* [*Fr. from L. torrefacio; torridus* and *facio.*] 1. The operation of drying by a fire.—2. In *metallurgy*, the operation of roasting ores.—3. In *phar.*, the drying or roasting of drugs on a metalline plate, placed over or before coals of fire, till they become friable to the fingers, or till some other desired effect is produced.

**TORREFIED**, *pp.* Dried; roasted; scorched. *Torrefied earth*, in agriculture, is that which has undergone the action of fire.

**TORREFY**, *v. t.* [*L. torrefacio; L. torridus, torreo, and facio; Fr. torrefier.*] 1. To dry by a fire.—2. In *metallurgy*, to roast or scorch, as metallic ores.—3. In *phar.*, to dry or parch, as drugs, on a metalline plate till they are friable, or are reduced to any state desired.

**TORREFYING**, *ppr.* Drying by a fire; roasting; parching.

**TORRENT**, *n.* [*L. torrens.* This is the participle of *torreo, to parch.* But the sense of the word *torrent*, allies it to the *W. tori, to break*, and the *Eng. tear.* They are all of one family, denoting violent action.] 1. A violent rushing stream of water falling suddenly from mountains, where there have been great rains, or an extraordinary melting of snow; a violent

rushing stream of any other fluid; a stream suddenly raised and running rapidly, as down a precipice; as, a *torrent* of lava.—2. A violent or rapid stream; a strong current; as, a *torrent* of vices and follies; a *torrent* of corruption.

Erasmus, that great injur'd name,  
Stemm'd the wild *torrent* of a barb'rous age. *Pope.*

**TORRENT**, *a.* Rolling or rushing in a rapid stream; as, waves of *torrent* fire.

**TORRICELLIAN**, *a.* Pertaining to Torricelli, an Italian philosopher and mathematician, who, in 1643, discovered the true principle on which the barometer is constructed, by means of an experiment called from him the *Torricellian experiment*. This experiment consisted in filling with mercury a glass tube closed at one end, and then inverting it, and bringing the open end under the surface of mercury in a vessel; when the column of mercury in the tube was observed to descend, till it stood at a height equal to about 29½ inches above the level of the mercury in the vessel, leaving what is considered to be a perfect vacuum at the top, between the upper extremity of the column and that of the tube. This experiment led to the discovery that the column of mercury in the tube is supported by the pressure of the atmosphere, acting on the surface of the mercury in the vessel, and that this column is an exact counterbalance to the atmospheric pressure. [*See BAROMETER.*—*Torricellian tube* is a glass tube thirty or more inches in length, open at one end, and hermetically sealed at the other, such as is used in the barometer.—*Torricellian vacuum*, a vacuum produced by filling a barometer tube with mercury, as in the *Torricellian experiment*; the vacuum above the mercurial column in the barometer.

**TORRID**, *a.* [*L. torridus, from torreo, to roast.*] 1. Parched; dried with heat; as, a *torrid* plain or desert.—2. Violently hot; burning or parching; as, a *torrid* heat.—*Torrid zone*, in *geography*, that space or broad belt of the earth included between the tropics, over which the sun is vertical at some period twice every year, and where the heat is always great.

**TORRIDNESS**, *n.* The state of being very hot or parched.

**TORSE**, *n.* [*Fr. torse; L. tortus.*] In *her.*, a wreath.

**TORSEL**, *n.* [*supra.*] Any thing in a twisted form.—2. In *arch.*, torsels are the pieces of timber lying under the mantle-tree. They are otherwise called *tassels*.

**TORSION**, *n.* [*L. torsio, from torqueo, to twist.*] The act of turning or twisting.—2. In *mech.*, the twisting or wrenching of a body by the exertion of a lateral force. The resistance which cylinders and prisms formed of different substances oppose to torsion, furnishes one of the usual methods of determining the strength of materials. Such machines as capstans and windlasses, also axles which revolve with their wheels, are, when in action, subject to be twisted, or undergo the strain of torsion. If a slender rod of metal be suspended vertically, so as to be fixed at the point of suspension, and then twisted through a certain angle, it will, when the twisting force

ceases to act, untwist itself, or return in the opposite direction with a greater or less force or velocity until it come to rest in its original position. The limits of torsion within which the body will return to its original state, depend upon its elasticity; and the force with which it tends to recover its natural state is called *elasticity of torsion*. This force is always proportional to the angle through which the body has been twisted. If a body is twisted so as to exceed the limit of its elasticity, its particles will either be wrenched asunder, or it will take a *set*, and will not return to its original position on the withdrawal of the twisting force. The word *torsion* is also used to signify that force with which a thread or slender wire returns to a state of rest when it has been twisted by being turned round on its axis; the thread or wire, which is suspended vertically, being attached at the upper extremity to some fixed object, and having at its lower extremity a weight with a horizontal index, or a stirrup, which is to carry a needle or bar in a horizontal position.—*Torsion balance*, or *Balance of torsion*. If a piece of very fine wire, silk, or spun glass, be suspended in the manner above stated, and then twisted, it will, when released, begin to untwist itself, and by the momentum acquired in the act of untwisting, will twist in the opposite direction to a greater or less extent, according to the amount of twisting to which it had been subjected. It will then begin to return; and thus by a series of oscillations continually diminishing in extent, it will at length gradually settle in its original position. Now, if a needle or an index be attached to the lower extremity of the suspended wire or thread, and a graduated circle placed immediately beneath the index in a horizontal position, so that the centre of the circle may be directly below the point of suspension of the index, the apparatus thus constructed will form the *torsion balance*. This balance has been employed to measure certain forces too minute to be estimated by the ordinary methods, and by means of it Coulomb was enabled to determine, by direct experiment, the laws which govern the variation of magnetic and electric forces. By means of the same instrument, Cavendish afterward detected and measured the attraction of gravitation existing between balls of lead. To measure small forces, such as those of electricity, magnetism, &c., with the torsion balance, they are made to act upon one extremity of the index, and thus cause it to turn round, and when the force is in equilibrium with the tendency of the suspended wire to untwist, the angle which the index makes with its original position, which is called the *angle of torsion*, and which is measured by the graduated circle, is the measure of the force employed. In making experiments with the torsion balance, the length of the suspended wire, its diameter, and the weights attached to its lower extremity, must be taken into account. When the balance is adapted to measure electric forces, it is called the *torsion electrometer*; when it is adapted to measure galvanic forces, it is called the *torsion galvanometer*; and, when applied to measure magnetic forces, it

receives the name of the *torsion magnetometer*.

**TORSK**, } n. A northern species of  
**TUSK**, } malacopterygious fish of the  
cod tribe, *Brosmius vulgaris*. It is

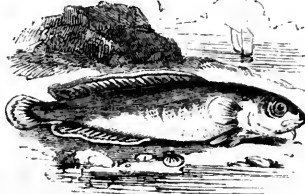

Zorsk (*Brosmius vulgaris*).

found in great quantities among the Orkney and Shetland islands, where it constitutes a very considerable article of trade. It varies from 18 to 30 inches in length.

**TORSO**, n. [It.] In *sculp.*, the trunk of a statue, deprived of its head and limbs; as, the *torso* of Hercules.

**TORT**, n. [Fr. from *L. tortus*, twisted, from *torqueo*. The primary sense is to turn or strain, hence to twist.] 1. In *law*, any wrong or injury. *Torts* are injuries done to the person or property of another, as trespass, assault and battery, defamation, and the like.— 2. Mischievousness; calamity. [Except in the legal sense above explained, it is obsolete.]

**TORTTEAU**, n. plur. *Tortteaux*. In *her.*, a red roundel.

**TORTILE**, a. [*L. tortilis*.] Twisted; wreathed; coiled. In *bot.*, coiled like a rope; as, a *tortile* awn.

**TORTION**, † n. [*L. tortus*.] Torment; pain.

**TORTIOUS**, a. [from *tort*.] Injurious; done by wrong.— 2. In *law*, implying tort, or injury, for which the law gives damages.

**TORTIOUSLY**, adv. In *Eng. law*, injuriously.

**TORTIVE**, a. [*L. tortus*.] Twisted; wreathed.

**TORTNESS**, n. Tension of a rope when stretched.

**TORTOISE**, n. (tor'tis.) [from *L. tortus*, twisted.] 1. An animal of the order Testudinata, or Chelonia, covered with a shell or crust. The tortoises form a numerous and highly interesting order (Testudinata) of reptiles. They are also called Chelonians from *χελών* (*Chelone*), the Greek name for a tortoise, and are readily distinguished by the double shield in which their body is enclosed, whether they are terrestrial, fresh water, or marine. They were all comprised by Linn. under his genus *Testudo*, but modern naturalists

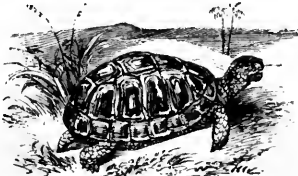

Common or Greek Tortoise (*Testudo Graeca*).

have subdivided them chiefly according to the forms and teguments of their shell, and their feet. According to some of the modern arrangements, the land tortoises form the genus *Testudo*;

the fresh-water tortoises, the genus *Emys*; and the sea tortoises, the genus *Chelonia*. Those Chelonians which resemble fresh-water tortoises, but are distinguished from them by their mouth, which opens cross-wise, and is unarmed with the horny beak common to the former, form the genus *Chelys*, while the soft-shelled tortoises form the genus *Trionyx*.— 2. In the *milit. art.*, a defence used by the ancients, formed by the troops arranging themselves in close order and placing their bucklers over their heads, making a cover resembling a tortoise-shell.

**TORTOISE-SHELL**, n. [*tortoise* and *shell*.] The shell or rather scales of the *Testudo imbricata*, Linn, or the *Chelonia imbricata* of modern zoolo-

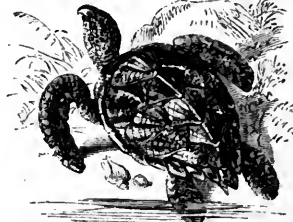

Hawk-bill Turtle (*Chelonia imbricata*).

gists, a species of tortoise which inhabits tropical seas, otherwise known by the name of Hawk's bill turtle. The

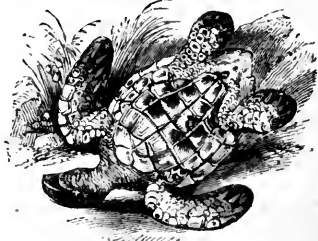

Hawk-bill Turtle, under side.

horny scales or plates which form the covering of this animal, under the name of *tortoise-shell*, are extensively used in the manufacture of combs, snuff-boxes, &c., and in inlaying and other ornamental work. The goodness of tortoise-shell depends mainly on the thickness and size of the scales, and in a smaller degree upon the clearness and brilliancy of the colours. The best tortoise-shell is that of the Indian archipelago.

**TORTUOSE**, } a. [*L. tortuosus*; Fr.  
**TORTUOUS**, } *tortuoux*.] 1. Twisted; wreathed; winding; as, a *tortuous* train; a *tortuous* leaf or corol, in *bot.*— 2. *Tortuose stem*, one that is bent in the manner of a flexuose stem, but less angularly; as in *Cahlie maritima*.— 3. Tortuous. [See **TORTUOUS**.]

**TORTUOSITY**, n. [from *tortuous*; The state of being twisted or wreathed] wreath; flexure.

**TORTUOUSLY**, adv. In a winding manner.

**TORTUOUSNESS**, n. The state of being twisted.

**TORTURE**, n. [Fr. *torture*; It. and Sp. *tortura*; from *L. tortus*, *torqueo*, to twist; W. *torci*; probably from the

root of *turn*. See *TOUR*.—1. Extreme pain; anguish of body or mind; pang; agony; torment. Ghastly spasm or racking *torture*. *Milton*.  
2. Severe pain inflicted judicially, either as a punishment for a crime, or for the purpose of extorting a confession from an accused person. Torture may be and is inflicted in a variety of ways, as by water or by fire, or by the boot or thumbkin. But the most usual mode is by the rack or wheel. Torture was virtually abolished in England in 1640, and in Scotland in the 7th year of Queen Anne.

**TORTURE**, *v. t.* To pain to extremity; to torment.—2. To punish with torture; to put to the rack; as, to *torture* an accused person.—3. To vex; to harass.—4.† To keep on the stretch, as a bow.

**TORTURED**, *pp.* Tormented; stretched on the wheel; harassed.

**TORTURER**, *n.* One who tortures; a tormenter.

**TORTURING**, *ppr.* Tormenting; stretching on the rack; vexing.

**TORTURINGLY**, *adv.* So as to torture or torment.

**TORTUROUS**, † *a.* Tormenting.

**TORULOSE**, } *a.* In *bot.*, cylindrical,  
**TORULOUS**, } with several swells and contractions.

**TORUS**, *n.* [L. *a rope*.] In *arch.*, a large moulding used in the bases of columns.



Torus.

Its section is semi-circular, and it differs from the astragal only in size, the astragal being much smaller. It is sometimes written *Tore*.—2. In *bot.*, the receptacle or part of the flower on which the carpels are seated.

**TORVITY**, *n.* [L. *torvitas*; from twisting, supra.] Sourness or severity of countenance.

**TORV'OUS**, *a.* [L. *torvus*, from the root of *torqueo*, to twist.] Son of aspect; stern; of a severe countenance.

**TORRY**, *n.* [said to be an Irish word, and meaning originally a robber; the Irish robbers of former days, when they called to a party to stand and deliver, usually crying, *Tora, tora!* Give, give!] The name given to an adherent to the ancient constitution of England and to the apostolical hierarchy. One who, in political principles, always leans to church and state; who supports the regal, ecclesiastical, and aristocratical institutions of the country, and who is jealous of the extension of democratic power. The *tories* thus differ from the *whigs* and *radicals*, who, on the other hand, are jealous of the encroachments of the crown, and the privileged classes, and who give their support, in various degrees, to an extension of the power of the people. Of late years the term *conservative* has been adopted by the *tories*, as tending to convey the best idea of their principles. [See *CONSERVATIVE*.] The distinctions of *tory* and *whig*, as applied to political partisans, were not known before the year 1678, in the reign of Charles II. [See *WHIG*.]

The bogs of Ireland... afforded a refuge to popish outlaws... called *tories*. The

name of *tory* was therefore [first] given to Englishmen who refused to concur in excluding a Roman Catholic prince [James II. of England] from the throne.

*Macaulay*.

In America, during the revolution, those who opposed the war and favoured the claims of Great Britain, were called *tories*.

**TORY**, *a.* Pertaining to the *tories*; as, *tory* principles; *tory* measures.

**TORYISM**, *n.* The principles of the *tories*.

**TOSE**, *v. t.* (s as z.) To tease wool. [Not in use or local.]

**TOSS**, *v. t.* pret. and pp. *tossed* or *tost*. [W. *tosiau*, to toss, to jerk. Qu. G. *stossen*, to thrust.]—1. To throw with the hand; particularly, to throw with the palm of the hand upward, or to throw upward; as, to *toss* a ball.—2. To throw with violence.—3. To lift or throw up with a sudden or violent motion; as, to *toss* the head; or to *toss* up the head.

He *toss'd* his arm aloft. *Addison*.

4. To cause to rise and fall; as, to be *tossed* on the waves.

We being exceedingly *tossed* with a tempest; Acts xxvii.

5. To move one way and the other; Prov. xxi.—6. To agitate; to make restless.

Calm region once,

And full of peace, now *tost* and turbulent. *Milton*.

7. To keep in play; to tumble over; as, to spend four years in *tossing* the rules of grammar.

**TOSS**, *v. t.* To toss the oars, in a boat, is to throw them with their blades up, in a perpendicular direction, as a salute.

**TOSS**, *v. i.* To fling; to roll and tumble; to writhe; to be in violent commotion.

To *toss* and fling, and to be restless, only frets and enrages our pain. *Tillotson*.

2. To be tossed.—To *toss up*, is to throw a coin into the air and wager on what side it will fall.

**TOSS**, *n.* A throwing upward or with a jerk; the act of tossing; as, the *toss* of a ball.—2. A throwing up of the head; a particular manner of raising the head with a jerk. It is much applied to horses, and may be applied to an affected manner of raising the head in men.

**TOSS'ED**, *pp.* Throwing upward suddenly or with a jerk; made to rise and fall suddenly.

**TOSS'EL**. See *TASSEL*.

**TOSS'ER**, *n.* One who tosses.

**TOSS'ING**, *ppr.* Throwing upward with a jerk; raising suddenly; as the head.

**TOSSING**, *n.* The act of throwing upward; a rising and falling suddenly; a rolling and tumbling. A violent commotion.

Dire was the *tossing*, deep the groans. *Milton*.

**TOSS'-POT**, *n.* [*toss* and *pot*.] A toper; one habitually given to strong drink.

**TOST**, *pret.* and *pp.* of *Toss*.

In a troubled sea of passion *tost*. *Milton*.

**TOTAL**, *a.* [Fr.; L. *totalis*, *totus*; W. *twl*.]—1. Whole; full; complete; as, *total* darkness; a *total* departure from the evidence; a *total* loss; the *total* sum or amount.—2. Whole; not divided.

Myself the *total* crime. *Milton*.

**TOTAL**, *n.* The whole; the whole sum or amount. These sums added, make the grand *total* of five millions.

**TOTALITY**, *n.* [Fr. *totalité*.] The whole sum; whole quantity or amount.

Identity, diversity; possibility, act; *totality*, parts, &c., are but wise cautions against ambiguities of speech. *Bacon*.

**TOTALLY**, *adv.* Wholly; entirely; fully; completely; as, to be *totally* exhausted; all hope *totally* failed; he was *totally* absorbed in thought.

The obdurate sinner, that hath long hardened his own heart against God, thereby provokes him *totally* to withdraw all inward grace from him. *Hammond*.

**TOTALNESS**, † *n.* Entireness.

**TOTALIZE**, *v. t.* To render entire.

**TOTAM**, *n.* In *American myth.*, a good spirit that every North American Indian believes to watch over him. It is represented under the form of a beast, or some other figure; consequently, the Indians never kill, hunt, nor eat the animal whose form the *totam* is supposed to have taken, being persuaded that if they killed it, even by mistake, they would expose themselves to the wrath of the disposer of life.

**TOTANUS** or **GAMBET**, *n.* A genus of wading birds allied to the *Scolopacidae*, and including numerous species which, under different names, are found in nearly all parts of the world. Their form is light and their legs long. Four species are British—the *Totanus ochropus*, green sandpiper or whistling snipe; the *T. glareola*, wood sandpiper; *T. calidris*, redshank; and *T. fuscus*, spotted snipe. Perhaps the most remarkable species is the *T. melanoleucus*, a native of North America, known to sportsmen by the name of Tell-tale. It has received this cognomen from annoying duck shooters by giving timely warning of their approach to all the feathered tribe within hearing, by means of the loud shrill whistle which it raises.

**TOTE**, *v. t.* To carry or bear. [A word used in slaveholding countries; said to have been introduced by the blacks. This word is said also to be the same as *toll*, which see, the *l* being omitted.]

**TOTE**, *n.* [Lat. *totus*.] The entire body, or all; as, the whole *tote*. [*Colloq.* or *vulgar*.]

**TÔTE**, *n.* Among joiners, the handle of a plane.

**TÔT'ED**, *pp.* Carried or borne.

**TOTHER**, a vulgar pronunciation of the other.

**TOTIDEM VERBIS**. [L.] In so many words; in the very words.

**TOTIES QUOTIES**. [L.] As often as one, so often the other.

**TOTIPAL/MES**, } *n.* [L. *totus*, en-  
**TOTIPAL/MATES**, } tire, and *palma*, a palm.] A tribe of Palmipedes, or swimming birds, whose hind-toe is united with the others in a continuous membrane. The Pelicans, the Cormorants, the Frigate birds, the Boobies, the Anhingas, and the Tropic birds, belong to this tribe.

**TOTO CÆLO**. [L.] By the whole hemisphere; as opposite as possible.

**INTOTO**. [L.] In the whole.

**TOTTER**, *v. t.* [This may be allied to *titter*.]—1. To shake so as to threaten a fall; to vacillate; as, an old man *totters* with age; a child *totters* when he begins to walk.—2. To shake; to reel; to lean. As a bowing wall shall ye be, and as a tottering fence; Ps. lxiii.

Troy nods from high, and *totters* to her fall. *Dryden*.

**TOTTERER**, *n.* One who totters.

**TOTTERING**, *ppr.* Shaking, as threatening a fall; vacillating; reeling; inclining.  
**TOTTERINGLY**, *adv.* In a tottering manner.  
**TOTTERY**, } † *a.* Shaking; trembling  
**TOTTY**, } or vacillating as if about to fall; unsteady. [Spenser wrote *tottle*.]  
**TOTTLE**, *v. i.* To toddle. [*Local, and familiar.*]  
**TOUCAN**, *n.* A bird of tropical America of several species, belonging to the genus *Ramphastos*, remarkable for the



Red-billed Toucan (*Ramphastos erythrorhynchus*)

very large size of its bill. The feet of the Toucans, like those of parrots, are formed for grasping.—2. A small modern constellation of the southern hemisphere.

**TOUCH**, *v. t.* (tuch.) [Fr. *toucher*; Arm. *toucha*, *touchan* or *touchain*; Goth. *tehan*, *atehan*; G. *tichen*; D. *tehen*; Sp. and Port. *tocar*; It. *toccare*; Gr. *τύω*; L. *tango*, originally *tago*, [our vulgar *tag*]; pret. *tetigi*, pp. *tactus*. The sense is to thrust or strike. It appears by the laws of Numa Pompilius, that in his days this word was written without *n*. "Pellex aram Junonis ne *tagito*."]—1. To come in contact with; to hit or strike against.

He *touched* the hollow of his thigh; Gen. xxxii.; Matth. ix.

Ea<sup>th</sup>er drew near and *touched* the top of the sceptre; Esth. v.

2. In *geom.*, to meet; to be in contact with. A straight line is said to *touch* a circle or curve, when it meets the circle or curve, and being produced, does not cut it; and two circles or curves are said to *touch* each other when they meet but do not cut each other. A straight line *touches* a circle or curve only in one point; two circles or spheres *touch* each other only in one point; and a sphere *touches* a plane in only one point. [See CONTACT, TANGENT.]—3. To perceive by the sense of feeling.

Nothing but body can be *touch'd* or *touch*. Creech.

4. To come to; to reach; to attain to. The God vindictive doom'd them never more,

Ah men unles'd! to *touch* that natal shore. Pope.

5. To try, as gold with a stone. Wherein I mean to *touch* your love indeed. Shak.

6. To relate to; to concern. The quarrel *toucheth* none but thee alone. Shak.

[This sense is now nearly obsolete.]

7. To handle slightly.—8. To meddle

with. I have not *touched* the books.—9. To affect.

What of sweet Hath *touch'd* my sense, that seems to this. Milton.

10. To move; to soften; to melt. The tender sire was *touch'd* with what he said. Addison.

11. To mark or delineate slightly. The lines, though *touch'd* but faintly. Pope.

12. To infect; as, men *touched* with pestilent diseases. [Little used.]—13. To make an impression on.

Its face must be...so hard that the file will not *touch* it. Mozon.

14. To strike, as an instrument of music; to play on.

They *touch'd* their golden harps. Milton.

15. To influence by impulse; to impel forcibly. No decree of mine.

To *touch* with lightest moment of impulse His free will. Milton.

16. To treat slightly. In his discourse, he barely *touched* upon the subject deemed the most interesting.—17. To afflict or distress; Gen. xxvi.—To *touch up*, to repair; or to improve by slight touches or emendations.—To *touch the wind*, in seamen's language, is to keep the ship as near the wind as possible.

**TOUCH**, *v. i.* (tuch.) To be in contact with; to be in a state of junction, so that no space is between. Two spheres *touch* only in one point. [See the active verb, No. 2.]—2. To fasten on; to take effect on.

Strong waters will *touch* upon gold, that will not *touch* silver. Bacon.

3. To treat of slightly in discourse.—4. Among seamen, the sails are said to *touch*, when they are braced so sharp, or so near the wind, that they begin to shake.—To *touch at*, to come or go to, without stay. The ship *touched* at Lisbon.

The next day we *touched* at Sidon; Acts xviii.

To *touch on* or *upon*, to mention slightly.

If the antiquaries have *touched upon* it, they have immediately quitted it. Addison.

2. In the sense of *touch at*. [Little used.]

**TOUCH**, *n.* (tuch.) Contact; the hitting of two bodies; the junction of two bodies at the surface, so that there is no space between them. The mimosa shrinks at the slightest *touch*.—2. The sense of feeling or common sensation, one of the five senses. The sense of touch resides in the nervous papillæ of the skin, and is shared in a minor and modified degree by those parts of the mucous membranes, which, at the various orifices of the body, are continuous prolongations of the same structure as that of the skin. Although the sense of touch is diffused over the whole body, it is much more exquisite in some parts than others. In man the hand is the principal organ of touch, and the greatest degree of sensibility resides in the extremities of the fingers. By the sense of touch we are enabled to ascertain the properties of bodies, in so far as they can be ascertained by contact. [See FEELING.] We say, a thing is cold or warm to the *touch*; silk is soft to the *touch*.

The spider's *touch*, how exquisitely fine! Pope.

3. The act of touching. The *touch* of cold water made him shrink.—4. The state of being touched.

That never *touch* was welcome to thy hand Unless I *touch'd*. Shak.

5. Examination by a stone.—6. Test; that by which any thing is examined. Equity, the true *touch* of all laws. Carew.

7. Proof; tried qualities. My friends of noble *touch*. Shak.

8. Single act of a pencil on a picture. Never give the least *touch* with your pencil, till you have well examined your design. Dryden.

9. Feature; lineament. Of many faces, eyes and hearts, To have the *touches* dearest priz'd. Shak.

10. Act of the hand on a musical instrument. Soft stillness and the night Become the *touches* of sweet harmony. Shak.

11. Power of exciting the affections. Not alone The death of Fulvia, with more urgent *touches* Do strongly speak t' us. Shak.

12. Something of passion or affection. He both makes intercession to God for sinners, and exercises dominion over all men, with a true, natural and sensible *touch* of mercy. Hooker.

13. Particular application of any thing to a person. Speech of *touch* toward others should be sparingly used. Bacon.

14. A stroke; as, a *touch* of railery; a satiric *touch*.—15. Animadversion; censure; reproof. I never bore any *touch* of conscience with greater regret. King Charles.

16. Exact performance of agreement. I keep *touch* with my promise. More.

17. A small quantity intermixed. Madam, I have a *touch* of your conscience. Shak.

18. A hint; suggestion; slight notice. A small *touch* will put him in mind of them. Bacon.

19. A cant word for a slight essay. Print my preface in such form as, in the bookseller's phrase, will make a sixpenny *touch*. Swift.

20. In music, the resistance of the keys of an instrument to the fingers; as, a heavy *touch* or light *touch*.—21. In music, an organ is said to have a good *touch* or stop, when the keys close well.—22. In ship-building, touch is the broadest part of a plank worked top and butt; or the middle of a plank worked anchor-stock fashion; also, the angles of the stern timbers at the counters.

**TOUCHABLE**, *a.* (tuch'able.) That may be touched; tangible.

**TOUCH-HOLE**, *n.* (tuch'-hole.) [*touch* and *hole*.] The vent of a cannon or other species of fire-arms, by which fire is communicated to the powder of the charge. It is now called the vent.

**TOUCHILY**, *adv.* (tuch'ely.) With irritation; peevishly.

**TOUCHINESS**, *n.* (tuch'iness.) [from *touchy*.] Peevishness; irritability; irascibility.

**TOUCHING**, *ppr.* (tuch'ing.) Coming in contact with; hitting; striking; affecting.—2. Concerning; relating to; with respect to.

Now as *touching* things offered to idols; 1 Cor. viii.

In this sense, *touching* is usually reckoned a preposition.—3. *a.* Affecting; moving; pathetic.

**TOUCHING**, *n.* (tuch'ing.) Touch; the sense of feeling.

**TOUCHING-LINE**, *n.* In *geom.*, a tangent.

**TOUCHINGLY**, *adv.* (tuch'ingly.) In

a manner to move the passions; feelingly.

**TOUCH-ME-NOT**, *n.* A plant of the genus *Impatiens*, the *I. noli-me-tangere*. [See **IMPATIENS**.]—2. Among physicians, a species of herpes, affecting the skin. [See **NOLI-ME-TANGERE**.]

**TOUCH-NEEDLE**, *n.* (tuch'-needle.) [touch and needle.] Touch-needles are small bars of gold and silver, some of which are pure, and others alloyed with various definite proportions of copper, used by assayers for trying gold and silver, or alloys of them, by comparing the colour and streak which they leave upon a piece of hard black stone, called a *touchstone*, with that produced by the metals to be tried. By this means the purity of gold and silver is discovered, and also the relative quantities of gold and silver in alloys of these metals.

**TOUCHSTONE**, *n.* (tuch'stone.) [touch and stone.] 1. A variety of extremely compact silicious schist, almost as close as flint, used in conjunction with the touch-needles for ascertaining the purity of gold and silver. It was also called *Lydian stone*, or *Lapis Lydia*, by the ancients, because it was found in Lydia in Asia Minor.—2. Any test or criterion by which the qualities of a thing are tried; as, money, the *touchstone* of common honesty.—*Irish touchstone* is the basalt, the stone which composes the Giant's Causeway.

**TOUCH-WOOD**, *n.* (tuch'-wood.) [touch and wood.] Decayed wood, used like a match for taking fire from a spark.

**TOUCHY**, *n.* (tuch'y.) [vulgarly *techy*.] Peevish; irritable; irascible; apt to take fire. [Not elegant.]

**TOUGH**, *a.* (tuf.) [Sax. *toh*; D. *taai*; G. *zũhe*. Qu. *tight*, *thick*.] 1. Having the quality of flexibility without brittleness; yielding to force without breaking. The ligaments of animals and India rubber are remarkably *tough*. *Tough* timber, like young ash, is the most proper for the shafts and springs of a carriage.—2. Firm; strong; not easily broken; able to endure hardship; as, an animal of a *tough* frame.—3. Not easily separated; viscous; clammy; tenacious; ropy; as, *tough* phlegm.—4. Stiff; not flexible.

**TOUGHEN**, *v. i.* (tuf'n.) To grow tough.

**TOUGHEN**, *v. t.* (tuf'n.) To make tough.

**TOUGHENED**, *pp.* Made or become tough.

**TOUGHENING**, *ppr.* Making tough.

**TOUGHISH**, *a.* (tuf'ish.) Tough in a slight degree.

**TOUGHLY**, *adv.* (tuf'ly.) In a tough manner.

**TOUGHNESS**, *n.* (tuf'ness.) The quality of a substance which renders it in some degree flexible, without brittleness or liability to fracture; flexibility with a firm adhesion of parts; as, the *toughness* of steel.—2. Viscosity; tenacity; clamminess; glutinousness; as, the *toughness* of mucus.—3. Firmness; strength of constitution or texture.

**TOUPEE**, } *n.* [Fr. *toupet*, from *touffe*,  
**TOUPET**, } a tuft, or its root.] A little tuft; a curl or artificial lock of hair.

**TOUR**, *n.* [Fr. *tour*, a turn; D. *toer*; Heb. *תור*, *tur*, Ar. *taura*, to go round.] 1. Literally, a going round; hence, a journey in a circuit; as, the *tour* of Europe; the *tour* of France or England.

—2. A turn; a revolution; as, the *tours* of the heavenly bodies. [Not now in use.]—3. A turn; as, a *tour* of duty; a military use of the word.—4. A tress or circular border of hair on the head, worn sometimes by both sexes.—5. † A tower.

**TOURA'EO**, *n.* A genus of birds, (*Corythaix*), natives of Africa, allied to the Scansores. The prevailing colour of the touraeco is green, varied in some species with purple on the wings and tail. They feed chiefly on soft fruits, and frequent the highest branches of the forest trees. The most elegant species is the *C. erythrolophus* of

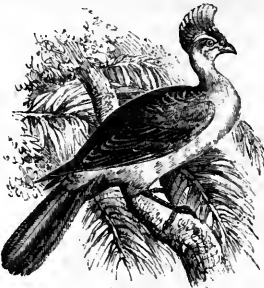

Touraeco (*Corythaix erythrolophus*).

Swainson. Its crest is red, and it is erected when the bird is excited, giving the head the appearance of being helmeted.

**TOURBILL'ON**, *n.* [Fr.] In *pyrotechnics*, a kind of whirling firework.

**TOURIST**, *n.* One who makes a *tour*, or performs a journey in a circuit.

**TOURMALIN**, } *n.* [probably a cor-  
**TOURMALINE**, } ruption of *tourmal*,

a name given to this stone in Ceylon.] A mineral occurring crystallized in three-sided or six-sided prisms, terminated by three-sided pyramids, the primary form being a rhomboid. Fracture uneven, conchoidal. Hardness, scratches glass easily. Specific gravity from 3.069 to 3.076. Colour, white, brown, blue, yellow, green, red, and black. The blue variety is called *Indicolite*, and the red *Rubellite*. Lustre, vitreous. Transparent, translucent, opaque. Tourmaline occurs most commonly in primary rocks, especially in granite, gneiss, and mica-slate. It is found in England, Scotland, Sweden, America, Spain, Siberia, and other parts. Its chief constituents are silica and alumina, with about 10 per cent. of soda, and a little oxide of manganese and of iron; but the proportions of the constituents are extremely variable. The tourmaline by friction exhibits vitreous electricity, and the prismatic crystals of the transparent varieties, when heated, produce vitreous electricity at one end, and resinous at the other. Some of the transparent varieties also exhibit polarization, and are employed in experiments on the polarization of light. Both the green and red varieties are highly esteemed in jewelry, when clear and of a large size. Tourmaline is considered as a variety of shorl.

**TOURN**, *n.* In *law*, the turn or circuit, anciently made by the sheriff, three times every year, for the purpose of holding in each hundred the great court leet of the county. The *tourn* has long fallen into disuse.—2. † A spinning wheel.

**TOURNAMENT**, *n.* (turn'ament.) [from Fr. *tourner*, to turn.] A martial sport or species of combat, performed in former times by knights and cavaliers on horseback, for the purpose of exercising and exhibiting their courage, prowess, and skill in arms. The tournament furnished an exciting show, and gave valour and military talent an opportunity of acquiring distinction; but it not infrequently happened that angry passions burst forth on such occasions, so that a tournament often ended in a hostile conflict. The arms usually employed were lances without



Armour for the Tournament, A. D. 1490.

heads, and with round braces of wood at the extremity, and swords without points, and with blunted edges; but those who desired to signalize themselves in an extraordinary degree, encountered each other with the ordinary arms of warfare. Tournaments were usually held on the invitation of some prince, which was proclaimed by heralds throughout his own dominions, and likewise at foreign courts, so that parties from different countries might join in such exercises. The tournament differed from the *joust*, which was merely a trial of military skill between one knight and another.

**TOURNEY**, *n.* (turn'ey.) A tournament, [supra.]

**TOURNEY**, *v. i.* (turn'ey.) To tilt; to perform tournaments.

**TOURNIQUET**, *n.* (turn'eket.) [Fr.] A surgical instrument or bandage which is straitened or relaxed with a screw, and used to check hemorrhages in the operations of amputation.

**TOURNOIS**, *a.* [Fr.] This epithet is used only in the compound term *livres tournois*, French money of account under the old régime. Each *livre tournois* was worth 99 centimes, or about 9½d. sterling.

**TOURNURE**, *n.* [Fr.] Turn; contour. **TOUSE**, *v. t.* (touz.) [G. *zausen*, to pull.] To pull; to haul; to tear. [Hence, *Touser*.]

As a bear whom angry curs have *tous'd* Spenser.

**TOUSE**, *n.* (touz.) A pulling; a disturbance. [Local.]

**TOUSLE**, *v. t.* (touz'le.) [from *touse*.]

In *low style*, to pull or haul about. In *Scotch*, to put into disorder; to dislevel; to rumple.

**TOUS LES MOIS**, *n.* A kind of starchy matter resembling arrow-root, procured from the rhizomes of several species of *Canna*, as *C. coccinea*, and *C. achiras*.

**TOUT**, *v. i.* To ply or seek for customers. Hence, a *touter* is one who plys for customers to an inn. [*Local*.]

**TOUT**, *† n.* The breech; the tail.

**TOW**, *v. t.* [*Sax. teogan, teon*; *Fr. touer*; *G. ziehen*, to pull; *zag*, a pulling, a tug; *L. duco*.] To drag, as a boat or ship, through the water by means of a rope. *Towing* is performed by another boat or ship, or by men on shore, or by horses. Boats on canals are usually *towed* by horses.

**TOW**, *n.* [*Sax. tow*; *Fr. etoupe*; *L. stupa*; *It. stoppa*; *Sp. estopa*. It coincides with *stuff*.] The coarse and broken part of flax or hemp, separated from the finer part by the hatchel or swingle.—2. Among *seamen*, a rope or chain used in *towing*.—To *take a vessel in tow*, is a figurative expression signifying to take care of her.

**TOWAGE**, *n.* [from *tow*, the verb.] The act of *towing*.—2. The price paid for *towing*.

**TOWARD**, } *prep.* [*Sax. toward*; to  
**TOWARDS**, } and *ward, ward*; *L. versus, verso*.] 1. In the direction to.

He set his face *toward* the wilderness; *Numb. xxiv.*

2. With direction to, in a moral sense; with respect to; regarding.

His eye shall be evil *toward* his brother; *Deut. xxviii.*

Herein do I exercise myself to have always a conscience void of offence *toward* God and *toward* men; *Acts xxiv.*

Hearing of thy love and faith which thou hast *toward* the Lord Jesus Christ, and *toward* all saints; *Philemon v.*

3. With ideal tendency to.

This was the first alarm England received *toward* any trouble. *Clarendon.*

4. Nearly.

I am *toward* nine years older since I left you. *Swift.*

**TOWARD**, } *adv.* Near; at hand;  
**TOWARDS**, } in a state of preparation.

**TOWARD**, *a.* Ready to do or learn; not froward; apt; as, a *toward* youth.

**TOWARDLINESS**, *n.* [from *towardly*.] Readiness to do or learn; aptness; docility.

The beauty and *towardliness* of these children moved her brethren to envy. *Raleigh.*

**TOWARDLY**, *a.* Ready to do or learn; apt; docile; tractable; compliant with duty.

**TOWARDNESS**, *n.* Docility; towardliness.

**TOW-BOAT**, *n.* Any boat employed in *towing* a ship or vessel out of a harbour, &c.

**TOWEL**, *n.* [*Fr. touaille*; *Gaelic, t-bailt*; *It. tovaglia*; *Arm. touailhon*. In Italian the word signifies a table cloth.] A cloth used for wiping the hands, and for other things.

**TOWELLING**, *n.* Cloth for towels.

**TOWER**, *n.* [*Sax. tor, turre*; *Ir. tor*; *Fr. and Arm. tour*; *W. tur*, a heap or pile; *G. thurm*; *D. torn*; *L. turris*; *Gr. τειχος*; *Heb. תורח, turah*.] 1. A lofty building, of a round, square, or polygonal form, and often consisting of several stories. When towers are erected with other buildings, as they

usually are, they rise above the main edifice. They are generally flat on the top, and thus differ from steeples or spires. Before the invention of guns, places were fortified with *towers*, and attacked with movable *towers* mounted on wheels, which placed the besiegers on a level with the walls. Such towers were frequently combined with a battering ram, and thus served the double purpose of breaching the walls and giving protection to the besiegers.—2. A citadel; a fortress; *Ps. lxi.*—3. In *costume*, a high *commode*, or head dress, worn by females in the reigns of William III. and Queen Anne. It was composed of pasteboard, ribands,



Tower head-dress, time of William III.

and lace; the latter two disposed in alternate tiers, or the ribands were formed into high stiffened bows, covered or not, according to taste, by a lace scarf or veil, that streamed down each side of the pinnacle.—4. High flight; elevation.—*Tower bastion*, in *fort.*, a small tower in the form of a bastion, with rooms or cells underneath for men and guns.—*Tower of London*, the name given to a large assemblage of buildings, which occupies an elevated area of 12 or 13 acres, just beyond the old walls of the city of London, south-eastwards, on the northern bank of the Thames. This collection of buildings is used as an arsenal, a garrison, and a repository of various objects of public interest. It was anciently a palace, where the kings of England sometimes resided. In former times it was frequently used as a state prison.—*Round towers*. [See **ROUND TOWERS**.]

**TOWER**, *v. i.* To rise and fly high; to soar; to be lofty. Sublime thoughts, which *tower* above the clouds. *Locke.*

**TOWER-CRESS**, *n.* A cruciferous plant of the genus *Arabis*, the *A. turvita*. It is a British plant, and grows on the walls of buildings.

**TOWERED**, *a.* Having towers; adorned or defended by towers.

**TOWERING**, *ppr.* Rising aloft; mounting high; soaring.—2. *a.* Very high; elevated; as, a *towering* height.

**TOWER-MUSTARD**, *n.* [*tower* and *mustard*.] The English name of a genus of plants (*Turrilis*), of the class *Tetradynamia*, and order *Siliquosa*, *Linn.*; *nat. order Cruciferae*. The leaves become gradually smaller upwards, so that the plant assumes a pyramidal form; hence the name. The long-podded or smooth tower-mustard (*Turrilis glabra*), is a British annual plant, about two feet high, and very erect and straight. It grows on banks

and road sides in many parts of England.

**TOWERY**, *a.* Having towers; adorned or defended by towers; as, *towery* cities.

**TOWING**, *ppr.* Drawing on water, as a boat.

**TOWING**, *n.* The act of drawing a vessel forward in the water by means of a rope attached to another vessel or boat. Steam boats are often employed in *towing* sailing vessels out of harbours, and up rivers, &c.—*Towing overboard*, the act of drawing any thing after a vessel while she is sailing or rowing, which has previously been on board that vessel.

**TOW-LINE**, *n.* [*tow* and *line*.] A small hawser generally used to tow vessels, or to remove a ship from one part of a harbour or road to another, by means of anchors, capstans, &c.

**TOW-PATH**, } *n.* A path used by  
**TOWING-PATH**, } men or horses that tow boats.

**TOW WIT**, To know; namely.

**TOWN**, *n.* [*Sax. tun*; *W. din, dinas*, a fortified hill, a fort; *Gaelic, dun*, *Sax. dun, dune*, a hill, whence *dawns*. The *Sax. tun* signifies an inclosure, a garden, a village, a town, and *tynan* is to shut, to make fast; *G. zaun*, a hedge; *D. tun*, a garden. If the original word signified a hill, the sense is a mass or collection. But probably the original word signified fortified, and the rude fortifications of uncivilized men were formed with hedges and stakes; hence, also, a garden. See **GARDEN** and **TUN**. *Sax. leactune*, a garden, that is, *leek-town*, an inclosure for leeks, that is, plants. This shows that the primary sense of *town* is an inclosure for defence.] 1. *Originally*, a walled or fortified place; a collection of houses inclosed with walls, hedges, or pickets for safety. *Rahab's* house was on the *town* wall; *Josh. ii.*

A *town* that hath gates and bars; *1 Sam. xxiii.*

2. Any collection of houses, larger than a village. In this use the word is very indefinite, and a *town* may consist of twenty houses, or of twenty thousand.

—3. In *popular lan.*, in *England*, a large assemblage of adjoining, or nearly adjoining, houses, to which a market is usually incident. Towns (taking the word in its general sense) are divided into cities, boroughs, and upland towns, or country towns, which latter class have been described as places which, though inclosed, are not governed as cities and boroughs are, by their own elected officers.—4. In *legal lan.*, the word *town* corresponds with the Norman *vill*. A vill or town is a subdivision of a county, as a parish is part or subdivision of a diocese. The law presumes, until the contrary is shown, that towns (or vills) and parishes are co-extensive, so that every parish is a vill, and every vill a parish. Many towns, however, both in the popular and legal sense of the term, contain several parishes, and many parishes several vills, which vills are usually called *tings* or *townships*.—5. The inhabitants of a town. The *town* sends two members to parliament, or the *town* agreed to petition parliament to grant a bill for improving the harbour, opening up new streets, &c.—6. In *popular usage*, in *America*, a township; the whole territory within certain limits.—7. In *England*, the court end

of London, or the people who originate and give currency to the fashions, taste, and opinions of the day.—8. The inhabitants of the metropolis.—9. The metropolis. The gentleman lives in *town* in winter; in summer he lives in the country. The same form of expression is used in regard to other populous towns.—10. A cant name at Oxford and Cambridge for the men of a town. Thus the students in these two cities adopt the phrase *town and town*, to designate the university men and the other male inhabitants. The terms are used in an antagonistic sense.

**TOWN-CLERK, n.** [*town* and *clerk*.] An officer who keeps the records of a town or borough, and enters all its official proceedings. In *Scotland*, the town-clerk of a royal burgh acts as clerk to the burgh court, and as notary in all infestments granted of burgh property. He is the proper custodian of the burgh records, and is entitled and bound to give extracts therefrom.

**TOWN-COUNCIL, n.** In *Scotland*, the body of councillors in a royal burgh who, along with the magistrates, regulate the affairs of the burgh.

**TOWN-CRIER, n.** [*town* and *cry*.] A public crier; one who makes proclamation.

**TOWN-HALL, n.** A large room in a building, used for public meetings, in a town or city.—2. The building itself; a town-house.

**TOWN-HOUSE, n.** [*town* and *house*.] The house where the public business of the town is transacted by the inhabitants, in legal meeting.—2. A house in town; in opposition to a house in the country.

**TOWNISH, a.** Pertaining to the inhabitants of a town; like the town.

**TOWNLESS, a.** Having no town.

**TOWNLEY-MARBLES, n.** An assemblage of Greek and Roman sculpture, which forms a portion of the gallery of antiquities in the British Museum. This collection was so named from Charles Townley, Esq. of Townley, in Lancashire, who made the collection.

**TOWNSHIP, n.** The corporation of a town; the district or territory of a town.—2. In *legal lan.*, a town or vill where there are more than one in a parish. [*See* *Town*, No. 4.] In *New England*, the states are divided into townships of five, six, seven, or perhaps ten miles square, and the inhabitants of such townships are invested with certain powers for regulating their own affairs, such as repairing roads, providing for the poor, &c.

**TOWNSFOLK, n.** People of a town or city. [*See* *Folk*.]

**TOWNSMAN, n.** [*town* and *man*.] An inhabitant of a place; or one of the same town with another.

**TOWN-TALK, n.** [*town* and *talk*.] The common talk of a place, or the subject of common conversation.

**TOWN-TOP, n.** A large top, formerly common in English villages, for public exercise.

**TOW-ROPE, n.** [*tow* and *rope*.] Any rope used in towing ships or boats.

**TOWSER, n.** [*from* *touse*.] The name of a dog.

**TOWSIE, a.** Rough; shaggy. [*Scotch*.]

**TOXICAL, a.** [*Gr.* *τοξικος*.] Poisonous. [*Little used*.]

**TOXICODENDRON, n.** A plant of the genus *Rhus*, the *R. toxicodendron*, or poison oak. [*See* *Rhus*.]

**TOXICOLOGICAL, a.** Pertaining to toxicology.

**TOXICOLOGICALLY, adv.** In a toxicological manner.

**TOXICOLOGIST, n.** One who treats of poisons.

**TOXICOL'OGY, n.** [*Gr.* *τοξικον*, pertaining to an arrow; and as arrows were frequently poisoned, hence a *poison*; and *λογος*, a treatise.] That branch of medicine which treats of poisons and their antidotes, or of the morbid and deleterious effects of excessive and inordinate doses and quantities of medicines, commonly called poisoning. [*See* *Poison*.]

**TOX'ODON, n.** [*Gr.* *τοξον*, a bow, and *odus*, a tooth.] An extinct genus of pachydermatous animals. The *T. platensis* is a gigantic mammiferous animal, having teeth bent like a bow. It was discovered in La Plata, South America.

**TOXOPHILITE, n.** [*Gr.* *τοξον*, a bow or arrow, and *φιλητης*, a lover.] An archer; one who recreates in archery.

**TOXOPHILITE, } a.** Pertaining to  
**TOXOPHILITIC, }** archery; as, there are both male and female members in some *toxophilitic* associations.

**TOXOTES, n.** [*Gr.* *τοξοτης*, a Bowman.] A genus of Acantliopterygious fishes. The only species established, *T. jaculator*, is remarkable for having the power of spouting out drops of water

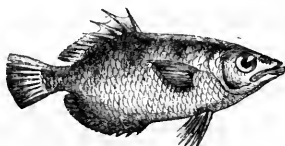

Archer fish (*Toxotes jaculator*).

on insects which alight or feed on the aquatic plants, thereby causing them to fall into the water and become its prey. It shoots the drops sometimes three or four feet high, and seldom misses its aim.

**TOY, n.** [*Qu. D.* *tooi*, tire, ornament.] 1. A plaything for children; a bawble.

—2. A trifle; a thing for amusement, but of no real value.—3. An article of trade of little value.

They exchange gold and pearl for toys. *Abbot.*

4. Matter of no importance. Nor light and idle toys my lines may vainly swell. *Drayton.*

5. Folly; trifling practice; silly opinion.

—6. Amorous dalliance; play; sport.—7. An old story; a silly tale.—8. Slight representation; as, the *toy* of novelty.

—9. Wild fancy; odd conceit.

**TOY, v. i.** [*Dan.* *töner*, Sw. *töfva*, to stay, to tarry, to dally. This seems to be the true origin of *toy*, supra.] To dally amorously; to trifle; to play.

**TOY, † v. t.** To treat foolishly.

**TOYER, n.** One who toys; one who is full of trifling tricks.

**TOYFUL, a.** Full of trifling play.

**TOYING, ppr.** Dallying; trifling.

**TOYISH, a.** Trifling; wanton.

**TOYISHLY, adv.** In a toyish or trifling manner.

**TOYISHNESS, n.** Disposition to dalliance or trifling.

**TOYMAN, n.** [*toy* and *man*.] One that deals in toys.

**TOYSHOP, n.** [*toy* and *shop*.] A shop where toys are sold.

**TOYTE, v. i.** To totter, like an old person in walking. [*Scotch*.]

**TOZE, v. t.** To pull by violence. [*See* *Touse*.]

**TRABEA, n.** [*L.*] In *Roman hist.*, a robe worn by kings, consuls, and augurs.

**TRABEA'TION, n.** [*L. trabs*, a beam.] In *arch.*, the same as entablature,—*which see*.

**TRACE, n.** [*Fr. id.*; *It. traccia*; *Sp. traza*; *L. tractus, tracto*.] *See* *TRACK*, and the verb *TRACE*.] 1. A mark left by any thing passing; a footstep; a track; a vestige; as, the *trace* of a carriage or wagon; the *trace* of a man or of a deer.—2. Remains; a mark, impression, or visible appearance of any thing left when the thing itself no longer exists. We are told that there are no *traces* of ancient Babylon now to be seen.

The shady empire shall retain no trace Of war or blood, but in the syrian chase. *Pope.*

3. A draught or delineation.—4. A small quantity. Telluret of bismuth is composed of tellurium, bismuth, sulphur, and *traces* of selenium.

**TRACE, n.** [*Fr. tirasse*; or *W. tres*.] *See* *TRESTLE*.] *Traces*, in a harness, are the straps, chains, or ropes by which a carriage, waggon, &c., is drawn by horses. [Locally, these are called *tugs*; *Sax. teogan*, to draw.]

**TRACE, v. t.** [*Fr. tracer*; *It. tracciare*; *Sp. trazar*; *L. tracto*, from *traho*, Eng. to draw, to drag.] 1. To mark out; to draw or delineate with marks; as, to *trace* a figure with a pencil; to *trace* the outline of any thing.—2. To follow by some mark that has been left by something which has preceded; to follow by footsteps or tracks.

You may trace the deluge quite round the globe. *Burnet.*

I feel thy power to trace the ways Of highest agents. *Milton.*

3. To follow with exactness. That servile path thou nobly dost decline. Of tracing word by word, and line by line. *Denham.*

4. To walk over.

We do trace this alley up and down. *Shak.*

**TRACEABLE, a.** That may be traced.

**TRACEABLENESS, n.** The state of being traceable.

**TRACEABLY, adv.** In a traceable manner; so as to be traced.

**TRACED, pp.** Marked out; delineated; followed.

**TRACER, n.** One that traces or follows by marks.

**TRACERY, n.** In *arch.*, that species of pattern work, formed or *traced* in the head of a Gothic window by the mullions, being there continued, but diverging into arches, curves, and flowing lines, enriched with foliations. Also, the subdivisions of groined vaults, or any ornamental design of the same character, for doors, panelling, or ceilings.

**TRACHEA, n.** [*Low L.* from *Gr. trachea*.] } *ραχευς*, rough.] In *anat.*, the windpipe; a cartilaginous and membranous pipe through which the air passes into and out of the lungs. Its upper extremity, which is called the *larynx*, consists of five cartilages. The uppermost of these is called the *epiglottis*, and forms a kind of valve at the mouth of the larynx or *glottis*, and closes the passage in the act of swallowing.

**TRACHEÆ, } n. plur.** [*L. trachea*, the *TRACHEÆ,* } windpipe.] In *bot.*,



the spiral vessels of plants, so named from their being considered as the respiratory tubes of plants, a mere fanciful opinion.—2. In entom., those vessels which receive the aerial fluid, and distribute it to every part of the interior of the body, and thus remedy the want of circulation.

TRA'CHEAL, *a.* Pertaining to the TRACHE'AL, } trachea or windpipe; as, the *tracheal* artery.

TRACHEA'RIES, } *n.* [Gr. *τραχεια*, the TRACHEA'RIA, } windpipe.] An order of Arachnides, including those whose organs of respiration consist of radiated or ramified tracheæ, that only receive air through two stigmata, in the absence of an organ of circulation. It includes the pseudo-scorpions, nymphones, mites, ticks, &c.

TRACHE'LIDANS, } *n.* [Gr. *τραχηλιδες*, TRACHE'LIDÆ, } a neck.] A family of coleopterous insects including those which have the head triangular or cordiform, and borne on a sort of neck or pedicel.

TRACHELIP'ODOUS, *a.* Having the foot united with the neck.

TRACHE'LIPODS, } *n.* [Gr. *τραχηλιδες*, TRACHELIP'ODA, } the neck, and *πους*, foot.] Lamarck's name for an order of molluscs, comprehending those which have the greater part of the body spirally convolved, always inhabiting a spirivalve shell; the foot free, attached to the neck, formed for creeping.

TRA'CHEOCELE, *n.* [*trachea* and *κελη*, a tumour.] An enlargement of the thyroid gland; bronchocele or goitre.

TRACHEOT'OMY, *n.* [*trachea* and *τομή*, to cut.] In *sur.*, the operation of making an opening into the trachea or windpipe. It is sometimes also called *Bronchotomy*; and a similar operation on the lower part of the larynx is termed *Laryngotomy*. [See *these terms*.]

TRACHI'NUS, *n.* [Gr. *τραχινος*, rough.] A genus of acanthopterygious fishes of the percid family. Several species are found in the Atlantic, of which the best known is the *T. draco*, or dragon weaver, which is formidable to fishermen from its having the power of inflicting wounds with its opercular spine. The flesh is esteemed.

TRACHI'TIS, *n.* Inflammation of the trachea or windpipe.

TRA'CHYTE, *n.* [Gr. *τραχυς*, rough.] A nearly compact feldspathic, pyrogenous rock, breaking with a rough surface, and often containing crystals of glassy feldspar, with sometimes hornblende and mica. This rock is extremely abundant among the products of modern volcanoes, and forms whole mountains in countries where igneous action is very slightly or not at all perceived.

TRACHYT'IC, *a.* Pertaining to trachyte, or consisting of it.

TRACING, *ppr.* [from *trace*.] Marking out; drawing in lines; following by marks or footsteps.—*Tracing lines*, in a ship, are lines passing through a block or thimble, and used to hoist a thing higher.

TRACING, *n.* Course; regular track or path.

TRACK, *n.* [It. *traccia*; Sp. *traza*; Fr. *trace*. See *TRACE*.] *Track* is properly a mark made by drawing, not by stepping; the latter is a derivative sense.] 1. A mark left by something that has passed along; as, the *track* of a ship, a wake; the *track* of a meteor;

the *track* of a carriage wheel.—2. A mark or impression left by the foot, either of man or beast. Savages are said to be wonderfully sagacious in finding the *tracks* of men in the forest.—3. A road; a beaten path. Behold Torquatus the same *track* pursue.

*Dryden.*

4. Course; way; as, the *track* of a comet.

TRACK, *v. t.* To follow when guided by a trace, or by the footsteps, or marks of the feet; as, to *track* a deer in the snow.—2. To tow; to draw a vessel or boat, by a line reaching from her to the shore or bank.

TRACK'AGE, *n.* A drawing or towing, as of a boat.

TRACK'ED, *pp.* Followed by the footsteps.

TRACK'ING, *ppr.* Following by the impression of the feet; drawing a boat; towing.

TRACK'LESS, *a.* Having no track; marked by no footsteps; untrodden; as, a *trackless* desert.

TRACK'LESSLY, *adv.* So as to leave no track.

TRACK'LESSNESS, *n.* The state of being without a track.

TRACK-ROAD, *n.* [*track* and *road*.] A towing-path.

TRACK-SCOUT, *n.* [*track* and D. *schuit*, boat.] A boat or vessel employed on the canals in Holland, usually drawn by a horse.

TRACK-WAY, *n.* A tram-road. [See *TRAMS*.]

TRACT, *n.* [L. *tractus*; It. *tratto*; Fr. *trait*; from L. *trahō*, Fr. *traire*, to draw.] 1. Something drawn out or extended.—2. A region, or quantity of land or water, of indefinite extent. We may apply *tract* to the sandy and barren desert of Syria and Arabia, or to the narrow vales of Italy and Sardinia. We say, a rich *tract* of land in England or in Scotland, a stony *tract*, or a mountainous *tract*.—3. A short composition in which some particular subject is treated, generally in the form of a pamphlet. *Tract* and *Treatise* are identical in origin and etymological meaning; but the latter is usually applied to a discourse or dissertation of greater length than the former.—*Tracts for the times*, the name given to a series of pamphlets issued by those divines of the Church of England called Puseyites, in which their peculiar opinions and doctrines are developed. [See *PUSEYISM*.]—4. In *hunting*, the trace or footing of a wild beast.—5. † Treatment; exposition.—6. † Track.—7. † Continuity or extension of any thing; as, a *tract* of speech.—8. Continued or protracted duration; length; extent; as, a long *tract* of time.

TRACT, *a.* An epithet used only in the compound term *tract society*. *Tract societies* are associations formed for printing and distributing of religious *tracts*.

TRACT, † *v. t.* To trace out; to draw out.

TRACTABILITY, *n.* [from *tractable*.] The quality or state of being tractable or docile; docility; tractableness.

TRACTABLE, *a.* [L. *tractabilis*, from *trahō*, to handle or lead; Fr. *traitable*; It. *trattabile*.] 1. That may be easily led, taught or managed; docile; manageable; governable; as, *tractable* children; a *tractable* learner.—2. Palpable; such as may be handled; as, *tractable* measures.

TRACT, † *v. t.* To trace out; to draw out.

TRACTABILITY, *n.* [from *tractable*.] The quality or state of being tractable or docile; docility; tractableness.

TRACTABLE, *a.* [L. *tractabilis*, from *trahō*, to handle or lead; Fr. *traitable*; It. *trattabile*.] 1. That may be easily led, taught or managed; docile; manageable; governable; as, *tractable* children; a *tractable* learner.—2. Palpable; such as may be handled; as, *tractable* measures.

TRACTABLENESS, *n.* The state or quality of being tractable or manageable; docility; as, the *tractableness* of children.

TRACTABLY, *adv.* In a tractable manner; with ready compliance.

TRACTA'RIAN, *n.* A term applied to the writers of the *tracts for the times*, or the *Oxford tracts*, in favour of Puseyism, and also to those who acquiesce in their opinions. [See *PUSEYISM*.]

TRACTA'RIAN, *a.* Pertaining to the Tractarians or their doctrines; as, the *tractarian* controversy.

TRACTA'RIANISM, *n.* Another name for Puseyism.

TRACTATE, † *n.* [L. *tractatus*.] A treatise; a tract.

TRACTA'TION, *n.* [L. *tractatio*.] Treatment or handling of a subject; discussion.

TRACTA'TRIX, *n.* In *geom.*, a curve line.

TRACT'ILE, *a.* [L. *tractus*.] Capable of being drawn out in length; ductile. Bodies are *tractile* or *intractile*. *Bacon*.

TRACTIL'ITY, *n.* The quality of being tractile; ductility.

TRACT'ION, *n.* [L. *tractus*, *trahō*.] 1. The act of drawing, or state of being drawn; as, the *traction* of a muscle.—2. Attraction; a drawing toward.—3. In *mech.*, the act of drawing a body along a plane, usually by the power of men, animals, or steam; as, when a vessel is towed upon the surface of water, or a carriage upon a road or railway. The power exerted in order to produce the effect is called the *force of traction*. This term has recently come much into use in reference to the draught on railways, canals, &c., and numerous experiments have been made for the purpose of determining the force of traction, in different cases, and the most advantageous mode of applying this power. The line in which the force of traction acts, is called the line of traction, and the angle which this line makes with the plane along which a body is drawn by the force of traction is called the *angle of traction*. It is synonymous with the angle of draught. [See *DRAUGHT*.]

TRACTI'TIOUS, *a.* Treating of, handling.

TRACT'IVE, *a.* That pulls or draws; drawing along; as, *tractive* power or force.

TRACT'OR, *n.* That which draws, or is used for drawing. *Metallic tractors*, the name given to two small pointed bars of brass and steel, which by being drawn over diseased parts of the body, were supposed to give relief through the agency of some electric or magnetic virtue, produced by the mode of using them. They were contrived by Dr. Perkins, an American physician, and were in great vogue about 40 years ago. Wonderful cures of local complaints are said to have been performed by them, but they have now fallen into disrepute.

TRACT'ORY, } *n.* [L. *trahō*, to draw.] TRACT'RIX, } In *math.*, a curve whose tangent is always equal to a given line. It may be described by a small weight attached to a string, the other end of which is moved along a given straight line or curve. The evolute of this curve is the common catenary.

TRADE, *n.* [Sp. and Port. *trato*; *tratar*, to handle, to trade; It. *trattu*, *trattare*,

from *L. tracto*, to handle, use, *treat* The Fr. *traite*, *traiter*, are the same words.] 1. The act or business of exchanging commodities by barter; or the business of buying and selling for money; commerce; traffic; barter. Trade comprehends every species of exchange or dealing, either in the produce of land, in manufactures, in bills or money. It is, however, chiefly used to denote the barter or purchase and sale of goods, wares, and merchandise, either by wholesale or retail. Trade is either *foreign*, or *domestic* or *inland*. *Foreign* trade consists in the exportation and importation of goods, or the exchange of the commodities of different countries. *Domestic* or *home* trade is the exchange or buying and selling of goods within a country. Trade is also by the wholesale, that is, by the package or in large quantities, or it is by retail, or in small parcels. The *carrying* trade is that of transporting commodities from one country to another by water. Trade was originally carried on chiefly by barter; but it is now carried on chiefly by means of money or bills.—2. The business which a person has learned and which he carries on for procuring subsistence or for profit; occupation; particularly, mechanical employment; distinguished from the liberal arts and learned professions, and from agriculture. Thus we speak of the *trade* of a smith, of a carpenter, or mason. But we never say, the *trade* of a farmer or of a lawyer or physician.—3. Business pursued; occupation; *in contempt*; as, piracy is their *trade*.

Hunting their sport, and plund'ring was their *trade*. *Dryden*.

#### 4. Instruments of any occupation.

The shepherd bears

His house and household goods, his *trade* of war. *Dryden*.

#### 5. Employment not manual; habitual exercise.—6. Custom; habit; standing practice.

Thy sin's not accidental, but a *trade*. *Shak*.  
7. Men engaged in the same occupation. Thus booksellers speak of the customs of the *trade*.—8. The *trades*, the trade-winds.—*Board of trade*, a department of the government, being a committee of the Privy Council, appointed principally "for the consideration of all matters relating to trade, and foreign plantations." It is practically under the direction of a president and vice-president, but several members of the cabinet and officers of state are members of it. All laws passed by colonial legislatures must receive the formal sanction of the Board of Trade, before they can receive the assent of the Crown.

**TRADE**, *v. i.* To barter, or to buy and sell; to deal in the exchange, purchase, or sale of goods, wares, and merchandise, or any thing else; to traffic; to carry on commerce as a business. Thus, British merchants *trade* with the Americans at New York, and New Orleans; they *trade* with the French at Havre; they *trade* with the Russians at Cronstadt; and they *trade* with Turkey and China. The country shopkeepers *trade* with London merchants. Our banks are permitted to *trade* in inland bills of exchange.—2. To buy and sell or exchange property, in a single instance. Thus we say, a man treats with another for the lease of his farm, but cannot *trade* with him. A.

*traded* with B. for a horse or a number of sheep.—3. To act merely for money.

How did you dare

To *trade* and traffic with Macbeth? *Shak*.

#### 4. To have a trade wind.

They on the *trading* flood ply tow'rd the pole. [*Unusual*.] *Milton*.

**TRADE**, *v. t.* To sell or exchange in commerce.

They *traded* the persons of men; *Ezek*. xvii.

[*Not legitimate*.]

**TRADED**, *† a.* Versed; practised.

**TRADEFUL**, *a.* Commercial; busy in traffic.

**TRADE**, *n.* One engaged in trade or commerce; a dealer in buying and selling or barter; as, a *trader* to New York; a *trader* to China; a country *trader*.

**TRADESCANTIA**, *n.* A genus of plants; nat. order *Commelinaceæ*. The species are natives of America and India, and many of them are cultivated as ornamental plants in flower-gardens.

*T. virginica*, a north American species,



Spider wort (*Tradescantia virginica*).

is known by the name of spider-wort, from its being employed in cases of bites of venomous spiders. It is common in the flower-borders of English gardens.

**TRADES**, *† n.* People employed in trade.

**TRADESMAN**, *n.* [*trade* and *man*.] A shopkeeper. A merchant is called a *trader*, but not a *tradesman*.

**TRADES-PEOPLE**, *n.* People employed in various trades.

**TRADES-WOMAN**, *n.* A woman who trades or is skilled in trade.

**TRADE-WINDS**, *n.* [*trade* and *wind*.] The trade-winds are those perpetual or constant winds which occur in all open seas, on both sides of the equator, and to the distance of about 30 degrees north and south of it. They are so named because they are favourable to navigation and trade. On the north of the equator, their direction is from the north-east, (varying at times a point or two of the compass either way); on the south of the equator they proceed from the south-east. The origin of the trade-winds is this:—the great heat of the torrid zone rarefies and makes lighter the air of that region, and in consequence of this rarefaction, the air rises, and ascends into the higher regions of the atmosphere. To supply its place, colder air from the northern and southern regions rushes towards the equator, which, also becoming rarefied, ascends in its turn. The heated

air which thus ascends into the upper regions of the atmosphere, being there condensed, flows northward and southward to supply the deficiency caused by the under currents blowing towards the equator. These under currents coming from the north and south, are, in consequence of the earth's rotation on its axis, deflected from their course as they approach the equatorial region, and thus become north-east and south-east winds, constituting the trade-winds. The space included between the second and fifth degrees of north latitude, is the internal boundary of the trade winds; and this space experiences calms, frequently interrupted, however, by violent storms. The position of the sun has an influence on the strength and direction of the trade-winds; for when the sun is near the tropic of Cancer, the south-east wind becomes gradually more southerly and stronger, and the north-east weaker and more easterly; the effect is reversed when the sun approaches towards the tropic of Capricorn. Trade-winds are constant only over the open ocean, and the larger the expanse of ocean over which they blow, (as in the Pacific), the more steady they are. When these winds blow over land, they are obstructed and their direction changed by coming in contact with high land or mountains. In some places the trade-winds become periodical, blowing one half of the year in one direction, and the other half in the opposite direction. [*See Monsoon*.]

**TRADING**, *ppr.* Trafficking; exchanging commodities by barter, or buying and selling them.—2. *a.* Carrying on commerce; as, a *trading* company.

**TRADING**, *n.* The act or business of carrying on commerce.

**TRADITION**, *n.* [*Fr.* from *L. traditio*, from *trado*, to deliver.] 1. Delivery; the act of delivering into the hands of another.

A deed takes effect only from the *tradition* or delivery. *Blackstone*.

The sale of a movable is completed by simple *tradition*. *Cyc*.

2. The delivery of opinions, doctrines, practices, rites, and customs from father to son, or from ancestors to posterity; the transmission of any opinions or practice from forefathers to descendants by oral communication, without written memorials. Thus, children derive their vernacular language chiefly from *tradition*. Most of our early notions are received by *tradition* from our parents.—3. That which is handed down from age to age by oral communication. The Jews pay great regard to *tradition* in matters of religion, as do the Romanists. Protestants reject the authority of *tradition* in sacred things, and rely only on the written word. *Traditions* may be good or bad, true or false.

Stand fast, and hold the *traditions* which ye have been taught, whether by word or our epistle; 2 Thess. ii.

Why do ye also transgress the commandment of God by your *traditions*? *Math*. xv.

4. In *Scots law*, delivery. Tradition or delivery is necessary to every conveyance of property, where the acquirer has not already the custody or possession. Tradition is either *actual*, or, where actual is impracticable, *symbolical*, as in the case of heritage.

**TRADITIONAL**, } *a.* Delivered  
**TRADITIONARY**, } orally from father to son; communicated from

ancestors to descendants by word only; transmitted from age to age without writing; as, *traditional* opinions; *traditional* evidence; the *traditional* expositions of the Scriptures.

The reveries of the Talmud, a collection of Jewish *traditionary* interpolations, are unrivaled in the regions of absurdity.

*Buckminster.*

2. † Observant of tradition.

**TRADI''TIONALLY, adv.** By transmission from father to son, or from age to age; as, an opinion or doctrine *traditionally* derived from the Apostles is of no authority.

**TRADI''TIONARILY, adv.** By tradition.

**TRADI''TIONARY, n.** Among the Jews, one who acknowledges the authority of traditions, and explains the Scriptures by them. The word is used in opposition to *Cairite*, one who denies the authority of traditions.

**TRADI''TIONER, } n.** One who ad-  
**TRADI''TIONIST, }** heres to tradition.

**TRAD''ITIVE, a.** [Fr. from *L. trado.*] Transmitted or transmissible from father to son, or from age to age, by oral communication.

Suppose we on things *traditive* divide.

*Dryden.*

**TRAD''ITOR, n. plur. Traditores.** [L.] A deliverer; a name of infamy given to Christians who in the first ages of the church, during the persecutions, delivered the Scriptures or the goods of the church to their persecutors, to save their lives.

**TRADUCE, v. t.** [L. *traduco*; *trans*, over, and *duco*, to lead; Fr. *traduire*; It. *tradurre.*] 1. To represent as blamable; to condemn.

The best stratagem that Satan hath, is by *traducing* the form and manner of the devout prayers of God's church. *Hooker.*

2. To calumniate; to vilify; to defame; wilfully to misrepresent.

As long as men are malicious and designing, they will be *traducing*.

*Gen. of the Tongue.*

He had the baseness to *traduce* me in libel.

*Dryden.*

3. To propagate; to continue by deriving one from another.

From these only the race of perfect animals was propagated and *traduced* over the earth. † *Hale.*

**TRADUCED, pp.** Misrepresented; calumniated.

**TRADUCEMENT, n.** Misrepresentation; ill founded censure; defamation; calumny. [*Little used.*]

**TRADUCENT, a.** Slandering; slanderous.

**TRADUCER, n.** One that traduces; a slanderer; a calumniator.

**TRADUCIBLE, a.** That may be orally derived or propagated. [*Little used.*]

**TRADUCING, ppr.** Slandering; defaming; calumniating.

**TRADUCINGLY, adv.** Slanderingly; by way of defamation.

**TRADUCT, † v. t.** [L. *traductus, traduco.*] To derive.

**TRADUC''TION, n.** [L. *traductio.*] 1. Derivation from one of the same kind; propagation.

If by *traduction* came thy mind,

Our wonder is the less to find

A soul so charming from a stock so good.

*Dryden.*

2. Tradition; transmission from one to another; as, traditional communication and *traduction* of truth. [*Little used.*].—3. Conveyance; transportation;

ii.

act of transferring; as, the *traduction* of animals from Europe to America by shipping.—4. Transition.

**TRADUCTIVE, a.** Derivable; that may be deduced.

**TRAF''FIC, n.** [Fr. *trafic*; It. *traffico*; Sp. *trafago*; a compound of *L. trans*, Celtic *tra* and *facio*, or some other verb of the like elements.] 1. Trade; commerce, either by barter or by buying and selling. This word, like *trade*, comprehends every species of dealing in the exchange or passing of goods or merchandise from hand to hand for an equivalent, unless the business of retailing may be excepted. It signifies appropriately foreign trade, but is not limited to that.

My father,

A merchant of great *traffice* through the world. *Shak.*

2. Commodities for market.

**TRAF''FIC, v. i.** [Fr. *trafiquer*; It. *trafficare*; Sp. *traficar* or *trafagar.*]

1. To trade; to pass goods and commodities from one person to another for an equivalent in goods or money; to barter; to buy and sell wares; to carry on commerce. The English and Americans *traffice* with all the world.—2. To trade meanly or mercenarily.

**TRAF''FIC, v. t.** To exchange in traffic.

**TRAF''FICABLE, † a.** Marketable.

**TRAF''FICKED, pp.** Exchanged in traffic.

**TRAF''FICKER, n.** One who carries on commerce; a trader; a merchant; *Is. viii.*

**TRAF''FICKING, ppr.** Trading; bartering; buying and selling goods, wares, and commodities.

**TRAF''FICLESS, a.** Destitute of trade.

**TRAG''ACANTH, n.** [L. *tragacanthum*; Gr. *τραγακανθα*; *τραγος*, a goat, and *ακανθα*, thorn.] 1. Goat's thorn; a leguminous plant of the genus *Astragalus*, the *A. tragacantha*, long reputed to be the source of the tragacanth of commerce, which yields however no concrete gum, but merely a gummy juice used in confectionary.—2. A variety of gum familiarly termed gum-dragon. It is the produce of several species of the genus *Astragalus*. The greater part of this gum used in Europe is yielded by *A. verus*, a native of the north of Persia, Armenia, and Asia Minor, and by *A. gummifer*, a native of

colour is whitish or yellowish. Both sorts are hard, yet somewhat soft, and even flexible before breaking; the fracture dull and splintery. *Tragacanth* is devoid of taste or smell. It swells in the mouth, and is lubricous. It is composed of gum, bassorin, starch, and vegetable membrane, and is imperfectly soluble. It is used in the form of mucilage, and of powder, to suspend heavy powders in water, and also to make lozenges and pills. It is demulcent, and is used in coughs and catarrhs. In Persia and France it is used to stiffen and glaze silk, and inferior kinds are used by shoemakers to glaze the edges of the soles of boots and shoes.

**TRAGACAN''THINE, n.** The principle of tragacanth; the soluble gum of tragacanth.

**TRAGE''DIAN, n.** [L. *tragædus. See TRAGEDY.*] 1. A writer of tragedy.—2. *More generally*, an actor of tragedy.

**TRAG''EDY, n.** [Fr. *tragédie*; It. and Sp. *tragedia*; Gr. *τραγωδία*; said to be composed of *τραγος*, a goat, and *ωδη*, a song, because originally it consisted in a hymn sung in honour of Bacchus by a chorus of music, with dances and the sacrifice of a goat; but some recent writers consider *τραγος* an ancient Greek adjective, signifying melancholy, or lamentable. According to this opinion, tragedy properly signifies a *melancholy* song.] 1. A dramatic poem representing some signal action performed by illustrious persons, and generally having a fatal issue. A Greek tragedy always consisted of two distinct parts; the dialogue, which corresponded in its general features to the dramatical compositions of modern times; and the chorus, the whole tone of which was lyrical rather than dramatical, and which was meant to be sung while the dialogue was intended to be recited. The unity of time;—namely, that the duration of the action should not exceed twenty-four hours; and that of place,—namely, that the scene in which the events occur should be the same throughout, are modern inventions. *Eschylus* is called the father of *tragedy*.—2. A fatal and mournful event; any event in which human lives are lost by human violence, more particularly by unauthorized violence.

**TRAG''IA, n.** A genus of plants; nat. order *Euphorbiacæ*. The species are climbing in habit, and some of them sting like nettles. They are found in India and America. The roots of *T. cannabina*, given in infusion, are considered diaphoretic and alterative.

**TRAG''IC, } a.** [L. *tragicus*; Fr. **TRAG''ICAL, } tragique; It. tragico.]**

1. Pertaining to tragedy; of the nature or character of tragedy; as, a *tragic* poem; a *tragic* play or representation.—2. Fatal to life; mournful; sorrowful; calamitous; as, the *tragic* scenes of *Hayti*; the *tragic* horrors of *Scio* and *Missolonghi*; the *tragic* fate of the Greeks.—3. Mournful; expressive of tragedy, the loss of life, or of sorrow. I now must change those notes to *tragic*.

*Milton*

**TRAG''ICALLY, adv.** In a tragical manner; with fatal issue; mournfully; sorrowfully. The play ends *tragically*. **TRAG''ICALNESS, n.** Fatality; mournfulness; sadness.

We moralize the fable in the *tragicalness* of the event. *Decay of Piety.*

6 q



Tragacanth (*Astragalus gummifer*).

Mount Lebanon, Arabia, &c. It is yielded, though more sparingly, by *A. creticus*, *A. aristatus*, and one or two other species. In commerce, tragacanth occurs in small twisted thread-like pieces, or in flattened cakes. The

**TRAGI-COM'EDY, n.** [Fr. *tragi-comédie*; *tragedy* and *comedy*.] A kind of dramatic piece representing some action passed among eminent persons, in which serious and comic scenes are blended. All the plays of Shakspeare, with the exception of the *Merry Wives of Windsor*, and the *Twelfth Night*, are, strictly speaking, of this nature, and indeed almost all the works of the old English dramatists; but some writers confine the word *tragi-comedy* to dramatic pieces, partaking of the nature of tragedy and comedy, of which the event is not unhappy.

**TRAGI-COM'IC, } a. Pertaining**  
**TRAGI-COM'ICAL, } to tragi-comedy; partaking of a mixture of grave and comic scenes.**

**TRAGI-COM'ICALLY, adv.** In a tragi-comical manner.

**TRAG'ICUS, n.** [See **TRAGUS**.] In *anat.*, a proper muscle of the ear, which pulls the point of the tragus a little forward.

**TRAGOPO'GON, n.** Goat's beard, a genus of plants. [See **GOAT'S BEARD**.]

**TRAG'US, n.** [Gr. *tragos*, a goat, so named from its being furnished, in some persons, with a tuft of hair, like the beard of a goat.] In *anat.*, a small cartilaginous eminence at the entrance of the external ear.

**TRAIL, v. t.** [W. *rhel*, a flagging, a trailing; *rhelyo*, a trail; Sp. *traillar*, to level the ground; *trailla*, a leash, packthread, an instrument for levelling the ground; W. *trail*, a drawing over, a trail, a turn, as if from *traigyl*, a turn or revolution; *treillaw*, to turn, to traverse, to dredge; Gael. *triallam*, to go, to walk, [qu. *travel*]; Port. *tralho*, a fishing net, as if from drawing, L. *traho*; D. *treillen*, to draw, to tow; Norm. *trailler*, to search for. The Welsh seems to accord with *troll*; the others appear to be formed on *drag*, L. *traho*. Qu.] 1. To hunt by the track. [See the Norman, supra.] —2. To draw along the ground; to drag. *Trail your pikes.*

And hung his head, and *trail'd* his legs along. *Dryden.*  
They shall not *trail* me through the streets Like a wild beast. *Milton.*  
That long behind he *trails* his pompous robe. *Pope.*

3. To lower; as, to *trail* arms.—4. In *America*, to tread down grass by walking through; to lay flat; as, to *trail* grass.

**TRAIL, v. i.** To be drawn out in length. When his brother saw the red blood *trail*. *Spenser.*

**TRAIL, n.** Track followed by the hunter; scent left on the ground by the animal pursued.

How cheerfully on the false *trail* they cry. *Shak.*

2. Any thing drawn to length; as, the *trail* of a meteor; a *trail* of smoke.

When lightning shoots in glittering *trailes* along. *Rowe.*

3. Any thing drawn behind in long undulations; a train.

And drew behind a radiant *trail* of hair. *Pope.*

4. The entrails of a fowl; applied sometimes to those of sheep.—5. In *gunnery*, the end of a travelling carriage, opposite to the wheels, and upon which the carriage slides, and which unlimbered or upon the battery.—

*Trail-boards*, in *ship-building*, a term for the carved work between the

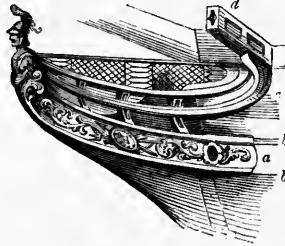

Trail-board in Ships.

a, Trail-board. c, Rails of the head.  
b, b, Cheeks of the head. d, Cat-head.

cheeks of the head, at the heel of the figure.

**TRAILED, pp.** Hunted by the tracks; laid flat; drawn along on the ground; brought to a lower position; as, *trailed* arms.

**TRAILING, ppr.** Hunting by the track; drawing on the ground; treading down; laying flat; bringing to a lower position; drawing out in length.

Since the flames pursu'd the *trailing* smoke. *Dryden.*

Swift men of foot whose broad-set backs Their *trailing* hair did hide. *Chapman.*  
*Trailing plants*, such plants as are of a creeping habit.

**TRAIN, v. t.** [Fr. *trainer*; It. *trainare*, *trarnare*, to draw or drag; Sp. *traina*, a train of gunpowder. Qu. *drain*, or is it a contracted word, from L. *traho*, to draw?] 1. To draw along.

In hollow cube he *train'd* His devilish enginery. *Milton.*

2. To draw; to entice; to allure. If but twelve French

Were there in arms, they would be as a call To *train* ten thousand English to their side. *Shak.*

3. To draw by artifice or stratagem. O *train* me not, sweet mermaid, with thy note. *Shak.*

4. To draw from act to act by persuasion or promise. We did *train* him on. *Shak.*

5. To exercise; to discipline; to teach and form by practice; as, to *train* the militia to the manual exercise; to *train* soldiers to the use of arms and to military tactics. Abram armed his *trained* servants; Gen. xiv. 14.—6. To break, tame, and accustom to draw; as oxen.—7. In *gardening*, to lead or direct and form to a wall or espalier; to form to a proper shape by growth, lopping, or pruning; as, to *train* young trees.—8. In *mining*, to trace a lode or any mineral appearance to its head.—*To train a gun*, is to point it at some object, either forward or abaft the beam, that is, not directly on the side.—*To train or train up*, to educate; to teach; to form by instruction or practice; to bring up.

*Train up a child* in the way he should go, and when he is old he will not depart from it; Prov. xxii.

**TRAIN, n.** Artifice; stratagem of enticement.

Now to my charms, And to my wily *trains*. *Milton.*

2. Something drawn along behind, the end of a gown, &c.; as, the *train* of a gown or robe.—3. The tail of a hawk, or fowl.

The *train* steers their flight, and turns their bodies, like the rudder of a ship. *Ray.*

4. A retinue; a number of followers or attendants.

My *train* are men of choice and rarest parts. *Shak.*

The king's daughter with a lovely *train*. *Addison.*

5. A series; a consecution or succession of connected things.

Rivers now stream and draw their humid *train*. *Milton.*

Other truths require a *train* of ideas placed in order. *Locke.*

The *train* of ills our love would drag behind it. *Addison.*

6. Process; regular method; course. Things are now in *atrain* for settlement.

If things were once in this *train*...our duty would take root in our nature. *Swift.*

7. A company in order; a procession. Fairest of stars, last in the *train* of night. *Milton.*

8. The number of beats which a watch makes in any certain time.—9. A line of gunpowder, laid to lead fire to a charge, or to a quantity intended for execution.—10. † A trap or lure for any animal.—11. The after part of a gun-carriage.—12. A continuous line of carriages on a railway.—13. In *horology*, the series of wheels, &c., forming a movement in a clock or watch; as, some clocks have an hour or dial *train* and a striking *train*; others have no striking *train*, that is, either do or do not sound the time.—*Train of artillery*, any number of cannon, mortars, &c., with the attendants and carriages which follow them into the field.

**TRAINABLE, a.** That may be trained. [*Little used*.]

**TRAIN-BAND, n.** [*train* and *band*.] A band or company of militia. *Train-bands*, in the plural, militia; so called because trained to military exercises.

**TRAIN-BEARER, n.** [*train* and *bearer*.] One who holds up a train.

**TRAINED, pp.** Drawn; allured; educated; formed by instruction; having a train.

**TRAINER, n.** One who trains up; an instructor.—2. One who trains or prepares men for athletic exercises, or horses for the race, &c.

**TRAINING, ppr.** Drawing; alluring; educating; teaching and forming by practice.

**TRAINING, n.** The act or process of drawing or educating; education.—2. The act of preparing men for athletic exercises, or horses for the race.

—3. In *gardening*, the operation or art of forming young trees to a wall or espalier, or of causing them to grow in a shape suitable for that end.—4. The disciplining of troops.

**TRAIN-OIL, n.** [Fr. *trainer*, to draw; but the term is possibly only a corruptive of *strain* or *strained oil*.] The oil procured from the blubber or fat of whales, and from the fat of various other fishes, by boiling.

**TRAIN-ROAD, n.** [*train* and *road*.] In *mines*, a slight railway for small wagons.

**TRAIN-TACKLE, n.** A tackle hooked to the train of a gun, to hold it to its place during action.

**TRAINY, † a.** Belonging to train-oil.

**TRAI'PSE, v. i.** To walk sluttishly or carelessly. [*A low word*.]

**TRAIT, n.** [Fr. *trait*, from *traire*, to draw; L. *tractus*. See **TRACT** and **TREAT**.] 1. A stroke; a touch.

By this single *trait*, Homer makes an essential difference between the Iliad and Odyssey. *Broome*

2. A line; a feature; as, a *trait* of character. This word is sometimes pronounced as in French, *trây*, plur. *trâys*.

**TRAITEUR**, *n.* [Fr.] The keeper of an eating-house; a restaurateur.

**TRAITOR**, *n.* [Fr. *traître*; Arm. *treitre*, *treitor*; Sp. *traidor*; from L. *traditor*, *trado*, to deliver.] 1. One who violates his allegiance and betrays his country; one guilty of treason; one who, in breach of trust, delivers his country to its enemy, or any fort or place intrusted to his defence, or who surrenders an army or body of troops to the enemy, unless when vanquished; or one who takes arms and levies war against his country; or one who aids an enemy in conquering his country. [See TREASON.]—2. One who betrays his trust; one guilty of perfidy or treachery.

**TRAITORIOUS**, *a.* Treacherous.

**TRAITOROUS**, *a.* Guilty of treason; treacherous; perfidious; faithless; as, a *traitorous* officer or subject.—2. Consisting in treason; partaking of treason; implying breach of allegiance; as, a *traitorous* scheme or conspiracy.

**TRAITOROUSLY**, *adv.* In violation of allegiance and trust; treacherously; perfidiously.

They had *traitorously* endeavoured to subvert the fundamental laws. *Clarendon*.

**TRAITOROUSNESS**, *n.* Treachery; the quality of being treasonable.

**TRAITRESS**, *n.* A female who betrays her country or her trust.

**TRAJECT**, *v. t.* [L. *trajectus*, *trajicio*; *trans* and *jacio*, to throw.] To throw or cast through; as, to *traject* the sun's light through three or more cross prisms.

**TRAJECT**, *n.* [Fr. *trajet*; L. *trajectus*.] A ferry; a passage, or place for passing water with boats.

**TRAJECTING**, *ppr.* Casting through.

**TRAJECTION**, *n.* The act of casting or darting through.—2. Transportation.—3. Emission.

**TRAJECTORY**, *n.* The name formerly given to the path of any body moving either in a void, or in a resisting medium, the body being acted on by given forces; as, the curve described by a planet or a comet in its orbit. The term is now seldom used.

**TRALATION**, *n.* [from L. *trallatio*.] A change in the use of a word, or the use of a word in a less proper, but more significant sense.

**TRALATION**, *n.* A change, as in the use of words; a metaphor.

**TRALATI'IOUS**, *a.* [L. *translatus*, *transfere*.] Metaphorical; not literal.

**TRALATI'IOUSLY**, *adv.* Metaphorically; not in a literal sense.

**TRALINEATE**, *v. t.* [L. *trans* and *linea*, line.] To deviate from any direction.

**TRALUCENT**, *a.* [L. *tralucens*; *trans* and *luco*.] Transparent; clear.

**TRAMMEL**, *n.* [Fr. *travail*, a drag-net; *tra* and *mail*. In Sp. *traba* is a fetter, Fr. *entraves*. This seems to be a different word.] 1. A kind of long net for catching birds or fishes.

The *trammel* differs not much from the shape of the bunt. *Carew*.

2. A kind of shackles used for regulating the motions of a horse, and making him amble.—3. An iron hook, of various forms and sizes, used for hanging kettles and other vessels over the fire.—4. *Trammets*, in *mech.*, elliptic compasses, an instrument for drawing

ovals, used by joiners and other artificers. One part consists of a cross with two grooves at right angles; the other is a beam carrying two pins which

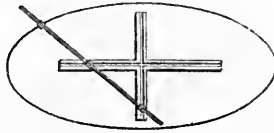

Trammels.

slide in those grooves, and also the describing pencil. The engines for turning ovals or ellipses, are constructed on the same principles as the trammels.

**TRAMMEL**, *v. t.* [Sp. *trabar*, to join, to seize, to shackle. Qu.] 1. To catch; to intercept.—2. To confine; to hamper; to shackle.

**TRAMMELLED**, *pp.* Caught; confined; shackled.—2. In the *manege*, a horse is said to be trammelled, when he has blazes or white marks on the fore and hind foot of one side.

**TRAMMELLING**, *ppr.* Catching; confining; shackling.

**TRAMONTANE**, *n.* One living beyond the mountain; a stranger; a barbarian.

**TRAMONTANE**, *a.* [It. *tramontana*; *tra*, L. *trans*, beyond, and *mons*, mountain.] Lying or being beyond the mountain; foreign; barbarous. The Italian painters apply this epithet to all such as live north of the Alps, as in Germany and France; and a north wind is called a *tramontane* wind. The French lawyers call certain Italian canonists *tramontane* or *ultramontane* doctors; considering them as favouring too much the court of Rome.

**TRAMP**, *n.* Travel on foot; a walk; a journey.—2. A trumper; a beggar; a vagrant; a stroller. [All trivial.]—3. An instrument used in making hedges.

**TRAMP**, *v. t.* [Sw. *trampa*.] To tread.

**TRAMP**, *v. i.* To travel; to wander or stroll; to travel on foot. [Colloq.]

**TRAMPER**, *n.* A stroller; a vagrant or vagabond.

**TRAMPLE**, *v. t.* [G. *trampeln*, *trampen*; Dan. *trampen*; Sw. *trampa*. If *m* is casual, as we suppose, these words are the D. *trappen*, to tread; *trap*, a step.] 1. To tread under foot; especially, to tread upon with pride, contempt, triumph, or scorn.

Neither cast ye your pearls before swine, lest they *trample* them under their feet; *Matth. vii.*

2. To tread down; to prostrate by treading; as, to *trample* grass.—3. To treat with pride, contempt, and insult.

**TRAMPLE**, *v. i.* To tread in contempt. *Diogenes trampled* on Plato's pride with greater of his own. *Gov. of the Tongue.*

2. To tread with force and rapidity.

**TRAMPLE**, *n.* The act of treading under foot with contempt.

**TRAMPLED**, *pp.* Trod on; trodden under foot.

**TRAMPLER**, *n.* One that tramples; one that treads down.

**TRAMPLING**, *ppr.* Treading under foot; prostrating by treading; treading with contempt and insult.

**TRAM-ROAD**, } n. A plate railway;

**TRAM-WAY**, } a road prepared for

the easy transit of *trams* or waggons, by forming the wheel tracks of smooth

beams of wood, blocks of stone, or plates of iron. It may be considered a species of railway adapted for the passage of carriages or waggons with wheels of the ordinary form. [See TRAMS, RAILWAY.]

**TRAMS**, *n.* A local name given to coal waggons which are used in the collieries, in the North of England, for conveying the coals from the pits to the place of shipment. Hence, the roads formed for such waggons to run on were termed *tram-roads* or *tramways*.

**TRANA'TION**, *n.* [L. *trano*.] The act of passing over by swimming.

**TRANÇE**, *n.* (trans.) [Fr. *transe*; supposed to be from the L. *transitus*, a passing over; *transeo*, to pass over; *trans* and *eo*. The L. *trans* seems to be the W. *tra*, It. *tra* and *tras*, Sp. *tras*, and Fr. *tres*, very; so that it may be inferred that *n* is not radical.] 1. An ecstasy; a state in which the soul seems to have passed out of the body into celestial regions, or to be rapt into visions. My soul was ravished quite as in a *trançe*. *Spenser*.

While they made ready, he fell into a *trançe*, and saw heaven opened; *Acts x.*

2. In *med.*, *cataplexy*, *i. e.* total suspension of mental power and voluntary motion, pulsation and breathing continuing; muscles flexible; body yielding to and retaining any given position not incompatible with the laws of gravitation. *Trançe*, or *cataplexy*, differs from *ecstasy* in the circumstance that in the latter the muscles are rigid, and the body erect and inflexible.

**TRANÇED**, *a.* Lying in a trançe.

And there I left him *trançèd*. *Shak.*

**TRAN'GRAM**, *n.* An odd thing intricately contrived.

**TRAN'KEY**, *n.* A kind of boat used in the Persian gulf.

**TRAN'NEL**, *n.* A treuil or treenail.

**TRAN'QUIL**, *a.* [Fr. *tranquille*; L. *tranquillus*.] Quiet; calm; undisturbed; peaceful; not agitated. The atmosphere is *tranquil*. The state is *tranquil*. A *tranquil* retirement is desirable; but a *tranquil* mind is essential to happiness.

**TRANQUILLITY**, *n.* [L. *tranquillitas*.] Quietness; a calm state; freedom from disturbance or agitation. We speak of the *tranquillity* of public affairs, of the state of the world, the *tranquillity* of a retired life, the *tranquillity* of mind proceeding from conscious rectitude.

**TRANQUILLIZA'TION**, *n.* The act of tranquillizing, or state of being tranquillized.

**TRANQUILLIZE**, *v. t.* To quiet; to allay when agitated; to compose; to make calm and peaceful; as, to *tranquillize* a state disturbed by factions or civil commotions; to *tranquillize* the mind.

Religion haunts the imagination of the sinner, instead of *tranquillizing* his heart.

*Rob. Hall*.

**TRAN'QUILLIZED**, *pp.* Quieted; calmed; composed.

**TRAN'QUILLIZER**, *n.* A kind of chair, in which a raving maniac may be so fixed as to be motionless. It is used for the production of tranquillity, in a paroxysm of raving.

**TRAN'QUILLIZING**, *ppr.* Quieting; composing.

**TRANQUILLIZINGLY**, *adv.* So as to tranquillize.

TRAN'QUILLY, *adv.* Quietly; peacefully.

TRAN'QUILNESS, *n.* Quietness; peacefulness.

TRANS, a Latin preposition, used in English as a prefix, signifies *over, across, beyond*, as in *transalpine*, beyond the Alps; *through*, as in *transpierce*. Hence, in a moral sense, it denotes a complete change; as to *transform*: also, *from one to another*, as to *transfer*.

TRANSACTION, *v. t.* [L. *transactus*, *transigo*; *trans* and *ago*, to act or drive through.] To do; to perform; to manage; as, to *transact* commercial business. We *transact* business in person or by an agent.

TRANSACTION, *v. i.* To conduct matters: to treat; to manage.

TRANSACTIONED, *pp.* Done; performed; managed.

TRANSACTIONING, *ppr.* Managing; performing.

TRANSACTION, *n.* The doing or performing of any business; management of any affair.—2. That which is done; an affair. We are not to expect in history a minute detail of every *transaction*.—3. In the *civil law*, an adjustment of a dispute between parties by mutual agreement.—*Philosophical transactions*, the published volumes containing the several papers relating to the sciences, which have been read at the meetings of certain philosophical societies, as the Royal Society of London, and the Royal Society of Edinburgh, and which have been thought worthy of being made public at the expense of such societies. These transactions contain the several discoveries and histories relative to the sciences, such as natural history, mathematics, mechanical philosophy, chemistry, &c., either made by the members themselves, or communicated by them from their correspondents, with the various experiments, observations, &c., made by them or transmitted to them.

TRANSACTIONER, *n.* One who performs or conducts any business.

TRANSALPINE, *a.* [L. *trans*, beyond, and *Alpine*, of the Alps.] Lying or being beyond the Alps in regard to Rome, that is, on the north or west of the Alps; as, *Transalpine* Gaul; opposed to *Cisalpine*.

TRANSANIMATE, *v. t.* [*trans* and *animate*.] To animate by the conveyance of a soul to another body.

TRANSANIMATED, *pp.* Animated by the conveyance of the soul from one body to another.

TRANSANIMATION, *n.* [L. *trans* and *anima*.] Conveyance of the soul from one body to another; transmigration. [*The latter is the word generally used.*]

TRANSATLANTIC, *a.* [L. *trans*, beyond, and *Atlantic*.] Lying or being beyond the *Atlantic*. When used by a person in Europe or Africa, *transatlantic* signifies being in America; when by a person in America, it denotes being or lying in Europe or Africa.

TRANSCALENCY, *n.* [L. *transcaleo*.] State of being transcendent.

TRANSCALENT, *a.* Pervious to heat.

TRANSCEND, *v. t.* [L. *transcendo*; *trans* and *scando*, to climb.]—1. To rise above; to surmount; as, lights in the heavens *transcending* the region of the clouds.—2. To pass over; to go beyond.

It is a dangerous opinion to such hopes as shall *transcend* their limits. *Bacon.*

3. To surpass; to outgo; to excel; to exceed.

How much her worth *transcended* all her kind. *Dryden.*

TRANSCEND, *† v. i.* To climb; to surpass thought.

TRANSCENDED, *pp.* Overpassed; surpassed, exceeded.

TRANSCENDENCE, } *n.* Superior  
TRANSCENDENCY, } excellence;  
super-eminence.—2. Elevation above truth; exaggeration.

TRANSCENDENT, *a.* [L. *transcendens*.] Very excellent; superior or supreme excellence; surpassing others; as, *transcendent* worth; *transcendent* valour.

Clothed with *transcendent* brightness. *Milton.*

2. In the *philosophy of Kant*, transcending or going beyond the bounds of human knowledge, going beyond the limits of human reason, of possible experience, and of philosophizing, applied to baseless or illusory knowledge.

TRANSCENDENTAL, *a.* Super-eminent; surpassing others; as *transcendental* being or qualities.—2. In the *Kantian philosophy*, pertaining to that which transcends or goes beyond the limits of actual experience. The term, however, as distinguished from *transcendent*, is applied to that which does not indeed originate from experience, but yet is connected with it, because it contains the grounds of the possibility of experience. "I call," says Kant, "all knowledge *transcendental*, which occupies itself not so much with objects as with the way of knowing these objects, as far as this is possible *à priori*. A system of such notions would be called *transcendental philosophy*, and would be the system of all the principles of pure reason;" or, as he says in another passage, "the pure, merely speculative reason from which the practical is separated."—In *math.*, a term applied to any equation, curve, or quantity which cannot be represented or defined by an algebraical equation of a finite number of terms, with numeral and determinate indexes. *Transcendental* quantities include all exponential, logarithmic, and trigonometrical lines, because there is no finite algebraical formula by which these quantities can be expressed.—*Transcendental equation* is an equation into which transcendental quantities enter. But *transcendental* equations sometimes signify such differential equations as can only be integrated by means of some curve, logarithm, or infinite series.—*Transcendental curve* is such as cannot be defined by any algebraic equation, or of which, when it is expressed by an equation, one of the terms is a variable quantity.

TRANSCENDENTALISM, *n.* In the *Kantian philosophy*, the transcending or going beyond empiricism, and ascertaining *à priori*, the fundamental principles of human knowledge. But, according to Schelling and Hegel, who reject Kant's distinction between *transcendent* and *transcendental* ideas, transcendentalism is that which aims at a true knowledge of all things, material and immaterial, human and divine, so far as the mind is capable of knowing them. And in this sense the term *transcendentalism* is now most used. Sometimes it is also used for that which is vague and illusive in philosophy.

TRANSCENDENTALIST, *n.* One who believes in transcendentalism.

TRANSCENDENTALITY, *n.* The quality of being transcendental. [*Rare.*] TRANSCENDENTALLY, *adv.* In a transcendental manner.

TRANSCENDENTLY, *adv.* Very excellently; super-eminently; by way of eminence.

The law of Christianity is eminently and *transcendently* called the word of truth. *South.*

TRANSCENDENTNESS, *n.* Superior or unusual excellence.

TRANSCENDING, *ppr.* Rising above; surmounting; surpassing.

TRANSCENSION, *† n.* Act of transcending.

TRANSCOLATE, *v. t.* [L. *trans* and *colo*, to strain.] To strain; to cause to pass through a sieve or colander.

TRANSCOLATING, *ppr.* Straining through a sieve.

TRANSCORPORATE, *† v. i.* To pass from one body to another.

TRANSCRIBER, *n.* One who transcribes. [*In contempt.*]—2. A plagiarist.

TRANSCRIBE, *v. t.* [L. *transcribo*; *trans*, over, and *scribo*, to write.]—To copy; to write over again or in the same words; to write a copy of anything; as, to *transcribe* Livy or Tacitus; to *transcribe* a letter.

TRANSCRIBED, *pp.* Copied.

TRANSCRIBER, *n.* A copier; one who writes from a copy.

TRANSCRIBING, *ppr.* Writing from a copy; writing a copy.

TRANSCRIPT, *n.* [L. *transcriptum*.]—1. A copy; a writing made from and according to an original; a writing or composition consisting of the same words with the original.

The decalogue of Moses was but a *transcript*, not an original. *South.*  
2. A copy of any kind.

The Roman learning was a *transcript* of the Grecian. *Glanville.*

TRANSCRIPTION, *n.* [Fr.] The act of copying. Corruptions creep into books by repeated *transcriptions*.

TRANSCRIPTIVELY, *adv.* In manner of a copy.

TRANSCUR, *† v. i.* [L. *transcurro*; *trans* and *curro*, to run.] To run or rove to and fro.

TRANSCURRENCE, *† n.* A roving hither and thither.

TRANSCURSION, *n.* [supra.] A rambling or ramble; a passage beyond certain limits; extraordinary deviation; as, the *transcursion* of a comet.

I am to make often *transcursions* into the neighbouring forests as I pass along. *Howell.*

[*Excursion* has in a great measure superseded this word.]

TRANSDUCTION, *n.* [L. *trans* and *duco*.] The act of carrying over.

TRANSE, *n.* Ecstasy. [See *TRANCE*.]

TRANSELEMENTATION, *n.* [*trans* and *element*.] The change of the elements of one body into those of another, as of the bread and wine into the actual body and blood of Christ; transubstantiation.

TRANSEPT, *n.* [L. *trans* and *septum*.] In *arch.*, the transverse portion of a church which is built in the form of a cross; that part which is placed between the nave and choir, and extends beyond the sides of the area which contains these divisions, forming the short arms of the cross, upon which the plan is laid out.

TRANSEXION, *† n.* Change of sex.

**TRANSFER**, *v. t.* [*L. transfero; trans* and *fero*, to carry.] 1. To convey from one place or person to another; to transport or remove to another place or person; as, to *transfer* the laws of one country to another. We say, a war is *transferred* from France to Germany. Pain, or the seat of disease in the body, is often *transferred* from one part to another. Engravings and lithographs are *transferred* from paper to wood or other material. Electricity is *transferred* from an electric to a non-electric or conducting substance, and from one conducting substance to another. Chemical substances may be *transferred* from one vessel to another by galvanic action.—2. To make over; to pass; to convey, as a right, from one person to another; to sell; to give. The title to land is *transferred* by deed. The property of a bill of exchange may be *transferred* by indorsement. Stocks are *transferred* by assignment, or entering the same under the name of the purchaser in the proper books.

**TRANSFER**, *n.* The removal or conveyance of a thing from one place or person to another.—2. The conveyance of right, title, or property, either real or personal, from one person to another, either by sale, by gift, or otherwise.—*Transfer*, in *Eng. law*, corresponds to *conveyance*, in *Scots law*, but the particular forms and modes included under the former term, differ very materially from those included under the latter. [See CONVEYANCE, CONVEYANCING.] Of late years various statutes have been passed for the purpose of facilitating the transfer of real property.

**TRANSFERABILITY**, *n.* Quality of being transferable.

**TRANSFERABLE**, *a.* That may be transferred or conveyed from one place or person to another.—2. Negotiable, as a note, bill of exchange, or other evidence of property, that may be conveyed from one person to another by indorsement or other writing. The stocks of the public and of companies are *transferable*.

**TRANSFERRED**, *pp.* Conveyed from one to another.

**TRANSFERREE**, *n.* The person to whom a transfer is made.

**TRANSFERRENCE**, } *n.* The act of  
**TRANSFERENCE**, } transferring;  
the act of conveying from one place, person, or thing, to another; the passage of any thing from one place to another, as the *transference* of electricity from one conducting body to another; the *transference* of chemical substances from one vessel to another by the agency of voltaic electricity.—2. In *Scots law*, that step by which a depending action is transferred from a person deceased to his representatives.

**TRANSFERER**, *n.* One who makes a transfer or conveyance.

**TRANSFERIBILITY**. See **TRANSFERABILITY**.

**TRANSFERIBLE**, *a.* See **TRANSFERABLE**.

**TRANSFERRING**, *pp.* Removing from one place or person to another; conveying to another, as a right.

**TRANSFERRING**, *n.* The act of conveying or removing from one place or person to another, as the *transferring* of lithographic prints or copperplate engravings from paper to wood or other material.—2. The act of conveying to another as a right.

**TRANSFIGURATION**, *n.* [*Fr. See*

**TRANSFIGURE**.] A change of form; particularly, the supernatural change in the personal appearance of our Saviour on the mount. See *Matt. xvii.*—2. A feast held by the Romish church on the 6th of August, in commemoration of the miraculous change above mentioned.

**TRANSFIGURE**, *v. t.* [*L. trans* and *figura; Fr. transfigurer.*] To transform; to change the outward form or appearance.

And was *transfigured* before them; *Matt. xvii.*

**TRANSFIGURED**, *pp.* Changed in form.

**TRANSFIGURING**, *pp.* Transforming; changing the external form.

**TRANSFIGURE**, *v. t.* [*L. transfixus, transfigo; trans* and *figo.*]—To pierce through, as with a pointed weapon; as, to *transfix* one with a dart or spear.

**TRANSFIXED**, *pp.* Pierced through.

**TRANSFIXING**, *pp.* Piercing through with a pointed weapon.

**TRANSFIXION**, *n.* The act of piercing through.

**TRANSFLUENT**, *a.* In *her.* a term used to express water appearing in a coat, as if running through a bridge.

**TRANSFORATE**, *v. t.* [*L. transforo.*] To bore through.

**TRANSFORATED**, *pp.* Pierced; perforated.

**TRANSFORATING**, *pp.* Boring through.

**TRANSFORM**, *v. t.* [*Fr. transformer; L. trans* and *forma.*]—1. To change the form of; to change the shape or appearance; to metamorphose; as, a caterpillar transformed into a butterfly.—2. To change one substance into another; to transmute. The alchemists sought to *transform* lead into gold.—3. In *theol.*, to change the natural disposition and temper of man from a state of enmity to God and his law, into the image of God, or into a disposition and temper conformed to the will of God.

Be ye *transformed* by the renewing of your mind; *Rom. xii.*

4. In the *Romish church*, to change the elements, bread and wine, into the flesh and blood of Christ.—5. Among the *mystics*, to change the contemplative soul into a divine substance, by which it is lost or swallowed up in the divine nature.—6. In *alge.*, to change an equation into another of a different form, but of equal value. [See **TRANSFORMATION**, No. 7.]

**TRANSFORM**, *v. i.* To be changed in form; to be metamorphosed.

His hair *transforms* to down. *Addison.*

**TRANSFORMATION**, *n.* The act or operation of changing the form or external appearance.—2. Metamorphosis; change of form in insects; as, from a caterpillar to a butterfly.—3. Transmutation; the change of one metal into another, as of copper or tin into gold. 4. The change of the soul into a divine substance; as, among the mystics.—5. Transubstantiation.—6. In *theol.*, a change of heart in man, by which his disposition and temper are conformed to the divine image; a change from enmity to holiness and love.—7. In *math.*, a change made in the object of a problem, or in the shape of a formula, in such a way that the original problem or formula is more easily solved, calculated, or used after the change.—In *alge.*, the *transformation* of an equation is the reducing it to an equation of a

different form, but of equal value, in order to facilitate the solution; as, when an equation is changed to another whose roots are greater or less than the roots of the proposed equation, or some multiple or quotient of them.—8. In *pathol.*, a morbid change in a part, which consists in the conversion of its texture into one which is natural to some other part; as, when soft parts are converted into cartilage or bone.

**TRANSFORMATIVE**, *a.* Having power or a tendency to transform.

**TRANSFORMED**, *pp.* or *a.* Changed in form or external appearance; metamorphosed; transmuted; renewed.

**TRANSFORMING**, *pp.* Changing the form or external appearance; metamorphosing; transmuting; renewing.—2. *a.* Effecting or able to effect a change of form or state; as, the *transforming* power of true religion.

**TRANSFRETIGHT**, *v. i.* (*transfretate*.) To pass over the sea.

**TRANSFRETATION**, *n.* [*L. trans* and *fretum*, a strait.] The passing over a strait or narrow sea. [*Little used.*]

**TRANSFUND**, *v. t.* [*L. transfundo.*] To pour from one vessel into another.

**TRANSFUND**, *pp.* Transfused.

**TRANSFUNDING**, *pp.* Transfusing.

**TRANSFUSE**, *v. t.* (*transfuze*.) [*Lat. transfusus, transfundo; trans* and *fun-do.*]—1. To pour, as liquor, out of one vessel into another.—2. To transfer, as blood from one animal to another.—3. To cause to pass from one to another; to cause to be instilled or imbibed; as, to *transfuse* a spirit of patriotism from one to another; to *transfuse* a love of letters.

**TRANSFUSED**, *pp.* or *a.* Poured from one vessel into another.

**TRANSFUSIBLE**, *a.* That may be transfused, &c.

**TRANSFUSING**, *pp.* Pouring out of one vessel into another; transferring.

**TRANSFUSION**, *n.* (*transfu'zion*.) The act of pouring, as liquor, out of one vessel into another. In *chem.* and *phar.* *transfusions* of liquors are frequent.—2. The act or operation of transferring the blood of one animal into the vascular system of another by means of a tube. This operation was long used in the hope that by injecting the blood of a healthy man or animal into the vessels of a diseased one, the health of the latter would be restored, but the attempt only proved mischievous. It has been found, however, that the injection of blood from the veins of a healthy person into the vessels of another person sinking from the effects of hæmorrhage, or great loss of blood, has been attended in various instances with the most beneficial effects.

**TRANSGRESS**, *v. t.* [*Fr. transgresser; L. transgressus, transgredior; trans* and *gradior*, to pass.]—1. To pass over or beyond any limit; to surpass.—2. In a *moral sense*, to overpass any rule prescribed as the limit of duty; to break or violate a law, civil or moral. To *transgress* a divine law, is sin. Legislators should not *transgress* laws of their own making.

**TRANSGRESS**, *v. i.* To offend by violating a law; to sin. 1 Chron. ii.

**TRANSGRESSED**, *pp.* Overpassed; violated.

**TRANSGRESSING**, *pp.* Passing beyond; surpassing; violating; sinning.

**TRANSGRESSION**, *n.* [*Fr.*] The act of passing over or beyond any law or rule of moral duty; the violation of a

law or known principle of rectitude; breach of command.

He mourned because of the *transgression* of them that had been carried away. *Ezra x.*

Forgive thy people all their *transgressions*; 1 Kings viii.

2. Fault; offence; crime.

TRANSGRESS'IONAL, *a.* That violates a law or rule of duty.

TRANSGRESS'IVE, *a.* Faulty; culpable; apt to transgress.

TRANSGRESS'IVELY, *adv.* By transgressing.

TRANSGRESS'OR, *n.* One who breaks a law or violates a command; one who violates any known rule or principle of rectitude; a sinner.

The way of *transgressors* is hard; *Prov. xiii.*

TRANSHIP', *v. t.* [*trans* and *ship*.] To convey from one ship to another; a commercial word.

TRANSHIP'MENT, *n.* The act of transferring, as goods, from one ship to another.

TRANSHIP'PED, *pp.* Carried from one ship to another.

TRANSHIP'PING, *ppr.* Carrying from one ship to another.

TRANS'ENCY, *n.* Transientness.

TRANSIENT, *a.* (*tran'shent*.) [*L. transiens, transeo; trans* and *eo*.] 1. Passing; not stationary; hence, of short duration; not permanent; not lasting or durable. How *transient* are the pleasures of this life!

Measur'd this *transient* world. *Milton.*

2. Hasty; momentary; imperfect; as, a *transient* view of a landscape.—*Transient* person, a person that is passing or travelling through a place; one without a settled habitation.—*Transient* effect, in *painting*, is a representation of appearances in nature produced by causes that are not stationary, as the shadows cast by a passing cloud. The term accidents has often the same signification.—*Transient* ship, a vessel not belonging to a line of packets; as, we had that news, by a *transient* ship, four days in advance. [*Both this, and the term transient person, are confined to American use.*]

TRAN'SIENTLY, *adv.* [*supra*.] In passage; for a short time; not with continuance.

I touch here but *transiently*...on some few of those many rules of imitating nature, which Aristotle drew from Homer. *Dryden.*

TRAN'SIENTNESS, *n.* [*supra*.] Shortness of continuance; speedy passage.

TRANSIL'ENCE, } *n.* [*L. transiliens,*

TRANSIL'ENCY, } *transilio; trans*

and *salio*.] A leap from thing to thing.

[*Not much used.*]

TRANSIRE, *n.* [*L.*] A custom-house warrant, giving free passage for goods to a place; a permit.

TRANSIT, *n.* [*L. transitus, from transeo*.] 1. A passing; a passing over or through; conveyance; as, the *transit* of goods through a country.—2. In *astron.*, the passage of a heavenly body across the meridian of any place. The determination of the exact times of the transits of the heavenly bodies across the meridian of the place of observation enables the astronomer to ascertain the differences of right ascensions, and the relative situations of the fixed stars, and the motions of the sun, planets, and comets, in respect of the celestial meridians.—3. The passage of one heavenly body over the disc of a larger one. But the term is chiefly

restricted to the passage of the inferior planets, Mercury and Venus, over the sun's disc. The transits of Venus are of great importance in astronomy, as they afford the best means of determining the sun's parallax, and consequently the dimensions of the planetary system. These transits are of rare occurrence. The last one took place June 3, 1769, and the next will happen December 8, 1874. The transits of Mercury occur more frequently, but they are comparatively useless, from the difficulty of observation.

TRANSIT, *v. t.* To pass over the disc of a heavenly body.

TRANSIT-DUTY, *n.* A duty paid on goods that pass through a country.

TRANSIT'ED, *pp.* Passed over the disc of a heavenly body.

TRANSIT INSTRUMENT, *n.* An important astronomical instrument, which consists essentially of a telescope fixed at right angles to a horizontal axis, having its ends directed to the east and west points of the horizon, so that the line of collimation of the telescope may move in the plane of the meridian. The instrument is susceptible of certain nice adjustments, so that the axis can be made perfectly horizontal, and at right angles to the plane of the meridian, in which plane the telescope must move. The principal use of the transit instrument is to determine the exact moment when a celestial body passes the meridian of the place of observation. [*See TRANSIT.*]

TRANSIT'ION, *n.* (*transizh'on*.) [*L. transitio*.] 1. Passage from one place or state to another; change; as, the *transit* of the weather from hot to cold. Sudden *transitions* are sometimes attended with evil effects.

The spots are of the same colour throughout, there being an immediate *transition* from white to black. *Woodward.*

2. In *rhet.*, a passing from one subject to another. This should be done by means of some connection in the parts of the discourse, so as to appear natural and easy.

He with *transition* sweet new speech resumes. *Milton.*

3. In *music*, a change of key from major to minor, or the contrary; or in short, a change from any one genus or key to another; also, the softening of a disjunct interval by the introduction of intermediate sounds.—*Transition rocks, transition series, or transition formations*, in *geol.*, names formerly given to the older secondary rocks, or to the lowest uncrystalline stratified rocks, erroneously supposed to contain no organic remains, and so named because they were considered to have been formed when the world was passing from an uninhabitable to a habitable state. The term *transition*, however, is no longer applicable in its original signification; and, accordingly, modern geologists include within the tertiary series all kinds of stratified rocks, from the earliest slates, in which we find the first traces of animal and vegetable remains, to the termination of the great coal formation. [*See STRATA.*]

TRANSIT'IONAL, } *a.* Containing

TRANSIT'IONARY, } or denoting

transition.

TRANSITIVE, *a.* Having the power of passing.—2. In *gram.*, a transitive verb is one which is or may be followed by an object; a verb expressing an action which passes from the agent to

an object, from the subject which *does*, to the object on which it is *done*. Thus, "*Cicero wrote* letters to Atticus." In this sentence, the act of writing, performed by Cicero, the agent, terminates on letters, the object. All verbs not passive, may be arranged in two classes, *transitive* and *intransitive*. In *Engl.*, this division is correct and complete.

TRANSIT'IVELY, *adv.* In a transitive manner.

TRANSIT'IVENESS, *n.* State of being transitive.

TRANSIT'ORILY, *adv.* [*See TRANSITORY*.] With short continuance.

TRANSIT'ORINESS, *n.* A passing with short continuance; speedy departure or evanescence. Who is not convinced of the *transitoriness* of all sub-lunary happiness?

TRANSITORY, *a.* [*L. transitorius*.] 1. Passing without continuance; continuing a short time; fleeting; speedily vanishing.

O Lord, comfort and succour all them who, in this *transitory* life, are in trouble.

*Com. Prayer*

2. In *law*, a transitory action is one which may be brought in any county, as actions for debt, detinue, slander, and the like. It is opposed to *local*.

TRANSIT TRADE, *n.* In *com.*, the trade which arises from the passage of goods through one country to another.

TRANSLA'TABLE, *a.* [*from translate*.] Capable of being translated or rendered into another language.

TRANSLATE, *v. t.* [*L. translatus, from transfero; trans, over, and fero, to bear; Sp. trasladar; It. traslatore*.] 1. To bear, carry, or remove from one place to another. It is applied to the removal of a bishop from one see to another; and in Scotland, to the removal of a clergyman from one parish or one congregation to another.

The bishop of Rochester, when the king would have *translated* him to a better bishoprick, refused. *Camden.*

2. To remove or convey to heaven, as a human being, without death.

By faith, Enoch was *translated*, that he should not see death; *Heb. xvi.*

3. To transfer; to convey from one to another; 2 Sam. iii.—4. To cause to remove from one part of the body to another; as, to *translate* a disease.—

5. To change.

Happy is your grace,

That can *translate* the stubbornness of fortune

Into so quiet and so sweet a style. *Shak.*

6. To interpret; to render into another language; to express the sense of one language in the words of another. The Old Testament was *translated* into the Greek language more than two hundred years before Christ. The Scriptures are now *translated* into most of the languages of Europe and Asia.—7. To explain.

TRANSLATED, *pp.* or *a.* Conveyed from one place to another; removed to heaven without dying; rendered into another language.

TRANSLATING, *ppr.* Conveying or removing from one place to another; conveying to heaven without dying; interpreting in another language.

TRANSLA'TION, *n.* [*Fr. from L. translatio*.] 1. The act of removing or conveying from one place to another; removal; as, the *translation* of a disease from the foot to the breast.—2. The removal of a bishop from one



see to another; and in Scotland, the removal of a clergyman from one parish or one congregation to another.—3. The removal of a person to heaven without subjecting him to death.—4. The act of turning into another language; interpretation; as, the *translation* of Virgil or Homer.—5. That which is produced by turning into another language; a version. We have a good *translation* of the scriptures.—*Motion of translation*, in *mech.*, a body is said to have motion of translation, when all its points move in parallel straight lines, or when all its points move with the same velocity. The motion of a single point considered by itself must always be that of translation. When all the points of a moving body have not the same motion, it must either move about a permanent or varying axis, or else its motion must be a compound of translation and rotation.

**TRANSLATI'VE**, *a.* Transposed; transported.

**TRANSLA'TIVE**, *a.* Taken from others.

**TRANSLA'TOR**, *n.* One who renders into another language; one who expresses the sense of words in one language by equivalent words in another.

**TRANSLATORY**, *a.* Transferring; **TRANSLA'TORY**, *a.* serving to translate.

**TRANSLA'TRESS**, *n.* A female translator.

**TRANSLOCA'TION**, *n.* [*L. trans* and *locatio, loco.*] Removal of things reciprocally to each others' places; or rather substitution of one thing for another.

There happened certain *translocations* of animal and vegetable substances at the deluge. *Woodward.*

**TRANSLU'CENCE**, *n.* [*L. translucere, trans*, through, and *lucere*, to shine.] 1. In *min.*, the property of admitting rays of light to pass through, but not so as to render objects distinguishable.—2. Transparency.

**TRANSLU'CENT**, *a.* In *min.*, transmitting rays of light, but not so as to render objects distinctly visible.—2. Transparent; clear.

Replenish'd from the cool *translucent* springs. *Pope.*

**TRANSLU'CENTLY**, *adv.* In a translucent manner.

**TRANSLU'CID**, *a.* [*L. translucidus*, supra.] Transparent; clear. [*See TRANSLUCENT.*]

**TRANSLUN'ARY**, *† a.* [*trans* and *luna.*] Being beyond the moon.

**TRANSMARINE**, *a.* [*L. transmarinus*; *trans* and *marinus*; *mare*, sea.] Lying or being beyond the sea.

**TRANSM'EATE**, *v. t.* [*L. trans*, and *meo*, to pass; to flow.] To pass over or beyond. [*Little used.*]

**TRANSMEW'**, *† v. t.* [*Fr. transmuer*; *L. transmuto.*] To transmute; to transform; to metamorphose.

**TRANSMIGRANT**, *a.* [*See TRANSMIGRATE.*] Migrating; passing into another country or state for residence, or into another form or body.

**TRANSMIGRANT**, *n.* One who migrates or leaves his own country and passes into another for settlement.—2. One who passes into another state or body.

**TRANSMIGRATE**, *v. i.* [*L. transmigro*; *trans* and *migro*, to migrate.] 1. To migrate; to pass from one coun-

try or jurisdiction to another for the purpose of residing in it; as men or families.—2. To pass from one body into another.

Their souls may *transmigrate* into each other. *Howell.*

**TRANSMIGRATING**, *ppr.* Passing from one country, state, or body into another.

**TRANSMIGRA'TION**, *n.* The passing of men from one country to another for the purpose of residence, particularly of a whole people.—2. The passing of a thing into another state, as of one substance into another.—3. The passing of the soul into another body, according to the opinion of Pythagoras; metempsychosis,—*which see.*

**TRANS MIGRATOR**, *n.* One who transmigrates.

**TRANSMIGRATORY**, *a.* Passing from one place, body, or state to another.

**TRANSMISSIBIL'ITY**, *n.* [*from transmissibile.*] The quality of being transmissible.

**TRANSMIS'SIBLE**, *a.* [*See TRANSMIR.*] That may be transmitted or passed from one to another.—2. That may be transmitted through a transparent body.

**TRANSMIS'SION**, *n.* [*Fr. from L. transmissio.*] 1. The act of sending from one place or person to another; as, the *transmission* of letters, writings, papers, news, and the like, from one country to another; or the *transmission* of rights, titles, or privileges from father to son, and from one generation to another.—2. The passing of a substance through any body, as of light, through glass or other transparent body.

**TRANSMIS'SIVE**, *a.* Transmitted; derived from one to another.

Itself a sun, it with *transmissive* light Enlivens worlds denied to human sight. *Prior.*

**TRANSMIT**, *v. t.* [*L. transmittit*; *trans* and *mitto*, to send.] 1. To send from one person or place to another; as, to *transmit* a letter or a memorial; to *transmit* dispatches; to *transmit* money or bills of exchange from one city or country to another. Light is *transmitted* from the sun to the earth; sound is *transmitted* by means of vibrations of the air. Our civil and religious privileges have been *transmitted* to us from our ancestors; and it is our duty to *transmit* them to our children.—2. To suffer to pass through; as, glass *transmits* light; metals *transmit* electricity.

**TRANSMIT'TAL**, *n.* Transmission.

**TRANSMIT'TED**, *pp.* Sent from one person or place to another; caused or suffered to pass through.

**TRANSMIT'TER**, *n.* One who transmits.

**TRANSMIT'TIBLE**, *† a.* Transmissible.

**TRANSMIT'TING**, *ppr.* Sending from one person or place to another; suffering to pass through.

**TRANSMOGRIFICATION**, *n.* The act of transmogrifying, or transforming. [*Low.*]

**TRANSMOGRIFY**, *v. t.* To transform. [*A ludicrous and low word.*]

**TRANSMUTABIL'ITY**, *n.* [*See TRANSMUTE.*] Susceptibility of change into another nature or substance.

**TRANSMU'TABLE**, *a.* [*from transmute.*] Capable of being changed into

a different substance, or into something of a different form or nature.

The fluids and solids of an animal body are *transmutable* into one another.

*Arbuthnot.*

**TRANSMUT'ABLENESS**, *n.* Quality of being transmutable; transmutability.

**TRANSMU'TABLY**, *adv.* With capacity of being changed into another substance or nature.

**TRANSMUTA'TION**, *n.* [*L. transmutatio.*] 1. The change of any thing into another substance, or into something of a different nature. For a long time, the *transmutation* of base metals into gold or silver was deemed practicable, but nature proved refractory, and the alchemists were frustrated.—2. In *geom.*, the change or reduction of one figure or body into another of the same area or solidity, but of a different form; as of a triangle into a square.—3. The change of colours, as in the case of a decoction of the nephritic wood.—4. In the *vegetable economy*, the change of a plant into another form; as of wheat into chess, according to the popular opinion. [*See CHESS.*]

**TRANSMUTA'TIONIST**, *n.* One who believes in the transmutation of metals.

**TRANSMUTE**, *v. t.* [*L. transmuto*; *trans* and *muto*, to change.] To change from one nature or substance into another. Water may be *transmuted* into ice, and ice into water; the juices of plants are *transmuted* into solid substances; but human skill has not been able to *transmute* lead or copper into gold.

A holy conscience sublimates every thing; it *transmutes* the common affairs of life into acts of solemn worship to God.

*J. M. Mason.*

The caresses of parents and the blandishments of friends, *transmute* us into idols.

*Buckminster.*

**TRANSMUTED**, *pp.* Changed into another substance or nature.

**TRANSMÜTER**, *n.* One that transmutes.

**TRANSMÜTING**, *ppr.* Changing or transforming into another nature or substance.

**TRANSMU'TUAL**, *a.* Reciprocally mutual.

**TRANSNATA'TION**, *† n.* Act of swimming over.

**TRANS'OM**, *n.* [*L. transenna*, from *trans*, over, across.] 1. In *ships*, transoms are beams or timbers fixed across the stern-post of the ship, to strengthen the after-part, and give it the figure

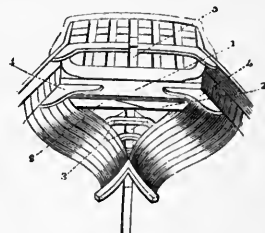

Frame of Ship, inside of Stern.

1. Main transom. 2. Half transoms. 3. Transom. 4. 4. Transom knees. 5. Stern post.

most suitable to the service for which she is calculated. Transoms are distinguished into the *helm-post transom*, which is at the head of the stern-post; *wing transom*, the next below, which

forms the lower part; and *deck transom*, that whereon all the lower deck planks are rebated. *Transom knees*, those crooked timbers which support the highest transoms of the ship's quarter.—2. In *arch*, a horizontal bar of stone or timber across a mullioned window, dividing it into stories; also, the cross-bar separating the door from the fanlight above it.—3. In *gunnery*, transoms are pieces of wood which join the cheeks of gun-carriages, whence the terms *transom plates*, *transom bolts*, &c.

**TRANSOM-WINDOW**, *n.* A window with a cross-piece.

**TRANSPADANE**, *a.* [L. *trans* and *Padus*, the river Po.] Being beyond the river Po.

**TRANSPARENCE**, *n.* [See TRANSPARENCY, } PARENT.] That state or property of a body by which it suffers rays of light to pass through it, so that objects can be distinctly seen through it; diaphaneity. This is a property of glass, water, and air, which, when clear, admit the free passage of light. This property is supposed to arise from the disposition of the particles which compose the transparent body. No substance, however, can be said to be perfectly transparent; that is, there is no substance which does not intercept some part of the light incident upon it, and the transparency of a substance, as water and glass, diminishes as its thickness or depth increases. On the other hand, all bodies possess transparency in some degree; the most dense metals, as gold, when rendered very thin, transmit light. Transparency is opposed to *opaqueness* or *opacity*.—2. A picture painted on semi-transparent materials, such as very thin cloth, silver, or tissue paper, or taffeta, and illuminated by light placed at the back, so that it may be exhibited at night.

**TRANSPARENT**, *a.* [Fr. *id.*; L. *trans* and *pareo*, to appear.] 1. Having the property of transmitting rays of light so that bodies can be distinctly seen through; pervious to light; diaphanous; pellucid; as, *transparent glass*; a *transparent diamond*; opposed to *opaque*.—2. Admitting the passage of light; open; porous; as, a *transparent veil*.—3. In *painting*, a term applied to those colours which are either light and aerial in their own nature, or become so by the delicate manner in which they are laid on by the painter. Rubens made his colours *transparent* by the use of varnish.

**TRANSPARENTLY**, *adv.* Clearly; so as to be seen through.

**TRANSPARENTNESS**, *n.* The quality of being transparent; transparency.

**TRANSPASS**, † *v. t.* [*trans* and *pass*.] To pass over.

**TRANSPASS**, † *v. i.* To pass by or away.

**TRANSPASS'ABLE**, † *a.* That may be crossed or passed over; as a stream, &c.

**TRANSPICUOUS**, *a.* [L. *trans* and *specio*, to see.] Transparent; pervious to the sight.

The wide *transpicuous* air. Milton.

**TRANSPIERCE**, *v. t.* [Fr. *transpercer*.] To pierce through; to penetrate; to permeate; to pass through.

His forceful spear the sides *transpiere*'d. Dryden.

**TRANSPIERCED**, *pp.* Pierced through; penetrated.

**TRANSPIERCING**, *ppr.* Penetrating; passing through.

**TRANSPYRABLE**, *a.* [Fr.; from *transpire*.] Capable of being emitted through pores.

**TRANSPIRA'TION**, *n.* [Fr.; from *transpire*.] The act or process of passing off through the excretories of the skin; cutaneous exhalation; as, the *transpiration* of obstructed fluids.

—*Pulmonary transpiration*, the exhalation of watery vapour which is constantly going on from the blood circulating through the lungs. It may be made evident by breathing on a cold reflecting surface.—2. In *bot.*, the exhalation of watery vapour from the surface of the leaves of plants. This exhalation consists of a great part of the water which served as the vehicle of the nutritious substances contained in the sap. Sometimes the water thus given out appears in the form of extremely small drops at the tip of the leaf, and especially at the extremities of the nerves.

**TRANSPIRE**, *v. t.* [Fr. *transpirer*; L. *transpiro*; *trans* and *spiro*.] To emit through the excretories of the skin; to send off in vapour.

**TRANSPIRE**, *v. i.* To be emitted through the excretories of the skin; to exhale; to pass off in insensible perspiration; as, fluids *transpire* through the human body.—2. To escape from secrecy; to become public. The proceedings of the council have not yet *transpired*.—3. To happen or come to pass.

**TRANSPIRED**, *pp.* Emitted through the excretories of the skin; exhaled.—2. Escaped from secrecy.

**TRANSPILING**, *ppr.* Exhaling; passing off in insensible perspiration; becoming public.

**TRANSP'ACE**, *v. t.* [*trans* and *place*.] To remove; to put in a new place.

It was *transplac'd* from the left side of the Vatican to a more eminent place.

[*Little used.*] Wilkins.

**TRANSP'ANT**, *v. t.* [Fr. *transplanter*; *trans* and *plant*, L. *planto*.] 1. To remove and plant in another place; as, to *transplant* trees.—2. To remove and settle or establish for residence in another place; as, to *transplant* inhabitants. Salmaneser *transplanted* the Cuthites to Samaria.—3. To remove.

**TRANSP'ANTA'TION**, *n.* The act of transplanting; the removal of a plant or of a settled inhabitant to a different place for growth or residence.—2. Removal; conveyance from one to another. Formerly men believed in the *transplantation* of diseases.

**TRANSP'ANT'ED**, *pp.* Removed and planted or settled in another place.

**TRANSP'AN'TER**, *n.* One who transplants.—2. A machine for transplanting trees.

**TRANSP'ANT'ING**, *ppr.* Removing and planting or settling in another place.

**TRANSP'ANT'ING**, *n.* The act of removing a plant or tree from one situation to another, in such a manner as not to interrupt or prevent its growth. The best seasons for transplanting are the winter, the end of autumn, or the beginning of spring, as plants at those seasons are generally in a dormant state.

**TRANSPLENDENCY**, *n.* [L. *trans* and *splendens*. See SPLENDOR.] Supereminent splendour.

**TRANSPLEND'ENT**, *a.* Resplendent in the highest degree.

**TRANSPLEND'ENTLY**, *adv.* With eminent splendour.

**TRANSP'ORT**, *v. t.* [L. *transporto*; *trans* and *porto*, to carry.] 1. To carry or convey from one place to another, either by means of beasts or vehicles on land, or by ships in water, or by balloons in air; as, to *transport* the baggage of an army; to *transport* goods from one country to another; to *transport* troops over a river.—2. To carry into banishment, as a criminal. Criminals are *transported* as a punishment for their crimes, which often amounts to banishment.—3. To hurry or carry away by violence of passion.

They laugh as if *transported* with some fit Of passion. Milton.

4. To ravish with pleasure; to bear away the soul in ecstasy; as, to be *transported* with joy.—5. To remove from one place to another, as a ship by means of hawsers and anchors.

**TRANSP'ORT**, *n.* Transportation; carriage; conveyance.

The Romans stipulated with the Carthaginians to furnish them with ships for *transport* and war. *Avbuthnot*.

2. A ship or vessel employed by government for carrying soldiers, warlike stores, or provisions from one place to another, or to convey convicts to the place of their destination.—3. Rapture; ecstasy. The news of victory was received with *transports* of joy.—4. A convict transported or sentenced to exile.

**TRANSP'ORTABILITY**, *n.* State of being transportable.

**TRANSP'ORTABLE**, *a.* That may be transported.

**TRANSP'ORTANCE**, † *n.* Conveyance.

**TRANSP'ORTA'TION**, *n.* The act of carrying or conveying from one place to another, either on beasts or on vehicles, by land or water, or in air. Goods in Asia are *transported* on camels; in Europe, either on beasts or on carriages or waggons, either along roads or railways. But *transportation* by water is the great means of commercial intercourse.—2. Banishment for felony; a statutab punishment for a great variety of offences. Almost all the felonies which were, before the 1st October, 1837, capital offences, are by the statutes passed I. Victoria, punishable by transportation for a period not exceeding 15 years, nor less than 10 years, or imprisonment for not exceeding three years.—3. Transmission; conveyance.—4. Transport; ecstasy. [*Little used.*]

5. Removal from one country to another; as, the *transportation* of plants.—*Transportation of a church*, in *Scots law*, is the erection of a parish church in a different part of the parish from that in which it formerly stood. The power of determining as to the transportation of churches is lodged in the court of session, as the commission of teinds, but the consent of three-fourths of the heritors, in point of valuation, is necessary to the removal, and any party having interest may oppose it.

**TRANSP'ORTED**, *pp.* Carried; conveyed; removed; ravished with delight.

**TRANSP'ORTEDLY**, *adv.* In a state of rapture.

**TRANSP'ORTEDNESS**, *n.* A state of rapture.

**TRANSPORTER**, *n.* One who transports or removes.

**TRANSPORTING**, *ppr.* Conveying or carrying from one place to another; removing; banishing for a crime.—2. *a.* Ravishing with delight; bearing away the soul in pleasure; ecstatic; as, *transporting joy*.

**TRANSPORTINGLY**, *adv.* Ravishingly.

**TRANSPORTMENT**, *n.* Transportation. [*Little used.*]

**TRANSPÓSAL**, *n.* (transpo'zal.) [from *transpose*.] The act of changing the places of things, and putting each in the place which was before occupied by the other.

**TRANSPÓSE**, *v. t.* (transpo'ze.) [Fr. *transposer*; *trans* and *poser*, to put.] 1. To change the place or order of things by putting each in the place of the other; as, to *transpose* letters, words, or propositions.—2. To put out of place.—3. In *alge.*, to bring any term of an equation over from one side to the other side. Thus, if  $a + b = c$ , and we make  $a = c - b$ , then  $b$  is said to be *transposed*.—4. In *gram.*, to change the natural order of words.—5. In *music*, to change the key.

**TRANSPÓSE**, *v. a.* In *typography*. [See **TRANSPRINT**.]

**TRANSPÓSED**, *pp.* Being changed in place and one put in the place of the other.—2. In *her.*, reversed, or turned contrary-wise from the usual or proper position; as, a pile *transposed*, or the like.

**TRANSPÓSING**, *ppr.* Changing the place of things and putting each in the place of the other.—2. Bringing any term of an equation over from one side to the other side.—3. Changing the natural order of words.

**TRANSPÓSING**, *a.* Having the quality of changeableness of place; as, the action of a *transposing* piano, whereby its keys can all be affected at once.

**TRANSPÓSI'TION**, *n.* [Fr. from *L. transpositio*.] 1. A changing of the places of things and putting each in the place before occupied by the other; as, the *transposition* of words in a sentence.—2. The state of being reciprocally changed in place.—3. In *alge.*, the bringing over of any term of an equation from one side to the other side. This is done by changing the sign of the term so transposed from *plus* to *minus* or from *minus* to *plus*, and the operation is in effect subtracting the term from both sides of the equation when its sign is plus, and adding it to both sides when its sign is minus. If  $a + x = b + c$ ; then, by transposing  $a$ , we get  $x = b + c - a$ . If again  $x - a = b + c$ ; then, by transposing  $-a$ , we get  $x = b + c + a$ . The object of transposition is to bring all the known terms of an equation to one side, and all those that are unknown to the other side, in order to determine the value of the unknown terms, with respect to those which are known.—4. In *gram.*, a change of the natural order of words in a sentence. The Latin and Greek languages admit *transposition* without inconvenience, to a much greater extent than the English.—5. In *music*, a change in the composition, either in the transcript or the performance, by which the whole is removed into a higher or lower key or pitch. This is effected in a written piece of music by raising or lowering all the notes on the staves

to the required degree, and altering the signature accordingly.

**TRANSPÓSI'TIONAL**, *a.* Pertaining to transposition.

**TRANSPÓSI'TIVE**, *a.* Made by transposing; consisting in transposition.

**TRANSPRINT**, *v. t.* To print in the wrong place. [Printers use the word *transpose*, when a *transposition* or mistake of this kind occurs.]

**TRANSPRÓSE**, *† v. t.* To change from prose into verse.

**TRANS-SHÁPE**, *† v. t.* [*trans* and *shape*.] To change into another form.

**TRANS-SHÁPED**, *† pp. or a.* Transformed.

**TRANS-SHÁPING**, *† ppr.* Transforming.

**TRANS-SHIP**. See **TRANSHIP**.

**TRANS'TRA**, *n.* [L.] In *Roman arch.*, the principal horizontal timbers in the roof of a building.

**TRANSUBSTANTIÁTE**, *v. t.* [Fr. *transubstantier*; *trans* and *substantie*.] To change to another substance; as, to *transubstantiate* the sacramental elements, bread and wine, into the flesh and blood of Christ, according to the popish doctrine.

**TRANSUBSTAN'TIATED**, *pp.* Changed to another substance.

**TRANSUBSTAN'TIATING**, *ppr.* Changing to another substance.

**TRANSUBSTANTIA'TION**, *n.* Change of substance. In the *Romish theol.*, the supposed conversion of the bread and wine in the eucharist, into the body and blood of Christ.

**TRANSUBSTANTIATOR**, *n.* One who maintains the popish doctrine of transubstantiation.

**TRANSUDA'TION**, *n.* [from *transude*.] The act or process of oozing through membranes, or of passing off through the pores of a substance; as, water, blood, or other fluid. Physiologists make a distinction between *transudation* and *perspiration*. The latter implies a function by which the perspired fluid is secreted from the blood; whereas by transudation the blood or other fluid merely oozes through unaltered.

**TRANSUDATORY**, *a.* Passing by transudation.

**TRANSÚDE**, *v. i.* [L. *trans* and *sudo*, to sweat.] To pass or ooze through the pores or interstices of texture, as water or other fluid; as, a liquid may *transude* through a membranous substance or texture, or through wood.

**TRANSÚDING**, *ppr.* Passing or oozing through the pores of a substance, as water or other fluid.

**TRANSÚME**, *v. t.* [L. *transumo*; *trans* and *sumo*, to take.] To take from one to another; to take a duplicate of; to copy or transcribe; as a writing. [*Little used.*]

**TRANSÚMPT**, *† n.* A copy of a writing or exemplification of a record.—An action competent to any one having a partial interest in a writing, or immediate use for it, to support his titles or defences in other actions, directed against the custodian of the writing, calling upon him to exhibit it, in order that a copy or *transumpt* of it may be made and delivered to the pursuer.

**TRANSÚMPTION**, *n.* The act of taking from one place to another.—2. In *logic*, a syllogism by concession or agreement, used where a question proposed is transferred to another with this condition, that a proof of the latter

should be admitted for a proof of the former. [*Little used.*]

**TRANSÚMP'TIVE**, *a.* Taking from one to another.

**TRANSÚVEC'TION**, *n.* [L. *transvectio*.] The act of conveying or carrying over.

**TRANSVERS'AL**, *a.* [Fr., from *L. trans* and *versus*.] Running or lying across; as, a *transversal* line; a *transversal* muscle.

**TRANSVERS'AL**, *n.* In *geom.*, a name given to a line drawn across several others so as to cut them all; as, when a straight or curved line intersects the three sides of a triangle.

**TRANSVERS'ALLY**, *adv.* In a direction crosswise.

**TRANSVERSE**, *a.* (transvers'.) [L. *transversus*; *trans* and *versus*, *verso*.] 1. Lying or being across or in a cross direction; as, a *transverse* diameter or axis. *Transverse* lines are the diagonals of a square or parallelogram. Lines which intersect perpendiculars, are also called *transverse*.—2. In *bot.*, a *transverse* partition, in a pericarp, is at right angles with the valves, as in a silique.—3. In *anat.*, a term applied to muscles, vessels, &c., which lie in a direction across other parts; as, the *transverse* muscle of the abdomen; the *transverse* suture which runs across the face.—*Transverse axis* or *diameter*, in the conic sections, is the diameter which passes through the foci. In the ellipse, it is the longest diameter; in the hyperbola, it is the shortest; and in the parabola, it is, like all the other diameters, infinite in length.—*Transverse strain*, in *mech.*, is the strain to which a beam is subjected when a force acts on it in a direction at right angles to its length, tending to bend it or break it across. A beam is more easily broken when subjected to a transverse strain, than when it is subjected to a longitudinal strain.

**TRANSVERSE**, *n.* That which crosses or lies in a cross direction; a transverse axis.

**TRANSVERSE**, *v. t.* (transvers'.) To overturn. [*Little used.*]

**TRANSVERS'ED**, *pp.* Overturned.

**TRANSVERSELY**, *adv.* (transvers'ly.) In a cross direction; as, to cut a thing *transversely*.

At Stonehenge, the stones lie *transversely* upon each other. *Stillingfleet.*

**TRANSVERS'ING**, *ppr.* Overturning.

**TRANSVOLA'TION**, *† n.* Act of flying beyond.

**TRANV'TER**, *n.* A carrier; a hawk of fish. [*Local.*]

**TRÁP**, *n.* [Sax. *trapp*, *trepp*; Fr. *trape*; It. *trappola*; Sp. *trampa*.] 1. An engine that shuts suddenly or with a spring, used for taking game; as, a *trap* for foxes. A trap is a very different thing from a *snare*; though the latter word may be used in a figurative sense for a trap.—2. An engine for catching men.—3. An ambush; a stratagem; any device by which men or other animals may be caught unawares.

Let their table be made a snare and a trap; Rom. xi

4. A play in which a ball is thrown up into the air by striking the end of a balanced stick on which it rests; the ball is then struck with a bat before it reaches the ground, and the object of the adversaries is to catch it before it reaches the ground, or to bowl it so as to hit a piece of wood with a hollow in it, called also a *trap*. [*Local.*]

5. A contrivance applied to drains and

soil pipes to prevent effluvia from passing the place where they are situated.

**TRAP**, } *n.* [Sw. *trappa*, Dan. **TRAP'-ROCKS**, } *trappe*, a stair, because rocks of this class often occur in large tabular masses, rising one above another like steps.] In *mineral.*, a name given to rocks characterized by a columnar form, or whose strata or beds have the form of steps or a series of stairs. Kirwan gives this name to two families of basalt. It is now employed to designate a rock or aggregate in which hornblend predominates, but it conveys no definite idea of any one species; and under this term are comprehended hornblend, hornblend slate, greenstone, greenstone slate, amygdaloid, basalt, wacke, clinkstone, porphyry, and perhaps hypersthene rock, augite rock, and some varieties of sienite.

**TRAP**, *a.* Relating to trap-rock.  
**TRAP**, *v. t.* To catch in a trap; as, to trap foxes or beaver.—2. To insure; to take by stratagem.

*I trapp'd the foe. Dryden.*  
3. To adorn; to dress with ornaments. [See TRAPPINGS.] [*The verb is little used.*]

**TRAP**, *v. i.* To set traps for game; as, to trap for beaver.

**TRAP'PA**, *n.* A genus of plants; nat. order Onagraceæ; sub-order Hydrocaryes. The species are commonly called water-caltrops, and are found in the temperate parts of Europe, and of Siberia, in the East Indies, and China. The large seeds of them all are sweet and edible. Those of *T. bispinosa* are extensively cultivated in



*Trapa bispinosa*, yielding Singhara nuts.

China and other parts of the East, where they form a common article of food, under the name of *Singhara nuts*.  
**TRAPAN'**, *v. t.* [Sax. *trepan*; from *trap*.] To insure; to catch by stratagem. [See TREPAN.]  
**TRAPAN'**, *n.* A snare; a stratagem.  
**TRAPAN'NER**, *n.* One who insnares.  
**TRAPAN'NING**, *ppr.* Insnares.  
**TRAP'-BALL**, *n.* See **TRAP**, def. 4.  
**TRAP'-BAT**, *n.* A bat used at the game of trap.  
**TRAP'-DOOR**, *n.* [*trap* and *door*.] A door in a floor, which shuts close like a valve.  
**TRAPE**, *v. i.* To traipse; to walk carelessly and sluttishly. [Not much used.]  
**TRAPES**, *n.* A slattern; an idle sluttish woman.  
**TRAPE'ZE**, *n.* A trapezium.  
**TRAPE'ZIAN**, *a.* [See **TRAPEZIUM**.] In *crystallography*, having the lateral planes composed of trapeziums situated in two ranges, between two bases.

**TRAPE'ZIFORM**, *a.* Having the form of a trapezium.

**TRAPEZIHE'DRON**, } *n.* [Gr. *τετρα-*  
**TRAPEZOHE'DRON**, } *ζων* and *εδρον*, side.] A solid bounded by twenty-four equal and similar trapeziums.

**TRAPE'ZIUM**, *n.* plur. *Trapezia* or *Trapeziums*. [L., from Gr. *τετραζιον*, a little table.] 1. In *geom.*, a plane figure contained under four right lines, none of them parallel.—2. In *anat.*, a bone of the carpus, so named from its shape.



Trapezium.

**TRAPE'ZIUS**, *n.* In *anat.*, a trapeziform muscle which serves to move the scapula in different directions.

**TRAPE'ZOID**, *n.* [Gr. *τετραζιον*, and *ιδος*.] In *geom.*, a plane four-sided figure having two of its opposite sides parallel.



Trapezoid.

**TRAPEZOID'AL**, *a.* Having the form of a trapezoid.—2. In *mineral.*, having the surface composed of twenty-four trapeziums, all equal and similar.

**TRAP'PEAN**, *a.* Pertaining to, or denoting trap or trap-rock.

**TRAP'PED**, *pp.* Caught in a trap; insnares.

**TRAP'PER**, *n.* [from *trap*.] In *America*, one who sets traps to catch beavers and other wild animals, usually for furs.

**TRAP'PING**, *ppr.* or *a.* Setting traps for wild animals; used also as a noun.

**TRAP'PINGS**, *n. plur.* [from *trap*.] The primary sense is that which is set, spread, or put on.] 1. Ornaments of horse furniture.

Caparisons and steeds,  
Bases and tinsel *trappings.* Milton.  
2. Ornaments; dress; external and superficial decorations. These but the *trappings* and the suits of woe. Shak.  
*Trappings* of life, for ornament, not use. Dryden.  
Affectation is part of the *trappings* of folly. Rambler.

**TRAP'PIST**, *n.* One of a very strict religious Roman catholic order, founded in 1140 in the valley of La Trappe, and still existing in Normandy.

**TRAP'POUS**, *a.* [from *trap*, in geology. It ought to be *trappy*.] Pertaining to trap; resembling trap, or partaking of its form or qualities.

**TRAP'-ROCKS.** See **TRAP**.  
**TRAPS**, *n.* Goods, furniture, &c. [*Local*.]

**TRAP'-STAIR**, *n.* A narrow staircase, or encased ladder, surmounted by a trap-door.

**TRAP'-STICK**, *n.* A stick used at the game of trap. Hence, a slender leg.

**TRAP'-TUFFA**, } *n.* In *geol.*, a kind of  
**TRAP'-TUFF**, } sandstone, composed of fragments and earthy materials from trap-rocks cemented together.

**TRASH**, *n.* [In G. *drüse* is a gland; in Sw. *trasa* is a rag. The word may be allied to *trash*.] 1. Any waste or worthless matter.

Who steals my purse, steals *trash*. Shak.  
2. Loppings of trees; bruised canes, &c. In the West Indies, the decayed leaves and stems of canes are called *field-trash*; the bruised and macerated rind of canes is called *cane-trash*; and both are called *trash*.—3. Fruit or other matter improper for food, but eaten by children, &c. It is used particularly of unripe fruits.—4. A worthless per-

son. [Not proper.]—5. A piece of leather or other thing fastened to a dog's neck to retard his speed. Hence, —6. A clog or encumbrance in a metaphorical sense.

**TRASH**, *v. t.* To lop; to crop.—2. To strip of leaves; as, to *trash* ratoon.—3. To crush; to humble; as, to *trash* the Jews.—4. To clog; to encumber; to hinder.

**TRASH**, *v. i.* To follow with violence and trampling.

**TRASH'ED**, *pp.* Lopped; stripped of leaves.

**TRASH'Y**, *a.* Waste; rejected; worthless; useless.

**TRASS**, *n.* Pumiceous conglomerate, a volcanic production, consisting of ashes and scoræ thrown out from the Eifel volcanoes. It is equivalent, or nearly so, to the puzzolana of the Neapolitans. It is used as a cement. The same name is given to a coarse sort of plaster or mortar, used to line cisterns and other reservoirs of water.

**TRAU'LISM**, } *n.* A stammering.  
**TRAU'MATE**, *n.* [from Gr. *τραυμα*, a fragment.] The name given by the French geologists to graywacke.

**TRAUMAT'IC**, *a.* [Gr. *τραυμα*, a wound.] 1. Pertaining to or applied to wounds.—2. Vulnerary; adapted to the cure of wounds.

**TRAUMAT'IC**, *n.* A medicine useful in the cure of wounds.

**TRAV'AIL**, *v. i.* [Fr. *travailler*; W. *travaelu*, to toil; a compound of W. *tra*, that is, *tras*, L. *trans*, over, beyond, and *mael*, work, Eng. *moil*.] 1. To labour with pain; to toil.—2. To suffer the pangs of childbirth; to be in parturition; Gen. xxxv.

**TRAV'AIL**, } *v. t.* To harass; to tire; as, troubles sufficient to *travail* the realm.

**TRAV'AIL**, *n.* Labour with pain; severe toil.

As every thing of price, so doth this require *travail*. Hooker.  
2. Parturition; as, a severe *travail*; an easy *travail*.

**TRAV'AILED**, *pp.* Harassed; laboured in childbirth.

**TRAV'AILING**, *ppr.* Labouring with toil; being in parturition; Is. xlii.

**TRAVE**, } *n.* [Sp. *traba*; Fr. *entraves*.  
**TRAVIS**, } See TRAMMEL.] 1. A

wooden frame to confine an unruly horse while shoeing. In *Scotch*, *traverse*, or *travis*, signifies a partition between two stalls in a stable.—2. In *arch.*, a cross beam; a traverse.

**TRAV'EL**, *v. i.* [A different orthography and application of *travail*.] 1. To walk; to go or march on foot; as, to *travel* from London to Dover, or from Edinburgh to Glasgow. So we say, a man ordinarily *travels* three miles an hour. [This is the proper sense of the word, which implies *toil*.]—2. To journey; to ride to a distant place in the same country; as, a man *travels* for his health; he *travels* to the Highlands. A man *travels* from London to Edinburgh in five days.—3. To go to a distant country, or to visit foreign states or kingdoms, either by sea or land. It is customary for men of rank and property to *travel* for improvement. Englishmen *travel* to France and Italy. Some men *travel* for pleasure or curiosity; others *travel* to extend their knowledge of natural history.—4. To pass; to go; to move. News *travels* with rapidity.

Time *travels* in divers paces with divers persons. Shak.

5. To labour. [See TRAVAIL.]—6. To move, walk, or pass, as a beast, a horse, ox, or camel. A horse *travels* fifty miles in a day; a camel *travels*.

TRAV'EL, *v. t.* To pass; to journey over; as, to *travel* the whole kingdom of England.

I *travel* this profound. *Milton.*

2. To force to journey.

The corporations shall not be *travelled* forth from their franchises.† *Spenser.*

TRAV'EL, *n.* A passing on foot; a walking.—2. Journey; a passing or riding from place to place.

His *travels* ended at his country seat. *Dryden.*

3. *Travel* or *travels*, a journeying to a distant country or countries. The gentleman has just returned from his *travels*.—4. In the *U. States*, the distance which a man rides in the performance of his official duties; or the fee paid for passing that distance; as, the *travel* of the sheriff is twenty miles; or that of a representative is seventy miles. His *travel* is a dollar for every twenty miles.—5. *Travels*, in the plural, an account of occurrences and observations made during a journey; as, a book of *travels*; the title of a book that relates occurrences in travelling; as, *travels* in Italy.—6. Labour; toil; parturition. [See TRAVAIL.]

TRAV'ELLED, *pp.* Gained or made by travel; as, *travelled* observations. [Unusual.]—2. *a.* Having made journeys.

TRAV'ELLER, *n.* One who travels in any way; Job xxxi.—2. One who visits foreign countries.—3. In *ships*, an iron thimble or thimbles with a rope spliced round them, forming a kind of tail or species of grommet, and serving to facilitate the hoisting or lowering of the top-gallant yards. Two of them are fixed on each backstay, on which they slide up and down like the ring of a curtain upon its rod.—4. In *mercantile affairs*, a person who travels for a merchant, or mercantile company, to receive payment of goods, wares, &c., sold by his employer, or employers, to other merchants, and to take orders.

TRAV'ELLER'S JOY, *n.* A plant of the genus *Clematis*, the *C. vitalba*. [See CLEMATIS.]

TRAV'ELLING, *ppr.* Walking; going; making a journey; Matth. xxv.—2. *a.* Incurred by travel; as, *travelling* expenses.—*Travelling* backstays, in *ships*, backstays so denominated from their having a traveller upon the topmast, which slides up and down according to the reefs in the top sail. A similar contrivance adapted to a martingale, constitutes what is termed a *travelling martingale*.

TRAV'EL-STAIN'ED, *a.* Having the clothes soiled, &c., with the marks of travelling.

TRAV'EL-TAINTED,† *a.* [*travel* and *tainted*.] Harassed; fatigued with travel.

TRAV'ERS,† *adv.* [Fr. See TRAVERSE.] Across; athwart.

TRAV'ERSABLE, *a.* [See TRAVERSE, in law.] That may be traversed or denied; as, a *traversable* allegation.

TRAV'ERSE, *adv.* [Fr. *a travers*.] Athwart; crosswise.

The ridges of the field lay *traverse*. *Hayward.*

TRAV'ERSE, *prep.* [supra.] Through; crosswise.

He *traverse*

The whole battalion views their order due. [Little used.] *Milton.*

TRAV'ERSE, *a.* [Fr. *traverse*; *tra*, *tras*,

and *L. versus*; *transversus*.] Lying across; being in a direction across something else; as, paths cut with *traverse* trenches.

Oak may be trusted in *traverse* work for summers. *Wotton.*

TRAV'ERSE, *n.* [supra.] Any thing laid or built across.

There is a *traverse* placed in the loft where she sitteth. *Bacon.*

2. Something that thwarts, crosses, or obstructs; a cross accident. He is satisfied he should have succeeded, had it not been for unlucky *traverses* not in his power.—3. In *fort*, a trench with a little parapet for protecting men on the flank; also, a wall raised across a work.—4. In *navigation*, the variation or alteration of a ship's course, occasioned by the shifting of the winds, currents, &c.; or it is a compound course consisting of several courses and distances. The reducing such courses and distances into an equivalent single course and distance, is called *resolving a traverse*. [See TRAVERSE-SAILING.]—5. In *arch*, the transverse piece in a timber roof; also, a gallery or loft of communication in a church or other large building.—6. In *law*, a denial of what the opposite party has advanced in any stage of the pleadings. When the *traverse* or denial comes from the defendant, the issue is tendered in this manner, "and of this he puts himself on the country." When the *traverse* lies on the plaintiff, he prays "this may be inquired of by the country."

The technical words introducing a *traverse*, are *absque hoc*, without this; that is, without this which follows.—7. A turning; a trick.—8. In *her*, a bearing resembling the chevron; sometimes termed a *doublet*.—*Traverse the escutcheon*, signifies across it.



Traverse.

TRAV'ERSE, *v. t.* To cross; to lay in a cross direction.

The parts should be often *traversed* or crossed by the fowing of the folds. *Dryden.*

2. To cross by way of opposition; to thwart; to obstruct.

Frog thought to *traverse* this new project. *Arbutnot.*

3. To wander over; to cross in travelling; as, to *traverse* the habitable globe.

What seas you *traversed*, and what fields you fought. *Pope.*

4. To pass over and view; to survey carefully.

My purpose is to *traverse* the nature, principles, and properties of this detestable vice, ingratitude. *South.*

5. To turn and point in any direction; as, to *traverse* a cannon.—6. To plane in a direction across the grain of the wood; as, to *traverse* a board.—7. In *law pleadings*, to deny what the opposite party has alleged. When the plaintiff or defendant advances new matter, he avers it to be true, and *traverses* what the other party has affirmed. So to *traverse* an indictment on an office, is to deny it.—*To traverse a yard*, in sailing, is to brace it aft.

TRAV'ERSE, *v. i.* In *fencing*, to use the posture or motions of opposition or counteraction.

To see thee fight, to see thee *traverse*. *Shak.*

2. To turn, as on a pivot: to move round; to swivel. The needle of a compass *traverses*; if it does not *traverse* well it is an unsafe guide.—3. In the *manège*, to cut the tread crosswise, as a horse that throws his cross to one side, and his head to the other.

TRAV'ERSE-BOARD, *n.* [*traverse* and *board*.] In a *ship*, a thin circular piece of board, marked with all the points of the compass, and having eight holes bored in each, and eight small pegs hanging from the centre of the board. It is hung up in the steerage, and used to record the different courses run by a ship during the period of a watch. This record is kept by putting a peg in that point of the compass whereon the ship has run each half hour.

TRAV'ERSED, *pp.* Crossed; thwarted; passed or travelled over; denied; opposed; made to bear, as a cannon on the point intended. In *her*, turned to the sinister side of the shield.

TRAV'ERSE, *n.* A term in law for one who traverses or opposes a plea.

TRAV'ERSE-SAILING, *n.* In *navigation*, the sailing on different courses, for short distances, in succession; or it is the method of reducing compound courses and distances into an equivalent single course and distance, which is effected by trigonometrical computation, or by the aid of a *traverse-table*.

TRAV'ERSE-TABLE, *n.* [*traverse* and *table*.] In *navigation*, a table containing the difference of latitude, and the departure made on each individual course and distance in a *traverse*, by means of which the difference of latitude and departure made upon the whole, as well as the equivalent single course and distance, may be readily determined. For facilitating the resolving of *traverses*, tables have been calculated for all units of distance run, from 1 to 300 miles or more, with every angle of the course which is a multiple of 10°, together with the corresponding differences of latitude and departure. Such a table is useful for many other purposes.

TRAV'ERSING, *ppr.* Crossing; passing over; thwarting; turning; denying.

TRAV'ERTIN, *n.* [It. *travertino*.] A white concretionary limestone, usually hard and semi-crystalline, deposited from the water of springs holding carbonate of lime in solution. *Travertin* is abundant in different parts of Italy, and a large proportion of the edifices of ancient and modern Rome are built of this stone.

TRAV'ESTIED, *pp.* Disguised by dress; turned into ridicule.

TRAV'ESTY, *a.* [infra.] Having an unusual dress; disguised by dress so as to be ridiculous. It is applied to a book or composition translated in a manner to make it burlesque.

TRAV'ESTY, *n.* A parody; a burlesque translation of a work. *Travesty* may be intended to ridicule absurdity, or to convert a grave performance into a humorous one.

TRAV'ESTY, *v. t.* [Fr. *travestir*; It. *travestire*; *tra*, *tras*, over, and *Fr. vestir*, *vêtir*, to clothe.] To translate into such language as to render ridiculous or ludicrous; to burlesque; to parody.

G. Battista Lalli *travestied* Virgil, or turned him into Italian burlesque verse. *Cyc. Good's Sacred Idyls.*

TRAV'ESTYING, *ppr.* Turning into ridicule.

TRAV'IS, *n.* A travc;—*which see.*

TRAWL, *v. i.* To fish with a drag-net.

TRAWLER, *n.* A fishing-vessel which *trawls* or trails a drag-net behind it.—2. A trawling fisherman.

TRAWLING, *ppr.* or *a.* Dragging for fish.—*n.* The act of one who trawls.

TRAY, *n.* [Sw. *trag*, Sax. *trog*, Dan. *trug*, a *trough*. It is the same word as *trough*, differently written; *L. trua*.] A small trough or wooden vessel, sometimes scooped out of a piece of timber and made hollow, used for various domestic purposes.—2. A sort of waiter, of wood or metal.

TRAY, *n.* Name of a dog; a watch-dog.

TRAY-TRIP, *n.* An ancient game at dice.

TREACHER, } † *n.* [Fr. *tricheur*.]

TREACHETOUR, } A traitor. [All

TREACHOUR, } *obs.*, in Britain;

but *treacher* is still vulgarly used in

Ireland.]

TREACHEROUS, *a.* (*trech'eros*.)

[See TREACHERY.] Violating allegiance

or faith pledged; faithless; traitorous

to the state or sovereign; perfidious in

private life; betraying a trust. A man

may be *treacherous* to his country, or

*treacherous* to his friend, by violating

his engagements or his faith pledged.

TREACHEROUSLY, *adv.* (*trech'erosly*.)

By violating allegiance or faith

pledged; by betraying a trust; faith-

lessly; perfidiously; as, to surrender

a fort to an enemy *treacherously*; to

disclose a secret *treacherously*.

You *treacherously* practis'd to undo me.

*Otway.*

TREACHEROUSNESS, *n.* (*trech'eros-*

*ness*.) Breach of allegiance or of

faith; faithlessness; perfidiousness.

TREACHERY, *n.* (*trech'ery*.) [Fr.

*tricherie*, a cheating; *tricher*, to cheat.

This word is of the family of *trick*, *in-*

*trigue*, *intricate*.] Violation of alle-

giance or of faith and confidence. The

man who betrays his country in any

manner, violates his allegiance, and is

guilty of *treachery*. This is treason.

The man who violates his faith pledged

to his friend, or betrays a trust in

which a promise of fidelity is implied,

is guilty of *treachery*. The disclosure

of a secret committed to one in confi-

dence, is *treachery*. This is perjury.

TREACLE, *n.* [Fr. *theriaque*; *L. the-*

*riaca*; Gr. *θηριακον*, from *θηρ*, a wild

beast; *θηριακα φαρμακον*.] 1. The spume

of sugar in sugar refineries. Treacle

is obtained in refining sugar; molasses

is the drainings of crude sugar. Treacle

however is often used for molasses.—

2. A saccharine fluid, consisting of the

inspissated juices or decoctions of cer-

tain vegetables, as the sap of the birch,

sycamore, &c.—3. A medicinal

compound of various ingredients. [See

Theriacal.]

TREACLE-MUSTARD, *n.* The com-

mon name of two British plants of the

genus *Erysimum*, the *E. cherianthoides*,

and *E. orientale*. The seeds of the

first are used for destroying worms in

children.

TREACLE-WATER, *n.* A compound

cordial, distilled with a spirituous

menstruum from any cordial and sud-

orific drugs and herbs, with a mixture

of Venice treacle.

TREAD, *v. i.* (*tréd*.) pret. *Trod*; pp.

*Trod*, *Trodden*. [Sax. *trædan*, *trædan*;

use the foot, to tread. It coincides in elements with *L. trudo*.] 1. To set the foot.

Where'er you *tread*, the blushing flow'rs shall rise.

Fools rush in where angels fear to *tread*.

*Pope.*

2. To walk or go.

Every place whereon the soles of your feet shall *tread*, shall be yours; Deut. xi.

3. To walk with form or state.

Yethat stately *tread*, or lowly creep. *Milton*.

4. To copulate, as fowls.—*To tread* or *tread on*, to trample; to set the foot on in contempt.

Thou shalt *tread upon* their high places; Deut. xxxiii.

TREAD, *v. t.* (*tréd*.) To step or walk on.

Forbid to *tread* the promis'd land he saw.

*Prior.*

2. To press under the feet.—3. To beat or press with the feet; as, to *tread* a path; to *tread* land when too light; a well trodden path.—4. To walk upon in a formal or stately manner.

He thought she *trod* the ground with greater grace. *Dryden*.

5. To crush under the foot; to trample in contempt or hatred, or to subdue; Ps. xlv. lx.—6. To compress, as a fowl.

—7. To put in action by the feet; as, to *tread* a wheel.—*To tread the stage*, to act, as a stage-player; to perform a part in a drama.—*To tread* or *tread out*, to press out with the feet; to press out wine or wheat; as, to *tread out* grain with cattle or horses.

They *tread* their wine presses and suffer thirst; Job xxiv.

TREAD, *n.* (*tréd*.) A step or stepping; footing; pressure with the foot; as, a nimble *tread*; cautious *tread*; doubtful *tread*.—2. Way; track; path. [Little used].—3. Compression of the male fowl.—4. Manner of stepping; as, a horse has a good *tread*.—*Tread of a step*, in *arch*, the horizontal surface of a step in a stair.

TREADER, *n.* (*tréd'er*.) One who treads; Is. xvi.

TREADING, *ppr.* (*tréd'ing*.) Stepping; pressing with the foot; walking on.

TREADING, *n.* Act of pressing with the foot.

TREADLE, } *n.* The part of a loom or

TRED'DLE, } other machine which is

moved by the tread or foot.—2. The albuminous cords which unite the yolk of the egg to the white.

TREAD MILL, *n.* A mill worked by persons treading on steps fixed on the periphery of a horizontal wheel. It is

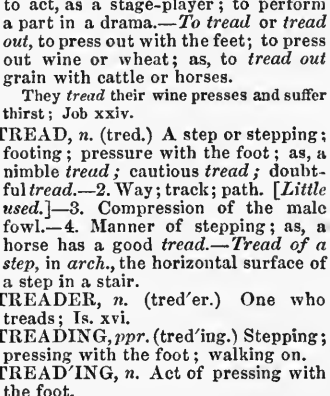

Tread Mill.

used chiefly as a means of prison discipline, or for giving usefulness to persons imprisoned for crime.

TREAD-WHEEL, *n.* A wheel similar in principle to an overshot water-wheel. It is usually about 5 feet diameter, and 16 or more feet long.

On its exterior surface are a number of steps placed horizontally, somewhat resembling the float boards of an undershot water wheel. On these steps a number of prisoners are placed, and all mounting the first step together, make it to descend by their weight, when they mount the next higher step, which descends in the same manner, and so on, causing the wheel to turn round, by *treading* on the steps in succession. They are assisted and supported in this labour by a horizontal rail which they lay hold of. The rotatory motion of the wheel thus produced, may be applied as the moving force for grinding corn, or in turning any other machinery.

TREAGUE, *n.* (*treeg*.) [Goth. *triggwa*; It. *trégua*; Ice. *trigd*, a truce, a league.] A truce.

TREASON, *n.* (*tree'zn*.) [Fr. *trahison*; Norm. *trahir*, to draw in, to betray, to commit treason, Fr. *trahir*, *L. traho*. See DRAW and DRAG.] In law, an overt or open act of compassing or devising the death of the king. But the term includes numerous acts and circumstances, which constructively and remotely, as well as immediately, affect the safety of the king's person; such as the violation of females of the royal family, levying war against the king in his realm, adherence to the king's enemies, counterfeiting the king's seals, the offence of slaying the chancellor or the judges; also, writings which import such compassings, or devices, attempts, or intentions, if published or shown to third persons, or words of advice, or persuasion, importing deliberation and design. There are no accessories to treason; all are held to be principals. The punishment for treason is, that the offender be drawn on a hurdle to the place of execution, and there hanged; that his head should be cut off; and the body divided into four quarters; but the king by warrant may dispense with all the immaterial parts of the punishment. The party attainted for treason forfeits all lands and property, and his heirs cannot take by any descent through him. Formerly treason used to be styled *high treason*, in contradistinction to what was termed *petty treason*, which was the killing of a master by his servant, a husband by his wife, but every offence which formerly amounted to petty treason is now deemed to be murder only, and not treason. In the United States, treason is confined to the actual levying of war against the United States, or in adhering to their enemies, giving them aid and comfort. TREASONABLE, *a.* (*tree'znable*.) Pertaining to treason; consisting of treason; involving the crime of treason, or partaking of its guilt.

Most men's heads had been intoxicated with imaginations of plots and treasonable practices. *Clarendon*.

TREASONABLENESS, *n.* Quality of being treasonable.

TREASONABLY, *adv.* In a treasonable manner.

TREASONOUS, for *Treasonable*, is not in use.

TREASURE, *n.* (*trezh'ur*.) [Fr. *tresor*; Sp. and It. *tesaurro*; *L. thesaurus*; Gr. *θησαυρος*.] 1. Wealth accumulated; riches hoarded; particularly, a stock or store of money in reserve. Henry VII. was frugal and penurious, and collected a great *treasure* of gold and

silver.—2. A great quantity of any thing collected for future use.

We have *treasures* in the field, of wheat and of barley, and of oil and of honey; Jer. xlii.

3. Something very much valued; Ps. cxxxv.

Ye shall be a peculiar *treasure* to me; Exod. xix.

4. Great abundance.

In whom are hid all the *treasures* of wisdom and knowledge; Col. ii.

**TREASURE, v. t.** (trezh'ur.) To hoard; to collect and reposit, either money or other things, for future use; to lay up; as, to *treasure* gold and silver; usually with up. Sinners are said to *treasure up* wrath against the day of wrath; Rom. ii.

**TREASURE-CITY, n.** (trezh'ur-city.) A city for stores and magazines; Exod. i.

**TREASURED, pp.** (trezh'ured.) Hoarded; laid up for future use.

**TREASURE-HOUSE, n.** (trezh'ur-house.) A house or building where treasures and stores are kept.

**TREASURER, n.** (trezh'urer.) One who has the care of a treasure or treasury; an officer who receives the public money arising from taxes and duties or other sources of revenue, takes charge of the same, and disburses it upon orders drawn by the proper authority. Incorporated companies and private societies have also their *treasurers*.—*Lord high treasurer*, formerly the third great officer of the crown, who had under his charge and government all the king's revenue, which is kept in the Exchequer; but at present the duties of the lord high treasurer are discharged by commissioners entitled *lords of the treasury*. [See **TREASURY**.]

—*Lord high treasurer of Scotland*, formerly an officer whose duty it was to examine and pass the accounts of the sheriffs, and others concerned in levying the revenues of the kingdom, to receive resignations of lands, and other subjects, and to revise, compound, and pass signatures, gifts of tutory, &c. In 1663, the lord high treasurer was declared president of the Court of Exchequer. The treasurer of the household, in the absence of the lord-steward, has power with the controller and other officers of the Green-cloth, and the steward of the Marshalsea, to hear and determine treasons, felonies, and other crimes committed within the king's palace. The treasurer of the navy is an officer who receives money out of the Exchequer, by warrant of the lords of the treasury, and pays all charges of the navy, by warrant from the principal officers of the navy.

**TREASURERSHIP, n.** (trezh'urership.) The office of treasurer.

**TREASURESS, n.** (trezh'uress.) A female who has charge of a treasure.

**TREASURE-TROVE, n.** (trezh'ur-trove.) [*treasure* and Fr. *trouv e*, found.] In law, any money or coin, gold, silver, plate, or bullion found hidden in the earth or in any private place, the owner of which is not known. In this case, the treasure becomes vested in the king by virtue of his prerogative; but if the owner is known or is ascertained after the treasure is found, the owner and not the king is entitled to it. In former ages, when persons were in the practice of burying their money, and other treasures in the earth, on account of the insecurity of property, *treasure-trove* became an important branch of

the revenue of this and of most other European states.

**TREAS'URING, ppr.** Hoarding; laying up for future use.

**TREASURY, n.** (trezh'ury.) A place or building in which stores of wealth are reposit; particularly, a place where the public revenues are deposited and kept, and where money is disbursed to defray the expenses of government.

—2. A department of government, which has control over the management, collection, and expenditure of the public revenue. The duties of this department are at present performed by a board of five lords commissioners, instead of a lord high treasurer, as in former times. The chief of these commissioners, or first lord of the treasury, is generally the prime minister for the time being; the other four junior lords have usually seats in parliament, as have also the two joint secretaries of the treasury. The other subordinate officers are a number of clerks, a receiver of fees, a keeper of the papers, a solicitor, a chamber keeper, messengers, house-keepers, extra clerks and extra messengers. The departments immediately under the control of the treasury, are the boards of customs, of excise, of stamps and taxes, and the post-office, the various officers in which are to a great extent appointed by the lords of the treasury. The chancellor of the Exchequer has the especial management of the revenue and expenditure of the nation, and when the prime minister or first lord of the treasury is a peer, the former takes the lead of the ministerial party in the house of commons, in which the seats occupied by that party are called the *treasury benches*. When the first lord of the treasury is a commoner, the offices of the prime minister and chancellor of the Exchequer are sometimes united in the same person.—3. A building appropriated for keeping public money; John viii. Also for keeping accounts of public money.—4. The officer or officers of the treasury department. [See **No. 2**.]—5. A repository of abundance; Ps. cxxxv.

**TREAT, v. t.** [Fr. *traiter*; It. *trattare*; L. *tracto*; Sax. *trahian*.] 1. To handle; to manage; to use. Subjects are usually faithful or treacherous, according as they are well or ill *treated*.

To *treat* prisoners ill, is the characteristic of barbarians. Let the wife of your bosom be kindly *treated*.—2. To discourse on. This author *treats* various subjects of morality.—3. To handle in a particular manner, in writing or speaking; as, to *treat* a subject diffusely.

—4. To entertain without expense to the guest; to give food or drink, as a compliment or expression of regard; as, to *treat* the whole company to a dinner, or to a glass of wine.—5. † To negotiate; to settle; as, to *treat* a peace.—6. To manage in the application of remedies; as, to *treat* a disease or a patient.—7. To subject to the action of; as, to *treat* a substance with sulphuric acid.

**TREAT, v. i.** To discourse; to handle in writing or speaking; to make discussions. Cicero *treats* of the nature of the gods; he *treats* of old age and of duties.—2. To come to terms of accommodation.

Inform us, will the emp'r or *treat*? Swift. 3. To make gratuitous entertainment; to give food or drink as a compliment

or expression of regard.—*To treat with*, to negotiate; to make and receive proposals for adjusting differences. Envoys were appointed to *treat with* France, but without success.

**TREAT, n.** An entertainment given as a compliment or expression of regard; as, a parting *treat*.—2. Something given for entertainment; as, a rich *treat*.—3. *Emphatically*, a rich entertainment. **TREATABLE, † a.** Moderate; not violent.

The heats or the colds of seasons are less *treatable* than with us. Temple.

**TREATABLY, † adv.** Moderately. **TREATED, pp.** Handled; managed; used; discoursed on; entertained.

**TREATER, n.** One that treats; one that handles or discourses on; one that entertains.

**TREATING, ppr. or a.** Handling; managing; using; discoursing on; entertaining.

**TREATING, n.** The act of one who treats.—2. Bribing with meat and drink; as, no candidate averse to *treat-ing*, need canvass the borough of Eatonswill.

**TREATISE, n.** [L. *tractatus*.] A tract; a written composition on a particular subject, in which the principles of it are discussed or explained. A treatise is of an indefinite length; but it implies more form and method than an essay, and less fulness or copiousness than a system.

**TREATISER, † n.** One who writes a treatise.

**TREATMENT, n.** [Fr. *traitement*.] 1. Management; manipulation; manner of mixing or combining, of decomposing and the like; as, the *treatment* of substances in chemical experiments.—2. Usage; manner of using; entertainment; good or bad behaviour towards. Accept such *treatment* as a swain affords.

*Pope.* 3. Manner of applying remedies to cure; mode or course pursued to check and destroy; as, the *treatment* of a disease.—4. Manner of applying remedies to; as, the *treatment* of a patient.

**TREATY, n.** [Fr. *trait e*; It. *trattato*.] 1. Negotiation; act of treating for the adjustment of differences, or for forming an agreement; as, a *treaty* is on the carpet.

He cast by *treaty* and by trusts Her to persuade. Spenser.

2. An agreement, league, or contract between two or more nations or sovereigns, formally signed by commissioners properly authorized, and solemnly ratified by the several sovereigns or the supreme power of each state. Treaties are of various kinds, as, *treaties* for regulating commercial intercourse, *treaties* of alliance, offensive and defensive, *treaties* for hiring troops, *treaties* of peace, &c. In most monarchies, the power of making and ratifying treaties is vested in the sovereign; in republics, it is vested in the chief magistrate, senate, or executive council; in the United States of America it is vested in the president, by and with the consent of the senate; while in the Germanic confederation, the particular states have the right of making treaties of alliance and commerce not inconsistent with the fundamental laws of the confederation. The East India Company enjoys the right of making treaties under certain limitations; but in all cases treaties can only be made by the sovereign power in a state, or by

parties upon whom the sovereign power has conferred that right. Hence, in order to enable a public minister or other diplomatic agent to conclude and sign a treaty, he must be furnished with full power by the sovereign authority, and the treaty concluded in this manner is binding on the state, in the same manner as if it had been concluded immediately by the sovereign power. In most constitutional governments it is necessary that the sanction of the legislative body be given to treaties of commerce, or those which impose taxes on the people, entered into by the executive—3. † Entreaty.

**TREATY-MAKING, a.** Authorized to make or form treaties; as, a *treaty-making power*.

**TREBLE, a.** (trib'l.) [Fr. *triple*; L. *triplex, triplus*; *tres*, three, and *plexus*, fold.] 1. Threefold; triple; as, a lofty tower with *treble walls*.—2. In *music*, acute; sharp; as, a *treble sound*; a *treble voice*.—3. That plays the highest part or most acute sounds; that plays the *treble*; as, a *treble violin*, &c.

**TREBLE, n.** (trib'l.) In *music*, the melody or air of a composition; the part of a symphony or concerted piece whose sounds are highest or most acute. In vocal music this part is performed by boys or females, and in instrumental music by violins, haut-boys, flutes, &c., adapted to it. The *treble* is divided into first or highest *treble*, and second or low *treble*. *Half treble* is a high counter-tenor, sometimes called *mezzo soprano*.

**TREBLE, v. t.** (trib'l.) [Fr. *tripler*.] To make thrice as much; to make *trebles* a debt. Compound interest soon *trebles* a debt.

**TREBLE, v. i.** (trib'l.) To become threefold. A debt at compound interest soon *trebles* in amount.

**TREBLE-CROSS-STAFF, n.** The pope's cross staff, formed of three crosses.

**TREBLENESS, n.** (trib'lness.) The state of being *treble*; as, the *trebleness* of tones.

**TREBLET, n.** A steel cylinder used *TREBLET*, } as a mandrel in the process of drawing metal tubes.

**TREBLY, adv.** (trib'ly.) In a threefold number or quantity; as, a good deed *trebly* recompensed.

**TREBUCHET, n.** In *archæol.*, a rude war engine something of the nature of

missiles into the towns and castles they beleagured. The receptacle at the lower portion of the machine being filled with the missiles intended to be thrown, the upper arm of the instrument, loaded with a heavy weight, was allowed to descend, which, owing to the unequal balance, it did with great velocity; and the large arm then swung in the air, and scattered its contents.

**TREBUCKET, n.** A tumbrel or cuck-TREBUCHET, } ing-stool.

**TRECK/SCHUYT, n.** [D.] A covered boat, drawn by horses or cattle, and used for conveying goods and passengers on the Dutch and Flemish canals. Such boats are now less used, owing to the introduction of railways.

**TRED'DLES, n. plur.** Dung of sheep or of hares. [*Provincial*.]

**TREE, n.** [Sax. *treo, treow*; Dan. *træ*; Sw. *trä*, wood, and *träd*, a tree; Gr. *δέν*: Slav. *drevo*; Sans. *druh*, or *drus*. Qu. W. *dar*, an oak; Sans. *taru*, a tree. It is not easy to ascertain the real original orthography; most probably it was as in the Swedish or Greek.] 1. A perennial plant having a woody trunk of varying size, from which spring a number of branches, having a structure similar to the trunk. Trees are thus distinguished from shrubs which have perennial stems, but have no trunk properly so called; and from herbs, whose stems live only a single year. It is difficult, however, to fix the exact limit between trees and shrubs. Trees, as to classification, may be either dicotyledonous or exogenous, monocotyledonous or endogenous, acotyledonous or acrogenous. [*See these Terms*.]

Trees are of various kinds; as, *nuciferous*, or nut-bearing trees; *bacciferous*, or berry-bearing; *coniferous*, or cone-bearing, &c.; *standard trees*, *dwarf trees*, *wall trees*, &c. Some are forest-trees, and useful for timber or fuel; others are fruit-trees, and cultivated in gardens and orchards; others are used chiefly for shade and ornament.—2. Something resembling a tree, consisting of a stem or stalk and branches; as, a genealogical *tree*.—3. In *ship-building*, pieces of timber are called *chess-trees*, *cross-trees*, *roof-trees*, *tressel-trees*, &c.—4. In *scrip.*, a cross.

Jesus, whom they slew and hanged on a tree; Acts x.

5. † Wood.—*Tree of Liberty*, a tree planted by the people of a country or state, to commemorate the achievement of their liberty, or the obtaining of some great accession to their liberties. Thus the Americans planted trees of liberty to commemorate the establishment of their independence in 1789; the Parisians planted trees of liberty to commemorate the revolution of 1848.

**TREE, v. t.** To drive to a tree; to cause to ascend a tree. A dog *tree*s a squirrel. [*American*.]

**TREE-FERNS, n.** The name given to several species of ferns, which attain to the size of trees; as, the *Al-sophila vestita*, *Cibotium billardieri*, *Chnoophora excelsa*, &c. They are found in tropical countries.

**TREE-FROG, n.** (*tree and frog* or *TREE-TOAD*,) *toad*.] The popular name of a batrachian genus of reptiles, (*Hyla*), differing from proper frogs, in the extremities of their toes, each of which is expanded into a rounded viscus pellet, that enables them to adhere to the surface of bodies, and to climb

trees, where they remain all summer, living upon insects. There are numerous species. They are found in North America.

**TREE-GÉRMANDER, n.** A plant of the genus *Teucrium*; the *T. scorodonia*. [*See GERMANDER*.]

**TREE'LESS, a.** Destitute of trees.

**TREE-LOUSE, n.** [*tree and louse*.] Plant louse, an insect of the genus *Aphis*. [*See APHIS*.]

**TREE'MALLOW, n.** A British plant of the genus *Lavatera*; the *L. arborea*. [*See LAVATERA*.]

**TREE-MOSS, n.** A species of lichen.

**TREEN, a.** Wooden; made of wood.

**TREEN, n.** The old plural of *Tree*.

**TRE'NAILS, n.** [*tree and nail*; com-

**TRE'NAILS, n.** *trunnel*.] In *mar. lan.*,

long cylindrical wooden pins, employed to fasten the planks of a ship's side and bottom to the corresponding timbers. The same name is also given to cylindrical wooden pins used by riggers for levers and heavers. In *railway engineering*, *treenails* are wooden pins about 6 inches long, and 1½ inch diameter, inserted into the holes of the stone blocks or sleepers to fasten the chair to.

**TREE-OF-LIFE, n.** The common name of the species of plants of the genus *Thuja* or *Thuya*. [*See THUJA*.]

**TREE-TOAD, n.** (*tree and toad*.) [*See TREE-FROG*.]

**TRE'FALLOW, v. t.** To plough land a third time before sowing. Written, also, *thrifallow*, *trifallow*, and *trufallow*.

**TREFLÉE, a.** [Fr.] In *her.*, an epithet applied to a cross, the arms of which end in three semi-circles, each representing the trefoil or three-leaved grass. Bends are sometimes borne *treflée*, that is, with trefoils issuing from the side.

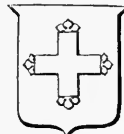

Cross Treflée.

**TRE'FOIL, n.** [Fr. *tréfle*; L. *trifolium*; *tres*, three, and *folium*, leaf.] The common name for many species of *Trifolium*, a genus of plants including white clover, red clover, &c., so well known as fodder-plants. [*See TRIFOLIUM*.] Also, a plant of the genus *medicago*, the *M. lupulina*, or black medick nonesuch, cultivated for fodder. Bird's foot trefoil is the common name for several species of the genus *Lotus*. [*See LOTUS*.]—2. In *arch.*, an



Trefoils.

ornament, consisting of three cusps, representing three-leaved clover.

**TRELLAGE, n.** (trell'lage.) [Fr. from *treillis*, *trellis*.] In *gardening*, a sort of rail-work, consisting of light posts and rails for supporting espaliers, and sometimes for wall-trees.

**TREIL'LE, n.** [Fr.] In *her.*, a lat-TREIL'LE, } tice.

**TREL' LIS, n.** [Fr. *treillis*, grated work.] In *gardening*, a structure or frame of cross-barred work, or lattice work, used like the trellage for supporting



*Trebuchet*, from an ancient carving in ivory, representing a knight preparing the machine for battering his fair opponents with roses.

a balista. It was principally used by besiegers, for casting stones and other



plants.—2. In *arch.*, a reticulated framing or lattice work of wood or metal, for screens, doors, or windows. It is also written *trellice*.

TRELLIS, *v. a.* To furnish with a trellis, lattice, or wooden frame.

TRELLISED, *a.* Having a trellis or trellises.

TREMANDO, [It. *trembling*.] In *music*, one of the harmonic graces, which consists in a general shake of the whole chord, and is thus distinguished from *tremolo*, which consists in a reiteration of a single note of the chord.

TREMATODES, } n. A family of pa-  
TREMATODEA, } renchymatous en-  
tozoa, or intestinal worms, comprising those which are furnished underneath the body, or at its extremity, with organs resembling cupping-glasses, by which they adhere to the viscera. The species infest horses, sheep, birds, fishes, &c.

TREMBLE, *v. i.* [Fr. *trembler*; L. *tremo*; Gr. *τρεμα*; It. *tremare*; Sp. *tremar*.]—1. To shake involuntarily; as, with fear, cold, or weakness; to quake; to quiver; to shiver; to shudder.

Frighted Turnus trembled as he spoke.

*Dryden.*

2. To shake; to quiver; to totter.

Sinal's grey top shall tremble. *Milton.*

3. To quaver; to shake, as sound; as, when we say the voice trembles.

TREMBLEMENT, *n.* In *Fr. music*, a trill or shake.

TREMBLER, *n.* One that trembles.

TREMBLING, *ppr.* Shaking; as, with fear, cold, or weakness; quaking; shivering.

TREMBLING, *n.* The act or state of shaking involuntarily; as, from fear, cold, or weakness.

TREMBLINGLY, *adv.* So as to shake; with shivering or quaking.

*Tremblingly* she stood.

TREMBLING-POPLAR, *n.* The aspen tree, *Populus tremula*, so called.

TREMBLINGS, *n.* An inflammatory affection in sheep, caused by eating noxious vegetables.

TREMELLA, *n.* A genus of fungi, the species of which are known by their amorphous character, by having a soft gelatinous appearance, and looking like gummy exudations of the substances on which they grow. They are all found on the decaying branches, trunks, and stumps of trees. The most common species is *T. mesenterica* or yellow nostoc, which is edible.

TREMENDOUS, *a.* [L. *tremendus*, from *tremo*, to tremble.]—1. Such as may excite fear or terror; terrible; dreadful. Hence—2. Violent; such as may astonish by its force and violence; as, a *tremendous* wind; a *tremendous* shower; a *tremendous* shock or fall; a *tremendous* noise.

TREMENDOUSLY, *adv.* In a manner to terrify or astonish; with great violence.

TREMENDOUSNESS, *n.* The state or quality of being tremendous, terrible, or violent.

TREMOLITE, *n.* A mineral, so called from Tremola, a valley in the Alps, where it was discovered. It is classed by Häüy, with hornblend or amphibole, and called amphibole grammatite. It is of three kinds, asbestous, common, and glassy tremolite; all of a fibrous or radiated structure, and of a pearly colour. Tremolite is a subspecies of straight-edged augite.

TREMOR, *n.* [L. from *tremo*.] An involuntary trembling; a shivering or shaking; a quivering or vibratory motion; as, the *tremor* of a person who is weak, infirm, or old, or labouring under some disorder.

He fell into a universal tremor. *Harvey.*

TREMULOUS, *a.* [L. *tremulus*, from *tremo*, to tremble.] 1. Trembling; affected with fear or timidity; as, a *tremulous* Christian.—2. Shaking; shivering; quivering; as, a *tremulous* limb; a *tremulous* motion of the hand or the lips; the *tremulous* leaf of the poplar.

TREMULOUSLY, *adv.* With quivering or trepidation.

TREMULOUSNESS, *n.* The state of trembling or quivering; as, the *tremulousness* of an aspen leaf.

TREN, *n.* A fish spear.

TRENCH, *v. t.* [Fr. *trancher*, to cut; It. *trincea*, a trench; *trinciare*, to cut; Sp. *trincar*, *trinchear*; Arm. *troucha*; W. *trygu*.]—1. To cut or dig, as a ditch, a channel for water, or a long hollow in the earth. [This is the appropriate sense of the word.]—2. In *agriculture*, to turn over and mix soil to the depth of two, three, or more spades or spits.

—3. To fortify by cutting a ditch and raising a rampart or breast-work of earth thrown out of the ditch. [In this sense, *entrench* is more generally used.]—4. To furrow; to form with deep furrows by ploughing.—5. To cut a long gash. †

TRENCH, *v. i.* To encroach, with *on* or *upon*; as, to *trench upon* another's rights. [See *ENTRENCH*.]

TRENCH, *n.* A long narrow cut in the earth; a ditch; as, a *trench* for draining land.—2. In *agriculture*, a narrow shallow ditch, for conveying water out of main ditches to float land, where irrigation is necessary, as in meadows.—3. In *fort.*, a deep ditch cut for defence, or to interrupt the approach of an enemy. The wall or breast-work, formed by the earth thrown out of the ditch, is also called a *trench*, as also any raised work, formed with bavons, gabions, wool-packs, or other solid materials. Hence the phrases, to *mount the trenches*, to *guard the trenches*, to *clear the trenches*, &c.—To *open the trenches*, to begin to dig, or to form the lines of approach.

TRENCH'ANT, } *a.* [Fr. *tranchant*.]  
TRENCH'AND, } Cutting; sharp.  
[Little used.]

TRENCH' DRAINS. Drains cut parallel to a trench, one on each side of it. Their use is to carry away the water immediately after it has flowed over the *panes*, or those portions of meadow land which lie between the trench and trench drains.

TRENCHED, *pp.* Cut into long hollows or ditches; furrowed or dug deep.

TRENCH'ER, *n.* [Fr. *tranchoir*.] 1. A wooden plate, on which meat was formerly eaten at table. In various country places wooden trenchers are still so used.—2. The table.—3. Food; pleasures of the table.

It would be no ordinary declension that would bring some men to place their *summun bonum* upon their trenchers. *South.*

TRENCH'ER CAP, *n.* The square cap worn by the collegians at Oxford and Cambridge.

TRENCH'ER-FLY, *n.* [*trancher* and *fly*.] One that haunts the tables of others; a parasite.

TRENCH'ER-FRIEND, *n.* [*trancher*

and *friend*.] One who frequents the tables of others; a sponger.

TRENCH'ER-MAN, *n.* [*trancher* and *man*.] A feeder; a great eater.—2. † A cook.

TRENCH'ER-MATE, *n.* [*trancher* and *mate*.] A table companion; a parasite.

TRENCH'ING, *ppr.* or *a.* Cutting into trenches; digging; ditching.

TRENCH'ING, *n.* In *agriculture*, a mode of pulverizing and mixing the soil, or of pulverizing and changing its surface by digging and turning it over to any greater depth than can be done by the spade alone. Trenching requires the assistance of the shovel and pick.

TRENCH'-PLOUGH, *n.* [*trench* and *plough*.] A kind of plough for opening land to a greater depth than that of common furrows.

TRENCH'-PLOUGH, *v. t.* [*trench* and *plough*.] To plough with deep furrows.

TRENCH'-PLOUGHING, *n.* The practice or operation of ploughing with deep furrows, for the purpose of loosening the land to a greater depth than usual.

TREND, *v. i.* [This word seems to be allied to *trundel* or to *run*.] To run; to stretch; to tend; to have a particular direction; as, the shore of the sea *trends* to the southwest.

TREND, *v. t.* In *rural economy*, to free wool from its filth. [*Local*.]

TREND, *n.* Inclination in a particular direction; as, the *trend* of a coast.

TREND, *n.* That part of the stock of an anchor from which the size is taken.

TREND'ER, *n.* One whose business is to free wool from its filth. [*Local*.]

TREND'ING, *ppr.* Running; tending.—2. Cleaning wool. [*Local*.]

TREND'ING, *n.* 1. An inclination; a stretching.—2. The operation of freeing wool from filth of various kinds.

TREND'LE, *n.* [Sax.; probably connected with *trundle*; Sw. *trind*, round; that is, *round*, with a prefix.] Any thing round used in turning or rolling; a little wheel.

TRENTAL, } *n.* [Fr. *trente*, thirty;  
TREN'TALS, } contracted from L. *triginta*, It. *trenta*.] An office for the dead in the Roman service, consisting of thirty masses rehearsed for thirty days successively after the party's death.

TREPAN, *n.* [Fr. *trépan*; It. *trapano*; Gr. *τρύπανον*, from *τρύπαω*, to bore; *τροπα*, a hole; *τροπος*. Qu. L. *tero*, *terebrā*.] In *sur.*, a circular saw for sawing a circular portion of bone out of the skull. It resembles a wimble, and is worked in the same manner. [See *TREPINE*.]

TREPAN', *v. t.* To perforate the skull and take out a piece; a surgical operation for relieving the brain from pressure or irritation.

TREPAN', a snare, and *Trepan*, to ensnare, are from *trap*, and should be written *trapan*,—which see.

TREPANG, } *n.* The sea-slug, a ma-  
TRI'PANG, } rine animal of the genus *Holothuria*, belonging to the order *Radiata*. It is found chiefly on coral reefs in the eastern seas, and is highly esteemed as an article of food in China, into which it is imported in large quantities. It is an unseemly looking animal, somewhat resembling the land-slug in shape, but having rows of tentaculi-form suckers on its body, and a radi-

ated mouth. The ordinary length is about a span, and the girth two or three inches, although some are found two feet in length, and seven or eight inches in circumference. When the trepan is taken, it is gutted, dipped for a short time in boiling water, then boiled in salt water for eight or ten hours, along with pieces of red mangrove bark, then dried and smoked over a wood fire, and this is all the preparation it receives. The fishery is carried on in numerous localities in the Indian ocean, the eastern Archipelago, and on the shores of Australia. The whole produce goes to China.



Trepan  
(Holothuria edulis).

**TREPAN'NED**, *pp.* Having the skull perforated.—2. Entrapped. See **TRAPAN**.  
**TREPAN'NER**, *n.* One who trepans.  
**TREPAN'NING**, *pp.* Perforating the skull with a trepan.—2. Entrapping.  
**TREPAN'NING**, *n.* The operation of making an opening in the skull, for relieving the brain from compression or irritation.—2. Insnaring.  
**TREPHINE**, *n.* [See **TREPAN**.] An improved form of the trepan, generally used by English surgeons instead of the trepan, which is used on the Continent. It consists of a cylindrical saw, with a handle placed transversely, like that of a gimlet, and has a sharp steel point, called the centre-pin, which may be fixed and removed at pleasure, and which stands in the centre of the circle formed by the saw, but projecting a little below the edge of the saw. The centre-pin is fixed in the skull, and forms an axis, round which the circular edge of the saw rotates, and as soon as the teeth of the saw have made a circular groove in which they can work steadily, the centre-pin is removed. The saw is made to cut through the bone, not by a series of complete rotations, such as are made by the trepan, but by rapid half rotations, alternately to the right and left, as in boring with an awl. The trephine is used especially in injuries of the head, and in cases resulting from injuries, for which the removal of a portion of the brain is necessary. The use of the trephine, however, is now much more rarely required than in former times, owing to improved modes of treating cases to which it was formerly applied, and the invention of simpler and more effective instruments.  
**TREPHINE**, *v. t.* To perforate with a trephine; to trepan.  
**TREPHINED**, *pp.* Trepanned.  
**TREP'ID**, *† a.* [L. *trepidus*.] Trembling; quaking.  
**TREPIDATION**, *n.* [L. *trepidatio*, from *trepido*, to tremble; Russ. *trepeg*, a trembling; *trepeschu*, to tremble.]—1. An involuntary trembling; a quaking or quivering, particularly from fear or terror; hence, a state of terror. The men were in great *trepidation*.—2. A trembling of the limbs, as in paralytic affections.—3. In the old *astr.*, a libration of the eighth sphere, or a motion which the Ptolemaic system ascribes to the firmament, to ac-

count for the changes and motion of the axis of the world.—4. Hurry; confused haste.

**TRES'AYLE**, *n.* In *Eng. law*, a writ sued on ouster by abatement, on the death of a grandfather's grandfather.

**TRES'PASS**, *v. i.* [Norm. *trespasser*; *tres*, L. *trans*, beyond, and *passer*, to pass.]—1. Literally, to pass beyond; hence, primarily, to pass over the boundary line of another's land; to enter unlawfully upon the land of another. A man may *trespass* by walking over the ground of another, and the law gives a remedy for damages sustained.—2. To commit any offence, or to do any act that injures or annoys another; to violate any rule of rectitude, to the injury of another.

If any man shall *trespass* against his neighbour, and an oath be laid upon him; 1 Kings viii.; see Luke xvii. 3, 4.

3. In a moral sense, to transgress voluntarily any divine law or command; to violate any known rule of duty.

In the time of his disease did he *trespass* yet more; 2 Chron. xxviii.

We have *trespassed* against our God; Ezra x.

4. To intrude; to go too far; to put to inconvenience by demand or importunity; as, to *trespass* upon the time or patience of another.

**TRES'PASS**, *n.* In *law*, strictly speaking, any transgression of the law not amounting to felony, or misprision of felony; but the term is generally used to signify any wrong done to the person, to the goods and chattels, or to the lands and tenements of any man. Any injuries or adverse contacts, committed against real property, that is, land or buildings, are, in the most ordinary sense of the word, *trespasses*; as entering another's house without permission, walking over the ground of another, or suffering any cattle to stray upon it, undermining, or even piling earth against a wall, or any detrimental act, or any practice which damages in the slightest degree the property, or interferes with the owner's or occupier's rights of possession. *Trespass* against the person may be by menace, assault, battery, or maiming. When an act is done which is in itself an immediate injury to another's person or property, it is called *trespass vi et armis*; such as assault and battery, or breaking and entering a house or close; also, where an act is not immediately injurious, but only by consequence and collaterally, it is termed *special trespass*, or *trespass on the case*. Actions which lie to redress the wrongs or injuries abovementioned are called *actions of trespass*.—2. Any injury or offence done to another.

If ye forgive not men their *trespasses*, neither will your Father forgive your *trespasses*; Matt. vi.

3. Any voluntary transgression of the moral law; any violation of a known rule of duty; sin. Col. ii.

You hath he quickened, who were dead in *trespasses* and sins; Eph. ii.

**TRES'PASSER**, *n.* One who commits a trespass; one who enters upon another's land, or violates his rights.—2. A transgressor of the moral law; an offender; a sinner.

**TRES'PASSING**, *pp.* Entering another man's inclosure; injuring or annoying another; violating the divine law or moral duty.

**TRES'PASS-OF-FERING**, *n.* An offering, among the Israelites, for a trespass.

**TRESS**, *n.* [Fr. and Dan. *trèsse*; Sw. *tress*, a lock or weft of hair; Dan. *tresser*, Sw. *tressa*, Russ. *trèstyru*, to weave, braid, or twist. The Sp. has *trenza*, and the Port. *trança*, a tress. The French may possibly be from the It. *treccia*, but probably it is from the North of Europe.] A knot or curl of hair; a ringlet.

Fair *tresses* man's imperial race insnare. Pope.

**TRESS'ED**, *a.* Having tresses.—2. Curled; formed into wringlets.

**TRES'SEL**, } *n.* [Fr. *trêteau*, for *tres-*  
**TRES'TLE**, } *teau*; W. *très*, a trace, a  
**TRUS'SEL**, } chain, a stretch, labour;  
*trèstau*, to labour, that is, to strain;  
*trèstyl*, a strainer, a trestle. This root occurs in *stress* and *distress*.]—1. The frame of a table. [Qu. D. *driestal*, a three-legged stool.]—2. A movable form for supporting any thing.—3. In *arch.*, a prop for the support of any thing which requires to be placed horizontally. It consists of three or four legs, attached to a horizontal piece, and frequently braced to give them strength and firmness. *Tressels* are much used for the support of scaffolding, in building, &c., and also by carpenters and joiners, for resting timber upon during the operations of ripping and cross-cutting, and for other purposes.—*Trestle-trees*, in a ship, are two strong bars of timber, fixed horizontally, and fore and aft, on the opposite sides of the lower mast-head, to support the frame of the top and the topmast.

**TRESS'URE**, *n.* In *her.*, a kind of border. The diminutive of the orle, and generally reckoned one-half of that ordinary. It passes round the field in the same shape and form as the escutcheon, whatever shape it may be, and is usually borne double and flory

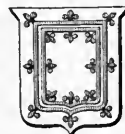

Tressure.

counter-flory.  
**TRES'SURED**, *a.* Bound with a tressure.

**TRET**, *n.* [probably from L. *tritrus*, *tero*, to wear.] In *com.*, an allowance to purchasers, for waste or refuse matter, or for dust or sand which may be mixed with commodities. It consists of a deduction of 4 lbs. for every 104 lbs. of subtle weight, or weight after the tare is deducted. It is now nearly discontinued by merchants, or else allowed in the price.

**TRETH'INGS**, *† n.* [W. *trèth*, a tax; *trèthu*, to tax.] Taxes; imposts.

**TREVET**, *n.* [three-feet, tripod; Sax. *triefet*; Fr. *tréped*.] A stool or other thing that is supported by three legs. [See **TRIVET**.]

**TREY**, *n.* [L. *tres*, Eng. *three*, Fr. *trois*.] A three at cards; a card of three spots.  
**TRI**, a prefix in words of Greek and Latin origin, signifies *three*, from Gr. *três*.

**TRI'ABLE** *a.* [from *try*.] That may be tried; that may be subjected to trial or test.—2. That may undergo a judicial examination; that may properly come under the cognizance of a court. A cause may be *triable* before one court, which is not *triable* in another. In *England*, testamentary

causes are *tribable* in the ecclesiastical courts.

**TRIABLENESS**, *n.* The state of being triable.

**TRIACONTAE'DRAL**, *a.* [Gr. *τριακοντα*, thirty, and *ιδεα*, side.] Having thirty sides. In *min.*, bounded by thirty rhombs.

**TRIACONTER**, *n.* [Gr. *τριακοντηρ*.] In ancient Greece, a vessel of thirty oars.

**TRIAD**, *n.* [L. *trias*, from *tres*, three.] The union of three; three united. In *music*, *triad*, or *harmonic triad*, is the common chord or harmony, and so named because it is formed of three radical sounds, a fundamental note or bass, its third, and its fifth.—*Triads of the Welsh bards*, poetical histories in which the facts recorded are thrown into a kind of triplets.

**TRIAL**, *n.* [from *try*.] Any effort or exertion of strength for the purpose of ascertaining its effect, or what can be done. A man tries to lift a stone, and on *trial* finds he is not able. A team attempts to draw a load, and after unsuccessful *trial*, the attempt is relinquished.—2. Examination by a test; experiment; as in chemistry and metallurgy.—3. Experiment; act of examining by experience. In *gardening* and *agriculture*, we learn by *trial* what land will produce; and often repeated *trials* are necessary.—4. Experience; suffering that puts strength, patience, or faith to test; afflictions or temptations that exercise and prove the graces or virtues of men.

Others had *trial* of cruel mockings and scourgings; Heb. xi.

5. In *law*, the examination of a cause in controversy between parties, before a proper tribunal. Trials are *civil* or *criminal*. Trial in civil causes, may be by *certificate*, by the *record*, or by a *jury*. By the laws of this country, trial by jury, in criminal cases, is held sacred. No criminal can be legally deprived of that privilege.—*Trial by inspection*, takes place where the judges personally examine and decide the question in dispute; but this practice has been long obsolete.—*Trial at the bar*, is one which resembles the ordinary cases of trials by jury, except that instead of its being presided over by a single judge, all the judges of the court in which the action is brought are in attendance. It is granted only in cases of great difficulty and importance. Ordinary cases it has long been superseded by trial *at nisi prius*. *New trials* in civil cases are granted, where the court, of which the record is, sees reason to be dissatisfied with a verdict, on the ground of a misdirection by the judge to the jury, a verdict against evidence, excessive damages, improper evidence, fresh evidence discovered after the verdict was given, &c. [See **CERTIFICATE, JURY, RECORD**.]—6. Temptation; test of virtue.

Every station is exposed to some *trials*. Rogers.

7. State of being tried.

**TRIALITY**, *n.* [from *three*.] Three united; state of being three. [Little used.]

**TRIALOGUE**, *n.* [Gr. *τρις*, three, and *λογος*, to speak.] Discourse by three speakers; a colloquy of three persons.

**TRIANDER**, *n.* [Gr. *τρις*, three, and *ανδρ*, a male.] A monoclinous or hermaphrodite plant having three distinct and equal stamens. *Triandria* is the

name given to the third class of plants in the sexual system of Linn. It comprises those plants which have hermaphrodite flowers, with three distinct stamens, as the crocus, the valerian,



Triander, Common Valerian.

a, Floret enlarged. b, Section of a floret.

and almost all the grasses. It comprehends three orders, *monogynia*, *digynia*, and *trigynia*. Triandria is also the name of several orders in the Linnæan system, the plants of which, besides their classic characters, have three stamens.

**TRIANDRIAN**, } *a.* Having three distinct stamens, in the same flower with a pistil or pistils.

**TRIANGLE**, *n.* [Fr. from L. *triangulum*; *tres*, three, and *angulus*, a corner.] 1. In *geom.*, a figure bounded by three lines, and containing three angles. The three angles of a plane triangle are equal to two right angles, or 180°, and its area is equal to half that of a rectangle or parallelogram of the same base and altitude. The triangle is the most important figure in geometry, and may be considered the element of all other figures. If the three lines or sides of a triangle are all right, it is a *plane* or *rectilinear* triangle; as, figs. 1, 2, 3, 4. If all the three sides are equal, it is an *equilateral* triangle; fig. 2. If two of the sides only are equal, it is an *isosceles* or *equicrural* triangle; fig. 3. If all the three sides are unequal, it is a *scalene* or *scalenoous* triangle; fig. 4. If one of

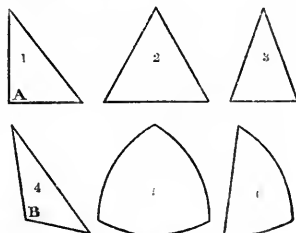

Triangles.

the angles is a right angle, the triangle is *right-angled*; as, fig. 1, having the right angle A. If one of the angles is obtuse, the triangle is called *obtusely-angled* or *amblygonous*; as fig. 4, having the obtuse angle B. If all the angles are acute, the triangle is *acutely-angled* or *oxygonous*; figs. 2, 3. If the three lines of a triangle are all curves, the triangle is said to be *curvilinear*; fig. 5. If some of the sides are

right and others curve, the triangle is said to be *mixtilinear*; fig. 6. If the sides are all arcs of great circles of the sphere, or arcs of the same circle, the triangle is said to be *spherical*; fig. 5.

—2. An instrument of percussion in music, made of a rod of polished steel, bent into the form of a triangle, and open at one of its angles. It is sounded by being struck with a small steel rod.

—3. In *astron.*, one of the 48 ancient constellations, situated in the northern hemisphere, surrounded by Perseus, Andromeda, Aries, and Musca. Also the name of one of the new southern constellations, lying between Ara, Centaurus, and the South Pole.—

4. In the *army*, three halberts stuck in the ground, and united at the top, to which soldiers are bound when flogged.

**TRIANGLED**, *a.* Having three angles; having the form of a triangle; formed into triangles.

**TRIANGULAR**, *a.* Having three angles; having the form of a triangle; relating to a triangle.—In *bot.*, a *triangular stem* has three prominent longitudinal angles; a *triangular leaf* has three prominent angles, without any reference to their measurement or direction.—*Triangular prism*, a prism whose ends are equal, similar, and parallel triangles, its three sides being parallelograms.—*Triangular pyramid*, a pyramid whose base is a triangle, its sides consisting of three triangles which meet in a point called its vertex.—*Triangular compasses*, compasses having three legs, by means of which any triangle or any three points may be taken off at once. This instrument is useful in the construction of maps, charts, &c.—*Triangular numbers*, the series of figurate numbers, which consists of the successive sums of the terms of an arithmetical series, whose first term is 1, and the common difference 1. Thus, 1, 3, 6, 10, 15, 21, 28, &c., are triangular numbers. They are so called because the number of points expressed by any one of them may be arranged in the form of an equilateral triangle.

**TRIANGULARITY**, *n.* Quality of being triangular.

**TRIANGULARLY**, *adv.* After the form of a triangle.

**TRIANGULATE**, *v. t.* In *surveying*, to divide into angles, or triangular net-work, by mensuration.

**TRIANGULATED**, *a.* Having a triangular form.

**TRIANGULATING**, *n.* The operation of laying down a net-work of triangles in the trigonometrical survey of a country.

**TRIANGULATION**, *n.* The net-work of triangles with which the face of a country is covered in a trigonometrical survey.

**TRIANTHEMA**, *n.* A genus of plants, nat. order Portulacææ. The flowers grow in threes in the axils of the leaves. The species inhabit the tropical parts of the old and new world, and in the subtropical parts of Africa. *T. obcordata* is employed by the natives of India as a pot herb.

**TRIAN'THÈE**, } *a.* In *heraldry*,

**TREBLE ARCHED**, } formed of three archings or having three arches.

**TRIARCHY**, *n.* [Gr. *τρις*, and *αρχη*.] Government by three persons.

**TRIARIAN**, *a.* [L. *triarii*.] Occupying the third post or place.

TRIAS, *n.* In *geol.*, a name sometimes given to the upper new red sandstone.

TRIASIC, *a.* Pertaining to or composed of trias.

TRIBAL, *a.* Belonging to a tribe.

TRIBE, *n.* [W. *trev*; Gael. *treabh*; Sax. *thorpe*, D. *dorp*, G. *dorf*; Sw. and Dan. *torp*, a hamlet or village; L. *tribus*. We have *tribe* from the last.

In Welsh, the word signifies a dwelling place, homestead, hamlet, or town, as does the Sax. *thorpe*. The Sax. *traef* is a tent; Russ. *derevni*, an estate, a hamlet. From the sense of house, the word came to signify a family, a race of descendants from one progenitor, who originally settled round him and formed a village.] 1. A family, race, or series of generations, descending from the same progenitor, and kept distinct, as in the case of the twelve tribes of Israel, descended from the twelve sons of Jacob.—2. A division, class, or distinct portion of people, from whatever cause that distinction may have originated. The city of Athens was divided into ten tribes. Rome was originally divided into three tribes; afterward the people were distributed into thirty tribes, and afterward into thirty-five.—3. A number of things having certain characters or resemblances in common; as, a tribe of plants; a tribe of animals. Linnæus distributed the vegetable kingdom into three tribes, viz., *monocotyledonous*, *dicotyledonous*, and *acotyledonous* plants, and these he subdivided into *gentes* or nations. By recent naturalists, *tribe* has been used for a division of animals or vegetables, intermediate between order and genus. Cuvier divides his orders into *families*, and his families into *tribes*, including under the latter one or more *genera*. Leach, in his arrangement of insects, makes his *tribes*, on the contrary, the primary subdivisions of his orders, and his families subordinate to them, and immediately including the *genera*.—*Tribes of plants, in gardening*, are such as are related to each other by some natural affinity or resemblance; as, by their duration, the *annual*, *biennial*, and *perennial* tribes; by their roots, as the *bulbous*, *tuberous*, and *fibrous-rooted* tribes; by the loss or retention of their leaves, as the *deciduous* and *evergreen* tribes; by their fruits and seeds, as the *leguminous*, *bacciferous*, *coniferous*, *nuciferous*, and *pomiferous* tribes, &c.—4. A division; a number considered collectively.—5. A nation of savages; a body of rude people united under one leader or government; as, the *tribes of the six nations*; the *Seneca tribe in America*.—6. A number of persons of any character or profession; *in contempt*; as, the scribbling *tribe*.

TRIBE, *v. t.* To distribute into tribes or classes. [Not much used.]

TRIBLET, } *n.* A goldsmith's tool

TRIBOLET, } for making rings. [See

TRIBLE.]

TRIBOMETER, *n.* [Gr. *τριβω*, to rub, or wear, and *μετρον*, measure.] The name given by Musschenbroek and Coulomb to an apparatus for measuring the force of friction in rubbing surfaces.

TRIBRACH, *n.* [Gr. *τρις*, three, and *βραχιν*, short.] In *ancient prosody*, a poetic foot of three short syllables, as *méliss*.

TRIBRACTEATE, *a.* Having three bracts.

TRIBULATION, *n.* [Fr. from L. *tribulo*, to thrash, to beat.] Severe affliction; distresses of life; vexations. In *scrip.*, it often denotes the troubles and distresses which proceed from persecution.

When *tribulation* or persecution ariseth because of the word, he is offended; Matt. xlii.

In the world ye shall have *tribulation*; John xvi.

TRIBULUS, *n.* Caltrops, a genus of plants, nat. order Rutacæ. The fruit is armed with prickles. The species are found in the South of Europe, and in the tropical and subtropical parts of the world. *T. terrestris*, and *T. cistoides*, are said to possess aperient properties.

TRIBUNAL, *n.* [L. *tribunal*, from *tribunus*, a tribune, who administered justice.] 1. Properly, the seat of a judge; the bench on which a judge and his associates sit for administering justice.—2. More generally, a court of justice; as, the house of lords is the highest *tribunal* in the kingdom.

TRIBUNARY, *a.* [from *tribune*.] Pertaining to tribunes.

TRIBUNATE, *n.* Tribuneship,—*which see*.

TRIBUNE, *n.* [Fr. *tribun*; L. *tribunus*, from *tribus*, tribe; Sp. and It. *tribuno*.]

1. In *ancient Rome*, an officer or magistrate chosen by the people, to protect them from the oppression of the patricians or nobles, and to defend their liberties against any attempts that might be made upon them by the senate and consuls. These magistrates were at first two, but their number was increased ultimately to ten. There were also military tribunes, officers of the army, each of whom commanded a division or legion. In the year of Rome 731, the senate transferred the authority of the tribunes to Augustus and his successors. There were also other officers called tribunes; as, *tribunes of the treasury*, of the horse, of the making of arms, &c.—2. A bench or elevated place, from which speeches were delivered.—3. In *France*, a pulpit or elevated place in the chamber of deputies, where a speaker stands to address the assembly.

TRIBUNESHIP, } *n.* The office of a

TRIBUNATE, } tribune.

TRIBUNICIAN, } *a.* Pertaining to

TRIBUNITIAL, } tribunes; as, *tribunian* power or authority.—2. Suiting a tribune.

TRIBUNITIOUS, *a.* Pertaining to tribunes. [Little used.]

TRIBUTARILY, *adv.* In a tributary manner.

TRIBUTARINESS, *n.* The state of being tributary. [Not authorized.]

TRIBUTARY, *a.* [from *tribute*.] Paying tribute to another, either from compulsion, as an acknowledgment of submission, or to secure protection, or for the purpose of purchasing peace. Many states of Hindostan are *tributary* to the British East India Company.—2. Subject; subordinate.

He, to grace his *tributary* gods. Milton.

3. Paid in tribute.

No flattery tunes these *tributary* lays. Cowden.

4. Yielding supplies of any thing. The Ohio has many large *tributary* streams; and is itself *tributary* to the Mississippi.

TRIBUTARY, *n.* One that pays tribute

or a stated sum to a conquering power, for the purpose of securing peace and protection, or as an acknowledgment of submission, or for the purchase of security. In *geography*, an affluent; a stream which falls into another stream. The Aar is a *tributary* of the Rhine.

TRIBUTUM, *n.* [Fr. *tribut*; L. *tributum*, from *tribuo*, to give, bestow, or divide.]

1. An annual or stated sum of money or other valuable thing, paid by one prince or nation to another, either as an acknowledgment of submission, or as the price of peace and protection, or by virtue of some treaty. The Romans made all their conquered countries pay *tribute*, as do the Turks at this day; and in some countries the *tribute* is paid in children.—2. A personal contribution; as, a *tribute* of respect.—3. Something given or contributed.

TRIBUTUM, *v. t.* To pay as tribute.

TRIBUTED, *pp.* Paid as tribute.

TRIBUTUMONEY, *n.* Money paid as tribute.

TRIBUTING, *ppr.* Paying as tribute.

TRICA, *n.* In *bot.*, the shield or reproductive organ of a lichen.

TRICAPSULAR, *a.* [L. *tres*, three, and *capsula*, a little chest.] In *bot.*, three-capsuled; having three capsules to each flower.

TRICE, *v. t.* To haul or tie up by means of a small rope. [See TRISS.]

TRICE, *n.* [Fr. *trois*, three.] A very short time; an instant; a moment; or before one can say or tell *three*.

If they get never so great spoil at any time, they waste the same in a *trice*. Spenser.

A man shall make his fortune in a *trice*. Young.

TRICENNA'RIOUS, *a.* Tricennial; belonging to the term of thirty years.

TRICEN'NIAL, *a.* Denoting thirty, or what pertains to that number.

TRICENTENARY, *n.* or *a.* A period or space of three hundred years.

TRICEPS, *a.* [L. from *tres*, three; and *caput*, head.] Three-headed. In *anat.*, a term applied to muscles, which arise by three heads; as, the *triceps extensor cubiti*, the use of which is to extend the forearm.

TRICHAS, *a.* A genus of birds of the order Sylviade.

TRICHECHUS, *n.* [Gr. *τριχ*, hair, and *εχον*, fish.] A genus of marine mammals, formerly including the sea-cows, (*T. manatus*); but now restricted to the walrus (*T. rosmarus*).

TRICHI'ASIS, *n.* [Gr. from *τριχ*, hair.] A disease of the eyelashes, in which one or more of them are turned inwards so as to be in contact with the ball of the eye, and produce irritation.

TRICHL'IA, *n.* A genus of plants, nat. order Meliaceæ. The species inhabit the tropical parts of America, and a few are found in Africa and New Holland. They form trees or shrubs, with axillary panicles of white flowers. Several of them are possessed of active properties, as *T. emetica*, or the emetic nut, which is found in the mountains of Yemen; *T. cathartica*, used in Brazil as a cure for fevers, &c. *T. moschata* is the musk-wood of Jamaica.

TRICHIURUS, *n.* [Gr. *τριχ*, and *ουρα*, a tail.] A genus of Acanthopterygious fishes, belonging to the family Tanioides, Cuv. They are called in English hair-tails, from the elongated hair-like

filament that terminates the tail. They resemble beautiful silver ribbons. *T.*

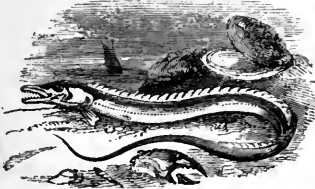

Silvery Hair-tail (*Trichurus lepturus*).

*lepturus*, or silvery hair-tail, has been found on the British coast.

**TRICHODERMA'CEE**, *n.* A tribe of fungous plants, the type of which is the genus *Trichoderma*.

**TRICHOMANES**, *n.* A genus of ferns, belonging to the suborder Hymenophyllaceæ. *T. spectosum* is a British species, found near Bingley, Yorkshire, and at Wicklow, Killarney, and Youghal, in Ireland. It is a rare and beautiful fern.

**TRICHONEMA**, *n.* A genus of plants, nat. order *Irdeæ*. *T. columnæ* is a British species, found in sandy places in Gnersey and Jersey. It is a small bulbous plant, with pale-bluish purple and yellow flowers.

**TRICHOPTERANS**, *n.* [Gr. *τριπτερον*, a wing.] An order of insects, with four hairy membranous wings. It comprises the case-worm flies.

**TRICHORD**, *n.* In music, an instrument with three cords or strings.

**TRICHOSANTHIS**, *n.* A genus of plants, nat. order Cucurbitaceæ. The species are trailing or climbing plants found in the hot and moist parts of Asia; a few are found in the West Indies. Many of them are edible, and are known by the name of snake gourds, from their long and often sinuous fruit. *T. dioica* is cultivated in India, and is called by the natives *puvul*. The unripe fruit and tender tops are much eaten both by Europeans and natives in Bengal, in stews and curries.

**TRICHOSPERMI**, *n.* A tribe of fungous plants, including the puff-balls, devil's snuff-boxes, &c.

**TRICHOTOMOUS**, *a.* [See **TRICHOTOMY**.] Divided into three parts, or divided by threes; as, a *trichotomous* stem.

**TRICHOTOMY**, *n.* [Gr. *τριχοταμία*, thrice, and *τομή*, to cut or divide.] Division into three parts.

**TRICK**, *n.* [D. *trek*, a pull or drawing, a *trick*; *trekken*, to draw, to drag; *bedriegen*, to cheat; *driegen*, to tack or baste; G. *triegen*, to deceive; *trug*, *betrug*, fraud, *trick*; Dan. *trekhe*, a *trick*; *trekher*, to draw, to entice; Fr. *tricher*, to cheat; It. *treccare*, to cheat; *trecca*, a huckster; *treccia*, a lock of hair, from folding, involving, Gr. *τριχοταμία*: Sp. *trica*, a quibble; L. *tricio*, to play tricks, to trifle, to baffle. We see the same root in the Low L. *intrico*, to fold, and in *intrigue*. *Trick* is from *drawing*, that is, a drawing aside, or a folding, interweaving, implication.] 1. An artifice or stratagem for the purpose of deception; a fraudulent contrivance for an evil purpose, or an underhand scheme to impose upon the world; a cheat or cheating. We hear of *tricks*, in bargains, and *tricks* of state.

He comes to me for counsel, and I show him a *trick*. South.

2. A dextrous artifice. On one nice *trick* depends the gen'ral fate.

*Pope*.  
3. Vicious practice; as, the *tricks* of youth.—4. The sly artifice or legerdemain of a juggler; as, *tricks* with cards.—5. A parcel of cards falling to the winner at one turn or one round of play.—6. An unexpected event. Some *trick* not worth an egg. *Shak*.

[Unusual.]  
7. A particular practice, habit, or manner; as, he has a *trick* of drumming with his fingers, or a *trick* of frowning.—8. In nautical lan., the time spent at the helm by a steersman. **TRICK**, *v. t.* To deceive; to impose on; to defraud; to cheat; as, to *trick* another in the sale of a horse.

**TRICK**, *v. t.* [W. *trecciau*, to furnish or harness, to trick out; *tree*, an implement, harness, gear, from *rheg*, a breaking forth, properly a throwing or extending. This may be a varied application of the foregoing word.] To dress; to decorate; to set off; to adorn fantastically.

*Trick her off in air.* *Pope*. It is often followed by *up*, *off*, or *out*.

People are lavish in *tricking up* their children in fine clothes, yet starve their minds. *Locke*.

2. To draw heraldic devices with pen and ink.

**TRICK**, *v. i.* To live by deception and fraud.

**TRICKED**, *pp.* Cheated; deceived; dressed.

**TRICK'ER**, } *n.* One who tricks; a  
**TRICK'STER**, } deceiver; a cheat.

**TRICK'ER**, *n.* A trigger. [See **TRIGGER**.]

**TRICK'ERY**, *n.* The art of dressing up; artifice; stratagem.

**TRICK'ING**, *ppr.* Deceiving; cheating; defrauding.—2. Dressing; decorating.

**TRICK'ING**, *n.* Deceit; dress; ornament.

**TRICK'ISH**, *a.* Artful in making bargains; given to deception and cheating; knavish.

**TRICK'ISHLY**, *adv.* Artfully; knavishly.

**TRICK'ISHNESS**, *n.* The state of being trickish, knavish, or deceitful.

**TRICK'LASITE**, *n.* Another name for Fahlnite,—*which see*.

**TRICK'LE**, *v. i.* [allied perhaps to Gr. *τριχλω*, to run, and a diminutive.] To flow in a small gentle stream; to run down in drops; as, tears *trickle* down the cheek; water *trickles* from the eaves.

Fast beside there *trickled* softly down  
A gentle stream. *Spenser*.

**TRICK'LING**, *ppr.* Flowing down in a small gentle stream.

**TRICK'LING**, *n.* The act of flowing in a small gentle stream or in drops.

He wakened by the *trickling* of his blood  
*Wiseman*.

**TRICK'MENT**, } *n.* Decoration.  
**TRICK'STER**, } *n.* One who practises tricks.

**TRICK'SY**, *a* [from *trick*.] Pretty; dainty, neat, brisk, lively, merry. [Not much used.]

The fool hath planted in his memory  
An army of good words; and I do know  
A many fools that stand in better place,  
Garnish'd like him, and for a *tricky* word  
Defy the matter. *Shak. Merch. of Venice*.

**TRICK-TRACK**, } *n.* A game at  
**TRICK-TRACK**, } tables; a kind of

backgammon, played both with men

and pegs, and more complicated. It is also written *Trick tack*.

**TRICK'Y**, *a.* Trickish; practising tricks. **TRICLINATE**, *a.* [Gr. *τρις*, threefold, and *κλίση*, to incline.] In *min.*, a term applied to crystals in which the three axes are all obliquely inclined to each other; as, in the oblique rhomboidal prism.

**TRICLINIARY**, *a.* [L. *triclinaryis*, from *triclinium*, a couch to recline on at dinner.] Pertaining to a couch for dining, or to the ancient mode of reclining at table.

**TRICLINIUM**, *n.* [L. from *tres*, three, and *clino*, to incline.] In ancient arch., a room in which meals were taken, furnished with three couches, which occupied three sides of the dinner table, the fourth side being left open for the free ingress and egress of servants. On these couches, which also received the name of triclodium, the guests reclined at dinner or supper.

**TRICOC'CE**, *n.* [Gr. *τρις*, and *κοκκος*, a kernel or berry.] The name given by Linnæus to one of the nat. orders of plants in the system he sketched out. It contained those plants which have a single three-cornered capsule with three cells, each containing a single seed, such as *Euphorbia*, *Cambogia*, *Sterculia*, &c. In Jussieu's system, as adopted and amended by Decandole and Lindley, this nat. order is called *Euphorbiaceæ*. Bartling, however, still makes use of the name *Tricocceæ* to designate a group of families, among which are *Euphorbiaceæ*, *Rhamnaceæ*, *Celastraceæ*, &c.

**TRICOC'COUS**, *a.* [See **TRICOCCEÆ**.] A tricoocous or three-grained capsule is one which is swelling out in three protuberances, internally divided into three cells, with one seed in each; as in *Euphorbia*.

**TRIC'OLOUR**, } *n.* [Fr. *tricolore*, of  
**TRIC'OLOUR**, } three colours.] The banner of various nations, supposed to be peculiarly emblematic of liberty. The French tricolor, counting from the staff, is composed of three stripes, respectively coloured blue, white, red; the Belgian, black, yellow, red; the Dutch, counting from the top, red, white, blue.

**TRIC'OLOURED**, *a.* Having three colours.

**TRICORNIG'EROUS**, *a.* [L. *tres* and *cornu*.] Having three horns.

**TRICOR'PORAL**, } *a.* [L. *tricornor*;  
**TRICOR'PORATE**, } *tres* and *corpus*.]  
Having three bodies. In *her.*, *tricornor*



Tricornate.

porate is a term applied when the bodies of three beasts are represented issuing from the dexter, sinister, and base points of the escutcheon, and meeting, conjoined to one head, in the centre point.

**TRICUS'PID**, *a.* Having three points. —*Tricuspid valve*, in anat., the valve situated between the auricle and ventricle, on the right side of the heart. It is so named from its shape.

**TRICUS'PIDATE**, *a.* [L. *tres*, three, and *cuspis*, a point.] In bot., three-pointed; ending in three-points; as, a *tricuspidate* stamen.

**TRIDAC'NA**, *n.* A genus of subtransverse inequilateral, equivaive marine molluscs, belonging to Lamarck's family of *Tridacnacea*, and found both

recent and fossil. The shells of this genus are of a delicate white colour, tinged with buff, and remarkably handsome. One of the species, *T.*

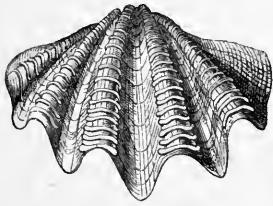

Giant Tridacna (*T. gigas*).

*gigas*, attains a remarkable size, measuring from two to three feet across, and sometimes weighing five hundred pounds.

**TRIDACTYLOUS**, *a.* [Gr. *τρεῖς*, and *δακτύλος*, a toe.] Having three toes.

**TRIDE**, *a.* Among hunters, short and ready; fleet; as, a *tride* pace.

**TRIDENT**, *n.* [Fr. from *L. tridens*; *tres*, three, and *dens*, tooth.] 1. Any instrument of the form of a fork with three prongs.—2. In *myth.*, a kind of sceptre or spear with three prongs, which the fables of antiquity put into the hands of Neptune, the deity of the ocean.—3. A name given to a kind of parabola, by which Des Cartes constructed equations of six dimensions.

**TRIDENT**, } *a.* Having three teeth

**TRIDENTED**, } or prongs.

**TRIDENTATE**, *a.* [L. *tres* and *dens*, tooth.] Having three teeth.

**TRIDENTINE**, *a.* [L. *Tridentum*, Trent.] Pertaining to Trent, or to the celebrated council held in that city.

**TRIDIAPASON**, *n.* [*tri* and *diapason*.] In *music*, a triple octave or twenty-second.

**TRIDING**. See **TRITHING**.

**TRIDODECAHEDRAL**, *a.* [Gr. *τρεῖς*, three, and *dodecahedral*.] In *crystallography*, presenting three ranges of faces, one above another, each containing twelve faces.

**TRIDUAN**, *a.* [L. *triduum*; *tres* and *dies*, day.] Lasting three days, or happening every third day. [*Little used*.]

**TRIENNIAL**, *a.* [Fr. *triennial*; L. *triennis*, *triennium*; *tres*, three, and *annus*, year.] 1. Continuing three years; as, *triennial* parliaments.—2. Happening every three years; as, *triennial* elections. *Triennial* elections and parliaments were established in England in 1695; but these were discontinued in 1717, and septennial elections and parliaments were adopted, which still continue.

**TRIENNIALY**, *adv.* Once in three years.

**TRIPENS**, *n.* [L.] A small Roman copper coin, equal to one-third of the *as*.

**TRIENTALIS**, *n.* A genus of plants, nat. order Primulaceæ; class and order Heptandria-monoynia, Linn.

The only British species is *T. europæa*, European chick-weed winter green. It is rare in England, but abundant in

many parts of the Highlands of Scotland, and is chiefly remarkable for being the only native heptander.

**TRIER**, *n.* [from *try*.] One who tries; one who makes experiments; one who examines any thing by a test or standard.—2. One who tries judicially; a judge who tries a person or cause.—3. One appointed to decide whether a challenge to a juror is just. [See **TRION**.]—4. A test; that which tries or approves.

**TRIERARCH**, *n.* [Gr. *τριεμς*, a trireme, and *αρχος*, a chief.] In *ancient Greece*, the commander of a trireme; also, a commissioner, who was obliged to build ships and furnish them at his own expense.

**TRIERARCHY**, *n.* The office or duty of a trierarch.

**TRIETERICAL**, *a.* [L. *trietericus*; *tres*, three, and Gr. *ετος*, year.] Triennial; kept or occurring once in three years. [*Little used*.]

**TRIFACIAL**, *a.* [L. *tres*, three, and *facies*, a face.] The *trifacial nerve*, in *anat.*, is the fifth nerve, so called from its division into three great branches, and distribution to the face.

**TRIFALOW**, *v. t.* [L. *tres*, three, and *fallow*.] To plough land the third time before sowing.

**TRIFALOWED**, *pp.* Ploughed the third time before sowing.

**TRIFALOWING**, *ppr.* Ploughing the third time before sowing.

**TRIFARIOUS**, *a.* Arranged in three rows; threefold.

**TRIFID**, *a.* [L. *trifidus*; *tres*, three, and *findo*, to divide.] In *bot.*, divided half way into three parts by linear sinuses with strait margins; three-cleft.

**TRIFISTULARY**, *a.* [L. *tres* and *fastula*, a pipe.] Having three pipes.

**TRIFLE**, *n.* [It coincides with *trivial*,—*which see*.] 1. A thing of very little value or importance; a *word applicable to any thing and every thing of this character*.

With such poor *trifles* playing. *Drayton*. Moments make the year, and *trifles*, life.

*Young*. *Trifles* light as air

Are to the jealous confirmations strong.

2. A dish composed of alternate layers of sweetmeats and cake, with syllabus.

—3. A cake.

**TRIFLE**, *v. i.* To act or talk without seriousness, gravity, weight, or dignity; to act or talk with levity.

They *trifle*, and they beat the air about nothing which toucheth us. *Hooker*.

2. To indulge in light amusements.—*To trifle with*, to mock; to play the fool with; to treat without respect or seriousness.—*To trifle with*, or *to trifle away*, to spend in vanity; to waste to no good purpose; as, *to trifle with time*, or *to trifle away time*; *to trifle with advantages*.

**TRIFLE**, † *v. t.* To make of no importance.

**TRIFLER**, *n.* One who trifles or acts with levity.

**TRIFLING**, *ppr.* or *a.* Acting or talking with levity, or without seriousness or being in earnest.—2. *a.* Being of small value or importance; trivial; as, a *trifling* debt; a *trifling* affair.

**TRIFLING**, *n.* Employment about things of no importance.

**TRIFLINGLY**, *adv.* In a trifling manner; with levity; without seriousness or dignity.

**TRIFLINGNESS**, *n.* Levity of manners; lightness.—2. Smallness of value; emptiness; vanity.

**TRIFLO'ROUS**, *a.* [L. *tres*, three, and *flos*, *floris*, flower.] Three-flowered; bearing three flowers; as, a *triflorous* peduncle.

**TRIFOLIATE**, *a.* [L. *tres*, three, and *folium*, leaf.] Having three leaves.

**TRIFOLIOLATE**, *a.* Having three folioles.

**TRIFOLIUM**, *n.* [L. from *tres*, three, and *folium*, a leaf.] Trefoil, a most extensive genus of plants, nat. order Leguminosæ, papilionaceous tribe, and curvembryose division. It is so named from its leaves possessing three segments. The species, which are very numerous, are principally inhabitants of temperate climates, and are found in all quarters of the world. They are all more or less pasture or fodder plants; a few of them are particularly valuable to the farmer, and their introduction into agriculture, under the name of clover, has greatly advanced the profits of farming. The most important species are *T. pratense*, common purple trefoil, or red clover; *T. repens*, white trefoil, white or Dutch clover; *T. incarnatum*, flesh-coloured trefoil, or scarlet clover; *T. arvense*, hare's foot trefoil; *T. maritimum*, seaside or tealz-headed trefoil; *T. alexandrinum*, Alexandrian trefoil or clover; *T. medium*, meadow trefoil, marl clover, or cow grass; *T. procumbens*, hop trefoil or yellow clover; *T. filiforme*, lesser yellow trefoil. Several of these are British plants, as are also the following:—*T. officinale*, common melilot; *T. ornithopodioides*, bird's-foot trefoil; *T. suffocatum*, suffocated trefoil; *T. subterraneum*, subterraneous trefoil; *T. ochroleucum*, sulphur-coloured trefoil; *T. stellatum*, starry-headed trefoil; *T. scabrum*, hard-knotted trefoil; *T. glomeratum*, smooth round-headed trefoil; *T. striatum*, soft-knotted trefoil; *T. fragiferum*, strawberry-headed trefoil; *T. resupinatum*, reversed trefoil.

**TRIFOLY**, *n.* Sweet trefoil. [See **TRIFOLIUM**.]

**TRIFORIUM**, *n.* [L.] In *arch.*, a gallery above the arches of the nave of a church, generally in the form of an arcade. In many churches there is also a similar gallery in the choir. Galleries of the same kind existed in several of the ancient Basilica. The name, which is of modern invention, is very inappropriate, as the triple opening which it implies is far from being a general characteristic of the triforium.

**TRIFORM**, *a.* [L. *triformis*; *tres* and *forma*.] Having a triple form or shape; as, the *triform* countenance of the moon.

**TRIFORMITY**, *n.* The state of being triform.

**TRIFURCATED**, *a.* Having three branches or forks.

**TRIG**, † *v. t.* [W. *trigaw*. See **TRIGGER**.] To fill; to stuff.—2. To stop; as a wheel.

**TRIG**, † *a.* Full; trim; neat.

**TRIG**, *n.* A stone, wedge of wood, or something else laid under a wheel or a barrel, to prevent its rolling.

**TRIGAMOUS**, *a.* [See **TRIGAMY**.] In *bot.*, having three sorts of flowers, in the same head, male, female, and hermaphrodite.

**TRIGAMY**, *n.* [Gr. *τρεῖς*, three, and

*γαμος*, marriage.] State of being married three times; or the state of having three husbands or three wives at the same time.

**TRIGEMINI**, *n. plur.* [L. *tres*, three, and *geminus*, double; threefold.] In anat., the fifth pair of nerves; which arise from the crura of the cerebellum, and are divided, within the cranium, into three branches, viz., the orbital, and the superior and inferior maxillary.

**TRIG'GER**, *n.* [W. *trigaw*, to stop; Dan. *trekker*, to draw; *trykker*, to press or pinch; or *trygger*, to make sure; *trug*, Sw. *trygg*, safe, secure; *trycka*, to press. This is the Eng. *true*, or from the same root.] 1. That which stops or catches; a catch to hold the wheel of a carriage on a declivity.— 2. The catch of a musket or pistol; the part which, being pulled, looses the lock for striking fire.

**TRIGON'TALS**, *n.* [L. *triginta*.] Trentals; the number of thirty masses to be said for the dead.

**TRIG'LA**, *n.* A genus of acanthopterygious fishes, popularly known as gurnards. [See GURNARD.]

**TRIGLO'CHIN**, *n.* Arrow-grass, a genus of plants; class Hexandria, order Trigynia, Linn.; nat. order Juncaginaceæ. The species are found in marshes, sides of rivers, ditches, and wet meadows. *T. palustre*, marsh arrow-grass, and *T. maritimum*, sea arrow-grass, are British plants. The leaves of the former, when bruised, give out a fetid smell.

**TRIGLYPH**, *n.* [Gr. *τρις*, three, and *γλυφισ*, sculpture.] An ornament in the frieze of the Doric column, repeated at equal intervals. Each triglyph consists of two entire gutters or channels, cut to a right angle, called *glyphs*, and separated by three interstices, called *femora*.

**TRIGLYPH'IC**, } *a.* Consisting of  
**TRIGLYPH'ICAL**, } or pertaining to  
triglyphs.—2. Containing three sets of characters or sculptures.

**TRIG'ON**, *n.* [Gr. *τρις*, three, and *γωνια*, angle.] 1. A triangle; a term used in astrology; also, trine, an aspect of two planets distant 120 degrees from each other.—2. A kind of triangular lyre or harp, used among the ancients.

**TRIG'ONAL**, } *a.* Triangular; having  
**TRIG'ONOUS**, } three angles or corners.—2. In bot., having three prominent longitudinal angles; as, a style or ovary.

**TRIGONEL'LA**, *n.* A genus of plants; nat. order Leguminosæ, papilionaceous tribe. The species are strong scented herbs with trifoliate leaves. *T. fenum græcum*, the common fenugreek, is a native of the South of Europe. Its seeds were formerly used in medicine, and are still used by grocers and farmers, as a medicine for horses. In some parts of the south of Germany, this plant is cultivated as fodder for horses and sheep. *T. esculenta*, is a native of some parts of the Indies, where its legumes are eaten by the natives as food.

**TRIGON'IA**, *n.* A genus of conchiferous molluscs, belonging to the family Ostracea. The trigonia is a triangular, or suborbicular, equivalve, transverse bivalve. The species are found both recent and fossil. The former have been discovered near Australia only, in sandy mud. They have been termed *Trigonia margaritacea*, or pearly trigon, from their pearly lustre.

**TRIGONOMET'RIC**, *a.* Pertaining to

trigonometry. [See TRIGONOMETRICAL.]

**TRIGONOMET'RIC**, *a.* Pertaining to trigonometry; performed by or according to the rules of trigonometry.

*Trigonometrical lines*, lines which are employed in solving the different cases of plane and spherical trigonometry; as, radins, sines, tangents, secants, cosines, cotangents, cosecants, &c. These lines have certain relations to each other, and numbers representing them, or the logarithms of such numbers, are formed into tables, for facilitating calculations in trigonometry.—*Trigonometrical curves*, a name given to certain curves, which have such equations as  $y = \sin x$ ,  $y = \cos x$ ,  $y = a \cos x + b \cos 2x$ , &c. These curves may be constructed from the fundamental properties of the sine, cosine, &c.—*Trigonometrical series*, infinite series which are of the form  $a \sin x + b \sin 2x + c \sin 3x$ , &c., and  $a \cos x + b \cos 2x + c \cos 3x$ , &c.

—*Trigonometrical survey*, a term which may be applied to any survey of a country, which is carried on from a single base, by the computation of observed angular distances; but the term is usually confined to measurements on a large scale, embracing a considerable extent of country, and requiring a combination of astronomical and geodetical operations. A trigonometrical survey may be undertaken either to ascertain the exact situation of the different points of a country relatively to each other, and to the equator and meridians of the terrestrial globe, for the purpose of constructing an accurate map; or to determine the dimensions and form of the earth, by ascertaining the curvature of a given portion of its surface, or by measuring an arc of the meridian. The most minute accuracy and the most perfect instruments, are required in all the practical parts of such operations; and it becomes necessary to have regard to the curvature of the earth's surface, the effects of temperature, refraction, altitude above the level of the sea, and a multitude of circumstances, which are not taken into account in ordinary surveying. In conducting a trigonometrical survey of a country, signals, such as spires, towers, poles, erected on elevated situations, or other objects, are assumed at as great a distance as will admit of distinct and accurate observations, with telescopes of considerable power attached to the instruments used in measuring the angles. In this way the country will be divided into a series of *primary triangles*; and if any side of any one of these be measured, the remaining sides of all of them may be computed by trigonometry. By means exactly similar, each of these triangles is resolved into a number of others called *secondary triangles*; and thus the positions of towns and other remarkable objects are determined. The length of the *base* or line measured, which is an arc of a great circle, must be determined with extreme accuracy, as an error in measuring it would affect the entire survey. For checking the measurements and the computations, it is proper to measure some other line at a considerable distance from the first; as the comparison of its measured and computed lengths will be a test of the accuracy of the intermediate operations. Such a line is called a *base of verifica-*

*tion*. The measurement of a base is one of the principal difficulties in the survey, chiefly on account of the inequalities of the earth's surface, and the variations in the length of the measuring instrument, arising from the change of temperature. The base is assumed on as flat a portion of country as can be obtained, and the chain or other measuring instrument is constructed with extreme care.

**TRIGONOMET'RICALLY**, *adv.* According to the rules or principles of trigonometry.

**TRIGONOME'TRY**, *n.* [Gr. *τριγωνος*, a triangle, and *μετροω*, to measure.] According to the primitive meaning of the term, the measuring of triangles, or the science of determining the sides and angles of triangles, by means of certain parts which are given; but in its modern acceptance it includes all theorems and formulæ relative to angles and circular arcs, and the lines connected with them, these lines being expressed by numbers or ratios. In fact, the principles of trigonometry are of very general application, furnishing means of investigation in almost every branch of mathematics. Trigonometry, in relation to its practical utility, may be regarded as the most important of all the applications of mathematics, especially in relation to astronomy, navigation, and surveying. Trigonometry is of two kinds, *plane* and *spherical*, the former treating of triangles described on a plane; and the latter, of those described on the surface of a sphere. In every triangle there are six things which may be considered, viz., the three sides and the three angles, and the main object of the theoretical part of trigonometry is to deduce rules, by which, when some of these are given, the others may be found by computation, such computations being facilitated by tables of sines, tangents, &c. In plane trigonometry any three of the six parts of a triangle being given, (except the three angles,) the other parts may be determined; but in spherical trigonometry this exception has no place, for any three of the six parts being given, the rest may thence be determined, the sides being measured or estimated by degrees, minutes, &c., as well as the angles. Both plane and spherical trigonometry is divided into *right-angled* and *oblique-angled*.

**TRIGRAMMAT'IC**, or **TRIGRAM'MIC**, *a.* [Gr. *τρις*, three, and *γραμμαμα*, a letter.] Consisting of three letters, or three sets of letters.

**TRIGRAP'H**, *n.* [Gr. *τρις*, and *γραφω*.] A name given to three letters having one sound; as *eau* in *beau*.

**TRIG'YNE**, *n.* [Gr. *τρις*, three, and *γυνη*, a female.] In bot., a plant having three styles. *Trigynia* is the name of an order of plants in the Linnæan system, distinguished by the flowers having three styles or pistils; as, in the bladder nut.

**TRIGYN'IAN**, or **TRIG'YNOUS**, *a.* Having three styles.

**TRIHE'DRAL**, *a.* [See TRIHEDRON.] Having three equal sides.

**TRIHE'DRON**, *n.* [Gr. *τρις*, three, and *δρα*, side.] A figure having three equal sides.

**TRI'HILATE**, *a.* [L. *trihilatus*.] Having three *hila* or scars; applied to seeds.

**TRIJUGATE**, } *a.* [L. *tres*, three, and  
**TRIJUGOUS**, } *jugum*, yoke.] In

*bot.*, having three pairs of leaflets. A *trijugous* leaf is a pinnate leaf with three pairs of leaflets.

**TRILATERAL**, *a.* [Fr. from *L. tres*, three, and *latus*, side.] Having three sides; as a triangle.

**TRILATERALLY**, *adv.* With three sides.

**TRILATERALNESS**, *n.* Quality of having three sides.

**TRILETTO**, *n.* [It.] In music, a short trill.

**TRILINGUAL**, } *a.* [*L. tres* and *lin-*  
**TRILINGUAR**, } *gua.*] Consisting  
of three languages.

**TRILITERAL**, *a.* [*L. tres*, three, and *litera*, letter.] Consisting of three letters; as, a *triliteral* root or word.

**TRILITERAL**, *n.* A word consisting of three letters.

**TRILITHON**, *n.* [Gr. *τεις*, three, and *λίθος*, a stone.] Three stones placed together like door posts and a lintel.

**TRILL**, *n.* [It. *trillo*; Dan. *trille*; G. *triller*; W. *treilliau*, to turn, to roll. But the latter may be contracted from *treiglaw*, to turn; *traill*, *traigyl*, a turn or roll, from the root of *draw*, *drag*. *Trill* coincides with *thirl* and *drill*; D. *drillen*. Qu. *reed*.] A quaver; a shake of the voice in singing, or of the sound of an instrument. [See SHAKE.]

**TRILL**, *v. t.* [It. *trillare*.] To utter with a quavering or tremulousness of voice; to shake.  
The sober-suited songstress *trills* her lay.

Thomson.

**TRILL**, *v. i.* To flow in a small stream, or in drops rapidly succeeding each other; to trickle.  
And now and then an ample tear *trill'd* down  
Her delicate cheek. Shak.

2. To shake or quaver; to play in tremulous vibrations of sound.  
To judge of *trilling* notes and tripping feet.

Dryden.

**TRILL'ED**, *pp.* Shaken; uttered with rapid vibrations.

**TRILL'ING**, *ppr.* Uttering with a quavering or shake.

**TRILLION**, *n.* (tril'yun.) [a word formed arbitrarily of *three*, or Gr. *τρεῖς*, and *million*.] The product of a million involved to the third power, or the product of a million multiplied by a million; the product of the square of a million multiplied by a million. Thus  $1,000,000 \times 1,000,000 = 1,000,000,000,000$ , and this product multiplied by a million =  $1,000,000,000,000,000$ . According to the *French notation*, the number expressed by a unit, with twelve cyphers annexed, or  $1,000,000,000,000$ .

**TRILLO**, *n.* [It.] In music, a trill, which consists of a rapid alternate transition from the one to the other of two contiguous sounds of the musical scale; but it has various modifications and names.

**TRILOBATE**, *a.* [*L. tres* and *lobus*.] Having three lobes.

**TRIOLOBITE**, *n.* [Gr. *τεις*, three, and *λοβος*, a lobe.] An extinct and widely distributed family of crustacea nearly allied to the *phyllopora*. They are found in the earliest fossiliferous strata, and comprehend those species in which the body is divided into three lobes, which run parallel to its axis. Trilobites are supposed to have moved by swimming in an inverted position, belly up, immediately beneath the surface of the water. When attacked, they could roll themselves into a ball. They

fed on small water animals, and inhabited gregariously and in vast numbers the shallow water near coasts.

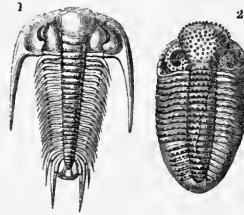

Trilobites.

1. *Paradoxides bohemicus*. 2. *Phacops latifrons*.

**TRIOCULAR**, *a.* [*L. tres*, and *locus*, a cell.] In *bot.*, three-celled; having three cells for seeds; as, a *trilocular* pericarp.

**TRILOGY**, *n.* [Gr. *τεις* and *λογος*.] A series of three dramas, which bear a mutual relation to each other, and form but parts of one historical and poetical picture. Shakspeare's *Henry VI.* is an example.

**TRILUMINAR**, } *a.* [*Lat. tres* and  
**TRILUMINOUS**, } *lumen*, light.] Having three lights.

**TRIM**, *a.* [Sax. *trum*, firm, stable, strong, secure; *tryman*, *getrymian*, to make firm, to strengthen, to prepare, to order or dispose, to exhort, persuade, or animate. The primary sense is to set, to strain, or to make straight.] Firm; compact; tight; snug; being in good order. We say of a ship, she is *trim*, or *trim-built*; every thing about the man is *trim*. We say of a person, he is *trim*, when his body is well shaped and firm; and we say, his dress is *trim*, when it sits closely to his body and appears tight and snug, and of posture we say, a man or a soldier is *trim*, when he stands erect. It is particularly applicable to soldiers, and in Saxon, *truma* is a troop or body of soldiers.

**TRIM**, *v. t.* [Sax. *trumian*, *trymian*, to make firm or strong, to strengthen, to prepare, to put in order.] 1. In a general sense, to make right, that is, to put in due order for any purpose.

The hermit *trimm'd* his little fire.

Goldsmith.

2. To dress; to put the body in a proper state.  
I was *trimm'd* in Julia's gown. Shak.

3. To decorate; to invest or embellish with extra ornaments; as, to *trim* a gown with lace.—4. To clip, as the hair of the head; also, to shave; that is, to put in due order.—5. To lop, as superfluous branches; to prune; as, to *trim* trees.—6. To supply with oil; as, to *trim* a lamp.—7. To make neat; to adjust.

I found her *trimming* up the diadem

On her dead mistress. Shak.

8. In *carpentry*, to dress, as timber; to make smooth; to fit to any thing.—

9. To adjust the cargo of a ship, or the weight of persons or goods in a boat, so equally on each side of the centre and at each end, that she shall sit well on the water and sail well. Thus we say, to *trim* a ship or a boat.—10. To rebuke; to reprove sharply; also to beat; to lick. [*Colloq.*]—11. To arrange in due order for sailing; as, to *trim* the sails.—To *trim in*, in *carpentry*, to fit, as a piece of timber into other work.—*Trim up*, to dress; to put in order, to fit up.

**TRIM**, *v. i.* To balance; to fluctuate between parties, so as to appear to favour each.

**TRIM**, *n.* Dress; gear; ornaments.—2. The state of a ship or her cargo, ballast, masts, &c., by which she is well prepared for sailing.—*Trim of the masts* is their position in regard to the ship and to each other, as near or distant, far forward or much aft, erect or raking.—*Trim of sails*, is that position and arrangement which is best adapted to impel the ship forward.

**TRIMERA**, *n.* [Gr. *τεις*, three, and *μερος*, a part.] The name given by Latreille to his fourth section of *Coleoptera*, including those which have each tarsus composed of three articulations; as, the lady-birds, and puff-ball beetles.

**TRIMEROUS**, *a.* In *bot.*, consisting of three parts. A flower is said to be trimorous when it has three parts in the calyx, three in the corolla, and three stamens.

**TRIMESTER**, *n.* [*L. trimestris*, *tres*, three, and *mensis*, month.] In *German universities*, a term or period of three months.

**TRIMETER**, *n.* A poetical division of verse, consisting of three measures.

**TRIMETER**, } *a.* [Gr. *τριμετρος*,  
**TRIMETRICAL**, } three measures.] Consisting of three poetical measures, forming an iambic of 6 feet.

**TRIMLY**, *adv.* Nicely; neatly; in good order.

**TRIMMED**, *pp.* Put in good order; dressed; ornamented; clipped; shaved; balanced; rebuked.—*Trimmed in*, in *arch.*, a term applied to a piece of work fitted between others previously executed. Thus, a post is said to be *trimmed in* between two beams. *Trimmers* of stairs, when brought forward to receive the rough strings, are said to be *trimmed out*.

**TRIMMER**, *n.* One that trims; a time-server; one who fluctuates between parties.—2. A partizan of the political trimmers during the reigns of Charles II. and James II.—3. In *arch.*, a flat brick arch for the support of a hearth in an upper floor. It is turned from the chimney breast to a joist parallel to it, called a trimmer-joist.

**TRIMMING**, *ppr.* Putting in due order; dressing; decorating; pruning; balancing; fluctuating between parties.

**TRIMMING**, *n.* Ornamental appendages to a garment, as lace, ribbons, and the like.

**TRIMMING-JOIST**, *n.* The joist which supports the trimmer joist.

**TRIMMINGLY**, *adv.* In a trimming manner.

**TRIMNESS**, *n.* Neatness; petty elegance; snugginess; the state of being close and in good order.

**TRINIAL**, *a.* [*L. trinus*, three.] Three-fold.

**TRINDLE**, *v. t.* To allow to trickle, or to run down in small streams.

[Local.]

**TRINDLE**, *v. i.* To trickle; to run in a small stream. [Local.]

**TRINE**, *a.* Threefold; as, *trine* dimension, that is, length, breadth, and thickness.

**TRINE**, *n.* [supra.] In *astrol.*, the aspect of planets distant from each other 120 degrees, or the third part of the zodiac. The *trine* was supposed to be a benign aspect.

**TRINE**, *v. t.* To put in the aspect of a trine.



**TRINED**, *pp.* Put in the aspect of a trine.  
**TRINERVATE**, *a.* [*L. tres* and *nervus*.]  
 In *bot.*, having three unbranched vessels extending from the base to the apex of a leaf.

**TRINERVE**, } *a.* In *bot.*, a *trinerved*  
**TRINERVED**, } or three-nerved leaf,  
 has three unbranched vessels extending from the base to the apex or point.

**TRINGA**, *n.* A Linnæan genus of birds, including the lapwings, ruffs, knots, sandpipers, purres or stints, &c. But modern ornithologists have arranged these birds differently.

**TRINGINÆ**, *n.* A family of wading birds, containing the snipes, woodcocks, and sandpipers.

**TRINGLE**, *n.* [*Fr.*] In *arch.*, a little square member or ornament, as a listel, reglet, platband, and the like, but particularly a little member fixed exactly over every triglyph.

**TRINITARIAN**, *a.* Pertaining to the Trinity, or to the doctrine of the Trinity.

**TRINITARIAN**, *n.* One who believes the doctrine of the Trinity.—2. One of an order of religious, instituted in 1198, who made it their business to ransom Christian captives taken by the Moors and other infidels.

**TRINITARIANISM**, *n.* The doctrine of trinitarians.

**TRINITY**, *n.* [*L. trinitas*; *tres* and *unus*, *unitas*, one, unity.] In *theol.*, the union of three persons in one Godhead, the Father, the Son, and the Holy Spirit.

In my whole essay, there is not any thing like an objection against the *Trinity*.

**TRINITY-HOUSE**, *n.* [A guild instituted in name of the Holy Trinity.] An institution for promoting commerce and navigation, by licensing pilots, erecting light houses, beacons, bnoys, &c. The most important institution of this kind is Trinity-house, of Deptford Strand, incorporated by Henry VIII., in 1515. This corporation is governed by a master, four wardens, eight assistants, and thirty-one elder brothers, besides numerous inferior members, called younger brethren. Many valuable privileges are attached to this corporation, and its revenues, which are very large, after maintaining the lights, are laid out in pensions to poor disabled seamen, and on the maintenance of their wives, orphans, &c. There are similar establishments, also charitable, at Hull, Newcastle, and Leith.

**TRINITY-SUNDAY**, *n.* The Sunday next after Whitsunday, observed by the Romish church in honour of the Trinity.

**TRINK**, *n.* A kind of fishing-net.

**TRINKET**, *n.* [If *n* is casual, this is from *W. trecciau*, to furnish. See *TRICK*.] 1. A small ornament, as a jewel, a ring, and the like.—2. A thing of little value; tackle; tools.

**TRINKET**, *v. i.* To give trinkets.

**TRINKETRY**, *n.* Ornaments of dress; trinkets.

**TRINKLE**, *v. i.* To tamper; to treat secretly or underhand.

**TRINOCIAL**, *a.* Comprising three nights.

**TRINODA**, *n.* [*L. tres*, three, and *nodus*, a knot.] An old land measure equal to three perches. *Trinoda necessitas*, in Anglo-Saxon times, was a term signifying the three services due to the king in respect of tenure of

lands in England, for the repair of bridges, the building of fortresses, and expeditions against the king's enemies.

**TRINOMIAL**, *a.* [*L. tres* and *nomen*.] In *alge.*, a trinomial quantity is an expression consisting of three terms connected by the signs + or -; as  $a + b + c$ , or  $x^2 - 2xy + y^2$ .

**TRINOMIAL**, *n.* In *alge.*, a quantity consisting of three terms.

**TRIO**, *n.* Three united.—2. In *music*, a composition for three voices or three instruments. The term *trio* is also applied to a movement in the 3rd time, which often follows the minuet in a piece of instrumental music.

**TRIOBOLAR**, } *a.* [*L. triobolaris*;  
**TRIOBOLARY**, } *tres* and *obolus*.]  
 Of the value of three oboli, or three halfpence; mean; worthless.

**TRIOCTAHEDRAL**, *a.* [*tri* and *octahedral*.] In *crystallog.*, presenting three ranges of faces, one above another, each range containing eight faces.

**TRIOCTILE**, *n.* [*L. tres*, three, and *octo*, eight.] In *astrol.*, an aspect of two planets with regard to the earth, when they are three octants or eight parts of a circle, that is, 135 degrees distant from each other.

**TRIODIA**, *n.* A genus of plants. [See *HEATH-GRASS*.]

**TRIOECIA**, *n.* [*Gr. tetis*, three, and *oecia*, a house.] The third order of plants in the class polygama, in the Linnæan system. It comprises plants with unisexual and bisexual flowers on three separate plants, or having flowers with stamens only on one, pistils on another, and bisexual flowers on a third. The fig-tree and fan-palm are examples.

**TRIOLET**, *n.* A stanza of eight lines, in which the first line is thrice repeated. It is suited to playful and light subjects.

**TRIONES**, *n.* In *astron.*, a name sometimes given to the seven principal stars in the constellation *Ursa major*, popularly called Charles's Wain.

**TRIOXYX**, *n.* A subgenus of tortoises, comprising those which are soft-shelled.

**TRIOR**, } *n.* [from *try*.] In *law*, a  
**TRIER**, } person appointed by the court to examine whether a challenge to a panel of jurors, or to any juror, is just. The *triors* are two indifferent persons.

**TRIP**, *v. i.* [*G. trippeln*; *D. trippen*; *Sw. trippa*; *Dan. tripper*; *W. tripiaw*, to trip, to stumble; from *rhip*, a skipping.] 1. To supplant; to cause to fall by striking the feet suddenly from under the person; usually followed by *up*; as, to *trip up* a man in wrestling; to *trip up* the heels.—2. To supplant; to overthrow by depriving of support.

—3. To catch; to detect.—4. To loose an anchor from the bottom by its cable or buoy-rope.

**TRIP**, *v. i.* To stumble; to strike the foot against something, so as to lose the step and come near to fall; or to stumble and fall.—2. To err; to fail; to mistake; to be deficient.

Virgil pretends sometimes to *trip*. *Dryden*.

**TRIP**, *v. i.* [*Ar. tariba*, to move lightly; allied perhaps to *Sw. trappa*, *Dan. trappe*, *G. treppe*, stairs.] 1. To run or step lightly; to walk with a light step. She bounded by and *tripp'd* so light, They had not time to take a steady sight. *Dryden*.

Thus from the lion *trips* the trembling doe. *Dryden*.

2. To take a voyage or journey.

**TRIP**, *n.* A stroke or catch by which a wrestler supplants his antagonist. And watches with a *trip* his foe to foil. *Dryden*.

2. A stumble by the loss of foot-hold, or a striking of the foot against an object.—3. A failure; a mistake.—*Figuratively*, a slight error arising from haste, or inconsideration.

Each seeming *trip*, and each digressive start. *Harte*.

4. A journey; or a voyage; an excursion or jaunt.

I took a *trip* to London on the death of the queen. *Pope*.

5. In *navigation*, a single board in plying to windward.—6. Among *seamen*, an outward bound voyage, particularly in the coasting navigation.—7. Among *farmers*, a small flock of sheep, or a small stock of them. [*Local*.]

**TRIPANG**. See *TREPANG*.

**TRIPARTED**, } *a.* [See *TRIPARTITE*.]  
**TRIPARTITE**, } In *her.*, parted into three pieces; applicable to the field as well as to ordinaries and charges; as, *triparted* in pale; a cross *triparted*.



Cross tripartite.

**TRIPARTITE**, *a.* [*Fr.* from *L. tripartitus*; *tres*, three, and *partitus*, divided; *partior*.] 1. Divided into three parts. In *bot.*, a *tripartite* leaf is one which is divided into three parts down to the base, but not wholly separate.—2. Having three corresponding parts or copies; as, indentures *tripartite*.

**TRIPARTITELY**, *adv.* By a division into three parts.

**TRIPARTITION**, *n.* A division by three, or the taking of a third part of any number or quantity.

**TRIPASCHAL**, *a.* Including three passovers.

**TRIPE**, *n.* [*Fr. id.*; *G. tripp*; *Russ. trebuch*; *W. tripa*, from *rhip*, from *rhib*, a streak or driblet. In *Sp. tripe*, *Dan. trip*, is shag, plush. This word is probably from tearing, ripping, like *strip*.] 1. Properly, the entrails; but in common usage, the large stomach of ruminating animals, prepared for food.

—2. In ludicrous language, the belly.

**TRIPEDAL**, *a.* [*L. tres* and *pes*.] Having three feet.

**TRIPE DE ROCHE**, *n.* [*Fr.*, literally, rock tripe.] A vegetable substance



Tripe de Roche (*Gyrophora mühlenbergii*).

b, One of the spores magnified.

constituting an article of food extensively used by the Canadian hunters in the arctic regions of North America. It is furnished by various species of

*Gyrophora*, all belonging to a distinct tribe of the liverworts or lichens, now constituting the genus *Umbilicaria*.

TRIPLE-MAN, *n.* A man who sells tripe.  
TRIPEN'NATE, } *a.* [*L. tres* and *penna*  
TRIPIN'NATE, } or *pinna*.] In *bot.*,  
a *tripinnate* leaf is a species of snr-  
decompound leaf, when a petiole has  
bipinnate leaves ranged on either side.  
TRIPER'SONAL, *a.* [*L. tres* and *per-*  
*sona*.] Consisting of three persons.  
TRIPER'SONALIST, *n.* A name ap-  
plied, or misapplied, to a believer in  
the trinity; a trinitarian.

TRIPERSONALITY, *n.* The state of  
existing in three persons in one God-  
head.

TRIPET'ALOID, *a.* [*Gr. τρεις, ὅλλων*,  
and *ἄλος*, resemblance.] In *bot.*, appear-  
ing as if furnished with three petals;  
as a *tripetaloid* corolla.

TRIPET'ALOUS, *a.* [*Gr. τρεις, three*,  
and *πεταλον*, leaf.] In *bot.*, three-petal-  
ed; having three petals or flower leaves.

TRIP-HAMMER, *n.* A large hammer  
used in forges.

TRIPHANE, *n.* Haüy's name for the  
mineral called Spodumene by Jameson.  
[*See* SPODUMENE.]

TRIPHA'SIA, *n.* A genus of plants;  
nat. order Aurantiaceae. The species  
are found in India, Cochín-China, and  
China. They are thorny shrubs, with  
trifoliate leaves. The fruit of *T. tri-*  
*foliata*, which is both preserved and



*Tripbasia trifoliata.*

eaten as a fruit, has an acid taste; and  
the plant is sometimes cultivated in gar-  
dens on account of the sweet-scented  
white flowers and orange berries.

TRIPH'THONG, *n.* [*Gr. τρεις, three*,  
and *φθγγη*, sound.] A coalition of three  
vowels in one compound sound, or in  
one syllable, as in *adieu, eye*.

TRIPH'THON'GAL, *a.* Pertaining to  
a triphthong; consisting of a triph-  
thong.

TRIPH'YLLOUS, *a.* [*Gr. τρεις, three*,  
and *ὄλλων*, leaf.] In *bot.*, three-leaved;  
having three leaves.

TRIPIN'NATE, *a.* Threefold pinnate.  
TRIPLE, *a.* [*Fr. from L. triplex, triplus*;  
*tres* and *plico*, to fold.] 1. Threefold;  
consisting of three united; as, a *triple*  
knot; a *triple* tie.

By thy *triple* shape as thou art seen.

*Dryden.*

2. Treble; three times repeated. [*See*  
TREBLE.]—*Triple time*, in music, is  
that in which each bar is divided into  
three measures or equal parts, as three  
minims, three crotchets, three quavers,  
&c.—*Triple salts*, the name formerly  
given to chemical compounds, consist-  
ing of one acid and two different bases;  
or of two acids and one base, but such  
salts are now more properly designated  
*double salts*, most of them consisting  
of the same acid and two different bases;  
as Rochelle salts, which are composed  
of soda, potassa, and tartaric acid.—

*Triple alliance*, in diplomatic language,  
a contract entered into by a formal and  
solemn treaty between three different  
powers, either for defensive or offensive  
purposes.

TRIP'LE, *v. t.* To treble; to make  
threefold or thrice as much or as many.  
[Usually written *treble*.]

TRIP'LE-CROWN, *n.* Dominion over  
three realms; as, Edward the First  
had pretensions to the *triple-crown*;  
namely, to being king of England,  
Scotland, and France.—2. The papal  
crown, or tiara. [*See* TIARA.]

TRIP'LE-CROWNED, *a.* Having three  
crowns.

TRIP'LED, *pp.* Made threefold.

TRIP'LE-HEADED, *a.* Having three  
heads.

TRIP'LET, *n.* [*from triple*.] Three of  
a kind, or three united.—2. In *poetry*,  
three verses rhyming together; as,  
Waller was smooth, but Dryden taught to  
join

The varying verse, the full resounding line,  
The long majestic march and energy divine.

*Pope.*

3. In *music*, triplets are notes grouped  
together by threes; as, in jigs. In com-  
mon time, where three of the quavers  
are intended to be equal in duration to  
a crotchet, the figure 3 is sometimes  
placed over them.—4. In *microscopes*,  
an eye piece, which, when used, triples  
the power of the instrument; one that  
doubles the power being termed a  
*doublet*.

TRIP'PLICATE, *a.* [*L. triplicatus, tri-*  
*plico*; *tres* and *plico*, to fold.] Made  
thrice as much; threefold.—*TriPLICATE*  
*ratio*, is the ratio which the cubes of  
two quantities bear to one another,  
compared with the ratio which the  
quantities themselves bear to each  
other: Thus the ratio of  $a^3$  to  $b^3$  is  
triplicate of the ratio of  $a$  to  $b$ . Similar  
solids are to each other in the *triplicate*  
ratio of their homologous sides or like  
linear dimensions.

TRIP'PLICATE, *n.* A third paper or  
thing, corresponding to two others of  
the same kind.

TRIP'PLICATE-TER'NATE, *a.* In *bot.*,  
thrice ternate. The same as *tritermate*,  
—*which see*.

TRIP'PLICATE-TION, *n.* The act of trebling  
or making threefold, or adding three  
together.—2. In the *civil law*, the same  
as sur-rejoinder in common law.

TRIP'PLICITY, *n.* [*Fr. triplicité*; from  
*L. triplex*.] Trebleness; the state of  
being threefold.—2. In *astrol.*, the  
division of the signs, according to the  
number of the elements, each division  
consisting of three signs.

TRIP'LING, *n.* Making threefold.

TRIP'LY, *adv.* In a threefold manner.

TRIP'LY-RIBBED, *a.* [*triple* and *rib*.]  
In *bot.*, having a pair of large ribs  
branching off from the main one above  
the base, as in the leaves of many  
species of sunflower.

TRIP-MADAM, *n.* A plant.

TRYP'OD, *n.* [*L. tripus, tripodis*; *Gr.*  
*τρεῖς, three*, and *πους, foot*.] A  
bench, stool, or seat supported by three  
legs, on which the priest and sibyls in  
ancient times were placed to render  
oracles.—2. A bowl or cup for contain-  
ing fluids, supported on a three-footed  
pedestal. In such a tripod the wine  
and water for the banquets of the  
ancients were very frequently mixed.  
Tripods were most frequently made  
of metal, but were sometimes of mar-  
ble, and they appear to have been as

much employed for ornament as for  
use.—3. Any article of furniture resting



Antique Tripod.

upon three feet, as a table, chair, &c.  
TRIP'ODIAN, *n.* An ancient stringed  
instrument.

TRIP'ODY, *n.* [*Gr. τρεις, and πους*.] A  
series of three feet.

TRIP'OLI, *n.* In *mineral.*, a mineral  
originally brought from Tripoli, used  
in polishing metals, marble, glass, &c.  
It occurs massive, with a coarse dull  
earthy fracture; it is of a yellowish  
grey, or white colour, is meagre, and  
rough to the touch, and yields readily  
to the nail. It has a fine hard grain,  
but is not compact. It imbibes water,  
which softens it, but it does not mix  
with the water. It consists chiefly of  
silica, with small portions of alumina  
and oxide of iron, but the varieties of  
tripoli vary greatly in composition, and  
appear to be composed of silicified ani-  
malcules. Tripoli is found in France,  
Italy, and Germany, as well as in Tri-  
poli. Rottenstone appears to be a  
variety of tripoli.

TRIP'OLINE, *a.* Pertaining to tripoli.

TRIPOL'TAN, *n.* A native of tripoli.

—2. *a.* Relating or belonging to Tripoli.

TRIP'OLY, *n.* Tripoli,—*which see*.

TRIP'POS, *n.* plur. *Triposes*. [*Gr. τριπους*,  
a tripod.] At the *university of Cam-*  
*bridge*, the name given to one who  
prepares what is termed a *tripo paper*.

A *tripo paper*, also called a *tripo*, is  
a printed list of the successful candi-  
dates for mathematical honours, ac-  
companied by a piece in Latin verse.  
There are two of these papers, designed  
to commemorate the two *tripo* days,  
or days of examination. The first con-  
tains the names of the wranglers, and  
senior optimes, and the second the  
names of the junior optimes. The  
word *tripo* is supposed to refer to the  
three-legged stool, formerly used at  
the examinations for these honours.

TRIP'PANT. *See* TRIPPING.

TRIP'PED, *pp.* [*from trip*.] Supplanted.

TRIP'PEL, *n.* One who trips or sup-  
plants; one that walks nimbly.

TRIP'PING, *ppr.* or *a.* Supplanting;  
stumbling; falling; stepping nimbly.—  
2. *a.* Quick; nimble.—3. In *her.*, *trip-*  
*ping*, or *trippant*, is a term used to



Tripping.

express a buck, antelope, hart, hind,  
&c., when represented with the right  
foot lifted up, and the other three feet,  
as it were, upon the ground; as if the  
animals were trotting.—*Counter-trippant*,  
is when two animals  
are borne trippant contrary ways, as if  
passing each other out of the field.

**TRIP'PING**, *n.* The act of tripping.—  
2. A light dance.—3. The losing of an anchor from the ground by its cable or buoy-rope.—*Tripping line*, a small rope serving to unring the lower top-gallant yard-arm, when in the act of lowering it down upon deck.

**TRIP'PINGLY**, *adv.* Nimbly; with a light nimble quick step; with agility. Sing and dance it *trippingly*. *Shak.* Speak the speech *trippingly* on the tongue. *Shak.*

**TRIP'SIS**, *n.* [Gr. *τριψις*, friction, the act of rubbing, from *τριβω*, to rub.] The process of rubbing and percussing the whole surface of the body, and, at the same time, flexing and extending the limbs, and racking the joints, in connection with the use of the hot bath, which is common in Egypt, Turkey, Greece, and Russia, in modern times, and which was practised by the ancients. It is used in India without the bath. In modern Greek, it is called *tripsimon*. It is also called *shampooing*.

**TRIP'TOTE**, *n.* [Gr. *τρις*, three, and *πρωτος*, case.] In *gram.*, a name having three cases only.

**TRIPU'DIARY**, *a.* [L. *tripudium*.] Pertaining to dancing; performed by dancing.

**TRIPU'DIATE**, *v. i.* [L. *tripudio*.] To dance.

**TRIPUDIA'TION**, *n.* [L. *tripudio*, to dance.] Act of dancing.

**TRIPYR'AMID**, *n.* A kind of spar composed of three-sided pyramids.

**TRIQUET'ROUS**, *a.* [L. *triquetrus*, from *triquetra*, a triangle.] Three-sided; having three plane sides.—*Triquetrous leaf*, a leaf having three longitudinal edges, as in *Mesembryanthemum deltoides*.

**TRIRA'DIATED**, *a.* [L. *tres* and *radius*.] Having three rays.

**TRIREME**, *n.* [L. *triremis*; *tres* and *remus*.] A galley or vessel with three benches or ranks of oars on a side.

**TRIRHOMBOID'AL**, *a.* [*tri* and *rhomboidal*.] Having the form of three rhombs.

**TRISACRAMENTA'RIAN**, *n.* [L. *tres*, three, and *sacramentum*.] One of a religious sect who admit of three sacraments and no more.

**TRISAG'ION**, *n.* [Gr. *τρις*, three, and *ἅγιος*, holy.] In the *Greek church*, an invocation of the Deity, in which the word *holy* is repeated three times. This invocation takes its origin from Isa. vi. 3.

**TRISE**, *v. t.* [W. *treisiaw*, to seize.] In *seamen's lan.*, to haul and tie up by means of a small rope or line, called a *trising-line*.

**TRISECT'**, *v. t.* [L. *tres*, three, and *seco*, to cut.] To cut or divide into three equal parts.

**TRISECT'ED**, *pp.* Divided into three equal parts.

**TRISECT'ING**, *ppr.* Dividing into three equal parts.

**TRISECT'ION**, *n.* [L. *tres* and *sectio*, a cutting.] The division of a thing into three parts; particularly in geometry, the division of an angle into three equal parts. The trisection of an angle, geometrically, was a problem of great celebrity among the Greek mathematicians, and in point of difficulty it is upon a footing with the duplication of the cube, and the quadrature of the circle. The indefinite trisection of an angle cannot be accomplished by plane geometry, or by the

line and circle, but it may be effected by means of the conic sections, and some other curves, as the conchoid, quadratrix, &c., the method employed by the ancient geometers. In modern analysis, there is no more difficulty of trisecting an angle than in finding a cube root.

**TRISEP'ALOUS**, *a.* In *bot.*, having three sepals, or small bracts of a calyx.

**TRISE'TUM**, *n.* A genus of grasses separated from the *Avena* of Linn. It consists of *T. flavescens*, golden oat, or yellow oat grass; and *T. pubescens*, downy oat grass. Both are natives of Great Britain, the former is common, especially in rich pastures, and sheep are very fond of it.

**TRIS'MUS**, *n.* [Gr. *τρισμα*, to gnash.] Lockjaw; a species of tetanus, affecting the under jaw with spastic rigidity. There are two kinds of trismus, one attacking infants during the two first weeks from their birth, and the other attacking persons of all ages, and arising from cold or a wound. [See *TETANUS*.]

**TRISOCTAHE'DRON**, *n.* [Gr. *τρις*, three times, *οκτω*, eight, and *ιδεα*, face.] A solid bounded by twenty-four equal faces, three corresponding to each face of an octahedron.

**TRIS'PAST**, } *n.* [Gr. *τρις* and *παστω*, **TRISPAS'TON**, } to draw.] In *mech.*, a term used by some old writers for a machine with three pulleys for raising great weights.

**TRISPERM'OUS**, *a.* [Gr. *τρις*, three, and *σπερμα*, seed.] Three-seeded; containing three seeds; as, a *trispermous* capsule.

**TRIST**, for *Tryst*,—*which see*.

**TRIST**, } *† a.* [L. *tristis*, sad.] Sad; **TRIST'FUL**, } sorrowful; gloomy.

**TRIST'FULLY**, *adv.* Sadly.

**TRISTY'TIATE**, *† v. t.* [L. *tristitia*.] To make sad.

**TRISULC'**, *† n.* [L. *trifulcus*.] Something having three furrows.

**TRISULC'ATE**, *a.* Having three furrows.

**TRISYLLAB'IC**, } *a.* [from *trisyll-* **TRISYLLAB'ICAL**, } *lable*.] Pertaining to a trisyllable; consisting of three syllables; as, a *trisyllabic* word or root.

**TRISYLL'ABLE**, *n.* [L. *tres*, three, and *syllaba*, syllable.] A word consisting of three syllables.

**TRITE**, *a.* [L. *tritius*, from *tero*, to wear.] Worn out; common; used till so common as to have lost its novelty and interest; as, a *trite* remark; a *trite* subject.

**TRITELY**, *adv.* In a common manner. **TRITENESS**, *n.* Commonness; staleness; a state of being worn out; as, the *triteness* of an observation or a subject.

**TRITERN'ATE**, *a.* [L. *tres*, three, and *ternate*.] Three times ternate. A petiole, which separates into three, and is again divided at each point into three, and on each of these nine points bears three leaflets.

**TRITHEISM**, *n.* [Fr. *tritheisme*; Gr. *τρις*, three, and *Θεος*, God.] The opinion that the Father, Son, and Holy Spirit, are three beings, or Gods.

**TRITHEIST**, *n.* One who believes that there are three distinct Gods in the Godhead, that is, three distinct substances, essences, or hypostases.

**TRITHEIST'IC**, *a.* Pertaining to tritheism.

**TRITHE'ITE**, *n.* A tritheist.

**TRITHING**, *n.* [from *three*.] One of the divisions of the county of York in England, which is divided into three parts. It is now called *Riding*.

**TRIT'ICAL**, *† a.* [from *trite*.] *Trite*; common.

**TRIT'ICALNESS**, *† n.* *Triteness*.

**TRIT'ICUM**, *n.* A genus of grasses yielding various kinds of wheat. The species are divided into two groups, the *cerealia*, yielding edible fruits, and the *agropyra*, which are merely grasses. Of the former group, the most important species are *T. vulgare*, or common wheat; *T. turgidum*, turgid, cone, or English wheat; *T. durum*, true beard wheat; *T. polonicum*, Polish wheat; *T. spelta*, spelt wheat; *T. dicoccum*, two-grained or rice wheat; and *T. monococcum*, one-grained wheat. To each of these belong several varieties of the *agropyra*, or wheat-grasses. Some are known as troublesome weeds, especially *T. repens*, creeping wheat-grass, couch-grass, or spear-grass, a native of Britain. The following are also British plants: *T. junceum*, sea wheat-grass, or rush-grass; *T. caninum*, fibrous-rooted wheat-grass, or dog's wheat; *T. cristatum*, or crested wheat-grass; and *T. loliceum*, dwarf sea wheat-grass. [See *WHEAT*.]

**TRITON**, *n.* In *myth.*, a fabled sea demi-god, supposed to be the son and trumpeter of Neptune. We find, however, a number of Tritons spoken of in ancient mythology, who were half



Mythological Triton.

man, half fish, and upon whom the Nereids rode.—2. A genus of siphonobranchiate molluscs, comprehending the marine trumpet, or triton-shell.—3. According to Laurent and others, a genus of Batrachian reptiles, or aquatic salamanders, comprehending numerous species.—4. A bird of the West Indies, famous for its notes.

**TRITONE**, *n.* [L. *tres* and *tonus*.] In *music*, a dissonant interval, called also a superfluous fourth. It consists of three tones between the extremes, or of two major and one minor tone, or of two tones and two semitones.

**TRITONIA**, *n.* A genus of marine, naked, gastropodous molluscs, many of which are found on the coasts of England, France, and other European countries.

**TRITOX'IDE**, *n.* [Gr. *τριτος*, third, and *οξιδε*.] In *chem.*, a non-acid compound of one equivalent of a base, with three equivalents of oxygen.

**TRITURABLE**, *a.* [See *TRITURATE*.] Capable of being reduced to a fine powder by pounding, rubbing, or grinding.

**TRITURATE**, *v. t.* [L. *trituro*, from *tritius*, *tero*, to wear.] To rub or grind to a very fine powder, and properly to a finer powder than that made by pulverization.

TRITURATED, *pp.* Reduced to a very fine powder.

TRITURATING, *ppr.* Grinding or reducing to a very fine powder.

TRITURATION, *n.* The act of reducing to a fine powder by grinding; levigation.

TRITURE, † *n.* A rubbing or grinding.

TRITURIUM, *n.* A vessel for separating liquors of different densities.

TRIUMPH, *n.* [Fr. *triomphe*; It. *trionfo*; L. *triumphus*; Gr. *τρίαινας*.] 1. Among the ancient Romans, a pompous ceremony performed in honour of a victorious general, and the highest military honour which he could obtain.

It was granted by the senate only to a dictator, consul, or prætor, and after a decisive victory, or the complete subjugation of a province. In a Roman triumph, the general to whom this honour was awarded, entered the city of Rome in a chariot drawn by four horses, crowned with laurel, and having a sceptre in one hand, and a branch of laurel in the other. He was preceded by the senate and magistrates, musicians, the spoils, the captives in fetters, &c., and followed by his army on foot, in marching order. The procession advanced in this order along the *via sacra* to the capitol, where the general sacrificed a bull to Jupiter, and deposited his wreath in the lap of the god. Banquets and other entertainments concluded the solemnity, which was generally brought to a close in one day, though in later times it sometimes lasted for three days. During the time of the empire, the emperor himself was the only person that could claim a triumph. The *ovation* was an honour inferior to a triumph, and less imposing in its ceremonies.—2. State of being victorious.

Hercules from Spain

Arriv'd in triumph, from Geryon slain.  
*Dryden.*

3. Victory; conquest.

The vain coquets the trifling triumphs boast.  
*Logie.*

4. Joy or exultation for success.

Great triumph and rejoicing was in heav'n.  
*Milton.*

5. A card that takes all others; now written *trump*,—which see.

TRIUMPH, *v. i.* To celebrate victory with pomp; to rejoice for victory.

How long shall the wicked triumph? Ps. xciv.

2. To obtain victory.

There fix thy faith, and triumph o'er the world.  
*Rowe.*

Attir'd with stars, we shall for ever sit  
Triumphing over death.  
*Milton.*

3. To insult upon an advantage gained.

Let not my enemies triumph over me;  
Ps. xxv.

Sorrow on all the pack of you  
That triumph thus upon my misery.  
*Shak.*

4. To be prosperous; to flourish.

Where commerce triumph'd on the favouring gales.  
*Trumbull.*

To triumph over, to succeed in overcoming; to surmount; as, to triumph over all obstacles.

TRIUMPHAL, *a.* [Fr. from L. *triumphalis*.] Pertaining to triumph; used in a triumph; as, a triumphal crown or car; a triumphal arch. A triumphal arch is a grand portico, or archway, erected at the entrance of a city, or in some public situation, in commemoration of some great victory or remark-

able event, or in honour of some victorious general. The Romans were the first people who erected triumphal arches. At first they were extremely plain and simple, but afterwards the style became enriched, and the whole was at length loaded with a profusion of every sort of ornament. Latterly, they were a rectangular mass penetrated by three arches, a central one, and two smaller side ones; as, the arches of Constantine, Septimius Severus, &c. In cases where they served as gates, they were usually constructed with two archways, one for carriages passing into the city, and the other for carriages passing out of it. Many beautiful structures, in imitation of the ancient triumphal arches, have been erected in modern times. In modern times, a temporary kind of triumphal arch is frequently, on festive occasions, formed of festoons of green branches, flowers, &c.—Triumphal column, among the Romans, an insulated column erected in commemoration of a conqueror, to whom had been decreed the honours of a triumph; as, the columns of Trajan and Antonine.—Triumphal crown, a crown usually awarded by the Romans to their victorious generals. It was formed of laurel.

TRIUMPHAL, *n.* A token of victory.

TRIUMPHANT, *a.* [L. *triumphans*.] 1. Celebrating victory; as, a triumphant chariot.—2. Rejoicing as for victory.

Successful beyond hope to lead you forth  
Triumphant out of this infernal pit.  
*Milton.*

3. Victorious; graced with conquest.

So shall it be in the church triumphant.  
*Perkins.*

Athena, war's triumphant maid.  
*Pope.*

4. Celebrating victory; expressing joy for success; as, a triumphant song.

TRIUMPHANTLY, *adv.* In a triumphant manner; with the joy and exultation that proceeds from victory or success.

Through arm'd ranks triumphantly she drives.  
*Glanville.*

2. Victoriously; with success.

Triumphantly tread on thy country's ruin.  
*Shak.*

3. With insolent exultation.

TRIUMPHER, *n.* One who triumphs or rejoices for victory; one who vanquishes.—2. One who was honoured with a triumph in Rome.

TRIUMPHING, *ppr.* Celebrating victory with pomp; vanquishing; rejoicing for victory; insulting on an advantage.

TRIUMVIR, *n.* [L. *tres*, three, and *vir*, man.] One of three men united in office. The triumvirs, L. *triumviri*, of Rome, were three men who jointly obtained the sovereign power in Rome. The first of these were Cæsar, Crassus, and Pompey.

TRIUMVIRATE, *n.* A coalition of three men; particularly, the union of three men who obtained the government of the Roman empire.—2. Government by three men in coalition.

TRIUMVIRY, † *n.* Trinumvirate.

TRIU'NE, *n.* [L. *tres*, and *unus*.] Three in one; an epithet applied to God, to express the unity of the Godhead in a trinity of persons.

TRIU'NITY, *n.* Trinity.

TRIVALV'ULAR, *a.* Three-valved; having three valves.

TRIVANT, *n.* A truant.

TRIVERB'IAL, *a.* [L. *triverbium*.] Triverbial days, in the Roman calendar,

were juridical or court days, days allowed to the prætor for hearing causes; called also *dies fasti*. There were only twenty-eight in the year.

TRIVET, *n.* A three-legged stool.

[See TREVET.]—2. A movable part of a kitchen range whereon to place vessels for boiling, or to receive something placed before the fire.

TRIVET-TA'BLE, † *n.* A table supported by three feet.

TRIVIAL, *a.* [Fr. from L. *trivialis*; probably from the Gr. *τρίβω*, L. *tero*, *trivi*, to wear, or from *trivium*, a highway.] 1. Trifling; of little worth or importance; inconsiderable; as, a trivial subject; a trivial affair.—2. Worthless; vulgar.—Trivial name, in *nat hist.*, the name for the species, which, added to the generic name, forms the complete denomination of the plant; the specific name. Thus in *Lathyrus aphaca*, *Lathyrus* is the generic name, and *aphaca* the trivial or specific name, and the two combined form the complete denomination of the plant. Linnaeus at first applied the phrase *specific name* to the essential character of the species, now called the *specific definition* or *difference*; but it is now applied solely to the trivial name.

TRIVIALITY, † *n.* Trivialness.

TRIVIALLY, *adv.* Commonly; vulgarly.—2. Lightly; inconsiderably; in a trifling degree.

TRIVIALNESS, *n.* Commonness.—2. Lightness; unimportance.

TRIV'VIUM, *n.* [L.] In the schools of the middle ages, the name given to the first three liberal arts, grammar, rhetoric, and logic; the other four, arithmetic, music, geometry, and astronomy, being termed quadrivium.

TRIV'WEEK'LY, *a.* Happening, performed, or appearing thrice a week; as, a tri-weekly newspaper. [A convenient, but not legitimately formed word.]

TROAT, *v. i.* To cry, as a buck in rutting time.

TROAT, *n.* The cry of a buck in rutting time.

TRO'CHAR, } *n.* [Fr. *un trois quart*,  
TRO'CHAR, } expressive of its triangular point.] A surgical instrument for tapping dropsical persons and the like.

TROCHA'IC, } *a.* [See TROCHEE.]  
TROCHA'ICAL, } In poetry, consisting of trochees; as, trochaic measure or verse. The trochaic verse was a kind of verse used by the Greek and Latin poets, especially by the tragedians and comedians. The most common form of this verse is that which is composed of a perfect dimeter, followed by a dimeter wanting the last half foot.

TROCHAN'TER, *n.* [Gr. *τροχωντης*.] In *anat.*, the trochanters are two processes of the thigh-bone, called *major* and *minor*, the major on the outside, and the minor on the inside.

TRO'CHE, *n.* [Gr. *τροχον*, a wheel.] A form of medicine in a circular cake or tablet, or a stiff paste cut into proper portions and dried. It is made by mixing the medicine with sugar and nuclage, and is intended to be gradually dissolved in the mouth and slowly swallowed, as a demulcent.

TRO'CHEE, *n.* [L. *trocheus*; Gr. *τροχαιος*, from *τροχον*.] In verse, a foot of two syllables, the first long, and the second short.

TROCHIDÆ, *n.* [L. *trochus*, a top,

and the name of one of the genera.] A family of testaceous turbinated gastropods.

**TRO'CHIL.** See **TROCHILUS**.

**TROCHIL'IC, a.** Having power to draw out or turn round.

**TROCHIL'ICES, n.** [Gr. τροχίλια, from τροχός: *L. trochilus*.] The science of rotary motion.

**TROCHILIDÆ, n.** [from *trochus*.] The family of humming birds.

**TRO'CHILUS, n.** [*L. trochilus*; Gr. τροχίλος, from τροχός, to run.] 1. A genus of birds, consisting of those small birds which are known by the name of hum birds, humming birds, or honey suckers. [See **HUM BIRD**.]—2. In *arch.*, an annular moulding whose section is concave; more commonly called a *Scotia*,—which see.

**TRO'CHINGS, n.** The small branches on the top of a deer's head.

**TRO'CHISK, n.** [Gr. τροχισκος.] A kind of tablet or lozenge. [See **TROCHE**.]

**TRO'CHITE, n.** [*L. trochus*; Gr. τροχός, to run.] 1. In *nat. hist.*, a kind of figured fossil stone resembling parts of plants, called St. Cuthbert's beads. These stones are usually of a brownish colour; they break like spar, and are easily dissolved in vinegar. Their figure is generally cylindrical, sometimes a little tapering. Two, three, or more of these joined, constitute an *entrochus*.—2. Fossil remains of the shells called *trochus*.

**TROCH'LEA, n.** [*L.*, a pulley, from Gr. τροχός, to run.] A pulley-like cartilage, through which the tendon of the trochlear muscle passes.

**TROCH'LEARY, a.** [from *L. trochlea*.] Pertaining to the trochlea; as, the *trochlear* muscle, the superior oblique muscle of the eye; the *trochlear* nerve, the pathetic nerve, which goes to that muscle.

**TRO'CHOID, n.** [Gr. τροχός, *L. trochus*, from τροχός, to run, and ἰδής, in *geoni*, a curve generated by the motion of a wheel; the cycloid.

**TROCHO'IDAL, a.** Pertaining to a trochoid; partaking of the nature of a trochoid; as, *trochoidal* curves. The epicycloid, the involute of the circle, the spiral of Archimedes, &c., are called *trochoidal* curves.

**TROCHOMETER, n.** [Gr.] An instrument for computing the revolutions of a carriage wheel.

**TRO'CHUS, n.** [Gr. τροχός.] A genus of conical, spiral gastropods. Most of these animals have three filaments on each edge of the mantle, or at least some appendages to the sides of the feet. The genus belongs to the Pectinibranchiate gastropods of Cuvier.

**TROD, pret. of Tread.**

**TROD,** } *pp. of Tread.*

Jerusalem shall be trodden down by the Gentiles; Luke xxi.

**TRODE, old pret. of Tread.**

**TRODE, † n.** Tread; footing; path.

**TROG'LODYTE, n.** [Gr. τρογλή, a cavern, and δύν, to enter.] The Troglodytes were a people of Ethiopia, represented by the ancients as living in caves. There are many fabulous accounts respecting the Troglodytes, but the remains of their subterraneous dwellings, still to be seen, attest their existence, especially along the banks of the Nile in Upper Egypt, and Nubia. There were also Troglodytes in parts of Syria and Arabia.—2. *Troglodytes* is the name of a genus of insectorial

birds. *Troglodytes europæus*, is known by the name of kitty wren.

**TRO'GON, or CU'RUCUI, n.** A genus of scansorial birds, and type of the family Trogonidae. The trogons are found plentifully in the Indian Archipelago, and in the tropical regions of America. They are solitary birds, jealous of their freedom, and frequenting the interior of the thickest forests.



Trogon pavo-ninus.

They feed on insects, and their flight is lively, short, vertical, and undulating. There are numerous species, all of them possessing most brilliantly coloured plumage, only second in splendour to the humming birds. The *T. pavo-ninus*, or peacock trogon, was celebrated in the mythology of the ancient Mexicans.

**TROGO'NIDÆ, n.** A family of perching birds, remarkable for the beauty of their plumage, and typically represented by the curucuis, or trogons.

**TROLL, v. t.** [G. *trollen*; W. *trolliaw*, to troll, to roll; *troelli*, to turn, wheel, or whirl; *troell*, a wheel, a reel; *trol*, a roller. It is probably formed on *roll*.] To move in a circular direction; to roll; to move volubly; to utter volubly; to draw on; to turn; to drive about.

*Troll* about the bridal bowl. *B. Jonson*.  
2. To allure, in allusion to the practice of fishing with a baited trolling line.

**TROLL, v. i.** To go round; to move or run round; to roll; to run about; as, to *troll* in a coach and six.—2. Among *anglers*, to fish, as for pikes, with a rod whose line runs on a wheel or pulley.

**TROLL, n.** A kind of reel, over which a line (called a *trolling* line) of great length is rolled, used for fishing for pikes.

**TROLLED, pp.** Rolled; turned about.

**TROLL'ER, n.** One who trolls.

**TROLLING, ppr. or a.** Rolling; turning; driving about; fishing with a rod and reel.

**TROL'LUS, n.** Globe-flower, a genus of plants. [See **GLOBE-FLOWER**.]

**TROL'LOP, n.** [G. *trolle*; from *troll*, strolling.] A stroller; a loiterer; a woman loosely dressed; a slattern.

**TROLLOPEE, † n.** Formerly, a loose dress for females.

**TROL'LOPISH, a.** Filthy; dirty; slovenly dressed.

**TROL'MYDAMES, n.** [Fr. *trou-madame*.] The game of nine holes.

**TROMBONE, n.** [It.] A deep-toned instrument of the trumpet kind, con-

sisting of three tubes; the first, to which the mouth-piece is attached, and the third, which terminates in a bell-shaped orifice, are placed side by side; the middle tube is doubled, and slides into the other two like the tube of a telescope. By the slide of the tube, every sound in the diatonic and chromatic scales being within its compass, is obtained in perfect tune, and thus the trombone surpasses every other instrument, in admitting, like the violin or the voice, the introduction of the slide. The trombone is of three kinds, the *alto*, the *tenor*, and the *base*; and in orchestral music, these are generally used together, forming a complete harmony in themselves.

**TROMP, n.** [See *Trumpet*.] A blowing machine formed of a hollow tube, used in furnaces.

**TROMPIL, n.** An aperture in a tromp.

**TRO'NA, n.** A sesquicarbonate of soda, which occurs native on the banks of the lakes of soda, in the province of Sukena, in Africa.

**TRO'NAGE, n.** Formerly, a toll or duty paid for weighing wool.

**TRO'NATOR, n.** An officer in London, whose business was to weigh wool.

**TRO'NCO, n.** [*L. truncus*.] A term in Italian music, directing a note or sound to be cut short, or just uttered and then discontinued.

**TRONE, n.** A provincial word in some parts of England for a small drain.

**TRONE, † n.** A throne.

**TRONE, } n.** A kind of steelyard or

**TRONES, } beam used in former times**

for weighing wool.

**TRO'NE WEIGHT, n.** An ancient Scottish weight used for many home productions, as wool, cheese, butter, &c. In this weight the pound varied in different counties, from 21 oz. to 28 oz. avoirdupois. Trone weight is now illegal, but is still occasionally used in some rural districts, in weighing wool, butter, &c.

**TROOP, n.** [Fr. *troupe*; It. *truppa*; Dan. *D. troop*; G. *trupp*.] The Gaelic *trapan*, a bunch or cluster, is probably the same word. The sense is a crowd, or a moving crowd.—1. A collection of people; a company; a number; a multitude. Gen. xlix.; 2 Sam. xxiii.; Hos. vii.

That which should accompany old age, As honour, love, obedience, *troops* of friends, I must not look to have. *Shak.*

2. A body of soldiers. But applied to infantry, it is now used in the plural, *troops*, and this word signifies soldiers in general, whether more or less numerous, including infantry, cavalry, and artillery. We apply the word to a company, a regiment, or an army. The captain ordered his *troops* to halt; the colonel commanded his *troops* to wheel and take a position on the flank; the general ordered his *troops* to attack; the *troops* of France amounted to 400,000 men.—3. *Troop*, in the singular, a small body or company of cavalry, light horse, or dragoons, commanded by a captain.—4. A company of stage-players.

**TROOP, v. i.** To collect in numbers. Armies at the call of trumpet, Troop to their standard. *Milton.*

2. To march in a body. I do not, as an enemy to peace, Troop in the throngs of military men. *Shak.*

3. To march in haste or in company.

**TROOPER**, *n.* A private or soldier in a body of cavalry; a horse soldier.

**TROOPING**, *ppr.* Moving together in a crowd; marching in a body.

**TROOPS**, *n. pl.* Soldiers in general; an army.

Has Norval seen the troops? *Home.*

**TROOSTE**, *n.* A mineral containing manganese.

**TROPÆOLEÆ**, *n.* A suborder of plants in the nat. order Balsaminaceæ, according to Lindley's arrangement. The genera belonging to this order, are Tropæolum, Magallana, and Chymocarpus, all natives of South America.

**TROPÆOLUM**, *n.* Indian cress, a genus of handsome trailing or climbing plants, nat. order Balsaminaceæ. The species are all inhabitants of South America. Some of them have pungent fruits, which are used as condiments, and others have obtained a place in our collections on account of their handsome and various-coloured flowers. All of them have obtained the common name of *Nasturtium*. The principal species are *T. minus*, small Indian cress, introduced into this country at an early period. The fruit is pickled, and eaten as capers, and the leaves may be eaten as a salad. *T. majus*, great Indian cress, the fruit of which is also made into a pickle. Of this plant there is a beautiful double variety much cultivated in gardens and greenhouses. *T. tricolorum*, tricolor Indian cress, the most showy and handsome of the species.

**TROPÉ**, *n.* [*L. tropus*; Gr. τροπος, from τροπα, to turn; W. trova, a turn, a tropic; trovâu, to turn.] In *rhet.*, a change in the signification of a word, from a primary to a derivative sense; a word or expression used in a different sense from that which it properly signifies; or a word changed from its original signification to another, for the sake of giving life or emphasis to an idea; as, when we call a stupid fellow an ass, or a shrewd man a fox. Tropes are chiefly of four kinds, metaphor, metonymy, synecdoche, and irony; but to these may be added, allegory, prosopopeia, autonomasia, and perhaps some others. Some authors make figures the genus, of which trope is a species; others make them different things, defining trope to be a change of sense, and figure to be any ornament, except what becomes so by such change.

**TROPÏI**, *n. plur.* [Gr. τροφος, one who feeds.] In *entom.*, the parts of the mouth employed in manducation or deglutition. They include the *labrum*, *labium*, *maxilla*, *mandibula*, *lingua*, and *pharynx*.

**TROPÏED**, *a.* [from *trophy*.] Adorned with trophies.

The trophied arches, storied halls invade.

*Pope.*

**TROPÏO'NIAN**, *a.* Pertaining to the Grecian architect Trophonius, or his cave, or his architecture.—In the *Grecian myth.*, Trophonius was a celebrated architect, the son of Erginus, king of Orchomenos, in Bœotia. He built Apollo's temple at Delphi. He is also said to have had a wonderful cave at Lebadea, whence he gave oracles, and this cave became one of the most celebrated oracles of Greece. From this circumstance, Trophonius was honoured as a god.

**TROPHOSPERM**, *n.* [Gr. τροφος, one who feeds, a nurse, and σπέρμα, seed.] In *bot.*, that part of the ovary from

which the ovules arise. It is most commonly called placenta, sometimes spermatophore, and sometimes receptacle of the seeds.

**TROPÏY**, *n.* [*L. tropæum*; Gr. τροπαιον; Fr. trophée; Sp. and It. trofeo.]

1. Among the *ancients*, a monument or memorial in commemoration of some victory. It consisted of some of the arms and other spoils of the vanquished enemy, hung upon the trunk of a tree, or a stone pillar, by the victorious army, either on the field of battle, or in the capital of the conquered nation. The custom of erecting trophies was most general among the Greeks, but it passed at length to the Romans. The Roman trophies, however, were usually constructed of more solid and durable materials than the Greek, such as towers, columns, &c. It was the practice, also, to have representations of trophies carved in stone, in bronze, and other solid substances. Many representations of trophies are to be found upon ancient medals, coins, &c.

—2. Any thing taken and preserved as a memorial of victory, as arms, flags, standards, and the like, taken from an enemy.

Around the posts hung helmets, darts and spears,

And captive chariots, axes, shields and bars,

And broken beaks of ships, the trophies of their wars. *Dryden.*

3. In *arch.*, an ornament representing the stem of a tree, charged or encompassed with arms and military weapons, offensive and defensive.—4. Something that is evidence of victory; memorial of conquest. Present every hearer to Christ as a trophy of grace.

**TROPÏY-MONEY**, *n.* A duty formerly paid in England annually by house-keepers, toward providing harness, drums, colours, &c., for the militia.

**TROPÏC**, *n.* [Fr. tropique; L. tropicus; from the Gr. τροπή, a turning; τροπικα, to turn.]—1. In *astron.*, the tropics, or tropical circles, are two parallels of declination, whose distances from the equator are each equal to the obliquity of the ecliptic, or twenty-three degrees and a half nearly. The northern one passes through the point Cancer, and is thence called the tropic of Cancer, and the southern one, which passes through the point Capricorn, is called the tropic of Capricorn. The sun's annual path in the heavens is bounded by these two circles, and they are called tropics, because when the sun, in his journey northward or southward, reaches either of them, he, as it were, turns back, and travels in an opposite direction in regard to north and south. [See ECLIPHTIC SOLSTICE.]—2. In *geography*, the tropics are two parallels of latitude, each at the same distance from the terrestrial equator as the celestial tropics are from the celestial equator. The one north of the equator is called the tropic of Cancer, and that south of the equator the tropic of Capricorn. Over these circles the sun is vertical when his declination is greatest, and they include that portion of the globe which is called the torrid zone.

**TROPÏCAL**, } *a.* Pertaining to the TROPÏC, } tropics; being within the tropics; as, tropical climates; tropical regions; tropical latitudes; tropical heat; tropical winds.—2. Incident to the tropics; as, tropical diseases.—3. [from *trope*.] Figurative; rhetorically

1068

changed from its proper or original sense.

The foundation of all parables is some analogy or similitude between the *tropical* or allusive part of the parable, and the thing intended by it. *South.*

*Tropical writing* or *hieroglyphic*, is such as represents a thing by qualities which resemble it. [See *HIEROGLYPHIC*.]

**TROPÏCALLY**, *adv.* In a tropical or figurative manner.

**TROPÏCAL YEAR**, *n.* The period occupied by the sun in passing from one tropic, or one equinox, to the other. On account of the precession of the equinoxes, it is 20 m. 20 s. shorter than the sidereal year.

**TROPÏC-BIRD**, *n.* The *Phaeton* of Linn., a genus of palmipede birds peculiar to tropical regions. There are only two species, the *P. atherus*, and *P. phœnicurus*. They are distinguished by the two long slender tail-feathers, which have obtained for them the French name of *paille-en queue*.

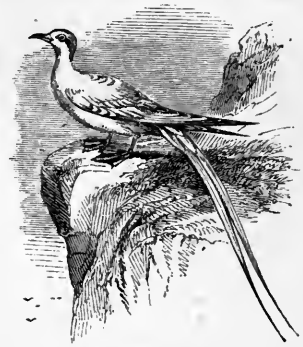

Tropic Bird (*Phaeton phœnicurus*).

The wings are long and the feet slender; their flight is swift and graceful. They are to be seen disporting in the air far at sea, and when they perceive a ship they never fail to sail round it. They generally return every evening to land, to roost in the midst of the rocks. Their food appears to consist entirely of fish.

**TROPÏCS**. See TROPÏC.

**TROPÏST**, *n.* [from *trope*.] One who explains the Scriptures by tropes and figures of speech; one who deals in tropes.

**TROPÏOLOGÏCAL**, *a.* [See TROPÏOLOGÏ.] Varied by tropes; changed from the original import of the words.

**TROPÏOLOGÏCALLY**, *adv.* In a tropological manner.

**TROPÏOLOGÏZE**, *v. t.* To change a word from its original meaning; to use as a trope. [Not authorized.]

**TROPÏOLOGÏ**, *n.* [Gr. τροπος, trope, and λογος, discourse.] A rhetorical mode of speech, including tropes, or change from the original import of the word.

**TROSS'ERS**, † *n.* Trowsers. [See TROWSERS.]

**TROT**, *v. i.* [Fr. trotter; G. trotten, to trot, to tread; It. trottare; allied probably to *tread* and to *strut*.]—1. To move faster than in walking, as a horse, or other quadruped, by lifting one fore foot and the hind foot of the opposite side at the same time.—2. To walk or move fast; or to run.

He that rises late must trot all day, and will scarcely overtake his business at night.

*Franklin.*

**TROT**, *n.* The pace of a horse or other quadruped, when he lifts one fore foot and the hind foot of the opposite side at the same time. This pace is the same as that of a walk, but more rapid. The trot is often a jolting hard motion, but in some horses it is as easy as the amble or pace, and has a more stately appearance.—2. An old woman; *in contempt*.—3. In a *ludicrous sense*, a quick sort of pace with a hobbling motion.

**TROTH**, *n.* [Sax. *troethe*; the old orthography of *truth*. See **TRUTH**.]—1.† Belief; faith; fidelity; as, to plight one's *troth*.—2.† Truth; verity; veracity; as, in *troth*; by my *troth*.

**TROTH'LESS**, † *a.* Faithless; treacherous.

**TROTH'-PLIGHT**, † *v. t.* To betroth or affianc.

**TROTH'-PLIGHT**, † *a.* Betrothed; espoused; affianced.

**TROTH'-PLIGHT**, *n.* The act of betrothing or plighting faith.

**TROTH'-PLIGHTED**, *a.* Having fidelity pledged.

**TROT'TER**, *n.* A beast that trots, or that usually trots.—2. A sheep's foot.

**TROT'TING**, *ppr.* Moving with a trot; walking fast, or running.

**TROUBADOUR**, *n.* [from Fr. *trouver*, to find.] Literally a finder or inventor, a name given to a poet in Provence in France. The troubadours were considered the inventors of a species of provençal poetry, characterized by an almost entire devotion to the subject of romantic gallantry, and generally very complicated in regard to its metre and rhymes. They flourished from the 11th to the latter end of the 13th century, their principal residence being the South of France, but they also lived in Catalonia, Arragon, and the North of Italy. The most renowned among the troubadours were knights who cultivated music and poetry as an honourable accomplishment.

**TROUBLE**, *v. t.* (trub'l.) Fr. *troubler*; It. *turbare*; Sp. and Port. *turbar*; L. *turbo*; Gaelic, *treabhlaim*, which seems to be connected with *treabham*, to plough, that is, to turn or to stir, W. *torva*, L. *turba*, a crowd, and perhaps *trova*, a turn; Gr. *τροβω*. The primary sense is to turn or to stir, to whirl about, as in L. *turbo*, *turbinis*, a whirlwind. Hence the sense of agitation, disturbance.] 1. To agitate; to disturb; to put into confused motion.

God looking forth will trouble all his host.

Milton.

An angel went down at a certain season into the pool, and troubled the water; John v.

2. To disturb; to perplex.

Never trouble yourself about those faults which age will cure. Locke.

3. To afflict; to grieve; to distress. Those that trouble me, rejoice when I am moved; Ps. xiii.

4. To busy; to cause to be much engaged or anxious.

Martha, thou art careful, and troubled about many things; Luke x.

5. To tease; to vex; to molest.

The boy so troubles me,

\*Tis past enduring. Shak.

6. To give occasion for labour to. I will not trouble you to deliver the letter. I will not trouble myself in this affair.—7. To sue for a debt. He wishes not to trouble his debtors.

**TROUBLE**, *n.* (trub'l.) Disturbance of mind; agitation; commotion of spirits;

perplexity; a word of very extensive application.—2. Affliction; calamity.

He shall deliver thee in six troubles; Job v.

Redeem Israel, O God, out of all his troubles; Ps. xxv.

3. Molestation; inconvenience; annoyance.

Least the fiend some new trouble raise.

Milton.

4. Uneasiness; vexation.—5. That which gives disturbance, annoyance, or vexation; that which afflicts.

**TROUBLED**, *pp.* (trub'ld.) Disturbed; agitated; afflicted; annoyed; molested.

**TROUBLER**, *n.* (trub'ler.) One who disturbs; one who afflicts or molests; a disturber; as, a *troubler* of the peace.

The rich *troublers* of the world's repose.

Waller.

**TROUBLESOME**, *a.* (trub'some.) Giving trouble or disturbance; molesting; annoying; vexatious. In warm climates, insects are very *troublesome*.—2. Burdensome; tiresome; wearisome.

My mother will never be *troublesome* to me.

Pope.

3. Giving inconvenience to. I wish not to be *troublesome* as a guest.—4. Teasing; importunate; as, a *troublesome* applicant.

**TROUBLESÖMELY**, *adv.* (trub'lsöme.) In a manner or degree to give trouble; vexatiously.

**TROUBLESÖMENESS**, *n.* (trub'lsömeness.) Vexatiousness; the quality of giving trouble or of molesting.—2. Unseasonable intrusion; importunity.

**TROUBLE-STATE**, † *n.* A disturber of the community.

**TROUBLING**, *ppr.* (trub'ling.) Disturbing; agitating; molesting; annoying; afflicting.

**TROUBLING**, *n.* (trub'ling.) The act of disturbing or putting in commotion; John v.—2. The act of afflicting.

**TROUBLOUS**, *a.* (trub'lus.) Agitated; tumultuous; full of commotion.

A tall ship toss'd in *troubulous* seas.

Spenser.

2. Full of trouble or disorder; tumultuous; full of affliction.

The street shall be built again, and the wall, even in *troubulous* times; Dan. ix.

**TROUGH**, *n.* (trauf.) [Sax. *trog*; D. and G. *trog*; It. *truogo*.] 1. A vessel hollow longitudinally, a vessel of wood, stone, or metal, in the form of a rectangular prism, open at the top, for holding water, &c.—2. A tray. [*This is the same word dialectically altered.*]

—3. A canoe; the rude boat of uncivilized men.—4. The channel that conveys water, as in mills. The *trough* of the sea, the hollow between waves.—Galvanic trough. [See under GALVANIC.]

**TROUGH'-BATTERY**, *n.* A galvanic battery. [See GALVANIC.]

**TROUGH'-GUTTER**, *n.* In *arch.*, a gutter in the form of a trough, placed below the dripping eaves of common buildings and outhouses, to convey the water from the roof to the pipe by which it is to be discharged.

**TROÛL**, for *Troll*. [See **TROLL**.]

**TROUNCE**, *v. t.* (trouns.) [Qu. Fr. *tronçon*, *tronçonner*.] To punish, or to beat severely. [*A low word.*]

**TROUN'CING**, *ppr.* Beating severely.

**TROUN'CING**, *n.* A severe beating.

**TROUSE**, *n.* (trooz.) [See **TROUSERS**.]

A kind of trousers worn by children.

**TROUSERS**, *n. plur.* See **TROUSERS**.

**TROUSSEAU**, *n.* [Fr.] Paraphernalia; the clothes, &c., of a bride.

**TROUT**, *n.* [Sax. *truht*; Fr. *truite*; L. *trutta*. *Trout* is contracted from *tracta*.] The common name of various species of the genus *Salmo*; as, the bull-trout (*Salmo eriox*); the salmon-trout (*S. trutta*); the common trout (*S. fario*); and the great grey or lake-trout (*S. ferox*). The parr or samlet (*S. salmus*) is also sometimes called a trout.

**TROUT'-COLOURED**, *a.* White with spots of black, bay, or sorrel; as, a *trout-coloured* horse.

**TROUT'-FISHING**, *n.* The fishing for trouts. [This term is often synecopated into *trouting*; and the latter word occasionally becomes an adjective, as in a *trouting* stream.]

**TROUT'LET**, } *n.* A small trout.

**TROUT'LING**, } [*Collog.*]

**TROUT'-STREAM**, *n.* A stream in which trout breed.

**TROVER**, *n.* [Fr. *trouver*, It. *trovare*, to find; Sw. *träffa*, to hit; Dan. *treffer*, to meet with; *traf*, an accident; D. and G. *treffen*, to meet, to hit.] Trover is properly the finding of any thing. Hence, 1. In *law*, the gaining possession of any goods, whether by finding or by other means.—2. A form of action which lies in general against a defender, for the conversion or appropriation to his own use of any personal property, in which the plaintiff has a general property as owner, or special property as carrier, depository, trustee, &c. It will lie for deeds, unstamped agreements, bills unlawfully withheld, under a verbal promise of being discounted, for goods wrongfully distrained, money deposited, or any other personal chattel. The action is brought to recover the specific chattels themselves, or damages for their conversion.

**TROW**, † *v. i.* [Sax. *treovian*, *treowan*, to believe, to trust; G. *trauen*; Sw. *tro*; Dan. *troer*; contracted from *trogan*, and coinciding with the root of *truth*. See **TRUE**.] To believe; to trust; to think or suppose.

**TROW**, is used in the imperative, as a word of inquiry. What means the fool, *trow*?

**TROWEL**, *n.* [Fr. *truelle*; L. *trulla*; D. *traffel*. Qu. D. and G. *treffen*, to hit, to strike, hence to put on.] 1. A tool used by masons, plasterers, and bricklayers, for spreading and dressing mortar and plaster, and for cutting bricks so as to reduce them to the required shape and dimensions. Trowels are of various kinds, according to the different purposes for which they are used.—2. A gardener's tool, somewhat like a trowel, made of iron, and scooped; used in taking up plants and for other purposes.

**TROW'ELED**, *a.* Dressed or formed with a trowel; as, *trowelled* stucco; that is, stucco laid on, and ready for the reception of paint.

**TROWSERS**, *n. plur.* *s. as z.* [Gaelic, *truisan*; Fr. *trousse*, a truss, a bundle; W. *trus*, a garment that covers; *trouse*, dress; *trusa*, a truss, a packet; *truisiaw*, to dress; Gaelic, *trusam*, to gird or *truss* up.] A loose garment worn by males, extending from the waist to the knee, or to the ankle, and covering the lower limbs.

**TROY**, } *n.* ["A corruption  
**TROY-WEIGHT**, } of *le roy*; *pondus regis*, the standard weight of 35 Edward I."—Dr. Truster. Some derive the word from *Troyovant*, the Monkish

name of London; and others from *Troyes*, in France. The etymology is uncertain.] A weight chiefly used in weighing gold, silver, and articles of jewelry. It is also used for comparing different weights with each other, and in experiments in natural philosophy. The pound troy contains 12 ounces; each ounce is divided into 20 pennyweights, and each pennyweight into 24 grains. Hence, the pound contains 5,760 grains.

**TRU'ANT**, *a.* [Fr. *truand*.] Idle; wandering from business; loafing; as, a *truant* boy.

While *truant* Jove, in infant pride,  
Play'd barefoot on Olympus' side.

*Trumbull.*

**TRU'ANT**, *n.* An idler; an idle boy; a boy who stays away from school.

**TRU'ANT**, *v. i.* To idle away time; to loiter or be absent from employment.

**TRU'ANTLY**, *adv.* Like a truand; in idleness.

**TRU'ANT-SHIP**, *n.* Idleness; neglect of employment; neglect of study.

**TRUBS**, *n.* An herb.

**TRUB'TAIL**, *n.* A short squat woman.

**TRUCE**, *n.* [Goth. *trigwa*; It. *tregua*; Norm. *trewe*; Ice. *trigd*; Cimbric, *trugth*; properly a league or pact, from the root of *trick*, to make fast, to fold. See **TRUE**.] 1. In war, a suspension of arms by agreement of the commanders; a temporary cessation of hostilities, either for negotiation or other purpose.—2. Intermission of action, pain, or contest; temporary cessation; short quiet.

There he may find

*Truce* to his restless thoughts. *Milton.*

*Truce of God*, in the middle ages, a suspension of arms which occasionally took place, and was introduced by the church in order to mitigate the evils of war. This truce provided that hostilities should cease at least on the holidays from Thursday evening to Sunday evening each week, during the season of Advent and Lent, and on the octaves of the great festivals.

**TRUCE-BREAKER**, *n.* [*truce* and *breaker*.] One who violates a truce, covenant, or engagement; 2 Tim. iii.

**TRUCE'LESS**, *a.* Without a truce.

**TRUCH'MAN**, } *n.* An interpreter.

**TRUDGE'MAN**, } [See **DRAGMAN**.]

**TRUCIDA'TION**, *n.* [L. *trucido*, to kill.] The act of killing.

**TRUCK**, *v. i.* [Fr. *troquer*; Sp. and Port. *trocar*; allied probably to W. *truc*, L. *trochus*, a round thing, Eng. *truck*; Gr. *τροχος*, *τροχον*.] To exchange commodities; to barter. American traders *truck* with the Indians, giving them whisky and trinkets for skins. [*Truck* is now vulgar.]

**TRUCK**, *v. t.* To exchange; to give in exchange; to barter; as, to *truck* knives for gold dust. [*Vulgar*.]

**TRUCK**, *n.* Permutation; exchange of commodities; barter.—2. A small wooden wheel not bound with iron; a cylinder.—3. In ships, the small wooden cap at the extremity of a flag-staff, or of a topmast, generally furnished with two or more small pulleys, and used to reeve the halliards. Also, a small circular piece of wood, having a hole bored through it for a rope to run through; as, the *trucks* of the shrouds.—4. In gunnery, trucks are circular pieces of wood like wheels, fixed on an axle-tree, for moving ordnance.—5. In railways, a kind of platform running upon wheels and used for the convey-

ance of ordinary stage-coaches and carriages, which are placed upon it.—6. A small wheel carriage, or a species of barrow with two wheels, to be moved by hand. Trucks of this description are made in a great variety of forms, to adapt them to their peculiar objects, such as the moving of sacks, bags, casks, cases, lead, iron, copper, stone, &c., in warehouses, granaries, &c.—*Truck*, or *truchs*, is also the name given to a kind of low carriage for conveying goods, stones, &c., on common roads.

**TRUCK'AGE**, *n.* The practice of bartering goods.

**TRUCK'ER**, *n.* One who traffics by exchange of goods.

**TRUCK'ING**, *ppr.* Exchanging goods; bartering.

**TRUCK'LE**, *n.* A small wheel or castor.—2. A small flat cheese. [*Local*.]

**TRUCK'LE**, *v. i.* [*dim.* of *truck*.] To yield or bend obsequiously to the will of another; to submit; to creep. Small states must *truckle* to large ones.

Religion itself is forced to *truckle* with worldly policy. *Norris.*

**TRUCK'LE-BED**, *n.* [*truckle* and *bed*.] A bed that runs on wheels and may be pushed under another; a trundle-bed.

**TRUCK'LING**, *ppr.* Yielding obsequiously to the will of another.

**TRUCK'-MAN**, *n.* A truck driver.

**TRUCK'-SYSTEM**, *n.* The practice of paying the wages of workmen in goods instead of money. This practice prevailed, particularly in the mining and manufacturing districts. The masters established warehouses or shops, and the workmen in their employment either got their wages accounted for to them by supplies of goods from such *depôts*, without receiving any money, or they got the money on a tacit or express understanding that they were to resort to the warehouses or shops of their masters for such necessaries as they required. The ostensible design of this system was to supply the workmen and their families with provisions, clothing of good quality, &c., at the cheapest rate, and thus to leave them but little money for the purposes of drinking and idleness. The truck system, however, was liable to great abuses. It gave rise to unfair dealing, and a species of tyranny; the workmen had often to pay exorbitant prices for their goods, and from the great facility afforded to them of procuring liberal supplies of goods in anticipation of wages, they were led into debt. These, and other evils incident to the truck system, induced the legislature to put a stop to it by an act passed in 1831.

**TRUC'ULENCE**, *n.* [L. *truculentia*, from *trux*, fierce, savage.] 1. Savagery of manners; ferociousness.—2. Terribleness of countenance.

**TRUC'ULENT**, *a.* Fierce; savage; barbarous; as, the *truculent* inhabitants of Scythia.—2. Of a ferocious aspect.—3. Cruel; destructive; as, a *truculent* plague.

**TRUC'ULENTLY**, *adv.* Fiercely; destructively.

**TRUDGE**, *v. i.* To travel on foot. The father rode; the son *trudged* on behind.

—2. To travel or march with labour. And *trudg'd* to Rome upon my naked feet.

*Dryden.*

**TRUE**, *a.* [Sax. *treow*, *treowe*, faithful, and as a noun, faith, trust; G. *treu*;

D. *trouw*, trust, loyalty, fidelity, faith; *trouwen*, to marry; Goth. *triggus*, faithful; *trigga*, a pact or league, a *truce*. This is the real orthography, coinciding with Sw. *trugg*, Dan. *trug*, safe, secure, and W. *trigiau*, to stay, to tarry, to dwell, that is, to stop, to set. The primary sense of the root is to make close and fast, to set, or to stretch, strain, and thus make straight and close.] 1. Conformable to fact; being in accordance with the actual state of things; as, a *true* relation or narration; a *true* history. A declaration is *true*, when it states the facts. In this sense, *true* is opposed to *false*.—2. Genuine; pure; real; not counterfeit, adulterated or false; as, *true* balsam; the *true* bark; *true* love of country; a *true* Christian.

The *true* light which lighteth every man that cometh into the world; John i.

3. Faithful; steady in adhering to friends, to promises, to a prince or to the state; loyal; not false, fickle, or perfidious; as, a *true* friend; a *true* lover; a man *true* to his king, *true* to his country, *true* to his word; a husband *true* to his wife; a wife *true* to her husband; a servant *true* to his master; an officer *true* to his charge.—4. Free from falsehood; as, a *true* witness.—5. Honest; not fraudulent; as, good men and *true*.

If King Edward be as *true* and just.

*Shak.*

6. Exact; right to precision; conformable to a rule or pattern; as, a *true* copy; a *true* likeness of the original.—

7. Straight; right; as, a *true* line; the *true* course of a ship.—8. Not false or pretended; real; as, Christ was the *true* Messiah.—9. Rightful; as, Victoria is the *true* Queen of England.—*True Bill*. See under **BILL**.—*True place* of a star or planet, in *astron.*, is the place which the star or planet would occupy, if the effects of refraction, parallax, &c., were removed, or the place which it would occupy, if seen from the earth's centre, supposing the rays coming from it not to be subject to refraction.

**TRUE'BLUE**, *a.* An epithet applied to a person of inflexible honesty and fidelity; from the *true* or *coventry blue*, formerly celebrated for its unchanging colour.

**TRUEBORN**, *a.* [*true* and *born*.] Of genuine birth; having a right by birth to any title; as, a *trueborn* Englishman.

**TRUEBRED**, *a.* [*true* and *bred*.] Of a genuine or right breed; as, a *truebred* beast.—2. Being of genuine breeding or education; as, a *truebred* gentleman.

**TRUEHEARTED**, *a.* [*true* and *heart*.] Being of a faithful heart; honest; sincere; not faithless or deceitful; as, a *truehearted* friend.

**TRUEHEARTEDNESS**, *n.* Fidelity; loyalty; sincerity.

**TRUELOVE**, *n.* [*true* and *love*.] One really beloved.—2. A plant of the genus *Paris*, the *P. quadrifolia*, called also Herb Paris, which see.

**TRUELOVE**, *n.* Affectionate; sincere.

**TRUELOVE-KNOT**, } *n.* [Qu. is **TRUELOVE'S-KNOT**,] not this from the Dan. *trolover*, to betroth, to promise in marriage; *troe*, true, and *lover*, to promise; the knot of faithful promise or engagement.] A kind of double knot, made with two bows on each side interlacing each other and



with two ends; the emblem of interwoven affection or engagements.

**TRUENESS, n.** Faithfulness; sincerity.—2. Reality; genuineness.—3. Exactness; as, the *trueness* of a line.

**TROEPEPENNY, † n.** [*true* and *penny*] A familiar phrase for an honest fellow.

**TROESERVICE, } n.** A plant of  
**TROESERVICE-TREE, }** the genus  
Pyrus, the *P. domestica*. [See *PYRUS*.]  
**TRUF'FLE, n.** [Fr. *truffe*; Sp. *trufa*,  
deceit, imposition, and *truffles*; and if  
this vegetable is named from its growth  
under ground, it accords with *It. truffare*,  
to deceive.] A subterraneous vegetable  
production, of the genus  
Tuber, the *T. cibarium*. It is a kind



Truffle (*Tuber cibarium*).

of mushroom, of a fleshy fungous structure and roundish figure, without any visible root; of a dark colour, approaching to black, and studded over with tubercles. It grows abundantly in some parts of England; also in Italy, the South of France, and several other countries. It is much esteemed and sought after as an ingredient in certain high seasoned dishes. Several other species of the genus Tuber are called truffles. The *T. moschatum* is called the musk-scented truffle. There being no appearance above ground to indicate the existence of the truffle, which lies concealed some inches under the surface of the clayey sandy soil, dogs are trained to discover these productions by the scent. As soon as the dog finds one, he barks and scrapes, and the truffle hunter follows and digs up the object of his pursuit.

**TRUF'FLE-WORM, n.** A worm found in truffles, the larva of a fly, a species of *Leiodes*.

**TRUF'FLED, a.** Furnished, cooked, or stuffed with truffles; as, a *truffled* turkey is a favourite French dish.

**TRUG, n.** A hod for mortar. This is our *trough* and *tray*; the original pronunciation being retained in some parts of England. The word was also used formerly for a measure of wheat, as much as was carried in a trough; three *trugs* making two bushels.

**TRU'ISM, n.** [from *true*.] An undoubted or self-evident truth.

Trifling *truisms* clothed in great swelling words of vanity. J. P. Smith.

**TRULL, n.** [W. *trolliaw*, to troll or roll, whence *stroll*; or *truliaw*, to drill. Qu. Gr. *μαρτύλλω*.] A low vagrant trumpet.

**TRULL, v. t.** To trundle. [Local.]

**TRULLIZA'TION, n.** [L. *trullisio*.] The laying of strata of plaster with a trowel.

**TRULY, adv.** [from *true*.] In fact; in deed; in reality.—2. According to truth; in agreement with fact; as, to see things *truly*; the facts are *truly* represented.—3. Sincerely; honestly; really; faithfully; as, to be *truly*

attached to a lover. The citizens are *truly* loyal to their prince or their country.—4. Exactly; justly; as, to estimate *truly* the weight of evidence.

**TRUMP, n.** [It. *tromba*; Gaelic, *trompa*. See *TRUMPET*.] 1. A trumpet; a wind instrument of music; a poetical word used for *trumpet*. It is seldom used in prose, in common discourse; but is used in Scripture, where it seems peculiarly appropriate to the grandeur of the subject.

At the last *trump*; for the trumpet shall sound, and the dead shall be raised; 1 Cor. xv; 1 Thess. iv.

2. [contracted from *triumph*; It. *trionfo*, Fr. *trionphe*.] A winning card; one of the suit of cards which takes any of the other suits.—3. An old game with cards.—To *put to the trumps*, or to *put on the trumps*, to reduce to the last expedient, or to the utmost exertion of power.—4. A Jew's harp. [Scotch.]

**TRUMP, v. t.** To take with a trump card; to put a trump card upon in order to win, or in accordance with the rules of the game.—2. † To obtrude; also, to deceive or impose upon. [Fr.] *trumper*.—To *trump up*, to devise; to forge; to seek and collect from every quarter; as, to *trump up* a story.

**TRUMP, † v. i.** To blow a trumpet.—2. To play a trump card.

**TRUMP'ED, pp.** Taken with a trump card; devised; forged, with *up*.

**TRUMP'ERY, n.** [Fr. *tromperie*.] 1. Falsehood; empty talk; trifles.—2. Useless matter; things worn out and cast aside.

**TRUMP'ERY, a.** Trifling; worthless.

**TRUMP'ET, n.** [It. *tromba*, *trombetta*; Fr. *trompette*; Gaelic, *trompa*, *trompaid*; G. *trompete*; Dan. *trompette*; Arm. *trompett*. The radical letters and the origin are not ascertained.] 1. A wind instrument of music of the highest antiquity, used chiefly in war and military exercises. It consists of a folded tube, generally of brass, but sometimes of silver, with a large bell-shaped aperture at one end for the emission of the sound, and a mouth piece at the other, adapted for blowing into the instrument with the mouth. The natural scale of the trumpet is limited, but by means of slides and keys, the number of notes may be greatly increased. It is the loudest of all portable wind instruments, and from its exciting effect, is well adapted for military music. It is used also for giving signals, and accompanies flags of truce, heralds, &c.

The *trumpet's* loud clangor

Excites us to arms.

Dryden.

*Speaking trumpet*, an instrument for increasing the intensity of articulate sounds, and transmitting them to considerable distances in a particular direction. It is constructed of various forms, but usually consists of a tin or copper tube from six to twelve or more feet long, of such a form that its diameter becomes greater towards the extremity furthest from the mouth. The mouth piece is made large enough to admit both lips. Philosophers are not agreed as to the best form of the speaking trumpet, as the theory of the instrument is attended with considerable difficulty. The sound which the trumpet conveys in one direction is supposed to be increased not so much from its being prevented from spreading in all directions, as by repeated reflections of the sound from the sides

of the trumpet. The speaking trumpet is chiefly used at sea.—*Ear trumpet*. [See among the compounds of EAR.]—*Trumpet marine*, an old musical stringed instrument. It was played with a bow, and the sounds were stopped by the fingers gently touching the string, so as to produce the harmonies of the string in the same manner as is practised on the violin.—*Feast of trumpets*, a feast among the Jews, which was held on the first and second days of the month Tisri, which was the commencement of the Jewish civil year. It derived its name from the blowing of trumpets in the temple with more than usual solemnity.—2. In the military style, a trumpeter.

He wisely desired that a *trumpet* might be first sent for a pass. Clarendon.

3. One who praises or propagates praise, or is the instrument of propagating it. A great politician was pleased to be the *trumpet* of his praises. **TRUMP'ET, v. t.** To publish by sound of trumpet; also, to proclaim; as, to *trumpet* good tidings.

They did nothing but publish and *trumpet* all the reproaches they could devise against the Irish. Bacon.

2. To sound the praises of.

**TRUMP'ET-CALL, n.** A call at the sound of the trumpet.

**TRUMP'ETED, pp.** Sounded abroad; proclaimed.

**TRUMP'ETER, n.** One who sounds a trumpet.—2. One who proclaims, publishes, or denounces.

These men are good *trumpeters*. Bacon.

3. A bird, a variety of the domestic pigeon. Also, a bird of South America, of the genus *Psophia*, the *P. crepitans*,



Trumpeter (*Psophia crepitans*).

called also *Agami*. It is of the size of a pheasant or large fowl, has a long neck, and stands high on its legs. It is so called from its uttering a hollow noise, like that of a trumpet. It is easily tamed, and becomes attached to its benefactor with all the fondness and fidelity of the dog.

**TRUMP'ET-FISH, n.** A fish of the genus *Centriscus*, (*C. scolopax*;) so named from its tubular muzzle. It is also called *sea-snipe* and *Bellows fish*.

**TRUMP'ET-FLOWER, n.** A flower of the genus *Bignonia*, another of the genus *Tecoma*, and another still of the genus *Lonicera*.

**TRUMP'ET HONEY-SUCKLE, n.** A plant of the genus *Lonicera*.

**TRUMP'ETING, pp.** Blowing the trumpet; proclaiming.

**TRUMP'ET-FLY, n.** An insect; a gray fly.

**TRUMP'ET-SHAPED, a.** Formed like a trumpet.

**TRUMP/PET-SHELL**, *n.* The shell of the *Triton variegatus*, found on the coasts of the West Indies, of Asia, and of the South Sea Islands. It is used by the natives of the last named localities as a trumpet, to call warriors and herds of cattle together. It is said to answer the purpose tolerably well, producing a very sonorous blast.



Trumpet shell  
(*Triton variegatus*).

**TRUMPET-TONGUED**, *a.* Having a tongue vociferous as a trumpet.

**TRUMPET-TREE**, *n.* A name given to *Cecropia*, one of the plants of the nat. order *Artocarpeae*.

**TRUMPING**, *ppr.* Taking with a trumpet.

**TRUMP-LIKE**, *a.* Resembling a trumpet.

**TRUNCATE**, *v. t.* [*L. truncus*, to cut off; *Fr. tronquer*, *W. trygu*, *Arm. troucha*.] To cut off; to lop; to maim.

**TRUNCATE**, *a.* In *bot.*, a *truncate* leaf is one which appears as if cut off at the tip by a transverse line; as in *Liriodendron tulipifera*.

**TRUNCATED**, *pp.* Cut off; cut short; maimed. A *truncated* cone or pyramid is one whose vertex is cut off by a plane parallel to its base; the frustum of a cone or pyramid.—2. In *mineral.*, having a solid angle or edge cut off, so as to produce a new surface or plane; as a crystal.

**TRUNCATING**, *ppr.* Cutting off.

**TRUNCATION**, *n.* The act of lopping or cutting off.—2. A state of being truncated.—3. In *mineral.*, a term used to signify that change in the geometrical form of a crystal, which is produced by the cutting off of an angle or edge, so as to leave a face more or less large in place of the edge or angle. When the face thus produced does not make equal angles with all the contiguous faces, the truncation is said to be *oblique*. The secondary forms of crystals may be supposed to be produced by *truncations* of the solid angles or edges of any of the primary forms. [See *CRYSTALLOGRAPHY*.]

**TRUNCHEON**, *n.* [*Fr. tronçon*, from *tronc*, trunk, *L. truncus*.] A short staff; a club; a cudgel; a baton; used by kings and great officers as a mark of command.

The marshal's *truncheon* nor the judge's robe. *Shak.*

*Truncheons*, a name given to large sets, stakes, or poles of willow, poplar, &c., planted on sandy downs on the sea shore, which growing up quickly into trees, fix the soil, and prevent it from being drifted by the winds.

**TRUNCHEON**, *v. t.* To beat with a truncheon; to cudgel.

**TRUNCHEONEER**, *n.* A person armed with a truncheon.

**TRUNDLE**, *v. i.* [*Sax. trændle*; *trendle*, any round body; *Dan.* and *Sw. trind*, round; *W. trôn* a circle, a round, a throne; *tróni*, to rim; from the root of *rundle*, *round*.] 1. To roll, as on little wheels; as, a bed *trundles* under another.—2. To roll; as a bowl.

**TRUNDLE**, *v. t.* To roll, as a thing on

little wheels; as, to *trundle* a bed or a gun-carriage.

**TRUNDLE**, *n.* A round body; a little wheel.—2. In *mech.*, a small wheel or pinion, having its teeth formed of cylinders or spindles; also called a *lantern* or *wallower*. [See *LANTERN-WHEEL*.]—3. A small carriage with low wheels; a truck,—*which see*.

**TRUNDLE-BED**, *n.* A bed that is moved on trundles or little wheels; called also *truckle-bed*.

**TRUNDLED**, *pp.* Rolled.

**TRUNDLE-HEAD**, *n.* The wheel that turns a mill-stone.

**TRUNDLE-TAIL**, *n.* A round tail; a dog so called from his tail.

**TRUNDLING**, *ppr.* Rolling, as a thing on little wheels.

**TRUNK**, *n.* [*Fr. tronc*; *It. troncone*; *Sp. tronco*; *L. truncus*, from *trunco*, to cut off. The primitive Celtic word of this family is in *Fr. trancher*, *It. trinciare*, *Sp. trincar*, *trincar*. The *n* is not radical, for in *Arm.* the word is *troucha*, *W. trygu*.] 1. The woody stem of trees, such as the oak, ash, and elm; that part of a plant which, springing immediately from the root, ascends in a vertical position above the surface of the soil, and constitutes the principal bulk of the individual. It is peculiar to dicotyledonous plants, and may be described as of an elongated conical form, its diameter being greatest at the base, and gradually becoming less to the top, where it sends out branches whose structure is similar to that of the trunk. In shrubs, properly speaking, that part which is between the root and the branches is called the *stem*; shrubs having no trunk in the strict sense of the term.—2. The body of an animal without the limbs.—3. The main body of any thing; as, the *trunk* of a vein or of an artery, as distinct from the branches.—4. The snout or proboscis of an elephant; the limb or instrument with which he feeds himself.—5.† The proboscis of an insect, by means of which it sucks the blood of animals or the juices of vegetables.—6. In *entom.*, that segment of the body of an insect, which is between the head and abdomen, and which bears the organs of motion.—7. In *arch.*, the shaft of a column; that part between the base and capital. Also, a vessel open at each end for the discharge of water, rain, &c. The term is sometimes used to signify the dado or body of a pedestal.

—8. A long tube through which pellets of clay are blown.—9. A box or chest covered with skin for containing clothes, &c.—10. A covered sluice; also a water course made of planks, and generally to conduct the water from the race to the water wheel.—*Fire-trunks*, in fire ships, wooden funnels fixed under the shrouds to convey or lead the flames to the masts and rigging.

**TRUNK**, † *v. t.* To lop off; to curtail; to truncate.

**TRUNKED**, † *pp.* Cut off; curtailed.—2. *a.* Having a trunk.—3. In *her.*, an epithet applied to a tree which is borne couped of all its branches, and separated from its roots. Also, when the main stem of a tree is borne of a different tincture from the branches, it is said to be *trunked*.

**TRUNK-FISH**, *n.* A sea-fish; the ostracion.

**TRUNK-HOSE**, *n.* [*trunk* and *hose*.] In *costume*, a kind of short wide

doublet and trunk-hose.

as French, Gallic or Venetian. This garment prevailed during the reign of Henry VIII, Elizabeth and James I.

**TRUNK-MAKER**, *n.* One who makes trunks; as, "many a dull book, else unseen, comes partially to light in the linings of the *trunk-maker's* works."

**TRUNNION**, *n.* [*Fr. trognon*.] The trunnions of a piece of ordnance, are two knobs which project from the opposite sides of a piece, whether gun, mortar, or howitzer, and serve to support it on the cheeks of the carriage. Trunnions are also employed in a similar manner in vibrating steam-engines, and in a variety of other machines.

**TRUNNION-PLATE**, *n.* The trunnion-plates are two plates in travelling carriages, mortars, and howitzers, which cover the upper parts of the side-pieces, and go under the trunnions.

**TRUNNION-RING**, *n.* A ring on a cannon next before the trunnions.

**TRUSION**, *n.* (*tru'zhon*.) [*L. trudo*.] The act of pushing or thrusting.

**TRUSS**, *n.* [*Fr. trosse*; *Dan. trosse*, a cord or rope; *Sw. tross*; *W. trusa*, a crass, a packet. See *TROWERS*.] 1. In a *general sense*, a bundle; as, a *truss* of hay or straw. A *truss* of hay is 56 pounds or half a hundred-weight, and 36 *trusses* make a load. A *truss* of straw is of different weights in different places.—2. In *sur.*, a bandage or apparatus used in cases of hernia, to keep up the reduced parts and hinder further protrusion, and for other purposes.—3. Among *botanists*, a *truss* or bunch is a tuft of flowers formed at the top of the main stalk or stem of certain plants.—4. In *carpentry*, a combination of timbers, of iron, or of timbers and iron work so arranged as to constitute an unyielding frame. It is so named because it is *trussed* or tied together. The simplest exemplar of a *truss* is the principal or main couple of a roof, in which *a*, *a*, the tie beam, is suspended in the middle by the king post, *b*, to the apex of the angle formed by the meeting of the rafters *c*, *c*. The feet of the rafters being tied together by the beam *a*, and being thus incapable of yielding in the direction of their length, their apex becomes a fixed point, to which the beam *a* is *trussed* or tied up, to prevent its sagging, and

breaches gathered in above the knees, or immediately under them, and distinguished according to their peculiar cut



Costume, time of Queen Elizabeth.  
Doublet and Trunk-hose.

as French, Gallic or Venetian. This garment prevailed during the reign of Henry VIII, Elizabeth and James I.

**TRUNK-MAKER**, *n.* One who makes trunks; as, "many a dull book, else unseen, comes partially to light in the linings of the *trunk-maker's* works."

**TRUNNION**, *n.* [*Fr. trognon*.] The trunnions of a piece of ordnance, are two knobs which project from the opposite sides of a piece, whether gun, mortar, or howitzer, and serve to support it on the cheeks of the carriage. Trunnions are also employed in a similar manner in vibrating steam-engines, and in a variety of other machines.

**TRUNNION-PLATE**, *n.* The trunnion-plates are two plates in travelling carriages, mortars, and howitzers, which cover the upper parts of the side-pieces, and go under the trunnions.

**TRUNNION-RING**, *n.* A ring on a cannon next before the trunnions.

**TRUSION**, *n.* (*tru'zhon*.) [*L. trudo*.] The act of pushing or thrusting.

**TRUSS**, *n.* [*Fr. trosse*; *Dan. trosse*, a cord or rope; *Sw. tross*; *W. trusa*, a crass, a packet. See *TROWERS*.] 1. In a *general sense*, a bundle; as, a *truss* of hay or straw. A *truss* of hay is 56 pounds or half a hundred-weight, and 36 *trusses* make a load. A *truss* of straw is of different weights in different places.—2. In *sur.*, a bandage or apparatus used in cases of hernia, to keep up the reduced parts and hinder further protrusion, and for other purposes.—3. Among *botanists*, a *truss* or bunch is a tuft of flowers formed at the top of the main stalk or stem of certain plants.—4. In *carpentry*, a combination of timbers, of iron, or of timbers and iron work so arranged as to constitute an unyielding frame. It is so named because it is *trussed* or tied together. The simplest exemplar of a *truss* is the principal or main couple of a roof, in which *a*, *a*, the tie beam, is suspended in the middle by the king post, *b*, to the apex of the angle formed by the meeting of the rafters *c*, *c*. The feet of the rafters being tied together by the beam *a*, and being thus incapable of yielding in the direction of their length, their apex becomes a fixed point, to which the beam *a* is *trussed* or tied up, to prevent its sagging, and

to prevent the rafters from sagging there are inserted the struts *d, d*. It is

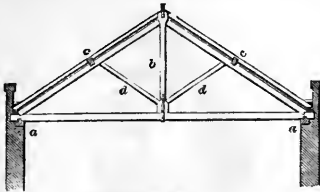

Truss (fig. 1.)

obvious that the office of the beam *a, a*, and of the king post *b*, could be perfectly fulfilled by a string, as they both serve as ties. There are other forms of truss suited to different purposes, but the conditions are the same in all, viz., the establishing of fixed points to which the tie beam is *trussed*. Thus, in fig. 2, two points *a, a*, are substituted for the single one, and two suspending posts are required. These are called

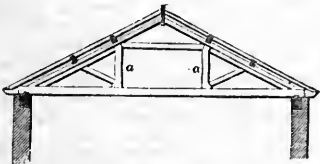

Truss (fig. 2.)

queen-posts, and the truss is called a queen-post truss.—5. In navigation, a machine to pull a lower yard close to its mast, and retain it firmly in that position. *Trusses* are also short pieces of carved work, fitted under the taffrail, in the same manner as the terms. They are chiefly used in small ships. [See *TROUSE*.]

**TRUSS**, *v. t.* To bind or pack close.—

You might have *trussed* him and all his apparel into an eelskin. *Shak*

2. To skewer; to make fast.—*To truss up*, to strain; to make close or tight.

What in most English writers useth to be loose and untight, in this author, is well grounded, finely framed and strongly *trussed* up together. *Spenser*

**TRUSSED**, *pp.* Packed or bound closely.—*Trussed beam*, a compound

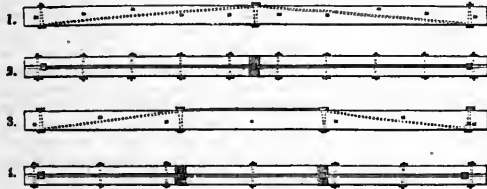

Trussed Beams.

1. Elevation. 2. Plan. 3. Elevation. 4. Plan.

beam composed of two beams secured together side by side with a truss generally of iron between them.—*Trussed roof*, a roof in which the principal rafters and tie beam are framed together so as to form a truss.—*Trussed partition*, a partition the timbers of which are framed together in the manner of a truss.—*Trussed or well trussed*, an epithet for a horse when his thighs are large, and proportioned to the roundness of the croup.

**TRUSS'ING**, *ppr.* Packing or binding closely.

**TRUSS'ING**, *n.* In *arch.*, the timbers &c., which form a truss.—2. In *falconry*, the act of a hawk when she seizes her prey and soars aloft with it into the air.—*Trussing of hay or straw*, in agriculture, is the operation of binding it in bundles for more convenient deporation.

**TRUST**, *n.* [Dan. *tröst*, consolation; *trüster*, to comfort, that is, to strengthen; *mistrüster*, to distrust, to discourage; Sw. *tröst*, confidence, trust, consolation; *trösta*, to console; *miströsta*, to distrust, to despair. The Saxon has *trusian*, to trust, to obligate. Qu. Gr. *Σερα*.] 1. Confidence; a reliance or resting of the mind on the integrity, veracity, justice, friendship, or other sound principle of another person.

He that putteth his *trust* in the Lord shall be safe; Prov. xxix.

My misfortunes may be of use to credulous maids, never to put too much *trust* in deceitful men. *Swift*

2. He or that which is the ground of confidence.

O Lord God, thou art my *trust* from my youth; Ps. lxxi.

3. Charge received in confidence.

Reward them well, if they observe their *trust*. *Denham*

4. That which is committed to one's care. Never violate a sacred *trust*.—

5. Confident opinion of any event:

His *trust* was with th' Eternal to be deem'd Equal in strength. *Milton*

6. Credit given without examination; as, to take opinions on *trust*.—7. Credit on promise of payment, actual or implied; as, to take or purchase goods on *trust*.—8. Something committed to a person's care for use or management, and for which an account must be rendered. Every man's talents and advantages are a *trust* committed to him by his Maker, and for the use or employment of which he is accountable.—9. Confidence; special reliance on supposed honesty.—10. State of him to whom something is intrusted.

I serv'd him truly, that will put me in *trust*. *Shak*

11. Care; management; 1 Tim. vi.—12. In *law*, any equitable right or interest, as distinguished from a legal one, and supposed to be founded in the

confidence placed by one party in another; an estate, devised or granted in confidence that the devisee or grantee shall convey it, or dispose of the profits, at the will of another; an estate held for the use of another. *Trusts* are divided into *simple* and *special*; a simple

*trust* is where property is simply vested in one person for the benefit of another, the terms of the trust not being specified, but left to the construction of law. A special *trust* is where property is vested in a trustee for purposes particularly pointed out, and where consequently the trustee is bound to the active performance of certain duties. Special trusts are farther subdivided into *ministerial* and *discretionary*, the former requiring for

their performance only the ordinary qualities of a rational agent; the latter requiring more or less of judgment and discretion. *Trusts* may be created by the voluntary act of a party, or by the operation of law. [See *USES*.] In *Scots law*, the term *trust* bears the same general signification as in English law, but in regard to the modes of constituting trusts, and the forms and technicalities connected therewith, the laws of the two kingdoms differ materially. For example, by the law of Scotland, a trust affecting heritage must be constituted by a formal disposition of the trustor, called a *trust-deed*, and completed by sasine of the heritage; whereas by the law of England, trusts of a like kind are not required to be declared or created by writing, but only manifested and proved by writing, and the law is satisfied if the trust be manifested by any subsequent acknowledgment on the part of the trustee, however informal or indirect, as by a letter under his hand, his answer in Chancery, or by a recital in a deed, &c., and though the writing itself must be signed, the terms of the trust may be collected from a paper not signed, provided it can be clearly connected with the signed writing.

**TRUST**, *v. t.* To place confidence in; to rely on. We cannot *trust* those who have deceived us.

He that *trusts* every one without reserve, will at last be deceived. *Rambler*

2. To believe; to credit.

*Trust* me, you look well. *Shak*

3. To commit to the care of, in confidence. *Trust* your Maker with yourself and all your concerns.—4. To venture confidently.

Fool'd by thee, to *trust* thee from my side. *Milton*

5. To give credit to; to sell to upon credit, or in confidence of future payment. The merchants and manufacturers *trust* their customers annually with goods to the value of millions.

It is happier to be sometimes cheated, than not to *trust*. *Rambler*

**TRUST**, *v. i.* To be confident of something present or future.

I *trust* to come to you, and speak face to face; 2 John xii.

We *trust* we have a good conscience; Heb. xiii.

2. To be credulous; to be won to confidence.

Well, you may fear too far... Safer than *trust* too far. *Shak*

*To trust in*, to confide in; to place confidence in; to rely on; *a use frequent in the scriptures*.

*Trust* in the Lord, and do good; Ps. xxxvii.

They shall be greatly ashamed that *trust* in graven images; Is. xlii.

*To trust to*, to depend on; to have confidence in; to rely on.

The men of Israel... *trusted* to the liars in wait; Judges xx.

**TRUST'-DEED**, *n.* In *Scots law*, a deed or disposition which conveys property not for the behoof of the donee, but for other purposes pointed out in the deed, as a deed by a debtor conveying property to a person as trustee for payment of his debts. A trust-deed is completed by delivery of the movables, and by sasine in the heritage.

**TRUST'ED**, *pp.* Confid ed in; relied on; depended on; *applied to persons*.—2. Sold on credit; as goods or pro-

erty.—3. Delivered in confidence to the care of another; as, letters or goods *trusted* to a carrier or bailee.

**TRUSTEE**, *n.* A person who holds lands or tenements, or other property, upon the *trust* or confidence that he will apply the same for the benefit of those who are entitled, according to an expressed intention, either by the parties themselves or by the deed, will, settlement, or arrangement of another.

**TRUSTEE'SHIP**, *n.* The office or functions of a trustee; the state of being placed in the hands of a trustee.

**TRUST'ER**, *n.* One who trusts or gives credit.—2. In *Scots law*, one who grants a trust-deed.

**TRUST ESTATE**, *n.* An estate under the management of a trustee or trustees.

**TRUST'FUL**, *a.* Faithful.

**TRUST'FULLY**, *adv.* In a trustful manner.

**TRUST'FULNESS**, *n.* Faithfulness.

**TRUST'ILY**, *adv.* [from *trusty*.] Faithfully; honestly; with fidelity.

**TRUST'INESS**, *n.* [from *trusty*.] That quality of a person by which he deserves the confidence of others; fidelity; faithfulness; honesty; as, the *trustiness* of a servant.

**TRUST'ING**, *ppr.* Confiding in; giving credit; relying on.

**TRUST'INGLY**, *adv.* With trust or implicit confidence.

**TRUST'LESS**, *a.* Not worthy of trust; unfaithful.

**TRUST'LESSNESS**, *n.* Unworthiness of trust.

**TRUST'WORTHINESS**, *n.* Quality of being trustworthy.

**TRUST'WORTHY**, *a.* Worthy of trust or confidence.

**TRUSTY**, *a.* That may be safely trusted; that justly deserves confidence; fit to be confided in; as, a *trusty* servant.—2. That will not fail; strong; firm; as, a *trusty* sword.

**TRUTH**, *n.* [Sax. *treowth*, truth, and *troth*; G. *treue*; D. *getrouweheid*, fidelity, from *trouw*, trust, faith, fidelity, whence *trouten*, to marry.] 1. Conformity to fact or reality; exact accordance with that which is, or has been, or shall be. The *truth* of history constitutes its whole value. We rely on the *truth* of the scriptural prophecies. My mouth shall speak *truth*; Prov. viii. Sanctify them through thy *truth*; thy word is *truth*; John xvii.

2. True state of facts or things. The duty of a court of justice is to discover the *truth*. Witnesses are sworn to declare the *truth*, the whole *truth*, and nothing but the *truth*.—3. Conformity of words to thoughts, which is called *moral truth*. Shall *truth* fail to keep her word? *Milton*.

4. Veracity; purity from falsehood; practice of speaking truth; habitual disposition to speak truth; as when we say, a man is a man of *truth*.—5. Correct opinion.—6. Fidelity; constancy. The thoughts of past pleasure and *truth*, The best of all blessings below. *Song*.

7. Honesty; virtue.

It must appear  
That malice bears down *truth*. *Shak*.

8. Exactness; conformity to rule. Ploughs, to go true, depend much on the *truth* of the iron work. *Mortimer*.

9. Real fact or just principle; real state of things. There are innumerable *truths* with which we are not acquainted.—10. Sincerity. God is a spirit, and they that worship

him must worship in spirit and in *truth*; John iv.

11. In the *fine arts*, a faithful adherence to the models of nature; verisimilitude.—12. The *truth* of God is his veracity and faithfulness; Ps. lxxi. Or his revealed will.

I have walked in thy *truth*; Ps. xcxvi.

13. Jesus Christ is called the *truth*; John xiv.—14. It is sometimes used by way of concession.

She said, *Truth*, Lord; yet the dogs eat of the crumbs; Matt. xv.

That is, it is a truth; what you have said, I admit to be true. According to Dr. Reid, the truths that fall within the compass of human knowledge, whether they be self-evident or deduced from those that are self-evident, may be reduced to two classes, namely, *necessary and immutable truths*, and *contingent and mutable truths*. A necessary truth is one that depends not upon the will and power of any being; it is immutably true, and its contrary impossible. A contingent truth is one which depends upon some effect of will and power, which had a beginning and may have an end. Of the first class are the axioms in mathematics, and all the conclusions drawn from them; that is, the whole body of the science of mathematics. Some first principles, also, belonging to other sciences, are necessary truths; such as the following:—That every proposition must either be true or false; that the qualities which we perceive by our senses must have a subject, which we call body; and that the thoughts we are conscious of must have a subject, which we call mind; and that, whatever begins to exist, must have a cause which produced it. To the second class of truths, viz., those that are contingent, belong the truths of natural philosophy, which depend upon the will of the Maker of the world, and also the principles from which they are deduced. In short, all those truths that express matters of fact or real existences, depending upon the will and power of the Supreme Being, are contingent, with exception of his own existence and nature, which is a necessary truth.—*First truths*, first or fundamental principles; intuitive articles of belief, which form the foundation of all reasoning.—*In truth*, in reality; in fact.—*Of a truth*, in reality; certainly.—*To do truth*, is to practice what God commands; John iii.

**TRUTHFUL**, *a.* Conformable to truth; true in the highest degree.

**TRUTHFULLY**, *adv.* In a truthful manner.

**TRUTHFULNESS**, *n.* The state of being true, or the truth.

**TRUTHLESS**, *a.* Wanting truth; wanting reality.—2. Faithless.

**TRUTHLESSNESS**, *n.* The state of being truthless.

**TRUTH-SPEAKING**, *a.* Uttering truth.

**TRUTH-TELLER**, *n.* One who tells the truth.

**TRUTINA'TION**, *n.* [L. *trutina*, a balance; *trutinor*, to weigh.] The act of weighing.

**TRUTTA'CEOUS**, *a.* [from L. *trutta*, trout.] Pertaining to the trout; as, fish of the *truttaceous* kind.

**TRY**, *v. i.* [This word is from the root of Dan. *trekker*, to draw, or *trykker*, Sw. *trycka*, to press, to urge; *trachta*, to seek or strive to obtain; D. *traegen*,

to endeavour; Dan. *tragter*, id. The primary sense of all these words is to strain, to use effort, to stretch forward.] To exert strength; to endeavour; to make an effort; to attempt. *Try* to learn; *try* to lift a weight. The horses *tried* to draw the load. [These phrases give the true sense.]

**TRY**, *v. t.* To examine; to make experiment on; to probe by experiment. Come, *try* upon yourselves what you have seen me. *Shak*.

2. To experience; to have knowledge by experience of.

Or *try* the Lybian heat, or Scythian cold. *Dryden*.

3. To prove by a test; as, to *try* weights and measures by a standard; to *try* one's opinions by the divine oracles.—4. To act upon as a test.

The fire seven times *tried* this. *Shak*.

5. To examine judicially by witnesses and the principles of law; as, causes *tried* in court.—6. To essay; to attempt.

Let us *try* adventurous work. *Milton*.

7. To purify; to assay; to refine; as, silver seven times *tried*.—8. To search carefully into; Ps. xi.—9. To use as means; as, to *try* remedies for a disease.—10. To strain; as, to *try* the eyes; the *literal sense of the word*.—

11. In *arch.*, to plane a piece of stuff by the rule and square only.—*To try on*, to put on a garment to see if it fits the person.—*To try tallow*, &c., is to melt and separate it from the membranes.—*To try out*, to pursue efforts till a decision is obtained.

**TRY**, *n.* A trial; experiment.—*Try on*, an attempt at imposition. [Trivial.]

**TRY'GON**, *n.* [Gr. *τρυγων*, a sort of fish.] The name of a genus of fishes, to which the sting-ray belongs.

**TRY'ING**, *ppr.* or *a.* Exerting strength; attempting.—2. Examining by searching or comparison with a test; proving; using; straining, &c.—3. *a.* Adapted to try, or put to severe trial.

**TRY'ING**, *n.* In *marine lan.*, the letting a ship lie in the trough or hollow of the sea in the midst of a storm, with only her main or mizzen sail, or under bare poles, with the helm lashed-a-lee.—*Trying plane*, among *joiners*, a plane used after the *jack-plane*, for taking off a shaving the whole length of the stuff, which operation is called *trying up*. [See PLANE.]

**TRY-SAIL**, *n.* In *nautical lan.*, a fore and aft sail, set with a boom and gaff, and hoisting on a lower mast or on a small mast abaft that mast, called a *try-sail-mast*. Trysail is also the name given to a sail set on a fore and aft rigged vessel, if two-masted, on the main-mast, hoisted by a gaff, but having no boom at its lower edge; this is used only in bad weather, as a *storm trysail*.

**TRYST**, *n.* An appointment to meet; an appointed meeting; a market; a rendezvous. [Scotch.]

**TRYST**, *v. t.* To engage a person to meet one at a given time and place. As a *verb intransitive*, to agree to meet at any particular time or place. [Scotch.]

**TSCHE'TWERT**, *n.* A grain measure of Russia, equal to 0.7218 imp. quarter, or three-fourths of a quarter nearly.

**TUB**, *n.* [D. *tobbe*; G. *zuber*; Gael. *tubag*.] 1. An open wooden vessel formed with staves, heading, and hoops; used for various domestic purposes, as for washing, for making cheese, &c.—2. † A state of salvation;

so called because the patient was formerly sweated in a tub.—3. A certain quantity; as, a *tub* of tea, which is 60 pounds; a *tub* of camphor, from 56 to 80 pounds; a *tub* of vermilion, from 300 to 400 pounds. [*Local.*—4. A wooden vessel in which vegetables are planted, for the sake of being movable and set in a house in cold weather.—5. A small cask.—6. Cant name for a pulpit; as, Henley's gilt *tub*.

**TUB**, *v. t.* To plant or set in a tub.

**TUB'BER**, *n.* In *Cornwall*, a mining instrument, called in other places a *bee*. The man who uses this tool is called *tubber-man* or *bee-man*.

**TUB'ING**, *ppr.* Setting in a tub.

**TUB'BY**, *a.* [from *tub*.] Having a sound like that of an empty tub when struck; wanting elasticity of sound. Applied to musical stringed instruments, as the violin.

**TUBE**, *n.* [Fr. *tube*; L. *tubus*.] 1. A pipe; a siphon; a canal or conduit; a hollow cylinder, either of wood, metal, or glass, used for the conveyance of fluids, and for various other purposes. Tubes may be straight or bent into various forms, and although they are generally understood to be hollow cylinders, the cylindrical form is not essential.—2. A vessel of animal bodies or plants, which conveys a fluid or other substance; as, the eustachian and fallopian *tubes* in anatomy, the *sap-tubes* in plants.—3. In *bot.*, the narrow hollow part of a monopetalous corolla, by which it is fixed to the receptacle.—4. In *artillery*, an instrument of tin, used in quick firing.—5. In *astron.*, a telescope, or more properly, that part of it into which the lenses are fitted, and by which they are directed and used.

**TUBE**, *v. t.* To furnish with a tube; as, to *tube* a well.

**TUBED**, *pp.* Furnished with a tube.

**TUBEFORM**, *a.* In the form of a tube.

**TUB'ER**, *n.* In *bot.*, a knob in roots; an underground fleshy stem, often considered as a modification of the root. It may be defined as an oblong or roundish body, of annual duration, composed chiefly of cellular tissue, with a great quantity of amylaceous matter, intended for the development of the stems or branches which are to spring from it, and of which the rudiments, in the form of buds, are irregularly distributed over its surface. Examples are seen in the potato and arrow-root. The organ named the lobe or *pseudo-tuber*, in which there is only a single bud, is nearly allied to the tuber proper. Tubers are distinguished, according to their forms, into *didymous*, that is, of an oblong form, and in pairs, *digitate*, *fusculate*, *globular*, *oblong*, and *palmate*. [See these terms.]—2. A genus of fungi. [See *TRUFFLE*.]—3. In *sur.*, a knot or swelling in any part.

**TUBERATED**, *a.* In *her.*, gibbous; knotted or swelled out, as the middle part of the serpent in the cut.

**TU'BERCLE**, *n.* [Fr. *tubercule*; from L. *tuberculum*, from *tuber*, a bunch.] 1. A pimple; a swelling or tumour on animal bodies. In entaneous diseases, it is a small hard superficial tumour, circumscribed, and



Tuberated.

permanent, or suppurating partially.—2. In *pathol.*, a peculiar morbid production, which occurs in various textures of the body in connection with scrofula. It occurs in isolated roundish masses, or infiltrated in the texture of organs. The matter which forms tubercles is unorganized, of a dull whitish, yellow, or yellowish-gray colour, opaque, and varying in form and consistency, according to the stage of development of the tubercle, and the texture of the part in which it is formed. Tubercles are formed in the lungs in pulmonary consumption.—*Tubercle of Lower*, an eminence in the right auricle of the heart, where the two *vena cava* meet; so named from Lower, who first described it.—3. A little knob, like a pimple, on plants; a little knob or rough point on the leaves of some lichens, supposed to be the fructification.

**TUBERCLED**, *a.* Having tubercles.

**TUBER'ULA QUADRIGEM'INA**, *n. plur.* [L.] In *anat.*, the name given to four white oval tubercles of the brain, two of which are situated on each side, at the posterior part of the third ventricle and over the aqueduct of Sylvius.

**TUBER'ULAR**, } *a.* Full of knobs  
**TUBER'ULOUS**, } or pimples.—2. Affected with tubercles.

**TUBER'ULATE**, } *a.* Having small  
**TUBER'ULATE**, } knobs or pimples, as a plant.

**TUBERIFEROUS**, *a.* Producing or bearing tubers.—A *tuberiferous root* is a fibrous root, to which are attached fleshy or amylaceous knobs or tubers, as in the potato.

**TUBEROSE**, *n.* [L. *tuberosa*.] 1. Tuberosus; having knobs or tubers.—2. An odoriferous plant, with a tuberous root, the *Polygonum tuberosa*. [See *POLYANTHES*.]

**TUBEROUS**, *a.* [from L. *tuber*, a bunch.] Knobbed. In *bot.*, consisting of roundish fleshy bodies, or tubers, connected into a bunch by intervening threads; as, the roots of potatoes.

**TUB'FISH**, *n.* [from *tub* and *fish*.] A local name for the sapphire gurnard, *Trigla hirundo*.

**TUBICINEL'LA**, *n.* [L. *tubicen*, a trumpeter.] A genus of multivalve tabular shells, not spiral, placed by Lamarck among the sessile cirripedes. They are found imbedded in the blubber of whales.

**TUBICOLÆ**, } *n.* [L. *tubus*, a tube,  
**TUBICOLÆ**, } and *colo*, to inhabit, live, or dwell in.] An order of Annelids, comprehending those which live in calcareous tubes, and likewise such as live in tubes formed of agglutinated grains of sand, fragments of shells, and particles of mud. The order comprises the genera *Serpula Sabella*, *Terrella*, *Amphitrite*, and *Syphos-toma*.

**TUBICOLA'RILÆ**, *n.* Lamarck's name for a genus of Infusoria, of the order Rotifera. The species secrete themselves in little tubes, which they construct of foreign particles, but which do not form any part of their body.

**TUBICOLIDÆ**, *n.* Lamarck's name for a family of Conchifers, including such as are borers, burrowing in stone, wood, and even in thick shells, although some live in the sand. It comprises the genera *Aspergillum*, *Clavagella*, *Fistulana*, *Septaria*, *Teredina*, and *Teredo*.

**TUBICORN**, *n.* [L. *tubus* and *cornu*.] In *zool.*, one of a family of ruminant animals, having horns composed of a horny axis, covered with a horny sheath.

**TUBIF'ERA**, } *n.* [L. *tubus*, a pipe or  
**TUBIFERS**, } tube, and *fero*, to bear.] Lamarck's name for an order of Poly-*paria*, comprising such as are united upon a common substance, fixed at its base, and whose surface is wholly or partially covered with retractile hollow tubes.

**TUBIFORM**, *a.* Having the form of a tube; tubular.

**TUBING**, *ppr.* Furnishing with a tube.  
**TUBING**, *n.* A length of tube; a series of tubes; as, leather *tubing*, metal *tubing*, &c.

**TUBIPOR'EA**, } *n.* [tube and pore.]  
**TUBIPORIDÆ**, } A family of Zoo-  
phytes, comprehending those which are provided with internal ovaries, and eight pinnated tentacula, and contained in elongated cylindrical cells, which are calcareous, or coriaceous, and attached by their base. The species are known by the name of organ-*pipe coral*.

**TUBIPORE**, *n.* [tube and pore.] The English name of a genus of Zoophytes, (*Tubipora*), organ-pipe coral.

**TUBIPORITES**, *n.* Fossil species of *Tubipora*, often found in marbles and pebbles.

**TUB-MAN**, *n.* In the *exchequer*, a bar-*ri-ster* so called.

**TUBULAR**, *a.* [from L. *tubus*.] Having the form of a tube or pipe; consisting of a pipe; fistular; as, a *tubular snout*.—*Tubular leaf*, one that is cylindrical and hollow, as in the onion.—*Tubular corolla*, a monopetalous corolla, which is narrow and elongated.

**TUBULARIA**, *n.* A genus of Corallines, belonging to the class Polyphyta. It consists of simple or branched tubes of a horny substance, each tube containing a polype. The species are both fresh-water and marine.

**TUBULATED**, } *a.* or *ppr.* Made in  
**TUBULOUS**, } the form of a small  
tube.—2. Furnished with a small tube.

—*Tubulated retort*, a retort having a small tube furnished with a stopper, so placed above the bulb as to enable substances to be introduced into the retort without soiling the neck. A receiver with a similar tube and stopper is called a *tubulated receiver*.

**TUBULE**, *n.* [L. *tubulus*.] A small pipe or fistular body.

**TUBULIBRANCHIA'TA**, *n.* [L. *tubus*, and *branchia*, gills.] Cuvier's name for his seventh order of Gastropods, comprehending those of which the shell, in which the branchiæ reside, resembles a more or less regularly shaped tube, only spiral at the commencement, and which attaches itself to various bodies. The order consists of the genera *Vermetus*, *Magilus*, and *Siliquaria*.

**TUBULIFORM**, *a.* Having the form of a small tube.

**TUBUL'OSE**, *a.* Resembling a tube or pipe.

**TUBULOUS**, *a.* Longitudinally hollow.—2. Containing small tubes; composed wholly of tubulous florets; as, a *tubulous compound flower*.—3. In *bot.*, having a bell-shaped border, with five reflex segments, rising from a tube; as, a *tubulous floret*.

**TUC'RT**, } *n.* A steak. [See *TUCKER*.]  
**TUCH**, *n.* A kind of marble.

**TUCK**, *n.* [Gael. *tuca*; W. *toca*; from the sense of cutting or thrusting, and the root of *dock*. The It. has *stocco*, and the Fr. *estoc*.] 1. A long narrow sword.—2. A kind of net.—3. [from the verb following.] In a ship, the part where the ends of the bottom planks are collected under the stern.—4. A fold in a dress; a horizontal fold made in the skirt of a garment or dress, in order to accommodate it to the height of a growing person.—5. A pull; a lugging. [See **TUG**.]—*Tuck of drum*, in Scotland, a drum beat on public proclamations by a town drummer.

**TUCK**, *v. t.* [In G. *zucken* signifies to stir, to stoop, to shrug. In some parts of England, this verb signifies to full, as cloth; Ir. *tucalam*.] 1. To thrust or press in or together; to fold under; to press into a narrower compass; to gather up; as, to *tuck up* a bed; to *tuck up* a garment; to *tuck in* the skirt of any thing.—2. To inclose by pushing close around; as, to *tuck* a child into a bed.—3. To full; as, cloth. [Local.] **TUCK**, *v. i.* To contract; to draw together.

**TUCK'A-HOE**, *n.* A singular vegetable found in the southern seaboard States of the North American Union, growing underground, like the European truffle. It is also called *Indian bread* and *Indian loaf*.

**TUCK'ED**, *pp.* Pressed in or together. **TUCK'ER**, *n.* An ornament round the top of a woman's stays to shade the bosom.—2. A fuller, whence the name. [Local.]

**TUCK'ET**, *n.* [It. *tocato*, a touch.] 1. A flourish in music; a voluntary; a prelude.—2. It. *tocchetto*.] A steak; a collop.

**TUCK'ETSONANCE**, *n.* The sound of the tucket, an ancient instrument of music.

**TUCK'ING**, *ppr.* Pressing under or together; folding.

**TUCK-POINT'ING**, *n.* Marking the joints of brickwork with a narrow parallel ridge of fine white putty.

**TUDOR STYLE**, *n.* In *arch.*, a name frequently applied to the latest Gothic

combats, strife, and litigation. Hence *Tuesday* is court day, assize day; the day for combat or commencing litigation. See **THING**.] The third day of the week.

**TU'FA**, *n.* [It. *tufo*, porous ground; Fr. *tuf*, soft gravel-stone or sand-stone; G. *tof*.] A loose and porous kind of stone formed by depositions from springs, usually calcareous. It is also called calcareous tuff. It is of the same nature as *travertin*, but is less solid.

**TUFA'CEOUS**, *a.* Pertaining to tufa; consisting of tufa or tuff, or resembling it.

**TUFF**, *n.* The name } given to a kind of volcanic rock, consisting of accumulations of scoria and ashes about the crater of a volcano, which are agglutinated together so as to make a coherent or solid mass. Sometimes tuff is composed of volcanic ashes and sand, transported and deposited by rain-water. Rounded fragments of greenstone, basalt, and other trap rocks, cemented into a solid mass, are termed *Trap-tuff*.

**TUFFOON'**, *n.* [a corruption of *typhon*.] A violent tempest or tornado with thunder and lightning, frequent in the Chinese sea and the gulf of Tonquin.

**TU'FO**, *n.* [It.] Tufa or tuff.

**TUFT**, *n.* [W. *tuf*; Fr. *touffe*, *toupet*; Sw. *tofs*; Sp. *tuye*, a tuft; *tupir*, to press together; *tupa*, satiety.] 1. A collection of small things in a knot or bunch; as, a *tuft* of flowers; a *tuft* of feathers; a *tuft* of grass or hair. A *tuft* of feathers forms the crest of a bird.—2. A cluster; a clump; as, a *tuft* of trees; a *tuft* of olives.—3. In *bot.*, a head of flowers, each elevated on a partial stalk, and all forming together a dense roundish mass. The word is sometimes applied to other collections, as little bundles of leaves, hairs, and the like.

**TUFT**, *v. t.* To separate into tufts.—2. To adorn with tufts or with a tuft.

**TUF-TAFF'ETA**, *n.* A villous kind of silk.

**TUFT'ED**, *pp.* or *a.* Adorned with a tuft; as, the *tufted* duck; growing in a *tuft* or clusters, as a *tufted* grove.

**TUFT'-HUNTER**, *n.* One who covets the society of titled persons; one who is willing to submit to the insolence of the great, for the sake of the supposed honour of being in their company. The term took its rise at the English universities of Oxford and Cambridge, where the young noblemen wear a peculiarly formed cap with a *tuft*. [Colloq.]

**TUFT'ING**, *ppr.* Separating into tufts; adorning with tufts.

**TUFTY**, *a.* Abounding with tufts; growing in clusters; bushy.

**TUG**, *v. t.* [Sax. *teogan*, *teon*; G. *ziehen*, to draw; *zug*, a tug; Fr. *touer*; L. *duco*. See **Tow**, to drag.] 1. To pull or draw with great effort; to drag along with continued exertion; to haul along. There sweat, there strain, *tug* the laborious oar. *Roscommon*.

2. To pull; to pluck.

To ease the pain,  
His *tugg'd* ears suffer'd with a strain.

*Hudibras*.

3. To drag by means of steam-power; as, the vessel had to be *tugged*.

**TUG**, *v. i.* To pull with great effort; as, to *tug* at the oar; to *tug* against the

stream.—2. To labour; to strive; to struggle.

They long wrestled and strenuously *tugged* for their liberty. *Howe*.  
[This is not elegant.]

**TUG**, *n.* A strongly built **TUG-BOAT**, steam-boat, used for dragging sailing and other vessels. Such a boat is also sometimes called a *steam-tug*.

**TUG**, *n.* [G. *zug*.] 1. A pull with the utmost effort.

At the *tug* he falls —  
Vast ruins come along. *Dryden*.

2. A sort of carriage, used in some parts of England, for conveying bavins or faggots and other things.

**TUG'GED**, *pp.* Pulled with great effort. **TUG'GER**, *n.* One who tugs or pulls with great effort.

**TUG'GING**, *ppr.* or *a.* Pulling or dragging with great exertion; hauling.

**TUG'GINGLY**, *adv.* With laborious pulling.

**TULL'E'S**, *n.* [Fr. *tuile*, a tile.] **TUILLETTE'S**, *n.* In *ancient armour*, extra guard plates appended to the tasses, to which they were frequently fastened by straps. They hung down and covered the upper part of the thigh, and were first introduced during the reign of Henry V.

**TUI'TION**, *n.* [L. *tuitio*, from *tueor*, to see, behold, protect, &c. This verb is probably contracted from *tugo*, Ir. *tuighim*. If so, it coincides with the Dan. *tugt*, education, *tugter*, to chastise, D. *tugt*, G. *zucht*. In this case, it coincides nearly with L. *duco*, to lead.] 1. Guardianship; superintending care over a young person; the particular watch and care of a tutor or guardian over his pupil or ward.—2. *More especially*, instruction; the act or business of teaching the various branches of learning. We place our children under the preceptors of academies for *tuition*. [This is now the common acceptance of the word.]

**TUI'TIONARY**, *a.* Pertaining to tuition.

**TU'LA METAL**, *n.* An alloy of silver, copper, and lead.

**TULIP**, *n.* [Fr. *tulipe*; L. *tulipa*; G. *tulpe*; Dan. *tulipan*; Pers. *toleban*.] The English name of a genus of plants (*Tulipa*), class Hexandria, order Monogynia, Linn.; nat. order Liliaceæ. The species are herbaceous plants, developed from a bulb, inhabiting the warmer parts of Europe and Asia Minor, and are much cultivated for the beauty of the flowers. About thirty species have been described, of which the most noted is the common garden tulip, *T. gesneriana*, a native of the Levant, and introduced into England about 1577. Upwards of 600 varieties of this plant have been enumerated by British florists, and these varieties have been divided into four families, viz., *bizarres*, *byblæmens*, *roses*, and *sels*. Several other species are cultivated. The wild tulip (*T. sylvestris*), is a native of Britain, and grows in chalk pits and quarries. It has yellow flowers, and blooms in April and May.

**TULIPIST**, *n.* A cultivator of tulips. **TULIPOMANIA**, *n.* A violent passion for tulips. **TULIPMADNESS**, *n.* Cultivation or acquisition of tulips. This species of mania was displayed by the Dutch in the 17th century, and rose to such a height that the Dutch government



Tudor Arch tecture, Hengrave Hall, Essex, 1538.

style in England, called also *Florid Gothic*. The period of this style is from 1400 to 1537. It is characterized by a flat arch, shallow mouldings, and a profusion of panelling on the walls. **TUE-IRON**. See **TUYERE**, and **TWEER**. **TU'EL**, *n.* [Fr. *tuyau*.] The anus. **TUESDAY**, *n.* (*s* as *z*). [Sw. *Tisdag*; Dan. *Tirsdag*; D. *Dingsdag*; G. *Dings-tag*; Sax. *Tiwæsdæg* or *Tuesdag*, from *Tig*, *Tiig*, or *Tuisco*, the Mars of our ancestors, the deity that presided over

found it necessary to interfere; but the ardent love of the tulip still exists among the Dutch floriculturists.

**TULIP-TREE**, *n.* An American tree bearing flowers resembling the tulip, the *Liriodendron tulipifera*. It is one of the most magnificent of the forest trees in the temperate parts of North America. Throughout the States it is generally known by the name of poplar, white wood, or canoe wood. It attains a height of from 80 to 100 feet, the

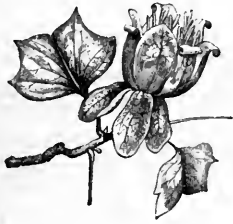

Flower of Tulip-tree (*Liriodendron tulipifera*).

trunk being from 18 inches to 3 feet in diameter. The wood is light, compact, and fine-grained, and is employed for various useful purposes; such as the interior work of houses, coach-panels, door-panels, wainscots, mouldings of chimney-pieces, bedsteads, trunks, &c. The Indians of the Middle and Western States prefer this tree for their canoes, which are made of a single trunk. The bark, especially of the roots, has an aromatic smell and bitter taste, and has been used in medicine as a tonic and febrifuge. In this country the tulip tree is cultivated as an ornamental tree. [See **LIRIODENDRON**.]

**TULLE**, *n.* [Fr.] A kind of thin net fabric used in female head-dresses, collars, &c.

**TUL'LIAN**, *a.* Ciceronian;—*which see*.

**TUMBLE**, *v. i.* [Sax. *tumbian*, to tumble, to dance; Sw. *tumla*, to fall, to tumble; Dan. *tumler*, to shake, toss, reel, tumble; Fr. *tomber*; Sp. *tumbar*, to tumble, roll, keel, as a ship, to throw down; *tumba*, a tomb, a vault, a *tumble* or fall; L. *tumulus*, *tumulus*, *tumeo*; It. *tomare*, to fall; *tombolare*, to tumble; W. *tump*, a hillock; G. *tumeln*, to reel.] 1. To roll; to roll about by turning one way and the other; as, a person in pain *tumbles* and tosses.—2. To fall; to come down suddenly and violently; as, to *tumble* from a scaffold.—3. To fall in great quantities; to fall tumultuously.—4. To roll down. The stone of Sisyphus is said to have *tumbled* to the bottom, as soon as it was carried up the hill.—5. To play mountebank tricks, by various librations, movements, and contortions of the body.

**TUMBLE**, *v. t.* To turn over; to turn or throw about for examination or searching; sometimes with *over*; as, to *tumble over* books or papers; to *tumble over* clothes. [To *tumble over* in thought, is not elegant.]—2. To disturb; to rumple; as, to *tumble* a bed.—3. To throw by chance or violence.—4. To throw down.—To *tumble out*, to throw or roll out; as, to *tumble out* casks from a store.—To *tumble down*, to throw down carelessly or with violence.

**TUMBLE**, *n.* A fall; a rolling over. **TUMBLER**, *pp.* Rolled; disturbed; rumbled; thrown down.—*Tumbled in*,

in *arch.*, the same as *trimmed in*,—*which see*.

**TUMBLER**, *n.* One who tumbles; one who plays the tricks of a mountebank.—2. A large drinking glass of a cylindrical form, or of the form of the frustum of an inverted cone.—3. A variety of the domestic pigeon, so called from his practice of tumbling or turning over in flight. It is a short-bodied pigeon, of a plain colour, black, blue, or white.—4. A sort of dog, so called from his practice of tumbling before he attacks his prey. This kind of dog was formerly employed for catching rabbits.

**TUMBLING**, *ppr.* or *a.* Rolling about; falling; disturbing; rumpling.—*Tumbling home*, in a ship, is the inclination of the top-sides from a perpendicular toward the centre of the ship; or the part of a ship which falls inward above the extreme breadth.

**TUMBLING**, *n.* The act of tumbling; the performances of a tumbler or buffoon.

**TUMBLING-BAY**, *n.* In a canal, an overflow, or weir.

**TUMBREL**, *n.* [Fr. *tombereau*, from **TUMBRIL**, } *tomber*. See **TUMBLE**.]

1. A cucking stool, or ducking stool, formerly used for the punishment of scolding women. It consisted of a stool or chair attached to the extremity of a long pole. The offender was placed in the chair, and swung over a pond by means of the pole, which was placed on an elevated support, and made to act as a long lever. By lowering the end of the pole to which the seat was attached, the offender might be immersed in the pond as often as was deemed necessary.—2. A dung-cart; a sort of low carriage with two wheels, occasionally used by farmers for the most ordinary purposes.—3. A covered cart or carriage with two wheels, which accompanies troops or artillery, for conveying the tools of pioneers, cartridges, and the like.

**TUMEFACATION**, *n.* [L. *tumefacio*, to make tumid. See **TUMID**.] The act or process of swelling or rising into a tumour; a tumour; a swelling.

**TUMEFIED**, *pp.* [from *tumefy*.] Swelled; enlarged; as, a *tumefied* joint.

**TUMEFY**, *v. t.* [L. *tumefacio*; *tumidus*, *tumeo*, and *facio*.] To swell, or cause to swell.

**TUMEFY**, *v. i.* To swell; to rise in a tumour.

**TUMEFYING**, *ppr.* Swelling; rising in a tumour.

**TUMID**, *a.* [L. *tumidus* from *tumeo*, to swell.] 1. Being swelled, enlarged, or distended; as, a *tumid* leg; *tumid* flesh.—2. Protuberant; rising above the level. So high as heav'd the *tumid* hills.

*Milton.*

3. Swelling in sound or sense; pompous; puffy; hombastic; falsely sublime; as, a *tumid* expression; a *tumid* style.

**TUMIDITY**, *n.* A swelled state.

**TUMIDLY**, *adv.* In a swelling form.

**TUMIDNESS**, *n.* A swelling or swelled state.

**TUMITE**, *n.* A mineral. [See **THUM-MERSTONE**.]

**TUMOUR**, *n.* [L. from *tumeo*, to swell.] 1. In *sur.*, a swelling; a morbid enlargement of any part of the body.

This is a word of very comprehensive signification, and it is very difficult to define exactly the diseases commonly classed under the name of *tumours*. According to some, a tumour is the

morbid enlargement of a particular part, without being caused by inflammation, a swelling which arises from inflammation being termed *tumefaction*. According to others, a tumour is any swelling which arises from the growth of distinct superfluous parts or substances, which did not make any part of the original structure of the body, or from a morbid increase in the bulk of other parts, which naturally and always existed in the human frame. The term *tumour* is limited, by Abernethy, to such swellings as arise from new productions, and includes only the *sarcomatous* and *encysted* tumours. An *encysted tumour* is one which is formed in a membrane called a *cyst*, connected with the surrounding parts by the neighbouring cellular substance. There are also fatty tumours, called *lipomatus* or *adipose* (*adipose sarcoma*), formed by an accumulation of fat in a limited extent of the cellular substance. Another division of tumours, considered as morbid parasitic growths, is into *malignant* and *innocent*. A *malignant tumour* is one which, after being removed by operation, is likely to recur in the same or some other part, while an *innocent tumour* is one which is not likely to recur after being removed by operation. Those tumours which are termed *tuberculous*, *medullary*, and *cancerous*, belong to the former class; and those termed the *common vascular*, the *adipose*, and the *pancreatic*, to the latter.—2. Affected pomp; bombast in language; swelling words or expressions; false magnificence or sublimity. [Little used.]

**TUMOURED**, *a.* Distended; swelled. **TUMOUROUS**, *a.* Swelling; protuberant.—2. Vainly pompous; bombastic; as language or style. [Little used.]

**TUMP**, *n.* [infra.] A little hillock.

**TUMP**, *v. t.* [W. *tump*, a round mass, a hillock; L. *tumulus*. See **TOMB**.] In gardening, to form a mass of earth or a hillock round a plant; as, to *tump* teasel.

**TUMPED**, *pp.* Surrounded with a hillock of earth.

**TUMPING**, *ppr.* Raising a mass of earth round a plant.

**TUMULAR**, *a.* [L. *tumulus*, a heap.] Consisting in a heap; formed or being in a heap or hillock.

**TUMULATE**, *v. t.* To swell.

**TUMULOSITY**, *n.* [infra.] Hilliness.

**TUMULOUS**, } a [L. *tumulosus*.] Full }  
**TUMULOSE**, } of hills.

**TUMULT**, *n.* [L. *tumultus*, a derivative from *tumeo*, to swell.] 1. The commotion, disturbance, or agitation of a multitude, usually accompanied with great noise, uproar, and confusion of voices.

What meaneth the noise of this *tumult*?  
1 Sam. iv.

Till in loud *tumult* all the Greeks arose.

*Pope.*

2. Violent commotion or agitation, with confusion of sounds; as, the *tumult* of the elements.—3. Agitation; high excitement; irregular or confused motion; as, the *tumult* of the spirits or passions.—4. Bustle; stir.

**TUMULT**, *v. t.* To make a tumult; to be in great commotion.

**TUMULTER**, *v. n.* A tumult-raiser.

**TUMULTUARILY**, *adv.* [from *tumultuary*.] In a tumultuary or disorderly manner.

**TUMULTUARINESS**, *n.* Disorderly

or tumultuous conduct; turbulence; disposition to tumult.

**TUMULTUARY**, *a.* [Fr. *tumultuaire*; from *L. tumultus*.] 1. Disorderly; promiscuous; confused; as, a *tumultuary* conflict.—2. Restless; agitated; unquiet.

Men who live without religion, live always in a *tumultuary* and restless state.

*Atterbury.*

**TUMULTUATE**, *v. i.* [*L. tumultuo*.] To make a tumult.

**TUMULTUATION**, *n.* Commotion; irregular or disorderly movement; as, the *tumultuation* of the parts of a fluid.

**TUMULTUOUS**, *a.* [Fr. *tumultueux*.] 1. Conducted with tumult; disorderly; as, a *tumultuous* conflict; a *tumultuous* retreat.—2. Greatly agitated; irregular; noisy; confused; as, a *tumultuous* assembly or meeting.—3. Agitated; disturbed; as, a *tumultuous* breast.—4. Turbulent; violent; as, a *tumultuous* speech.—5. Full of tumult and disorder; as, a *tumultuous* state or city.

**TUMULTUOUSLY**, *adv.* In a disorderly manner; with turbulence; by a disorderly multitude.

**TUMULTUOUSNESS**, *n.* The state of being tumultuous; disorder; commotion.

**TUMULUS**, *n.* [*L.*] A barrow, or artificial mound of earth. *Tumuli*, or barrows, are of various sizes and forms, and are in many parts of the globe. They are of great antiquity, and are generally supposed to be tombs, or sepulchral monuments raised to perpetuate the memory of persons of distinction, or of warriors slain in battle. In the most ancient tumuli, bodies are found deposited within a stone receptacle, with the head towards the north. The bones which have been discovered within those tumuli which have been opened, are generally accompanied by utensils, weapons, &c. In some tumuli urns only have been found; in others, both bodies and urns, and in some the bones of animals. The tumuli found in this country are supposed to be of British construction. Those found in Roman camps appear to have been intended to serve for land marks, or some military purpose. [See *BARROW*.]

**TUN**, *n.* [Sax. *tunna*, a cask; Fr. *tonne*, *tonneau*; Ir. *tonna*; Arm. *tonnell*; G. *tonne*; D. *ton*; W. *tynell*, a barrel or tun. This word seems to be from the root of *L. teneo*, to hold, Gr. *τενω*, to stretch, W. *tyu*, stretched, strained, tight, *tyndu*, to strain, to tighten; and this seems also to be the Sax. *tun*, a town, for this word signifies also a garden, evidently from inclosing, and a class, from collecting or holding.] 1. In a general sense, a large cask; an oblong vessel bulging in the middle, like a pipe or puncheon, and girt with hoops, and used for stowing several kinds of merchandise for convenience of carriage; as brandy, oil, sugar, skins, &c.—2. A certain measure for liquids, as for wine, oil, &c.—3. A quantity of wine, consisting of two pipes or four hogsheds, or 252 gallons. In different countries, the tun differs in quantity.—4. In com. [See *TON*.]—5. A certain weight by which the burden of a ship is estimated, but in this signification the word is usually written *ton*,—which see.—6. A certain quantity of timber, consisting of forty solid feet, if round, or fifty-four feet, if square.—7. Proverbially, a large quantity.—8. In burlesque, a drunkard.—9. At the end

of names, *tun*, *ton*, or *don*, signifies town, village, or hill.

**TUN**, *v. t.* To put into casks.

**TUNABLE**, *a.* [from *tune*.] Harmonious; musical.

And *tunable* as sylvan pipe or song.

*Milton.*

2. That may be put in tune.

**TUNABLENESS**, *n.* Harmony; melodiousness.

**TUNABLY**, *adv.* Harmoniously; musically.

**TUN-BELLIED**, *a.* [*tun* and *belly*.] Having a large, protuberant belly.

**TUN-DISH**, *n.* [*tun* and *dish*.] A fannel.

**TUNE**, *n.* [Fr. *ton*; It. *tuono*; D. *toon*; W. *ton*; Ir. *tona*; L. *tonus*. It is a different spelling of *tone*,—which see.] 1. A short air or melody; a series of musical notes in some particular measure, and consisting of a single series, for one voice or instrument, the effect of which is melody; or a union of two or more series or parts to be sung or played in concert, the effect of which is harmony. Thus we say, a merry *tune*, a lively *tune*, a grave *tune*, a psalm *tune*, a martial *tune*.—2. Sound; note.—3. Harmony; order; concert of parts.

A continual parliament I thought would but keep the commonweal in *tune*.

*K. Charles*

4. Correct intonation in singing or playing; the state of giving the proper sounds; as when we say, a harpsichord is in *tune*; that is, when the several chords are of that tension, that each gives its proper sound, and the sounds of all are at due intervals, both of tones and semitones.—5. Proper state for use or application; right disposition; fit temper or humour. The mind is not in *tune* for mirth.

A child will learn three times as fast when he is in *tune*, as he will when he is dragged to his task.

*Locke.*

6. Among *phrenologists*, one of the perceptive faculties. Its organ is situated above the external angle of the orbit of the eye, as high as the middle of the forehead, on each side of the temporal ridge. This faculty gives the perception of melody.

**TUNE**, *v. t.* To put into a state adapted to produce the proper sounds; as, to *tune* a forte-piano; to *tune* a violin.

*Tune* your harps.

*Dryden.*

2. To sing with melody or harmony.

Fountains, and ye that warble as ye flow,  
Melodious murmurs, warbling *tune* his praise.

*Milton.*

So we say of birds, they *tune* their notes or lays.—3. To put into a state proper for any purpose, or adapted to produce a particular effect. [*Little used*.]

**TUNE**, *v. i.* To form one sound to another.

While *tuning* to the waters' fall,

The small birds sang to her.

*Drayton.*

2. To utter inarticulate harmony with the voice.

**TUNED**, *pp.* Uttered melodiously or harmoniously; put in order to produce the proper sounds.

**TUNEFUL**, *a.* Harmonious; melodious; musical; as, *tuneful* notes; *tuneful* birds.

**TUNEFULLY**, *a.* Harmoniously; musically.

**TUNELESS**, *a.* Unmusical; unmusical.—2. Not employed in making music; as, a *tuneless* harp.

**TUNER**, *n.* One who tunes.—2. One

whose occupation is to tune musical instruments.

**TUNGSTATE**, *n.* A salt formed of tungstic acid and a base; as, *tungstate* of lime.

**TUNGSTEN**, *n.* [Sw. and Dan. *tung*, heavy, and *sten*, stone, heavy stone, or ponderous ore, so named from the density of its ores.] 1. A metal discovered by D'Elhuyart in 1781. It has a greyish white colour, and considerable lustre. It is brittle, nearly as hard as steel, and less fusible than *manganese*. Its specific gravity is 17.4. When heated to redness in the open air, it takes fire, and is converted into *tungstic acid*, and it undergoes the same change by the action of nitric acid. Digested with a concentrated solution of pure potash, it is dissolved with disengagement of hydrogen gas, and tungstate of potash is generated. The ores of this metal are the native tungstate of lime, and the tungstate of iron and manganese, which latter is also known by the name of Wolfram, and the same name is also given to the metal. Tungsten may be procured in the metallic state, by exposing tungstic acid to the action of charcoal or dry hydrogen gas at a red heat, but an exceedingly intense heat is required for fusing the metal. With oxygen, tungsten forms two compounds, the dark brown oxide, and the yellow acid of tungsten. With chlorine gas it forms two chlorides, a bichloride, and a trichloride. Both are red, volatile, and crystallizable compounds, subliming in beautiful crystals.—2. An obsolete name for the native tungstate of lime.

**TUNGSTENIC**, *† a.* Pertaining to or procured from tungsten.

**TUNGSTIC ACID**, *n.* An acid composed of one equivalent of the metal tungsten, and three equivalents of oxygen. It is obtained by heating the brown oxide of tungsten to redness in open vessels, and it may also be obtained from the native tungstate of lime, and from Wolfram. It is a yellow powder, insoluble in water. With bases it forms crystallizable salts. When exposed to the action of hydrogen gas at a temperature of 500° or 600°, it becomes of a fine deep blue, and is converted into the blue oxide of tungsten, which is regarded as a tungstate of tungsten.

**TUNGSTO SULPHURETS**. Compounds of tungsten and sulphur. They have no peculiar interest.

**TUNIC**, *n.* [Fr. *tunique*; L. *tunica*. See *TOWN* and *TUN*.] 1. A garment worn by the Romans of both sexes under the toga, and next to the skin. It was a kind of vest, generally of wool, of a white colour, and, as worn by men, came down a little below the knees before, and to the middle of the legs behind. It was fastened by a girdle or belt about the waist, to keep it tight when they went abroad, the girdle also serving as a purse, in which they kept their money. The tunic was at first worn without sleeves, but afterwards sleeves came to be used with fringes at the hands. The senators had a broad stripe of purple (called *latus clavus*) sewed on the breast of their tunic, and the equites had a narrow stripe (called *angustus clavus*) on the breast. Hence the terms *laticlavii* and *angusticlavii*, applied to persons of these orders. The tunic worn by women had sleeves, and reached down



to the feet.—2. In the *Roman catholic church*, a long under garment worn by the officiating clergy.—3. A garment worn under the coat of mail.—4. In *anat.*, a membrane that covers or composes some part or organ; as, the *tunics* or coats of the eye; the *tunics* of the stomach, or the membranous and muscular layers which compose it.—5. A natural covering; an integument; as, the *tunic* of a seed.

**TUNICARIES**, } *n.* [from *tunic*.] An **TUNICA'TA**, } order of acephalous molluscs, comprehending those which have a soft covering, consisting of an organized envelope, provided with two orifices, the one branchial, and the other anal. These animals are found either solitary, or in groups, fixed or floating, and sometimes joined together in a common mass.

**TUNICATED**, *a.* In *bot.*, covered with a tunic, or membranes; coated. A *tunicated bulb*, is one composed of numerous concentric coats, as an onion. **TUNICLE**, *n.* [from *tunic*.] A natural covering; an integument.

**TUNING**, *ppr.* Uttering harmoniously or melodiously; putting in due order for making the proper sounds.

**TUNING**, *n.* The art or operation of adjusting the various sounds of a musical instrument, so that they may be all at due intervals, and the scale of the instrument brought into as correct a state as possible. In tuning an instrument, the first point is to fix upon some one note as a leading note, and then by the pitch of it to determine the relative sounds of all the rest.—2. The art or operation of adjusting two or more musical instruments, so as to bring them into agreement with each other, as two or more violins, a violin and violoncello, &c. Horns, fifes, flutes, &c., have a permanent relative scale, and only change their pitch by change of temperature. [See **TEMPERAMENT**.]

**TUNING-FORK**, *n.* A steel instrument consisting of two prongs and a handle; used for tuning instruments, for regulating their pitch, and also the pitch of voices. There are two kinds of tuning forks in use; one of which sounds C major, and the other A minor. The first is used in tuning piano-fortes, and the second in orchestras, for the violins, &c.

**TUNING-HAMMER**, *n.* An instrument used by piano-forte tuners, to twist round the iron pegs to which the wires are fastened at one end, or to fix these pegs into their holes, by hammering them on the ends.

**TUNISIAN**, *n.* A native of Tunis.—*a.* Relating to Tunis.

**TUNKERS**, *n.* [G. *tunken*, to dip.] In *America*, a religious sect resembling English baptists. This sect was founded by Conrad Peyssel, a German, in 1724. They reside chiefly in Pennsylvania, and in baptism practise *trine* immersion, that is, dipping three times in the water. Every brother is allowed to speak in the congregation, and their best speaker is usually ordained to be their preacher. They are also called *dunkers* and *tumblers*.

**TUNNAGE**. See **TONNAGE**.

**TUNNEL**, *n.* [Fr. *tonnelle*.] An old name for a funnel.—2. The opening of a chimney for the passage of smoke; called generally a *funnel*.—3. In *engineering*, an arched subterranean passage cut through a hill, a rock, an eminence, or under a river or town, to

carry a canal, a road, railway, &c., in an advantageous course. In the construction of canals and railways, tunnels are frequently had recourse to, in order to obtain the requisite level, and save the expense of open cutting, and for various other local causes.—4. An arched drain or sewer.

**TUNNEL**, *v. t.* To form like a tunnel; as, to *tunnel* fibrous plants into nests.—2. To catch in a net called a *tunnel-net*.—3. To form with net work.—4. To make an opening or way for passage, through a hill, or mountain, or under a river.

**TUNNELLED**, *pp.* Formed like a tunnel; penetrated by an artificial opening for a passage.

**TUNNELLING**, *ppr.* Forming like a tunnel; penetrating by a subterranean passage.

**TUNNELING**, *n.* The operation of cutting an arched passage through a hill or other eminence, or under a river or town, in order to conduct a canal, road, or railway on a lower level than the natural surface. The Thames tunnel is the most remarkable instance of tunnelling under a river, and perhaps the most astonishing work of the kind ever executed.

**TUNNEL-KILN**, *n.* A lime-kiln in which coal is burnt, as distinguished from a *flame-hiln*, in which wood or peat is used.

**TUNNEL-NET**, *n.* A net with a wide mouth at one end, and narrow at the other.

**TUNNEL-PIT**, *n.* A shaft sunk from the top of the ground to the level of an intended tunnel, for drawing up the earth and stones.

**TUNNING**, *ppr.* Putting into casks.

**TUNNY**, *n.* [It. *tonno*; Fr. *thon*; G. *thunfisch*; L. *thynnus*.] A fish of the genus *Thynnus*, the *T. vulgaris* of

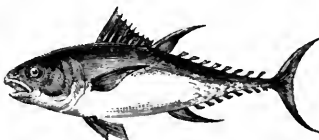

Tunny (*Thynnus vulgaris*).

*Cur.*, belonging to the family *Scomberoides*, or mackerel tribe. This fish is an object of considerable importance to many of the nations bordering on the Mediterranean, and when salted and dried, serves the inhabitants of most catholic countries with the fast day's meat. The tunnies, like the mackerel, appear in great shoals or banks, and their approach is perceived by the fishermen at a considerable distance, from the noise which accompanies their rapid movements. The tunny attains to a large size, weighing sometimes a thousand pounds. The flesh somewhat resembles veal, is delicate, and has been in request from time immemorial. The tunny is abundant in the seas of the south of Europe, and it has occasionally been found in the British seas.

**TUP**, *n.* A ram. [Local.]

**TUP**, *v. t.* [Gr. *τυπω*.] 1. To butt; as, a ram. [Local.]—2. To cover; as, a ram. [Local.]

**TUPELO**, *n.* A North American forest tree of the genus *Nyssa*, the *N. denticulata*; nat. order *Santalaceæ*. It is a lofty tree of great beauty. The same

name is given to other species of the genus, some of which are also called *black gum*, *sour gum*, *gum tree*, &c.

**TUP-MAN**, *n.* A man who deals in tups. [Local.]

**TURBAN**, *n.* [Ar.] A head dress worn by the Orientals, consisting of a cap, and a sash of fine linen or taffeta artfully wound round it in plaits. The cap is red or green, roundish on the top, and quilted with cotton. The sash of the Turks is white linen: that of the Persians is red woollen. The Turkish sultan's turban contains three heron's feathers, with many diamonds and other precious stones; the Grand vizier's turban has two heron's feathers, and other officers but one.—2. A kind of head dress worn by ladies.—3. In *conchology*, the whole set of whorls of a shell.

**TURBAN-CROWNED**, *a.* Crowned with a turban.

**TURBANED**, *a.* Wearing a turban; as, a *turbaned Turk*.

**TURBAN-SHELL**, *n.* In *nat. hist.*, the popular name of a genus of shells, or rather of sea urchins (*echinodermata*), of a hemispheric or spheroidal shape, the *Cidaris* of Klein.

**TURBAN-TOP**, *n.* A plant of the genus *Helvella*; a kind of fungus or mushroom.

**TURBARY**, *n.* [from *turf*; Latinised, *turbaria*.] 1. In *law*, a right of digging turf on another man's land. *Common of turbary*, is the liberty which a tenant enjoys of digging turf on the lord's waste.—2. The place where turf is dug.

**TURBID**, *a.* [L. *turbidus*, from *turbo*, to disturb, that is, to stir, to turn.] Properly, having the lees disturbed; but in a more general sense, muddy; foul with extraneous matter; thick, not clear; used of liquids of any kind; as, *turbid water*; *turbid wine*. Streams running on clay generally appear to be *turbid*. This is often the case with the river *Seine*.

**TURBIDITY**, *n.* The state of being turbid.

**TURBIDLY**, *adv.* In a turbid manner; muddily.—2. Proudly; haughtily; a *Latinism*.

**TURBIDNESS**, *n.* Muddiness; foulness.

**TURBILLION**, *n.* [Fr. *tourbillon*.] A whirl; a vortex.

**TURBINATE**, } *a.* [L. *turbinatus*,  
**TURBINATED**, } formed like a top, from *turbo*, *turben*, a top.] 1. Of a spiral oblong form; shaped like a top.—2. In *conchology*, spiral, or wreathed conically from a larger base to a kind of apex; as, *turbinated shells*.—3. In *bot.* shaped like a top or cone inverted; narrow at the base, and broad at the apex; as, a *turbinated germ*, nectary, or pericarp.—4. Whirling. [Lil. *us*.]

**TURBINATION**, *n.* The act of spinning or whirling, as a top.

**TURBINE**, *n.* A species of hydraulic engine, employed to a considerable extent in modern times, as a prime mover for machinery. It is considered to be preferable to ordinary water wheels, in situations where the height of the fall is great and the quantity of water not very considerable. The annexed cut represents an example of a turbine, or *horizontal water-wheel*. The water is introduced into a close cast-iron vessel *a*, by the pipe *b*, connecting it with the reservoir. Here, by virtue of its pressure, it tends to escape by

any aperture which may be presented; but the only apertures consist of a

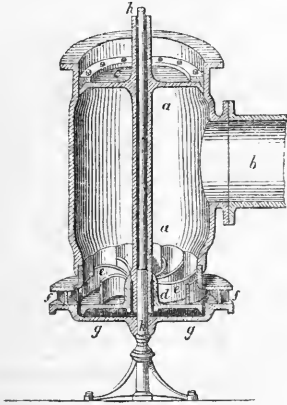

Turbine.

series of curved float boards *f f*, fixed to a horizontal plate *g*, mounted upon a central axis *h*, which passes upwards through a tube connecting the upper and lower covers, *c* and *d*, of the vessel *a*. Another series of curved plates *e e*, is fixed to the upper surface of the disc *d*, to give a determinate direction to the water before flowing out at the float boards, and the curves of these various parts are so adjusted as to render the reactive force of the water available to the utmost extent in producing a circular motion. The machinery to be impelled is connected with the axis *h*.

**TURBINEL/Ā, n.** [from *Turbo*.] A genus of molluscs, belonging to the family Siphonostomata. The species inhabit the Indian Ocean.

**TURBINIDÆ, n.** [See *Turbo*.] A family of gastropod molluscs, of which the genus *Turbo*, Linn. is the type.

**TURBINITE, } n.** A petrified shell  
**TURBITE, } of the turbo kind.**

**TURBIT, n.** A variety of the domestic pigeon, remarkable for its short beak; called by the Dutch *kort-bek*, short beak.—2. The turbot.

**TURBITH, n.** An incorrect spelling of *Turpeth*,—which see.

**TURBO, n.** [L. a whirling or turning round; a top.] A Linnæan genus of gastropod molluscs, belonging to the order Phytophaga, and family Turbinidæ. It comprises all those species which have a completely and regularly turbinated shell and a perfectly round aperture. The animal resembles a limax or slug. The periwinkle is an example. In the arrangement of Cuvier the genus *Turbo* is placed in his order of Pectinibranchiate gastropods, family Trochoidea, and he subdivides it into the following groups:—*Delphinula*, *Pleurotoma*, *Turritella*, *Scalaria*, *Cyclostoma*, and *Valvata*.

**TURBOT, n.** [Fr.] A well known and highly esteemed fish of the genus *Rhombus*, Cuv. (*R. maximus*); family Pleuronectidae, order Malacopterygii, and section Subbrachiales. Next to the halibut, the turbot is the largest of the Pleuronectidae found on the British coast, and is the most highly esteemed for the table. It is of a short and broad form, and rather deeper than

many of the flat fishes. There is a considerable fishery of turbot on the

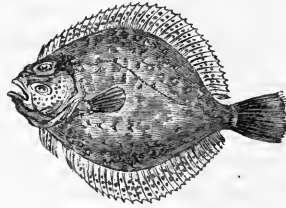
Turbot (*Rhombus maximus*).

coasts of Durham and Yorkshire, but a large portion of the turbot produced in the English market is taken on or near the various sand banks between the line of our eastern shore and the coast of Holland. In Scotland, the turbot is called the Rawn Fleuk, and Bannock Fleuk.

**TURBULENCE, or TURBULENCY, n.** [See *TURBULENT*.] A disturbed state; tumult; confusion; as, the *turbulence* of the times; *turbulence* in political affairs.—2. Disorder or tumult of the passions; as, *turbulence* of mind.—3. Agitation; tumultuousness; as, *turbulence* of blood.—4. Disposition to resist authority; insubordination; as, the *turbulence* of subjects.

**TURBULENT, a** [L. *turbulentus*, from *turbo*, to disturb.] 1. Disturbed; agitated; tumultuous; being in violent commotion; as, the *turbulent* ocean.

Calm region once,

And full of peace, now tost and *turbulent*.

Milton.

The *turbulent* mirth of wine. Dryden.

2. Restless; unquiet; refractory; disposed to insubordination and disorder; as, *turbulent* spirits.—3. Producing commotion.

Whose heads that *turbulent* liquor fills with fumes. Milton.

**TURBULENTLY, adv.** Tumultuously; with violent agitation; with refractoriness.

**TURCISM, n.** The religion of the Turks.

**TURDIDÆ, n.** [See *TURDUS*.] The family of thrushes.

**TURDUS, n.** [L.] The thrush; a genus of passerine birds. [See *TURDUS*.]

**TUREEN, n.** [Fr. *terrine*.] A vessel for holding soup.

**TURF, n.** [Sax. *tyrf*; D. *turf*; G. and Sw. *torf*; Fr. *tourbe*; Ir. *tarp*, a clod. The word seems to signify a collection, a mass, or perhaps an excrescence.]—

1. That upper stratum of earth and vegetable mould, which is filled with the roots of grass and other small plants, so as to adhere and form a kind of mat, which allows it to be raised in slices by the plough or the paring tool made for the purpose. This is otherwise called *sward* and *sod*.—2. Peat; a peculiar kind of blackish, fibrous, vegetable, earthy substance, used as fuel. [This word has a regular plural, *turfs*, but the old plural was *turves*.]—3. Race ground; or horse racing. The honours of the *turf* are all our own.

Cowper.

**TURF, v. t.** To cover with turf or sod; as, to *turf* a bank or the border of a terrace.

**TURF-BUILT, a.** Formed of turf.

**TURF-CLAD, a.** Covered with turf.

**TURF-COVERED, a.** Covered with turf.

**TURF-DRAIN, n.** A kind of pipe-drain constructed with turfs, cut from the surface of the soil.

**TURF'ED, pp.** Covered with turf or green sod.

**TURF'EN, a.** Made of turf; covered with turf.

**TURF-HEDGE, n.** A hedge or fence formed with turf and plants of different kinds.

**TURF-HOUSE, n.** A house or shed formed of turf, common in the northern parts of Europe.

**TURF'INESS, n.** [from *turfy*.] The state of abounding with turf, or of having the consistence or qualities of turf.

**TURF'ING, ppr.** Covering with turf. **TURF'ING, n.** The operation of laying down turf, or covering with turf.

**TURF'ING-IRON, n.** An implement for paring off turf.

**TURF'ING-SPADE, n.** An instrument for under-cutting turf, when marked out by the plough.

**TURF-KNIFE, n.** An implement for tracing out the sides of drains, trenches, &c. It has a scimitar-like blade, with a tread for the foot and a bent handle.

**TURF-MOSS, n.** A tract of turf, mossy, or boggy land.

**TURF-SPADE, n.** A spade used for cutting turf from pastures, and in removing ant-hills and other inequalities.

**TURF'Y, a.** Abounding with turf.—2. Having the qualities of turf.—3. Formed of turf.

**TUR'GENT, a.** [L. *turgens*, from *turgeo*, to swell.] Swelling; tumid; rising into a tumour or puffy state; as, when the humors are *turgent*.

**TURGES' CENCE, } n.** [L. *turgescens*.]  
**TURGES' CENCY, } 1. The act of swelling.—2. The state of being swelled.—3. Empty pompousness; inflation; bombast.**

**TURGES' CENT. a.** Growing large; in a swelling state.

**TUR'GID, a.** [L. *turgidus*, from *turgeo*, to swell.] 1. Swelled; bloated; distended beyond its natural state by some internal agent or expansive force. A bladder held by the fire grew *turgid*.

Boyle.

*More generally*, the word is applied to an enlarged part of the body; as, a *turgid* limb.

2. Tumid; pompous; inflated; bombastic; as, a *turgid* style; a *turgid* manner of talking.

**TURGIDITY, n.** State of being swelled; tumidness.

**TUR'GIDLY, adv.** With swelling or empty pomp.

**TUR'GIDNESS, n.** A swelling or swelled state of a thing; distention beyond its natural state by some internal force or agent; as, in a limb.—2. Pompousness; inflated manner of writing or speaking; bombast; as, the *turgidness* of language or style.

**TUR'IO, n. plur. Turiones.** [L.] In *bot.*, the subterranean bud of a perennial herbaceous plant, annually developed, and producing a new stem; as, the young shoots of grasses which have a rhizoma or creeping stem.

**TURIONIFEROUS, a.** [L. *turio*, a shoot, and *fero*, to bear.] Producing shoots.

**TURKEY, n.** A large gallinaceous fowl, the *Meleagris gallo-pavo*, and the original stock from which the domesticated turkey is derived. It is a native of America, and was introduced into Europe

in the 16th century. The size of this noble bird and the delicious quality of

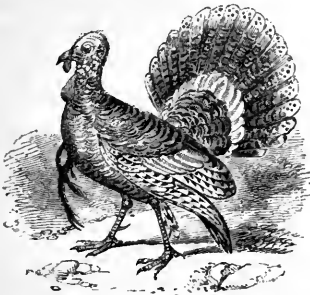

American Wild Turkey (*Meleagris gallo-pavo*).

its flesh and eggs, have rendered it extremely common. Wild turkeys abound in the forests of America, where they feed on berries, fruits, grasses, maize, beetles, tadpoles, young frogs, and lizards. There is another species, the *Meleagris ocellata*, found about the Bay of Honduras.

**TURKEY BERRIES**, *n.* The berries of some species of *Rhamnus*, which form an article of commerce from the Mediterranean, on account of the colouring matter which they yield, which varies from yellow to green. [*See RHAMNUS.*]

**TURKEY-BUZZARD**, *n.* In America, a common species of vulture, having a distant resemblance to a turkey, and remarkable for its graceful flight in the higher regions of the air. It is the *Cathartes aura* of Illiger, and the *Vultur aura*, Linn.

**TURKEY OAK**, *n.* A species of oak, the *Quercus cerris*, indigenous to Spain and the south of Europe.

**TURKEY RED**, *n.* A brilliant red dye produced on cotton and woollen cloth by madder.

**TURKEY-STONE**, } *n.* A mineral  
**TURKEY-HONE**, } which occurs massive, with a slaty structure. Colour commonly greenish-grey, sometimes yellowish or brownish-grey. It is translucent on the edges, yields to the knife, and is somewhat unctuous to the touch. When cut and polished it is used for sharpening small cutting instruments. It is also termed *Novaculite* and *Whetslate*, and was first brought from the Levant.

**TURKISH**, *a.* Pertaining to the Turks.  
**TURKISHLY**, *adv.* In the manner of the Turks.

**TURK'OIS**, } *n.* [*Fr. turquoise*, from  
**TURQUOISE**, } *Turkey*.] A mineral, called also calcite, brought from Persia, of a peculiar bluish-green colour, occurring in rounded masses, or in reniform masses, with a botryoidal surface. It is susceptible of a high polish, and is used in jewelry, and when highly coloured is much esteemed as a gem. It is usually written in the French manner.

**TURK'S-CAP**, *n.* A plant of the genus *Lilium*; and also of the genus *Melocactus*.

**TURK'S-HEAD**, *n.* Plants of the genera *Mammillaria* and *Melocactus*.

**TURK'S-TURBAN**, *n.* A plant of the genus *Ranunculus*.

**TURLUPINS**, *n.* [*Fr.*] In *Fr. eccles. hist.*, a nickname applied to the secretaries of the 14th century, who were

the precursors of the Reformation. They were otherwise called *Lollards*, *Beghards*, *Picards*, &c.

**TURM**, *n.* [*L. turma.*] A troop. [*Not English.*]

**TURMA**, *n.* [*L.*] In the Roman army a company of horse; the tenth part of a legion. There were three decurie or thirty horsemen in each turma.

**TURMALIN**, *n.* An electric stone. [*See TOURMALIN.*]

**TURMERIC**, *n.* [*Ital. turtumaglio.*] Thompson says, Sans. and Pers. *zur*, yellow, and *mirich*, pepper.] Indian saffron, the root of a plant of the genus *curcuma*, the *C. longa*, imported from Bengal, Java, China, &c. It is externally greyish, but internally of a deep lively yellow or saffron colour. It has a slight aromatic smell, and a bitterish, slightly acrid taste. It was formerly used as a medicine, but in Europe it is now only used as a dye. It yields a beautiful bright yellow dye, which is, however, extremely fugitive. The Indians use it for colouring and seasoning their food. [*See CURCUMA.*] This name is sometimes given to the blood-root, *Sanguinaria canadensis*, of America, and also to the *Hydrastis canadensis*.

**TURMOIL**, } *n.* [We know not the  
**TURMOIL**, } origin of this word; but it is probably from the root of the *L. turba*, *turbo*, *turma*, or of *turn*.] Disturbance; tumult; harassing labour; trouble; molestation by tumult.

There I'll rest, as after much *turmoil*  
A blessed soul doth in Elysium. *Shak.*

**TURMOIL**, } *v. t.* To harass with  
**TURMOIL**, } commotion.

It is her fatal misfortune...to be miserably tossed and *turmoiled* with these storms of affliction. *Spenser.*

2. To disquiet; to weary.

**TURMOIL**, } *v. i.* To be disquieted; to  
**TURMOIL**, } be in commotion.

**TURMOILED**, } *pp.* Harassed with  
**TURMOILED**, } commotions.

**TURN**, *v. t.* [*Sax. turnan*, *tyrnan*; *L. torno*; *Gr. τροχός*; *Fr. tourner*; *It. torno*, a wheel; *L. turnus*; *tornaire*, to turn; *tornare*, to return; *tornare*, *tornire*; to turn, to fence round, to tilt; *tornimento*, tournament; *G. turnier*, a tilt; *Sw. tornera*, to run tilt, *Dan. turner*; *W. tern*, turn, from *tur*, a turning; *Gaelic. turna*, a spinning wheel; *turmoir*, a turner. This is probably a derivative verb from the root of *Ar. daura*, to turn.] 1. To cause to move in a circular course; as, to *turn* a wheel; to *turn* a spindle; to *turn* the body.—2. To change or shift sides; to put the upper side downward, or one side in the place of the other. It is said a hen *turns* her eggs often when sitting.—3. To alter, as a position.

Expert  
When to advance, or stand, or *turn* the  
sway of battle. *Milton.*

4. To cause to preponderate; to change the state of a balance; as, to *turn* the scale.—5. To bring the inside out; as, to *turn* a coat.—6. To alter, as the posture of the body, or direction of the look.  
The monarch *turns* him to his royal guest.

7. To form on a lathe; to give circular or other forms to bodies by means of a lathe.—8. To form; to shape; used in the *participle*; as, a body finely *turned*.  
His limbs now *turn'd*. *Pope.*

9. To change; to transform; as, to

*turn* evil to good; to *turn* goods into money.

Impatience *turns* an ague into a fever. *Taylor.*

I pray thee, *turn* the counsel of Ahiathophel into foolishness; 2 Sam. xv.

10. To metamorphose; as, to *turn* a worm into a winged insect.—11. To alter or change, as colour; as, to *turn* green to blue.—12. To change or alter in any manner; to vary.—13. To translate; as, to *turn* Greek into English.

Who *turns* a Persian tale for half a crown. *Pope.*

14. To change, as the manner of writing; as, to *turn* prose into verse.—15. To change, as, from one opinion or party to another; as, to *turn* one from a tory to a whig; to *turn* a Mohammedan or a Pagan to a Christian.—16. To change in regard to inclination or temper.

*Turn* thee to me, and have mercy on me; Ps. xxv.

17. To change or alter from one purpose or effect to another.

God will make these evils the occasion of greater good, by *turning* them to our advantage. *Tillotson.*

18. To transfer.  
Therefore he slew him, and *turned* the kingdom to David; 1 Chron. x.

19. To cause to nauseate or loathe; as, to *turn* the stomach.—20. To make giddy. Eastern priests in giddy circles run, And *turn* their heads to imitate the sun. *Pope.*

21. To infatuate; to make mad, wild, or enthusiastic; as, to *turn* the brain.

—22. To change direction to or from any point; as, to *turn* the eyes to the heavens; to *turn* the eyes from a disgusting spectacle.—23. To direct by a change to a certain purpose or object; to direct, as the inclination, thoughts, or mind. I have *turned* my mind to the subject.

My thoughts are *turn'd* on peace. *Addison.*

24. To revolve; to agitate in the mind.  
*Turn* those ideas about in your mind. *Watts.*

25. To bend from a perpendicular direction; as, to *turn* the edge of an instrument.—26. To move from a direct course or straight line; to cause to deviate; as, to *turn* a horse from the road, or a ship from her course.—27. To apply by a change of use.

When the passage is open, land will be *turned* most to cattle. *Temple.*

28. To reverse.

The Lord thy God will *turn* thy captivity, and have compassion on thee; Deut. xxx.  
29. To keep passing and changing in the course of trade; as, to *turn* money or stock two or three times in the year.—30. To adapt the mind; chiefly in the *participle*.

He was perfectly well *turned* for trade. *Addison.*

31. To make acid; to sour; as, to *turn* cider or wine; to *turn* milk.—32. To persuade to renounce an opinion; to dissuade from a purpose, or cause to change sides. You cannot *turn* a firm man.—*To turn aside*, to avert.—*To turn away*, to dismiss from service; to discard; as, to *turn away* a servant.—2. To avert; as, to *turn away* wrath or evil.—*To turn back*, to return; as, to *turn back* goods to the seller. [*Lit. us.*]

—*To turn down*, to fold or double down.—*To turn in*, to fold or double; as, to *turn in* the edge of cloth.—*To turn off*, to dismiss contemptuously; as, to *turn off* a sycophant or parasite.—2. To give over; to resign. We are

not so wholly *turned off* from that reversion.—3. To divert; to deflect; as, to *turn off* the thoughts from serious subjects.—4. To throw off a criminal from the platform, that he may hang.—*To be turned of*, to be advanced beyond; as, to be *turned of* sixty-six.—*To turn out*, to drive out; to expel; as, to *turn a family out* of doors, or *out of the house*.—2. To put to pasture; as cattle or horses.—*To turn over*, to change sides; to roll over.—2. To transfer; as, to *turn over* a business to another hand.—3. To open and examine one leaf after another; as, to *turn over* a concordance.—4. To over-set.—*To turn to*, to have recourse to.

Helvetius' tables may be *turned to* on all occasions. *Locke.*

*To turn upon*, to retort; to throw back; as, to *turn the arguments of an opponent upon himself*.—*To turn the back*, to flee; to retreat; Exod. xxiii.—*To turn the back upon*, to quit with contempt; to forsake.—*To turn the die or dice*, to change fortune.

**TURN, v. i.** To move round; to have a circular motion; as, a wheel *turns on its axis*; a spindle *turns on a pivot*; a man *turns on his heel*.—2. To be directed.

The understanding *turns inward* on itself, and reflects on its own operations. *Locke.*

3. To show regard by directing the look toward any thing.

*Turn mighty monarch, turn this way;*  
Do not refuse to hear. *Dryden.*

4. To move the body round. He *turned to me with a smile*.—5. To move; to change posture. Let your body be at rest; do not *turn in the least*.—6. To deviate; as, to *turn from the road or course*.—7. To alter; to be changed or transformed; as, wood *turns to stone*; water *turns to ice*; one colour *turns to another*.—8. To become by change; as, the fur of certain animals *turns in winter*.

Cygnets from gray *turn white*. *Bacon.*  
9. To change sides. A man in a fever *turns often*.—10. To change opinions or parties; as, to *turn Christian* or Mohammedan.—11. To change the mind or conduct.

*Turn from thy fierce wrath;* Exod. xxxii.  
12. To change to acid; as, milk *turns suddenly* during a thunder storm.—13. To be brought eventually; to result or terminate in. This trade has not *turned to much account* or advantage. The application of steam *turns to good account*, both on land and water.—14. To depend on for decision. The question *turns on a single fact or point*.—15. To become giddy.

I'll look no more,

Lest my brain *turn*. *Shak.*

16. To change a course of life; to repent. *Turn ye, turn ye from your evil ways, for why will ye die?* Ezek. xxxiii.

17. To change the course or direction; as, the tide *turns*.—18. To exercise the art or trade of a turner; to operate upon wood, metal, &c., by means of a turning lathe.—*To turn about*, to move the face to another quarter.—*To turn away*, to deviate.—2. To depart from; to forsake.—*To turn in*, to bend inward.—2. To enter for lodgings or entertainment; Gen. xix.—3. To go to bed.—*To turn off*, to be diverted; to deviate from a course. The road *turns off to the left*.—*To turn on or upon*, to reply or retort.—2. To depend on.—*To turn out*, to move from its place, as a bone.—2. To bend outward; to project.—3. To rise from bed; also, to come

abroad.—*To turn over*, to turn from side to side; to roll; to tumble.—2. To change sides or parties.—*To turn to*, to be directed; as, the needle *turns to the magnetic pole*.—*To turn under*, to bend or be folded downward.—*To turn up*, to bend or be doubled upward.

**TURN, n.** The act of turning; movement or motion in a circular direction; whether horizontally, vertically, or otherwise; a revolution; as, the *turn of a wheel*.—2. A winding; a meandering course; a bend or bending; as, the *turn of a river*.—3. A walk to and fro. I will take a *turn in your garden*. *Dryden.*  
4. Change; alteration; vicissitude; as, the *turns and varieties of passions*.  
Too well the *turns of mortal chance* I know. *Pope.*

5. Successive course.

Nobleness and bounty...which virtues had their *turns in the king's nature*. *Bacon.*

6. Manner of proceeding; change of direction. This affair may take a different *turn from that which we expect*.—7. Chance; hap; opportunity.

Every one has a fair *turn to be as great as he pleases*. *Collier.*

8. Occasion; incidental opportunity. An old dog falling from his speed, was loaded at every *turn with blows and reproaches*. *L'Strange.*

9. Time at which, by successive vicissitudes, any thing is to be had or done. They take each other's *turn*.

His *turn* will come to laugh at you again. *Denham.*

10. Action of kindness or malice. Thanks are half lost when good *turns are delay'd*. *Fairfax.*

Some malicious natures place their delight in doing ill *turns*. *L'Strange.*

11. Reigning inclination or course. Religion is not to be adapted to the *turn and fashion of the age*.—12. A step off the ladder at the gallows.—13. Convenience; occasion; purpose; exigence; as, this will not serve his *turn*.—14. Form; cast; shape; manner; in a literal or figurative sense; as, the *turn of thought*; a man of a sprightly *turn in conversation*.

The *turn of his thoughts and expression* is unharmonious. *Dryden.*  
Female virtues are of a domestic *turn*. *Addison.*

The Roman poets, in their description of a beautiful man, often mention the *turn of his neck and arms*. *Addison.*

15. Manner of arranging words in a sentence.—16. Change; new position of things. Some evil happens at every *turn of affairs*.—17. Change of direction; as, the *turn of the tide* from flood to ebb.—18. One round of a rope or cord.—19. In *mining*, a pit sunk in some part of a drift.—20. In *music*, a grace marked thus ♪. It is formed of appoggiaturas, consisting of the note on which the turn is made, the note above, and the semitone below: If the turn is written thus, it is performed as below:—

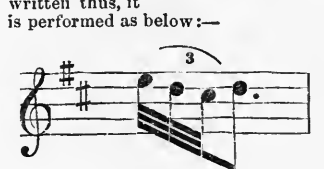
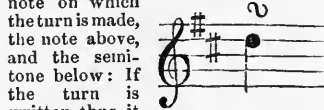

21. *Turn or tourn*, in law. [See **TOURN**.]

—*By turns*, one after another; alternately. They assist each other *by turns*.—2. At intervals. They feel *by turns* the bitter change. *Milton.*  
*To take turns*, to take each other's place alternately.

**TURN'-BENCH, n.** [*turn and bench*.] A kind of iron lathe.

**TURN'CAP, n.** A chimney top which turns round with the wind.

**TURN'-COAT, n.** [*turn and coat*.] One who forsakes his party or principles.

**TURN'ED, pp.** Moved in a circle; changed; formed by means of a turning lathe.

**TURN'ER, n.** One whose occupation is to form things with a lathe; one who turns.—2. A variety of pigeon.

**TURN'ERA, n.** A genus of plants, the type of the nat. order Turneraceae. The species are found in South America and the West India Islands. They are mostly small plants, with inconspicuous flowers, generally of a yellow colour, and are frequently cultivated in gardens.

**TURNERA'CEÆ, n.** A nat. order of polypetalous exogenous plants, nearly allied to Loasaceae and Passifloraceae. This order has only two genera, Turnera and Piqueta; all the species are herbaceous plants, natives of South America and the West Indies.

**TURN'ERITE, n.** A rare mineral occurring in small crystals of a yellowish brown colour, externally brilliant and translucent. The primary form is an oblique rhombic prism; fracture conchoidal; lustre vitreous. It occurs at Mount Sorel in France, and consists chiefly of alumina, lime, and magnesia, with a little iron, and a minute portion of silica.

**TURN'ER'S-YELLOW, n.** An oxichloride of lead employed as a yellow pigment. It is also called *cassel yellow*, and *patent yellow*.

**TURN'ERY, n.** The art of forming into a cylindrical shape by the lathe.—2. Things made by a turner or in the lathe.

**TURN'-FILE, n.** An instrument used by comb-makers in sharpening a kind of tool called a *float*.

**TURN'ING, ppr.** Moving in a circle; changing; winding.

**TURN'ING, n.** A winding; a bending course; flexure; meander.—2. Deviation from the way or proper course.—3. The art or operation of giving circular and other forms to bodies, as wood, metal, bone, ivory, &c., by making them revolve in various manners in a machine called a lathe, and applying cutting instruments so as to produce the form required; or by making the cutting instrument revolve when the substance to be operated upon is fixed. The art of turning is of immense importance to the practical mechanic, and in the whole range of manufactures, whether of articles of necessity, utility, ornament, or luxury, there is no art so generally applied. At the same time, there is probably no art in the range of mechanical operation susceptible of greater accuracy, and there is none which has so much contributed to the improvement of machinery. The lathe is a most wonderful contrivance, especially when we take into account all the improvements it has undergone, from its simplest and most ancient form in the potter's wheel, to that adaptation of varied and complex mechanism, by which, not merely cir-

cular turning of the most beautiful and accurate description, but exquisite figure-work, and complicated geometrical designs, depending upon eccentric and cycloidal movements, are produced. In ordinary turning, the body operated upon is made to revolve on a stationary straight line, as an axis, and a cutting tool applied to its surface in such a way, as, in the circumvolutions of the object, to cut off those parts which lie farthest from the axis, and make the outside of the substance concentric with the axis. In this case any section of the work made at right angles to its axis will be of a circular figure; but there are methods of turning several other curves in a variety of ways. Lathes are made in a great variety of forms, and put in motion by different means. They are called *centre lathes*, when the work is supported at both ends; *mandrel, spindle, or chuck-lathes*, when the work is fixed only at one end. There are also *pole lathes*, and *turn-bench lathes*, which resemble each other; *foot-lathes*, which are moved by the foot; *bar-lathes*, &c. Lathes for great works are moved by horses and water-wheels, but more generally by steam-engines. The largest columns, the most ponderous artillery, the minutest pivots of watch-work, wheel-work, rotatory machines, vessels, &c., are executed by means of the lathe.

**TURN'INGNESS**, *n.* Quality of turning; tergiversation; subterfuge.

**TURN'ING-PIECE**, *n.* In *arch.*, a board having a circular edge for turning a thin brick arch upon.

**TURN'ING-POINT**, *n.* The point on which a thing turns; that which decides a matter.

**TURN'IP**, *n.* [a compound of *tur*, round, and *Sax. naepe, L. napus*, a turnip.] The common name of the *Brassica rapa*, a cruciferous plant much cultivated both in the field and in the garden, on account of its bulbous esulent root. In its wild state, it is a native of Great Britain, found in the borders of fields and waste places; but by cultivation the size of the plant, especially of the tuber or underground stem, is greatly increased. There are many varieties of the turnip cultivated for the table, and also in the fields. Those grown by farmers may be arranged as *whites* and *yellow*s. The Swedish turnip is the *Brassica campestris rutabaga*. The young leaves and buds of the turnip are gathered and eaten under the name of *turnip tops*; the tubers consist of a large mass of soft cellular tissue, in which starch and sugar are deposited. Their great importance as food for cattle is well known, and turnips and clover are the two main pillars of the best courses of British husbandry. Oil is produced from the seeds of several varieties of the turnip.

**TURN'NIP-FLY**, *n.* A small coleopterous insect of the genus *Haltica*, the *H. nemorum*, very destructive to young turnips.

**TURN'KEY**, *n.* A person who has charge of the keys of a prison for opening and fastening the doors.

**TURN'OUT**, *v.* [turn and out.] The act of coming forth; a quitting of employment.—2. The place in a railway where trucks and carriages turn out of the way. Applied also to an equipage.—3. In *colloquial style*, a multitude of persons, who have come out on some

public occasion; as, to see a spectacle, to witness a performance at the theatre, attend a public meeting, &c.

**TURN'-OVER**, *n.* A kind of apple pie or tart, in a semicircular form.—2. An apprentice transferred from one master to another, to complete his term of apprenticeship. [Both *colloquial*.]—3. A piece of white linen formerly worn by cavalry over their stocks.—**Turn-over-table**, a table whose top is so fitted to the supporting block or pedestal that it can be turned up at pleasure; and thus, when out of use, it may be placed against the wall of the apartment, so as to occupy less space. [Familiar.]

**TURN'PIKE**, *n.* [turn and pike.] Strictly, a frame consisting of two bars crossing each other at right angles, and turning on a post or pin, placed on a road or footpath, to hinder the passage of beasts, but admitting a person to pass between the arms.—2. A gate set across a road, watched by an officer appointed for the purpose, in order to stop carriages, carts, waggons, &c., and sometimes travellers, till toll is paid for keeping the road in repair. It is generally called a *toll-bar* or *toll-gate*.—3. A turnpike road.—4. In *military affairs*, a beam filled with spikes to obstruct passage.

**TURN'PIKE**, *v. t.* To form, as a road, in the manner of a turnpike road; to throw the path of a road into a rounded form.

**TURN'PIKE**, } *n.* A round  
**TURN'PIKE-STAIR**, } staircase, attached to, but built outside of a house. [Scotch.]

**TURN'PIKED**, *pp.* Formed in the manner of a turnpike-road.

**TURN'PIKE-MAN**, *n.* A tollman.

**TURN'PIKE-ROAD**, *n.* A road on which turnpikes or tollgates are established by law, and which are made and kept in repair by the toll collected from carriages, waggons, cattle, &c., which travel on them. Turnpike roads are placed by Act of Parliament under the management of trustees or commissioners, who are invested with certain powers for the construction, management, and repair of such roads.  
**TURN'PIKE-TRUST**, *n.* The individuals in whom the care and revenue of turnpike roads are vested; or the business connected therewith.

**TURN'-PLATE**. See **TURN-TABLE**.  
**TURN'-SERVING**, *n.* [turn and serve.] The act or practice of serving one's turn or promoting private interest.

**TURN'SICK**, *a.* [turn and sick.] Giddy; vertiginous.

**TURN'SICK**, *n.* A disease of sheep.

**TURN'SOLE**, } *n.* [turn and *L. sol*, the  
**TURN'SOL**, } sun.] A plant of the genus *Heliotropium*, so named because its flower is supposed to turn toward the sun. [See **HELIOTROPE**.]—2. A blue pigment obtained from the lichen *Rocella tinctoria*, also called *archil*.

**TURN'SPIT**, *n.* [turn and spit.] A person who turns a spit.

His lordship is his majesty's *turnspit*.  
*Burke*.

2. A variety of the dog, allied to the terriers, so called from having formerly been employed to turn a wheel on which depended the spit for roasting meat in the kitchen.

**TURN'STILE**, *n.* [turn and stile.] A turnpike in a footpath.

**TURN'STONE**, *n.* [turn and stone.] A

bird, called the sea-dotterel, of the genus *Streptilas*, the *S. collaris*, (Tringa



Turnstone (*Streptilas collaris*).

morinella, Linn.) a little larger than an English blackbird. This bird takes its name from its practice of turning up small stones in search of insects.

**TURN'-TABLE**, } *n.* In *railways*, a  
**TURN'-PLATE**, } circular platform of iron and wood, placed on a level with the tracks, and mounted on friction wheels, so as to turn on its centre with great facility. Turn-tables are used for transferring single carriages from one track to another. They are placed in pairs, one upon each track, and if A and B be supposed to represent two tracks parallel to each other, and C a turn-table connected with the

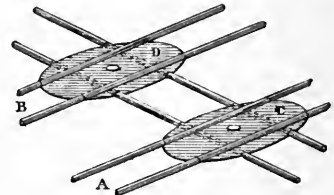

Turn-table.

track A, and D another connected with the track B, then a carriage to be transferred from A to B is rolled on the turn-table C, and this, with the carriage on it, is turned a quarter round. The carriage is then rolled on the table D, which being turned a quarter round, puts the carriage in a right position for running on the track B.

**TUR'PENTINE**, *n.* [*L. terebinthina*; Sp. and It. *trementina*; G. *terpentin*.] An oleo-resinous substance, flowing naturally or by incision from several species of trees, as from the pine, larch, fir, pistacia, &c. Common turpentine is obtained from the *Pinus sylvestris*, and some other species of *Pinus*. All the turpentines dissolve in pure alcohol, and by distillation yield oils, which are termed *spirits of turpentine*. Oil or spirits of turpentine is used in medicine externally as an excellent rubefacient, and counter-irritant, and internally as a vermifuge. It is also much used in the arts for dissolving resins and oils in making varnishes. [See **TEREBINTH**.]

**TUR'PENTINE-TREE**, *n.* The name given to some species of trees of the genus *Pistacia*, which yield turpentine, as the *P. terebinthus*, the Venetian turpentine tree, *P. atlantica*, the Mount Atlas Mastich or turpentine tree, &c. The *P. terebinthus* produces not only its proper fruit, but a kind of horny substance which grows on the

surface of its leaves. This is an excrescence, the effect of the puncture of



Turpentine tree (*Pistacia terebinthus*).

an insect, and is produced in the same manner as the galls of other plants.

**TURPETH**, *n.* [*L. turpetum*; *Gr. τροχίτηρ*.] The name of the root of *Convolvulus turpetum*, a plant of Ceylon, Malabar, and New Holland, which has a cathartic power. It is sometimes called *vegetable turpeth*, to distinguish it from *mineral turpeth*.

**TURPETH-MINERAL**, *n.* The name formerly given to a subsulphate of the binoxide of mercury, a salt composed of two equivalents of the *protoxide of mercury*, and one equivalent of *sulphuric acid*. It acts as a powerful emetic, but it is not now used internally. It is a very useful ermine in cases of headache, amanorosis, &c.

**TURPIS CAUSA**. [*L.*] An immoral consideration. [*A Scots law term.*]

**TURPITUDE**, *n.* [*Fr.* from *L. turpido*, from *turpis*, foul, base.] 1. Inherent baseness or vileness of principle in the human heart; extreme depravity. —2. Baseness or vileness of words or actions; shameful wickedness.

**TURQUOISE**. See **TURKOIS**.

**TURRÆA**, *n.* A genus of plants; *nat. order* Meliaceæ. Many of the species are highly ornamental trees or shrubs, inhabiting the interior of the Cape of Good Hope, Madagascar, the Mauritius, and the Eastern parts of India.

**TURREL**, *n.* A tool used by coopers.

**TURRET**, *n.* [*L. turris*.] 1. A little tower.—2. In *arch.*, a small tower, often crowning the angle of a wall, &c. Turrets are of two kinds, such as rise immediately from the ground, as *stair-case turrets*, and such as are formed on the upper part of a building by being carried up higher than the rest, as *bartizan turrets*.

And lift her *turrets* nearer to the sky. *Pope*. 3. In the *art of war*, movable turrets, used formerly by the Romans, were buildings of a square form, consisting of ten or even twenty stories, and sometimes one hundred and twenty cubits high, moved on wheels. They were employed in approaches to a fortified place, for carrying soldiers, engines, ladders, casting-bridges, and other necessities.

**TURRETED**, *a.* Formed like a tower; as, a *turreted lamp*.—2. Furnished with turrets.

**TURRICULATED**, *a.* Resembling a turret; having the form of a turret; as a *turriculated shell*.

**TURRILITES**, *n.* [*L. turris*, a tower, and *Gr. λίθος*, a stone.] A genus of testaceous Polythalamacea, occurring in a fossil state in the cretaceous formations. The shell is spiral, turreted, chambered; the turns are con-

tiguous, and all visible; the chambers are divided by sinuous septa, pierced by a siphuncle in their discs. The month is round. The turrilites are nearly related to the ammonites. There are several British species, found in the chalk and green-sand formations.

**TURRITEL'LA**, *n.* A genus of turriculated, elongated marine univalves, belonging to the family Turbinacea, both recent and fossil. The species are commonly known by the name of *screw-shells*.

**TURRITIS**, *n.* Tower-mustard, a genus of plants. [*See TOWER-MUSTARD.*]

**TUR'TLE**, *n.* [*Sax. id*; *Fr. tourterelle*; *L. turtur*; *Gaelic, turtuir*; *It. tortora, tortola, tortorella.*] 1. A gallinaceous fowl of the genus *Turtur*, the *T. communis*, (*Columba turtur*, Linn.) called also the *turtle dove*, and *turtle pigeon*. It is a wild species, frequenting the thickest parts of the woods, and its note is plaintive and tender. Turtle doves are found throughout the temperate parts of Europe and Asia, and also in many of the South Sea Islands. They are only summer visitors in Britain, arriving about the end of April, or the beginning of May, and leaving about the end of August. The turtle dove is celebrated for the constancy of its affection, and few birds have been more sung by poets, or more appealed to by lovers. —3. The sea-tortoise. The turtles or sea-tortoises constitute a family of Chelonians, (Thalassians or Thalassites). They are distinguished from all the other families by the comparatively depressed carapace, and the long and broad paddles, the anterior of which are very much prolonged when compared with the posterior ones. They are found in all the seas of warm climates. The most important species is the green turtle, (*Testudo mydas* Linn., *Chelonia mydas* of modern naturalists), so much prized as a luxury

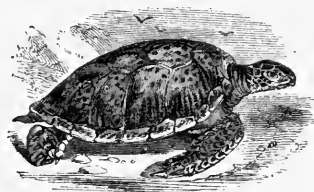

Green Turtle (*Chelonia mydas*).

at the tables of the rich. It is found from six to seven feet long, and weighing from 700 to 800 pounds. Its flesh is highly esteemed, and furnishes a

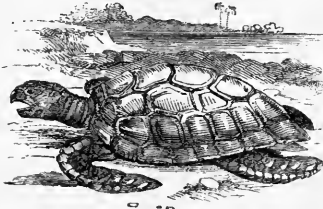

Logger-head Turtle (*Chelonia caretta*).

wholesome and palatable supply of food to the mariner in every latitude of the torrid zone. The logger-head turtle (*Chelonia caretta*), yields an oil,

which is used for lamps, and for dressing leather. The *hawk's bill turtle*, *Chelonia imbricata*, yields the finest kind of tortoise-shell. [*See TORTOISE.*]

**TUR'TLE-DOVE**, *n.* A species of the genus *Turtur*. [*See TURTLE.*]

**TUR'TLER**, *n.* One who catches turtles.

**TUR'TLE-SHELL**, *n.* [*turtle and shell.*] A shell, a beautiful species of *Murex*; also, tortoise-shell.

**TUR'TLE-SOUP**, *n.* A rich soup, the chief ingredient of which is turtle-meat. The meat used for *mock-turtle soup* is that of calf's head.

**TUS'CAN**, *a.* Pertaining to Tuscany in Italy.—*Tuscan order*, one of the five orders of architecture, according to Vitruvius and Palladio. It admits of no ornaments, and the columns are

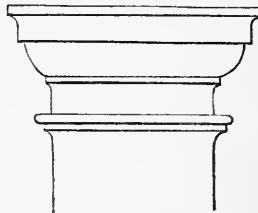

Tuscan Capital.

never fluted. It differs so little, however, from the Doric, that it is now regarded as being only a variety of the latter. [*See DORIC.*]

**TUS'CAN**, *n.* An inhabitant of Tuscany.

—2. In *ancient arch.*, the Tuscan order.

**TUSH**, an exclamation, indicating check, rebuke, or contempt, and equivalent to pshaw! be silent! *Tush, tush*, never tell me such a story as that.

**TUSH**, *n.* [*Sax. tuz.*] A tooth.

**TUSK**, *n.* [*Sax. tuz.*] The long pointed tooth of certain rapacious, carnivorous, or fighting animals; as, the *tusks* of the boar.—2. In *carpentry*, a bevel shoulder made above a tenon to give additional strength to it.—3. In *zool.*, a kind of fish. [*See TORSK.*]

**TUSK**, *† v. i.* To gnash the teeth, as a boar.

**TUSK'ED**, } *a.* Furnished with tusks;

**TUSKY**, } as, the *tusky boar*. *Tusk-ed* or *tusked*, in *her.*, is an epithet applied to boars, tigers, or elephants, when their tusks are borne of a different tincture from that of the body.

**TUS'SAC GRASS**, *n.* A grass found in



Tussock grass (*Dactylis cespitosa*).

the Falkland islands, and called *Dactylis cespitosa*, which grows in tufts

or tussncks. It thrives on peat lands within the influence of the sea spray, and is recommended for the peat and unproductive soil of the Hebrides of Scotland. It has succeeded well in the island of Lewis. The grass is excellent herbage, and is relished by cattle.

**TUSSILA'GO**, *n.* Colt's foot, a genus of broad-leaved plants; nat. order Compositeæ. The species are natives of Europe and America. *T. farfara*, common colt's foot, is anative of Britain. [See COLT'S FOOT.]

**TUS'SIS**, [*L.*] In *med.*, a cough.

**TUS'SLE**, *n.* A struggle; a conflict.

[*Vulgar.*] [See TOUSSE.]

**TUS'SUCK**, } *n.* Aclump, tuft, or minnte  
**TUS'SOCK**, } billock of growing grass.  
[*Scotch.*]

**TUT**, an exclamation, used for checking or rebuking. It is synonymous with *tush*.

**TUT**, *n.* An imperial ensign of a golden globe with a cross on it.—*Tut bargain*, among *miners*, a bargain by the lump. [*Qu. L. totus.*]

**TUTE'LA**, *n.* [*L.*] In *law*, guardianship; tutelage.

**TU'TELAGE**, *n.* [from *L. tutela*, protection, from *tueor*, to defend.] 1. Guardianship; protection; applied to the person *protecting*; as, the king's right of seignory and *tutelage*.—2. State of being under a guardian.

**TU'TELAR**, } *a.* [*L. tutelaris*, supra.]

**TU'TELARY**, } Having the guardianship or charge of protecting a person or a thing; guardian; protecting; as, *tutelary genii*; *tutelary* goddesses.

**TU'TENAG**, *n.* The Indian name of zinc. Sometimes the word is used to denote a metallic compound brought from China, called Chinese copper or white copper, consisting of copper, zinc, nickel and iron. It is employed by the Chinese in the manufacture of the gong. It resembles silver in appearance, is malleable, susceptible of a very fine polish, and does not readily tarnish. Specific gravity 8.43.

**TUTENAGUE**. See **TUTENAG**.

**TU'TOR**, *n.* [*L.* from *tueor*, to defend; *Fr. tuteur*.] 1. In the *civil law*, a guardian; one who is chosen to look to the persons and estates of children left by their fathers and mothers in their minority. In *Scots law*, a tutor is either a *tutor-nominate*, a *tutor-at-law*, or a *tutor-dative*. A *tutor-nominate* is one nominated in a testament, &c., by the father of the child or children to be placed under guardianship. A father may nominate any number of tutors. A *tutor-at-law* is one who acquires his right by the mere disposition of law, in cases where there is no tutor-nominate, or where the tutor-nominate is dead, or cannot act, or has not accepted. A *tutor-dative* is one named by the sovereign, on the failure both of tutors-nominate, and tutors-at-law.—2. One who has the care of instructing another in various branches or in any branch of human learning. Some gentlemen employ a *tutor* to teach in their families, others to attend a son in his travels.—3. In the *English universities*, a member of some college or hall, who has the charge of hearing the lessons of the students, and otherwise instructing them in the sciences and other branches of learning. In the *American colleges*, tutors are graduates selected by the trustees, for the instruction of undergraduates

of the three first years. They are usually officers of the institution, who have a share, with the president and professors, in the government of the students.

**TU'TOR**, *v. t.* To teach; to instruct.—2. To treat with authority or severity.—3. To correct.

**TU TORAGE**, *n.* In the *civil law*, guardianship; the charge of a pupil and his estate. In France, *tutorage* does not expire till the pupil is twenty-five years of age.—2. The authority or solemnity of a tutor. [*Little used.*]

**TU'TORED**, *pp.* Instructed; corrected; disciplined.

**TU'TORESS**, *n.* A female tutor; an instructor; a governess.

**TU'TORIAL**, *a.* Belonging to or exercised by a tutor or instructor.

**TU'TORING**, *pp.* Teaching; directing; correcting.

**TU'TORING**, *n.* The act of instructing; e location.

**TU'TORSHIP**, *n.* The office of a tutor.

**TU'TORY**, *n.* Tutorage; instruction.

**TU'TRAN**, *n.* A female guardian.

**TUT'SAX**, *n.* A plant, park-leaves, of the genus *Hypericum*, the *H. androsaemum*. [See **HYPERICUM**.]

**TUT'TI**, *n.* [*L. toti*.] In Italian music, a direction for all to play in full concert.

**TUT'TY**, *n.* [*It. tuzia*; Low *L. tutia*.]

1. An argillaceous ore of zinc, found in Persia, formed on cylindrical moulds into tubular pieces, like the bark of a tree. It is said to be made of a glutinous, argillaceous earth, like clay, which is put into pots, moistened and baked.—2. An impure oxide of zinc, collected from the chimneys of the smelting furnaces.

**TUYERE**, } [*Fr. tuyere*.] The nozzle  
**TUE'-IRON**, } of the blast pipe in a smelting furnace or smith's forge. It is also written *tweer*.

**TUZ**, } *n.* [*Qu. touse*.] A lock or tuft of hair.

**TWAD'DLE**, *v. i.* [*Sax. twæde*, double.] To prate much in a weak and silly manner, like one whose faculties are decayed.—2. † To beguilty of duplicity.

**TWAD'DLE**, *n.* Empty, silly talk; insignificant discourse.

**TWAD'DLER**, *n.* One who prates in a weak and silly manner.

**TWAD'DLING**, *n.* Silly, empty talk.

**TWAIN**, *a.* or *n.* [*Sax. twægen*; *Sw. twenne*; *Dan. twende*, for *toegeende*.] Whether *two* is contracted from *twøey*, is not apparent, but we see in the Danish *twende*, the first syllable of twenty; *twen-tig*, two tens.] *Two*. When old winter splits the rocks in *twain*.

*Dryden*. [*Nearly obsolete in common discourse, but used in poetry and burlesque.*]

**TWAI'ITE**, *n.* A fish, the *twaiite* shad, *Lasu finita*.—2. In old writers, wood grubbed up and converted into arable land. [*Local.*]

**TWANG**, *v. i.* [*D. duang*, *Dan. twang*, *G. zwang*, force, compulsion; *G. zwängen*, *zwingen*, *D. dwingen*, *Sw. tvinga*, *Dan. tvinger*, to constrain.] To sound with a quick sharp noise; to make the sound of a string which is stretched and suddenly pulled; as, the *twanging* bows.

**TWANG**, *v. t.* To make to sound, as by pulling a tense string and letting it go suddenly.

Sound the tough horn, and *twang* the quivering string. *Pope*.

**TWANG**, *n.* A sharp quick sound; as,

the *twang* of a bowstring; a *twang* of the nose.—2. An affected modulation of the voice; a kind of nasal sound.

He has a *twang* in his discourse. *Arbutnot*.

**TWANG'ING**, *pp.* Making a sharp sound.—2. *a.* Contemptibly noisy.

**TWAN'GLE**, *v. i.* To twang.

**TWAN'GLING**, } *a.* Twanging; noisy.

**TWANK**, a corruption of *Twang*.

**TWANKAY**, *n.* A sort of green tea.

**TWAS**, a contraction of *It was*.

**TWAT'TLE**, *v. i.* [*G. schwatzen*, with a different prefix. See **TWITTER**.] To prate; to talk much and idly; to gabble; to chatter; as, a *twat'tling* gossip.

**TWAT'TLE**, *v. t.* To pet; to make much of. [*Local.*]

**TWAT'TLER**, *n.* One who twattles.

**TWAT'TLING**, *pp.* or *a.* Prating; gabbling; chattering.

**TWAT'TLING**, *n.* The act of prating; idle talk.

**TWAY**, } for *Twain*, two.

**TWAY-BLADE**, } *n.* [*tway* and *blade*.]

**TWEY-BLADE**, } A plant, *Listera ovalata*, growing in Britain. [See **LISTERA**.]

**TWEAG**, } *v. t.* [*Sax. twiccian*, to twitch; *TWEAK*, } *G. zwicken*; *D. zwikken*.

It is radically the same word as *twitch*, and of the same signification.] To twitch; to pinch and pull with a sudden jerk; as, to *twøag* or *tweæk* the nose.

**TWEAG**, } † *n.* Distress; a pinching

**TWEAGUE**, } condition.

**TWEAK**. See **TWEAG**.

**TWEEDLE**, *v. t.* To handle lightly; used of awkward fiddling. [*Qu.*]

—2. To wheedle; to coax. *Tweedledum* and *tweedledee* are two ludicrous compounds of this word, used by Swift,

both signifying a musician in contempt. Strange all this difference should be,

\*Twixt *tweedledum* and *tweedledee*.

*Swift*.

**TWEEL**, *v. t.* To weave cloth in a particular manner; to twill,—*which see*.

**TWEER**, *n.* [*Fr. tuyere*.] In a *smelting furnace*, or *smith's forge*, the point of the blast-pipe. It is sometimes written *twier*, or *tuyere*.

**TWEE'ZER-CASE**, *n.* A case for carrying tweezers.

**TWEE'ZERS**, *n.* [This seems to be formed on the root of *wise*, an instrument for pinching.] Nippers; small pinchers used to pluck out hairs.

**TWELF'HINDI**, *n.* [*Sax.*] The name given to men of the highest rank under the Saxon government. They were assessed at 1200 shillings, and enjoyed many special privileges. Men of the lowest degree were called *Twihindi*, and were valued at 200 shillings.

**TWELFTH**, *a.* [*Sax. twelfta*; *D. twaalfde*; *G. zwölfte*.] The second after the tenth; the ordinal of twelve.

**TWELFTH-DAY**, } *n.* [*twelfth* and *TWELFTH-TIDE*, } *tide*.] The twelfth day after Christmas.—2. The festival of the Epiphany.

**TWELFTH-NIGHT**, *n.* The evening of the Epiphany, a festival of the church of Rome. In families, on this occasion, a *twelfth-cake* is baked, with a bean in it. Whoever gets the slice containing the bean, becomes *twelfth-night* king or queen, and has a mock authority over the rest of the party.

**TWELVE**, *a.* [*twelv*.] [*Sax. twelf*; *D. twaalf*; *G. zwölf*; *Qu. tuo left after ten*.] The sum of two and ten; twice six; a dozen. *Twelve* men compose a petty jury.

**TWELVE**, *n.* The number which consists of ten and two.

**TWELVE-MONTH**, *n.* (twelv'month.) [*twelve* and *month*.] A year which consists of twelve calendar months.

I shall laugh at this a *twelvemonth* hence.  
*Shak.*

**TWELVE-PENCE**, *n.* (twelv'pence.) [*twelve* and *pence*.] A shilling.

**TWELVE-PENNY**, *a.* [Sax. *twentigtha*, *twentogotha*. See **TWENTY**.] Sold for a shilling; worth a shilling; as, a *twelvepenny* gallery.

**TWELVE-SCORE**, *a.* (twelv'score.) [*twelve* and *score*.] Twelve times twenty; two hundred and forty.

**TWELVE-TABLES**. See under **TABLE**.

**TWEN'TIETH**, *a.* [Sax. *twentigtha*, *twentogotha*. See **TWENTY**.] The ordinal of twenty; as, the *twentieth* year.

**TWEN'TY**, *a.* [Sax. *twenti*, *twentig*; composed of *twend*, *twenne*, *twan*, *two*, and Goth. *tig*, ten, Gr. *δύο*, *L. decem*, W. deg. See **TWAIN**.] 1. Twice ten; as, *twenty* men; *twenty* years.—2. Proverbially, an indefinite number.

Maximilian, upon *twenty* respects, could not have been the man.  
*Bacon.*

**TWEN'TY-FOLD**, *a.* Twenty times as many.

**TWIB'IL**, *a.* [*two* and *bil*.] A kind of mattock, and a halbert.—2. A provincial term for a kind of reaping hook for cutting canary grass, used in the Isle of Thanet.

**TWIBILLED**, *a.* Armed with twibills or halberds.

**TWICE**, *adv.* [from *two*.] Two times.

He *twice* essay'd to cast his son in gold.  
*Dryden.*

2. Doubly; as, *twice* the sum. He is *twice* as fortunate as his neighbour.—

3. *Twice* is used in composition; as, in *twice-told*, *twice-born*, *twice-planted*, *twice-conquered*.

**TWICE-TOLD**, *a.* Related or told twice; as, a *twice-told* tale.

**TWID'DLE**, *v. t.* To twirl, in a small way; as, to *twiddle* one's thumbs, when the rest of the hands are interlocked. [*Collog.*]

**TWID'DLE**, *v. i.* To be busy about trifles; to quiddle. [*Local.*]

**TWID'LE**, for **Tweedle**. [See **TWEEDLE**.]

**TWIFALLOW**, *v. t.* [*twi*, *two*, and *fallow*.] To plough a second time land that is fallowed.

**TWIFALLOWED**, *pp.* Ploughed twice, as summer fallow.

**TWIFALLOWING**, *ppr.* Ploughing a second time.

**TWIFALLOWING**, *n.* The operation of ploughing a second time, as fallow land, in preparing it for seed.

**TWIFÖLD**, *† a.* Twofold.

**TWIG**, *n.* [Sax. *twig*; D. *twyg*; G. *zweig*. Qu. *L. vigeo*, with a prefix.] A small shoot or branch of a tree or other plant of no definite length or size.

The Britons had boats made of willow *twigs*, covered on the outside with hides.

**TWIG**, *v. t.* To flog; to lash, as with a *twig* or *twigs*.  
*Ralegh.*

**TWIG'GEN**, *a.* Made of twigs; wicker.

**TWIG'GY**, *a.* Full of twigs; abounding with shoots.

**TWIG-RUSH**, *n.* Cladinn, a genus of plants; nat. order, Cyperaceæ. *C. mariscus* is a British perennial plant, growing in boggy and fenny places. The leaves are keeled, ending in a sharp point, with prickly serratures.

**TWILIGHT**, *n.* [Sax. *tweon-leokt*, doubtful light, from *tweon*, *twægan*, to doubt, from *twegen*, two.] 1. The faint light which is reflected upon the earth after sunset and before sunrise; crepuscular light. It is occasioned by the

reflection of the sun's light from the atmosphere, and begins or ends when the sun is at a certain depression below the horizon, which depression must depend upon the state of the atmosphere for the time being. The morning twilight is said to begin, and the evening twilight to end, on a medium, in our latitudes, when the sun is 18° below the horizon; but it is impossible to fix the limit with any precision. In latitudes remote from the equator, the *twilight* is of much longer duration than at and near the equator.—2. Dubious or uncertain view; as, the *twilight* of probability.

**TWILIGHT**, *a.* Obscure; imperfectly illuminated; shaded.

O'er the *twilight* groves and dusky caves.  
*Pope.*

2. Seen or done by twilight.

**TWILL**, *v. t.* To weave in such a manner as to produce a kind of diagonal ribbed appearance upon the surface of the cloth.

**TWILL**, *n.* A variety of textile fabric very extensively employed. In the *twill* the weft-threads do not pass over and under the warp-threads in regular succession, as in common plain weaving, but pass over one and under two, over one and under three, or over one and under eight or ten, according to the kind of *twill*. The effect of this is to produce the appearance of parallel diagonal lines or ribs over the whole surface of the cloth; but the regularity of the parallel lines is broken in various ways in what is termed fanciful *twelling*.

**TWILL'ED**, *pp. or a.* Woven in such a manner as to present the appearance of diagonal ribs on the surface; as, *twill'ed* cloth.

**TWILT**, *n.* A quilt. [*Local.*]

**TWIN**, *n.* [Sax. *twinan*, to twine; from *two*.] 1. One of two young produced at a birth by an animal that ordinarily brings but one; used mostly in the plural, *twins*; applied to the young of beasts, as well as to human beings.—

2. The *twins*, pl.; a sign of the zodiac; Gemini.—3. One very much resembling another.

**TWIN**, *a.* Noting one of two born at a birth; as, a *twin* brother or sister.—

2. Very much resembling.—3. In *bot.*, swelling out into two protuberances, as an anther or germ.

**TWIN**, *v. i.* To be born at the same birth.—2. To bring two at once.—

3. To be paired; to be suited. [*This verb is little used.*]

**TWIN**, *† v. t.* To separate into two parts.

**TWIN'-BORN**, *a.* [*twin* and *born*.] Born at the same birth.

**TWIN'-BROTHER**, *n.* One of two brothers who are twins.

**TWINE**, *v. t.* [Sax. *twinan*; D. *twymen*; Sw. *twina*; Dan. *twinder*; from *two*.] 1. To twist; to wind, as one thread or cord around another, or as any flexible substance around another body; as, fine *twined* linen; Exod. xxxix.—2. To unite closely; to cling to; to embrace.—3. To gird; to wrap closely about.

Let wreaths of triumph now my temples *twine*.  
*Pope.*

**TWINE**, *v. i.* To unite closely or by interposition of parts.

Friends now fast sworn, who *twine* in love.  
*Shak.*

2. To wind; to bend; to make turns.

As rivers, though they bend and *twine*.  
*Swift.*

3. To turn round; as, her spindles *twine*.

**TWINE**, *n.* A strong thread composed of two or three smaller threads of strands twisted together; used for binding small parcels, and for sewing sails to their port-ropes, &c. *Twine* of a stronger kind is used for nets.—2. A twist; a convolution; as, Typhon's snaky *twine*.—3. Embrace; act of winding round.

**TWINED**, *pp.* Twisted; wound round.

**TWINGE**, *v. t.* (twinj.) [Sw. *twinga*, D. *dwingen*, Dan. *twinger*, G. *zwingen*, to constrain; but the sense is primarily to *twitch*. See **TWANG**, **TWEAK**, **TWITCH**.]

1. To affect with a sharp sudden pain; to torment with pinching or sharp pains.

The gnat *twinged* the lion till he made him tear himself, and so he mastered him.  
*L'Estrange.*

2. To pinch; to tweak; to pull with a jerk; as, to *twinge* one by the ears and nose.

**TWINGE**, *v. i.* (twinj.) To have a sudden, sharp local pain, like a twitch; to suffer a keen darting or shooting pain; as, the side *twinges*.

**TWINGE**, *n.* (twinj.) A sudden sharp pain; a darting local pain of momentary continuance; as, a *twinge* in the arm or side.—2. A sharp rebuke of conscience.—3. A pinch; a tweak; as, a *twinge* of the ear.

**TWING'ING**, *ppr.* Suffering a sharp local pain of short continuance; pinching with a sudden pull.

**TWING'ING**, *n.* The act of pinching with a sudden twitch; a sudden, sharp, local pain.

**TWINGING**, *ppr.* Twisting; winding round; uniting closely to; embracing.—2. In *bot.*, a *twining stem* is one which ascends spirally around another stem; a branch or prop; either to the right, as in the honeysuckle, or to the left, as in the kidney bean.

**TWINK**. See **TWINKLE**.

**TWINK'LE**, *v. i.* [Sax. *twincelian*; most probably formed from *wink*, with the prefix *eth*, *ed*, or *oth*, like *twit*.]—1. To sparkle; to flash at intervals; to shine with a tremulous intermitted light, or with a broken quivering light. The fixed stars *twinkle*; the planets do not.

These stars do not *twinkle*, when viewed through telescopes that have large apertures.  
*Newton.*

2. To open and shut the eye by turns; as, the *twinkling* owl.—3. To play irregularly; as, her eyes will *twinkle*.

**TWINK'LE**, *n.* A sparkling; a TWINK'LING, } shining with intermitted tremulous light; as, the *twinkling* of the fixed stars. This twinkling arises from the unequal refraction of light, in consequence of inequalities and undulations in the atmosphere.—

2. A motion of the eye.—3. A moment; an instant; the time of a wink.

In a moment, in the *twinkling* of an eye, at the last trump—the dead shall be raised incorruptible; 1 Cor. xv.

**TWINK'LING**, *ppr.* Sparkling.

**TWINK'-LIKENESS**, *n.* Near resemblance; a resemblance as close as that which is observed between twins.

**TWIN'LING**, *n.* [from *twi*.] A twin lamb.

**TWINE'D**, *a.* [from *twi*.] Produced one birth, like twins; united.

**TWIN'NER**, *n.* [from *twi*.] A breeder of twins.

**TWIN'TER**, *n.* [*two* and *winter*.] A beast two winters old. [*Local.*]

**TWIRE**, *† v. i.* To take short flights; to flit; to quiver; to twitter.



**TWIRE**, † *n.* A twisted thread or filament.

**TWIRL**, *v. t.* (twurl) [D. *dwarlen*; G. *querlen*; formed on *whirl*. The German coincides with our vulgar *quirl*.] To move or turn round with rapidity; to whirl round.

See ruddy maids,  
Some taught with dextrous hand to *twirl*  
the wheel. *Dodsey.*

**TWIRL**, *v. i.* To revolve with velocity; to be whirled round.

**TWIRL**, *n.* A rapid circular motion; quick rotation.—2. Twist; convolution.

**TWIRL'ED**, *pp.* Whirled round.

**TWIRL'ING**, *ppr.* Turning with velocity; whirling.

**TWIST**, *v. t.* [Sax. *gehwistan*; D. *twisten*, to dispute, Sw. *twista*; Dan. *twister*, to dispute, to litigate; G. *zwist*, a dispute. In all the dialects except ours, this word is used figuratively, but it is remarkably expressive and well applied.] 1. To unite by winding one thread, strand, or other flexible substance round another; to form by convolution, or winding separate things round each other; as, to *twist* yarn or thread. So we say, to double and *twist*.—2. To form into a thread from many fine filaments; as, to *twist* wool or cotton.—3. To contort; to writhe; as, to *twist* a thing into a serpentine form.—4. To wreath; to wind; to encircle.

Pillars of smoke *twisted* about with wreaths of flame. *Burnet.*

5. To form; to weave; as, to *twist* a story.—6. To unite by intertexture of parts; as, to *twist* bays with ivy.—7. To unite; to enter by winding; to insinuate; as, avarice *twists* itself into all human concerns.—8. To pervert; as, to *twist* a passage in an author.—9. To turn from a straight line.

**TWIST**, *v. i.* To be contorted or united by winding round each other. Some strands will *twist* more easily than others.

**TWIST**, *n.* A cord, thread, or any thing flexible, formed by winding strands or separate things round each other.—2. A cord; a string; a single cord.—3. A contortion; a writhe.—4. A little roll of tobacco.—5. Manner of twisting.—6. † A twig.

**TWIST'ED**, *pp.* Formed by winding threads or strands round each other.—*Twisted estivation*, in *bot.*, is that species of estivation in which the petals or the divisions of the corolla are spirally twisted, as in *Oxalis*.

**TWIST'ER**, *n.* One that twists; a rope maker.—2. The instrument of twisting.

**TWIST'ING**, *ppr.* Winding different strands or threads round each other; forming into a thread by twisting.

**TWIST'ING-CROOK**, *n.* An agricultural implement used for twisting straw ropes.

**TWIT**, *v. t.* [Sax. *othwitan*, *edwitan*, *edwitan*, to reproach, to upbraid; a compound of *ad*, *eth*, or *oth*, and *witan*. The latter verb signifies to know, Eng. to *wit*, and also to impute, to ascribe, to prescribe, or appoint, also to reproach; and with *ge*, a different prefix, *gewitan*, to depart. The original verb then signifies to set, send, or throw. We have in this word decisive evidence that the first letter *t* is a prefix, the remains of *eth* or *oth*, a word that probably coincides with the L. *ad*, to; and hence we may fairly infer that other words in which *t* precedes *w*, are also compound. That some of them

are so, appears evident from other circumstances.] To reproach; to upbraid; as, for some previous act. He *twitted* his friend of falsehood.

With this these scoffers *twitted* the Christians. *Tillotson.*

*Esop* minds men of their errors, without *twitting* them for what is amiss. *L' Etrange.*

**TWITCH**, *v. t.* [Sax. *twiccian*. See **TWANG**.] To pull with a sudden jerk; to pluck with a short, quick motion; to snatch; as, to *twitch* one by the sleeve; to *twitch* a thing out of another's hand; to *twitch* off clusters of grapes.

**TWITCH**, *n.* A pull with a jerk; a short, sudden, quick pull; as, a *twitch* by the sleeve.—2. A short spastic contraction of the fibres or muscles; as, a *twitch* in the side; convulsive *twitches*.

**TWITCH'ED**, *pp.* Pulled with a jerk.

**TWITCH'ER**, *n.* One that twitches.

**TWITCH'-GRASS**, *n.* Couch-grass; a species of grass which it is difficult to exterminate. This term is applied to various species of grass that are difficult to pull out of the ground. But *qu.* is not this word a corruption of *quitch grass*, or *quich-grass*?

**TWITCH'ING**, *ppr.* or *a.* Pulling with a jerk; suffering short spastic contractions.

**TWITCH'ING**, *n.* The act of pulling with a jerk; the act of suffering short spasmodic contractions.

**TWIT'ED**, *pp.* Upbraided.

**TWIT'TER**, *v. i.* [D. *kwetteren*; Dan. *quidrer*; Sw. *quitra*.] 1. To make a succession of small, tremulous, intermitted noises; as, the swallow *twitters*.—2. To have a tremulous motion of the nerves.—3. To make the sound of a half suppressed laugh; to titter.

**TWIT'TER**, *n.* [from *twit*.] One who twits or reproaches.

**TWIT'TER**, *n.* A small intermitted noise; a titter, as in half suppressed laughter; or the sound of a swallow.

—2. A slight trembling of the nerves.

**TWIT'TERING**, *ppr.* Uttering a succession of small interrupted sounds, as in a half suppressed laugh, or as a swallow; having a tremulous motion of the nerves.

**TWIT'TING**, *ppr.* Upbraiding; reproaching.

**TWIT'TINGLY**, *adv.* With upbraiding.

**TWIT'TLE-TWAT'TLE**, *n.* Tattle; gabble. [*Vulgar.*]

**TWIXT**, a contraction of *Betwixt*, used in poetry.

**TWÓ**, *a.* [Sax. *twa*; Goth. *twa twai*,

*twos*; D.  *twee*; G. *zwei*; Sw. *twa*; Ir. and Gaelic, *da* or *do*; Russ. *twa*, *twoe*; Slav. *dwa*; Sans. *dui*, *dwaja*; Gipsy, *duj*; Hindoo, Ch. and Pers. *du*; L. *duo*; Gr. *due*; It. *due*; Sp. *dos*; Port. *dous*; [Fr. *deux*.] 1. One and one. *Two* similar horses used together are called a span, or a pair.—2. *Two* is used in composition; as, in *two-legged*. Man is a *two-legged* animal. In *two*, into two parts; as, cut in *two*.

**TWÓ**, *n.* The number which consists of one and one.

**TWÓ-CAP'SULED**, *a.* Bicapsular; having two distinct capsules.

**TWÓ-CELL'ED**, *a.* Bilocular; having two cells.

**TWÓ-CLEFT**, *a.* Bifid; divided half way from the border to the base into two segments.

**TWÓ-EDGED**, *a.* Having two edges, or edges on both sides; as, a *two-edged*

sword. In *bot.*, a *two-edged* stem is one that is round, with two opposite edges.

**TWÓ-FACED**, *a.* Having two visages, like the Roman deity *Janus*.—2. Insincere; given to equivocation or double dealing.

**TWÓ-FLOWERED**, *a.* Bearing two flowers at the end, as a peduncle.

**TWÓ-FÓLD**, *a.* [*two* and *fold*.] Two of the same kind, or two different things existing together; as, *twofold* nature; a *twofold* sense; a *twofold* argument.—2. Double; as, *twofold* strength or desire.—3. In *bot.*, two and two together, growing from the same place; as, *twofold* leaves.

**TWÓ-FÓLD**, *adv.* Doubly; in a double degree; Matth. xxiii.

**TWÓ-FORKED**, *a.* Dichotomous; divided into two parts somewhat after the manner of a fork.

**TWÓ-HANDED**, *a.* Having two hands; an epithet used as equivalent to large, stout, and strong.—2. Large; bulky; requiring the two hands to grasp; as, a *two-handed* sword.

**TWÓ-HAN'DLED**, *a.* Having two handles; as, having two projections to hold by.—2. Of equivocal meaning.

**TWÓ-HEAD'ED**, *a.* Bicapitate.

**TWÓ-LEAVED**, *a.* Diphyllous; having two distinct leaves.

**TWÓ-LEGGED**, *a.* Biped; as, man is a *two-legged* animal. [*Commonly used in contempt.*]

**TWÓ-LÓBED**, Bilobate; having two distinct lobes.

**TWÓ-MÁSTED**, *a.* Having two masts.

**TWÓ-PÁRTED**, *a.* Bipartite; divided from the border to the base into two distinct parts.

**TWÓ-PENCE**, *n.* Formerly a small coin, but at present two copper coins, equal to the third part of a sixpence, or the value of these. [The word is colloquially pronounced *tup'pens*.]

**TWÓ-PENNY**, *a.* Of the value of worth; mean; vulgar; of little worth. [Colloq. in all but the first signification, and usually pronounced *tup'penny*.]

**TWÓ-PETALED**, *a.* Dipetalous; having two perfectly distinct petals.

**TWÓ-PLY**, *a.* [*two* and Fr. *pli*.] Double; having two strands, as cord; or two thicknesses, as cloth. [*Scotch, or local.*]

**TWÓ-RANKED**, *a.* In *bot.*, a *two-ranked* stem is one having the branches spreading in two opposite directions; as, in the silver fir.

**TWÓ-SEEDED**, *a.* In *bot.*, dispermous; containing two seeds, as a fruit; having two seeds.

**TWÓ-TIPPED**, *a.* Bilabiate; divided in such a manner as to resemble the two lips when the mouth is more or less open.

**TWÓ-TÓNGUED**, *a.* Double-tongued; deceitful.

**TWÓ-VALVED**, *a.* Bivalvular, as a shell, pod, or glume.

**TWY FÓIL**, *a.* Having only two leaves. A heraldic term, also written *dufoil*.

**TYBURN-TREE**, *n.* [From Tyburn, near London, where executions long took place.] The gallows; a gibbet.—*Tyburn ticket*, in *Eng. law*, a certificate that expenses are due, given to the prosecutor of a felon to conviction.

**TYCHO'NIC**, *a.* Pertaining to Tycho Brahe, or to his system of astronomy.

**TYE**, *v. t.* [see **TIE**, the more usual orthography, and **TING**.] To bind or fasten.

**TYE**, *n.* A knot. [See **TIE**.]—2. A bond; an obligation.

By the soft *tye* and sacred name of friend. *Pope.*

3. In *ships*, a runner or short thick rope.

TYER, *n.* One who ties or unites.

TYGER, *n.* A tiger—*which see*.—2. In *her.*, a fictitious beast, with a hooked kind of talon at the nose, and with a mane formed of tufts.



Tyger.

TY'ING, *ppr.* [See TIE and TYE.] Binding; fastening. [As this participle must be written with *y*,

it might be well to write the verb *tye*.]

TYKE, *n.* A dog; or one as contemptible as a dog.

TYLO'PHORA, *n.* A genus of plants; nat. order Asclepiadaceæ. The species are twining herbs or undershrubs, inhabiting India, the Malayan Peninsula, Java, and New South Wales. The roots of *T. asthmatica* are used on the coast of Coromandel for the same purpose as ipecacuanha.

TYMBAL, *n.* [Fr. *tymbale*; It. *taballo*; Sp. *tímbal*. *M* is probably not radical. It is from beating, Gr. *τυττω*.] A kind of kettle drum.

▲ *tymbal's* sound were better than my voice.

*Prior.*

TYMPAN, } *n.* [L. *tympānum*. See TYMPANUM, } TYMBAL.} 1. A drum; hence, the barrel or hollow part of the ear behind the membrane of the tympanum. [See MEMBRANA TYMPANI.]

—2. In *arch.*, the space in a pediment, included between the cornice of the inclined sides and the fillet of the corona. The term is also used to signify the die of a pedestal, and the panel of a door. The *tympan of an arch* is the spandrell. It is usually hollowed, and enriched with ornaments, as foliage, &c.

—3. In *mech.*, a kind of wheel placed round an axis or cylindrical beam, on the top of which are two levers for turning the axis, and therewith the weight required. Also, a kind of hollow tread-wheel wherein two or more persons or animals walk to turn it, and thus give motion to a machine.—4. Among *printers*, a frame attached to the carriage of the press by joints, and covered with parchment or cloth, on which the blank sheets are put, in order to be laid on the form to be impressed. There is another frame

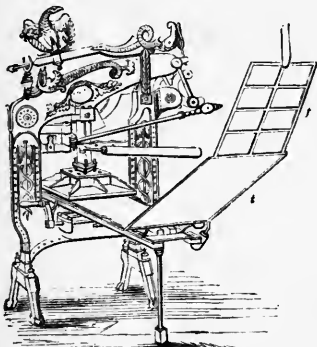

4, Tympan. f. Friquet.

which fits into this, called the *inner tympan*, also covered with parchment. Between these are placed pieces of cloth, called *blankets*, which form a soft medium between the types and

the platen, and tend to produce an equal impression.—*Tympan sheet*, a sheet of paper laid on the tympan, and serving as the guide on which the sheets to be printed are laid, by which means the margin is kept regular and uniform.—5. In *bot.*, a membranous substance stretched across the theca of a moss.

TYMPANIC, *a.* Relating to the tympanum; drum-like.

TYMPANITES, } *n.* [L. *tympānum*, a TYMPANY, } drum.] In *med.*, drum-belly; an elastic distension of the abdomen, which sounds like a drum when struck, with costiveness and atrophy, but no fluctuation. It arises from a morbid collection of gas in the intestines, caused by indigestion, colic, &c. It sometimes arises from a collection of gas in the cavity of the abdomen, in which case it is usually fatal.

TYMPANITIC, *a.* Relating to tympany or tympanites; affected with tympany or tympanites.

TYMPANIZE, *v. i.* To act the part of a drummer.

TYMPANIZE, *v. t.* To stretch, as a skin over the head of a drum.

TYMPANIZED, *pp.* Stretched, as a skin over the head of a drum.

TYMPANIZING, *ppr.* Stretching, as a skin over the head of a drum.

TYMPANUM, *n.* The drum of the ear. [See TYMPAN.]—2. In *mech.*, a wheel placed round an axis.

TYMPANY, *n.* A flatulent distention of the belly. [See TYMPANITES.]

TYNES, *n.* [Suo-Goth. *tinne*, any thing sharp like a tooth.] In *her.*, the name given to the branches of the horns of stags, bucks, rein-deer, and beasts of venery, when such horns are borne differing in tincture from that of the body. The term is also used in expressing the number of such projecting branches; as, a stag's head attired with ten *tynes*.—2. In *agriculture*, the teeth of cultivators, grubbers, &c.

TYNY, *a.* Small. [See TINY.]

TYPE, *n.* [Fr. *type*; L. *typus*; Gr. *τυπος*, from the root of *τυπ*, Gr. *τυττω*, to beat, strike, impress.] Literally, a die; figure; outline; model. Hence,—1. The mark of something; an emblem; that which represents something else.

Thy emblem, gracious queen, the British rose,

*Type of sweet rule and gentle majesty.*

*Prior.*

2. A sign; a symbol; a figure of something to come; as, Abraham's sacrifice and the paschal lamb were *types* of Christ. To this word is opposed *antitype*. Christ, in this case, is the *antitype*.—3. A model or form of a letter in metal, or other hard material; used in printing. Also, in a collective sense, printing letters. Types are designated according to their size; as, *great primer*, the largest used for printing books,

*English, pica, small pica, long primer, bourgeois, brier, minion, nonpareil, ruby, pearl, diamond*, which last is the smallest type ordinarily used in this country. The varieties of type used for titles of books, cards, placards of all sizes, &c. &c., are endless; that kind called *script*, as its name indicates, is cut so as to imitate writing.—4. In *med.*, some peculiarity in the form of a disease.—5. In *nat. hist.*, a general form, that form which gives the character of similarity to a group of individuals. Thus, a particular individual may be the type of a species, a species

of a genus, a genus of a family, &c.—6. In the *fine arts*, the primitive model or pattern of an object or work of art, and which has its existence in nature. Thus, in *arch.*, trees are said to be the *types* of columns.—7. In *anat.*, the primary model, according to which the parts of an animal body are formed.—8. In some *systems of philosophy*, types are the primary forms which are conceived to exist in the mind of the Creator, and which determine the character of all individual existence.—9. In *numismatics*, the impression on a coin or medal of any image or figure whatever.—10. † A stamp or mark.

TYPE, *v. t.* To prefigure; to represent by a model or symbol beforehand. [Little used.]

TYPE-FOUNDING, *n.* The art or practice of manufacturing metallic movable types, used by printers. The type or pattern of each letter is first cut with great care and precision, on a steel punch. By striking this punch into a piece of copper, a matrix for the face of the type is formed. The matrix is then placed in a mould, of which it forms the bottom, and into this mould is poured the type-metal in the requisite state of fluidity. The mould forms the body of the type, and consists of two halves, so that every letter which is cast may be easily loosened, and removed from it. A single type consists of three parts; the *shank*, or body of the letter, the *beard*, or that part between the shoulder of the shank and the face, and the *face* or shape of the letter from which the impression is to be taken. The place where types are made is called a *type-foundery*.

TYPE-METAL, *n.* An alloy of lead, antimony, and tin, used in making types. The usual proportion is one part of antimony to three of lead; but the proportions vary for different sorts of types.

TYPHA, *n.* A genus of plants, the species of which are known by the name of cat's tail, or reed mace. [See REED-MACE.]

TYPHA'CEÆ, *n.* A nat. order of monocotyledonous plants, characterized by their calyx being three-sepaled, and half-glabrous, or a mere bundle of long hairs, long lax filaments, clavate anthers, solitary pendulous ovules, and peculiar habit. The order includes two genera, *Typha* and *Sparganium*, the species of which are abundant in the northern parts of the world. They are herbaceous plants, growing in marshes and ditches.

TYPHE'AN, } *a.* Pertaining to Ty- TYPHE'AN, } phæus, the fabled giant with a hundred heads.

TYPHIS, *n.* A genus of testaceous molluscs, of which the type is the *murex tubifer*.

TYPHLOPS, *n.* [from Gr. *τυφος*, blind.] A genus of reptiles, placed by Cuvier among the ophiidians or serpents, and so named because the eye resembles a point hardly visible through the skin. They are small serpents, with small imbricated scales, a projecting muzzle furnished with plates, and a long forked tongue. They resemble, at first sight, earth-worms, and are found in the hot portions of both continents.

TYPHOID, *a.* [*typhus*, and Gr. *ιδος*, form.] Resembling typhus; weak; low; as, a *typhoid fever*.

TYPHOMANIA, *n.* [Gr. *τυφος*, stupor, and *μανια*, madness.] The low mutter-

ing delirium which accompanies typhoid fevers.

**TY'PHON**, *n.* The evil genius of Egyptian mythology, represented with a human form, having the head of a quadruped.

**TY'PHON**, } *n.* [Gr. τυφων.] A furious  
**TY'PHOON**, } whirling wind; a hurri-  
cane in the eastern or Chinese seas; a whirlwind moving forward with irresistible impetuosity.

**TY'PHOUS**, *a.* Relating to typhus.

**TY'PHUS**, *n.* [Gr. τυφος, to render stupid, to burn with a smothered fire, and with more smoke than flame; hence τυφος, stupor or coma.] A genus of simple continuous fevers, essentially attended with a greater or less degree of atony or exhaustion, throughout their whole course, and from beginning to end. A preternaturally weak pulse always attends all these fevers. They are liable to be attended with coma in some of their stages. Typhus is contagious or infectious, and often epidemic, but is most prone to attack debilitated persons, and is aided in its progress by want of cleanliness, good food, and fresh air. There are two kinds of typhus, the *malignant* and the *mild*. The latter is the low nervous or typhoid fever of this country, which has a slow and insidious origin, and lasts from fourteen to twenty-eight days.

**TY'PIC**, } *a.* Emblematic; figura-  
**TY'PICAL**, } tive; representing some-  
thing future by a form, model, or resemblance. Abraham's offering of his only son Isaac was *typical* of the sacrifice of Christ. The brazen serpent was *typical* of the cross.—*Typic fever* is one that is regular in its attacks; opposed to *erratic fever*.

**TY'PICALLY**, *adv.* In a typical manner; by way of image, symbol, or resemblance.

**TY'PICALNESS**, *n.* The state of being typical.

**TY'PIFICATION**, *n.* Act of typifying.

**TY'PIFIED**, *pp.* Represented by symbol or emblem.

**TY'PIFIER**, *n.* One who typifies.

**TY'PIFY**, *v. t.* To represent by an image, form, model, or resemblance. The washing of baptism *typifies* the cleansing of the soul from sin by the blood of Christ. Our Saviour was *typified* by the goat that was slain.

**TY'PIFYING**, *ppr.* Representing by model or emblem.

**TY'POGOSMY**, *n.* [Gr. τυπος and γωσμος.] A representation of the world. [*Not much used.*]

**TY'POGRAPHER**, *n.* [See **TYPOGRAPHY**.] A printer.

**TYPOGRAPHIC**, } *a.* Pertaining  
**TYPOGRAPHICAL**, } to printing;  
as, the *typographic art*; *typographical errors*.—2. Emblematic.

**TYPOGRAPHI'CALLY**, *adv.* By means of types; after the manner of printers.—2. Emblematically; figuratively.

**TYPOGRAPHY**, *n.* [Gr. τυπος, type, and γραφω, to write.] 1. The art of printing, or the operation of impressing letters and words on forms of types.—2. Emblematical or hieroglyphic representation.

**TY'POLITE**, *n.* [Gr. τυπος, form, and λιθος, stone.] In *nat. hist.*, an old name for a stone or fossil which has on it impressions or figures of plants and animals.

**TYPOL'OGY**, *n.* [Gr. τυπος, form, and λογος,] The doctrine of types; a discourse on types.

**TY'RAN**, *† n.* A tyrant.

**TY'RANNESS**, *n.* [from *tyrant*.] A female tyrant.

**TYRAN'NIC**, } *a.* [Fr. *tyrannique*;  
**TYRAN'NICAL**, } Gr. τυραννικος.] Per-  
taining to a tyrant; suiting a tyrant; arbitrary; unjustly severe in government; imperious; despotic; cruel; as, a *tyrannical* prince; a *tyrannical* master; *tyrannical* government or power. Our sects a more *tyrannic* power assume.

*Roscommon.*

Th' oppressor rul'd *tyrannic* where he durst.

*Pope.*

**TYRAN'NICALLY**, *adv.* With unjust exercise of power; arbitrarily; oppressively.

**TYRAN'NICALNESS**, *n.* Tyrannical disposition or practice.

**TYRAN'NICIDAL**, *a.* Relating to tyrannicide.

**TYRAN'NICIDE**, *n.* [L. *tyrannus*, tyrant, and *caedo*, to kill.] 1. The act of killing a tyrant.—2. One who kills a tyrant.

**TYRANN'NÆ**, *n.* Swainson's name for a sub-family of shrikes, otherwise called tyrant shrikes. They are found in America only. [See **SHRIKE**.]

**TY'RANNING**, *† ppr. or a.* Acting as a tyrant.

**TY'RANNIZE**, *v. i.* [Fr. *tyranniser*.] To act the tyrant; to exercise arbitrary power; to rule with unjust and oppressive severity; to exercise power over others not permitted by law or required by justice, or with a severity not necessary to the ends of justice and government. A prince will often *tyrannize* over his subjects; republican legislatures sometimes *tyrannize* over their fellow citizens; masters sometimes *tyrannize* over their servants or apprentices. A husband may not *tyrannize* over his wife and children.

**TY'RANNIZED**, *pp.* Ruled with oppressive severity.

**TY'RANNIZING**, *ppr.* Exercising arbitrary power; ruling with unjust severity.

**TYR'ANNOUS**, *a.* Tyrannical; arbitrary; unjustly severe; despotic.

**TYR'ANNOUSLY**, *adv.* Tyrannically; with despotic power or authority.

**TYR'ANNY**, *n.* [Fr. *tyrannie*; from *tyran*.] 1. Arbitrary or despotic exercise of power; the exercise of power over subjects and others with a rigour not authorized by law or justice, or not requisite for the purposes of government. Hence tyranny is often synonymous with *cruelty* and *oppression*.—2. Cruel government or discipline; as, the *tyranny* of a master.—3. Unresisted and cruel power.—4. Absolute monarchy cruelly administered.—5. Severity; rigour; inclemency.

The *tyranny* o' th' ope night. *Shak.*

**TY'RANT**, *n.* [L. *tyrannus*; Gr. τυραννος.] The Welsh has *teyrn*, a king or sovereign, which Owen says is compounded of *te*, [that spreads,] and *gyrn*, imperious, supreme, from *gyr*, a driving. The Gaelic has *tiarna* and *tighearna*, a lord, prince, or ruler, from *tigh*, a house; indicating that the word originally signified the master of a family merely, or the head of a clan. There is some uncertainty as to the real origin of the word. It originally signified merely a chief, prince, king, or monarch possessing absolute power, but the abuse of the office has altered the import of the word.] 1. A monarch or other ruler or master, who uses power to oppress his subjects; a person who exercises unlawful authority, or lawful authority in an unlawful manner; one who by taxation, injustice, or cruel punishment, or the demand of unreasonable services, imposes burdens and hardships on those under his control, which law and humanity do not authorize, or which the purposes of government do not require.—2. A despotic ruler; a cruel master; an oppressor.

Love, to a yielding heart is a *tyrant*. *Sidney.*

**TYRE**, *n.* A preparation of milk and rice, used by the East Indians.

**TYRE**. See **TIRE**.

**TYR'IAN**, *n.* A native of Tyre.

**TYR'IAN**, *a.* Pertaining to the ancient Tyre.—2. Being of a purple colour.

**TYRO**, *n.* A beginner in learning; a novice; one who is employed in learning the rudiments of any branch of study.—2. A person who has an imperfect knowledge of a subject.

**TY'ROLESE**, *a.* Belonging or relating to the Tyrol; as, a *Tyrolese* air.—2. *n.* A native of the Tyrol.

**TY'PHE**. See **TYPHE**.

**TY'THING**. See **TITHING**.

**TZAR**, *n.* The emperor of Russia. [See **CZAR**.]

**TZAR'INA**, *n.* The empress of Russia. [See **CZARINA**.]

U.

**U** IS the twenty-first letter and the fifth vowel in the English Alphabet. Its true primary sound in Anglo-Saxon, was the sound which it still retains in most of the languages of Europe; that of *oo* in *cool*, *tool*, answering to the French *ou*, in *tour*. This sound was changed, probably under the Norman kings, by the attempt made to introduce the Norman French language into

common use. However this fact may be, the first, or long and proper sound of *u*, in English, is now not perfectly simple, and it cannot be strictly called a *vowel*. The sound seems to be nearly that of *eu*, shortened and blended. This sound, however, is not precisely that of *eu* or *yu*, except in a few words, as in *unite*, *union*, *uniform*; the sound does not begin with the distinct sound

of *e*, nor end in the distinct sound of *oo*, unless when prolonged. It cannot be well expressed in letters. This sound is heard in *annuity*, *numerate*, *mute*, *dispute*, *duke*, *opportunity*, *infusion*. Some modern writers make a distinction between the sound of *u*, when it follows *r*, as in *rude*, *truth*, and its sound when it follows other letters, as in *mute*, *duke*; making the former

sound equivalent to *oo*; *rood, trooth*; and the latter a diphthong equivalent to *eu* or *yu*. The difference, very nice indeed, between the sound of *u* in *mute*, and in *rude*, is owing entirely to the articulation which precedes that letter. For example, when a labial, as *m* or *p*, precedes *u*, we enter on its sound with the lips closed, and in opening them to the position required for uttering *u*, there is almost necessarily a slight sound of *e* formed before we arrive at the proper sound of *u*. When *r* precedes *u*, the mouth is open before the sound of *u* is commenced. [See INTRODUCTION, p. lii.] In some words, as in *bull, full, pull*, the sound of *u* is that of the Italian *u*, the French *ou*, but shortened. This is a vowel. *U* has another short sound, as in *turn, run, sun, turn, rub*. This also is a vowel. *U* and *V* were long used indiscriminately, the one for the other, but since the beginning of the 16th century they have been separated, *U* being considered as a vowel, and *V* a consonant. In abbreviations, *U. S.* stand for *United States*; *ult.* for *ultimo*, in the last month being understood. As a Latin abbreviation, *U. C.* stand for *Urbe condita*, the city having been built, that is Rome: thus *U. C.* 400 signifies 400 years after the building of Rome.

**UBEROUS**, *a.* [L. *uber*.] Fruitful; copious. [Little used.]

**UBERTY**, *n.* [L. *ubertas*, from *uber*, fruitful or copious.] Abundance; fruitfulness. [Little used.]

**UBICATION**, *n.* [L. *ubi*, where.]  
**UBICITY**, *n.* } The state of being in a place; local relation. [Not much used.]

**UBIQUISTS**, *n.* } [L. *ubique*, everywhere, in  
**UBIQUITISTS**, } every place, in  
**UBIQUITARIANS**, } every place.]  
In *eccles. hist.*, names given to a sect of Lutherans who sprung up in Germany about the year 1560. Their distinguishing tenet was that the body of Christ is omnipresent, or in every place at the same time; and, hence, that he is corporeally present in the Eucharist.

**UBIQUITARINESS**, *n.* Existence every where. [Little used.]

**UBIQUITARY**, *a.* [L. *ubique*, from *ubi*, where.] Existing every where, or in all places.

**UBIQUITARY**, *n.* [supra.] One that exists every where.—2. One who maintains that the body of Christ is present every where. [See UBIQUISTS.]

**UBIQUITOUS**, *a.* Existing or being every where.

**UBIQUITY**, *n.* [L. *ubique*, every where.] Existence in all places or every where at the same time; omnipresence. The *ubiquity* of God is not disputed by those who admit his existence.

**UBI SUPRA**. [L.] In the place above mentioned; noting reference to some passage or page before named.

**UDAL**, *n.* A freehold in the Shetland isles.

**UDALLER**, *n.* A freeholder in the Shetland isles.

**UDDER**, *n.* [Sax. *uder*; G. *euter*; D. *uyer*; Gr. *υδρα*.] The breast of a female; but the word is applied chiefly or wholly to the glandular organ, or *bag* of cows, and other quadrupeds, in which the milk is secreted and retained for the nourishment of their young.

**UDDERED**, *a.* Furnished with udders.

**UDOMETER**, *n.* [Gr. *υδρα*, water, and *μετρον*, measure.] A rain-gauge,—which see.

**UGLY**, *adv.* In an ugly manner; with deformity.

**UGLINESS**, *n.* [from *ugly*.] Total want of beauty; deformity of person; as, old age and *ugliness*.—2. Turpitude of mind; moral depravity; loathsomeness.

Their dull ribaldry must be offensive to any one who does not, for the sake of the sin, pardon the *ugliness* of its circumstances.

**UGLY**, *a.* [W. *hag*, a cut or gash; *hagyr*, ugly, rough. See HACK.] Deformed; offensive to the sight; contrary to beauty; hateful; as, an *ugly* person; an *ugly* face.

O, I have pass'd a miserable night,  
So full of *ugly* sights, of ghastly dreams.

Fellow, begone; I cannot bear thy sight;  
This news hath made thee a most *ugly* man

**UKASE**, *n.* In Russia, a proclamation or imperial order published.

**U'LAHS**, *n.* Militia among the Tartars.

**UL'GER**, *n.* [Fr. *ulcere*; It. *ulcera*; L. *ulcus*; Gr. *υλκος*.] A sore; a solution of continuity in any of the soft parts of the body, either open to the surface or to some natural cavity, and attended with a secretion of pus or some kind of discharge. Ulcers are of various kinds, as *simple, fistulous, gangrenous, scorbutic, cancerous, inveterate, scrofulous*, &c. They are also divided into *local and constitutional*, and into *simple and specific*.

**UL'GERATE**, *v. i.* To be formed into an ulcer; to become ulcerous.

**UL'GERATE**, *v. t.* [Fr. *ulcerer*; L. *ulcero*.] To affect with an ulcer or with ulcers.

**UL'GERATED**, *pp.* Affected with ulcers; as, *ulcerated* sore throat.

**UL'GERATING**, *ppr.* Turning to an ulcer; generating ulcers.

**ULCERATION**, *n.* [Fr. from L. *ulceratio*.] 1. The process of forming into an ulcer; or the process of becoming ulcerous.—2. An ulcer; a morbid sore that discharges pus or other fluid.

**UL'GERED**, *a.* Having become an ulcer.

**UL'GEROUS**, *a.* Having the nature or character of an ulcer; discharging purulent or other matter.—2. Affected with an ulcer or with ulcers.

**UL'GEROUSLY**, *adv.* In an ulcerous manner.

**UL'GEROUSNESS**, *n.* The state of being ulcerous.

**UL'CUSLE**, *n.* [L. *ulcusculum*, *ULCUS'CULE*, } from *ulcus*.] A little ulcer.

**ULE TREE**, *n.* In *bot.* a Mexican tree, a species of Castilleo, *C. elastica*, from which caoutchouc is obtained, called by the Mexicans *ule*.

**U'LEX**, *n.* Furze, a genus of plants. [See FURZE.]

**ULIG'INOUS**, *a.* [L. *uliginosus*, from *uligo*, oozy.] Muddy; oozy; slimy.

**UL'TAGE**, *n.* In *com.*, the wantage of casks of liquor, or what a cask wants of being full.

**ULMA'CEÆ**, *n.* A nat. order of incomplete exogens, of which the genus *Ulmus*, or elm, is the type. It is nearly related to *Urticaceæ*, from which it differs only in having a two-celled fruit, and hermaphrodite flowers. It consists of trees or shrubs, which have scabrous, alternate, simple, deciduous leaves and stipules. The genera included in it are, *Planera*, *Abelicea*, *Ulmus*, *Celtis*, *Sponia*, *Mertensia*. The

species are natives of the north of Asia, the mountains of India, China, North America, and Europe, in the latter of which countries they form valuable timber trees.

**UL'MIC ACID**, *n.* [L. *ulmus*, an elm.]

**UL'MINE**, } A vegetable acid, exuding spontaneously from the elm, the chestnut, the oak, and various other trees. It is a dark brown, and nearly black, solid, insipid, inodorous, and very sparingly soluble in water and alcohol. It constitutes the essential ingredient of *peat*, &c. It appears to constitute what is usually called *vegetable manure*. It has also been called *humus*, *humine*, *geine*, *humic acid*, and *geic acid*. [See HUMUS.]

**UL'MUS**, *n.* The elm, a genus of plants, the type of the nat. order *Ulmaceæ*. All the species are trees, some of them attaining a great size and age; four are natives of Britain. The *U. campestris*, the common English or small-leaved elm, is extensively employed for forming avenues, and is planted as an ornamental tree in parks, and around mansions. Its wood is used for axle-trees, mill-wheels, chairs, coffins, &c., and also in ship-building. [See ELM.]

**UL'NA**, *n.* [L.] In *anat.*, the cubit; the larger of the two bones of the forearm, reaching from the elbow to the wrist. Its upper extremity forms the point of the elbow. Its chief use seems to be to support and regulate the motions of the *radius*, the other bone of the forearm.

**UL'NAGE**. See ALNAGE, AUNAGE.

**UL'NAR**, *a.* [L. *ulna*.] Pertaining to the ulna or cubit; as, the *ulnar* nerve.

**ULODENDRON**, *n.* [Gr. *υλος* and *δενδρον*.] A genus of trees now extinct, and found only in a fossil state in the coal formations.

**ULTE'RIOR**, *a.* [L. comparative.] Further; as, *ulterior* demands; *ulterior* propositions. What *ulterior* measures will be adopted is uncertain.—2. In *geography*, being or situated beyond or on the further side of any line or boundary; opposed to *citerior*, or hither.

**UL'TIMA RATIO**. [L.] The last reason or argument.

**UL'TIMA RATIO REGUM**. [L.] The last reason of kings is war, force of arms.

**UL'TIMATE**, *a.* [L. *ultimus*, furthest.] 1. Furthest; most remote; extreme. We have not yet arrived at the *ultimate* point of progression.—2. Final; being that to which all the rest is directed, as to the main object. The *ultimate* end of our actions should be the glory of God, or the display of his exalted excellence. The ultimate end and aim of men is to be happy, and to attain to this end, we must yield that obedience which will honour the law and character of God.—3. Last in a train of consequences; intended in the last resort.

Many actions apt to procure fame, are not conducive to this our *ultimate* happiness.

*Addition.*  
4. Last; terminating; being at the furthest point.—5. The last into which a substance can be resolved; constituent.—*Ultimate analysis*, in *chem.*, is the resolution of a substance into its absolute elements; opposed to *proximate analysis*, or the resolution of a substance into its secondary elements. Thus, when the analysis consists only in determining the simpler constituents of a compound, it is *proximate*, as when

carbonate of potash is separated into carbonic acid and potash; but when the operation is extended, and the carbonic acid is resolved into carbon and oxygen, and the potash into potassium and oxygen, the analysis is ultimate; for neither carbon, oxygen, nor potassium is resolvable into two or more kinds of matter; they are therefore to be considered as *ultimate* elements, or constituents. The terms *ultimate analysis*, and *ultimate elements*, are most generally used in reference to organic products. In inorganic analysis, the proximate elements are the substances generally sought, and the elementary composition of these being already known, the ultimate elements of which the substance analyzed is composed are also ascertained.—*Prime and ultimate ratios*. [See under RATIO.]

ULTIMATELY, *adv.* Finally; at last; in the end or last consequence. Afflictions often tend to correct immoral habits, and ultimately prove blessings.

ULTIMATUM, *n.* plur. *Ultimata*. [L.] In *diplomacy*, the final propositions, conditions, or terms offered as the basis of a treaty; the most favourable terms that a negotiator can offer, and the rejection of which usually puts an end to negotiation.—2. Any final proposition or condition.

ULTIMATE, *a.* Ultimate.

ULTIMITY, *n.* The last stage or consequence.

ULTIMO, *n.* [L. *ultimo mense*.] The month which preceded the present; last month; as distinguished from the current or present month, and all others. It is usually contracted to *ult.*; as, parliament met on the 12th *ult.*

ULTIMUS HÆRES, [L.] In *law*, the last heir. Thus, in cases of intestate succession, failing relations of every kind, the succession devolves on the crown as *ultimus hæres*.

ULTION, *n.* [L. *ultio*.] Revenge. [Little used.]

ULTRA, [L.] Beyond. In *politics*, a prefix used to denote those members of a party who carry the opinions of their party to excess; as, *ultra* Tories; *ultra* radicals; *ultra* liberals. In 1793, those persons were called *ultra* revolutionists who demanded much more than the constitution then adopted allowed. The word is sometimes used as a noun, to denote a person who advocates extreme measures in politics.

ULTRAISM, *n.* The principles of men who advocate extreme measures, as a radical reform, &c.

ULTRAIST, *n.* One who pushes a principle or measure to extremes.

ULTRAMARINE, *a.* [L. *ultra*, beyond, and *marinus*, marine.] Situated or being beyond the sea.

ULTRAMARINE, *n.* [supra.] A beautiful and durable sky-blue; a colour formed of the mineral called lapis lazuli. This substance is much valued by painters, on account of the beauty and permanence of its colour, both for oil and water painting. According to Gmelin of Tubingen, sulphuret of sodium is the colouring principle of lapis lazuli, to which the colour of ultramarine is owing. He has succeeded in preparing artificial ultramarine by heating sulphuret of sodium with a mixture of silicic acid and alumina. Artificial ultramarine thus prepared is sold in Paris at a moderate price. The finer specimens are quite equal to the native ultramarine, and much less ex-

pensive.—2. Aznre-stone.—*Ultramarine ashes*, an inferior sort of a pigment which is the residuum of lapis lazuli, after the ultramarine has been extracted. Their appearance is that of the ultramarine, a little tinged with red, and diluted with white.

ULTRAMONTANE, *a.* [Fr. from L. *ultra* and *montanus*, from *mons*, mountain.] Being beyond the mountain. Thus France, with regard to Italy, is an *ultramontane* country.

Poussin is the only *ultramontane* painter whom the Italians seem to envy. *Cyc.*

2. Of or belonging to the Italian or ultra popish party in the church of Rome; as, *ultramontane* opinions.

ULTRAMONTANE, *n.* A foreigner; one who resides beyond the mountain.

ULTRAMONTANISM, *n.* The doctrines of ultramontanists.—2. The endeavours of the Roman curia, to extend the papal authority, and destroy the consequence of the national churches, such as the Gallican church. It is the endeavour to render the catholic churches of the various countries more subservient to the pope than is compatible with the laws of the various countries, with the rights of the bishops and sovereigns, with the independence and intellectual freedom of each country, and with various elements of catholicism itself. The Jesuits are most strenuous upholders of *ultramontanism*.

ULTRAMONTANIST, *n.* One of the ultramontane party; a promoter of ultramontanism.

ULTRAMUNDANE, *a.* [L. *ultra* and *mundus*, world.] Being beyond the world, or beyond the limits of our system.

ULTRONEOUS, *a.* [L. *ultra*, of one's own accord.] Spontaneous; voluntary. — *Ultroneous witness*, in *Scots law*, is a witness who offers his testimony without being regularly cited.

ULULATE, *v. i.* [L. *ululo*, to howl.] To howl, as a dog or wolf.

ULULATION, *n.* A howling, as of the wolf or dog.

ULVA, *n.* Green laver, a genus of cryptogamic plants, nat. order Algae, tribe Ulvaceæ. The plants of this order are distinguished by having a membranaceous frond of a green colour, with its reproductive granules arranged in fours. Seven species are British, three growing in the sea, one in fresh water, and three in damp places on the land. *U. latissima*, broad green laver, and *U. lactuca*, lettuce green laver, are edible.

ULVA'CEÆ, *n.* A tribe of cryptogamic plants, nat. order Algae. It includes plants which are found in the sea, in fresh water, or on the damp ground. They are generally of an herbaceous green or fine purple colour, and have a thin, tender, membranaceous, reticulated structure, rarely gelatinous; the reproductive organs consist of roundish, mostly quaternate, granules or minute opercular grains, which are embedded in the delicate membrane of the plant. The tribe includes about ten genera, of which five are British, viz. Porphyra, Ulva, Tetraspora, Enteromorpha, and Bangia. [See PORPHYRA, and ULVA, the most important genera.]

UMBEL, *n.* [L. *umbella*, a screen, UMBEL'LA, } or fan.] In *bot.*, a particular mode of inflorescence or flowering, which consists of a number of flower-stalks or rays, nearly equal in

length, spreading from a common centre, their summits forming a level, convex, or even globose surface, more rarely a concave one, as in the carrot.



Umbel of Hemlock.

It is simple or compound. A *simple umbel* is when only a single flower is seated on each pedicel; as, in *Eryngium*, *Butomus umbellatus*, &c. When the primary pedicels have other smaller pedicels, which form of themselves a smaller umbel; as in *Heracleum*, *Terniculum*, *Daucus*, &c., the umbel is said to be *compound*, and the smaller umbels are called *umbellules*. The whole assemblage of the umbels is called the *universal umbel*, and the secondary umbels or umbellules are called *partial umbels*. *Umbel* is sometimes called a *rundel*, from its roundness.

UMBELLAR, } *a.* Pertaining to an UMBELLAL, } umbel; having the form of an umbel.

UMBELLATE, } *a.* Bearing umbels; UMBELLATED, } consisting of an umbel growing on an umbel; as, *umbellate* plants or flowers.

UMBELLET, *n.* A little or partial umbel.

UMBELLIFER, *n.* [L. *umbella* and *fero*.] In *bot.*, a plant producing an umbel.

UMBELLIFERÆ, *n.* An extensive and important nat. order of plants, distinguished by the possession of five stamens and two stigmas, and by the flowers being always seated on umbels. The plants of this order are natives chiefly of the northern parts of the northern hemisphere, inhabiting groves, thickets, plains, marshes, and waste places. They are herbs, seldom shrubs, with fistular furrowed stems. The leaves are in most cases divided; they are alternate, and all of them embrace or clasp the stem by a sheathing petiole. The flowers are white, pink, yellow, or blue, and are seated on umbels which are either simple or compound. The fruit consists of two carpels united by a common axis. The seed is pendulous, and contains a large quantity of albumen in proportion to the size of the embryo. The genera are very numerous, and the species extremely so, and difficult to recognize. Some are poisonous, as hemlock, fool's parsley, and others; others are esculents, as celery, carrots, and parsnips; many yield aromatics, as caraway, coriander, dill, anise; a few secrete a foetid gum-resin, much used in medicine, as assafoetida, galbanum, gum-ammoniacum, oppopanax, and sagapenum.

UMBELLIFEROUS, *a.* [L. *umbella* and *fero*, to bear.] Producing the inflorescence called an umbel; bearing umbels; as, *umbelliferous* plants.

UMBELLULE, *n.* A partial umbel. [See UMBEL.]

**UMBER, n.** In *mineral*, an ore of iron, of a brown, yellowish, or blackish-brown colour, so called from Umbria in Italy, where it was first obtained. It is used as a brown pigment, and to make varnish dry quickly. A specimen from Cyprus afforded, of a hundred parts, 48 parts of oxide of iron, 20 of oxide of manganese, the remainder silic, alumin and water. The same name is given to a variety of peat or brown coal, also used as a pigment. Large beds of it are worked near Cologne, and it is said to be largely used in the adulteration of snuff.

**UMBER, n.** A fish of the salmon family, called the *grayling*, or *Thymallus vulgaris*, a fresh water fish of a fine taste.

**UMBER, v. t.** To colour with umber; to shade or darken.

**UMBERED, a.** [L. *umbra*, a shade.] 1. Shaded; clouded.—2. [from *umber*.] Painted with umber.

**UMBILIC, n.** [infra.] The navel; the centre.

**UMBILIC, } a.** [L. *umbilicus*, the  
**UMBILICAL, } navel.]** Pertaining to the navel; as, *umbilical vessels*; *umbilical region*.—*Umbilical points*, in *math.*, the same as *foci*.—*Umbilical vessels*, in *vegetables*, are the small vessels which pass from the heart of the seed into the side seed-lobes, and are supposed to imbibe the saccharine, farinaceous, or oily matter which is to support the new vegetable in its germination and infant growth.—*Umbilical cord*, the navel-string; a cord-like substance of an intestinal form, about half a yard in length, that proceeds from the navel of the fœtus to the centre of the placenta. In *bot.*, the *umbilical cord* is an elongation of the placenta, in the form of a little cord, as in the hazel nut. It is also named *podosperm*.

**UMBILIC, n.** In *conchology*, a conical depression at the base of a univalve shell.

**UMBILICATE, } a.** Navel-shaped;  
**UMBILICATED, }** formed in the middle like a navel; as a flower, fruit, or leaf.—2. In *zool.*, an epithet applied to a pit, tubercle, or granule, which has a depression in its centre.

**UMBILICUS, n.** [L.] In *anat.*, the navel.—2. In *bot.*, the part of the seed by which it is attached to the pericarp. It is also called the hilum.—3. In *bot.*, formerly the generic name of the wall pennywort and navel-wort.—4. In *conchology*, a circular perforation in the base of the lower whorl or body of many spiral univalves, and common to most of the Trochi.—5. In *geom.*, a term used by the older geometers, as synonymous with *focus*; but in modern works it stands for a point in a surface through which all lines of curvature pass.

**UMBLES, n.** [Fr.] The entrails of a deer.

**UMBO, n.** [L.] The boss or protuberant part of a shield.—2. In *bot.*, the knob in the centre of the pileus or hat of the fungous tribe.—3. In *conchology*, that point of a bivalve shell situated immediately above the hinge.

**UMBONATE, } a.** Bossed; knobbed  
**UMBONATED, }** in the centre.

**UMBRA, n.** [L.] A shadow. In *astron.*, a term applied to the shadow of the earth or moon in an eclipse, or to the dark cone projected from a planet or satellite, on the side opposite to the sun.

**UMBRA'ULIFORM, a.** Having the form of an umbraclum or arbor.

**UMBRAGE, n.** [Fr. *ombrage*, from *ombre*; L. *umbra*, a shade.] 1. A shade; a screen of trees; as, the *umbrage* of woods.—2. Shadow; shade; slight appearance.

The opinion carries no show of truth nor *umbrage* of reason on its side. [See *SHADOW*.] *Woodward.*

3. Suspicion of injury; offence; resentment. The court of France took *umbrage* at the conduct of Spain.

**UMBRA'GEOUS, a.** [Fr. *ombrageaux*.] 1. Shading; forming a shade; as, *umbrageous trees* or foliage.—2. Shady; shaded; as, an *umbrageous grotto* or garden.

*Umbrageous* grots and caves of cool recess. *Milton.*

3. Obscure.

**UMBRA'GEOUSLY, adv.** In an *umbrageous* manner.

**UMBRA'GEOUSNESS, n.** Shadiness; as, the *umbrageousness* of a tree.

**UMBRATE, v. t.** [L. *umbro*, to shade.] To shade; to shadow. [Little used.]

**UMBRATED, pp.** Shaded; shadowed.

**UMBEAT'IC, } a.** [L. *umbraticus*.]  
**UMBRAT'ICAL, }** 1. Shadowy; typical.

—2. Keeping in the shade or at home.

**UMBRATILE, a.** [L. *umbratilis*.] 1. Being in the shade.—2. Unreal; unsubstantial.

This life, that we live disjoined from God, is but a shadow and *umbratile* imitation of that. *More.*

3. Being in retirement; secluded; as, an *umbratile* life. [Little used.]

**UMBRATIOUS, a.** [See *UMBRAGE*.] Suspicious; apt to distrust; captious; disposed to take *umbrage*. [Little used.]

**UMBRE, n.** The African crow. A grallatorial bird, the only species known being the crested or tufted



Umbre (*Scopus umbretta*).

*umbre*, *Scopus Umbretta*. It is diffused throughout all Africa, is as large as a crow, of an umber colour, and has a tuft on its crown.

**UMBREL,† } n.** An umbrella,—  
**UMBRELLO,† }** which see.

**UMBRELLA, n.** [from L. *umbra*, shade.] A portable shade, screen, or canopy which opens and folds, carried in the hand for sheltering the person from the rays of the sun, or from rain or snow. It is formed of silk, cotton, or other cloth extended on strips of elastic whalebone, inserted in or fastened to a rod or stick. The light kind of umbrella, carried by ladies as a defence from the rays of the sun, is more usually termed a parasol. Umbrellas were introduced into Europe in comparatively recent times, from the East, where they have been used for shelter against the sun

from time immemorial. [See *PARASOL*.]—2. A genus of tectibranchiate molluscs, the Gastroplax of Blainville. **UMBRELLA TREE, n.** A species of Magnolia, the *M. tripetala*, a native of North America, so named from the form and position of its leaves. [See *MAGNOLIA*.] The same name is given to another tree, *Thespesia populnea*, a native of India, on account of the form of its branches, which spread out near the top into a close and very regular flat dome or circle. It affords the natives a shade from the sun and a protection from the rain.

**UMBIERE, n.** The visor of a helmet. But only vented up her *umbriere*. *Spenser.*

**UMBRIFEROUS, a.** [L. *umbra* and *fero*.] Casting or making a shade.

**UMBRINA, n.** A genus of acanthopterygious fishes of the family Sciænidæ. The *U. vulgaris* or bearded umbrina



Bearded umbrina (*Umbina vulgaris*).

is a beautiful fish, the ground colour being gold, with bright bands of steel-blue, frequently attaining two feet in length, and sometimes forty pounds in weight. The flesh is white and well flavoured, and is in much request. Its food is small fish, molluscs, and seaweed. It is common on the coasts of France, Spain, and Italy, and has been taken on the coast of Britain.

**UMBROSE, a.** Shady.

**UMBROSITY, n.** [L. *umbrosus*.] Shadiness. [Little used.]

**UMPIRAGE, n.** [from *umpire*.] Arbitration; the decision of an umpire.

**UMPIRE, n.** [Norm. *impere*; L. *imperium*, contracted, as an *empire*.] 1. In *law*, a third person called in to decide a controversy or question submitted to arbitrators, when the arbitrators do not agree in opinion.—2. A person to whose sole decision a controversy or question between parties is referred. Thus the emperor of Russia was constituted *umpire* between Great Britain and the United States, to decide the controversy respecting the slaves carried from the States by the British troops.

**UMPIRE, v. t.** To arbitrate; to decide as *umpire*; to settle, as a dispute. [Little used.]

**UMPIRESHIP, n.** The office of an umpire.

**UN, a** prefix or inseparable preposition, Sax. *un* or *on*, usually *un*, G. *un*, D. *on*, Sans. *an*, is the same word as the L. *in*. It is a particle of negation or of privation, giving to words to which it is prefixed a negative or privative signification. In adjectives it is interpretable by *not*, in nouns by the *want* or *absence of*; and in verbs and their passive participles it almost uniformly signifies the reversing or annulling of the action or state expressed by the verb. *Un* and *In* were formerly in many words, and in some still are used indiscriminately; but *Un* has, in numerous instances, more especially in words of Latin origin, given place to *In*. *Un* admits of no change of *n* into *l*, *m*, or *r*, as *in* does, in *illuminate*, *im-*

*mense, irresolute.* It is prefixed generally to adjectives and participles, and almost at pleasure; but this liberty may be carried too far. As the compounds formed with *un* are so common and so well known, the composition is not noticed under the several words. For the etymologies, see the simple words.

UNABANDONED, *a.* Not abandoned.  
UNABASED, *a.* Not abased; not humbled.

UNABASH'ED, *a.* Not abashed; not confused with shame or by modesty.

UNABATED, *a.* Not abated; not diminished in strength or violence. The fever remains *unabated*.

UNABAT'EDLY, *adv.* Without abatement.

UNABATING, *a.* Not abating; continuing in full force or without alleviation or diminution.

UNABBREVIATED, *a.* Not abbreviated; not shortened

UNABET'TED, *a.* Not abetted; not aided.

UNABIDING, *a.* Not abiding or permanent.

UNABIDINGLY, *adv.* Not abidingly.  
UNABIDINGNESS, *n.* State of being not permanent.

UNA'BILITY, } *n.* Want of ability.  
UNA'BLENESS, } [We use *inability*.]

UNABJURED, *a.* Not abjured; not renounced on oath.

UNA'BLE, *a.* Not able; not having sufficient strength or means; impotent; weak in power, or poor in substance. A man is *unable* to rise when sick; he is *unable* to labour; he is *unable* to support his family or to purchase a farm; he is *unable* for a particular enterprise.—2. Not having adequate knowledge or skill. A man is *unable* to paint a good likeness; he is *unable* to command a ship or an army.  
UNABOLISHABLE, *a.* Not abolishable; that may not be abolished, annulled, or destroyed.

UNABOLISHED, *a.* Not abolished; not repealed or annulled; remaining in force.

UNABRADED, *a.* Not abraded or worn by friction.

UNABRIDG'ED, *a.* Not abridged; not shortened.

UNABROGATED, *a.* Not abrogated; not annulled.

UNABSOLV'ED, *a.* (*s* as *z*.) Not absolved; not acquitted or forgiven.

UNABSORB'ABLE, *a.* Not absorbable; not capable of being absorbed.

UNABSORB'ED, *a.* Not absorbed; not imbibed.

UNABSRD', *a.* Not absurd; reasonable.

UNABUSED, *a.* Not abused.

UNACCELERATED, *a.* Not accelerated; not hastened.

UNACCENT'ED, *a.* Not accented; having no accent; as, an *unaccented* syllable.

UNACCEPTABILITY, *n.* Unacceptableness.

UNACCEPT'ABLE, *a.* Not acceptable; not pleasing; not welcome; not such as will be received with pleasure.

UNACCEPT'ABLENESS, *n.* The state of not pleasing.

UNACCEPT'ABLY, *adv.* In an unwelcome or unpleasing manner.

UNACCEPT'ED, *a.* Not accepted or received; rejected.

UNACCESS'IBLE, *a.* Inaccessible. [This latter word is now used.]

UNACCESS'IBLENESS, *n.* State of

not being approachable; inaccessibleness. [The latter is the word now used.]  
UNACCESS'IBLY, *adv.* In an inaccessible manner.

UNACCLIMATED, *a.* Not inured to the climate.

UNACCOMMODATED, *a.* Not accommodated; not furnished with external conveniences.—2. Not fitted or adapted.

UNACCOMMODATING, *a.* Not accommodating; not ready to oblige; uncompliant.

UNACCOMPANIED, *a.* Not attended; having no attendants, companions, or followers.—2. Having no appendages.

UNACCOMPLISHED, *a.* Not accomplished; not finished; incomplete.—2. Not refined in manners; not furnished with elegant literature or with polish of manners.

UNACCOMPLISHMENT, *n.* Want of accomplishment or execution.

UNACCORD'ANT, *a.* Not accordant or harmonious.

UNACCORD'ED, *a.* Not accorded; not agreed upon.

UNACCORD'ING, *a.* Not according; not agreeing.

UNACCOUNTABILITY, *n.* The state or quality of not being accountable; or the state of being unaccountable for.

UNACCOUNT'ABLE, *a.* Not to be accounted for. Such folly is *unaccountable*.—2. Not explicable; not to be solved by reason or the light possessed; not reducible to rule. The union of soul and body is to us *unaccountable*.—3. Not subject to account or control; not subject to answer; not responsible.

UNACCOUNT'ABLENESS, *n.* Strangeness.—2. Irresponsibility.

UNACCOUNT'ABLY, *adv.* In a manner not to be explained; strangely.

UNACCOUNT'ED, *a.* Not accounted.

UNACCOUT'RED, *a.* Not accoutred.

UNACCREDIT'ED, *a.* Not accredited; not received; not authorized. The minister or the consul remained *unaccredited*.

UNACCUM'ULATED, *a.* Not accumulated.

UNAC'CURATE, *a.* Inaccurate; not correct or exact. [But *inaccurate* is now used.]

UNAC'CURATENESS, *n.* Want of correctness. [But we now use *inaccuracy* or *inaccuracy*.]

UNACCURSED, *a.* Not accursed.

UNACCUSED, *a.* (*s* as *z*.) Not accused; not charged with a crime or fault.

UNACCUS'TOMED, *a.* Not accustomed; not used; not made familiar; not habituated; as, a bullock *unaccustomed* to the yoke. Jer. xxxi.—2. New; not usual; not made familiar; as, *unaccustomed* air; *unaccustomed* ideas.

UNACHIEVABLE, *a.* That cannot be done or accomplished.

UNACHIEVED, *a.* Not achieved; not accomplished or performed.

UNACHING, *a.* Not aching; not giving or feeling pain.

UNACKNOWLEDGED, *a.* Not acknowledged; not recognized; as, an *unacknowledged* agent or consul.—2. Not owned; not confessed; not avowed; as, an *unacknowledged* crime or fault.

UNACQUAINTANCE, *n.* Want of acquaintance or familiarity; want of knowledge; followed by *with*; as, an utter *unacquaintance* with his design.

UNACQUAINTED, *a.* Not well known; unusual.

And th' *unacquainted* light began to fear.  
Spenser.

2. Not having familiar knowledge; followed by *with*.

My ears are *unacquainted*  
With such bold truths. Denham.

UNACQUAINTEDNESS, *n.* Want of acquaintance.

UNACQUIR'ABLE, *a.* Not acquirable.

UNACQUIRED, *a.* Not acquired; not gained.

UNACQUIT'TED, *a.* Not acquitted; not declared innocent.

UNACT'ABLE, *a.* Not capable of being acted; unfit to be represented.

Much of the unacted drama is really *unactable*.  
Qu. Rev.

UNACT'ED, *a.* Not acted; not performed; not executed.

UNACT'IVE, *a.* Not active; not brisk. [We now use *inactive*.]—2. Having no employment.—3. Not busy; not diligent; idle.—4. Having no action or efficacy. [See *INACTIVE*.]

UNACT'IVENESS, *n.* Inactivity.

UNACT'UATED, *a.* Not actuated; not moved.

UNADAPT'ED, *a.* Not adapted; not suited.

UNADAPT'EDNESS, *n.* Unsuitableness.

UNADDICT'ED, *a.* Not addicted; not given or devoted.

UNADDRESS'ED, *a.* Not addressed.

UNADHESIVE, *a.* Not adhesive.

UNADJUDG'ED, *a.* Not adjudged; not judicially decided.

UNADJUST'ED, *a.* Not adjusted; not settled; not regulated; as, differences *unadjusted*.—2. Not settled; not liquidated; as, *unadjusted* accounts.

UNADMINISTERED, *a.* Not administered.

UNADMIR'ED, *a.* Not admired; not regarded with great affection or respect.

UNADMIRING, *a.* Not admiring.

UNADMITTED, *a.* Not admitted.

UNADMONISHED, *a.* Not admonished; not cautioned, warned, or advised.

UNADOPT'ED, *a.* Not adopted; not received as one's own.

UNADORED, *a.* Not adored; not worshipped.

UNADORN'ED, *a.* Not adorned; not decorated; not embellished.

UNADUL'TERATE, } *a.* Not adulterated;  
UNADUL'TERATED, } dulterated;  
genuine; pure.

UNADUL'TERATELY, *adv.* Without spurious mixture.

UNADULTEROUS, *a.* Not guilty of adultery.

UNADULTEROUSLY, *adv.* Without being guilty of adultery.

UNADVENTUROUS, *a.* Not adventurous; not bold or resolute.

UNADVISABLE, *a.* (*s* as *z*.) Not advisable; not to be recommended; not expedient; not prudent.

UNADVISABLY, *adv.* In an inadvisable manner.

UNADVISED, *a.* (*s* as *z*.) Not prudent; not discreet.—2. Done without due consideration; rash; as, an *unadvised* measure or proceeding.

UNADVISEDLY, *adv.* (*s* as *z*.) Imprudently; indiscreetly; rashly; without due consideration.

UNADVISEDNESS, *n.* (*s* as *z*.) Imprudence; rashness.

UNA'ERATED, *a.* Not combined with carbonic acid.

UNAFF'ABLE, *a.* Not affable; not free to converse; reserved.

UNAFFECT'ED, *a.* Not affected; plain; natural; not laboured or artificial;

simple; as, *unaffected* ease and grace.—2. Real; not hypocritical; sincere; as, *unaffected* sorrow.—3. Not moved; not having the heart or passions touched. Men often remain *unaffected* under all the solemn monitions of Providence.

**UNAFFECTEDLY**, *adv.* Really; in sincerity; without disguise; without attempting to produce false appearances. He was *unaffectedly* cheerful.

**UNAFFECTEDNESS**, *n.* State of being unaffected.

**UNAFFECTIBLE**, *a.* That cannot be affected.

**UNAFFECTING**, *a.* Not pathetic; not adapted to move the passions.

**UNAFFECTIONATE**, *a.* Not affectionate; wanting affection.

**UNAFFIANCED**, *a.* Not affianced.

**UNAFFIRMED**, *a.* Not affirmed; not confirmed.

**UNAFFLICTED**, *a.* Not afflicted; free from trouble.

**UNAFRAID**, *a.* Not afraid; fearless.

**UNAFFRIGHTED**, *a.* Not frightened.

**UNAGGRAVATED**, *a.* Not aggravated.

**UNAGGRESSIVE**, *a.* Not aggressive.

**UNAGITATED**, *a.* Not agitated; calm.

**UNAGREEABLE**, *a.* Not consistent; unsuitable.

**UNAGREEABLENESS**, *n.* Unsuitableness; inconsistency.

**UNAGREEABLY**, *adv.* In an unagreeable manner.

**UNAIDABLE**, *† a.* Not to be aided or assisted.

**UNAIDED**, *a.* Not aided; not assisted.

**UNAILING**, *a.* Free from disease.

**UNAIMED**, *a.* Not aimed.

**UNAIMING**, *a.* Having no particular aim or direction.

**UNAIRED**, *a.* Not aired.

**UNALARMED**, *a.* Not alarmed; not disturbed with fear.

**UNALARMING**, *a.* Not alarming.

**UNALIENABLE**, *a.* Not alienable; that cannot be alienated; that may not be transferred; as, *unalienable* rights.

**UNALIENABLELY**, *adv.* In a manner that admits of no alienation; as, property *unalienably* vested.

**UNALIENATE**, *a.* Not alienate.

**UNALIENATED**, *a.* Not alienated; not transferred; not estranged.

**UNALIST**, *n.* A holder of only one benefice. [*The reverse of Pluralist.*]

**UNALLAYED**, *a.* Not allayed; not appeased or quieted.—2. For *unalloyed*. [*See UNALLOYED.*]

**UNALLEGED**, *a.* Not alleged.

**UNALLEVIATED**, *a.* Not alleviated; not mitigated.

**UNALLIABLE**, *a.* That cannot be allied or connected in amity.

**UNALLIED**, *a.* Having no alliance or connection, either by nature, marriage, or treaty; as, *unallied* families, or nations, or substances.—2. Having no powerful relation.

**UNALLOWABLE**, *a.* That may not be allowed.

**UNALLOWED**, *a.* Not allowed; not permitted.

**UNALLOYED**, *a.* Not alloyed; not reduced by foreign admixture; as, metals *unalloyed*.

I enjoyed *unalloyed* satisfaction in his company. *Mitford.*

**UNALLURED**, *a.* Not allured; not enticed.

**UNALLURING**, *a.* Not alluring; not tempting.

**UNALLURINGLY**, *adv.* Not alluringly.

**UNALMSED**, *a.* (unalm̄ed.) Not having received alms. [*Bad.*]

**UNALTERABLE**, *a.* Not alterable; unchangeable; immutable.

**UNALTERABLENESS**, *n.* Unchange-  
**UNALTERABILITY**, } ableness; }  
immutability.

**UNALTERABLY**, *adv.* Unchangeably; immutably.

**UNALTERED**, *a.* Not altered or changed.

**UNALTERING**, *a.* Not altering.

**UNAMALGAMATED**, *a.* Not amalgamated.

**UNAMAZED**, *a.* Not amazed; free from astonishment.

**UNAMBIGUITY**, *n.* Absence of ambiguity; clearness.

**UNAMBIGUOUS**, *a.* Not ambiguous; not of doubtful meaning; plain; clear; certain.

**UNAMBIGUOUSLY**, *adv.* In a clear, explicit manner.

**UNAMBIGUOUSNESS**, } *n.* Clear-  
**UNAMBIGUITY**, } ness; ex-  
plicitness.

**UNAMBITIOUS**, *a.* Not ambitious; free from ambition.—2. Not affecting show; not showy or prominent; as, *unambitious* ornaments.

**UNAMBITIOUSLY**, *adv.* Not ambitiously.

**UNAMBITIOUSNESS**, *n.* Freedom from ambition.

**UNAMENABLE**, *a.* Not amenable or responsible.

**UNAMENDABLE**, *a.* Not capable of emendation.

**UNAMENDED**, *a.* Not amended; not rectified.

**UNAMERCED**, *a.* Not amerced.

**UNAMIABLE**, *a.* Not amiable; not conciliating love; not adapted to gain affection.

**UNAMIABLENESS**, *n.* Want of amiableness.

**UNAMUSABLE**, *a.* Incapable of being amused; of an insensible nature.

**UNAMUSED**, *a.* (s as z.) Not amused; not entertained.

**UNAMUSING**, *a.* (s as z.) Not amusing; not affording entertainment.

**UNAMUSINGLY**, *adv.* Not amusingly.

**UNAMUSIVE**, *a.* Not affording amusement.

**UNANALOGICAL**, *a.* Not analogical.

**UNANALOGOUS**, *a.* Not analogous; not agreeable to.

**UNANALYZED**, *a.* Not analyzed; not resolved into simple parts.

**UNANCHORED**, *a.* Not anchored; not moored.

**UNANELED**, *† a.* Not having received extreme unction. [*See ANNEAL.*]

**UNANGULAR**, *a.* Having no angles.

**UNANIMIALIZED**, *a.* Not formed into animal matter.

**UNANIMATE**, *† a.* Of one mind; unanimous.

**UNANIMATED**, *a.* Not animated; not possessed of life.—2. Not enlivened; not having spirit; dull. [In this sense *Inanimate* is preferable.]

**UNANIMATING**, *a.* Not animating; dull.

**UNANIMITY**, *n.* [Fr. *unanimité*; L. *unus*, one, and *animus*, mind.] Agreement of a number of persons in opinion or determination; as, there was perfect *animity* among the members of the council.

**UNANIMOUS**, *a.* Being of one mind; agreeing in opinion or determination; as, the house of assembly was *unanimous*; the members of the council

were *unanimous*.—2. Formed by unanimity; as, a *unanimous* vote.

**UNANIMOUSLY**, *adv.* With entire agreement of minds.

**UNANIMOUSNESS**, *n.* The state of being of one mind.—2. Proceeding from unanimity; as, the *unanimousness* of a vote.

**UNANNEALED**, *a.* Not annealed; not tempered by heat; suddenly cooled.

**UNANNEXED**, *a.* Not annexed; not joined.

**UNANNIHILABLE**, *a.* That cannot be annihilated.

**UNANNOUNCED**, *a.* Not announced or proclaimed.

**UNANNOYED**, *n.* Not annoyed or incommoded.

**UNANPOINTED**, *a.* Not anointed.—2. Not having received extreme unction.

**UNANSWERABLE**, *a.* Not to be satisfactorily answered; not capable of refutation; as, an *unanswerable* argument.

**UNANSWERABLENESS**, *n.* The state of being unanswerable.

**UNANSWERABLY**, *adv.* In a manner not to be answered; beyond refutation.

**UNANSWERED**, *a.* Not answered; not opposed by a reply.—2. Not refuted.—3. Not suitably returned.

**UNANTICIPATED**, *a.* Not anticipated.

**UNANXIOUS**, *a.* Free from anxiety.

**UNAPOCRYPHAL**, *a.* Not apocryphal; not of doubtful authority.

**UNAPOLOGETIC**, *a.* Not apologetic.

**UNAPOSTOLIC**, } *a.* Not apos-  
**UNAPOSTOLICAL**, } tolic; not agreeable to apostolic usage; not having apostolical authority.

**UNAPPALLED**, *a.* Not appalled; not daunted; not impressed with fear.

With eyes erect and visage *unappall'd*. *Smith.*

**UNAPPARUELLED**, *a.* Not apparelled; not clothed.

**UNAPPARENT**, *a.* Not apparent; obscure; not visible.

**UNAPPEALABLE**, *a.* Not appealable; admitting no appeal; that cannot be carried to a higher court by appeal; as, an *unappealable* cause.

**UNAPPEALING**, *a.* Not appealing.

**UNAPPEASABLE**, *a.* (s as z.) Not to be appeased or pacified; as, an *unappeasable* clamour.—2. Not placable; as, *unappeasable* wrath.

**UNAPPEASABLENESS**, *n.* State of being unappeasable.

**UNAPPEASED**, *a.* (s as z.) Not appeased; not pacified.

**UNAPPLAUD'ED**, *a.* Not applauded.

**UNAPPLAUD'ING**, *a.* Not applauding.

**UNAPPLAUS'IVE**, *a.* Not applauding.

**UNAPPLIABLE**, *a.* Inapplicable. [*Little used.*]

**UNAPPLICABLE**, *a.* Inapplicable; that cannot be applied. [We now use *inapplicable*.]

**UNAPPLIED**, *a.* Not applied; not used according to the destination; as, *unapplied* funds.

**UNAPPORTIONED**, *a.* Not apportioned.

**UNAPPOSITE**, *a.* (s as z.) Not apposite; not suitable.

**UNAPPRECIABLE**, *a.* Not appreciable.

**UNAPPREC'IABLY**, *adv.* Inappreciablely.

**UNAPPRECIATED**, *a.* Not duly estimated or valued.

**UNAPPREHENDED**, *a.* Not appre-



## UNARTFULLY

hended; not taken.—2. Not understood.

**UNAPPREHENSIBLE**, *a.* Not capable of being understood. [*Inapprehensible* is now used.]

**UNAPPREHENSIBLENESS**, *n.* State of being unapprehensible.

**UNAPPREHENSIVE**, *a.* Not apprehensive; not fearful or suspecting.—2. Not intelligent; not ready of conception. [*Inapprehensive* is now used.]

**UNAPPREHENSIVELY**, *adv.* Not apprehensively.

**UNAPPREHENSIVENESS**, *n.* State of being unapprehensive.

**UNAPPRISED**, *a.* (*s* as *z*.) Not apprised; not previously informed.

**UNAPPROACHABLE**, *a.* That cannot be approached; inaccessible.

**UNAPPROACHABLENESS**, *n.* Inaccessibility.

**UNAPPROACHABLY**, *adv.* So as not to be approachable.

**UNAPPROACHED**, *a.* Not approached; not to be approached.

**UNAPPROPRIATE**, *a.* Inappropriate.

**UNAPPROPRIATED**, *a.* Not appropriated; not applied or directed to be applied to any specific object; as money or funds.—2. Not granted or given to any person, company, or corporation; as, *unappropriated* lands.

**UNAPPROVED**, *a.* Not approved; not having received approbation.

**UNAPPROVING**, *a.* Not approving.

**UNAPPROVINGLY**, *adv.* With disapprobation.

**UNAPRONED**, *a.* Without an apron.

**UNAPT**, *a.* Not apt; not ready or propense.

*A soldier, unapt to weep. Shak.*

**2. Dull**; not ready to learn.—3. Unfit; not qualified; not disposed; with *to*, before a verb, and *for*, before a noun; as, *unapt to admit a conference with reason.*

*Unapt for noble, wise, spiritual employments. Taylor.*

**4. Improper**; unsuitable.

**UNAPTLY**, *adv.* Unfitly; improperly.

**UNAPTNESS**, *n.* Unfitness; unsuitableness.—2. Dulness; want of quick apprehension.—3. Unreadiness; disqualification; want of propension. The mind, by excess of exertion, gets an *unaptness* to vigorous attempts.

**UNARGUED**, *a.* Not argued; not debated.—2. Not disputed; not opposed by argument.—3. † Not censured; *a Latinism.*

**UNARM**, † *v. t.* To disarm; to strip of armour or arms. [*See* DISARM.]

**UNARMED**, *a.* Not having on arms or armour; not equipped. Man is born *unarmed*. It is mean to attack even an enemy *unarmed*.—2. Not furnished with scales, prickles, or other defence; as animals and plants.

**UNARRAIGNED**, *a.* Not arraigned; not brought to trial.

**UNARRANGED**, *a.* Not arranged; not disposed in order.

**UNARRAYED**, *a.* Not arrayed; not dressed.—2. Not disposed in order.

**UNARRESTED**, *a.* Not stopped; not apprehended.

**UNARRIVED**, *a.* Not arrived. [*III formed.*]

**UNARTED**, † *a.* Ignorant of the arts.

**UNARTFUL**, *a.* Not artful; artless; not having cunning.—2. Wanting skill. [*Little used.*]

**UNARTFULLY**, *adv.* Without art; in an unartful manner. [*In lieu of these*

## UNASSUMING

words, *artless* and *artlessly* are generally used.]

**UNARTICULATED**, *a.* Not articulated or distinctly pronounced.

**UNARTIFICIAL**, *a.* Inartificial; not artificial; not formed by art.

**UNARTIFICIALLY**, *adv.* Not with art; in a manner contrary to art.

**UNARTIST-LIKE**, *a.* Not like an artist.

**UNASCENDED**, *a.* Not ascended.

**UNASCENDING**, *a.* That cannot be ascended.

**UNASCERTAINABLE**, *a.* That cannot be ascertained, or reduced to a certainty; that cannot be certainly known.

*The trustees are unascertainable. Wheaton's Rep.*

**UNASCERTAINED**, *a.* Not reduced to a certainty; not certainly known.

**UNASHAMED**, *a.* Not ashamed.

**UNASKED**, *a.* Not asked; unsolicited; as, to bestow favours *unasked*; that was an *unasked* favour.—2. Not sought by entreaty or care.

*The bearded corn ensu'd From earth unask'd. Dryden.*

**UNASPECTIVE**, *a.* Not having a view to.

**UNASPIRATED**, *a.* Having no aspirate.

**UNASPIRING**, *a.* Not aspiring; not ambitious.

**UNASPIRINGLY**, *adv.* In an unspiriting manner.

**UNASSAILABLE**, *a.* Not assailable; that cannot be assaulted.

**UNASSAILABLELY**, *adv.* So as to be unassailable.

**UNASSAILED**, *a.* Not assailed; not attacked by violence.

*To keep my life and honour unassail'd. Milton.*

**UNASSAULTABLE**, *a.* Not assaultable.

**UNASSAULTED**, *a.* Not assaulted; not attacked.

**UNASSAYED**, *a.* Not essayed; not attempted. [*We now use unessayed.*]

—2. Not subjected to assay or trial.

**UNASSEMBLED**, *a.* Not assembled or congregated.

**UNASSERTED**, *a.* Not asserted; not affirmed; not vindicated.

**UNASSESS'ED**, *a.* Not assessed; not rated.

**UNASSIGNABLE**, *a.* Not assignable; that cannot be transferred by assignment or indorsement.

**UNASSIGNABLY**, *adv.* In an unassignable manner.

**UNASSIGNED**, *a.* Not assigned; not declared; not transferred.

**UNASSIMILATED**, *a.* Not assimilated; not made to resemble.—2. In *physiology*, not united with, and actually made a part, either of the proper fluids or solids of the body; not animalized, as food.

**UNASSIMILATING**, *a.* Not assimilating.

**UNASSIST'ED**, *a.* Not assisted; not aided or helped; as, *unassisted* reason.

**UNASSISTING**, *a.* Giving no help.

**UNASSOCIATED**, *a.* Not associated; not united with a society.—2. In *Connecticut*, not united with an ecclesiastical association; as, an *unassociated* church.

**UNASSORT'ED**, *a.* Not assorted; not distributed into sorts.

**UNASSUAGED**, *a.* Not appeased.

**UNASSUMED**, *a.* Not assumed.

**UNASSUMING**, *a.* Not assuming; not bold or forward; not making lofty

## UNAVAILABLY

pretensions; not arrogant; modest; as, an *unassuming* youth; *unassuming* manners.

**UNASSURED**, *a.* [*See* SURE.] Not assured; not confident; as, an *unassured* countenance.—2. Not to be trusted; as, an *unassured* foe.—3. Not insured against loss; as, goods *unassured*.

**UNATONABLE**, *a.* Not to be appeased; not to be reconciled.

**UNATONED**, *a.* Not expiated.

*A brother's blood yet unaton'd. Rowe.*

**UNATTACHED**, *a.* Not attached; not arrested.—2. Not closely adhering; having no fixed interest; as, *unattached* to any party.—3. Not united by affection.

**UNATTACK'ABLE**, *a.* Not attackable.

**UNATTACK'ED**, *a.* Not attacked; not assaulted.

**UNATTAINABLE**, *a.* Not to be gained or obtained; as, *unattainable* good.

**UNATTAINABLENESS**, *n.* The state of being beyond the reach of power.

**UNATTAINABLY**, *adv.* In an unattainable manner.

**UNATTAINED**, *a.* Not attained or reached.

**UNATTAINING**, *a.* Not attaining.

**UNATTAINED**, *a.* Not attained; not corrupted.

**UNATTEMPERED**, *a.* Not tempered by mixture.

**UNATTEMPTED**, *a.* Not attempted; not tried; not essayed.

*Things unattempted yet in prose or rhyme. Milton.*

**UNATTEND'ED**, *a.* Not attended; not accompanied; having no retinue or attendance.—2. Forsaken.—3. Not medically attended; not dressed; as, *unattended* wounds.

**UNATTENDING**, *a.* Not attending or listening; not being attentive.

*Ill is lost that prattise That is address'd to unattending ears. Milton.*

**UNATTENTIVE**, *a.* Not regarding; inattentive. [*The latter word is now used.*]

**UNATTENUATED**, *a.* Not attenuated.

**UNATTEST'ED**, *a.* Not attested; having no attestation.

**UNATTIRED**, *a.* Not attired; not adorned.

**UNATTRACT'ED**, *a.* Not attracted; not affected by attraction.

**UNATTRACTIVE**, *a.* Not attractive.

**UNAU**, *n.* An edentate mammal, the *Bradypus didactylus*. [*See* SLOTH.]

**UNAUDITED**, *a.* Not audited or adjusted.

**UNAUGMENT'ED**, *a.* Not augmented or increased; in *gram.*, having no augment, or additional syllable.

**UNAUTHENTIC**, *a.* Not authentic; not genuine or true.

**UNAUTHENTICATED**, *a.* Not authenticated; not made certain by authority.

**UNAUTHORITATIVE**, *a.* Not authoritative.

**UNAUTHORITATIVELY**, *adv.* Without authority.

**UNAUTHORIZED**, *a.* Not authorized; not warranted by proper authority; not duly commissioned.

**UNAVAILABLE**, *a.* Not available; not having sufficient power to produce the intended effect; not effectual; vain; useless.

**UNAVAILABLENESS**, *n.* Inefficacy; uselessness.

**UNAVAILABLY**, *adv.* Without availing or success.

UNAVAILING, *a.* Not having the effect desired; ineffectual; useless; vain; as, *unavailing* efforts; *unavailing* prayers.

UNAVAILINGLY, *adv.* Without effect.

UNAVENGE'ABLE, *a.* Not avengable.

UNAVENG'ED, *a.* Not avenged; not having obtained satisfaction; as, a person is *unavenged*.—2. Not punished; as, a crime is *unavenged*.

UNAVERT'ED, *a.* Not averted; not turned away.

UNA VOICE. [Lat.] With one voice; unanimately.

UNAVOID'ABLE, *a.* That cannot be made null or void.—2. Not avoidable; not to be shunned; inevitable; as, *unavoidable* evils.—3. Not to be missed in ratiocination.

UNAVOID'ABLENESS, *n.* The state of being unavoidable; inevitableness.

UNAVOID'ABLY, *adv.* Inevitably; in a manner that prevents failure or escape.

UNAVOID'ED, *a.* Not avoided or shunned.—2. Inevitable. [*Not legitimate*.]

UNAVOUCH'ED, *a.* Not avouched.

UNAVOWED, *a.* Not avowed; not acknowledged; not owned; not confessed.

UNAWAKED, } *a.* Not awakened;

UNAWAKENED, } not roused from sleep.—2. Not roused from spiritual slumber or stupidity.

UNAWARE, *a.* Without thought; inattentive.

UNAWARE, } *adv.* Suddenly; un-

UNAWARES, } expectedly; without previous preparation. The evil came upon us *unawares*.—2. Without premeditated design. He killed the man *unawares*.—*At unawares*, unexpectedly.

He breaks *at unawares* upon our walks. *Dryden*.

UNAW'ED, *a.* Not awed; not restrained by fear; undaunted.

UNBACK'ED, *a.* Not having been backed; as, an *unbacked* colt.—2. Not tamed; not taught to bear a rider.—3. Unsupported; left without aid.

UNBAR'FLED, *a.* Not defeated; not confounded.

UNBAG', *v. t.* To let out of a bag; as, to *unbag* a fox.

UNBAG'GED, *a.* or *pp.* Not bagged; ejected from a bag.

UNBAIL'ABLE, *a.* Not hailable.

UNBAK'ED, *a.* Not baked.

UNBAL'ANCED, *a.* Not balanced; not poised; not in equipoise.

Let earth *unbalanc'd* from her orbit *fly*. *Pope*.

2. Not adjusted; not settled; not brought to an equality of debt and credit; as, an *unbalanced* account.—3. Not restrained by equal power; as, *unbalanced* parties.

UNBAL'LAST, *v. i.* To free from ballast; to discharge the ballast from.

UNBAL'LASTED, *pp.* Freed from ballast.—2. *a.* Not furnished with ballast; not kept steady by ballast or by weight; unsteady; as, *unballasted* wits. "*Unballast vessel*," for *unballasted*, in Addison, is an unauthorized phrase.

UNBAN'DAGED, *a.* Not bandaged.

UNBAND'ED, *a.* Stripped of a band; having no band.

UNBAN'NERED, *a.* Having no banner.

UNBAPTIZED, *a.* Not baptized.

UNBAPTIZING, *a.* Not baptizing.

UNBAR, *v. t.* To remove a bar or bars

from; to unfasten; to open; as, to *unbar* a gate.

UNBARBED,† Not shaven.

UNBARKE'D, *a.* Stripped of its bark. [We now use *barked* in the same sense.]

UNBARRED, *pp.* Having its bars removed; unfastened.

UNBAR'RIE'ADE, *v. t.* To throw open.

UNBARRING, *pp.* Removing the bars from; unfastening.

UNBASH'FUL, *a.* Not bashful; bold; impudent.

UNBASH'FULLY, *adv.* Boldly; impudently.

UNBATED,† *a.* Not repressed; not blunted.

UNBATHED, *a.* Not bathed; not wet.

UNBATTERED, *a.* Not battered; not bruised or injured by blows.

UNBAY,† *v. t.* To open; to free from the restraint of mounds.

I ought to *unbay* the current of my passions. *Norris*.

UNBEARABLE, *a.* Not to be borne or endured.

UNBEARDED, *a.* (unberd'ed). Having no beard; beardless.

UNBEARING, *a.* Bearing or producing no fruit.

UNBEATEN, *a.* Not beaten; not treated with blows.—2. Untrod; not beaten by the feet; as, *unbeaten* paths.

UNBEAUTE'OUS, } *a.* [See BEAUTY.]

UNBEA'UTIFUL, } Not beautiful; having no beauty.

UNBEAUTE'OUSLY, *adv.* In an unbeauteous manner.

UNBEA'UTIFIED, *a.* Not beautified or adorned.

UNBEA'UTIFULLY, *adv.* In an unbeautiful manner.

UNBE'CLOUD'ED, *a.* Not beclouded or dimmed; seeing clearly.

UNBE'COME,† *v. t.* Not to become; not to be suitable to; to misbecome.

UNBE'COMING, *a.* Unsuitable; improper for the person or character; indecent; indecorous.

My grief lets *unbecoming* speeches fall. *Dryden*.

UNBE'COMINGLY, *adv.* In an unsuitable manner; indecorously.

UNBE'COMINGNESS, *n.* Unsuitableness to the person, character, or circumstances; impropriety; indecorousness.

UNBED', *v. t.* To raise or rouse from bed.

Eels *unbed* themselves and stir at the noise of thunder. *Walton*.

UNBED'DED, *pp.* Raised from bed; disturbed.

UNBED'DING, *pp.* Raising from bed.

UNBE'FITTING, *a.* Not befitting; unsuitable; unbecoming.

UNBEFOOL', *v. t.* To change a foolish nature.—2. To open the eyes of some one to a sense of folly.—3. To deceive one.

UNBEFRIENDED, *a.* (unbefrend'ed.) Not befriended; not supported by friends; having no friendly aid.

UNBEGET', *v. t.* To deprive of existence.

UNBEGOT', } *a.* Not generated;

UNBEGOT'TEN, } eternal.—2. Not yet generated.—3. Not begotten; not generated.

UNBEGUILE, *v. t.* To deceive; to free from the influence of deceit.

Then *unbeguile* thyself. *Donne*.

UNBEGUILED, *pp.* Undeceived.

UNBEGUILING, *pp.* Undeceiving.

UNBEGUN', *a.* Not yet begun.

UNBEHELD', *a.* Not beheld; not seen; not visible.

UNBE'ING,† *a.* Not existing.

UNBELIEF, *n.* [Sax. *unbelæfa*.] 1. Incredulity; the withholding of belief; as, *unbelief* is blind.—2. Infidelity; disbelief of divine revelation.—3. In the *New Testament*, disbelief of the truth of the gospel, rejection of Christ as the Saviour of men, and of the doctrines he taught; distrust of God's promises and faithfulness, &c.; *Matth. xiii.*; *Mark xvi.*; *Heb. iii.*; *Rom. iv.*—4. Weak faith; *Mark ix.*

UNBELIEVE, *v. t.* To discredit; not to believe or trust.—2. Not to think real or true.

UNBELIEVED, *pp.* Not believed; discredited.

UNBELIEVER, *n.* An incredulous person; one who does not believe.—2. An infidel; one who discredits revelation, or the mission, character, and doctrines of Christ; *2 Cor. vi.*

UNBELIEVING, *a.* Not believing; incredulous.—2. Infidel; discrediting divine revelation, or the mission, character, and doctrines of Christ; as, the *unbelieving* Jews; *Acts xiv.*; *Rev. xxi.*

UNBELIEVINGLY, *adv.* In an unbelieving manner.

UNBELIEVINGNESS, *n.* State of being unbelieving

UNBELOVED, *a.* Not loved.

UNBELT'ED, *a.* Not belted; ungirded.

UNBEMO'ANED, *a.* Not lamented.

UNBEND', *v. i.* To become relaxed or unbent.—2. To rid one's self of constraint; to act with freedom.

UNBEND', *v. t.* To free from flexure; to make straight; as, to *unbend* a bow.

—2. To relax; to remit from a strain or from exertion; to set at ease for a time; as, to *unbend* the mind from study or care.—3. To relax effeminately.

You *unbend* your noble strength. *Shak.*

4. In *seamanship*, to take the sails from their yards and stays; also to cast loose a cable from the anchors; also, to untie one rope from another.

UNBEND'ING, *pp.* Relaxing from any strain; remitting; taking from their yards, &c., as sails.—2. *a.* Not suffering flexure.—3. Unyielding; resolute; inflexible; *applied to persons*.—4. Unyielding; inflexible; firm; *applied to things*; as, *unbending* truths.—5. Devoted to relaxation.

I hope it may entertain your lordship at an *unbending* hour. *Rowe*.

UNBEND'INGLY, *adv.* Without bending; obstinately.

UNBEN'EFICED, *a.* Not enjoying or having a benefice.

UNBENEVO'LENT, *a.* Not benevolent; not kind.

UNBENEVO'LENTLY, *adv.* In an unbenevolent manner.

UNBENIGHTED, *a.* Never visited by darkness.

UNBENIGN, *a.* Not benign; not favourable or propitious; malignant.

UNBENT', *pp.* of *Unbend*. Relaxed; remitted; relieved from strain or exertion.—2. In *seamen's lan.*, taken from the yards; loosed; as, the sails are *unbent*; the cable is *unbent*.—3. Not strained; unstrung; as, a bow *unbent*.—4. Not crushed; not subdued; as, the soul is *unbent* by woes.

UNBEQUEATHED, *a.* Not bequeathed; not given by legacy.

UNBESEEMING, *a.* Unbecoming; not befitting; unsuitable.

UNBESEEMINGLY, *adv.* In an unbecoming manner.

UNBESEEMINGNESS, *n.* State of being unbeseeiming.

UNBESOUGHT, *a.* (unbesaut'.) Not besought; not sought by petition or entreaty.

UNBESPOKEN, *a.* Not bespoken, or ordered beforehand.

UNBESTARRED, *a.* Not adorned or distinguished by stars.

UNBESTOWED, *a.* Not bestowed; not given; not disposed of.

UNBETRAYED, *a.* Not betrayed.

UNBETROTH'ED, *a.* Not betrothed.

UNBEWAILED, *a.* Not bewailed; not lamented.

UNBEWITCH', *v. t.* To free from fascination.

UNBIAS, *v. t.* To free from bias or prejudice.

The truest service a private man can do his country, is to *unbias* his mind, as much as possible, between the rival powers. *Swift*.

UNBI'ASSED, *pp.* Freed from prejudice or bias.—2. *a.* Free from any undue partiality or prejudice; impartial; as, an *unbiased* mind; *unbiased* opinion or decision.

UNBI'ASSEDLY, *adv.* Without prejudice; impartially.

UNBI'ASSEDNESS, *n.* Freedom from bias or prejudice.

UNBID', } *a.* Not bid; not com-

UNBID'DEN, } manded.—2. Spontaneous; as, thorns shall the earth produce *unbid*.—3. Uninvited; not requested to attend; as, *unbidden* guests.

UNBIG'OTED, *a.* Free from bigotry.

UNBIND, *v. t.* To untie; to remove a band from; to unfasten; to loose; to set free from shackles. *Unbind* your fillets; *unbind* the prisoner's arms; *unbind* the load.

UNBINDING, *pp.* Untying; setting free.

UNBIOGRAPH'ICAL, *a.* Not biographical.

UNBISH'OP, *v. t.* To deprive of episcopal orders.

UNBISH'OPED, *pp.* Deprived of episcopal orders.

UNBIT', *a.* Not bitten.

UNBIT', *v. t.* In *seamanship*, to remove the turns of a cable from off the bits.—2. To unbride.

UNBIT'ED, *pp.* Removed from the bits; unbridled.

UNBIT'TING, *pp.* Unbridling; removing from the bits.

UNBLAMABLE, *a.* Not blamable; not culpable; innocent.

UNBLAMABLENESS, *n.* State of being chargeable with no blame or fault.

UNBLAMABLY, *adv.* In such a manner as to incur no blame; 1 *Thess.* ii.

UNBLAMED, *a.* Not blamed; free from censure.

UNBLASTED, *a.* Not blasted; not made to wither.

UNBLEACHED, *a.* Not bleached; not whitened.

UNBLEEDING, *a.* Not bleeding; not suffering loss of blood.

UNBLEM'ISHABLE, *a.* Not capable of being blemished.

UNBLEM'ISHABLY, *adv.* Without being blemishable.

UNBLEM'ISHED, *a.* Not blemished; not stained; free from turpitude or reproach; in a *moral sense*; as, an *unblemished* reputation or life.—2. Free from deformity.

UNBLENC'ED, *a.* Not disgraced; not injured by any stain or soil; as, *unblemched* majesty.

UNBLENC'H'ING, *a.* Not shrinking or finching; firm.

UNBLEND'ED, *a.* Not blended; not mingled.

UNBLESSED', } *a.* Not blest; excluded

UNBLEST', } from benediction.—2. Wretched; unhappy.

UNBLIGHTED, *a.* Not blighted; not blasted.

UNBLIGHTEDLY, *adv.* Without being blighted.

UNBLINDED, *a.* Not blinded.

UNBLOCKA'DED, *a.* Not blocked.

UNBLOOD'ED, } *a.* Not stained with UNBLOOD'IED, } blood.

UNBLOODY, *a.* Not stained with blood.—2. Not shedding blood; not cruel.

UNBLOS'SOMING, *a.* Not producing blossoms.

UNBLOT'TED, *a.* Not blotted.

UNBLOWN, *a.* Not blown; not having the bud expanded.—2. Not extinguished.—3. Not inflated with wind.

UNBLUNT'ED, *a.* Not made obtuse or dull; not blunted.

UNBLUSH'ING, *a.* Not blushing; destitute of shame; impudent.

UNBLUSH'INGLY, *adv.* In an impudent manner.

UNBOASTED, *a.* Not boasted.

UNBOASTFUL, *a.* Not boasting; unassuming; modest.

UNBOASTFULLY, *adv.* Without being boastful.

UNBOD'IED, *a.* Having no material body; incorporeal; as, *unbodied* spirits.—2. Freed from the body.

UNBOIL'ED, *a.* Not boiled; as, *unboiled* rice.

UNBOLT, *v. t.* To remove a bolt from; to unfasten; to open; as, to *unbolt* a gate.

UNBOLTED, *pp.* Freed from fastening by bolts.—2. *a.* Unsifted; not bolted; not having the bran or coarse part separated by a bolter; as, *unbolted* meal.

UNBOLTING, *pp.* Freeing from fastening by bolts.

UNBONED, *a.* Not boned.—2. *pp.* Deprived of bones.

UNBONNETED, *a.* Having no bonnet on.

UNBOOK'ISH, *a.* Not addicted to books or reading.—2. Not cultivated by erudition.

UNBOOT', *v. t.* To take off boots from.

UNBOOT'ED, *pp.* Stripped of boots.—2. *a.* Not having boots on.

UNBOOT'ING, *pp.* Taking off boots.

UNBORN', } *a.* [It is accented either UNBORN', } on the first or second syllable.] Not born; not brought into life; future.

Some *unborn* sorrow, ripe in fortune's womb. *Shak.*

The woes to come, the children yet *unborn* Shall feel this day. *Shak.*

UNBOR'ROWED, *a.* Not borrowed; genuine; original; native; one's own; as, *unborrowed* beauties; *unborrowed* gold; *unborrowed* excellence.

UNBOSOM, *v. t.* (*s* as *z*.) To disclose freely one's secret opinions or feelings.—2. To reveal in confidence.

UNBOSOMED, *pp.* Disclosed, as secrets; revealed in confidence.

UNBOSOMING, *pp.* Disclosing, as secrets; revealing in confidence.

UNBOT'TOMED, *a.* Having no bottom; bottomless.

The dark, *unbottomed*, infinite abyss. *Milton.*

2. Having no solid foundation.

UNBOUGHT, (*unbaut'*.) Not bought; obtained without money or purchase. The *unbought* dainties of the poor. *Dryden.*

2. Not having a purchaser.

UNBOUND', *a.* Not bound; loose; wanting a cover; as, *unbound* books.—2. Not bound by obligation or covenant.—3. *pret.* of *Unbind*.

UNBOUND'ED, *a.* Having no bound or limit; unlimited in extent; infinite; interminable; as, *unbounded* space; *unbounded* power.—2. Having no check or control; unrestrained. The young man has *unbounded* license. His extravagance is *unbounded*.

UNBOUND'EDLY, *adv.* Without bounds or limits.

UNBOUND'EDNESS, *n.* Freedom from bounds or limits.

UNBOUN'TEOUS, *a.* Not bounteous; not liberal.

UNBOW', *v. t.* To unbend.

UNBOW'ED, *a.* Not bent.

UNBOW'ED, *a.* Not arched.

UNBOW'EL, *v. t.* To deprive of the entrails; to eviscerate; to eviscerate; to embowel.

UNBOW'ELLED, *pp.* Eviscerated.

UNBOW'ELLING, *pp.* Taking out the bowels; embowelling.

UNBOX', *v. t.* To take out of a box.

UNBRACE, *v. t.* To loose; to relax; as, to *unbrace* a drum; to *unbrace* the arms; to *unbrace* the nerves.

UNBRACED, *pp.* Loosed; relaxed.

UNBRACING, *pp.* Loosing; relaxing.

UNBRAID, *v. t.* To separate the strands of a braid; to disentangle.

UNBRAIDED, *pp.* Disentangled, as the strands of a braid.

UNBRAIDING, *pp.* Separating the strands of a braid.

UNBRANCHED, *a.* Not ramified; not shooting into branches.

UNBRANCHING, *a.* Not dividing into branches.

UNBRAND'ED, *a.* Not branded.

UNBREAST', *v. t.* (*unbrest'*.) To disclose or lay open.

UNBREAST'ED, *pp.* Disclosed; laid open.

UNBREAST'ING, *pp.* Disclosing.

UNBREAT'HABLE, *a.* Not breathable or respirable.

UNBREATHED, *a.* Not exercised.

Our *unbreathed* memories. *Shak.*

UNBREATHING, *a.* Unanimated; as, *unbreathing* stones.

UNBRED', *a.* Not well bred; not polished in manners; ill educated; rude; as, *unbred* minds; *unbred* servants.—2. Not taught; as, *unbred* to spinning.

UNBREECHED, *a.* Having no breeches; loosed, as a ship from the breechings.

UNBREW'ED, *a.* Not mixed; pure; genuine.

UNBRIBABLE, *a.* That cannot be bribed.

UNBRIBED, *a.* Not bribed; not corrupted by money; not unduly influenced by money or gifts.

UNBRIDG'ED, *a.* Not furnished or crossed by a bridge; as, an *unbridged* stream.

UNBRID'DLE, *v. t.* To free from the bridle.

UNBRID'DLED, *pp.* Loosed from the bridle.—2. *a.* Unrestrained; licentious; as, *unbridled* lust; *unbridled* boldness; *unbridled* passions.

UNBRIGHTENED, *a.* Not brightened.

UNBROACH'ED, *a.* Not broached.

UNBROKE, } *a.* Not broken; not vio-

UNBROKEN, } lated. Preserve your vows *unbroken*.—2. Not weakened; not crushed; not subdued.

How broad his shoulders spread, by age *unbroke*. *Pope.*

3. Not tamed; not taught; not ac-

customed to the saddle, harness, or yoke; as, an *unbroken* horse or ox.

**UNBROTHERLY, a.** Not becoming a brother; not suitable to the character and relation of a brother; unkind. [*Unbrotherlike* is not used.]

**UNBRUISED, a.** (*s* as *z*.) Not bruised; not crushed or hurt.

**UNBRUSH'ED, a.** Not brushed.

**UNBUCK'LE, v. t.** To loose from, buckles; to unfasten; as, to *unbuckle* a shoe; to *unbuckle* a girdle; to *unbuckle* a helm.

**UNBUCK'LED, pp.** Loosed from buckles; unfastened.

**UNBUCK'LING, ppr.** Loosing from buckles; unfastening.

**UNBUILD, v. t.** To demolish what is built; to raze; to destroy.

**UNBUILT, a.** Not yet built; not erected.

**UNBUOY'ED, a.** Not buoyed or borne up.

**UNBURIED, a.** (unber'ried.) Not buried; not interred.

**UNBURN'ED, } a.** Not burnt; not  
**UNBURN'T, }**  consumed by fire.—  
2. Not injured by fire; not scorched.  
—3. Not baked, as brick.

**UNBURN'ING, a.** Not consuming away by fire.

**UNBUR'THEN, } v. t.** To rid of a load;  
**UNBUR'DEN, }**  to free from a burden; to ease.—2. To throw off.—3. To relieve the mind or heart by disclosing what lies heavy on it.

**UNBUR'THENE, } pp.** Freed from  
**UNBUR'DENED, }**  a load; thrown off; eased; relieved.

**UNBUR'DENSOME, a.** Not burdensome; not onerous.

**UNBUR'THENING, } ppr.** Freeing  
**UNBUR'DENING, }**  from a load or burden; relieving from what is a burden.

**UNBURY, v. t.** (unber'ry.) To disinter.

**UNBUSIED, a.** (unbiz'zied.) Not busied; not employed; idle.

**UNBUSINESSLIKE, a.** Not businesslike.

**UNBUSK'INED, a.** Not buskined.

**UNBUSY, a.** (unbiz'zy.) Not busy.

**UNBUT'TON, v. t.** To loose from being fastened by buttons; to loose buttons.

**UNBUT'TONED, pp.** Loosed from buttons.

**UNBUT'TONING, ppr.** Loosing from buttons.

**UNCAGE, v. t.** To loose from a cage.

**UNCAGED, pp.** Released from a cage or from confinement.

**UNCAL'CINED, a.** Not calcined.

**UNCAL'CULATED, a.** Not subjected to calculation.

**UNCAL'CULATING, a.** Not making calculations.

**UNCAL'CULATINGLY, adv.** Without calculation.

**UNCAL'LED, a.** Not called; not summoned; not invited.—*Uncalled for*, not required; not needed or demanded.

**UNCALM, a.** Not calm; not easy; as, a very *uncalm* patient.

**UNCALM,† v. t.** To disturb.

**UNCALUMNIATED, a.** Not calumniated or defamed.

**UNCAMP, v. t.** To cause to decamp; to dislodge; to expel.

**UNCAN'CELLABLE, a.** That cannot be cancelled.

**UNCAN'CELLED, a.** Not cancelled; not erased; not abrogated or annulled.

**UNCAN'DID, a.** Not candid; not frank or sincere; not fair or impartial.

**UNCANON'ICAL, a.** Not agreeable to the canons; not acknowledged as authentic.

**UNCANON'ICALLY, adv.** In an uncanonical manner.

**UNCANON'ICALNESS, n.** The state of being uncanonical.

**UNCAN'ONIZE, v. t.** To deprive of canonical authority.—2. To reduce from the rank of a canon or saint.

**UNCAN'ONIZED, a.** Not canonized.

**UNCAN'OPIED, a.** Not covered by a canopy.

**UNCAN'VASSED, a.** Not canvassed.

**UNCAP', v. t.** To remove a cap or cover; to open.

**UNCA'PABLE, a.** Incapable. [The latter word has superseded *uncapable*.]

**UNCAPE,† v. t.** In *ancient sports*, to prepare for pursuit, as by taking off a hawk's *cape* or hood; also, to unbag a fox; to throw off dogs, &c.

**UNCAP'PED, pp.** Opened.

**UNCAP'TIVATED, a.** Not captivated.

**UNCARED FOR, not** regarded; not heeded.

**UNCARESS'ED, a.** Not caressed.

**UNCA'RIA, n.** A genus of plants, nat. order Rubiaceæ. The species are chiefly natives of India, but a few are found in America. They are permanent cirriferous ramblers, hanging to different trees by the hooked old peduncles. The most important species is the *U. gambier*, a native of Penang,



Uncaria gambier.

Sumatra, Malacca, &c., which yields the substance called gambier or gambier by the Malays, and which is known in commerce by the names of *Terra japonica*, *catechu*, and *cutch*.

**UNCARNATE, a.** Not fleshy.

**UNCARPETED, a.** Not covered with a carpet.

**UNCARV'ED, a.** Not carved.

**UNCASE, v. t.** To disengage from a covering; to take off or out.—2. To flay; to strip.

**UNCASED, pp.** Stripped of a covering or case.

**UNCASING, ppr.** Disengaging from a cover.

**UNCAS'TRATED, a.** Not castrated.

**UNCATECHISED, a.** (*s* as *z*.) Not catechised; untaught.

**UNCAUGHT, a.** (uncant'.) Not yet caught or taken.

**UNCAUS'ED, a.** (*s* as *z*.) Having no precedent cause; existing without an author.

**UNCAU'TIOUS, a.** Not cautious; not wary; heedless. [*Incautious* is now generally used.]

**UNCAU'TIOUSLY, adv.** Without caution; incautiously. [*The latter is the word now used*.]

**UNCEASING, a.** Not ceasing; not intermitting; continual.

**UNCEASINGLY, adv.** Without intermission or cessation; continually.

**UNCEDED, a.** Not ceded; not granted or transferred.

**UNCELEBRATED, a.** Not celebrated; not solemnized.

**UNCELES'TIAL, a.** Not heavenly.

**UNCEMENT'ED, a.** Not cemented.

**UNCEN'SURABLE, a.** Not worthy of censure.

**UNCEN'SURABLY, adv.** In an unceusable manner.

**UNCEN'SURED, a.** Not censured; exempt from blame or reproach.

Whose right it is *uncensur'd* to be dull.  
Pope.

**UNCEN'TRICAL, a.** Not central; distant from the centre.

**UNCEREMO'NIAL, a.** Not ceremonial.

**UNCEREMO'NIOUS, a.** Not ceremonious; not formal.

**UNCEREMO'NIOUSLY, adv.** Without ceremony or form.

**UNCER'TAIN, a.** Not certain; doubtful; not certainly known. It is *uncertain* who will be the next president.—2. Doubtful; not having certain knowledge.

Man without the protection of a superior  
Being...is *uncertain* of every thing that he  
hopes for.  
Tillotson.

3. Not sure in the consequence.  
Or whistling slings dismiss'd the *uncertain*  
stone.  
Gay.

4. Not sure; not exact.  
Soon bent his bow, *uncertain* in his aim.  
Dryden.

5. Unsettled; irregular.

**UNCER'TAINLY, adv.** Not surely; not certainly.—2. Not confidently.

Standards that cannot be known at all,  
or but imperfectly and *uncertainly*.  
Locke.

**UNCER'TAINTY, n.** Doubtfulness; dubiousness. The truth is not ascertained; the latest accounts have not removed the *uncertainty*.—2. Want of certainty; want of precision; as, the *uncertainty* of the signification of words.—3. Contingency.

Steadfastly grasping the greatest and  
most slippery *uncertainties*.  
South.

4. Something unknown.

Our shepherd's case is every man's case  
that quits a certainty for an *uncertainty*.  
L'Estrange.

**UNCERTI'FICATED, a.** Having no certificate to show; as, an *uncertificated* bankrupt.

**UNCES'SANT, a.** Continual; incessant. [*The latter is the word now used*.]

**UNCES'SANTLY,† adv.** Incessantly.

**UNCHAIN, v. t.** To free from chains or slavery.

**UNCHAINED, pp.** Disengaged from chains, shackles, or slavery.

**UNCHAINING, ppr.** Freeing from chains, bonds, or restraint.

**UNCHAL'LENGEABLE, a.** That cannot be challenged.

**UNCHAL'LENGEABLY, adv.** So as to be unchallengeable.

**UNCHAL'LENGED, a.** Not challenged.—2. pp. Not having been challenged.

**UNCHANGEABLE, a.** Not capable of change; immutable; not subject to variation. God is an *unchangeable* being.

**UNCHANGEABLENESS, n.** The state or quality of being subject to no change; immutability.

**UNCHANGEABLY, adv.** Without change; immutably.

**UNCHANGED, a.** Not changed or altered.—2. Not alterable.

UNCHANGING, *a.* Not changing; suffering no alteration.  
 UNCHANGINGLY, *adv.* Without changing.  
 UNCHARACTERIS'TIC, } *a.* Not  
 UNCHARACTERIS'TICAL, } characteristic; not exhibiting a character.  
 UNCHARACTERIS'TICALLY, *adv.* Not in a characteristic manner.  
 UNCHARACTERIZED, *a.* Not characterized.  
 UNCHARGE,† *v. t.* To retract an accusation.  
 UNCHARGED, *a.* Not charged; not loaded.  
 UNCHAR'IOT, *v. t.* To throw out of a chariot.  
 UNCHAR'ITABLE, *a.* Not charitable; contrary to charity, or the universal love prescribed by Christianity; as, *uncharitable* opinions or zeal.  
 UNCHAR'ITABLENESS, *n.* Want of charity. If we hate our enemies we sin; we are guilty of *uncharitableness*.  
 UNCHAR'ITABLY, *adv.* In a manner contrary to charity.  
 UNCHARM, *v. t.* To release from some charm, fascination, or secret power.  
 UNCHARMED, *a.* Not charmed; not fascinated.  
 UNCHARMING, *a.* Not charming; no longer able to charm.  
 UNCHART'ED, *a.* Not described or delineated on a chart.  
 UNCHARTERED, *a.* Having no charter.  
 UNCHA'RY,† *a.* Not wary; not frugal.  
 UNCHASTE, *a.* Not chaste; not continent; not pure; libidinous; lewd.  
 UNCHASTE'LY, *adv.* Incontinently; lewdly.  
 UNCHAS'TENED, *a.* Not chastened.  
 UNCHASTISABLE, *a.* [See CHASTISE.] That cannot be chastised.  
 UNCHASTISED, *a.* Not chastised; not punished.—2. Not corrected; not restrained.  
 UNCHAS'TITY, *n.* Incontinence; lewdness; unlawful indulgence of the sexual appetite.  
 UNCHEATED, *a.* Not cheated.  
 UNCHECK'ED, *a.* Not checked; not restrained; not hindered.—2. Not contradicted.  
 UNCHEERED, *a.* Not cheered.  
 UNCHEERFUL, *a.* Not cheerful; sad.  
 UNCHEERFULLY, *adv.* In an uncheerful manner.  
 UNCHEERFULNESS, *n.* Want of cheerfulness; sadness.  
 UNCHERY, *a.* Dull; not enlivening.  
 UNCHECK'ERED, } *a.* Not checked;  
 UNCHECK'ERED, } not diversified.  
 UNCHEW'ED, *a.* Not chewed or masticated.  
 UNCHIDED, *a.* Not chided or rebuked.  
 UNCHILD,† *v. t.* To bereave of children.  
 UNCHIV'ALROUS, *a.* Not according to the rules of chivalry.  
 UNCHIV'ALROUSLY, *adv.* In a manner the reverse of chivalric; ungenerously.  
 UNCHOL'ERIC, *a.* Not choleric.  
 UNCHRIS'TEN, *v. t.* To annul baptism.  
 UNCHRIS'TENED, *a.* Not baptized and named.  
 UNCHRIS'TIAN, *a.* Contrary to the laws of Christianity; as, an *unchristian* reflection; *unchristian* temper or conduct.—2. Not evangelized; not converted to the Christian faith; infidel.  
 UNCHRIS'TIAN, *v. t.* To deprive of the constituent qualities of Christianity.  
 UNCHRIS'TIANIZE, *v. t.* To turn from the Christian faith; to cause to

degenerate from the belief and profusion of Christianity.  
 UNCHRIS'TIANIZED, *pp.* Not christianized.  
 UNCHRIS'TIAN-LIKE, *a.* Not like a Christian.  
 UNCHRIS'TIANLY, *a.* Contrary to the laws of Christianity; unbecoming Christians.  
 UNCHRIS'TIANLY, *adv.* In a manner contrary to christian principles.  
 UNCHRIS'TIANNESS, *n.* Contrariety to Christianity.  
 UNCHRON'ICLED, *a.* Not recorded in a chronicle.  
 UNCHURCH, *v. t.* To expel from a church; to deprive of the character and rights of a church.  
 UNCHURCH'ED, *pp.* Expelled from a church.  
 UNCHURCH'ING, *ppr.* Expelling from a church.  
 UN'CIA, *n.* [L.] The twelfth part of any thing; an ounce, as being the twelfth part of the Roman *As*.—2. Among old writers on Algebra, a term used to signify the numerical coefficient of an Algebraical letter or term.  
 UN'CIAL, *a.* [L. *uncialis*.] Pertaining to letters of a large size, used in ancient Latin manuscripts, and known by the name of *Unciales literæ*. These letters were compounded between the capital and minuscule or small character, some of the letters resembling the former, others the latter. Several ancient manuscripts of the bible, or of parts of it, are written in uncial letters.  
 UN'CIAL, *n.* An uncial letter.—2. A letter that stands for a word in inscriptions, epitaphs, &c., as C. for Corsul.  
 UN'CIFORM, *a.* [L. *uncus*, a hook, and *forma*, form.] Hook-like, having a curved or hooked form.—*Unciform bone*, in *anat.*, the last bone of the second row of the carpus or wrist, so named from its hook-like process which projects towards the palm of the hand, and gives origin to the great ligament by which the tendons of the wrist are bound down.  
 UN'CINATE, *a.* [L. *uncinatus*, from *uncus*, a hook.] In *bot.* hooked at the end, as an awn.  
 UNCIN'TURED, *a.* Not cinctured.—2. *pp.* Deprived of a cincture.  
 UNCIR'ULAR, *a.* Not circular or spherical.  
 UNCIR'UMCISED, *a.* (*s* as *z*.) Not circumcised.  
 UNCIRCUMCIS'ION, *n.* Absence or want of circumcision.—2. In *scrip.*, the Gentiles who did not practice circumcision; Rom. iv. 9.  
 UNCIRCUMSCRIBED, *a.* Not circumscribed; not bounded; not limited.  
 Where the prince is *uncircumscribed*, obedience ought to be unlimited. *Addition*.  
 UNCIR'UMSPECT, *a.* Not circumspect; not cautious.  
 UNCIR'UMSPECTLY, *adv.* Without circumspection.  
 UNCIRCUMSTAN'TIAL,† *a.* Not important.  
 UNCIT'ED, *a.* Not summoned; not quoted.  
 UNCIV'IL, *a.* Not civil; not complimentary; not courteous in manners; *applied to persons*.—2. Not polite; rude; *applied to manners*; as, *uncivil* behaviour.  
 UNCIVILIZA'TION, *n.* A state of savageness; rude state.  
 UNCIVILIZED, *a.* Not reclaimed from

savage life; as, the *uncivilized* inhabitants of Canada or New Zealand.—2.† Coarse; indecent; as, the most *uncivilized* words in our language.  
 UNCIVILLY, *adv.* Not complaisantly; not courteously; rudely.  
 UNCLAD, *a.* Not clad; not clothed.  
 UNCLAIMED, *a.* Not claimed; not demanded; not called for; as, *unclaimed* dividends of a bank.  
 UNCLAR'IFIED, *a.* Not purified; not fined; not depurated by a separation of feculent or foreign matter.  
 UNCLASP, *v. t.* To loose a clasp; to open what is fastened with a clasp; as, to *unclasp* a book.  
 UNCLÄSPING, *ppr.* Loosing a clasp.  
 UNCLASS'IC, } *a.* Not classic; not  
 UNCLASS'ICAL, } according to the best models of writing.—2. Not pertaining to the classic writers; as, *unclassic* ground.  
 UNCLASS'ICALLY, *adv.* Not according to the classics.  
 UN'CLE, *n.* [Fr. *oncle*; contracted from L. *avunculus*.] The brother of one's father or mother. It is also applied to the husband of one's aunt.  
 UNCLEAN, *a.* Not clean; foul; dirty; filthy.—2. In the *Jewish law*, ceremonially impure; not cleansed by ritual practices; Num. xix; Lev. xi; Rom. xiv.—3. Foul with sin; Matth. x.  
 That holy place where no *unclean* thing shall enter.  
 Rogers.  
 4. Not in covenant with God; 1 Cor. vii.—5. Lewd; unchaste.  
 Adultery of the heart, consisting of inordinate and *unclean* affections. Perkins.  
 No *unclean* person...hath any inheritance in the kingdom of Christ and of God; Eph. v.  
 UNCLEANABLE, *a.* That cannot be cleansed.  
 UNCLEANLINESS, *n.* (uncle'n'liness.) Want of cleanliness; filthiness.  
 UNCLEANLY, *a.* (uncle'n'ly.) Foul; filthy; dirty.—2. Indecent; unchaste; obscene.  
 It is a pity that these harmonious writers have indulged any thing *uncleanly* or impure to defile their paper. Watts.  
 UNCLEANNESS, *n.* Foulness; dirtiness; filthiness.  
 Be not troublesome to thyself or to others by *uncleanness*. Taylor.  
 2. Want of ritual or ceremonial purity; Lev. xv.—3. Moral impurity; defilement by sin; sinfulness.  
 I will save you from all your *uncleanness*; Ezek. xxxvi.  
 4. Lewdness; incontinence; Col. iii.; 2 Pet. ii.  
 UNCLEANSED, *a.* (uncle'nz'ed.) Not cleansed; not purified.  
 UNCLEAR'ED, *a.* Not cleared, as, *uncleared* land.—2. Not expurgated; as, his character remains *uncleared*.  
 UNCLEAVABLE, *a.* That cannot be cleaved, split, or divided.  
 UN'CLE SAM, *n.* The name given trivially, in North America, to the men of the United States, as supposed to be embodied in an individual imaginary representative; just as one John Bull is fabled to represent the English people. The word is a sportive extension of the initials *U. S.* or *United States*. [N. B. The Americans "repudiate" the appellation *Brother Jonathan*.]  
 UNCLER'ICAL, *a.* Not befitting the clergy; not clerical in nature; as an *unclerical* style of language, manners, or appearance.

UNCLEW', *v. t.* To undo; to unwind; unfold or untie.

UNCLEW'ED, *pp.* Undone; unwound; or untied.

UNCLINCH', *v. t.* To open the closed hand; as, to *unclinch* the fist.

UNCLINCH'ED, *pp.* Opened; unclosed.

UNCLIPP'ED, *a.* Not clipped: not cut; not diminished or shortened by clipping; as, *unclipped* money; *unclipped* hair.

UNCLOAK', *v. t.* To deprive of the cloak.—*v. i.* To take off one's cloak; as, where do we *uncloak*?

UNCLOAK'ED, *pp. or a.* Not cloaked; rid of the cloak.

UNCLOAK'ING, *ppr.* Taking off the cloak.

UNCLOG', *v. t.* To disincumber of difficulties and obstructions; to free from incumbrances, or any thing that retards motion.

UNCLOG'GED, *pp. or a.* Disincumbered; set free from obstructions.

UNCLOG'GING, *ppr.* Disincumbering.

UNCLOIS'TER, *v. t.* To release from a cloister or from confinement; to set at liberty.

UNCLOIS'TERED, *pp.* Released from a cloister or from confinement.

UNCLOIS'TERING, *ppr.* Releasing from confinement.

UNCLOSE, *v. t. (s as z.)* To open; to break the seal of; as, to *unclose* a letter.—2. To disclose; to lay open.

UNCLOSED, *pp.* Opened.—2. *a.* Not separated by inclosures; open.—3. Not finished; not concluded.—4. Not closed; not sealed.

UNCLOSING, *ppr.* Opening; breaking the seal of.

UNCLOTHE, *v. t.* To strip of clothes; to make naked; to divest.

To have a distinct knowledge of things, we must *unclothe* them *Watts.*

UNCLOTH'ED, *pp.* Stripped of clothing or covering.

Not for that we would be *unclothed*, but clothed upon; 2 Cor. v.

2. *a.* Not clothed; wanting clothes. UNCLOTH'EDLY, *adv.* Without clothing.

UNCLOTHING, *ppr.* Stripping of clothing.—2. *n.* Act of taking off clothes.

UNCLOUD', *v. t.* To unveil; to clear from obscurity or clouds.

UNCLOUD'ED, *a.* Not cloudy; free from clouds; clear; as, an *unclothed* sky.—2. Not darkened; not obscured.

UNCLOUD'EDNESS, *n.* Freedom from clouds; clearness.—2. Freedom from obscurity or gloom.

UNCLOUD'ING, *ppr.* Clearing from clouds or obscurity.

UNCLOUD'Y, *a.* Not cloudy; clear; free from clouds, obscurity, or gloom.

UNCLUTCH', *v. t.* To open something closely shut.

*Unclutch* his griping hand.

*Decay of Piety.*

UN'CO, *a.* Unknown; strange; unusual. [*Scotch.*]

UN'CO, *adv.* Very; as, *unco* glad. [*Scotch.*]

UNCOAG'ULABLE, *a.* That cannot be coagulated.

UNCOAG'ULATED, *a.* Not coagulated or conereted.

UNCOATED, *a.* Not coated; not covered with a coat.

UNCOCK', *v. t.* To let down; as the hammer of a gun; or the brim flaps of a cocked hat.—2. To reinstate that which is cocked.

UNCOCK'ED, *a.* Not cocked; as, a gun.—2. Not made into cocks; as, hay.—3. Not set up; as, the brim of a hat.

UNCOFF'INED, *a.* Not furnished with a coffin; not put into a coffin.

UNCO'GENT, *a.* Not cogent or forcible.

UNCOIF', *v. t.* To pull the cap off.

UNCOIF'ED, *a.* Not wearing a coif.

UNCOIL', *v. t.* To unwind or open, as the turns of a rope or other line.

UNCOIL'ED, *pp.* Opened; unwound.

UNCOIL'ING, *ppr.* Opening; unwinding.

UNCOIN'ED, *a.* Not coined; as, *uncoined* silver.

UNCOLLAT'ED, *a.* Not collated.

UNCOLLECT'ED, *a.* Not collected; not received; as, *uncollected* taxes; debts *uncollected*.—2. Not collected; not recovered from confusion, distraction or wandering; as, the mind yet *uncollected*.

UNCOLLECT'EDNESS, *n.* A state of not being collected.

UNCOLLECT'IBLE, *a.* Not collectible; that cannot be collected or levied, or paid by the debtor; as, *uncollectible* taxes, *uncollectible* debts.

UNCOLOURED, *a.* Not coloured; not stained or dyed.—2. Not heightened in description.

UNCOMBED, *a.* Not combed; not dressed with a comb.

UNCOMBINABLE, *a.* Not capable of combining or of being combined.

UNCOMBINABLY, *adv.* In an uncombining manner.

UNCOMBINED, *a.* Not combined; separate; simple.

UNCOMEAT'ABLE, *a.* Not attainable; not obtainable. [*Trivial.*]

UNCOMELINESS, *n.* Want of comeliness; want of beauty or grace; as, *uncomeliness* of person, of dress, or behaviour.

UNCOMELY, *a.* Not comely; wanting grace; as, an *uncomely* person; *uncomely* dress; *uncomely* manners.—2. Unseemly; unbecoming; unsuitable.

UNCOMFORTABLE, *a.* Affording no comfort; gloomy.

Christmas...the most *uncomfortable* time of the year. *Addison.*

2. Giving uneasiness; as, an *uncomfortable* seat or condition.

UNCOMFORTABLENESS, *n.* Want of comfort or cheerfulness.—2. Uneasiness.

UNCOMFORTABLY, *adv.* In an uncomfortable manner; without comfort or cheerfulness; in an uneasy state.

UNCOMMANDED, *a.* Not commanded; not required by precept, order, or law; as, *uncommanded* austerities.

UNCOMMEMORATED, *a.* Not commemorated.

UNCOMMEND'ABLE, *a.* Not commendable; not worthy of commendation; illaudable.

UNCOMMEND'ED, *a.* Not praised; not commended.

UNCOMMER'CIAL, *a.* Not commercial; not carrying on commerce.

UNCOMMER'CIALLY, *adv.* Not according to commercial usage.

UNCOMMIS'ERATED, *a.* Not commiserated; not pitied.

UNCOMMIS'SIONED, *a.* Not commissioned; not having a commission.

UNCOMMIT'TED, *a.* Not committed. 2. Not referred to a committee.—3. Not pledged by any thing said or done.

UNCOMMON, *a.* Not common; not usual; rare; as, an *uncommon* season; an *uncommon* degree of cold or heat; *uncommon* courage.—2. Not frequent;

not often seen or known; as, an *uncommon* production.—*Uncommon chord* in music, the chord of the sixth, so named to distinguish it from the *common chord*, in which the lowest note is the fundamental bass.

UNCOMMONLY, *adv.* Rarely; not usually.—2. To an uncommon degree.

UNCOMMONNESS, *n.* Rareness of occurrence; infrequency. The *uncommonness* of a thing often renders it valuable.

UNCOMMUNICATED, *a.* Not communicated; not disclosed or delivered to others.—2. Not imparted to or from another; as, the *uncommunicated* perfections of God.

UNCOMMUNICATING, *a.* Not making communication.

UNCOMMUNICATIVE, *a.* Not communicative; not free to communicate to others; reserved.

UNCOMPACT', *a.* Not compact; not firm; not of close texture; loose. [*Incompact is now used.*]

UNCOMPACT'ED, *a.* Not compact; not firm. [*Incompact is now used.*]

UNCOMPACT'EDLY, *adv.* Not compactedly.

UNCOMPAN'IED, *a.* Having no companion. [*Unaccompanied* is mostly used.]

UNCOMPAN'IONABLE, *a.* Not companionable or sociable.

UNCOMPAS'SIONATE, *a.* Not compassionate; having no pity.

UNCOMPAS'SIONED, *a.* Not pitied.

UNCOMPAT'IBLY, *adv.* Incompatibly.

UNCOMPEL'ABLE, *a.* Not compelling; that cannot be forced or compelled.

UNCOMPEL'ED, *a.* Not forced; free from compulsion.

UNCOMPEN'SATED, *a.* Not compensated; unrewarded.

UNCOMPLAINING, *a.* Not complaining; not murmuring; not disposed to murmur.

UNCOMPLAININGLY, *adv.* Without complaining.

UNCOMPLAININGNESS, *n.* An uncomplaining state.

UNCOMPLAISANT', *a. (s as z.)* Not complaisant; not civil; not courteous.

UNCOMPLAISANT'LY, *adv.* Uncivily; discourteously.

UNCOMPLETE, *a.* Not complete; not finished; not perfect. [*But incomplete is chiefly used.*]

UNCOMPLETED, *a.* Not finished; not completed.

UNCOMPLICATED, *a.* Not complicated; simple.

UNCOMPLIMENT'ARY, *a.* Not complimentary.

UNCOMPLY'ING, *a.* Not complying; not yielding to request or command; unbending.

UNCOMPOS'ED, *a.* Not composed; restless.

UNCOMPOUND'ED, *a.* Not compounded; not mixed.

Hardness may be reckoned the property of all *uncompounded* matter. *Newton.*

2. Simple; not intricate.

UNCOMPOUND'EDLY, *adv.* Without being compounded.

UNCOMPOUND'EDNESS, *n.* Freedom from mixture; simplicity of substance.

UNCOMPREHEND'ED, *a.* Not comprehended.

UNCOMPREHENS'IVE, *a.* Not comprehensive.—2. Unable to comprehend. [*Incomprehensive is now used.*]

## UNCONDITIONAL

UNCOMPRESS'ED, *a.* Not compressed; free from compression.

UNCOMPROMIS'ED, *a.* Not compromised.

UNCOMPROMISING, *a.* (*s as z.*) Not compromising; not agreeing to terms; not complying.

UNCOMPROMISINGLY, *adv.* Without compromise.

UNCONCEALABLE, *a.* Not concealable.

UNCONCEALED, *a.* Not concealed. UNCONCEIVABLE, *a.* Not to be conceived or understood; that cannot be comprehended. [But *inconceivable* is chiefly used.]

UNCONCEIVABLENESS, *n.* The state or quality of being inconceivable. [Little used.]

UNCONCEIVED, *a.* Not thought; not imagined.

UNCONCERN', *n.* Want of concern; absence of anxiety; freedom from solicitude.

UNCONCERN'ED, *a.* Not concerned; not anxious; feeling no solicitude. He is *unconcerned* at what has happened. He is *unconcerned about* or *for* the future.

Happy mortals, *unconcerned* for more.  
*Dryden.*

[It has *at* sometimes before a past event, but *about* or *for* is more generally used before a past or future event.]—2. Having no interest in. He is *unconcerned* in the events of the day.

UNCONCERN'EDLY, *adv.* Without interest or affection; without anxiety.

And *unconcern'dly* cast his eyes around.  
*Dryden.*

UNCONCERN'EDNESS, *n.* Freedom from concern or anxiety.

UNCONCERN'ING, *† a.* Not interesting; not affecting; not belonging to one.

UNCONCERN'MENT, *† n.* The state of having no share.

UNCONCERT'ED, *a.* Not concerted.

UNCONCILIATED, *a.* Not reconciled.

UNCONCILIATING, *a.* Not conciliating; not adapted or disposed to gain favour, or to reconciliation.

UNCONCILIATORY, *a.* Not tending to conciliate.

UNCONCLU'DED, *a.* Not concluded.

UNCONCLU'DIBLE, *† a.* Not determinable.

UNCONCLU'DING, } *a.* Not decisive;  
UNCONCLU'DENT, } not inferring a plain or certain conclusion or consequence. [Little used.] [In the place of these, *inconclusive* is generally used.]

UNCONCLU'DINGNESS, *† n.* Quality of being inconclusive.

UNCONCLU'SIVE, *a.* Not decisive. [But *inconclusive* is now used.]

UNCONCOCT'ED, *a.* Not concocted; not digested.

UNCONDEMN'ED, *a.* Not condemned; not judged guilty.

A man that is a Roman and *uncondemned*; Acts xxii.

2. Not disapproved; not pronounced criminal; as, a practice yet *uncondemned*.

UNCONDENS'ABLE, *a.* That cannot be condensed.

UNCONDENS'ABLENESS, *n.* A state of being incapable of condensation.

UNCONDENS'ED, *a.* Not condensed.

UNCONDI'TIONAL, *a.* Absolute; unreserved; not limited by any conditions. We are required to make an *unconditional* surrender of ourselves

## UNCONNECTED

to our Maker. The king demanded *unconditional* submission.

O pass not, Lord, an absolute decree, Or bind thy sentence *unconditional*.

*Dryden.*

UNCONDI'TIONALLY, *adv.* Without conditions; without terms of limitation; without reservation. The troops did not surrender *unconditionally*, but by capitulation.

UNCONDUCTING, *a.* Not leading to.

UNCONDUCT'ED, *a.* Not led; not guided.

UNCONFESS'ED, *a.* Not confessed; not acknowledged.

UNCONFES'SING, *a.* Not making confession.

UNCONFINABLE, *† a.* Unbounded.—2. That cannot be confined or restrained.

UNCONFINED, *a.* Not confined; free from restraint; free from control.—2. Having no limits; illimitable; unbounded.

UNCONFINEDLY, *adv.* Without confinement or limitation.

UNCONFIRM'ED, *a.* Not fortified by resolution; weak; raw; as, troops *unconfirmed* by experience.—2. Not confirmed; not strengthened by additional testimony.

His witness *unconfirm'd*. *Milton.*

3. Not confirmed according to the church ritual.

UNCONFORM, *† a.* Unlike; dissimilar; not analogous.

UNCONFORMABLE, *a.* Not consistent; not agreeable; not conforming.

Moral evil is an action *unconformable* to the rule of our duty. *Watts.*

2. In *geol.*, a term applied to strata whose planes do not lie parallel with those of the subjacent strata, but have a different line of direction or inclination. When the planes of one set of strata are generally parallel to those of another which are in contact, the two sets are said to be *conformable*.

UNCONFORM'ABLY, *adv.* In an unconformable manner. In *geol.*, strata are said to rest *unconformably* upon other strata, when the former set have not the same direction or inclination as the latter.

UNCONFORM'ED, *a.* Not conformed.

UNCONFORM'ITY, *n.* Incongruity; inconsistency; want of conformity.

UNCONFOUND'ED, *a.* Not confounded.

UNCONFOUND'EDLY, *adv.* Without being confounded.

UNCONFUSED, *a.* (*s as z.*) Free from confusion or disorder.—2. Not embarrassed.

UNCONFUSEDLY, *adv.* (*s as z.*) Without confusion or disorder.

UNCONFUTABLE, *a.* Not confutable; not to be refuted or overthrown; that cannot be disproved or convicted of error; as, an *unconfutable* argument.

UNCONFUT'ED, *a.* Not confuted.

UNCONGEALABLE, *a.* Not capable of being congealed.

UNCONGEALED, *a.* Not frozen; not congealed; not concreted.

UNCONGENIAL, *a.* Not congenial.

UNCONJOIN'ED, *a.* Not conjoined.

UNCONJUGAL, *a.* Not suitable to matrimonial faith; not befitting a wife or husband.

UNCONJUNCTIVE, *a.* That cannot be joined. [Little used.]

UNCONNECT'ED, *a.* Not connected; not united; separate.—2. Not coherent; not joined by proper transitions or

## UNCONSTITUTIONAL

dependence of parts; loose; vague; desultory; as, an *unconnected* discourse.

UNCONNECT'EDLY, *adv.* Without connection; incoherently.

UNCONNVING, *a.* Not conniving; not overlooking or winking at.

UNCONQUERABLE, *a.* Not conquerable; invincible; that cannot be vanquished or defeated; that cannot be overcome in contest; as, an *unconquerable* foe.—2. That cannot be subdued and brought under control; as, *unconquerable* passions or temper.

UNCONQUERABLENESS, *n.* State of being unconquerable; invincibility.

UNCONQUERABLY, *adv.* Invincibly; insuperably; as, foes *unconquerably* strong.

UNCONQUERED, *a.* Not vanquished or defeated.—2. Unsubdued; not brought under control.—3. Invincible; insuperable.

UNCONSCIENTIOUS, *a.* Not conscientious; not regulated or limited by conscience.

UNCONSCIONABLE, *a.* Unreasonable; exceeding the limits of any reasonable claim or expectation; as, an *unconscionable* request or demand.—2. Forming unreasonable expectations. You cannot be so *unconscionable* as to expect this sacrifice on my part.—3. Enormous; vast; as, *unconscionable* size or strides. [Not elegant.]—4. Not guided or influenced by conscience.

UNCONSCIONABLENESS, *n.* Unreasonableness of hope or claim.

UNCONSCIONABLY, *adv.* Unreasonably; in a manner or degree that conscience and reason do not justify.

UNCONSCIOUS, *a.* Not conscious; having no mental perception; as, *unconscious* causes.—2. Not conscious; not knowing; not perceiving; as, *unconscious* of guilt or error.

UNCONSCIOUSLY, *adv.* Without perception; without knowledge.

UNCONSCIOUSNESS, *n.* Want of perception; want of knowledge.

UNCONSECRATE, *† v. t.* To render not sacred; to desecrate.

UNCONSECRATED, *a.* Not consecrated; not set apart for a sacred use by religious ceremonies; not dedicated or devoted; as, a temple *unconsecrated*; *unconsecrated* bread.

UNCONSECRATEDNESS, *n.* A state of being unconsecrated.

UNCONSENTED TO, Not consented to; not yielded; not agreed to.

UNCONSENT'ING, *a.* Not consenting; not yielding consent.

UNCONSID'ERED, *a.* Not considered; not attended to.

UNCONSID'ERING, *a.* Not considering.

UNCONSOLED, *a.* Not consoled; not comforted.

UNCONSOLIDATED, *a.* Not consolidated or made solid.

UNCONSOLING, *a.* Not consoling; affording no comfort.

UNCONSONANT, *a.* Not consonant; not consistent; incongruous; unfit.

UNCONSPIC'UOUS, *a.* Not open to the view; inconspicuous.

UNCONSPIRINGNESS, *† n.* Absence of plot or conspiracy.

UNCONSTANT, *a.* Not constant; not steady or faithful; fickle; changeable. [Inconstant is now used.]

UNCONSTITUTIONAL, *a.* Not agreeable to the constitution; not authorized by the constitution; contrary to the principles of the constitution. It

is not *unconstitutional* for the king of Great Britain to declare war without the consent of parliament; but for the king to impose a tax on his subjects without an act of parliament authorizing it, would be *unconstitutional*.

**UNCONSTITUTIONALITY, n.** The quality of being unauthorized by the constitution, or contrary to its provisions or principles.

**UNCONSTITUTIONALLY, adv.** In a manner not warranted by or contrary to the laws, principles, and usages of the constitution.

**UNCONSTRAINED, a.** Free from constraint; acting voluntarily; voluntary.—2. Not proceeding from constraint; as actions.

**UNCONSTRAINEDLY, adv.** Without force or constraint; freely; spontaneously; voluntarily.

**UNCONSTRAINT, n.** Freedom from constraint; ease.

**UNCONSULT'ED, a.** Not asked or consulted.

**UNCONSULT'ING, a.** Taking no advice; rash; imprudent.

**UNCONSUMED, a.** Not consumed; not wasted, expended, or dissipated; not destroyed.

**UNCONSUMING, a.** Not consuming.

**UNCONSUMMATE, a.** Not consummate.

**UNCONSUMMATED, pp.** Not consummated.

**UNCONTAMINATED, } a.** Not contaminated; } taminated; }  
**UNCONTAMINATE, }** not contaminate.

**UNCONTEM'NED, a.** Not despised; not contemned.

**UNCONTEMPLATED, a.** Not contemplated.

**UNCONTENT'ED, a.** Not disputed. *Uncontented for*, not contended for; not urged for.

**UNCONTENT'ING, a.** Not contending; not contesting; not disputing.

**UNCONTENT'ED, † a.** Not contented; not satisfied. [*Discontented* is the word now in use.]

**UNCONTENT'INGNESS, † n.** Want of power to satisfy.

**UNCONTEST'ABLE, a.** Indisputable; not to be controverted. [*Incontestible* is the word now used.]

**UNCONTEST'ED, a.** Not contested; not disputed.—2. Evident; plain.

**UNCONTRADICT'ABLE, a.** That cannot be contradicted.

**UNCONTRADICT'ED, a.** Not contradicted; not denied.

**UNCON'TRITE, a.** Not contrite; not penitent.

**UNCONTRIVED, a.** Not contrived; not formed by design.

**UNCONTRIVING, a.** Not contriving; imprevient.

**UNCONTROLLABLE, a.** That cannot be controlled; ungovernable; that cannot be restrained; as, an *uncontrollable* temper; *uncontrollable* subjects.—2. That cannot be resisted or diverted; as, *uncontrollable* events.—3. Indisputable; irrefragable; as, an *uncontrollable* maxim; the king's *uncontrollable* title to the English throne.

**UNCONTROLLABLY, adv.** Without power of opposition.—2. In a manner or degree that admits of no restraint or resistance; as, a stream *uncontrollably* violent.

**UNCONTROLLED, a.** Not governed; not subjected to a superior power or authority; not restrained.—2. Not resisted; unopposed.—3. Not convinced; not refuted. [*Unusual*.]

**UNCONTROLLEDLY, adv.** Without control or restraint; without effectual opposition.

**UNCONTROVERTED, a.** Not disputed; not contested; not liable to be called in question.

**UNCONVERS'ABLE, a.** Not free in conversation; not social; reserved.—2. Not suited to conversation.

**UNCON'VERSANT, a.** Not conversant; not familiarly acquainted with.

**UNCONVERS'ION, n.** The state of being unconverted.

**UNCONVERT'ED, a.** Not converted; not changed in opinion; not turned from one faith to another.—2. Not persuaded of the truth of the Christian religion; as, *unconverted* pagans.—3. Not renewed; not regenerated; not having the natural enmity of the heart subdued, and a principle of grace implanted.—4. Not turned or changed from one form to another.

**UNCONVERT'IBLE, a.** That cannot be converted or changed in form. Lead is *unconvertible* into silver.

**UNCONVIC'TED, a.** Not convicted.

**UNCONVIN'CED, a.** Not convinced; not persuaded.

**UNCONVIN'ING, a.** Not sufficient to convince.

**UNCONVULS'ED, a.** Not convulsed.

**UNCOOK'ED, a.** Not cooked.

**UNCOP'iable, a.** That cannot be copied.

**UNCORD', v. t.** To loose from cords; to unfasten or unbind; as, to *uncord* a bed; to *uncord* a package.

**UNCORD'ED, pp.** Loosed from cords; unbound.

**UNCOR'DIAL, a.** Not cordial; not hearty.

**UNCOR'DING, ppr.** Unfastening; unbinding.

**UNCORK', v. t.** To draw the cork from; as, to *uncork* a bottle.

**UNCORK'ED, pp.** Not having the cork drawn.

**UNCORK'ING, ppr.** Drawing the cork from.

**UNCOR'ONETTED, a.** Not honoured with a coronet or title.

**UNCORP'ULENT, a.** Not corpulent; not fleshy.

**UNCORRECT'ED, a.** Not corrected; not revised; not rendered exact; as, an *uncorrected* copy of a writing.—2. Not reformed; not amended; as, life or manners *uncorrected*.

**UNCOR'RIGIBLE, a.** That cannot be corrected; deprived beyond correction. [For this, *incorrigible* is now used.]

**UNCORROB'ORATED, a.** Not confirmed.

**UNCORROD'ED, a.** Not corroded.

**UNCORRUPT', a.** Not corrupt; not depraved; not perverted; not tainted with wickedness; not influenced by iniquitous interest; as, an *uncorrupt* judgment; *uncorrupt* manners.

**UNCORRUPT'ED, a.** Not corrupted; not vitiated; not depraved; as, the dictates of *uncorrupted* reason; *uncorrupted* records.

**UNCORRUPT'EDNESS, n.** State of being uncorrupted.

**UNCORRUPT'IBLE, a.** That cannot be corrupted. [But *incorruptible* is the word now used.]

**UNCORRUPT'LY, adv.** With integrity; honestly.

**UNCORRUPT'NESS, n.** Integrity; uprightness; Tit. ii.

**UN'COS, n. plur.** News; strangers. [*Scotch*.]

**UNCOUN'SELLABLE, a.** Not to be

advised; not consistent with good advice or prudence.

**UNCOUN'SELLED, a.** Not having counsel or advice.

**UNCOUNT'ABLE, a.** That cannot be counted; innumerable.

**UNCOUNT'ED, a.** Not counted; not numbered.

**UNCOUNT'ENANCED, a.** Not encouraged.

**UNCOUNTERACT'ED, a.** Not counteracted; not effectually opposed.

**UNCOUNTERFEIT', a.** Not counterfeit; not spurious; genuine; as, *uncounterfeit* zeal.

**UNCOUNTERFEITED, a.** Not counterfeited.

**UNCOUNTERM'ANDED, a.** Not countermanded.

**UNCOUPLE, v. t. (uncup'pl.)** To loose dogs from their couples; to set loose; to disjoin.

**UNCOUPLED, pp. (uncup'pled.)** Disjoined; set free.

**UNCOUPLING, ppr. (uncup'pling.)** Disuniting; setting free.

**UNCOURT'ED, a.** Not courted; not wooed.

**UNCOUR'TEOUS, a.** Uncivil; unpolite; not kind and complaisant.

**UNCOUR'TEOUSLY, adv.** Uncivilly; unpolitely.

**UNCOUR'TEOUSNESS, n.** Incivility; disobliging treatment.

**UNCOURTLINESS, n.** Unsuitableness of manners to a court; inelegance; as, *uncourtliness* of manners or phrases.

**UNCOURTLY, a.** Inelegant in manners; not becoming a court; not refined; not polite; as, *uncourtly* behaviour or language.—2. Not courteous or civil; as, an *uncourtly* speech.—3. Not versed in the manners of a court.

**UNCOUTH, a.** [*Sax. uncuth*, unknown ] Odd; strange; unusual; not rendered pleasing by familiarity; as, an *uncouth* phrase or expression; *uncouth* manners; *uncouth* dress.

**UNCOUTH-LOOKING, a.** Having uncouth looks.

**UNCOUTHLY, adv.** Oddly; strangely.

**UNCOUTHNESS, n.** Oddness; strangeness; want of agreeableness derived from familiarity; as, the *uncouthness* of a word or of dress.

**UNCOVENANT'ED, a.** Not promised by covenant; not resting on a covenant or promise.

**UNCOVER, v. t.** To divest of a cover; to remove any covering from; a *word of general use*.—2. To deprive of clothes; to strip; to make naked.—3. To unroof, as a building.—4. To take off the hat or cap; to bare the head in token of respect.—5. To strip off a veil or off any thing that conceals; to lay open; to disclose to view.

**UNCOVERED, pp.** Divested of a covering or clothing; laid open to view; made bare.

**UNCOVERING, ppr.** Divesting of a cover or of clothes; stripping of a veil; laying open to view.

**UNCOWL', v. t.** To deprive of a cowl.

**UNCOWL'ED, pp.** Deprived of a cowl.

**UNCRAMP'ED, a.** Not cramped; not confined or fettered; free from constraint.

**UNCREAT'ABLE, a.** That cannot be created.

**UNCREATE, v. t.** To annihilate; to deprive of existence.

Who can *uncreate* thee, thou shalt know.

*Milton.*

**UNCREA'TED, pp.** Reduced to nothing; deprived of existence.—2. *a.* Not yet



created; as, misery *uncreated*.—3. Not produced by creation. God is an *un-created* being.

**UNCREATING**, *ppr.* Depriving of existence.

**UNCRED'IBLE**, *a.* Not to be believed; not entitled to credit. [For this, *incredible* is used.]

**UNCRED'ITABLE**, *a.* Not in good credit or reputation; not reputable.—2. Not for the credit or reputation. [We now use *discreditable*.]

**UNCRED'ITABLENESS**, *n.* Want of reputation.—2. The quality of being disreputable.

**UNCRED'ITED**, *a.* Not believed.

**UNCREST'ED**, *a.* Not having a crest.

**UNCRIT'ICAL**, *a.* Not critical.—2. Not according to the just rules of criticism.

**UNCRIT'ICALLY**, *adv.* Not critically.

**UNCRIT'ICISED**, *a.* Not criticised.

**UNCROP'PED**, *a.* Not cropped; not gathered.

**UNCROSS'ED**, *a.* Not crossed; not cancelled.—2. Not thwarted; not opposed.

**UNCROWD'ED**, *a.* Not crowded; not compressed; not straitened for want of room.

**UNCROWN'**, *v. t.* To deprive of a crown; to dethrone.—2. To pull off the crown.

**UNCROWN'ED**, *pp.* Deprived of a crown.—2. *a.* Not crowned; having no crown.

**UNCROWN'ING**, *ppr.* Depriving of a crown.

**UNCRUSH'ED**, *a.* Not crushed.

**UNCRYST'ALLINE**, *a.* Not consisting of or resembling crystal.

**UNCRYST'ALLIZ'ABLE**, *a.* Not susceptible of crystallization.

**UNCRYST'ALLIZED**, *a.* Not crystallized.

**UNCTION**, *n.* [Fr. *unction*; L. *unctio*, from *ungo*, to anoint.] 1. The act of anointing.—2. Unguent; ointment. [*Unusual*.]—3. The act of anointing medically; as, mercurial *unction*.—4. Any thing softening or lenitive.—5. That which excites piety and devotion.—6. Richness of gracious affections.—7. Divine or sanctifying grace; 1 John i.—*Extreme Roman catholics*, the rite of anointing in the last hours; or the application of sacred oil to the parts where the five senses reside. [See under *EXTREME*.]

**UNCTIONLESS**, *a.* Devoid of unction.

**UNCTUOS'ITY**, *n.* Oiliness; fatness; the quality of being greasy.—2. In *min.*, a character belonging to certain minerals, in virtue of which, when the finger is passed over their surface, or their powder is rubbed between the finger and thumb, they feel as if they were coated with some greasy matter.

**UNCTUOUS**, *a.* Fat; oily; greasy.—2. Having a resemblance to oil or grease; as, the *unctuous* feel of a stone or mineral.

**UNCTUOUSNESS**, *n.* Fatness; oiliness.—2. The quality of resembling oil.

**UNCUCK'OLDED**, † *a.* Not made a cuckold.

**UNCULL'ED**, *a.* Not gathered.—2. Not separated; not selected.

**UNCUL'PABLE**, *a.* Not blamable; not faulty.

**UNCULT'**, † *a.* [un and L. *cultus*.] Uncultivated; rude; illiterate.

**UNCUL'TIVABLE**, *a.* Not capable of being tilled or cultivated.

**UNCUL'TIVATED**, *a.* Not cultivated; not tilled; not used in tillage; as, an

*uncultivated* tract of land.—2. Not instructed; not civilized; rude; rough in manners; as, an *uncultivated* nation or age.

**UNCUL'TIVATEDNESS**, *n.* An uncultivated state.

**UNCUMBERED**, *a.* Not burdened; not embarrassed. [We now use *unencumbered*.]

**UNCUR'ABLE**, *a.* Incurable. [*The latter is mostly used*.]

**UNCUR'ABLY**, *adv.* Incurably.

**UNCURB'ABLE**, † *a.* That cannot be curbed or checked.

**UNCURB'ED**, *a.* Not curbed; not restrained; licentious.

**UNCURED**, *a.* Not cured; not healed.

**UNCURL'**, *v. t.* To loose from ringlets. The lion *uncurls* his angry mane. *Dryden*.

**UNCURL'**, *v. i.* To fall from a curled state, as ringlets; to become straight.

**UNCURL'ED**, *pp.* Loosed from ringlets. 2. *a.* Not curled; not formed into ringlets.

**UNCURL'ING**, *ppr.* Loosing from ringlets.

**UNCUR'ENT**, *a.* Not current; not passing in common payment; as, *uncurrent* coin or notes.

**UNCURSE**, † *v. t.* (uncurs'.) To free from any excretion.

**UNCURSED**, } *a.* Not cursed; not

**UNCURST**, } execrated.

**UNCURTAILED**, *a.* Not curtailed; not shortened.

**UNCURTAIN**, *v. t.* To remove a curtain or covering from.

**UNCUS'TOMARILY**, *adv.* In an unusual manner.

**UNCUS'TOMARINESS**, *n.* State of being not customary.

**UNCUS'TOMARY**, *a.* Not customary; not usual.

**UNCUS'TOMED**, *a.* Not subjected to customs or duty.—2. That has not paid duty, or been charged with customs.

**UNCUT**, *a.* Not cut; as, trees *uncut*.

**UNDAM'**, *v. t.* To free from a dam, mound, or obstruction.

**UNDAM'AGED**, *a.* Not damaged; not made worse; as, *undamaged* goods.

**UNDAM'MED**, *pp.* Freed from a dam, mound, or obstruction.

**UNDAMP'ED**, *a.* Not damped; not depressed.

**UNDANGEROUS**, *a.* Not dangerous.

**UNDARKENED**, *a.* Not darkened or obscured.

**UNDATED**, *a.* [L. *undatus*; *unda*, a wave.] Waved; having a waved surface; rising and falling in waves toward the margin, as a leaf.

**UNDA'TED**, *a.* Not dated; having no date.

**UNDAUNT'ABLE**, *a.* Not to be daunted.

**UNDAUNTED**, *a.* Not daunted; not subdued or depressed by fear; intrepid.

**UNDAUNTEDLY**, *adv.* Boldly; intrepidly.

**UNDAUNTEDNESS**, *n.* Boldness; fearless bravery; intrepidity.

**UNDAWN'ING**, *a.* Not yet dawning; not growing light; not opening with brightness.

**UNDAZ'ZLED**, *a.* Not dazzled; not confused by splendour.

**UN'DE**, UN'DEE, or UN'DY, *a.* In *her.*, wavy, applied to charges, the



Unde.

edges of which curve and recurve like the waves of water.

**UNDEAF**, † *v. t.* To free from deafness.

**UNDEBÄR'RED**, *a.* Not debarred.

**UNDEBASED**, *a.* Not debased; not adulterated.

**UNDEBAUCH'ED**, *a.* Not debauched; not corrupted; pure.

**UNDEC'AGON**, *n.* [L. *undecim*, eleven, and Gr. γωνία, angle.] In *geom.*, a plane figure of eleven angles or sides.

**UNDECAYED**, *a.* Not decayed; not impaired by age or accident; being in full strength.

**UNDECAYING**, *a.* Not decaying; not suffering diminution or decline.—2. Immortal; as, the *undecaying* joys of heaven.

**UNDECEIT'FUL**, *a.* Not deceitful.

**UNDECEIVABLE**, *a.* That cannot be deceived; not subject to deception.

**UNDECEIVE**, *v. t.* To free from deception, cheat, fallacy, or mistake, whether caused by others or by ourselves. If we rely on our own works for salvation, the Scriptures may *undecieve* us.

**UNDECEIVED**, *pp.* Disabused of cheat, deception, or fallacy.—2. Not deceived; not misled or imposed on.

**UNDECEIVING**, *ppr.* Freeing from deception or fallacy.

**UNDECENARY**, *a.* [L. *undecim*, eleven.] Eleventh; occurring once in every period of eleven years.

**UNDECENCY**, *n.* Unbecomingness; indecency. [*The latter word is now used*.]

**UNDECENT**, *a.* Not decent; indecent. [*The latter is the word used*.]

**UNDECENTLY**, *adv.* Indecent. [*The latter is the word used*.]

**UNDECEPTIVE**, *a.* Not deceptive.

**UNDECIDABLE**, *a.* That cannot be decided.

**UNDECIDED**, *a.* Not decided; not determined; not settled.

**UNDECIPHERABLE**, *a.* That cannot be deciphered.

**UNDECIPHERABLY**, *adv.* So as not to be decipherable.

**UNDECIPHERED**, *a.* Not deciphered or explained.

**UNDECIS'IVE**, *a.* Not decisive; not conclusive; not determining the controversy or contest. [We now use *indecisive*.]

**UNDECK'**, *v. t.* To divest of ornaments or dress.

**UNDECK'ED**, *pp.* Deprived of ornaments or dress.—2. *a.* Not decked; not adorned.—3. Not having a deck; as, an *undecked* vessel or barge.

**UNDECLARED**, *a.* Not declared; not avowed.

**UNDECLINABLE**, *a.* That cannot be declined.—2. Not to be avoided.—3. In *gram.*, not variable in the termination; as, an *undeclinable* noun; but in this sense we now use *undeclinable*.

**UNDECLINED**, *a.* Not deviating; not turned from the right way.—2. Not varied in termination; as, a noun *undeclined*.

**UNDECLINING**, *a.* Not declining.

**UNDECOMPOSABLE**, *a.* (s as z.) Not admitting decomposition; that cannot be decomposed.

**UNDECOMPOSED**, *a.* (s as z.) Not decomposed; not separated; as constituent particles.

**UNDECOMPOUND'ED**, *a.* Not decomposed.

**UNDECORATED**, *a.* Not adorned; not embellished; plain.

To leave the character of Christ *undecorated*, to make its own impression. *Buckminster*.

**UNDECREED**, *a.* Not decreed.

UNDEDICATED, *a.* Not dedicated; not consecrated.—2. Not inscribed to a patron.

UNDEEDED, *a.* Not signaled by any great action.—2. Not transferred by deed; as, *undeeded* land. [*Local.*]

UNDEFACEABLE, *a.* That cannot be defaced.

UNDEFACED, *a.* Not deprived of its form; not disfigured; as, an *undefaced* statue.

UNDEFA'CEDNESS, *n.* State of being undefaced.

UNDEFEASIBLE, *a.* (*s* as *z.*) Not defeasible. [*Indefeasible* is chiefly used.]

UNDEFENDED, *a.* Not defended; not protected.—2. Not vindicated.—3. Open to assault; being without works of defence.

UNDEFEND'ING, *a.* Not making defence.

UNDEFY'ED, *a.* Not set at defiance; not challenged.

UNDEFILED, *a.* Not defiled; not polluted; not vitiated.

UNDEFILEDNESS, *n.* Freedom from stain or pollution.

UNDEFINABLE, *a.* Not definable; not capable of being described or limited; as, the *undefinable* bounds of space.—2. That cannot be described by interpretation or definition.  
Simple ideas are *undefinable*. *Locke.*

UNDEFINABLENESS, *n.* The quality or state of being undefinable.

UNDEFINED, *a.* Not defined; not described by definition or explanation.—2. Not having its limits described.

UNDEFLOW'ERED, *a.* Not debauched; not vitiated.

UNDEFORM'ED, *a.* Not deformed; not disfigured.

UNDEFRAUD'ED, *a.* Not defrauded.

UNDEFRAYED, *a.* Not defrayed; not paid.

UNDEGRADED, *a.* Not degraded.

UNDEFI'ED, *pp.* Reduced from the state of Deity.

UNDEFI'FY, *v. t.* To reduce from the state of Deity.

UNDEJECT'ED, *a.* Not dejected; not depressed.

UNDELAYED, *a.* Not delayed.

UNDELAYING, *a.* Not making delay.

UNDELEGATED, *a.* Not delegated; not deputed; not granted; as, *undellegated* authority; *undellegated* powers.

UNDELIB'ERATE, *a.* Indeliberate.

UNDELIB'ERATED, *a.* Not carefully considered; as, an *undeliberated* measure. [*Not correct.*]

UNDELIB'ERATENESS, } *n.* Want  
UNDELIB'ERATIVENESS, } of consideration.

UNDELIB'ERATING, *a.* Not deliberating; not hesitating; hasty; prompt.

UNDELIGHTED, *a.* Not delighted; not well pleased.

UNDELIGHTFUL, *a.* Not giving delight or great pleasure.

UNDELIGHTFULLY, *adv.* Without giving delight.

UNDELIN'EATED, *a.* Not delineated.

UNDELIVERED, *a.* Not delivered; not communicated.

UNDELU'DED, *a.* Not deluded or deceived.

UNDELUGED, *a.* Not overwhelmed.

UNDELUSIVE, *a.* Not delusive.

UNDELUSIVELY, *adv.* Not delusively.

UNDELUSIVENESS, *n.* State of being not delusive.

UNDEMANDED, *a.* Not demanded; not required.

UNDEMOL'ISHED, *a.* Not demo-

lished; not pulled down.—2. Not destroyed.

UNDEMON'STRABLE, *a.* Not capable of fuller evidence.—2. Not capable of demonstration. [We now use *indemonstrable*.]

UNDEMON'STRABLY, *adv.* Without proving by demonstration.

UNDEMONSTRATED, *a.* Not proved by demonstration.

UNDENI'ABLE, *a.* That cannot be denied; as, *undeniable* evidence.

UNDENI'ABLY, *adv.* So plainly as to admit no contradiction or denial.

UNDEPEND'ING, *a.* Not dependent.

UNDEPLORED, *a.* Not lamented.

UNDEP'OSABLE, *a.* (*s* as *z.*) That cannot be deposited from office.

UNDEPRAVED, *a.* Not corrupted; not vitiated.

UNDEPRE'GATED, *a.* Not depre- ciated.

UNDEPRE'CIATED, *a.* Not depre- ciated; not lowered in value.

UNDEPRESS'ED, *a.* Not depressed.

UNDEPRIVED, *a.* Not deprived; not divested of by authority; not stripped of any possession.

UNDE'ER, *prep.* [Goth. *undar*; Sax. *under*; D. *under*; G. *unter*; probably compounded of *on* and *nether*; on the *nether* side.] 1. Beneath; below; so as to have something over or above. He stood under a tree; the carriage is under cover. We may see things under water; we have a cellar under the whole house.—2. In a state of pupillage or subjection to; as, a youth under a tutor; a ward under a guardian; colonies under the British government.  
I also am a man under authority, having soldiers under me; Matth. viii.

3. In a less degree than. The effect of medicine is sometimes under, and sometimes above or over its natural strength.—4. For less than. He would not sell the horse under forty pounds.—5. Less than; below. There are parishes in England under forty pounds a year.—6. With the pretence of; with the cover or pretext of. He does this under the name of love. This argument is not to be evaded under some plausible distinction.—7. With less than.  
Several young men could never leave the pulpit under half a dozen conceits. *Swift.*

8. In a degree, state, or rank inferior to. It was too great an honour for any man under a duke. *Addison.*

9. In a state of being loaded; in a state of bearing or being burdened; as, to travel under a heavy load; to live under extreme oppression.—10. In a state of oppression or subjection to, the state in which a person is considered as bearing or having any thing laid upon him; as, to have fortitude under the evils of life; to have patience under pain, or under misfortunes; to behave like a Christian under reproaches and injuries.—11. In a state of liability or obligation. No man shall trespass but under the pains and penalties of the law. Attend to the condition under which you enter upon your office. We are under the necessity of obeying the laws. Nuns are under vows of chastity. We all lie under the curse of the law, until redeemed by Christ.—12. In the state of bearing and being known by; as, men trading under the firm of Wright & Co.—13. In the state of; in the enjoyment or possession of. We live under the gospel dispensation.—14. During the time of. The American revolution commenced under the ad-

ministration of lord North.—15. Not having reached or arrived to; below. He left three sons under age.—16. Represented by; in the form of. Morpheus is represented under the figure of a boy asleep. [But *morph*, in Ethiopic, signifies cessation, rest.]—17. In the state of protection or defence. Under favour of the prince, our author was promoted. The enemy landed under cover of their batteries.—18. As bearing a particular character.

The duke may be mentioned under the double capacity of a poet and a divine.

*Felton.*

19. Being contained or comprehended in.

Under this head may be mentioned the contests between the popes and the secular princes. *Lesly.*

20. Attested by; signed by. Here is a deed under his hand and seal.

He has left us evidence under his own hand. *Locke.*

21. In a state of being handled, treated, or discussed, or of being the subject of. The bill is now under discussion. We shall have the subject under consideration next week.—22. In subordination to. Under God, this is our only safety.—23. In subjection or bondage to; ruled or influenced by; in a moral sense; within the dominion of.

They are all under sin; Rom. iii.

Under a signature, bearing, as a name or title.—Under way, in seamen's lan., moving; in a condition to make progress.—Under the lee. [See *LEE*.]—To keep under, to hold in subjection or control; to restrain.

I keep under my body; 1 Cor. ix.

To bring under, to bring into a state of subjection or control.—To knock under, to yield; to submit. [See under *KNOCK*.]

UNDE'ER, *a.* Lower in degree; subject; subordinate; as, an under officer; under sheriff. Under is much used in composition. For the etymologies, see the principal words.

UNDE'ERACT'ION, *n.* Subordinate action; action not essential to the main story.

The least episodes or underactions...are parts necessary to the main design.

*Dryden.*

UNDE'ERACT'OR, *n.* A subordinate actor or agent.

UNDE'ER-A'GENT, *n.* A subordinate agent.

UNDE'ERANGED, *a.* Not deranged.

UNDE'ERBEAR, *v. t.* To support; to endure.—2. † To line; to guard; as, cloth of gold underborne with blue tinsel.

UNDE'ERBEARER, *n.* In funerals, one who sustains the corpse.

UNDE'ERBID', *v. t.* To bid or offer less than another; as in auctions, when a contract or service is set up to the lowest bidder.

UNDE'ERBID'DING, *ppr.* Bidding less than another.

UNDE'ERBORNE, *pp.* Supported.

UNDE'ERBOUGHT', *pp.* Bought at less than a thing is worth.

UNDE'ERBRACE, *v. t.* To bind together below.

UNDE'ERBRED, *a.* Of inferior breeding or manners.

UNDE'ERBRUSH, *n.* Shrubs and small trees in a wood or forest, growing under large trees.

UNDE'ERBUY, *v. t.* To buy at less than a thing is worth. [*Not used.*]

UNDERCHAMBERLAIN, *n.* A deputy chamberlain of the exchequer.  
 UN'DERCHAPS, *n. pl.* The lower chaps.  
 UN'DERCLERK, *n.* A clerk subordinate to the principal clerk.  
 UN'DER-COAT, *n.* A coat worn under another.  
 UN'DER-COOK, *n.* A subordinate cook.  
 UN'DER-CREST, *v. t.* To support.  
 UN'DERCROFT, *n.* A vault under the choir or chancel of a church; also, a vault or secret walk under ground.  
 UN'DERCURRENT, *n.* A current below the surface of the water.  
 UN'DER-DEALING, *n.* Clandestine dealing; artifice.  
 UN'DERDITCH, *v. t.* To form a deep ditch or trench to drain the surface of land.  
 UN'DERDŪ, *v. i.* To act below one's abilities.—2. To do less than is requisite.  
 UN'DERDŌNE, *pp.* Done less than is requisite.  
 UN'DERDOSE, *n.* A quantity less than a dose.  
 UN'DERDOSE, *v. i.* To take small doses.  
 UN'DERDRAIN, *n.* A drain or trench below the surface of the ground.  
 UN'DERDRAIN, *v. t.* To drain by cutting a deep channel below the surface.  
 UN'DERDRAINED, *pp.* Drained by cutting a deep channel below the surface.  
 UN'DERFACT'ION, *n.* A subordinate faction.  
 UN'DERFÄRMER, *n.* A subordinate farmer.  
 UN'DERFEL'LOW, *n.* A mean sorry wretch.  
 UN'DERFILL'ING, *n.* The lower part of a building.  
 UN'DERFONG', *† v. t.* [Sax. *fungan*, to seize.] To take in hand.  
 UN'DERFOOT, *adv.* Beneath.—2. In *mar. lan.*, underfoot is said of an anchor when first let go.  
 UN'DERFOOT, *a.* Low; base; abject; trodden down.  
 UN'DERFURNISH, *v. t.* To supply with less than enough.  
 UN'DERFURNISHED, *pp.* Supplied with less than enough.  
 UN'DERFURNISHING, *ppr.* Furnishing with less than enough.  
 UN'DERFUR'ROW, *adv.* In *agriculture*, to sow *underfurrow*, is to plough in seed. This phrase is applied to other operations, in which something is covered by the furrow-slice.  
 UN'DER-GAR'DENER, *n.* A subordinate gardener.  
 UN'DERGIRD', *v. t.* [See *GIRD*.] To bind below; to gird round the bottom; Acts xxvii.  
 UN'DERGIRD'ING, *ppr.* Binding below; girding round the bottom.  
 UN'DERGO', *v. t.* To suffer; to endure something burdensome or painful to the body or the mind; as, to *undergo* toil and fatigue; to *undergo* pain; to *undergo* grief or anxiety; to *undergo* the operation of amputation.—2. To pass through. Bread in the stomach *undergoes* the process of digestion; it *undergoes* a material alteration.—3. To sustain without fainting, yielding, or sinking. Can you *undergo* the operation or the fatigue?—4. To be the bearer of; to possess.  
 Virtues—  
 As infinite as man may *undergo*.†  
*Shak.*

5. To support; to hazard.  
 I have mov'd certain Romans  
 To *undergo* with me an enterprise.† *Shak.*  
 6. To be subject to.  
 Claudio *undergoes* my challenge.† *Shak.*  
 UN'DER-GOD, *n.* An inferior deity; a demigod.  
 UN'DERGO'ING, *ppr.* Suffering; enduring.  
 UN'DERGONE, *pp.* (undergawn'). Borne; suffered; sustained; endured. Who can tell how many evils and pains he has *undergone*.  
 UN'DERGRAD'UATE, *n.* A student or member of a university or college, who has not taken his first degree.  
 UN'DERGRAD'UATESHIP, *n.* State or rank of an undergraduate.  
 UN'DERGROUND', *n.* A place or space beneath the surface of the ground.  
 UN'DERGROUND, *a.* Being below the surface of the ground; as, an *underground* story or apartment.  
 UN'DERGROUND', *adv.* Beneath the surface of the earth.  
 UN'DERGRŌWTH, *n.* That which grows under trees; shrubs or small trees growing among large ones.  
 UN'DERHAND, *adv.* By secret means; in a clandestine manner.—2. By fraud; by fraudulent means.  
 UN'DERHAND, *a.* Secret; clandestine; usually implying meanness or fraud, or both. He obtained the place by *underhand* practices.  
 UN'DERHEW', *v. t.* To hew a piece of timber which should be square, in such a manner that it appears to contain a greater number of cubic feet than it really does.  
 UN'DER-HON'EST, *† a.* Scarcely honest.  
 UN'DERHUNG, *a.* Hung low; as, an *underhung* jaw.  
 UN'DERIDED, *a.* Not derided.  
 UN'DERIVED, *a.* Not derived; not borrowed; not received from a foreign source.  
 UN'DER-JAW, *n.* The lower jaw.  
 UN'DERKEEPER, *n.* A subordinate keeper.  
 UN'DERLA'BOURER, *n.* A subordinate workman.  
 UN'DERLAID, *pp.* or *a.* [from *underlay*.] Having something lying or laid beneath; as, sand *underlaid* with clay.  
 UN'DERLAY, *v. t.* To lay beneath; to support by something laid under.  
 UN'DERLAYER, *n.* One that underlays.—2. Something laid under.  
 UN'DERLAYING, *ppr.* Laying beneath; supporting by laying something under.  
 UN'DERLEAF, *n.* A sort of apple good for cider.  
 UN'DERLET', *v. t.* To let below the value.—2. To let or lease; as, a lessee or tenant; to let under a lease.  
 It is a matter of much importance...that the tenant should have power to *underlet* his farms. *Cyc.*  
 UN'DERLET'TER, *n.* A tenant who leases.  
 UN'DERLET'TING, *ppr.* Letting or leasing under a lease, or by a lessee.  
 UN'DERLET'TING, *n.* The act or practice of letting lands by lessees or tenants. [This is called also *subletting*.]  
 UN'DERLIE, *v. i.* To lie beneath.  
 UN'DERLINE, *v. t.* To mark with a line below the words; sometimes called *scoring*.—2.† To influence secretly.  
 UN'DERLINED, *pp.* Marked with a line underneath.  
 UN'DERLING, *n.* An inferior person or agent; a mean sorry fellow.

UN'DERLINING, *ppr.* Marking with a line below.  
 UN'DERLOCK, *n.* A lock of wool hanging under the belly of a sheep.  
 UN'DERMÄSTED, *a.* In *mar. lan.*, an epithet applied to a ship with low masts, or one whose masts are too short or too light, in which case the vessel cannot bear so great a sail as should give her true way.  
 UN'DERMÄSTER, *n.* A master subordinate to the principal master.  
 UN'DERMEAL, *† n.* A repast before dinner; in some places after dinner.  
 UN'DERMINE, *v. t.* To sap; to excavate the earth beneath, for the purpose of suffering to fall, or of blowing up; as, to *undermine* a wall.—2. To excavate the earth beneath. Rapid streams often *undermine* their banks and the trees growing upon them.—3. To remove the foundation or support of any thing by clandestine means; as, to *undermine* reputation; to *undermine* the constitution of the state.  
 He should be warned who are like to *undermine* him. *Locke.*  
 UN'DERMINED, *pp.* Sapped; having the foundation removed.  
 UN'DERMINER, *n.* One that saps, or excavates the earth beneath any thing.—2. One that clandestinely removes the foundation or support; one that secretly overthrows; as, an *underminer* of the church.  
 UN'DERMINING, *ppr.* Sapping; digging away the earth beneath; clandestinely removing the supports of.  
 UN'DERMOST, *a.* Lowest in place beneath others.—2. Lowest in state or condition.  
 The party that is *undermost*. *Addison.*  
 UN'DERN, *† n.* [Sax.] The third hour of the day, or nine o'clock.  
 UN'DERNEATH, *adv.* [under and neath. See *Nether*.] Beneath; below; in a lower place.  
 Or sullen mole that runneth *underneath*. *Milton.*  
 The slate did not lie flat upon it, but left a free passage *underneath*. *Addison.*  
 UN'DERNEATH, *prep.* Under; beneath. *Underneath* this stone doth lie As much beauty as could die. *B. Jonson.*  
 UN'DEROF'FICER, *n.* A subordinate officer.  
 UN'DEROG'ATORY, *a.* Not derogatory.  
 UN'DERPÄRT, *n.* A subordinate part.  
 UN'DER-PEEP, *† v. i.* To peep or to look under.  
 UN'DER-PEO'PLED, *a.* Not fully peopled.  
 UN'DERPET'TICOAT, *n.* A petticoat worn under a skirt or another petticoat.  
 UN'DERPIN', *v. t.* In *arch.*, to bring a wall up to the ground sill.—2. To support by some solid foundation; or to place something underneath for support.  
 UN'DERPIN'NED, *pp.* Supported by stones or a foundation.  
 UN'DERPIN'NING, *ppr.* Bringing up a wall to the ground sill.  
 UN'DERPIN'NING, *n.* In *arch.*, the act of bringing a wall up to the ground sill. The term is also used to signify the temporary support of a wall, whose foundation is not secure, and the bringing up of new solid work on which the wall is afterward to rest.  
 UN'DER-PLAY', *† v. t.* To play an inferior part.  
 UN'DERPLOT, *n.* A series of events in a play, proceeding collaterally with

the main story, and subservient to it.—2. A clandestine scheme.

**UNDERPRAISE**, *v. t.* (*s* as *z*.) To praise below desert.

**UNDERPRIZE**, *v. t.* To value at less than the worth; to undervalue.

**UNDERPRIZED**, *pp.* Undervalued.

**UNDERPRIZING**, *ppr.* Undervaluing.

**UNDERPROP**, *v. t.* To support; to uphold.

And *underprop* the head that bears the crown. *Fenton.*

**UNDERPROPORTIONED**, *a.* Having too little proportion.

Scanty and *underproportioned* returns of civility. *Cotlier.*

**UNDERPROPPED**, *pp.* Supported; upheld.—2. *a.* Having props underneath.

**UNDERPULLER**, *† n.* An inferior puller.

**UNDERRATE**, *v. t.* To rate too low; to rate below the value; to undervalue.

**UNDERRATE**, *n.* A price less than the worth; as, to sell a thing at an *underrate*.

**UNDERRATED**, *pp.* Rated too low; undervalued.

**UNDER-RECOMPENCED**, *a.* Not fully paid.

**UNDER-REGION**, *n.* An inferior region.

**UNDERRUN**, *v. t.* In *mar. lan.*, to pass under in a boat.—To *underrun* a tackle, to separate its parts and put them in order.—To *underrun* a cable, to pass under it in a boat, in order to examine whether any part of it is damaged or entangled.

**UNDER SAIL**. In *mar. lan.*, a term applied to a ship when she is loosened from her moorings, and is under the government of her sails and rudder.

**UNDERSATURATED**, *a.* Not fully saturated; a *chemical term*.

**UNDERSAY**, *v. t.* To say by way of derogation or contradiction. [*Not in use.*]

**UNDERSCORE**, *v. t.* To draw a mark under.

**UNDERScoreD**, *pp.* Marked underneath.

**UNDERSCORING**, *ppr.* Marking underneath.

**UNDERSECRETARY**, *n.* A secretary subordinate to the principal secretary.

**UNDERSSELL**, *v. t.* To sell the same articles at a lower price than another.

**UNDERSSELLING**, *ppr.* Selling at a lower price.

**UNDERSERVANT**, *n.* An inferior servant.

**UNDERSSET**, *v. t.* To prop; to support.

**UNDERSSET**, *n.* In *mar. lan.*, a current of water below the surface in a direction contrary to that of the wind, or of the water at the surface.

**UNDERSSETTER**, *n.* A prop; a pedestal; a support; 1 Kings vii.

**UNDERSSETTING**, *ppr.* Propping; supporting.

**UNDERSSETTING**, *n.* The lower part; the pedestal.

**UNDERSHERIFF**, *n.* A sheriff's deputy.

**UNDERSHERIFFRY**, *† n.* The office of an under-sheriff.

**UNDERSHOT WHEEL**, *n.* A water wheel having a number of float-boards disposed on its circumference, and turned round by the moving force of a stream of water, acting on the float-boards at its lowest part. In this wheel the water acts entirely by its momentum, and therefore the effect depends on the quantity of water in

the mill course, and the velocity with which it strikes the float-boards. The velocity will depend upon the height of the fall, which therefore should be

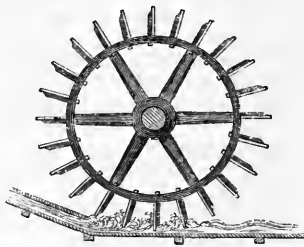

Undershot Wheel.

as much increased as the peculiar circumstances of the situation will admit. It has been determined by experiment that the effect of the wheel is the greatest when its velocity is about half the velocity of the stream. The effect of an overshot wheel under the same circumstances of quantity and fall of water is, at a medium, double to that of the undershot. [*See BREAST WHEEL, OVERSHOT WHEEL.*]

**UNDERSHRUB**, *n.* A low shrub, permanent and woody at the base, but the branches decaying yearly.

**UNDERSIGN**, *v. t.* To write one's name at the foot or end of a letter or any legal instrument.

**UNDERSIGNED**, *pp.* Written or subscribed at the bottom or end of a writing.

**UNDERSIGNING**, *ppr.* Subscribing.

**UNDERSIZED**, *a.* Being of a size less than common.

**UNDERSOIL**, *n.* Soil beneath the surface; subsoil.

**UNDERSOLD**, *pp.* Sold at a lower price.

**UNDERSÖNG**, *n.* Chorus; burden of a song.

The challenge to Damætas shall belong; Menæceas shall sustain his *undersong*;

Each in his turn your tuneful numbers bring. *Dryden.*

**UNDER-SPARRED**, *a.* *See* UNDERMASTED.

**UNDERSTAND**, *v. t.* pret. and *pp.* *understood*. [*under* and *stand*.] The sense is to support or hold in mind.]

1. To have just and adequate ideas of; to comprehend; to know; as, to *understand* a problem in Euclid; to *understand* a proposition or a declaration.

—2. To have the same ideas as the person who speaks, or the ideas which a person intends to communicate. I *understood* the preacher; the court perfectly *understands* the advocate or his argument.—3. To receive or have the ideas expressed or intended to be conveyed in a writing or book; to know the meaning. It is important that we should *understand* the sacred oracles.

—4. To know the meaning of signs, or of any thing intended to convey ideas; as, to *understand* a nod, a wink or a motion.—5. To suppose to mean.

The most learned interpreters *understood* the words of sin, and not of Abel. *Locke.*

6. To know by experience.—7. To know by instinct.

Amorous intent, well *understood*. *Milton.*

8. To interpret, at least mentally.—9. To know another's meaning.—10. To

hold in opinion with conviction.—11. To mean without expressing.

War then, war.

Open or *understood*, must be resolv'd.

*Milton.*

12. To know what is not expressed. I bring them to receive

From thee their names, and pay the fealty With low subjection; *understand* the same Of fish. *Milton.*

13. To learn; to be informed. I *understand* that parliament have passed the bill.

**UNDERSTAND**, *v. i.* To have the use of the intellectual faculties; to be an intelligent and conscious being.

All my soul be

Imparadis'd in you, in whom alone I *understand*, and grow, and see. *Donne.*

2. To be informed by another; to learn. I *understood* of the evil that Eliashib did; Neh. xiii.

**UNDERSTANDABLE**, *a.* That can be understood. [*Not much used.*]

**UNDERSTANDER**, *n.* One who understands or knows by experience. [*Little used.*]

**UNDERSTANDING**, *ppr.* Comprehending; apprehending the ideas or sense of another, or of a writing; learning or being informed.—2. *a.* Knowing; skilful. He is an *understanding* man.

**UNDERSTANDING**, *n.* The faculty of the human mind by which it apprehends the real state of things presented to it, or by which it receives or comprehends the ideas which others express and intend to communicate. The *understanding* is called also the *intellectual faculty*.

It is the faculty by means of which we obtain a great part of our knowledge; Luke xxiv; Eph. i.

By *understanding* I mean that faculty whereby we are enabled to apprehend the objects of knowledge, generals or particulars, absent or present, and to judge of their truth or falsehood, good or evil.

*Watts.*

The *understanding* comprehends our contemplative powers; by which we perceive objects; by which we conceive or remember them; by which we analyze or compound them; and by which we judge and reason concerning them.

*Dr. Reid's Essays*

There is a spirit in man, and the inspiration of the Almighty giveth him *understanding*; Job xxxii.

2. Knowledge; exact comprehension.

Right *understanding* consists in the perception of the visible or probable agreement or disagreement of ideas.

*Locke.*

3. Intelligence between two or more persons; agreement of minds or union of sentiments. There is a good *understanding* between the minister and his people.

**UNDERSTANDINGLY**, *adv.* Intelligibly; with full knowledge or comprehension of a question or subject; as, to vote upon a question *understandingly*; to act or judge *understandingly*.

The gospel may be neglected, but it cannot be *understandingly* disbelieved.

*J. Haves.*

**UNDERSTATE**, *v. t.* To state or represent less strongly than the truth will bear.

**UNDERSTOOD**, *pret.* and *pp.* of *understand*.

**UNDERSTRAPPER**, *n.* A petty fellow; an inferior agent.

**UNDERSTRATUM**, *n.* Subsoil; the

bed or layer of earth on which the mould or soil rests.

**UNDERSTROKE**, *v. t.* To underline.

**UNDERTAKABLE**, *† a.* That may be undertaken.

**UNDERTAKE**, *v. t. pret. Undertook*; *pp. Undertaken.* [*under and take.*] 1. To engage in; to enter upon; to take in hand; to begin to perform. When I *undertook* this work, I had a very inadequate knowledge of the extent of my labours.—2. To covenant or contract to perform or execute. A man *undertakes* to erect a house, or to make a mile of canal, when he enters into stipulations for that purpose.—3. To attempt; as, when a man *undertakes* what he cannot perform.—4. *†* To assume a character.—5. To engage with; to attack.

Your lordship should not *undertake* every companion you offend. *† Shak.*

6. To have the charge of.

Who *undertakes* you to your end. *† Shak.*

**UNDERTAKE**, *v. i.* To take upon or assume any business or province.

O Lord, I am oppressed; *undertake* for me. Is. xxxviii.

2. To venture; to hazard. They dare not *undertake*.—3. To promise; to be bound.

I dare *undertake* they will not lose their labour. *Woodward.*

To *undertake for*, to be bound; to become surety for.

**UNDERTAKEN**, *pp. of Undertake.* The work was *undertaken* at his own expense.

**UNDERTAKER**, *n.* One who undertakes; one who engages in any project or business.—2. One who stipulates or covenants to perform any work for another.—3. One who manages funerals.

**UNDERTAKING**, *ppr.* Engaging in; taking in hand; beginning to perform; stipulating to execute.

**UNDERTAKING**, *n.* Any business, work, or project which a person engages in, or attempts to perform; an enterprize. The tunnel, or the formation of the tunnel, under the Thames, was a gigantic *undertaking*. The attempt to find a navigable passage to the Pacific round North America, is a hazardous *undertaking*, and probably useless to navigation.

**UNDERTENANCY**, *n.* A tenure under a lessee.

**UNDERTENANT**, *n.* The tenant of a tenant; one who holds lands or tenements of a tenant.

**UN'DERTIME**, *† n.* Undern-tide; the time after dinner, or in the evening.

**UN'DER-TONE**, *n.* A low tone; a tone lower than is usual.

**UNDERTOOK**, *pret. of Undertake.*

**UN'DER-TOW**, *n.* A current of water below the surface in a different direction from that at the surface.

**UNDERTREASURER**, *n.* (*under-treaz'urer.*) A subordinate treasurer.

**UNDERTUTOR**, *n.* A subordinate tutor.

**UNDERVALUATION**, *n.* The act of valuing below the real worth; rate not equal to the worth.

**UNDERVAL'UE**, *v. t.* To value, rate, or estimate below the real worth.—2. To esteem lightly; to treat as of little worth.

In comparison of the discharge of my duties, I *undervalued* all designs of authority. *Atterbury.*

3. To despise; to hold in mean estimation.

I write not this with the least intention to *undervalue* the other parts of poetry. *Dryden.*

**UNDERVAL'UE**, *n.* Low rate or price; a price less than the real worth.

**UNDERVAL'UED**, *pp.* Estimated at less than the real worth; slighted; despised.

**UNDERVAL'UER**, *n.* One who esteems lightly.

**UNDERVAL'UING**, *ppr.* Estimating at less than the real worth; slighting; despising.

**UN'DER-WAY**. To be *under-way*, in *seamen's lan.*, is to be in motion; as, when a ship begins to sail out of a harbour.

**UNDERWENT**, *pret. of Undergo.* He *underwent* severe trials.

**UN'DERWOOD**, *n.* Small trees that grow among large trees; coppice.

**UN'DERWORK**, *n.* Subordinate work; petty affairs.

**UNDERWORK**, *v. t.* To destroy by clandestine measures.—2. To work or labour upon less than is sufficient or proper.—3. To work at a less price than others in the like employment; as, one mason may *underwork* another; a shoemaker cannot *underwork* a joiner.

**UN'DERWORKER**, *n.* One who underworks; or, a subordinate workman.

**UNDERWORK'ING**, *ppr.* Destroying clandestinely; working at less price than others in the like employment.

**UN'DERWORKMAN**, *n.* A subordinate workman.

**UN'DER-WORLD**, *n.* An inferior world.—2. The lower or inferior part of mankind.

**UNDERWRITE**, *v. t.* [*See WRITE.*] To write under something else.

The change I have made, I have here *underwritten*. *Sunderson.*

2. To subscribe. We whose names are *underwritten*, agree to pay the sums expressed against our respective names.—3. To subscribe one's name for insurance; to set one's name to a policy of insurance, for the purpose of becoming answerable for loss or damage, for a certain premium per cent. Individuals *underwrite* policies of insurance, as well as companies.

The broker who procures insurance, ought not, by *underwriting* the policy, to deprive the parties of his unbiased testimony. *Marshall.*

**UNDERWRITE**, *v. i.* To practise insuring.

**UNDERWRITER**, *n.* One who insures; an insurer; so called because he *underwrites* his name to the conditions of the policy.

**UNDERWRITING**, *ppr.* Writing under something.—2. Subscribing a policy; insuring.

**UNDERWRITING**, *n.* The act or practice of insuring ships, goods, houses, &c.

**UNDERWRIT'TEN**, *pp.* Written under; subscribed.

**UNDERWROUGHT**, } *a.* Not worked  
**UNDERWORK'ED**, } to the utmost;  
not worked enough.

**UNDESCEND'IBLE**, *a.* Not descendible; not capable of descending to heirs.

**UNDESCRIBABLE**, *a.* That cannot be described.

**UNDESCRIBED**, *a.* Not described.

**UNDESERIED**, *a.* Not deserved; not discovered; not seen.

**UNDESERV'ED**, *a. (s as z.)* Not deserved; not merited.

**UNDESERV'EDLY**, *adv.* Without desert, either good or evil.

**UNDESERV'EDNESS**, *n.* Want of being worthy.

**UNDESERV'ER**, *n.* One of no merit.

**UNDESERV'ING**, *a.* Not deserving; not having merit. God continually supplies the wants of his *undeserving* creatures.—2. Not meriting; with *of*; as, a man *undeserving* of happiness, or of punishment.

**UNDESERV'INGLY**, *adv.* Without meriting any particular advantage or harm.

**UNDES'IGNATED**, *a.* Not designated.

**UNDES'IGNED**, *a.* Not designed; not intended; not proceeding from purpose; as, to do an *undesigned* injury.

**UNDES'IGNEDLY**, *adv.* Without design or intention.

**UNDES'IGNEDNESS**, *n.* Freedom from design or set purpose.

**UNDESIGN'ING**, *a.* Not acting with set purpose.—2. Sincere; upright; artless; having no artful or fraudulent purpose. It is base to practise on *undesigning* minds.

**UNDESIRABLE**, *a. (s as z.)* Not to be desired; not to be wished; not pleasing.

**UNDES'IRE**D, *a. (s as z.)* Not desired, or not solicited.

**UNDESIR'ING**, *a.* Not desiring; not wishing.

**UNDESIR'OUS**, *a.* Not desirous.

**UNDES'PAIRING**, *a.* Not yielding to despair.

**UNDES'PATCH'ED**, *a.* Not despatched.

**UNDESPOIL'ED**, *a.* Not despoiled.

**UNDES'TINED**, *a.* Not destined.

**UNDE'STROY'ABLE**, *† a.* Indestructible.

**UNDE'STROY'ED**, *a.* Not destroyed; not wasted; not ruined.

**UNDE'TACH'ED**, *a.* Not detached; not separated.

**UNDE'TAIL'ED**, *a.* Not detailed.

**UNDE'TECT'ED**, *a.* Not detected; not discovered; not laid open.

**UNDE'TERM'INABLE**, *a.* That cannot be determined or decided.

**UNDE'TERM'INATE**, *a.* Not determinate; not settled or certain. [But *indeterminate* is now generally used.]

**UNDE'TERM'INATENESS**, *n.* Uncertainty; unsettled state.

**UNDE'TERM'INATION**, *n.* Indecision; uncertainty of mind. [*See INDETERMINATION*, which is chiefly used.]

**UNDE'TERM'INED**, *a.* Not determined; not settled; not decided.—2. Not limited; not defined; indeterminate.—3. In *matn.*, not known. An *undetermined* quantity may be determinate, or capable of being known, but an *indeterminate* quantity is one which cannot be known.

**UNDE'TE'RR'ED**, *a.* Not deterred; not restrained by fear or obstacles.

**UNDE'TEST'ING**, *a.* Not detesting; not abhorring.

**UNDE'VELOP'ED**, *a.* Not opened or unfolded.

**UNDE'VIATING**, *a.* Not deviating; not departing from the way, or from a rule, principle, or purpose; steady; regular; as, an *undeviating* course of virtue.—2. Not erring; not wandering; not crooked.

**UNDE'VIATINGLY**, *adv.* Without wandering; steadily; regularly.

**UNDE'VIOUS**, *a.* Not devions.

**UNDE'VIOUSLY**, *adv.* Not deviously.

UNDEVISED, *a.* Not devised.  
 UNDEVOTED, *a.* Not devoted.  
 UNDEVOURED, *a.* Not devoured.  
 UNDEVOU'T, *a.* Not devout; having no devotion.  
 UNDEVOU'TLY, *adv.* Without devotion.  
 UNDEX'TROUS, *a.* Not dextrous; clumsy.  
 UNDI'ADEMED, *a.* Not adorned with a diadem.  
 UNDIAPH'ANOUS, *a.* Not transparent; not pellucid.  
 UNDI'D, *pret. of Undo.*  
 UNDIFFUSED, *a.* Not diffused.  
 UNDIG'ENOUS, *a.* [L. *unda*, wave, and Gr. *γενος*, kind.] Generated by water.  
 UNDIG'EST, *† a.* Undigested.  
 UNDIGEST'ED, *a.* Not digested; not subdued by the stomach; crude.  
 UNDI'GHT, *† v. t.* To put off, as ornaments, or apparel.  
 UNDIG'NIFIED, *a.* Not dignified; common; mean.  
 UNDI'LUTED, *a.* Not diluted.  
 UNDIMIN'ISHABLE, *a.* Not capable of diminution.  
 UNDIMIN'ISHABLY, *adv.* So as not to be diminishable.  
 UNDIMIN'ISHED, *a.* Not diminished; not lessened; unimpaired.  
 UNDIMIN'ISHING, *a.* Not diminishing; not becoming less.  
 UNDI'AMED, *a.* Not made dim; not obscured.  
 UN'DINE, *n.* [L. *unda*.] A name given by the Cabalists to a kind of water-nymph.  
 UNDI'NT'ED, *a.* Not impressed by a blow.  
 UNDIPLOMAT'IC, *a.* Not according to the rules of diplomatic bodies.  
 UNDI'P'ED, *a.* Not dipped; not plunged.  
 UNDI'RECT'ED, *a.* Not directed; not guided; left without direction.—2. Not addressed; not superscribed; as a letter.  
 UNDISAPPOINT'ED, *a.* Not disappointed.  
 UNDISBAND'ED, *a.* Not disbanded.  
 UNDISCERN'ED, *a.* Not discerned; not seen; not observed; not described; not discovered; as, truths *undiscovered*.  
 UNDISCERN'EDLY, *adv.* In such a manner as not to be discovered or seen.  
 UNDISCERN'IBLE, *a.* That cannot be discerned, seen, or discovered; invisible; as, *undiscernible* objects or distinctions.  
 UNDISCERN'IBLENESS, *n.* The state or quality of being undiscernible.  
 UNDISCERN'IBLY, *adv.* In a way not to be discovered or seen; invisibly; imperceptibly.  
 UNDISCERN'ING, *a.* Not discerning; not making just distinctions; wanting judgment or the power of discrimination.  
 UNDISCERN'ING, *n.* Want of discernment.  
 UNDISCHARG'ED, *a.* Not discharged.  
 UNDISCIPLINABLE, *a.* Not disciplinable.  
 UNDISCIPLINED, *a.* Not disciplined; not duly exercised and taught; not subdued to regularity and order; raw; as, *undisciplined* troops; *undisciplined* valour.—2. Not instructed; untaught; as, *undisciplined* minds.  
 UNDISCLOSE, *v. t.* (undisclo'ze.) Not to discover. [A bad word.]  
 UNDISCLOSED, *a.* Not disclosed; not revealed.  
 UNDISCOLOURED, *a.* Not discoloured; not stained.

UNDISCONCERT'ED, *a.* Not disconcerted.  
 UNDISCORD'ANT, *a.* Not discordant.  
 UNDISCORD'ING, *a.* Not disagreeing; not jarring in music; harmonious; as, *undiscording* voices.  
 UNDISCOUR'AGED, *a.* Not disheartened.  
 UNDISCOVERABLE, *a.* That cannot be discovered or found out; as, *undiscoverable* principles.  
 UNDISCOVERABLY, *adv.* In a manner not to be discovered.  
 UNDISCOVERED, *a.* Not discovered; not seen; not described.  
 UNDISCREET, *a.* Not discreet; not prudent or wise. [Instead of this, *indiscreet* is used.]  
 UNDISCREETLY, *adv.* Indiscreetly; [See *INDISCREETLY*.]  
 UNDISCRIMINATED, *a.* Not discriminated.  
 UNDISCRIMINATING, *a.* Not discriminating.  
 UNDISCUSS'ED, *a.* Not discussed; not argued or debated.  
 UNDISGRACED, *a.* Not disgraced or dishonoured.  
 UNDISGUIASABLE, *a.* That cannot be disguised.  
 UNDISGUISED, *a.* [See *GUISE*.] Not disguised; not covered with a mask, or with a false appearance.—2. Open; frank; candid; plain; artless.  
 UNDISGUISING, *a.* Not disguising.  
 UNDISHEARTENED, *a.* Not discouraged.  
 UNDISHON'OURED, *a.* [See *HONOUR*.] Not dishonoured; not disgraced.  
 UNDISIN'TEGRATED, *a.* Not disintegrated.  
 UNDISMAYED, *a.* Not dismayed; not disheartened by fear; not discouraged; as, troops *undismayed*.  
 UNDISMISS'ED, *a.* Not dismissed.  
 UNDISOBLI'GING, *a.* Inoffensive. [Little used.]  
 UNDISOR'DERED, *a.* (s as z.) Not disordered; not disturbed.  
 UNDISPENS'ED, *a.* Not dispensed.—2. Not freed from obligation.  
 UNDISPENS'ING, *a.* Not allowing to be dispensed with.  
 UNDISPERS'ED, *a.* Not dispersed; not scattered.  
 UNDISPLAYED, *a.* Not displayed; not unfolded.  
 UNDISPOSED, *a.* Not disposed.—*Undisposed of*, not disposed of; not bestowed; not parted with; as, employments *undisposed of*.  
 UNDISPOSEDNESS, *n.* Indisposition; disinclination.  
 UNDISPUTABLE, *a.* Not disputable. [But the word now used is *undisputable*.]  
 UNDISPUTABLENESS, *n.* A state of not being disputable.  
 UNDISPUTED, *a.* Not disputed; not contested; not called in question; as, an *undisputed* title; *undisputed* truth.  
 UNDISPUT'EDLY, *adv.* Without dispute.  
 UNDISQUIETED, *a.* Not disquieted; not disturbed.  
 UNDISSECT'ED, *a.* Not dissected.  
 UNDISSEMBLED, *a.* Not dissembled; open; undisguised; unfeigned; as, *undissembled* friendship or piety.  
 UNDISSEMBLING, *a.* Not dissembling; not exhibiting a false appearance; not false.  
 UNDIS'SIPATED, *a.* Not dissipated; not scattered.  
 UNDISSOLV'ABLE, *a.* [See *DISSOLVE*.] That cannot be dissolved or

melted.—2. That may not be loosened or broken; as, the *undissolvable* ties of friendship.  
 UNDISSOLV'ED, *a.* Not dissolved; not melted.  
 UNDISSOLV'ING, *a.* Not dissolving; not melting; as, the *undissolving* ice of the Alps.  
 UNDISTEMPERED, *a.* Not diseased; free from malady.—2. Free from perturbation.  
 UNDISTEND'ED, *a.* Not distended; not enlarged.  
 UNDISTILL'ED, *a.* Not distilled.  
 UNDISTIN'GISHABLE, *a.* That cannot be distinguished by the eye; not to be distinctly seen.—2. Not to be known or distinguished by the intellect, by any peculiar property.  
 UNDISTIN'GISHABLY, *adv.* Without distinction; so as not to be known from each other, or to be separately seen.  
 UNDISTIN'GISHED, *a.* Not distinguished; not so marked as to be distinctly known from each other.  
*Undistinguish'd* seeds of good and ill.  
*Dryden.*  
 2. Not separately seen or described.—3. Not plainly discerned.—4. Having no intervenient space.—5. Not marked by any particular property.—6. Not treated with any particular respect.—7. Not distinguished by any particular eminence.  
 UNDISTIN'GISHING, *a.* Making no difference; not discriminating; as, *undistinguishing* favour.  
*Undistinguishing* distribution of good and evil.  
*Addison.*  
 UNDISTORT'ED, *a.* Not distorted; not perverted.  
 UNDISTRACT'ED, *a.* Not perplexed by contrariety or confusion of thoughts, desires, or concerns.  
 UNDISTRACT'EDLY, *adv.* Without disturbance from contrariety of thoughts or multiplicity of concerns.  
 UNDISTRACT'EDNESS, *n.* Freedom from disturbance or interruption from contrariety or multiplicity of thoughts and concerns.  
 UNDISTRIB'UTED, *a.* Not distributed or allotted.  
 UNDISTURB'ED, *a.* Free from interruption; not molested or hindered; as, *undisturbed* with company or noise.—2. Free from perturbation of mind; calm; tranquil; placid; serene; not agitated. To be *undisturbed* by danger, by perplexities, by injuries received, is a most desirable object.—3. Not agitated; not stirred; not moved; as, the surface of water *undisturbed*.  
 UNDISTURB'EDLY, *adv.* Calmly; peacefully.  
 UNDISTURB'EDNESS, *n.* Calmness; tranquillity; freedom from molestation or agitation.  
 UNDISTURB'ING, *a.* Not disturbing.  
 UNDIVERS'IFIED, *a.* Not diversified; not varied; uniform.  
 UNDIVERT'ED, *a.* Not diverted; not turned aside.—2. Not amused; not entertained or pleased.  
 UNDIVIDABLE, *a.* That cannot be divided; not separable; as, an *undividable* scene.  
 UNDIVIDED, *a.* Not divided; not separated or disunited; unbroken; whole; as, *undivided* attention or affections.—2. In *bot.*, not lobed, cleft, or branched.  
 UNDIVIDEDLY, *adv.* So as not to be parted.  
 UNDIVINABLE, *a.* That cannot be divined.

**UNDIVORCED**, *a.* Not divorced; not separated.

**UNDIVULG'ED**, *a.* Not divulged; not revealed or disclosed; secret.

**UNDO**, *v. t. pret. Undid; pp. Undone.* To reverse what has been done; to annul; to bring to naught any transaction. We can *undo* many kinds of work; but we cannot *undo* crimes, errors, or faults.

To-morrow ere the setting sun,  
She'd all *undo* what she had done.

*Swift.*

2. To loose; to open; to take to pieces; to unravel; to unfasten; to untie; as, to *undo* a knot.—3. To ruin; to bring to poverty; to impoverish. Many are *undone* by unavoidable losses; but more *undo* themselves by vices and dissipation, or by indolence.—4. To ruin, in a moral sense; to bring to everlasting destruction and misery.—5. To ruin in reputation.

**UNDOCK**, *v. t.* To take out of dock; as, to *undock* a ship.

**UNDOER**, *n.* One who undoes or brings destruction; one who reverses what has been done; one who ruins the reputation of another.

**UNDOING**, *ppr.* Reversing what has been done; ruining.

**UNDOING**, *n.* The reversal of what has been done.—2. Ruin; destruction.

**UNDOMESTIC**, *a.* Not domestic.

**UNDOMESTICATED**, *a.* Not domesticated; not accustomed to a family life.—2. Not tamed.

**UNDONE**, *pp.* Reversed; annulled.—2. Ruined; destroyed.

When the legislature is corrupted, the people are *undone*. *J. Adams.*

3. *a.* Not done; not performed; not executed. We are apt to leave *undone* what we ought to do.

**UNDOUBTABLE**, *a.* (undout'able.) Not to be doubted.

**UNDOUBTED**, *a.* (undout'ed.) Not doubted; not called in question; indubitable; indisputable; as, *undoubted* proof; *undoubtedly* truth.

**UNDOUBTEDLY**, *adv.* (undout'edly.) Without doubt; without question; indubitably.

**UNDOUBTFUL**, *a.* (undout'ful.) Not doubtful; not ambiguous; plain; evident.

**UNDOUBTING**, *a.* (undout'ing.) Not doubting; not hesitating respecting facts; not fluctuating in uncertainty; as, an *undoubting* believer; an *undoubting* faith.

**UNDOUBTINGLY**, *adv.* Without doubting.

**UNDOWERED**, *a.* Not having a dower.

**UNDRAINED**, *a.* Not drained; not freed from water.

**UNDRAMATIC**, } *a.* Not drama-  
**UNDRAMATICAL**, } tic; not according to the rules of the drama, or not suited to the drama.

**UNDRAPED**, *a.* Not draped; not covered with drapery or clothes.

**UNDRAWN**, *a.* Not drawn; not pulled by an external force.—2. Not allured by motives or persuasion.—3. Not taken from the box; as, an *undrawn* ticket.

**UNDREADED**, *a.* (undred'ed.) Not dreaded; not feared.

**UNDREADING**, *a.* Not dreading; fearless.

**UNDRAMED**, } *a.* Not dreamed; not  
**UNDREAM'T**, } thought of.

**UNDRESS**, *v. t.* To divest of clothes; to strip.—2. To divest of ornaments, or the attire of ostentation; to disrobe.

**UN'DRESS**, *n.* A loose negligent dress. **UNDRESS'ED**, *pp.* Divested of dress; disrobed.—2. *a.* Not dressed; not attired.—3. Not prepared; as, meat *undressed*.—4. Not pruned; not trimmed; not put in order; as, an *undressed* vineyard.

**UNDRI'ED**, *a.* Not dried; wet; moist; as, *undried* cloth.—2. Not dried; green; as, *undried* hay; *undried* hops.

**UNDRILL'ED**, *a.* Not drilled.

**UNDRINK'ABLE**, *a.* Not drinkable.

**UNDRIV'EN**, *a.* Not driven; not impelled.

**UNDRUOP'ING**, *a.* Not drooping; not sinking; not despairing.

**UNDRUOSS'Y**, *a.* Free from dross or recrement.

**UNDRUO'N'ED**, *a.* Not drowned.

**UNDU'BITABLE**, *a.* Not to be doubted; unquestionable. [But the word now used is *indubitable*.]

**UNDUE**, *a.* Not due; not yet demanded by right; as, a debt, note, or bond *undue*.—2. Not right; not legal; improper; as, an *undue* proceeding.—3. Not agreeable to a rule or standard, or to duty; not proportioned; excessive; as, an *undue* regard to the externals of religion; an *undue* attachment to forms; an *undue* rigour in the execution of law.

**UNDÜKE**, *v. t.* To deprive of dukedom.

**UNDULANT**, *a.* Undulatory.

**UNDULARY**, *a.* [L. *undula*, a little wave.] Playing like waves; waving.

**UNDULATE**, } *a.* Wavy; having a  
**UNDULATED**, } waved surface. In *bot.*, an epithet for a leaf, having the limb near the margin waved; as in *Reseda lutea*.

**UNDULATE**, *v. t.* [L. *undula*, a little wave; *unda*, a wave; Low L. *undulo*.] To move back and forth, or up and down, as waves; to cause to vibrate.

Breath vocalized, that is, vibrated and *undulated*. *Holder.*

**UNDULATE**, *v. i.* To vibrate; to move back and forth; to wave; as, *undulating* air.

**UNDULATING**, *ppr.* Waving; vibrating.—2. *a.* Wavy; rising and falling. A surface, as of land, is said to be *undulating* or *undulated*, when it presents a succession of elevations and depressions, resembling the waves of the sea. A country alternately hill and dale is said to be *undulating*.

**UNDULATINGLY**, *adv.* In the form of waves.

**UNDULA'TION**, *n.* [from *undulate*.] A waving motion or vibration.—*Undulations*, in *physics*, are vibrations resembling waves, propagated in succession through some fluid medium by impulses communicated to the medium; as, the *undulations* of water or air; the *undulations* of sound. The *undulations* of a fluid are propagated in concentric circles. [See **SOUND**, **WAVE**.]—2. In *med.*, a particular uneasy sensation of an undulatory motion in the heart.—3. In *music*, a rattling or jarring of sounds, as when discordant notes are sounded together. It is called also *beat*.—4. In *sur.*, a certain motion of the matter of an abscess when pressed, which indicates its fitness for opening.

**UNDULATORY**, *a.* [from *undulate*.] Moving in the manner of waves; or resembling the motion of waves, which successively rise or swell and fall. We speak of the *undulatory* motion of water, of air, or other fluid, and this *undulatory* motion of air is supposed to be the cause of sounds. This is

sometimes called *vibratory*; but *undulatory* seems to be most correct.—*Undulatory theory*, in *optics*, the hypothesis, according to which the phenomena of light are explained by the supposed vibrations or undulations of an ethereal medium, set in motion by the luminous body. This theory is opposed to the *theory of emanations*, or, as it is sometimes called, the *emission theory*, or *material theory*, according to which light is a material fluid of extreme subtilty. According to the former theory, the universe is filled with an ether or medium of great elasticity and rarity, which transmits light in the same manner as air transmits sound, and the impression is conveyed from the luminous body to the eye by successive undulations of this medium, occasioned by the luminous body; according to the latter theory, the luminous body constantly throws off material particles in every direction, which proceed in straight lines, and these particles falling upon the eye produce vision. Neither the undulatory nor material theory can be said to be satisfactorily established; but it would seem that every phenomenon which can be brought under the latter, can also, with equal facility, be explained by the former; while there are some known effects, as the phenomena of inflexion, in strict accordance with the former, which cannot, without great difficulty, and the introduction of gratuitous suppositions, be accounted for by the latter. Hence the undulatory theory has been more generally adopted in the investigations of modern philosophers.

**UNDULL**, } *v. t.* To remove dullness or  
**UNDULLY**, } obscurity; to clear; to purify.

**UNDULY**, *adv.* Not according to duty or propriety.—2. Not in proper proportion; excessively. His strength was *unduly* exerted.

**UNDURABLE**, } *a.* Not durable; not  
lasting.

**UNDUST**, } *v. t.* To free from dust.

**UNDUTEOUS**, *a.* Not performing duty to parents and superiors; not obedient; as, an *undutious* child, apprentice, or servant.

**UNDUTIFUL**, *a.* Not obedient; not performing duty; as, an *undutiful* son or subject.

**UNDUTIFULLY**, *adv.* Not according to duty; in a disobedient manner.

**UNDUTIFULNESS**, *n.* Want of respect; violation of duty; disobedience; as, the *undutifulness* of children or subjects.

**UNDY**, *a.* In *her.* [See **UNDE**.]

**UNDY'ING**, *a.* Not dying; not perishing.—2. Not subject to death; immortal; as, the *undyng* souls of men.

**UNEARNED**, *a.* (unern'ed.) Not merited by labour or services.

Hoping heaven will bless

Thy slighted fruits, and give thee bread  
*unearned.* *Philips.*

**UNEARTH**, } *v. t.* To drive from the  
earth; to uncover.

**UNEARTHED**, } *a.* (unerth'ed.) Driven  
from a den, cavern, or burrow.

**UNEARTHLY**, } *a.* (unerth'ly.) Not  
terrestrial.

**UNEASILY**, *adv.* (*s* as *z*.) With uneasiness or pain.

He lives *uneasily* under the burden.

*L'Estrange.*

2. With difficulty; not readily.

**UNEASINESS**, *n.* A moderate degree of pain; restlessness; want of ease; dis-

quiet.—2. Unquietness of mind; moderate anxiety or perturbation; disquietude.—3. That which makes uneasy or gives trouble; ruggedness; as, the *uneasiness* of the road. [*Unusual*.]

UNEASY, *a.* (*s* as *z*.) Feeling some degree of pain; restless; disturbed; unquiet. The patient is *uneasy*.—2. Giving some pain; as, an *uneasy* garment.—3. Disturbed in mind; somewhat anxious; unquiet. He is *uneasy* respecting the success of his project.

The soul, *uneasy* and confin'd from home,  
Rests and expatiates in a life to come.

Pope.

4. Constraining; cramping; as, *uneasy* stiff.—5. Constrained; stiff; not graceful; not easy; as, an *uneasy* deportment.—6. Giving some pain to others; disagreeable; unpleasing.

A sour, untractable nature makes him *uneasy* to those who approach him.

Spectator.

7. Difficult.

Things...so *uneasy* to be satisfactorily understood.†

Boyle.

UNEATABLE, *a.* Not eatable; not fit to be eaten.

UNEATEN, *a.* Not eaten; not devoured.

UNEATH,† *adv.* [*un* and Sax. *earth*, easy.] 1. Not easily.—2. Beneath; below. [See NEITHER and BENEATH.]

UNECHOING, *a.* Not echoing.

UNECLIPSED, *a.* Not eclipsed; not obscured.

UNECONOMICAL, *a.* Not economical.

UNEDIFIED, *a.* Not edified.

UNEDIFYING, *a.* Not edifying; not improving to the mind.

UNEDIFYINGLY, *adv.* Not in an edifying manner.

UNEDUCATED,† *a.* Not educated; UNEDUCATE, } illiterate.

UNEFFACED, *a.* Not effaced; not obliterated.

UNEFFECTED, *a.* Not effected or performed.

UNEFFECTUAL, *a.* Ineffectual. [*The latter is the word now used.*]

UNELABORATE, } *a.* Finished  
UNELABORATED, } with little labour or study.

UNELASTIC, *a.* Not elastic; not having the property of recovering its original state, when bent or forced out of its form. [*Inelastic is more generally used.*]

UNELASTICITY, *n.* State of being unelastic. [*Inelasticity is more generally used.*]

UNELATED, *a.* Not elated; not puffed up.

UNELBOWED, *a.* Not attended by any at the elbow.

UNELECTED, *a.* Not elected; not chosen; not preferred.

UNELEGANT,† *a.* Not elegant. [See INELEGANT.]

UNELEGIBLE, *a.* Not proper to be chosen; ineligible. [*The latter is the word now used.*]

UNEMANCIPATED, *a.* Not emancipated or liberated from slavery.

UNEMBALMED, *a.* Not embalmed.

UNEMBARRASSED, *a.* Not embarrassed; not perplexed in mind; not confused. The speaker appeared *unembarrassed*.—2. Free from pecuniary difficulties or incumbrances. He or his property is *unembarrassed*.—3. Free from perplexing connection; as, the question comes before the court *unembarrassed* with irrelevant matter.

UNEMBELLISHED, *a.* Not embellished.

UNEMBODIED, *a.* Free from a corporeal body; as, *unembodied* spirits.—2. Not embodied; not collected into a body; as, *unembodied* militia.

UNEMPHATIC, } *a.* Having no  
UNEMPHATICAL, } emphasis.  
UNEMPHATICALLY, *adv.* Without energy or emphasis.

UNEMPLOYED, *a.* Not employed; not occupied; not busy; at leisure; not engaged.—2. Not being in use; as, *unemployed* capital or money.

UNEMPPOWERED, *a.* Not empowered or authorized.

UNEMP'TIABLE,† *a.* Not to be emptied; inexhaustible.

UNEMP'TIED, *a.* Not emptied.

UNEMPLATING, *a.* Not emulating; not striving to excel.

UNENCHANTED, *a.* Not enchanted; that cannot be enchanted.

UNENCOUNTERED, *a.* Not encountered.

UNENCUMBER, *v. t.* To free from incumbrance.

UNENCUMBERED, *pp.* Disengaged from incumbrance.—2. *a.* Not encumbered; not burdened.

UNENDANGERED, *a.* Not endangered.

UNENDÉARED, *a.* Not attended with endearment.

UNENDEAVOURING, *a.* Making no effort.

UNENDED, *a.* Not ended.

UNENDING, *a.* Not ending.

UNENDORS'ED, *a.* Not endorsed.

UNENDOWED, *a.* Not endowed; not furnished; not invested; as, a man *unendowed* with virtues.—2. Not furnished with funds; as, an *unendowed* college or hospital.

UNENDURABLE, *a.* Not to be endured; intolerable.

UNENDURABLY, *adv.* So as not to be endured.

UNENDURING, *a.* Not lasting; of temporary duration.

UNENERV'ATED, *a.* Not enervated or weakened.

UNENFEEBLED, *a.* Not enfeebled.

UNENGA'GED, *a.* Not engaged; not bound by covenant or promise; free from obligation to a particular person; as, a lady is *unengaged*.—2. Free from attachment that binds; as, her affections are *unengaged*.—3. Unemployed; unoccupied; not busy.—4. Not appropriated; as, *unengaged* revenues. [We generally say, *unappropriated* revenue or money.]

UNENGA'GING, *a.* Not adapted to engage or win the attention or affections; not inviting.

UNENGLISH, *a.* Not English.

UNENGROSS'ED, *a.* Not engrossed.

UNENJOYED, *a.* Not enjoyed; not obtained; not possessed.

UNENJOYING, *a.* Not using having no fruition.

UNENLARGED, *a.* Not enlarged; narrow.

UNENLIGHTENED, *a.* Not enlightened; not illuminated.

UNENLIVENED, *a.* Not enlivened.

UNENSLAVED, *a.* Not enslaved; free.

UNENTAN'GLE, *v. t.* To free from complication or perplexity; to disentangle.

UNENTAN'GLED, *pp.* Disentangled.—2. *a.* Not entangled; not complicated; not perplexed.

UNENTERED, *a.* Not entered.

UNENTERPRISING, *a.* Not enterprising; not adventurous.

UNENTERPRISINGLY, *adv.* Without enterprise.

UNENTERTAINING, *a.* Not entertaining or amusing; giving no delight.

UNENTERTAININGLY, *adv.* Without entertainment.

UNENTERTAININGNESS, *n.* The quality of being unentertaining or dull.

UNENTHRALL'ED, *a.* Not enslaved; not reduced to thraldom.

UNENTOMBED, *a.* Not buried; not interred.

UNENTOMOLOGICAL, *a.* Not entomological.

UNENUMERATED, *a.* Not numbered; not included among enumerated articles.

UNENVIABLE, *a.* Not enviable.

UNENVIED, *a.* Not envied; exempt from the envy of others.

UNENVIOUS, *a.* Not envious; free from envy.

UNENVYING, *a.* Not envying.

UNEPIS'OPAL, *a.* Not episcopal.

UNEP'TAPHED, *a.* Having no epitaph.

UNE'QUABLE, *a.* Different from itself; different at different times; not uniform; diverse; as, *unequable* motions; *unequable* months or seasons.

UNEQUAL, *a.* [L. *inequalis*.] 1. Not equal; not even; not of the same size, length, breadth, quantity, &c.; as, men of *unequal* stature; houses of *unequal* dimensions.—2. Not equal in strength, talents, acquirements, &c.; inferior.—3. Not equal in age or station; inferior.—4. Insufficient; inadequate. His strength is *unequal* to the task.—5. Partial; unjust; not furnishing equivalents to the different parties; as, an *unequal* peace; an *unequal* bargain.—6. Disproportioned; ill matched.

Against *unequal* arms to fight in pain.

Milton.

7. Not regular; not uniform; as, *unequal* pulsations.—8. In *bot.*, having the parts not corresponding in size, but in proportion only, as a corol; rugged; not even or smooth, as the surface of a leaf or stem. An *unequal leaf*, is when the two halves, separated by the mid-rib, are unequal in dimensions, and their bases not parallel; called also an *oblique leaf*.

UNE'QUALLABLE, *a.* Not to be equalled.

UNE'QUALLED, *a.* Not to be equalled; unparalleled; unrivalled; in a good or bad sense; as, *unequaled* excellence; *unequaled* ingratitude or baseness.

UNE'QUALLY, *adv.* Not equally; in different degrees; in disproportion to each other.—2. Not with like sentiments, temper, or religious opinions or habits; 2 Cor. vi.

UNE'QUALNESS, *n.* State of being unequal; inequality.

UNE'QUITABLE, *a.* Not equitable; not just.—2. Not impartial. [*Inequitable is generally used.*]

UNE'QUITABLY,† *adv.* Inequitably.

UNEQUIVOCAL, *a.* Not equivocal; not doubtful; clear; evident; as, *unequivocal* evidence.—2. Not ambiguous; not of doubtful signification; not admitting different interpretations; as, *unequivocal* words or expressions.

UNEQUIVOCALLY, *adv.* Without doubt; without room to doubt; plainly; with full evidence.



UNEQUIVOCALNESS, *n.* State of being unequivocal.  
 UNERADICABLE, *a.* That cannot be eradicated.  
 UNERADICATED, *a.* Not eradicated; not exterminated.  
 UNERABLE, *a.* Incapable of erring; infallible.  
 UNERABLENESS, *n.* Incapacity of error.  
 UNERRING, *a.* Committing no mistake; incapable of error; as, the *unerring* wisdom of God.—2. Incapable of failure; certain. He takes *unerring* aim.  
 UNERRINGLY, *adv.* Without mistake.  
 UNESCHEWABLE, † *a.* Unavoidable.  
 UNESCUTCHED, *a.* Not having a coat of arms or ensign.  
 UNESPIED, *a.* Not espied; not discovered; not seen.  
 UNESSAYED, *a.* Not essayed; unattempted.  
 UNESSENTIAL, *a.* Not essential; not absolutely necessary; not of prime importance.—2. Not constituting the essence.—3. Void of real being; as, *unessential* night.  
 UNESSENTIAL, *n.* Something not constituting essence, or not of absolute necessity. Forms are among the *unessentials* of religion.  
 UNESSENTIALLY, *adv.* Not essentially.  
 UNESTABLISH, *v. t.* To unfix; to deprive of establishment. [*Little used.*]  
 UNESTABLISHED, *a.* Not established; not permanently fixed.  
 UNETH, † *adv.* Scarcely; hardly. [Spelled also *unearth* and *unmeth.*]  
 UNEUCHARISTICAL, *a.* Not eucharistical.  
 UNEVADABLE, *a.* That cannot be evaded.  
 UNEVANGELICAL, *a.* Not orthodox; not according to the gospel.  
 UNEVANGELIZED, *a.* Not evangelized.  
 UNEVAPORATED, *a.* Not evaporated.  
 UNEVEN, *a.* (*une'vn.*) Not even; not level; as, an *uneven* road or way; *uneven* ground.—2. Not equal; not of equal length.  
 Hebrew verse consists of *uneven* feet. *Peacham.*  
 3. Not uniform; as, an *uneven* temper.—*Uneven number, in arith.,* an odd number; a number not divisible by 2.  
 UNEVENLY, *adv.* In an uneven manner.  
 UNEVENNESS, *n.* Surface not level; inequality of surface; as, the *unevenness* of ground or of roads.—2. Turbulence; change; want of uniformity; as, the *unevenness* of king Edward's reign. [*Unusual.*].—3. Want of uniformity; as, *unevenness* of temper.—4. Want of smoothness.  
 UNEVENTFUL, *a.* Not eventful.  
 UNEVITABLE, *a.* Not to be escaped; unavoidable. [The word now used is *inevitable.*]  
 UNEVOLVED, *pp.* Not evolved.  
 UNEXACT, *a.* Not exact. [See *INEXACT*, which is generally used.]  
 UNEXACTED, *a.* Not exacted; not taken by force.  
 UNEXAGGERATED, *a.* Not exaggerated.  
 UNEXAGGERATING, *a.* Not enlarging in description.  
 UNEXALTED, *a.* Not exalted.  
 UNEXAMINABLE, *a.* Not to be examined or inquired into.

UNEXAMINED, *a.* Not examined; not interrogated strictly; as a witness.—2. Not inquired into; not investigated; as a question.—3. Not discussed; not debated.  
 UNEXAMINING, *a.* Not examining; not given to examination.  
 UNEXAMPLED, *a.* Having no example or similar case; having no precedent; unprecedented; unparalleled; as, the *unexampled* love and sufferings of our Saviour.  
 UNEXCELLED, *a.* Not excelled.  
 UNEXCEPTED, *a.* Not excepted.  
 UNEXCEPTIONABLE, *a.* Not liable to any exception or objection; unobjectionable; as, *unexceptionable* conduct; *unexceptionable* testimony.  
 UNEXCEPTIONABLENESS, *n.* State or quality of being unexceptionable.  
 UNEXCEPTIABLY, *adv.* In a manner liable to no objection; as, a point *unexceptionably* proved.  
 UNEXCISED, *a.* (*s* as *z.*) Not charged with the duty of excise.  
 UNEXCITED, *a.* Not excited; not roused.  
 UNEXCLUDED, *a.* Not excluded.  
 UNEXCLUSIVE, *a.* Not exclusive.  
 UNEXCOGITABLE, † *a.* Not to be found out.  
 UNEXCOMMUNICATED, *a.* Not excommunicated.  
 UNEXCUSABLE, *a.* (*s* as *z.*) Not excusable. [We now use *inexcusable.*]  
 UNEXCUSABLENESS, *n.* Inexcusableness,—*which see.*  
 UNEXECUTED, *a.* Not performed; not done; as, a task, business, or project *unexecuted*.—2. Not signed or sealed; not having the proper attestations or forms that give validity; as, a contract or deed *unexecuted*.  
 UNEXEMPLARY, *a.* Not exemplary; not according to example.  
 UNEXEMPLIFIED, *a.* Not exemplified; not illustrated by example.  
 UNEXEMPT, *a.* Not exempt; not free by privilege.  
 UNEXERCISED, *a.* (*s* as *z.*) Not exercised; not practised; not disciplined; not experienced.  
 UNEXERTED, *a.* Not called into action; not exerted.  
 UNEXHAUSTED, *a.* Not exhausted; not drained to the bottom, or to the last article.—2. Not spent; as, *unexhausted* patience or strength.  
 UNEXHAUSTIBLE, † *a.* Inexhaustible.  
 UNEXISTENT, *a.* Not existing.  
 UNEXISTING, *a.* Not existing.  
 UNEXORCISED, *a.* (*s* as *z.*) Not exorcised; not cast out by exorcism.  
 UNEXPANDED, *a.* Not expanded; not spread out.  
 UNEXPECTATION, † *n.* Want of foresight.  
 UNEXPECTED, *a.* Not expected; not looked for; sudden; not provided against.  
 UNEXPECTEDLY, *adv.* At a time or in a manner not expected or looked for; suddenly.  
 UNEXPECTEDNESS, *n.* The quality of being unexpected, or of coming suddenly and by surprise.  
 UNEXPECTORATING, *a.* Not expectorating; not discharging from the lungs.  
 UNEXPELIENT, † *a.* Not expellent.  
 UNEXPENDED, *a.* Not expended; not laid out. There is an *unexpended* balance of the appropriation.  
 UNEXPENSIVE, *a.* Not expensive; not costly.

UNEXPERIENCED, *a.* Not experienced; not versed; not acquainted by trial or practice.—2. Untried; *applied to things.* [*Unusual.*]  
 UNEXPERIMENTAL, *a.* Not experimental.  
 UNEXPERT, *a.* Wanting skill; not ready or dextrous in performance.  
 UNEXPERTLY, *adv.* Inexpertly; without skill.  
 UNEXPIRED, *a.* Not expired; not ended.  
 UNEXPLAINABLE, *a.* That cannot be explained.  
 UNEXPLAINED, *a.* Not explained; not interpreted; not illustrated.  
 UNEXPLICATED, *a.* Not explicated.  
 UNEXPLORED, *a.* Not explored; not searched or examined by the eye; unknown.—2. Not examined intellectually.  
 UNEXPLOSIVE, *a.* Not explosive.  
 UNEXPORTED, *a.* Not exported; not sent abroad.  
 UNEXPOSED, *a.* (*s* as *z.*) Not laid open to view; concealed.—2. Not laid open to censure.  
 UNEXPOUNDED, *a.* Not expounded; not explained.  
 UNEXPRESSED, *a.* Not expressed; not mentioned or named; not exhibited.  
 UNEXPRESSIBLE, † *a.* That cannot be expressed; inexpressible.  
 UNEXPRESSIBLY, † *adv.* Inexpressibly.  
 UNEXPRESSIVE, *a.* Not having the power of expressing.—2. Inexpressible; unutterable.  
 UNEXPRESSIVELY, *adv.* Inexpressibly; unutterably.  
 UNEXPUNGED, *a.* Not expunged.  
 UNEXTENDED, *a.* Occupying no assignable space; having no dimensions; as, a spiritual, an *unextended* substance.  
 UNEXTINCT, *a.* Not extinct; not being destroyed; not having perished.  
 UNEXTINGUISHABLE, *a.* That cannot be extinguished; unquenchable; as, *unextinguishable* fire.—2. That cannot be annihilated or repressed; as, an *unextinguishable* thirst for knowledge. [But *unextinguishable* is more generally used.]  
 UNEXTINGUISHABLY, *adv.* In a manner or degree that precludes extinction.  
 UNEXTINGUISHED, *a.* Not extinguished; not quenched; not entirely repressed.  
 UNEXTIRPATED, *a.* Not extirpated; not rooted out.  
 UNEXTORTED, *a.* Not extorted; not wrested.  
 UNEXTRACTED, *a.* Not extracted or drawn out.  
 UNEXTRICABLE, † *a.* Inextricable.  
 UNFADED, *a.* Not faded; not having lost its strength of colour.—2. Unwithered; as a plant.  
 UNFADING, *a.* Not liable to lose strength or freshness of colour.—2. Not liable to wither; as, *unfading* laurels.  
 UNFADINGLY, *adv.* In an unfading manner.  
 UNFADINGNESS, *n.* The state or quality of being unfading.  
 UNFAILABLE, † *a.* That cannot fail.  
 UNFAILABLENESS, † *n.* The quality of being unfaillable.  
 UNFAILING, *a.* Not liable to fail; not capable of being exhausted; as, an *unfailing* spring; *unfailing* sources of supply.—2. That does not fail; certain; as, an *unfailing* promise.  
 UNFAILINGLY, *adv.* Without failure.

**UNFAILINGNESS**, *n.* The state of being unfailing.

**UNFAINTING**, *a.* Not fainting; not sinking; not failing under toil.

**UNFAIR**, *a.* Not honest; not impartial; disingenuous; using trick or artifice; as, an *unfair* dealer.—2. Not honest; not just; not equal; as, *unfair* practices.—3. Proceeding from trick or dishonesty; as, *unfair* advantages.

**UNFAIRLY**, *adv.* Not in a just or equitable manner.

**UNFAIRNESS**, *n.* Dishonest or disingenuous conduct or practice; use of trick or artifice; *applied to persons.* He is noted for his *unfairness* in dealing.—2. Injustice; want of equitableness; as, the *unfairness* of a proceeding.

**UNFAITHFUL**, *a.* Not observant of promises, vows, allegiance, or duty; violating trust or confidence; treacherous; perfidious; as, an *unfaithful* subject; an *unfaithful* husband or wife; an *unfaithful* servant; an *unfaithful* bailee or agent.—2. Not performing the proper duty.  
My feet through wine *unfaithful* to their weight. *Pope.*

**3.** Impious; infidel.—4. Negligent of duty; as, an *unfaithful* workman.

**UNFAITHFULLY**, *adv.* In violation of promises, vows, or duty; treacherously; perfidiously.—2. Negligently; imperfectly; as, work *unfaithfully* done.

**UNFAITHFULNESS**, *n.* Neglect or violation of vows, promises, allegiance, or other duty; breach of confidence or trust reposed; perfidiousness; treachery; as, the *unfaithfulness* of a subject to his prince or the state; the *unfaithfulness* of a husband to his wife, or of a wife to her husband; the *unfaithfulness* of an agent, servant, or officer.

**UNFALCATED**, *a.* Not curtailed; having no deductions.

**UNFALLIBLE**, *† a.* Infallible.

**UNFALL'EN**, *a.* Not fallen.

**UNFALLOWED**, *a.* Not followed.

**UNFALTERING**, *a.* Not faltering; not failing; not hesitating.

**UNFALTERINGLY**, *adv.* Without faltering; unhesitatingly.

**UNFAMED**, *a.* Not renowned.

**UNFAMILIAR**, *a.* Not accustomed; not common; not rendered agreeable by frequent use.

**UNFAMILIARITY**, *n.* Want of familiarity.

**UNFAMILIARLY**, *adv.* Not familiarly.

**UNFANN'ED**, *a.* Not fanned.

**UNFASCINATED**, *a.* Not fascinated.

**UNFASCINATING**, *a.* Not fascinating.

**UNFASHIONABLE**, *a.* Not fashionable; not according to the prevailing mode; as, *unfashionable* dress or language.—2. Not regulating dress or manners according to the reigning custom; as, an *unfashionable* man.

**UNFASHIONABLENESS**, *n.* Neglect of the prevailing mode; deviation from reigning custom.

**UNFASHIONABLY**, *adv.* Not according to the fashion; as, to be *unfashionably* dressed.

**UNFASHIONED**, *a.* Not modified by art; amorphous; shapeless; not having a regular form; as, a lifeless lump *unfashioned*.

**UNFAST**, *a.* Not safe; not secure.

**UNFASTEN**, *v. t.* To loose; to unfix; to unbind; to untie.

**UNFASTENED**, *pp.* Loosed; untied; unfixed.

**UNFASTING**, *a.* Not fasting.

**UNFATHERED**, *a.* Fatherless.

**UNFATHERLY**, *a.* Not becoming a father; unkind.

**UNFATHOMABLE**, *a.* That cannot be sounded by a line; as, an *unfathomable* lake.—2. So deep or remote that the limit or extent cannot be found. The designs of Providence are often *unfathomable*.

**UNFATHOMABLENESS**, *n.* The state of being unfathomable.

**UNFATHOMABLY**, *adv.* So as not to be capable of being sounded.

**UNFATH'OMED**, *a.* Not sounded; not to be sounded.

**UNFATIGUED**, *a.* (unfatee'gd.) Not wearied; not tired.

**UNFAULTY**, *a.* Free from fault; innocent.

**UNFAVOURABLE**, *a.* Not favourable; not propitious; not disposed or adapted to countenance or support. We found the minister's opinion *unfavourable* to our project. The committee made a report *unfavourable* to the petitioner.—2. Not propitious; not adapted to promote any object; as, weather *unfavourable* for harvest.—3. Not kind; not obliging.—4. Discouraging; as, *unfavourable* prospects.

**UNFAVOURABLENESS**, *n.* Unpropitiousness; unkindness; want of disposition to countenance or promote.

**UNFAVOURABLY**, *adv.* Unpropitiously; unkindly; so as not to countenance, support, or promote; in a manner to discourage.

**UNFAV'ORED**, *a.* Not favoured; not assisted.

**UNFEARED**, *a.* Not affrighted; not daunted.—2. Not feared; not dreaded.

**UNFEARFUL**, *a.* Not fearful; courageous.

**UNFEARING**, *a.* Not fearing.

**UNFEARINGLY**, *adv.* Without fear.

**UNFEASIBLE**, *a.* (s as z.) That cannot be done; impracticable.

**UNFEATHERED**, *a.* Having no feathers; unfeathered; implumous; naked of feathers.

**UNFEATURED**, *a.* Wanting regular features; deformed.  
Visage rough,  
Deformed, *unfeatured.* *Dryden.*

**UNFED**, *a.* Not fed; not supplied with food.

**UNFEED**, *a.* Not feed; not retained by a fee.—2. Unpaid; as, an *unfeed* lawyer.

**UNFEELING**, *a.* Insensible; void of sensibility.—2. Cruel; hard.

**UNFEELINGLY**, *adv.* In an unfeeling or cruel manner.

**UNFEELINGNESS**, *n.* Insensibility; hardness of heart; cruelty.

**UNFEIGNED**, *a.* Not feigned; not counterfeit; not hypocritical; real; sincere; as, *unfeigned* piety to God; *unfeigned* love to man.

**UNFEIGNEDLY**, *adv.* Without hypocrisy; really; sincerely.  
He pardoneth all them that truly repent,  
and *unfeignedly* believe his holy gospel.  
*Com. Prayer.*

**UNFEIGN'EDNESS**, *n.* Sincerity.

**UNFEIGN'ING**, *a.* Not feigning.

**UNFELICITATING**, *a.* Not producing felicity. [*Unusual.*]

**UNFEL'LOWED**, *a.* Not matched.

**UNFELT**, *a.* Not felt; not perceived.

**UNFEMININE**, *a.* Not feminine; not according to the female character or manners.

**UNFENCE**, *v. t.* (unfens'.) To strip of fence; to remove a fence from.

**UNFENCED**, *pp.* Deprived of a fence.

**2. a.** Not fenced; not inclosed; defenceless; as, a tract of land *unfenced*.

**UNFERMENT'ED**, *a.* Not fermented; not having undergone the process of fermentation; as liquor.—2. Not leavened; as bread.

**UNFER'TILE**, *a.* Not fertile; not rich; not having the qualities necessary to the production of good crops.—2. Barren; unfruitful; bare; waste.—3. Not prolific. [This word is much used instead of it.]

**UNFER'TILENESS**, *n.* State of being unfruitful.

**UNFETTER**, *v. t.* To loose from fetters; to unchain; to unshackle.—2. To free from restraint; to set at liberty; as, to *unfetter* the mind.

**UNFETTERED**, *pp.* Unchained; unshackled; freed from restraint.—2. *a.* Not restrained.

**UNFETTERING**, *ppr.* Unchaining; setting free from restraint.

**UNFEUDALIZE**, *v. t.* To free from feudalism.

**UNFIGURED**, *a.* Representing no animal form.

**UNFILIAL**, *a.* Unsuitable to a son or child; undutiful; not becoming a child.

**UNFILIALLY**, *adv.* In a manner unbecoming a child.

**UNFILL'ED**, *a.* Not filled; not fully supplied.

**UNFILM'ED**, *a.* Not covered with a film.

**UNFINISHED**, *a.* Not finished; not complete; not brought to an end; imperfect; wanting the last hand or touch; as, an *unfinished* house; an *unfinished* painting.

**UNFIRM**, *a.* Not fired; not inflamed.

**UNFIRM**, *a.* [See FIRM.] Not firm; weak; feeble; infirm.  
*Note.*—When we speak of the weakness of the human frame, we use *infirm*. When we speak of the weakness of other things, as a bridge, wall, and the like, we say, it is *infirm*.

**2.** Not stable; not well fixed.  
With feet *infirm.* *Dryden.*

**UNFIRMNESS**, *n.* A weak state; instability.

**UNFIT**, *a.* Not fit; improper; unsuitable.—2. Unqualified; as, a man *unfit* for an office.

**UNFIT**, *v. t.* To disable; to make unsuitable; to deprive of the strength, skill, or proper qualities for any thing. Sickness *unfits* a man for labour.—2. To disqualify; to deprive of the moral or mental qualities necessary for anything. Sin *unfits* us for the society of holy beings.

**UNFITLY**, *adv.* Not properly; unsuitably.

**UNFITNESS**, *n.* Want of suitable powers or qualifications, physical or moral; as, the *unfitness* of a sick man for labour, or of an ignorant man for office; the *unfitness* of sinners for the enjoyment of heaven.—2. Want of propriety or adaptation to character or place; as, *unfitness* of behaviour or of dress.

**UNFITTED**, *pp.* Rendered unsuitable; disqualified.

**UNFITTING**, *ppr.* Rendering unsuitable; disqualifying.—2. *a.* Improper; unbecoming.

**UNFIX**, *v. t.* To loosen from any fastening; to detach from any thing that holds; to unsettle; to unhinge; as, to *unfix* the mind or affections.—2. To make fluid; to dissolve.  
Nor can the rising sun  
*Unfix* their frosts. *Dryden.*

UNFIX'ED, *pp.* Unsettled; loosened.—2. *a.* Wandering; erratic; inconstant; having no settled habitation.—3. Having no settled view or object of pursuit.

UNFIX'EDNESS, *n.* The state of being unsettled.

UNFIX'ING, *ppr.* Unsettling; loosening.

UNFLAG'GING, *a.* Not flagging; not drooping; maintaining strength or spirit.

UNFLANK'ED, *a.* Not flanked.

UNFLATTERED, *a.* Not flattered.

UNFLATTERING, *a.* Not flattering; not gratifying with obsequious behaviour; not colouring the truth to please.—2. Not affording a favourable prospect; as, the weather is *unflattering*.

UNFLATTERINGLY, *adv.* Without flattery.

UNFLEDG'ED, *a.* Not yet furnished with feathers; implumous; as, an *unfledged* bird.—2. Young; not having attained to full growth.

UNFLESH'ED, *a.* Not fleshed; not seasoned to blood; raw; as, an *unfleshed* hound; *unfleshed* valour.

UNFLINCH'ING, *a.* Not flinching; not shrinking.

UNFLIT'TING, *a.* Not flitting.

UNFLOWERING, *a.* Not flowering.

UNFOILED, *a.* Not vanquished; not defeated.

UNFOLD, *v. t.* To open folds; to expand; to spread out.—2. To open any thing covered or close; to lay open to view or contemplation; to disclose; to reveal; as, to *unfold* one's designs; to *unfold* the principles of a science.—3. To declare; to tell; to disclose.

*Unfold* the passion of my love. *Shak.*

4. To display; as, to *unfold* the works of creation.—5. To release from a fold or pen; as, to *unfold* sheep.

UNFOLDED, *pp.* Opened; expanded; revealed; displayed; released from a fold.

UNFOLDER, *n.* One who unfolds or discloses.

UNFOLDING, *ppr.* Opening; expanding; disclosing; displaying; releasing from a fold.

UNFOLDING, *n.* The act of expanding, displaying, or disclosing; disclosure.

UNFOL'LOWED, *a.* Not followed.

UNFOOL', *v. t.* To restore from folly.

UNFORBEARING, *a.* Not forbearing.

UNFORBID', } *a.* Not forbid; not  
UNFORBID'DEN, } prohibited; *applied* to persons.—2. Allowed; permitted; legal; *applied* to things.

UNFORBID'DENNESS, *n.* The state of being unforbidden.

UNFORCED, *a.* Not forced; not compelled; not constrained.—2. Not urged or impelled.—3. Not feigned; not heightened; natural; as, *unforced* passions; *unforced* expressions of joy.—4. Not violent; easy; gradual; as, an easy and *unforced* ascent.—5. Easy; natural; as, an *unforced* posture.

UNFORCIBLE, *a.* Wanting force or strength; as, an *unforcible* expression.

UNFORDABLE, *a.* Not fordable; that cannot be forded, or passed by wading; as, an *unfordable* river.

UNFORDED, *a.* Not forded.

UNFOREBODING, *a.* Giving no omens.

UNFOREKNOWN, *a.* Not previously known or foreseen.

UNFORESEE'ABLE, *† a.* That cannot be foreseen.

UNFORESEEING, *a.* Not foreseeing.

UNFORESEEN, *a.* Not foreseen; not foreknown.

UNFÖRESKINNED, *a.* Circumcised. [*Bad.*]

UNFORETOLD, *a.* Not predicted.

UNFOREWARN'ED, *a.* [See WARN.] Not previously warned or admonished.

UNFOR'FEITED, *a.* Not forfeited.

UNFORGET'FUL, *a.* Not forgetful.

UNFORGIV'EN, *a.* Not forgiven; not pardoned.

UNFORGIV'ING, *a.* Not forgiving; not disposed to overlook or pardon offences; implacable.

UNFORGOT', } *a.* Not forgot; not  
UNFORGOT'TEN, } lost to memory.—2. Not overlooked; not neglected.

UNFORM', *v. t.* To destroy; to unmake; to decompose or resolve into parts.

UNFORM'AL, *a.* Not formal; informal.

UNFORM'ED, *pp.* Decomposed or resolved into parts.—2. *a.* Not moulded into regular shape; as, *unformed* matter.—*Unformed stars*, in *astron.*, such as are not included in any of the constellations.

UNFORSÄKEN, *n.* Not forsaken; not deserted; not entirely neglected.

UNFOR'TIFIED, *a.* Not fortified; not secured from attack by walls or mounds.—2. Not guarded; not strengthened against temptations or trials; weak; exposed; defenceless; as, an *unfortified* mind.—3. Wanting securities or means of defence.

UNFOR'TUNATE, *a.* Not successful; not prosperous; as, an *unfortunate* adventure; an *unfortunate* voyage; *unfortunate* attempts; an *unfortunate* man; an *unfortunate* commander; *unfortunate* business.

UNFOR'TUNATELY, *adv.* Without success; unsuccessfully; unhappily. The scheme *unfortunately* miscarried.

UNFOR'TUNATENESS, *n.* Ill luck; ill fortune; failure of success.

UNFOS'SILIZED, *a.* Not fossilized.

UNFOS'TERED, *a.* Not fostered; not nourished.—2. Not countenanced by favour; not patronized.

UNFOUGHT, *a.* (unfaut'.) Not fought.

UNFOUL'ED, *a.* Not fouled; not polluted; not soiled; not corrupted; pure.

UNFOUND', *a.* Not found; not met with.

UNFOUND'ED, *a.* Not founded; not built or established.—2. Having no foundation; vain; idle; as, *unfounded* expectations.

UNFOUND'EDLY, *adv.* In an idle or unfounded manner.

UNFRAG'GRANT, *a.* Not fragrant.

UNFRÄMABLE, *† a.* Not to be framed or moulded.

UNFRÄMABLENESS, *† n.* The quality of not being framable.

UNFRÄME, *† v. t.* To destroy the frame of.

UNFRAMED, *a.* Not framed; not fitted for erection; as, *unframed* timber.—2. Not formed; not constructed; not fashioned.

UNFRAN'CHISED, *a.* Not franchised.

UNFRATERN'AL, *a.* Not brotherly.

UNFRATERN'ALLY, *adv.* In an unbrotherly manner.

UNFREE', *a.* Not free; as *unfree* peasants.

UNFREIGHT'ED, *a.* Not freighted.

UNFRE'QUENCY, *n.* The state of being infrequent.

UNFRE'QUENT, *a.* Not frequent; not common; not happening often; infrequent.

UNFRE'QUENT', *† v. t.* To cease to frequent.

UNFRE'QUENT'ED, *a.* Rarely visited;

seldom resorted to by human beings; as, an *unfrequented* place or forest.

UNFRE'QUENTLY, *adv.* Not often; seldom.

UNFRU'ABLE, *a.* Not easily crumbled.

UNFRIEND', *† n.* One not a friend.

UNFRIEND'ED, *a.* (unfriend'ed.) Wanting friends; not countenanced or supported.

UNFRIEND'LINESS, *n.* Want of kindness; disfavour.

UNFRIEND'LY, *a.* Not friendly; not kind or benevolent; as, an *unfriendly* neighbour.—2. Not favourable; not adapted to promote or support any object; as, weather *unfriendly* to health.

UNFRIEND'SHIP, *† n.* State of being unfriendly.

UNFROCK', *v. t.* To divest; to uncover.

UNFROCK'ED, *pp.* Divested of a gown, &c.

UNFROZEN, *a.* Not frozen; not congealed.

UNFRUC'TED, *a.* Destitute of fruit; as, a branch.

UNFRU'GAL, *a.* Not frugal; not saving or economical.

UNFRUIT'FUL, *a.* Not producing fruit; barren; as, an *unfruitful* tree.—2. Not producing offspring; not prolific; barren; as, an *unfruitful* female.—3. Not producing good effects or works; as, an *unfruitful* life.—4. Unproductive; not fertile; as, an *unfruitful* soil.

UNFRUIT'FULLY, *adv.* Without producing fruit.

UNFRUIT'FULNESS, *n.* Barrenness; infecundity; unproductiveness; *applied* to persons or things.

UNFRUS'TRABLE, *a.* That cannot be frustrated.

UNFUL'FILLED, *a.* Not fulfilled; not accomplished; as, a prophecy or prediction *unfulfilled*.

UNFUMED, *a.* Not fumigated.—2. Not exhaling smoke; not burnt.

UNFUNDED, *a.* Not funded; having no permanent funds for the payment of its interest; as, an *unfunded* debt. *Unfunded debt* is the name given to that part of Government stock, for the payment of the interest of which no certain funds are set apart. The chief documents of this debt are exchequer and navy bills, which bear interest from their dates, or from six months after they are issued. These funds are held in law to be movable, and the right passes with the possession of the document.

UNFURL', *v. t.* To loose and unfold; to expand; to open or spread; as, to *unfurl* sails.

UNFURL'ED, *pp.* Unfolded; expanded.

UNFURL'ING, *ppr.* Unfolding; spreading.

UNFURN'ISH, *v. t.* To strip of furniture; to divest; to strip.—2. To leave naked.

UNFURN'ISHED, *pp.* Stripped of furniture; degarnished.

UNFURN'ISHED, *a.* Not furnished; not supplied with furniture; as, an *unfurnished* room or house.—2. Unsupplied with necessaries or ornaments.—3. Empty; not supplied.

UNFUR'ROWED, *a.* Not furrowed.

UNFUSED, *a.* (*s* as *z*.) Not fused; not melted.

UNFUSIBLE, *a.* (*s* as *z*.) Infusible. [*The latter word is generally used.*]

UNGAIN', *† a.* Ungainly.—2. Unprofitable.—3. Inconvenient.—4. Intractable.

UNGAINABLE, *a.* That cannot be gained. [*Little used.*]

UNGAINFUL, *a.* Unprofitable; not producing gain.  
 UNGAINFULLY, *adv.* Unprofitably.  
 UNGAINLINESS, *n.* Clumsiness; awkwardness.  
 UNGAINLY, *a.* [Sax. *ungægne.*] Not expert or dextrous; clumsy; awkward; ineouth; as, an *ungainly* strut in walking.  
 UNGALLANT, *a.* Not gallant.  
 UNGALLANTLY, *adv.* In an ungallant manner.  
 UNGALLED, *a.* Unhurt; not galled.  
 UNGARLANDED, *a.* Not crowned with a garland.  
 UNGARNISHED, *a.* Not garnished or furnished; unadorned.  
 UNGARRISONED, *a.* Not garrisoned; not furnished with troops for defence.  
 UNGARTERED, *a.* Being without garters.  
 UNGATHERED, *a.* Not gathered; not cropped; not picked.  
 UNGEAR, *v. t.* To unharness; to strip of gear.  
 UNGEARED, *pp.* Unharnessed.  
 UNGEARING, *ppr.* Stripping of harness or gear.  
 UNGELD, *n.* In *ancient English law*, a person out of the protection of the law; so that, if he were murdered, no *geld* or fine should be paid for his slaughter.  
 UNGENERATED, *a.* Having no beginning; unbegotten.  
 UNGENERATIVE, *a.* Begetting nothing.  
 UNGENEROUS, *a.* Not of a noble mind; not liberal; *applied to persons*; as, an *ungenerous* man or prince.—2. Not noble; not liberal; *applied to things*; as, an *ungenerous* act.—3. Dishonourable; ignominious.  
 The victor never will impose on Cato  
*Ungen'rous terms.* Addison.  
 UNGENEROUSLY, *adv.* Unkindly; dishonourably.  
 UNGENIAL, *a.* Not favourable to nature or to natural growth; as, *ungenial* air; *ungenial* soils.  
 Sullen seas that wash th' *ungenial* pole.  
 Thomson.  
 UNGENTEEL, *a.* Not genteel; *used of persons*; not consistent with polite manners or good breeding; *used of manners*.  
 UNGENTEELLY, *adv.* Uncivily; not with good manners.  
 UNGENTLE, *a.* Not gentle; harsh; rude.  
 UNGENTLEMANLIKE, *a.* Not like a gentleman.  
 UNGENTLEMANLINESS, *n.* The quality of being gentlemanlike.  
 UNGENTLEMANLY, *a.* Not becoming a gentleman.  
 UNGENTLENESS, *n.* Want of gentleness; harshness; severity; rudeness.—2. Unkindness; incivility.  
 UNGENTLY, *adv.* Harshly; with severity; rudely.  
 UNGEOMETRICAL, *a.* Not agreeable to the rules of geometry.  
 UNGIFTED, *a.* Not gifted; not endowed with peculiar faculties.  
 UNGILD'ED, } *a.* Not gilt; not over-  
 UNGILT, } laid with gold.  
 UNGILD'ING, } *a.* Not gilding.  
 UNGIRD, *v. t.* [See GIRD.] To loose from a girdle or band; to unbind; Gen. xxiv.  
 UNGIRD'ED, *pp.* Loosed from a girth or band.  
 UNGIRD'ING, *ppr.* Loosing from a girdle or band.

UNGIRT', *pp.* Unbound.—2. *a.* Loosely dressed.  
 UNGIV'EN, *a.* Not given or bestowed.  
 UNGIV'ING, *a.* Not bringing gifts.  
 UNGLAD'DENED, *a.* Not gladdened.  
 UNGLAZE, *v. t.* To strip of glass; to remove the glass from windows.  
 UNGLAZED, *a.* Deprived of glass; not furnished with glass; as, the windows are *unglazed*; the houses yet *unglazed*.—2. Wanting glass windows.—3. Not covered with vitreous matter; as, *unglazed* potters' ware.  
 UNGLAZING, *ppr.* Depriving of glass in windows.  
 UNGLO'RIFIED, *a.* Not glorified; not honoured with praise or adoration.  
 UNGLO'RIFY, *v. t.* To deprive of glory.  
 UNGLO'RIOUS, *a.* Not glorious; bringing no glory or honour.  
 UNGLOVE, } *v. t.* To take off the gloves.  
 UNGLOVED, } *a.* Having the hand naked.  
 [Little used.]  
 UNGLUE, *v. t.* To separate any thing that is glued or cemented.  
 UNGLU'ED, *pp.* Loosed from glue or cement.  
 UNGLU'ING, *ppr.* Separating what is cemented.  
 UNGOADED, *a.* Not goaded.  
 UNGOD', *v. t.* To divest of divinity.  
 UNGOD'ED, } *a.* Godless; atheistical.  
 UNGODLI'LY, } *adv.* Impiously; wickedly.  
 UNGOD'LINESS, *n.* Impiety; wickedness; disregard of God and his commands, and neglect of his worship; or any positive act of disobedience or irreverence.  
 The wrath of God is revealed from heaven against all *ungodliness*; Rom. 1.  
 UNGOD'LY, *a.* Wicked; impious; neglecting the fear and worship of God, or violating his commands; 1 Pet. iv.—2. Sinful; contrary to the divine commands; as, *ungodly* deeds; Jude iv.—3. Polluted by wickedness; as, an *ungodly* day.  
 UNGORED, *a.* Not gored; not wounded with a horn.—2. Not wounded.  
 UNGORG'ED, *a.* Not gorged; not filled; not sated.  
 UNGOT, } *a.* Not gained.—2. Not  
 UNGOT'TEN, } begotten.  
 UNGOVERNABLE, *a.* That cannot be governed; that cannot be ruled or restrained.—2. Licentious; wild; unbridled; as, *ungovernable* passions.  
 UNGOVERNABLENESS, *n.* State of being ungovernable.  
 UNGOVERNABLY, *adv.* So as not to be governed or restrained.  
 UNGOVERNED, *a.* Not being governed.—2. Not subjected to laws or principles; not restrained or regulated; unbridled; licentious; as, *ungoverned* appetite; *ungoverned* passions.  
 UNGOWN', *v. t.* To strip of a gown, as a clergyman.  
 UNGOWN'ED, *a.* Not having or not wearing a gown.  
 UNGOWN'ING, *ppr.* Depriving of a gown.  
 UNGRACED, *a.* Not graced.  
 UNGRACEFUL, *a.* Not graceful; not marked with ease and dignity; wanting beauty and elegance; as, *ungraceful* manners. Without politeness, learning is *ungraceful*.  
 UNGRACEFULLY, *adv.* Awkwardly; inelegantly.  
 UNGRACEFULNESS, *n.* Want of gracefulness; want of ease and dignity; want of elegance; awkwardness; as, *ungracefulness* of manners.  
 UNGRA'CIOUS, *a.* Wicked; odious;

hateful.—2. Offensive; unpleasing; as, *ungracious* manners.—3. Unacceptable; not well received; not favoured.  
 Any thing of grace toward the Irish rebels was as *ungracious* at Oxford as at London.  
 Clarendon.  
 UNGRA'CIOUSLY, *adv.* With disfavour. The proposal was received *ungraciously*.—2. Not in a pleasing manner.  
 UNGRA'CIOUSNESS, *n.* State of being ungracious.  
 UNGRAMMATICAL, *a.* Not according to the established and correct rules of grammar.  
 UNGRAMMATICALLY, *adv.* In a manner contrary to the rules of grammar.  
 UNGRANTED, *a.* Not granted; not yielded; not conceded in argument.  
 UNGRATE, } *a.* Not agreeable; un-  
 grateful.  
 UNGRATE, } *n.* [Fr. *ingrat.*] An un-  
 grateful person.  
 UNGRATEFUL, *a.* Not grateful; not feeling thankful for favours.—2. Not making returns, or making ill returns for kindness.—3. Making no returns for culture; as, an *ungrateful* soil.—4. Unpleasing; unacceptable. Harsh sounds are *ungrateful* to the ear.  
 UNGRATEFULLY, *adv.* With ingratitude.—2. Unpleasingly; unacceptably.  
 UNGRATEFULNESS, *n.* Ingratitude; want of due feelings of kindness for favours received; ill return for good.—2. Disagreeableness; unpleasing quality.  
 UNGRATIFIED, *a.* Not gratified; not compensated.—2. Not pleased.—3. Not indulged; as, *ungratified* appetite.  
 UNGRAVE, } *v. t.* To disinter.  
 UNGRAVELY, *adv.* Without gravity or seriousness.  
 UNGREGARIOUS, *a.* Not gregarious.  
 UNGROANING, *a.* Not groaning.  
 UNGROUND'ED, *a.* Having no foundation or support; as, *ungrounded* hopes or confidence.  
 UNGROUND'EDLY, *adv.* Without ground or support; without reason.  
 UNGROUND'EDNESS, *n.* Want of foundation or support.  
 UNGROWN', } *a.* Not grown; imma-  
 ture.  
 UNGRUDG'ED, *a.* Not grudging.  
 UNGRUDG'ING, *a.* Not grudging; freely giving.  
 UNGRUDG'INGLY, *adv.* Without ill will; heartily; cheerfully; as, to bestow charity *ungrudgingly*.  
 UNGUAL, *a.* [L. *unguis*, a nail, claw, or hoof.] In *zool.*, an epithet applied to such bones of the feet as have attached to them a nail, claw, or hoof.  
 UNGUARDED, *a.* Not guarded; not watched.—2. Not defended; having no guard.—3. Careless; negligent; not attentive to danger; not cautious; as, to be *unguarded* in conversation.—4. Negligently said or done; not done or spoken with caution; as, an *unguarded* expression or action.  
 UNGUARDEDLY, *adv.* Without watchful attention to danger; without caution; carelessly; as, to speak or promise *unguardedly*.  
 UNGUARDEDNESS, *n.* State of being unguarded.  
 UNGUENT, *n.* [L. *unguentum*, from *ungo*, to anoint.] Ointment; a soft composition used as a topical remedy, as for sores, burns, and the like. An unguent is stiffer than a liniment, but softer than a cerate.



UNHEDGED, *a.* Not hedged; not surrounded by a hedge.  
 UNHEEDED, *a.* Not heeded; disregarded; neglected.  
 The world's great victor passed *unheeded* by.  
 UNHEEDEDLY, *adv.* Without being noticed.  
 UNHEEDFUL, *a.* Not cautious; inattentive; careless.  
 UNHEEDFULLY, *adv.* Not heedfully.  
 UNHEEDING, *a.* Not heeding; careless; negligent.  
 UNHEEDINGLY, *adv.* Without giving heed.  
 UNHEEDY, *a.* Precipitate; sudden.  
 UNHELE, † *v. t.* To uncover.  
 UNHELM, *v. t.* To deprive of a helm or guide.  
 UNHELMED, *pp.* Deprived of a helm.—2. *a.* Having no helm.  
 UNHELMET, *v. t.* To deprive of a helmet.  
 UNHELMETED, *pp.* Deprived or destitute of a helmet.  
 UNHELMING, *pp.* Depriving of a helm.  
 UNHELPED, *a.* Unassisted; having no aid or auxiliary; unsupported.  
 UNHELPFUL, *a.* Affording no aid.  
 UNHELPFULLY, *adv.* In an unhelpful manner.  
 UNHEROIC, *a.* Not heroic; not brave.  
 UNHESITATING, *a.* Not hesitating; not remaining in doubt; prompt; ready.  
 UNHESITATINGLY, *adv.* Without hesitation or doubt.  
 UNHEWN, *a.* Not hewn; rough.  
 UNHIDE-BOUND, † *a.* Lax of maw; capacious.  
 UNHINDERED, *a.* Not hindered; not opposed; exerting itself freely.  
 UNHINGE, *v. t.* (unhinj'.) To take from the hinges; as, to *unhinge* a door.—2. To displace; to unfix by violence.—3. To unfix; to loosen; to render unstable or wavering; as, to *unhinge* the mind; to *unhinge* opinions.  
 UNHINGED, *pp.* Loosed from a hinge or fastening.  
 UNHINGEMENT, *n.* The act of unhooking or state of being unhinged. [*Unusual.*]  
 UNHINGING, *pp.* Loosening from a hinge or fastening.  
 UNHIRED, *a.* Not hired.  
 UNHISTORICAL, *a.* Not historical.  
 UNHITCH, † *v. t.* To disengage from a hitch; to set free.  
 UNHIVE, *v. t.* To drive from a hive.—2. To deprive of habitation or shelter, as a crowd.  
 UNHIVED, *pp.* Driven from the hive or shelter.  
 UNHOARD, *v. t.* To steal from a hoard; to scatter.  
 UNHOARDED, *pp.* Stolen from a hoard; scattered.  
 UNHOARDING, *pp.* Scattering.  
 UNHOLILY, *adv.* In an unholly manner.  
 UNHOLINESS, *n.* Want of holiness; an unsanctified state of the heart.—2. Impiety; wickedness; profaneness.  
 UNHOLY, *a.* Not holy; not renewed and sanctified; 2 Tim. iii.—2. Profane; not hallowed; not consecrated; common; Heb. x.—3. Impious; wicked.—4. Not ceremonially purified; Lev. x. UNHONEST, † *a.* [*See HONEST.*] Dishonest; dishonourable.  
 UNHONOURED, *a.* [*See HONOUR.*] Not honoured; not regarded with veneration; not celebrated.  
 UNHOOD, *v. t.* To deprive of a hood.  
 UNHOOK, *v. t.* To loose from a hook.  
 UNHOOKED, *pp.* Loosed from a hook;

UNHOOP, *v. t.* To strip of hoops.  
 UNHOOPED, *pp.* Stripped of hoops.  
 UNHOPED, *a.* Not hoped for; not so probable as to excite hope.  
 With *unhop'd* success. *Dryden.*  
 UNHOPEFUL, *a.* Such as leaves no room to hope.  
 UNHOPEFULLY, *adv.* In an unhopeful manner.  
 UNHORSED, *a.* Having no horns.  
 UNHORSE, *v. t.* (unhors'.) To throw from a horse; to cause to dismount.  
 UNHORSED, *pp.* Thrown from a horse.  
 UNHORRING, *pp.* Throwing from a horse; dismounting.  
 UNHOSPITABLE, *a.* Not kind to strangers. [But *inhospitable* is the word now used.]  
 UNHOSPITABLE, *a.* Not belonging to a public enemy.  
 UNHOUSE, *v. t.* (unhouz'.) To drive from the house or habitation; to dislodge.—2. To deprive of shelter.  
 UNHOUSED, *pp.* Driven from a house or habitation.—2. *a.* Wanting a house; homeless.—3. Having no settled habitation.—4. Destitute of shelter or cover. Cattle in severe weather should not be left *unhoused*.  
 UNHOUSED, *a.* (s as z.) Not having received the sacrament.  
 UNHOUSING, *pp.* Driving from a habitation.  
 UNHUMAN, *a.* Inhuman. [But *inhuman* is the word now used.]  
 UNHUMANIZE, *v. t.* To render inhuman or barbarous.  
 UNHUMBLED, *a.* Not humbled; not affected with shame or confusion; not contrite in spirit.—2. In *theol.*, not having the will and the natural enmity of the heart to God and his law subdued.  
 UNHUNG, *a.* Not hanged.  
 UNHUNTED, *a.* Not hunted.  
 UNHURT, *a.* Not hurt; not harmed; free from wound or injury.  
 UNHURTFUL, *a.* Not hurtful; harmless; innoxious.  
 UNHURTFULLY, *adv.* Without harm; harmlessly.  
 UNHUSBANDED, *a.* (s as z.) Deprived of support; neglected.—2. Not managed with frugality.  
 UNHUSKED, *a.* Not being stripped of husks.  
 UNIAXI'AL, *a.* Having but one axis.  
 UNICAP'SULAR, *a.* [*L. unus, one, and capsula, chest.*] Having one capsule to each flower.  
 UNICORN, *n.* [*L. unicornis; unus, one, and cornu, horn.*] 1. An animal with one horn; the monoceros. This animal is frequently mentioned in Scripture, and many fabulous accounts of it are given by ancient historians, but the unicorn of Scripture is now generally understood to be the rhinoceros.—2. In *her.*, a fabulous animal having the head, neck, and body of the horse, the legs of the buck, the tail of the lion, and a long horn growing out of the middle of the forehead. The unicorn is one of the supporters of the royal arms of Great Britain, in that posture termed *salient*.—3. The *sea unicorn*, called narwal, is of the whale kind, and is remarkable for a horn growing out at his nose.—4. A bird.—*Fossil unicorn*, or *fossil uni-*



Unicorn.

*corn's horn*, a substance formerly in great repute in medicine. It is a terrene, crustaceous spar, so named from having been supposed to be the bone or horn of the unicorn.  
 UNICORN-ROOT, *n.* A popular name of two plants, viz. *Chamaelirium Carolinianum*, to which this name was first applied, and *Alettris farinosa*, to which

Unicorn Root (*Alettris farinosa*).

it has been subsequently applied; both used in medicine. *A. farinosa* is one of the most intense bitters known, and is used in infusion as a tonic and stomachic, but large doses produce nausea. It has also been employed in chronic rheumatism.

UNICORNOUS, *a.* Having only one horn.  
 UNIDE'AL, *a.* Not ideal; real.  
 UNIDIOMAT'IC, *a.* Not idiomatic.  
 UNIFIC, *a.* Making one; forming unity.  
 UNIFA'CIAL, *a.* Having but one front surface; thus, some foliaceous corals are *unifacial*, the polyp-mouths being confined to one surface.  
 UNIFLOROUS, *a.* [*L. unus, one, and flos, flower.*] Bearing one flower only; as, a *uniflorous* peduncle.  
 UNIFOIL, *n.* [*L. unus, and folium, a leaf.*] In *her.*, a plant with only one leaf.  
 UNIFORM, *a.* [*L. uniformis; unus, one, and forma, form.*] 1. Having always the same form or manner; not variable. Thus we say, the dress of the Asiatics is *uniform*, or has been *uniform* from early ages. So we say, it is the duty of a Christian to observe a *uniform* course of piety and religion.—2. Consistent with itself; not different; as, one's opinions on a particular subject have been *uniform*.—3. Of the same form with others; consonant; agreeing with each other; conforming to one rule or mode.  
 How far churches are bound to be *uniform* in their ceremonies is doubted. *Hooker.*  
 4. Having the same degree or state; as, *uniform* temperature.—*Uniform motion or velocity.* The motion or velocity of a body is *uniform*, when it passes over equal spaces in equal times. In *uniform motion*, the space passed over is directly as the time, and directly as the velocity; and the time is inversely as the velocity. [*See MOTION, VELOCITY.*]—*Uniform force*, a constant force; a force which, acting in the direction of a body's motion, adds equal velocities in equal times; such is the force of gravity.—*Uniform matter*, is that which is all of the same kind and texture.  
 UNIFORM, *n.* The particular dress of

soldiers, by which one regiment or company is distinguished from another, or a soldier from another person. We say, the *uniform* of a company of militia, the *uniform* of the artillery companies, the *uniform* of a regiment, &c. This dress is called a *uniform*, because it is alike among all the soldiers.

**UNIFORMITY**, *n.* Resemblance to itself at all times; even tenor; as, the *uniformity* of design in a poem.—2. Consistency; sameness; as, the *uniformity* of a man's opinions.—3. Conformity to a pattern or rule; resemblance, consonance, or agreement; as, the *uniformity* of different churches in ceremonies or rites.—4. Similitude between the parts of a whole; as, the *uniformity* of sides in a regular figure. Beauty is said to consist in *uniformity* with variety.—5. Continued or unvaried sameness or likeness.

*Uniformity* must tire at last, though it is a *uniformity* of excellence. *Johnson.*

*Act of uniformity*, in *Eng.*, the act of parliament by which the form of public prayers, administration of sacraments, and other rites, is prescribed to be observed in all the churches; 1 Eliz. and 13 and 14 Car. II.

**UNIFORMLY**, *adv.* With even tenor; without variation; as, a temper *uniformly* mild.—2. Without diversity of form from another.

**UNIFORMNESS**, *n.* State of being uniform; uniformity. [*Rarely used.*]

**UNIFY**, *v. t.* To form into one; to make a unit of. [*Rarely used.*]

**UNIGENITURE**, *n.* [*L. unigenitus; unus and genitus.*] The state of being the only begotten.

**UNIGENITUS**, *n.* [*L. only begotten.*] A celebrated papal bull, so called from its opening words, "*Unigenitus Dei filius*," issued by Clement XI., in 1713, condemning 101 propositions in Quesnel's work on the New Testament, or, in other words, supporting the Jesuits against the Jansenists in their opinions concerning divine grace.

**UNIGENOUS**, *a.* [*L. unigena.*] Of one kind; of the same genus.

**UNIJUGATE**, *a.* [*L. unus, and jugatus, coupled together.*] In *bot.*, a *unijugate leaf* is a pinninerved compound leaf, consisting of only one pair of leaflets.

**UNILABATE**, *a.* In *bot.*, having one lip only, as a corol.

**UNILATERAL**, *a.* [*L. unus, one, and latus, side.*] 1. Being on one side or party only. [*Unusual.*]—2. Having one side. A *unilateral raceme*, is when the flowers grow only on one side of the common peduncle.—*Unilateral leaves* are such as lean towards one side of the stem; as in *Convallaria multiflora*.—*Unilateral obligations*, in *Scots law*, are those obligations in which one party alone is bound.—*Unilateral trusts* are those which a debtor voluntarily and extra-judicially executes, for the better and more equal settlement of the claims against him, in favour of a trustee for behoof of all his creditors.

**UNILITERAL**, *a.* [*L. unus, one, and litera, letter.*] Consisting of one letter only.

**UNILLUMINATED**, *a.* Not illuminated; not enlightened; dark.—2. Ignorant.

**UNILLUMINED**, *a.* Not illumined.

**UNILLUSTRATED**, *a.* Not illustrated; not made plain.

**UNILLUSTRATIVE**, *a.* Not illustrative.

**UNILOCULAR**, *a.* [*L. unus, one, and oculus, cell.*] Having one cell only; as, a *unilocular pericarp* or anther.—2. In *conchol.*, *unilocular shells* are such as are not divided by septa into chambers or cells.

**UNIMAGINABLE**, *a.* Not to be imagined; not to be conceived.

**UNIMAGINABLY**, *adv.* To a degree not to be imagined.

**UNIMAGINATIVE**, *a.* Not imaginative.

**UNIMAGINED**, *a.* Not imagined; not conceived.

**UNIMBITTERED**, *a.* Not embittered; not aggravated.

**UNIMBUED**, *a.* Not imbued; not tintured.

**UNIMITABLE**, *a.* That cannot be imitated. [But the word now used is *inimitable*.]

**UNIMITATED**, *a.* Not imitated.

**UNIMMORTAL**, *a.* Not immortal; perishable.

**UNIMPAIRABLE**, *a.* Not liable to waste or diminution.

**UNIMPAIRED**, *a.* Not impaired; not diminished; not enfeebled by time or injury; as, an *unimpaired constitution*.

**UNIMPARTED**, *a.* Not imparted; not shared.

**UNIMPASSIONATE**, *a.* Not impassionate.

**UNIMPASSIONATENESS**, *n.* A state of being unimpassionate.

**UNIMPASSIONED**, *a.* Not endowed with passions.—2. Free from passion; calm; not violent; as, an *unimpassioned address*.

**UNIMPEACHABLE**, *a.* That cannot be impeached; that cannot be accused; free from stain, guilt, or fault; as, an *unimpeachable reputation*.—2. That cannot be called in question; as, an *unimpeachable claim* or testimony.

**UNIMPEACHABLY**, *adv.* So as not to be impeachable.

**UNIMPEACHED**, *a.* Not impeached; not charged or accused; fair; as, an *unimpeached character*.—2. Not called in question; as, testimony *unimpeached*.

**UNIMPEDED**, *a.* Not impeded; not hindered.

**UNIMPLICATED**, *a.* Not implicated; not involved.

**UNIMPLIED**, *a.* Not implied; not included by fair inference.

**UNIMPLORED**, *a.* Not implored; not solicited.

**UNIMPORTANCE**, *n.* Want of importance.

**UNIMPORTANT**, *a.* Not important; not of great moment.—2. Not assuming airs of dignity.

**UNIMPORTANTLY**, *adv.* Without weight or importance.

**UNIMPORTING**, *a.* Not importing.

**UNIMPORTONED**, *a.* Not importuned; not solicited.

**UNIMPOSING**, *a.* (*s* as *z*.) Not imposing; not commanding respect.—2. Not enjoining as obligatory; voluntary.

**UNIMPREGNABLE**, *a.* That may be taken or impugned; not impregnable.

**UNIMPREGNATED**, *a.* Not impregnated.

**UNIMPRESSED**, *a.* Not impressed

**UNIMPRESSIBLE**, *a.* Not impressible.

**UNIMPRESSIVE**, *a.* Not impressive; not forcible; not adapted to affect or awaken the passions.

**UNIMPRESSIVELY**, *adv.* Unforcibly; without impression.

**UNIMPRESSIVENESS**, *n.* State of being unimpressive.

**UNIMPRISONED**, *a.* Not confined in prison.

**UNIMPROPRIATED**, *a.* Not impropriated.

**UNIMPROVABLE**, *a.* Not capable of improvement, melioration, or advancement to a better condition.—2. Incapable of being cultivated or tilled.

**UNIMPROVABLENESS**, *n.* The quality of being not improvable.

**UNIMPROVABLY**, *adv.* Without being improvable.

**UNIMPROVED**, *a.* Not improved; not made better or wiser; not advanced in knowledge, manners, or excellence.—2. Not used for a valuable purpose.

How many advantages *unimproved* have we to regret!—3. Not used; not employed.—4. Not tilled; not cultivated; as, *unimproved land* or soil; *unimproved lots of ground*.—5. Unensured; not disapproved. [This sense, from the *L. improbo*, is entirely obsolete.]

**UNIMPROVING**, *a.* Not improving; not tending to advance or instruct.

**UNIMPUTABLE**, *a.* Not imputable or chargeable to.

**UNIMPUTED**, *a.* Not imputed.

**UNIMUSCULAR**, *a.* Having one muscle only and one impression, as a bivalve molluscan.

**UNINCARNATE**, *a.* Not incarnate.

**UNINCHANTED**, *a.* Not enchanted; not affected by magic or enchantment; not haunted. [Usually *unenchantd*.]

**UNINCITED**, *a.* Not incited.

**UNINCLOSED**, *a.* Not inclosed.

**UNINCORPORATED**, *a.* Not incorporated.

**UNINCREASEASABLE**, *a.* Admitting no increase.

**UNINCUMBERED**, *a.* Not incumbered; not burdened.—2. Free from any temporary estate or interest, or from mortgage, or other charge or debt; as, an estate *unincumbered* with dower. [*Unincumbered* is the preferable word.]

**UNINDEBTED**, *a.* Not indebted.—2. Not borrowed. [*Unusual.*]

**UNINDIFFERENT**, *a.* Not indifferent; not unbiased; partial; leaning to one party.

**UNINDORSED**, *a.* Not indorsed; not assigned; as, an *unindorsed note* or bill.

**UNINDUCED**, *a.* Not induced.

**UNINDUSTRIOUS**, *a.* Not industrious; not diligent in labour, study, or other pursuit.

**UNINDUSTRIOUSLY**, *adv.* Without industry.

**UNINEBRIATING**, *a.* Not inebriating.

**UNINFECTED**, *a.* Not infected; not contaminated or affected by foul infectious air.—2. Not corrupted.

**UNINFECTIOUS**, *a.* Not infectious; not foul; not capable of communicating disease.

**UNINFESTED**, *a.* Not infested.

**UNINFLAMED**, *a.* Not inflamed; not set on fire.—2. Not highly provoked.

**UNINFLAMMABLE**, *a.* Not inflammable; not capable of being set on fire.

**UNINFLUENCED**, *a.* Not influenced; not persuaded or moved by others, or by foreign considerations; not biased; acting freely.—2. Not proceeding from influence, bias, or prejudice; as, *uninfluenced conduct* or actions.

**UNINFLUENCIVE**, *a.* Uninfluential. [*Rarely used.*]

**UNINFLUENTIAL**, *a.* Not having influence.

UNINFORM'ED, *a.* Not informed; not instructed; untaught.—2. Unanimated; not enlivened.  
 UNINFORMING, *a.* Not furnishing information; uninstructional.  
 UNINGENIOUS, *a.* Not ingenious; dull.  
 UNINGENIOUSLY, *adv.* Without ingenuity.  
 UNINGENUOUS, *a.* Not ingenuous; not frank or candid; disingenuous.  
 UNINGENUOUSLY, *adv.* Not ingenuously.  
 UNINGENUOUSNESS, *n.* Want of ingenuousness.  
 UNINHABITABLE, *a.* Not inhabitable; that in which men cannot live; unfit to be the residence of men.  
 UNINHABITABLENESS, *n.* The state of being uninhabitable.  
 UNINHABITED, *a.* Not inhabited by men; having no inhabitants.  
 UNINITIATE, } *a.* Not initiated.  
 UNINITIATED, }  
 UNINJURED, *a.* Not injured; not hurt; suffering no harm.  
 UNINJURIOUS, *a.* Not injurious.  
 UNINQUIRING, *a.* Not inquiring or disposed to inquire.  
 UNINQUISITIVE, *a.* (*s* as *z*.) Not inquisitive; not curious to search and inquire.  
 UNINSCRIBED, *a.* Not inscribed; having no inscription.  
 UNINSPIRED, *a.* Not having received any supernatural instruction or illumination.  
 UNINSPIRITED, *a.* Not inspirited.  
 UNINSTITUTED, *a.* Not instituted.  
 UNINSTRUCT'ED, *a.* Not instructed or taught; not educated.—2. Not directed by superior authority; not furnished with instructions.  
 UNINSTRUCTING, *a.* Not instructing.  
 UNINSTRUCTIVE, *a.* Not instructive; not conferring improvement.  
 UNINSTRUCTIVELY, *adv.* Not instructively.  
 UNINSULATED, *a.* Not insulated; not being separated or detached from every thing else.  
 UNINSULT'ED, *a.* Not insulted.  
 UNINSURED, *a.* [See *SURE*.] Not insured; not assured against loss.  
 UNINTELLECTUAL, *a.* Not intellectual.  
 UNINTELLECTUALLY, *adv.* Not intellectually.  
 UNINTELLIGENT, *a.* Not having reason or consciousness; not possessing understanding.—2. Not knowing; not skilful; dull.  
 UNINTELLE'GENTLY, *adv.* Not intelligently.  
 UNINTELLIGIBILITY, *n.* The quality of being not intelligible.  
 UNINTELLIGIBLE, *a.* Not intelligible; that cannot be understood.  
 UNINTELLIGIBLENESS, *n.* State of being unintelligible.  
 UNINTELLIGIBLY, *adv.* In a manner not to be understood.  
 UNINTEND'ED, *a.* Not intended; not designed.  
 UNINTENTIONAL, *a.* Not intentional; not designed; done or happening without design.  
 UNINTENTIONALLY, *adv.* Without design or purpose.  
 UNINTERESTED, *a.* Not interested; not having any interest or property in; having nothing at stake; as, to be *uninterested* in any business or calamity.—2. Not having the mind or the pas-

sions engaged; as, to be *uninterested* in a discourse or narration.  
 UNINTERESTING, *a.* Not capable of exciting an interest, or of engaging the mind or passions; as, an *uninteresting* story or poem.  
 UNINTERESTINGLY, *adv.* So as not to excite interest.  
 UNINTERMISSION, *n.* Defect or failure of intermission.  
 UNINTERMITTED, *a.* Not intermitted; not interrupted; not suspended for a time; continued.  
 UNINTERMITTEDLY, *adv.* Without being intermitted.  
 UNINTERMITTING, *a.* Not intermitting; not ceasing for a time; continuing.  
 UNINTERMITTINGLY, *adv.* Without cessation; continually.  
 UNINTERMIX'ED, *a.* Not intermixed; not mingled.  
 UNINTERPOLATED, *a.* Not interpolated; not inserted at a time subsequent to the original writing.  
 UNINTERPRETED, *a.* Not explained or interpreted.  
 UNINTERRED, *a.* Not buried.  
 UNINTERRUPTED, *a.* Not interrupted; not broken.—2. Not disturbed by intrusion or avocation.  
 UNINTERRUPTEDLY, *adv.* Without interruption; without disturbance.  
 UNINTOXICATING, *a.* Not intoxicating.  
 UNINTRENCH'ED, *a.* Not intrenched; not defended by intrenchments.  
 UNINTRICATED, } *a.* Not perplexed;  
 UNINTRICATE, } not obscure or intricate.  
 UNINTRODUCED, *a.* Not introduced; not properly conducted; obtrusive.  
 UNINURED, *a.* Not inured; not hardened by use or practice.  
 UNINVADED, *a.* Not invaded.  
 UNINVENTED, *a.* Not invented; not found out.  
 UNINVENTIVE, *a.* Not inventive.  
 UNINVENTIVELY, *adv.* Not inventively.  
 UNINVEST'ED, *a.* Not invested; not clothed.—2. Not converted into some species of property less fleeting than money; as, money *uninvested*.  
 UNINVESTIGABLE, *a.* That cannot be investigated or searched out.  
 UNINVESTIGATED, *a.* Not investigated.  
 UNINVESTIGATIVE, *a.* Not adapted or given to investigation.  
 UNINVIDIOUS, *a.* Not invidious.  
 UNINVITED, *a.* Not invited; not requested; not solicited.  
 UNINVITING, *a.* Not inviting.  
 UNINVOKED, *a.* Not invoked.  
 U'NIO, *n.* [L. a pearl.] A genus of fresh-water bivalve shells, belonging to the family Mytilacea, Cuvier, commonly called fresh-water muscles. Numerous species, remarkable for size or form, inhabit the rivers and lakes of the United States.  
 U'NION, *n.* [Fr. *union*; It. *unione*; L. *unio*, to unite, from *unus*, one.] 1. The act of joining two or more things into one, and thus forming a compound body or a mixture; or the junction or coalition of things thus united. *Union* differs from *connection*, as it implies the bodies to be in contact, without an intervening body; whereas things may be *connected* by the intervention of a third body, as by a cord or chain. One kingdom, joy and *union* without end.  
 Milton.

tion of mind, will, affections, or interest. Happy is the family where perfect *union* subsists between all its members.—3. The junction or united existence of spirit and matter; as, the *union* of soul and body.—4. Among *painters*, a symmetry and agreement between the several parts of a painting.—5. In *arch.*, harmony between the colours in the materials of a building.—6. In *ecclesiastical affairs*, the combining or consolidating of two or more churches into one. This cannot be done without the consent of the bishop, the patron, and the incumbent. *Union* is by *accession*, when the united benefice becomes an accessory of the principal; by *confusion*, where the two titles are suppressed, and a new one created, including both; and by *equality*, where the two titles subsist, but are equal and independent.—7. States united. Thus the United States of America are sometimes called the *Union*.—8. † A pearl. [L. *unio*.]—*Union flag*, in the navy, one of the three ensigns or standards in which the crosses of St. George, St. Andrew, and St. Patrick are blended, to denote the union of the three kingdoms. This flag is appropriated to the admiral of the fleet, who is the first naval officer under the lord high admiral.—*Union jach*. [See *JACK*.] In the flag of the United States, a square portion at the upper left hand corner, in which the stars are united on a blue ground; denoting the *union* of the States.—*Union*, or *Act of union*, the act by which Scotland was united to England, or by which the two kingdoms were incorporated into one, in 1707.—*Legislative union*, the union of Great Britain and Ireland, in 1800.—*Union by the first intention*, in *sur.*, the process by which the opposite surfaces of recent wounds, when they are kept in contact with each other, grow together and unite without suppuration; the result of a wonderful self-healing power in living bodies.—*Charter of union*, or *clause of union*. In *Scots law*, where lands lie discontiguous, but are held by the same tenure, under the same superior, and derived from the same author, the sovereign by a crown charter may unite them into one tenantry. The object of this charter or *clause of union*, is to dispense with the necessity of taking separate infeftments, and to declare that one sasine shall be sufficient to carry the whole discontiguous subjects.—*Union cloth*, cloth made of two kinds of materials, as cotton and wool, cotton and silk.  
 U'NIONIST, *n.* One who promotes or advocates union.—2. One who is joined with others to maintain strikes; as, a trades' *unionist*.  
 UNIP'AROUS, *a.* [L. *unus*, one, and *pario*, to bear.] Producing one at a birth.  
 UNIPED, *n.* or *a.* Having only one foot.  
 UNIPELTA'TA, *n.* [L. *unus*, and *pelta*, a buckler.] A family of stomapodous crustaceans, in which the shell consists of a single shield, of an elongated quadrilateral form. It consists of but a single genus, the squilla of Fabricius.  
 UNIPERSONAL, *a.* Having but one person.  
 UNIPERSONALIST, *n.* One who believes there is a single person in the deity.  
 UNIQUE, *a.* (yuneek') [Fr.] Sole;



unequaled; single in its kind or excellence.

**UNIQUELY**, *adv.* In a unique manner.  
**UNIRADIATED**, *a.* Having one ray.  
**UNIRRADIATED**, *a.* Not irradiated.  
**UNIRITATED**, *a.* Not irritated; not fretted.—2. Not provoked or angered.  
**UNIRITATING**, *a.* Not irritating or fretting.—2. Not provoking.—3. Not exciting.

**UNIRITATINGLY**, *adv.* So as not to irritate.

**UNISERIATE**, *a.* Having a single line or series.

**UNISERIATELY**, *adv.* In a single line or series.

**UNISEXUAL**, *a.* In *bot.*, having one sex only.

**UNISON**, *n.* [*L. unus*, one, and *sonus*, sound.] 1. In *music*, an accordance or coincidence of sounds proceeding from an equality in the number of vibrations made in a given time by a sonorous body. If two chords of the same matter have equal length, thickness, and tension, they are said to be in *unison*, and their sounds will be in *unison*. Sounds of very different qualities and force may be in *unison*; as, the sound of a bell may be in *unison* with a sound of a flute. *Unison* then consists in sameness of degree, or similarity in respect to gravity or acuteness, and is applicable to any sound, whether of instruments or of the human organs, &c.—2. A single unvaried note.—In *unison*, in agreement; in harmony.

**UNISON**, *a.* Sounding alone.

Sounds intermix'd with voice,

Choral or *unison*. *Anon.*

**UNISONANCE**, *n.* Accordance of sounds.

What constitutes *unisonance* is the equality of the number of vibrations of sonorous bodies, in two equal times. *Cyc.*

**UNISONANT**, *a.* Being in *unison*; having the same degree of gravity or acuteness.

**UNISONOUS**, *a.* Being in *unison*.

**UNIT**, *n.* [*L. unus*, one; *unitas*, unity.] 1. One; a word which denotes a single thing or person.—2. In *arith.*, the least whole number, or one, represented by the figure 1. Every other number is an assemblage of units. This definition is applicable to fractions as well as to whole numbers. Thus, the fraction  $\frac{7}{10}$  is an assemblage of seven units, each of which is one-tenth of the integer.

*Units* are the integral parts of any large number. *Watts.*

3. In *math.*, any known determinate quantity, by the constant repetition of which, any other quantity of the same kind is measured; or it is the name given to that magnitude, which is to be considered or reckoned as one, when other magnitudes of the same kind are to be measured. It is not itself one, but is the magnitude which one or 1 shall stand for in calculation: it is a length, or a surface, or a solid, or a weight, or a time, as the case may be, while 1 is only a numerical symbol. This symbol 1 represents the abstract conception of singleness, as distinguished from multitude, and is the unit of abstract arithmetic: but all concrete quantities must have units of their own kind.—*Measuring unit*, in *mensuration*, a certain dimension or magnitude, assumed as a standard by which other dimensions or magnitudes of the same kind are to be measured.

Thus, in mensuration of surfaces, the measuring unit is a square inch, a square foot, a square yard, &c., and the area or superficies of any figure is estimated by the number of squares of this kind that are contained in it. In solids, the measuring unit is a cubical inch, a cubical foot, a cubical yard, &c., and the content or solidity of any figure is estimated by the number of cubes of this kind which it contains. In like manner, in linear measure, the measuring unit is an inch, a foot, a yard, &c.—*Unit of time*, in *theoretical mech.*, one second, and all motion is measured by the space which is, or would be, passed over in this time; hence the velocity of a body signifies the space which it passes over in one second, and where one body is said to have a greater or a less velocity than another, it is meant that a greater or less space is passed over by it in one second.—*Unit of force or of weight*, in *theoretical mech.*, a certain force or weight assumed as a standard, by which other forces or weights, or their effects, may be estimated. This unit may be an ounce, a pound, a hundredweight, &c. [*See* UNITV.]

**UNITABLE**, *a.* Capable of being united.

**UNITARIAN**, *n.* [*L. unitas*, unity.] The *Unitarians* are a sect of religionists who confine the glory and attribute of divinity to the one only great and supreme God, and Father of our Lord Jesus Christ. The Unitarians are opposed to the Trinitarians, or those who conceive of one God in three persons, characters, or relations, each of which they regard as the proper object of religious worship. The Unitarian Christian believes the Father to be the only true God, and Jesus, his messenger, to be the Christ. This is the leading fundamental principle, which constitutes the true and complete definition of the term Unitarian; under which are consequently included all those who, receiving the divine authority or commission of Jesus Christ, believe him to be a dependent creature, deriving his existence from the Father, and therefore the fit object of all the veneration, submission, and obedience which can be offered to a creature, but not of religious worship, properly so called. Agreeing in this great and leading principle, Unitarians differ in their opinions as to the origin, nature, and dignity of Jesus Christ. One division of them has received the name of Arians, another that of Socinians.

**UNITARIAN**, *a.* Pertaining to Unitarians.

**UNITARIANISM**, *n.* The doctrines of Unitarians, who deny the divinity of Christ.

**UNITARIANIZE**, *v. t.* and *i.* To conform to Unitarianism.

**UNITE**, *v. t.* [*L. unio*, *unitus*; *Fr.* and *Sp.* *unir*; *It.* *unire*.] 1. To put together or join two or more things, which make one compound or mixture. Thus we *unite* the parts of a building to make one structure. The kingdoms of England, Scotland, and Ireland *united*, form one empire. So we *unite* spirit and water and other liquors. We *unite* strands to make a rope. The states of North America *united*, form one nation.—2. To join; to connect in a near relation or alliance; as, to *unite* families by marriage; to *unite* nations by treaty.—3. To make to agree or be uniform; as, to *unite* a kingdom in one

form of worship; to *unite* men in opinions.—4. To cause to adhere; as, to *unite* bricks or stones by cement.—5. To join in interest or fellowship; *Gen.* xlix.—6. To tie; to splice; as, to *unite* two cords or ropes.—7. To join in affection; to make near; as, to *unite* hearts in love [*Unite* is followed by *to* or *with*. To *unite to*, is to join; *Gen.* xlix. 6. To *unite with*, is to associate; but the distinction is not always obvious or important.]—*To unite the heart*, to cause all its powers and affections to join with order and delight in the same objects; *Ps.* lxxxvi.  
**UNITE**, *v. i.* To join in an act; to concur; to act in concert. All parties *united* in petitioning for a repeal of the law.—2. To coalesce; to be cemented or consolidated; to combine; as, bodies *unite* by attraction or affinity.—3. To grow together, as the parts of a wound.

The spur of a young cock grafted into the comb, will *unite* and grow. *Duhamel.*

4. To coalesce, as sounds.—5. To be mixed. Oil and water will not *unite*.

**UNITED**, *pp.* Joined; made to agree;

cemented; mixed; attached by growth.

—*United flowers*, are such as have the stamens and pistils in the same flower.

—*United brethren*, a religious community commonly called Moravians,

from their original country, Moravia,

where they sprung up on the first

opening of the Reformation. Generally

speaking, they adhere to the confession

of Augsburg, considering it as founded

on the Scriptures, which are the only

rule of their faith and practice. The

Moravians are remarkable for a meek,

quiet, and child-like spirit, and for

their earnest and unremitting labours in

attempting to convert the heathen.

**UNITEDLY**, *adv.* With union or joint

efforts.

**UNITER**, *n.* The person or thing that

unites.

**UNITING**, *ppr.* Joining; causing to

agree; consolidating; coalescing; grow-

ing together.

**UNITION**, *n.* Junction; act of unit-

ing.

**UNITIVE**, *n.* Having the power of

uniting.

**UNIT JAR**, *n.* In *electrical experi-*

*ments*, a small insulated Leyden jar,

placed between the electrical machine

and a larger jar or battery. On work-

ing the machine, the small jar will

make repeated discharges, and these

will pass into the larger jar or battery.

Hence the use of this jar is to an-

nounce the number of such discharges,

from which an estimate may be formed

of the amount of electricity which

passes into the larger jar or battery.

**UNITY**, *n.* [*L. unitas*.] 1. The state of

being one; oneness. *Unity* may con-

sist of a simple substance or existing

being, as the soul; but usually it con-

sists in a close junction of particles or

parts, constituting a body detached from

other bodies. *Unity* is a thing undi-

vided itself, but separate from every

other thing.—2. Concord; conjunction;

as, a *unity of proofs*.—3. Agreement;

uniformity; as, *unity of doctrine*; *unity*

of worship in a church.—4. In *Christian*

*theol.*, oneness of sentiment, affec-

tion, or behaviour.

How good and how pleasant it is for

brethren to dwell together in *unity*? *Ps.*

cxxxiii.

5. In *math.*, the abstract expression

for any unit whatsoever. The terms

*unit* and *unity* are often used synony-

monly, but in general, the number 1 is *unity* when it is not applied to any particular object; and a *unit*, when it is so applied. [See UNIT, No. 3.]—6. In *poetry*, the principle by which a uniform tenor of story and propriety of representation is preserved. In the *Greek drama*, the three unities required were those of *action*, of *time*, and of *place*; in other words, that there should be but one main plot; that the time supposed should not exceed twenty-four hours, and that the place of the action before the spectators should be one and the same throughout the piece. In the epic poem, the great and almost only *unity* is that of action.—7. In *music*, such a combination of parts as to constitute a whole, or a kind of symmetry of style and character.—8. In *all the arts*, the correspondence of the various parts of a work, so that they may form one harmonious whole. *Unity* is indispensable in every work of art.—9. In *law*, the properties of a joint estate are derived from its *unity*, which is fourfold; *unity of interest*, *unity of title*, *unity of time*, and *unity of possession*; in other words, joint-tenants have one and the same interest, accruing by one and the same conveyance, commencing at the same time, and held by one and the same undivided possession.—10. In *law*, *unity of possession* is a joint possession of two rights by several titles, as when a man has a lease of land upon a certain rent, and afterward buys the fee simple. This is a *unity of possession*, by which the lease is extinguished.—*Unity of faith*, is an equal belief of the same truths of God, and possession of the grace of faith in like form and degree.—*Unity of spirit*, is the oneness which subsists between Christ and his saints, by which the same spirit dwells in both, and both have the same disposition and aims; and it is the oneness of Christians among themselves, united under the same head, having the same spirit dwelling in them, and possessing the same graces, faith, love, hope, &c.

UNIVALVE, *a.* [L. *unus*, one and *valve*.] Having one valve only, as a shell or pericarp.

UNIVALVE, *n.* A shell having one valve only. The *univalves* form one of the three divisions into which shells were divided by Linnæus, the other two divisions being bivalves and multivalves. In this arrangement the generic characters reside in the shell and not in the structure of the inhabiting animal. Modern naturalists have adopted a much more scientific system of arrangement in regard to testaceous or molluscous animals. Lamarck divides the bivalves into five orders, viz., Heteropoda, Cephalopoda, Trachelipoda, Gasteropoda, and Pteropoda. Univalves are far more numerous than either multivalves or bivalves, both in genera and species.

UNIVALVED, *a.* Having only one valve.

UNIVALVULAR, *a.* Having one valve only; as, a *univalvular* pericarp or shell.

UNIVERSAL, *a.* [L. *universalis*; *unus* and *versor*.] 1. All; extending to or comprehending the whole number, quantity, or space; as, *universal* ruin; *universal* good; *universal* benevolence.

The *universal* cause,

Acts not by partial, but by general laws.

Pope.

2. Total; whole.

From harmony, from heavenly harmony, This *universal* frame began. Dryden.

3. Comprising all the particulars; as, *universal* kinds.—4. In bot., a *universal umbel*, is a primary or general umbel; the first or largest set of rays in a compound umbel; opposed to *partial*. A *universal involucre* is not unfrequently placed at the foot of a *universal umbel*.—*Universal dial*, is a dial by which the hour may be found by the sun in any part of the world, or under any elevation of the pole.—*Universal successor*, in *Scots law*, an heir who succeeds to the whole of the heritage of a person who dies intestate.—*Universal joint*. [See JOINT.]—*Universal proposition*, one in which the subject is taken in its widest extent, and the predicate applies to every thing which the subject can denote. Thus, "all men are mortal," is a *universal proposition*, and also, "no man is perfect." A *universal proposition* is opposed to a *particular proposition*, or one which makes such an assertion or denial of some of the things spoken of, as implies that others are left unspoken of: Thus, "some men are born in England," and "some animals cannot live in this climate," are *particular propositions*. [See the Noun.] UNIVERSAL, *n.* [See the Adjective.] In logic, a *universal* is *complex* or *incomplex*. A *complex universal*, is either a *universal proposition*, as "every whole is greater than its parts," or whatever raises a manifold conception in the mind, as the definition of a reasonable animal. An *incomplex universal*, is what produces one conception only in the mind, and is a simple thing respecting many; as human nature, which relates to every individual in which it is found.—2.† The whole; the general system of the universe.—*Universals*, the name given by the schoolmen to general notions or ideas, especially those of genera and species.

UNIVERSALISM, *n.* In *theol.*, the doctrine or belief that all men will be saved or made happy in a future life.

UNIVERSALIST, *n.* One who holds the doctrine that all men will be saved, in opposition to the doctrine of eternal punishment. The *universalists* maintain that Christ died for all, and hence that all shall finally be brought to a participation of the benefits of his death, in their restoration to holiness and happiness. The name *universalists* is sometimes applied to the Arminians, in consequence of the *universality* which they ascribe to the operation of divine grace, and their opposition to the doctrine of *particular* election.

UNIVERSALITY, *n.* The state of extending to the whole; as, the *universality* of a proposition; the *universality* of sin; the *universality* of the deluge.

UNIVERSALIZE, *v. t.* To make universal.

UNIVERSALIZED, *pp.* Rendered universal.

UNIVERSALIZING, *ppr.* Rendering universal.

UNIVERSALLY, *adv.* With extension to the whole; in a manner to comprehend all; without exception. Air is a fluid *universally* diffused. God's laws are *universally* binding on his creatures.

UNIVERSALNESS, *n.* Universality.

Note.—*Universal* and its derivatives are used in common discourse for *ge-*

*neral*. This kind of universality is by the schoolmen called *moral*, as admitting of some exceptions, in distinction from *metaphysical*, which precludes all exceptions.

UNIVERSE, *n.* [Fr. *univers*; L. *universum*.] The general system of things; the collective name of heaven and earth, and all that belongs to them; the whole system of created things; the  $\tau\omicron\ \pi\alpha\upsilon$  of the Greeks, and the *mundus* of the Latins.

UNIVERSITY, *n.* [L. *universitas*, the whole of any thing as contrasted with its parts; a community, association, corporation, company, &c.] In the modern sense of the term, an establishment or corporation for the purposes of instruction in all or some of the most important divisions of science and literature, and having the power of conferring certain honorary dignities, termed degrees. The term *university*, like many other terms of extensive application, has undergone various modifications of meaning, till its origin and primary use seem to have been utterly forgotten. In its proper and original meaning, it denotes the whole members of an incorporated body of persons, teaching and learning one or more departments of knowledge. In the technical language of the civil law, the word *universitas* was used to signify a plurality of persons, associated for a continued purpose, and may be rendered by *society*, *company*, *corporation*. In the middle ages, the term was used in reference to seminaries of learning, to denote either the whole body of teachers and learners, or the whole body of learners, with corporate rights and under bye-laws of their own, divided either by faculty or by country, or both together; its meaning being determined by the words with which it was connected. At a later period, the expression *universitas literarum* was used to indicate that all the most important branches of science were to be taught in these establishments; but although it is true that most of the modern universities embrace the whole circle of learning, as contained in the four faculties of the arts, theology, law, and physic, this was not the case in the 12th century, when the term *universities* was first applied to academical institutions. The university of Paris, as well as Oxford and Cambridge, existed at first only in the faculty of arts, and Salerno and Montpellier contained the single faculty of medicine. Some, forming their notion of the word *university* merely from the English universities, suppose that it necessarily means a collection and union of colleges; that it is a great corporation embodying in one the smaller and subordinate collegiate bodies; but this is not correct, for many universities exist in which there are no colleges: This is the case with most of the German universities, and in the Scottish universities there are no foundations which bear any resemblance to the English colleges; and, besides, the universities of Oxford and Cambridge existed before a single college was endowed. The oldest of the European universities were those of Paris and Bologna, and these formed the models on which the other universities, which subsequently sprung up in various parts of Europe, were established.

**UNIVOCAL**, *n.* A word having only one signification or meaning; a synonyme.  
**UNIVOCAL**, *a.* [L. *unus*, one, and *vox*, word.] 1. Having one meaning only. A univocal word is opposed to an equivocal, which has two or more significations.—2. Having unison of sounds; as the octave in music and its replicates.—3. Certain; regular; pursuing always one tenor. [*Little used.*]  
**UNIVOCALLY**, *adv.* In one term; in one sense.  
 How is sin univocally distinguished into venial and mortal, if the venial be not sin? *Hale.*  
 2. In one tenor. [*Little used.*]  
**UNIVOCATION**, *n.* Agreement of name and meaning.  
**UNJAR'RING**, *a.* Not discordant.  
**UNJAUN'DICED**, *a.* Not jaundiced.  
**UNJEALOUS**, *a.* (unjel'ous.) Not jealous or mistruſting.  
**UNJOIN'**, *v. t.* To ſeparate; to diſjoin.  
**UNJOINED**, *a.* Not joined.  
**UNJOINT'**, *v. t.* To diſjoint.  
**UNJOINT'ED**, *pp.* Diſjointed; ſeparated.—2. *a.* Having no joint or articulation; as, an unjointed ſtem.  
**UNJOY'FUL**, *a.* Not joyful; ſad.  
**UNJOY'FULLY**, *adv.* Not joyfully.  
**UNJOY'OUS**, *a.* Not joyous; not gay or cheerful.  
**UNJOY'OUSLY**, *adv.* Not joyouſly.  
**UNJUDG'ED**, *a.* Not judged; not judicially determined.  
**UNJUST'**, *a.* Not juſt; acting contrary to the ſtandard of right eſtabliſhed by the divine law; not equitable; as, an unjust man.—2. Contrary to juſtice and right; wrongful; as, an unjust ſentence; an unjust demand; an unjust accuſation.  
**UNJUSTIFIABLE**, *a.* Not juſtifiable; that cannot be proved to be right; not to be vindicated or defended; as, an unjustifiable motive or action.  
**UNJUSTIFIABLENESS**, *n.* The quality of not being juſtifiable.  
**UNJUSTIFIABLY**, *adv.* In a manner that cannot be juſtified or vindicated.  
**UNJUSTIFIED**, *a.* Not juſtified or vindicated.—2. Not pardoned.  
**UNJUSTLY**, *adv.* In an unjust manner; wrongfully.  
**UNK'ED**, † } for *Uncouth*, odd; ſtrange.  
**UNK'ID**, † }  
**UNKEMMED**, } *a.* Uncombed; un-  
**UNKEMPT**, } polished. [*Obſolete,*  
*except in poetry.*]  
**UNKEN'NEL**, *v. t.* To drive from his hole; as, to unkenel a fox.—2. To rouse from ſecrecy or retreat.—3. To reſeaſe from a kennel.  
**UNKEN'NELLED**, *pp.* Driven or let looſe from confinement, as a fox or dog.  
**UNKENT'**, † *a.* [un and ken, to know.] Unknown.  
**UNKEPT**, *a.* Not kept; not retained; not preſerved.—2. Not obſerved; not obeyed; as a command.  
**UNKER'CHIEFED**, *a.* Having no kerchief.  
**UNKERN'ELLED**, *a.* Deſtitute of a kernel.  
**UNKETH**, † *a.* Unconch; ſtrange.  
**UNKILL'ED**, *a.* Not killed; ſtill in being.  
**UNKIND**, *a.* Not kind; not benevolent; not favourable; not obliging.—2. Unnatural.  
**UNKINDLED**, *a.* Not kindled.  
**UNKINDLINESS**, *n.* Unfavourable-  
 neſs.  
**UNKINDLY**, *a.* Unnatural; contrary

to nature; as, an unkindly crime.—2. Unfavourable; malignant; as, an unkindly fog.  
**UNKINDLY**, *adv.* Without kindneſs; without affection; as, to treat one unkindly.—2. In a manner contrary to nature; unnaturally.  
 All works of nature,  
 Abortive, monſtrous, or unkindly mix'd. *Milton.*  
**UNKINDNESS**, *n.* Want of kindneſs; want of natural affection; want of good will.—2. Diſobliging treatment; diſfavour.  
**UNKING'**, *v. t.* To deprive of royalty.  
**UNKING'LIKE**, } *a.* Unbecoming n  
**UNKING'LY**, } king; not noble.  
**UNKISS'ED**, *a.* Not kiſſed.  
**UN'KLE**, † See *UNCLE*.  
**UNKNELLED**, *a.* Untolled.  
**UNKNIGHT'LY**, *a.* Unbecoming a knight.  
**UNKNIT'**, *v. t.* To ſeparate threads that are knit; to open; to looſe work that is knit or knotted.—2. To open.  
**UNKNOT'**, *v. t.* To free from knots; to untie.  
**UNKNOT'TED**, *pp.* Freed from knots; untied.  
**UNKNOT'TY**, *a.* Having no knots.  
**UNKNOW**, † *v. t.* To ceaſe to know.  
**UNKNOWABLE**, *a.* That cannot be known.  
**UNKNOWING**, *a.* Not knowing; ignorant; with *of*.  
*Unknowing of deceit* *Pope.*  
**UNKNOWINGLY**, *adv.* Ignorantly; without knowledge or deſign.  
**UNKNOWN**, *a.* Not known. The author of the invention is unknown.—2. Greater than is imagined.—3. Not having had cohabitation.—4. Not having communication.  
**UNLA'BOURED**, *a.* Not produced by labour; as, unlaboured harveſts.—2. Not cultivated by labour; not tilled.—3. Spontaneous; voluntary; that offers without effort; natural.  
 And from the theme unlabour'd beauties riſe. *Tickel.*  
 4. Easy; natural; not ſtiff; as, an unlaboured ſtyle.  
**UNLABORIOUS**, *a.* Not laborious; not difficult to be done.  
**UNLABORIOUSLY**, *adv.* Without labour.  
**UNLACE**, *v. t.* To looſe from lacing or faſtening by a cord or ſtrings paſſed through loops and holes; as, to unlace a helmet or a garment.—2. To looſe a woman's dreſs.—3. To divest of ornaments.—4. In *ſea lan.*, to looſe and take off a bonnet from a ſail.  
**UNLACED**, *pp.* Looſed from lacing; unfaſtened.  
**UNLACING**, *pp.* Loofing from lacing or faſtening.  
**UNLACK'EYED**, *a.* Unattended with a lackey.  
**UNLADE**, *v. t.* To unload; to take ont the cargo of; as, to unlade a ſhip.—2. To unload; to remove, as a load or burden; Acts xxi.  
**UNLADEN**, *pp.* of *Lade*. Unloaded.  
**UNLADING**, *pp.* Removing the cargo from a ſhip.  
**UNLA'DYLIKE**, *a.* Not lady-like.  
**UNLÄID**, *a.* Not placed; not fixed.—2. Not allayed; not pacified; not ſuppreſſed.—3. Not laid out, as a corſe.  
**UNLAMENT'ED**, *a.* Not lamented; whoſe loſs is not deplored.  
 Thus unlamented paſſ the proud away. *Pope.*  
**UNLAP'**, *v. t.* To unfold.

**UNLAP'PED**, *pp.* Unfolding.  
**UNLAP'PING**, *pp.* Unfolding.  
**UNLÄRDED**, *a.* Not intermixed or inſerted for improvement.  
**UNLASH'**, *v. t.* In *nautical lan.*, to looſe or ſunder what has been lashed or tied.  
**UNLASH'ING**, *pp.* of *Unlash*.  
**UNLASH'ED**, *a.* Untied.  
**UNLATCH'**, *v. i.* To open or looſe by lifting the latch.  
**UNLATCH'ING**, *pp.* Opening or looſing by lifting the latch.  
**UNLATH**, *v. t.* To remove laths or lathine.  
**UNLATH'ED**, *a.* Having no laths.—2. *pp.* Deprived of lathing.  
**UNLÄTHERED**, *a.* Not lathered.  
**UNLÄUNCHED**, *a.* Not launched.  
**UNLAURELLED**, *a.* Not crowned with laurel; not honoured.  
**UNLAVISH**, *a.* Not lavish; not profuſe; not waſteful.  
**UNLAV'ISHED**, *a.* Not lavished; not ſpent waſtefully.  
**UNLAW'**, *v. t.* To deprive of the authority of law.—2. In *Scots law*, to fine.  
**UNLAW'**, *n.* In *Scots law*, any tranſgreſſion of the law; any injury or act of injuſtice; a fine or amerſciament legally fixed and exacted from one who has tranſgreſſed the law.  
**UNLAW'FUL**, *a.* Not lawful; contrary to law; illegal; not permitted by law.—*Unlawful aſſembly*, in *law*, the meeting of three or more perſons to commit an unlawful act.  
**UNLAW'FULLY**, *adv.* In violation of law or right; illegally.—2. Illegitimately; not in wedlock; as, a child unlawfully born.  
**UNLAW'FULNESS**, *n.* Illegality; contrariety to law.—2. Illegitimacy.  
**UNLAW'LIKE**, *a.* Not lawlike.  
**UNLAY'**, *v. t.* In *nautical lan.*, to untwiſt the ſtrands of a rope, &c.  
**UNLAY'ING**, *pp.* of *Unlay*.  
**UNLAID'**, *a.* Untwisted.  
**UNLEACHED**, *a.* Not leached; as, unleached aſhes.  
**UNLEAD'ED**, *a.* Not leaded; not covered with lead.—2. *pp.* Deprived of leads or lead.  
**UNLEARN'**, *v. t.* (unlern'). To forget or loſe what has been learned. It is moſt important to us all to *unlearn* the errors of our early education.  
 I had learned nothing right; I had to unlearn every thing. *Luther in Milner.*  
**UNLEARN'ABLE**, *a.* That cannot be learned; unteachable.  
**UNLEARN'ED**, *pp.* Forgotten.—2. *a.* Not learned; ignorant; illiterate; not inſtructed.—3. Not gained, by ſtudy; not known.—4. Not ſuitable to a learned man; as, unlearned verſes.  
**UNLEARN'EDLY**, *adv.* Ignorantly.  
**UNLEARN'EDNESS**, *n.* Want of learning; illiterateness.  
**UNLEARN'ING**, *pp.* Forgetting what one has learned.  
**UNLEASED**, *a.* Not leaſed.  
**UNLEAVENED**, *a.* (unlev'ened.) Not leavened; not raiſed by leaven, barm or yeast; Exod. xii.  
**UNLECTURED**, *a.* Not taught by lecture.  
**UNLED**, *a.* Not led or conducted.  
**UNLEG'ACIED**, *a.* Having no legacy.  
**UNLEISURED**, † *a.* (unle'zhured.) Not having leiſure.  
**UNLEISUREDNESS**, † *n.* (unle'zhurd-  
 neſs.) Want of leiſure.  
**UNLENT**, *a.* Not lent.  
**UNLESS**, *conj.* [Sax. *onleſan*, to looſe or reſeaſe.] Except; that is, remove

or dismiss the fact or thing stated in the sentence or clause which follows. "We cannot thrive *unless* we are industrious and frugal." The sense will be more obvious with the clauses of the sentence inverted. *Unless*, [remove this fact, suppose it not to exist,] *we are industrious and frugal*, we cannot thrive. *Unless*, then answers for a negation. If we are *not* industrious, we cannot thrive.

UNLESS'ENED, *a.* Not diminished.  
UNLES'ONED, *a.* Not taught; not instructed.

UNLET'TERED, *a.* Unlearned; untaught; ignorant.

UNLET'TEREDNESS, *n.* Want of learning.

UNLEV'EL, *a.* Not level; uneven.

UNLEV'ELED, *a.* Not levelled; not laid even.

UNLEV'IED, *a.* Not levied.

UNLIBID'INOUS, *a.* Not libidinous; not lustful.

UNLI'CEASED, *a.* Not licensed; not having permission by authority; as, an *unlicensed* innkeeper.

The vending of ardent spirits, in places licensed or *unlicensed*, is a tremendous evil.

*L. Beecher.*

UNLICK'ED, *a.* Shapeless; not formed to smoothness; as, an *unlicked* bear whelp, from the notion that the bear licks her young into shape.—2. Rough; uncultivated.

UNLIFT'ED, *a.* Not lifted; not raised.

UNLIGHTED, *a.* Not lighted; not illuminated.—2. Not kindled or set on fire.

UNLIGHTSOME, *a.* Dark; gloomy; wanting light.

UNLIKE, *a.* Dissimilar; having no resemblance. Never were two men more *unlike*. The cases are entirely *unlike*.—2. Improbable; unlikely.—*Unlike quantities*, in *algebra*, are different combinations of letters; or they are such as consist of different letters or different powers.

UNLIKELYHOOD, } *n.* Improbability.  
UNLIKELINESS, }

UNLIKELY, *a.* Improbable; such as cannot be reasonably expected; as, an *unlikely* event. The thing you mention is very *unlikely*.—2. Not promising success. He employs very *unlikely* means to effect his object.

UNLIKELY, *adv.* Improbably.

UNLIKENESS, *n.* Want of resemblance; dissimilitude.

UNLIM'BER, *a.* Not limber; not flexible; not yielding.

UNLIM'BER, *v. t.* In *milit. lan.*, to take off the limbers; as, to *unlimber* the guns. [See LIMBERS.]

UNLIM'BERED, *n. pp.* or *a.* Freed from the limbers.

UNLIM'BERING, *ppr.* Taking off the limbers.

UNLIMITABLE, *a.* Admitting no limits; boundless. [We now use *ilimitable*.]

UNLIMITED, *a.* Not limited; having no bounds; boundless.—2. Undefined; indefinite; not bounded by proper exceptions; as, *unlimited* terms.—3. Unconfined; not restrained.

Ascribe not to God such an *unlimited* exercise of mercy as may destroy his justice.

*Rogers.*

*Unlimited problem*, is one which may have an infinite number of solutions.

UNLIMITEDLY, *adv.* Without bounds.

UNLIMITEDNESS, *n.* The state of being boundless, or of being undefined.

UNLIN'EAL, *a.* Not in a line; not coming in the order of succession.

UNLINING, *n.* In *bot.*, a term used to express the formation of certain parts in the flower, by the separation of a lamina from the petal. The process is sometimes called deduplication, chorization and dilamination. It accounts for some anomalous appearances in flowers, more especially the formation of scales opposite the petals.

UNLINK', *v. t.* To separate links; to loose; to unfasten; to untwist.

UNLIQUIDATED, *a.* Not liquidated; not settled; not having the exact amount ascertained; as, an *unliquidated* debt; *unliquidated* accounts.—2. Unpaid; unadjusted.

UNLIQUEFIED, *a.* Unmelted; not dissolved.

UNLIQUORED, *a.* Not moistened; not smeared with liquor; not filled with liquor.

UNLIST'ENING, *a.* Not listening; not hearing; not regarding.

UNLITERARY, *a.* Not literary; illiterate.

UNLIVELINESS, *n.* Want of life; dullness.

UNLIVELY, *a.* Not lively; dull.

UNLOAD, *v. t.* To take the load from; to discharge of a load or cargo; as, to *unload* a ship; to *unload* a cart.—2. To disburden; as, to *unload* a beast.—3. To disburden; to relieve from any thing, onerous or troublesome.—*To unload a gun or a musket*, is to take the powder and ball out of it.

UNLOADED, *pp.* Free from a load or cargo; disburdened.

UNLOADING, *ppr.* Freeing from a load or cargo; disburdening; relieving of a burden.

UNLOCATED, *a.* Not placed; not fixed in a place.—2. In *America*, unlocated lands are such new or wild lands as have not been surveyed, appropriated, or designated by marks, limits, or boundaries, to some individual, company, or corporation.

UNLOCK', *v. t.* To unfasten what is locked; as, to *unlock* a door or a chest.—2. To open, in general; to lay open.

*Unlock your springs*, and open all your shades. *Pope.*

UNLOCKED, *pp.* Opened.—2. *a.* Not locked; not made fast.

UNLODGE, *v. t.* To deprive of a lodging; to dislodge.

UNLOOKED FOR, Not expected; not foreseen.

UNLOOP', *v. t.* To undo a loop.

UNLOOP'ED, *pp.* or *a.* Not fastened by a loop; unfastened.

UNLOOSE', *v. t.* To loose; to untie; to let go or free from hold or fastening. [In this word the prefix *un* is merely intensive.]

UNLOOSE', *v. i.* To fall in pieces; to loose all connection or union. [See ABOVE.]

UNLORD'LY, *a.* Not lordly; not arbitrary.

UNLÖSABLE, † *a.* (*s* as *z*.) That cannot be lost.

UNLOVED, *a.* Not loved.

UNLOVELINESS, *n.* Want of loveliness; unamiableness; want of the qualities which attract love.

UNLOVELY, *a.* Not lovely; not amiable; destitute of the qualities which attract love, or possessing qualities that excite dislike.

UNLOVING, *a.* Not loving; not fond.

UNLOVINGLY, *adv.* In an unloving manner.

UNLU'BRICATED, *a.* Not lubricated.

UNLUCK'ILY, *adv.* Unfortunately; by ill fortune.

UNLUCK'INESS, *n.* Unfortunateness; ill fortune.—2. Mischievousness.

UNLUCK'Y, *a.* Unfortunate; not successful; as, an *unlucky* man.—2. Unfortunate; not resulting in success; as, an *unlucky* adventure; an *unlucky* throw of dice; an *unlucky* game. [This word is usually applied to incidents in which success depends on single events, to games of hazard, &c., rather than to things which depend on a long series of events, or on the ordinary course of Providence. Hence we say, a man is *unlucky* in play or in a lottery; but not that a farmer is *unlucky* in his husbandry, or a commander *unlucky* in the result of a campaign.]—3. Unhappy; miserable; subject to frequent misfortunes.—4. Slightly mischievous; mischievously waggish; as, an *unlucky* boy; an *unlucky* wag. [Colloq.]—5. Ill omened; inauspicious.

Haunt me not with that *unlucky* face. *Dryden.*

UNLUS'TROUS, *a.* Wanting lustre; not shining.

UNLUSTROUSLY, *adv.* With want of lustre.

UNLUST'Y, *a.* Not lusty; not stont; weak.

UNLÜTE, *v. t.* To separate things cemented or luted; to take the lute or clay from.

UNLÜTED, *pp.* Separated, as luted vessels.

UNLÜTING, *ppr.* Separating, as luted vessels.

UNLUX'URIOUS, *a.* Not luxurious.

UNMAD'DENED, *a.* Not maddened.

UNMADE, *pp.* Deprived of its form or qualities.—2. *a.* Not made; not yet formed.—3. Omitted to be made.

UNMAGNET'IC, *a.* Not having magnetic properties.

UNMAIDENLY, *a.* Not becoming a maiden.

UNMAILED, *a.* Not mailed.

UNMAIMED, *a.* Not maimed; not disabled in any limb; sound; entire.

UNMAINTAINABLE, *a.* That cannot be maintained or supported.

UNMAKABLE, *a.* Not possible to be made. [Little used.]

UNMAKE, *v. t.* To destroy the form and qualities which constitute a thing what it is.

God does not make or *unmake* things to try experiments. *Burnet.*

2. To deprive of qualities before possessed.

UNMAKING, *ppr.* Destroying the peculiar properties of a thing.

UNMAL'ICIOUS, *a.* Not malicious.

UNMALLEABILITY, *n.* The quality or state of being unamalleable.

UNMALLEABLE, *a.* Not malleable; not capable of being hammered into a plate, or of being extended by beating.

UNMAN', *v. t.* To deprive of the constitutional qualities of a human being, as reason, &c.—2. To deprive of men; as, to *unman* a ship.—3. To emasculate; to deprive of virility.—4. To deprive of the courage and fortitude of a man; to break or reduce into irresolution; to dishearten; to deject.—5. To dispeople; as, towns *unmanned*.

UNMAN'AGED, *a.* Not managed.

UNMAN'AGEABLE, *a.* Not manageable; not easily restrained, governed, or directed; not controllable.—2. Not easily welded.

## UNMASTICABLE

UNMAN'AGEABLENESS, *n.* State of being unmanageable.  
 UNMAN'AGEABLY, *adv.* So as not to be manageable.  
 UNMAN'AGED, *a.* Not broken by horsemanship.—2. Not tutored; not educated.  
 UNMAN'FUL, *a.* Not becoming a man; unmanly.  
 UNMAN'LIKE, } *a.* Not becoming a  
 UNMAN'LY, } human being.—2.  
 Unsuitable to a man; effeminate.  
*Unmanly* warmth and tenderness of love.  
*Addison.*  
 3. Not worthy of a noble mind; ignoble; base; ungenerous; cowardly.  
 UNMAN'LINESS, *n.* State of being unmanly.  
 UNMAN'NED, *pp.* Deprived of the qualities of a man; rendered effeminate; dispirited; dejected; deprived of manly fortitude.—2. Not furnished with men.—3. Not tamed; a term in *falconry*.  
 UNMAN'NERED, *a.* Uncivil; rude.  
 UNMAN'NERLINESS, *n.* Want of good manners; breach of civility; rudeness of behaviour.  
 UNMAN'NERLY, *a.* Ill bred; not having good manners; rude in behaviour; as, an *unmanly* youth.—2. Not according to good manners; as, an *unmanly* jest.  
 UNMAN'NERLY, *adv.* Uncivily.  
 UNMAN'NING, *ppr.* Depriving of the powers or qualities of a man.  
 UNMAN'TLE, *v. t.* To divest of a mantle or cloak; to dismantle.  
 UNMAN'TLED, *a.* Not mantled; not cloaked; having no mantle or cloak.  
 UNMANU'FACTURED, *a.* Not manufactured; not wrought into the proper form for use.  
 UNMAN'URED, *a.* Not manured; not enriched by manure.—2. Uncultivated.  
 UNMARKED, *a.* Not marked; having no mark.—2. Unobserved; not regarded; undistinguished.  
 UNMÄRK'ETABLE, *a.* Not marketable.  
 UNMÄRRED, *a.* Not marred; not injured; not spoiled; not obstructed.  
 UNMAR'RIABLE, *a.* Not marriageable. [*Little used.*]  
 UNMAR'RIAGEABLE, *a.* Not fit to be married.  
 UNMAR'RIAGEABLENESS, *n.* The state or condition of not being fit to be married.  
 UNMAR'RIED, *a.* Not married; having no husband or no wife.  
 UNMAR'RY, *v. t.* To divorce.  
 UNMÄRSHALLED, *a.* Not disposed or arranged in due order.  
 UNMÄSCULATE, *v. t.* To emasculate.  
 UNMÄSCULINE, *a.* Not masculine or manly; feeble; effeminate.  
 UNMÄSCULINELY, *adv.* In an unmasculine manner.  
 UNMÄSK, *v. t.* To strip of a mask or of any disguise; to lay open what is concealed.  
 UNMÄSK, *v. i.* To put off a mask.  
 UNMÄSKED, *pp.* Stripped of a mask or disguise.—2. *a.* Open; exposed to view.  
 UNMÄSKING, *ppr.* Stripping off a mask or disguise.  
 UNMÄSTERABLE, } *a.* That cannot  
 be mastered or subdued.  
 UNMÄSTERED, *a.* Not subdued; not conquered.—2. Not conquerable.  
 He cannot his *unmaster'd* grief sustain.  
*Dryden.*  
 UNMAS'TICABLE, *a.* Not capable of being chewed.

## UNMERCIFUL

UNMATCH'ABLE, *a.* That cannot be matched; that cannot be equalled; unparalleled.  
 UNMATCH'ED, *a.* Matchless; having no match or equal.  
 UNMEANING, *a.* Having no meaning or signification; as, *unmeaning* words.—2. Not expressive; not indicating intelligence; as, an *unmeaning* face  
 There pride sits blazon'd on th' *unmeaning* brow. *Trumbull.*  
 UNMEANINGLY, *adv.* Without significance.  
 UNMEANINGNESS, *n.* Want of meaning.  
 UNMEANT, *a.* (unment'.) Not meant; not intended.  
 UNMEASURABLE, *a.* (unmezh'urable.) That cannot be measured; unbounded; boundless. [For this, *immeasurable* is generally used.]  
 UNMEAS'URABLY, *adv.* Beyond all measure.  
 UNMEAS'URED, *a.* Not measured; plentiful beyond measure.—2. Immense; infinite; as, *unmeasured* space.  
 UNMECHAN'ICAL, *a.* Not mechanical; not according to the laws or principles of mechanics.  
 UNMECHAN'ICALLY, *adv.* Not according to the laws of mechanics.  
 UNMED'DLED WITH, *a.* Not meddled with; not touched; not altered.  
 UNMED'DLING, *a.* Not meddling; not interfering with the concerns of others; not officious.  
 UNMED'DLINGLY, } *adv.* Without  
 meddling.  
 UNMED'DLINGNESS, } *n.* Forbearance  
 of interposition.  
 UNMED'ITATED, *a.* Not meditated; not prepared by previous thought.  
 UNMÄET, *a.* Not fit; not proper; not worthy or suitable.  
 UNMÄETLY, *adv.* Not fitly; not properly; not suitably.  
 UNMÄETNESS, *n.* Unfitness; unsuitableness.  
 UNMÄLOWED, *a.* Not mellowed; not fully matured.  
 UNMÄLO'DIOUS, *a.* Not melodious; wanting melody; harsh.  
 UNMÄLO'DIOUSLY, *adv.* Without melody.  
 UNMÄLO'DIOUSNESS, *n.* State of being destitute of melody.  
 UNMÄLTED, *a.* Undissolved; not melted.—2. Not softened  
 UNMÄLT'EDNESS, *n.* State of being unmelted.  
 UNMÄMBER, *v. t.* To deprive of membership in a church.  
 UNMÄMBERED, *pp.* Deprived of membership  
 UNMÄN'ACED, *a.* Not threatened.  
 UNMÄN'ACING, *a.* Not threatening.  
 UNMÄN'ACINGLY, *adv.* Without menacing.  
 UNMÄN'TIONABLE, *a.* Not to be mentioned.  
 UNMÄN'TIONABLES, *n. plur.* In *burllesque style*, breeches, as a piece of dress not to be mentioned in polite circles.  
 UNMÄN'TIONED, *a.* Not mentioned; not named.  
 UNMÄR'CANTILE, *a.* Not according to the customs and rules of commerce.  
 UNMÄR'CENARY, *a.* Not mercenary; not hired.  
 UNMÄR'CHANTABLE, *a.* Not merchantable; not of a quality fit for the market.  
 UNMÄR'CIFUL, *a.* Not merciful; cruel; inhuman to such beings as are in one's power; not disposed to spare

## UNMODIFIABLE

or forgive.—2. Unconscionable; exorbitant; as, *unmerciful* demands.  
 UNMÄR'CIFULLY, *adv.* Without mercy or tenderness; cruelly.  
 UNMÄR'CIFULNESS, *n.* Want of mercy; want of tenderness and compassion toward those who are in one's power; cruelty in the exercise of power or punishment.  
 UNMÄR'ITABLE, } *a.* Having no merit  
 or desert.  
 UNMÄR'ITED, } *a.* Not merited; not  
 deserved; obtained without service or equivalent; as, *unmerited* promotion.—2. Not deserved; cruel; unjust; as, *unmerited* sufferings or injuries.  
 UNMÄR'ITEDLY, *adv.* Not deservedly.  
 UNMÄR'ITEDNESS, *n.* State of being unmerited.  
 UNMÄT, *a.* Not met.  
 UNMÄTAL'LIC, *a.* Not metallic; not having the properties of metal; not belonging to metals.  
 UNMÄTAPHYS'ICAL, *a.* Not metaphysical; not pertaining to metaphysics.  
 UNMÄMETH'ODIZED, *a.* Not methodized.  
 UNMÄIGHTY, *a.* Not mighty; not powerful.  
 UNMÄILD, *a.* Not mild; harsh; severe; fierce.  
 UNMÄILDLY, *adv.* Not mildly; harshly.  
 UNMÄILDNESS, *n.* Want of mildness; harshness.  
 UNMÄILITARY, *a.* Not according to military rules or customs.  
 UNMÄILK'ED, *a.* Not milked.  
 UNMÄIL'ED, *a.* Not milled; not indented or grained; as, *unmilled* coin.  
 UNMÄINDED, *a.* Not minded; not heeded.  
 UNMÄINDFUL, *a.* Not mindful; not heedful; not attentive; regardless; as, *unmindful* of laws; *unmindful* of health or of duty.  
 UNMÄINDFULLY, *adv.* Carelessly; heedlessly.  
 UNMÄINDFULNESS, *n.* Heedlessness; inattention; carelessness.  
 UNMÄIN'GLE, *v. t.* To separate things mixed.  
 UNMÄIN'GLEABLE, } *a.* That cannot  
 be mixed.  
 UNMÄIN'GLED, *a.* Not mingled; not mixed; pure.—2. Pure; not vitiated or alloyed by foreign admixture; as, *unmingled* joy.  
 UNMÄINISTE'RIAL, *a.* Not ministerial.  
 UNMÄINISTE'RIALLY, *adv.* Unsuitably to a minister.  
 UNMÄMIRAC'ULOUS, *a.* Not miraculous.  
 UNMÄMIRAC'ULOUSLY, *adv.* Without a miracle.  
 UNMÄMIRY, *a.* Not miry; not muddy; not foul with dirt.  
 UNMÄMISS'ED, *a.* Not missed; not perceived to be gone or lost.  
 UNMÄMISTAKEABLE, *a.* That cannot be mistaken. [*Little used.*]  
 UNMÄMISTAKEN, *a.* Not mistaken; sure.  
 UNMÄMISTRUST'ING, *a.* Not mistrusting; not suspecting; unsuspecting.  
 UNMÄMIT'IGABLE, *a.* Not capable of being mitigated, softened or lessened.  
 UNMÄMIT'IGATED, *a.* Not mitigated; not lessened; not softened in severity or harshness.  
 UNMÄMIX'ED, } *a.* Not mixed; not  
 UNMÄMIX'T, } mingled; pure; unadulterated; unvitiated by foreign admixture.—2. Pure; unalloyed; as, *unmixed* pleasure.  
 UNMÄMOANED, *a.* Not lamented.  
 UNMÄMOD'IFIABLE, *a.* That cannot be modified or altered in form; that can-

not be reduced to a more acceptable or desired form.

UNMODIFIED, *a.* Not modified; not altered in form; not qualified in meaning.

UNMODISH, *a.* Not modish; not according to custom.

UNMODULATED, *a.* Not modulated.

UNMOIST', *a.* Not moist; not humid; dry.

UNMOISTENED, Not made moist or humid.

UNMOLESTED, *a.* Not molested; not disturbed; free from disturbance.

UNMONEYED, *a.* Not having money.

UNMONOPOLIZE, † *v. t.* To recover from being monopolized.

UNMONOPOLIZED, *a.* Not monopolized.

UNMOOR', *v. t.* In *sea lan.*, to bring to the state of riding with a single anchor, after having been moored by two or more cables.—2. To loose from anchorage.

UNMOORED, *pp.* Loosed from anchorage, or brought to ride with a single anchor.

UNMOORING, *ppr.* Loosing from anchorage, or bringing to ride with a single anchor.

UNMORALIZED, *a.* Untutored by morality; not conformed to good morals.

UNMORTGAGED, *a.* [See MORTGAGE.] Not mortgaged; not pledged.

UNMORTIFIED, *a.* Not mortified; not shamed.—2. Not subdued by sorrow; as, *unmortified sin.*

UNMOTHERLY, *a.* Not becoming a mother.

UNMOULD, *v. t.* To change the form; to reduce from any form.

UNMOULDED, *pp.* Not changed in form.—2. *a.* Not moulded; not shaped or formed.

UNMOUNTED, *a.* Not mounted. *Unmounted* dragoons are such as have no horses.

UNMOURNED, *a.* Not lamented.

UNMOVABLE, *a.* That cannot be moved or shaken; firm; fixed. [*Immovable* is more generally used.]

UNMOVABLY, † *adv.* Immovably.

UNMOVED, *a.* Not moved; not transferred from one place to another.—2. Not changed in purpose; unshaken; firm.—3. Not affected; not having the passions excited; not touched or impressed.—4. Not altered by passion or emotion.

UNMOVEDLY, *adv.* Quietly; without emotion.

UNMOVING, *a.* Having no motion.—2. Not exciting emotion; having no power to affect the passions.

UNMUFFLE, *v. t.* To take a covering from the face.—2. To remove the muffling of a drum.

UNMUFFLED, *pp.* Uncovered.

UNMUFFLING, *ppr.* Removing a covering.

UNMURMURED, *a.* Not murmured at.

UNMURMURING, *a.* Not murmuring; not complaining; as, *unmurmuring* patience.

UNMURMURINGLY, *adv.* Without a murmur.

UNMUSICAL, *a.* (*s* as *z.*) Not musical; not harmonious or melodious.—2. Harsh; not pleasing to the ear.

UNMUSICALLY, *adv.* Without harmony; harshly.

UNMUSING, *a.* Not musing.

UNMUSINGLY, *adv.* In an unmusing manner.

UNMUTILATED, *a.* Not mutilated; not deprived of a member or part; entire.

UNMUZZLE, *v. t.* To loose from a muzzle.

UNMUZZLED, *pp.* Loosed from a muzzle.

UNNAMED, *a.* Not named; not mentioned.

UNNATIONAL, *a.* (unnash'unal.) Not national; unpatriotic.

UNNATIVE, *a.* Not native; not natural; forced.

UNNATURAL, *a.* Contrary to the laws of nature; contrary to the natural feelings.—2. Acting without the affections of our common nature; as, an *unnatural* father or son.—3. Not in conformity to nature; not agreeable to the real state of persons or things; not representing nature; as, affected and *unnatural* thoughts; *unnatural* images or descriptions.

UNNATURALIZE, *v. t.* To divest of natural feelings.

UNNATURALIZED, *pp.* Divested of natural feelings.—2. *a.* Not naturalized; not made a citizen by authority.

UNNATURALLY, *adv.* In opposition to natural feelings and sentiments.

UNNATURALNESS, *n.* Contrariety to nature.

UNNAVIGABLE, *a.* Not navigable. [But *innavigable* is more generally used.]

UNNAVIGATED, *a.* Not navigated; Not passed over in ships or other vessels.

UNNECESSARILY, *adv.* Without necessity; needlessly.

UNNECESSARINESS, *n.* The state of being unnecessary; needlessness.

UNNECESSARY, *a.* Not necessary; needless; not required by the circumstances of the case; useless; as, *unnecessary* labour or care; *unnecessary* rigour.

UNNECESSITATED, *a.* Not required by necessity.

UNNEEDED, *a.* Not needed.

UNNEEDFUL, *a.* Not needful; not wanted; needless.

UNNEEDFULLY, *adv.* Not needfully.

UNNEIGHBOURLY, *a.* Not suitable to the duties of a neighbour; not becoming persons living near each other; not kind and friendly.

UNNEIGHBOURLY, *adv.* In a manner not suitable to a neighbour; in a manner contrary to the kindness and friendship which should subsist among neighbours.

UNNERVATE, † *a.* Not strong; feeble.

UNNERVE, *v. t.* (unnerv'). To deprive of nerve, force, or strength; to weaken; to enfeeble; as, to *unnerve* the arm.

UNNERVED, *pp.* Deprived of strength.—2. *a.* Weak; feeble.

UNNERVING, *ppr.* Depriving of strength.

UNNETH, † } *adv.* Scarcely; hardly.

UNNETHES, } [See UNEATH.]

UNNEUTRAL, *a.* Not neutral; not uninterested.

UNNOBLE, *a.* Not noble; ignoble; mean.

UNNOBLY, † *adv.* Ignobly.

UNNOTED, *a.* Not noted; not observed; not heeded; not regarded.—2. Not honoured.

UNNOTICED, *a.* Not observed; not regarded.—2. Not treated with the usual marks of respect; not kindly and hospitably entertained.

UNNOTICING, *a.* Not taking notice.

UNNUMBERED, *a.* Not numbered; innumerable; indefinitely numerous.

UNNURTURED, *a.* Not nurtured; not educated.

UNNUTRITIOUS, *a.* Not affording nourishment.

UNOBEYED, *a.* Not obeyed.

UNOBEYING, *a.* Not yielding obedience.

UNOBJECTED, *a.* Not objected; not charged as a fault or error.

UNOBJECTIONABLE, *a.* Not liable to objection; that need not be condemned as faulty, false, or improper.

UNOBJECTIONABLY, *adv.* In a manner not liable to objection.

UNOBLIGED, *a.* Not obliged.

UNOBLIGING, Not obliging or disposed to oblige.

UNOBLITERATED, *a.* Not obliterated or effaced.

UNOBNOXIOUS, *a.* Not liable; not exposed to harm.

UNOBNOXIOUSLY, *adv.* In an unobnoxious manner.

UNOBSCURED, *a.* Not obscured; not darkened.

UNOBSEQUIOUS, *a.* Not obsequious; not servilely submissive.

UNOBSEQUIOUSLY, *adv.* Not with servile submissiveness.

UNOBSEQUIOUSNESS, *n.* Want of servile submissiveness or compliance; incomppliance.

UNOBSERVABLE, *a.* (*s* as *z.*) That is not observable; not discoverable.

UNOBSERVANCE, *n.* Want of observation; inattention; regardlessness.

UNOBSERVANT, *a.* Not observant; not attentive; heedless.—2. Not obsequious.

UNOBSERVANTLY, *adv.* Not observantly.

UNOBSERVED, *a.* Not observed; not noticed; not seen; not regarded; not heeded.

UNOBSERVEDLY, *adv.* Without being observed.

UNOBSERVING, *a.* Not observing; inattentive; heedless.

UNOBSERVINGLY, *adv.* Inattentively.

UNOBSTRUCTED, *a.* Not obstructed; not filled with impediments; as, an *unobstructed* stream or channel.—2. Not hindered; not stopped.

UNOBSTRUCTEDLY, *adv.* Without being obstructed.

UNOBSTRUCTIVE, *a.* Not presenting any obstacle.

UNOBSTRUCTIVELY, *adv.* Without obstruction.

UNOBSTRUCTIVENESS, *n.* State of being not obstructive.

UNOBTAINABLE, *a.* That cannot be obtained; not within reach or power.

UNOBTAINABLENESS, *n.* State of being unobtainable.

UNOBTAINED, *a.* Not obtained; not gained; not acquired.

UNOBTRUSIVE, *a.* Not obtrusive; not forward; modest.

UNOBTRUSIVELY, *adv.* Modestly.

UNOBTRUSIVENESS, *n.* State of being unobtrusive.

UNOBVIOUS, *a.* Not obvious; not readily occurring to the view or the understanding.

UNOCCUPIED, *a.* Not occupied; not possessed; as, *unoccupied* land.—2. Not engaged in business; being at leisure. The man is *unoccupied*.—3. Not employed or taken up; as, time *unoccupied*.

UNOFFENDED, *a.* Not offended; not having taken offence.

**UNOFFENDING**, *a.* Not offending; not giving offence.—2. Not sinning; free from sin or fault.—3. Harmless; innocent.

**UNOFFENSIVE**, *a.* Not offensive; giving no offence; harmless. [For this *inoffensive* is more generally used.]

**UNOFFERED**, *a.* Not offered; not proposed to acceptance.

**UNOFFICIAL**, *a.* Not official; not pertaining to office.—2. Not proceeding from the proper officer or from due authority; as, *unofficial* news or notice.

**UNOFFICIALLY**, *adv.* Not officially; not in the course of official duty. The man was *unofficially* informed by the sheriff or commander.

**UNOFFICIOUS**, *a.* Not officious; not forward or intermeddling.

**UNOFFICIOUSLY**, *adv.* Not officiously.

**UNOFFICIOUSNESS**, *n.* The state of not being officious.

**UNOFFTEN**, *adv.* Rarely.

**UNOIL**, *v. t.* To free from oil.

**UNOILED**, *pp.* Freed from oil.—2. *a.* Not oiled; free from oil.

**UNONA**, *n.* A genus of plants, nat. order, *Anonaceæ*. The species consist of trees, large shrubs, or climbing plants, found in India, Africa, and South America. The bark and fruit



*Unona febrifuga.*

of many of the species are aromatic, with some degree of acridity, and are employed as stimulants and febrifuges.

**UNOPENED**, *a.* Not opened; remaining fast, close, shut, or sealed.

**UNOPENING**, *a.* Not opening.

**UNOPERATIVE**, *a.* Not operative; producing no effect. [But *inoperative* is generally used.]

**UNOPERCULATED**, *a.* Having no cover or operculum.

**UNOPPOSED**, *a.* (as *z.*) Not opposed; not resisted; not meeting with any obstruction; as, an army or stream *unopposed*.

**UNOPPRESS'ED**, *a.* Not oppressed; not unduly burdened.

**UNOPPRESS'IVE**, *a.* Not oppressive.

**UNORDAIN'ED**, *a.* Not ordained.

**UNORDER'ED**, *a.* Not ordered.

**UNORDERLY**, *a.* Not orderly; disordered; irregular. [*Disorderly* is more generally used.]

**UNORDINARY**, *adv.* Not ordinary; not common.

**UNORGANIZED**, *a.* Not organized; not having organic structure or vessels for the preparation, secretion, and distribution of nourishment, &c. Metals are *unorganized* bodies. [This word is in use, but *inorganized* is also used.]

**UNORIENT'AL**, *a.* Not oriental.

**UNORIG'INAL**, *a.* Not original; derived.—2. Having no birth; ungenerated.

**UNORIG'INATED**, *a.* Not originated; having no birth or creation.

God is undervived, *unoriginated*, and self-existent. *Stephens.*

**UNORNAMENT'AL**, *a.* Not ornamental.

**UNOR'NAMENTED**, *a.* Not ornamented; not adorned; plain.

**UNORTHODOX**, *a.* Not orthodox; not holding the genuine doctrines of the Scriptures.

**UNORTHODOXLY**, *adv.* Not orthodoxly.

**UNOSTENTA'TIOUS**, *a.* Not ostentatious; not boastful; not making show and parade; modest.—2. Not glaring; not showy; as, *unostentatious* colouring.

**UNOSTENTA'TIOUSLY**, *adv.* Without show, parade, or ostentation.

**UNOSTENTA'TIOUSNESS**, *n.* State of being free from ostentation.

**UNOWED**, *a.* Not owed; not due.

**UNOWNED**, *a.* Not owned; having no known owner; not claimed.—2. Not avowed; not acknowledged as one's own; not admitted as done by one's self.

**UNOX'IDATED**, **UNOX'IDIZED**, **UNOX'YGENATED**, **UNOX'YGENIZED**, } *a.* Not having oxygen in combination.

**UNPACIF'IC**, *a.* Not pacific; not disposed to peace; not of a peaceable disposition.

**UNPACIF'ICALLY**, *adv.* Not pacifically.

**UNPAC'IFIED**, *a.* Not pacified; not appeased; not calmed.

**UNPACK**, *v. t.* To open, as things packed; as, to *unpack* goods.—2. To disburden. [*Little used.*]

**UNPACKED**, *pp.* Opened, as goods.—2. *a.* Not packed; not collected by unlawful artifices; as, an *unpacked* jury.

**UNPACK'ING**, *ppr.* Opening, as a package.

**UNPAID**, *a.* Not paid; not discharged; as a debt.—2. Not having received his due; as, *unpaid* workmen.—*Unpaid for*, not paid for; taken on credit.

**UNPAINED**, *a.* Not pained; suffering no pain.

**UNPAIN'FUL**, *a.* Not painful; giving no pain.

**UNPAIN'FULLY**, *adv.* Without pain.

**UNPAINT'**, *v. t.* To efface painting or colour.

**UNPAINT'ED**, *a.* Not painted.

**UNPAIRED**, *a.* Not paired; not matched.

**UNPAL'ATABLE**, *a.* Not palatable; disgusting to the taste.—2. Not such as to be relished; disagreeable; as, an *unpalatable* law.

**UNPAL'ATABLY**, *adv.* So as not to be relished.

**UNPALL'ED**, *a.* Not deadened.

**UNPAN'OPLIED**, *a.* Destitute of panoply or complete armour.

**UNPARADISE**, *v. t.* To deprive of happiness like that of paradise; to render unhappy.

**UNPAR'AGONED**, *a.* Unequaled; unmatched.

**UNPAR'ALLELED**, *a.* Having no parallel or equal; unequalled; unmatched.

The *unparalleled* perseverance of the armies of the United States, under every suffering and discouragement, was little short of a miracle. *Washington.*

**UNPAR'ALYZED**, *a.* Not paralyzed.

**UNPARDONABLE**, *a.* Not to be for-

given; that cannot be pardoned or remitted; as, an *unpardonable* sin.

**UNPARDONABLENESS**, *n.* Quality of not being pardonable.

**UNPARDONABLY**, *adv.* Beyond forgiveness.

**UNPARDONED**, *a.* Not pardoned; not forgiven; as, *unpardoned* offences.—2. Not having received a legal pardon. The convict returned *unpardoned*.

**UNPARDONING**, *a.* Not forgiving; not disposed to pardon.

**UNPARLIAMENT'ARILY**, *adv.* Not according to the rules of parliament.

**UNPARLIAMENT'ARINESS**, *n.* Contrariety to the rules, usages, or constitution of parliament.

**UNPARLIAMENT'ARY**, *a.* Contrary to the usages or rules of proceeding in parliament.—2. Contrary to the rules or usages of legislative bodies.

**UNPARTED**, *a.* Not parted; not divided; not separated.

**UNPARTIAL**, *adv.* Not partial. [See *IMPARTIAL.*]

**UNPARTIALLY**, *adv.* Fairly; impartially.

**UNPARTICIPATED**, *a.* Not participated or shared.

**UNPASSABLE**, *a.* Not admitting persons to pass; impassable; as, *unpassable* roads, rivers, or mountains. [*Impassable* is more generally used.]—2. Not current; not received in common payments; as, *unpassable* notes or coins. [Instead of this, *uncurrent* and *not current* are now used.]

**UNPAS'SIONATE**, *a.* Calm; free

**UNPAS'SIONATED**, } from passion; impartial. [Instead of these words, *dispassionate* is now used.]

**UNPAS'SIONATELY**, *adv.* Without passion; calmly. [For this, *dispassionately* is now used.]

**UNPASSIONED**, *a.* Free from passion.

**UNPASTORAL**, *a.* Not pastoral; not suitable to pastoral manners.

**UNPATENTED**, *a.* Not granted by patent.

**UNPAT'IED**, *a.* Unmarked by passage; not trodden.—2. Not being beaten into a path; as, *unpat'ied* snow.

**UNP'ATHET'IC**, *a.* Not pathetic; not adapted to move the passions or excite emotion.

**UNP'ATHET'ICALLY**, *adv.* Without moving the passions or exciting emotion.

**UNPATRIOT'IC**, } *a.* Not patriotic.

**UNPATRIOT'ICALLY**, *adv.* Not patriotically.

**UNPATRONIZED**, *a.* Not having a patron; not supported by friends.

**UNPAT'ERNED**, *a.* Having no equal.

**UNPAU'PERIZED**, *a.* Not pauperized.

**UNPAVED**, *a.* Not paved; not covered with stone.

**UNPAVIL'IONED**, *a.* Having no pavilion.

**UNPAWN'ED**, *a.* Not pawned; not pledged.

**UNPAY**, *v. t.* To undo.—2. *adv.* Not to pay or compensate.

**UNPAYING**, *a.* Neglecting payment.

**UNPAY'INGLY**, *adv.* Unprofitably.

**UNPEACEABLE**, *a.* Not peaceable; quarrelsome.

**UNPEACEABLENESS**, *n.* Unquietness; quarrelsomeness.

**UNPEACEABLY**, *adv.* Unquietly.

**UNPEACEFUL**, *a.* Not pacific or peaceful; unquiet.

**UNPEACEFULLY**, *adv.* Not peacefully.

UNPEACEFULNESS, *n.* Disquiet; inquietude.  
 UNPEDESTALIZED, *a.* Not distinguished by a pedigree.  
 UNPEELED, *a.* Not peeled; not deprived of the peel.  
 UNPEG, *v. t.* To loose from pegs; to open.—2. To pull out the peg from.  
 UNPEGGED, *pp.* Loosed from pegs; opened.  
 UNPELTED, *a.* Not pelted; not assailed with stones.  
 UNPEN, *v. t.* To let out or suffer to escape by breaking a dam or opening a pen.  
 If a man *unpens* another's water...  
*Blackstone.*  
 UNPENAL, *a.* Not penal; not subject to a penalty.  
 UNPENICILLED, *a.* Not pencilled.  
 UNPENETRABLE, *a.* Not to be penetrated. [But *impenetrable* is chiefly used.]  
 UNPENETRATED, *a.* Not entered or pierced.  
 UNPENITENT, *a.* Not penitent. [But *impenitent* is the word now used.]  
 UNPENNING, *pp.* Unfastened; let out.  
 UNPENNING, *pp.* Suffering to escape; unlocking.  
 UNPENSIONED, *a.* Not pensioned; not rewarded by a pension; as, an *unpensioned* soldier.—2. Not kept in pay; not held in dependence by a pension.  
 UNPEOPLE, *v. t.* To deprive of inhabitants; to depopulate; to dispeople.  
 UNPEOPLED, *pp.* Depopulated; dispeopled.  
 UNPEOPLING, *pp.* Depopulating.  
 UNPERCEIVABLE, *a.* Not to be perceived; not perceptible.  
 UNPERCEIVABLY, *adv.* In a manner not to be perceived.  
 UNPERCEIVED, *a.* Not perceived; not heeded; not observed; not noticed.  
 UNPERCEIVEDLY, *adv.* So as not to be perceived.  
 UNPERFECT, *a.* Not perfect; not complete. [But the word now used is *imperfect*.]  
 UNPERFECTED, *a.* Not perfected; not completed.  
 UNPERFECTLY, *adv.* Imperfectly.  
 UNPERFECTNESS, *n.* Want of perfectness; incompleteness. [*Imperfectness* and *imperfection* are now used.]  
 UNPERFORATED, *a.* Not perforated; not penetrated by openings.  
 UNPERFORMED, *a.* Not performed; not done; not executed; as, the business remains *unperformed*.—2. Not fulfilled; as, an *unperformed* promise.  
 UNPERFORMING, *a.* Not performing; not discharging its office.  
 UNPERISHABLE, *a.* Not perishable; not subject to decay. [The word now used is *imperishable*.]  
 UNPERISHABLY, *adv.* Imperishably.  
 UNPERISHING, *a.* Not perishing; durable.  
 UNPERISHINGLY, *adv.* Not perishingly.  
 UNPERJURED, *a.* Free from the crime of perjury.  
 UNPERMANENT, *a.* Not permanent; not durable.  
 UNPERMITTED, *a.* Not permitted.  
 UNPERPLEX, *v. t.* To free from perplexity.  
 UNPERPLEXED, *a.* Not perplexed; not harassed; not embarrassed.—2. Free from perplexity or complication; simple.  
 UNPERSECUTED, *a.* Free from persecution.  
 UNPERSPIRABLE, *a.* That cannot be

perspired or emitted through the pores of the skin.  
 UNPERSUADABLE, *a.* That cannot be persuaded or influenced by motives urged.  
 UNPERSUASIVE, *a.* Not persuasive.  
 UNPERTURBED, *a.* Not disturbed.  
 UNPERUSED, *a.* Not read.  
 UNPERVERTED, *a.* Not perverted; not wrested or turned to a wrong sense or use.  
 UNPETRIFIED, *a.* Not petrified; not converted into stone.  
 UNPHILANTHROPIC, *a.* Not philanthropic.  
 UNPHILOSOPHIC, } *a.* Not according to the rules or principles of sound philosophy; contrary to philosophy or right reason.  
 UNPHILOSOPHICAL, }  
 UNPHILOSOPHICALLY, *adv.* In a manner contrary to the principles of sound philosophy or right reason.  
 UNPHILOSOPHICALNESS, *n.* Incongruity with philosophy.  
 UNPHILOSOPHIZE, *v. t.* To degrade from the character of a philosopher.  
 UNPHILOSOPHIZED, *pp.* or *a.* Degraded from the rank of a philosopher.—2. Not sophisticated or perverted by philosophy; as, *unphilosophized* revelation.  
 UNPHRENOLOGICAL, *a.* Not pertaining to phrenology; not in accordance with phrenology.  
 UNPHYSICKED, *adv.* (as *z.*) Not influenced by medicine; not physicked.  
 UNPIERCEABLE, *a.* That cannot be pierced.  
 UNPIERCED, *a.* Not pierced; not penetrated.  
 UNPILLARED, *a.* Deprived of pillars; as, an *unpillared* temple.  
 UNPILLOWED, *a.* Having no pillow; having the head not supported.  
 UNPILOTED, *a.* Not steered by a pilot.  
 UNPIN, *v. t.* To loose from pins; to unfasten what is held together by pins; as, to *unpin* a frock.  
 UNPINIONED, *a.* Not having pinions.  
 UNPINKED, *a.* Not pinked; not marked or set with eyelet holes.  
 UNPINNED, *pp.* Loosed from pins.  
 UNPINNING, *pp.* Unfastening what is held together by pins.  
 UNPITIED, *a.* Not pitied; not compassionate; not regarded with sympathetic sorrow.  
 UNPITIFUL, *a.* Having no pity; not merciful.—2. Not exciting pity.  
 UNPITIFULLY, *adv.* Unmercifully; without mercy.  
 UNPITIABLY, *adv.* So as not to be pitied.  
 UNPITYING, *a.* Having no pity; showing no compassion.  
 UNPLACABLE, *a.* Not to be appeased. [*Implacable* is the word now used.]  
 UNPLACED, *a.* Having no office or employment under the government.  
 UNPLAGUED, *a.* Not plagued; not harassed; not tormented.  
 UNPLAINTED, *a.* Not plaited; not braided.  
 UNPLANTED, *a.* Not planted; of spontaneous growth.  
 UNPLASTERED, *a.* Not plastered.  
 UNPLAUSIBLE, *a.* (as *z.*) Not plausible; not having a fair appearance; as, arguments not *unplausible*.  
 UNPLAUSIBLY, *adv.* (as *z.*) Not with a fair appearance.  
 UNPLAUSIVE, *a.* Not approving; not applauding.  
 UNPLEADABLE, *a.* That cannot be pleaded.

UNPLEASANT, *a.* (unplez'ant.) Not pleasant; not affording pleasure; disagreeable.  
 UNPLEASANTLY, *adv.* (unplez'antly.) In a manner not pleasing; unceasingly.  
 UNPLEASANTNESS, *n.* (unplez'antness.) Disagreeableness; the state or quality of not giving pleasure.  
 UNPLEASED, *a.* (as *z.*) Not pleased; displeased.  
 UNPLEASEING, *a.* Offensive; disgusting.  
 UNPLEASEINGLY, *adv.* In a manner to displease.  
 UNPLEASEINGNESS, *n.* Want of qualities to please.  
 UNPLEASEIVE, *adv.* Not pleasing.  
 UNPLEDGED, *a.* Not pledged; not mortgaged.  
 UNPLIABLE, *a.* Not pliable; not easily bent.  
 UNPLIABLY, *adv.* In an unpliant manner.  
 UNPLIANT, *a.* Not pliant; not easily bent; stiff.—2. Not readily yielding the will; not compliant.  
 UNPLIGHTED, *a.* Not plighted.  
 UNPLOGGED, *a.* Not ploughed.  
 UNPLUME, *v. t.* To strip of plumes or feathers; to degrade.  
 UNPLUMED, *pp.* or *a.* Deprived of plumes; destitute of plumes.  
 UNPLUNDERED, *a.* Not plundered or stripped.  
 UNPOETIC, } *a.* Not poetical; not UNPOETICAL, } having the beauties of verse.—2. Not becoming a poet.  
 UNPOETICALLY, *adv.* In a manner not comporting with the nature of poetry.—2. In a manner unbecoming a poet.  
 UNPOETICALNESS, *n.* State of being unpoetical.  
 UNPOINTED, *a.* Having no point or sting.—2. Not having marks by which to distinguish sentences, members, and clauses in writing.—3. Not having the vowel points or marks; as, an *unpointed* manuscript in Hebrew or Arabic.  
 UNPOISED, *a.* (as *z.*) Not poised; not balanced.  
 UNPOISON, *v. t.* (as *z.*) To remove or expel poison.  
 UNPOLARIZED, *a.* Not polarized; not having polarity.  
 UNPOLICIED, *a.* Not having civil polity, or a regular form of government.  
 UNPOLISHED, *a.* Not polished; not made smooth or bright by attrition.—2. Not refined in manners; uncivilized; rude; plain.  
 UNPOLITE, *a.* Not refined in manners; not elegant.—2. Not civil; not courteous; rude. [See *IMPOLITE*.]  
 UNPOLITELY, *adv.* In an uncivil or rude manner.  
 UNPOLITENESS, *n.* Want of refinement in manners; rudeness.—2. Incivility; want of courtesy.  
 UNPOLITIC, *a.* Impolitic. [The latter is used.]  
 UNPOLLED, *a.* Not registered as a voter.—2. Unplundered; not stripped.  
 UNPOLLUTED, *a.* Not polluted; not defiled; not corrupted.  
 UNPOPULAR, *a.* Not popular; not having the public favour; as, an *unpopular* magistrate.—2. Not pleasing the people; as, an *unpopular* law.  
 UNPOPULARITY, *n.* The state of not enjoying the public favour, or of not pleasing the people.  
 UNPOPULARLY, *adv.* Not popularly.  
 UNPORTABLE, *a.* Not to be carried.  
 UNPORTIONED, *a.* Not endowed or



## UNPRESCRIBED

furnished with a portion or fortune; as, an *unportioned* daughter.  
**UNPORTUOUS**, *a.* Having no ports.  
**UNPOSSESSED**, *a.* Not possessed; not held; not occupied.  
**UNPOSSESSING**, *a.* Having no possessions.  
**UNPOSIBLE**, *† a.* Not possible. [The word now used is *impossible*.]  
**UNPO/TABLE**, *a.* Not drinkable.  
**UNPOWDERED**, *a.* Not sprinkled with powder.  
**UNPRACTICABLE**, *a.* Not feasible; that cannot be performed. [The word now used is *impracticable*.]  
**UNPRACTISED**, *a.* Not having been taught by practice; not skilled; not having experience; raw; unskilful.—2. *†* Not known; not familiar by use.  
**UNPRAISED**, *a.* (*s* as *z*.) Not praised; not celebrated.  
**UNPREACHING**, *a.* Not preaching; as, *unpreaching* prelates.  
**UNPRECA/RIOUS**, *a.* Not dependent on another; not uncertain.  
**UNPRECEDED**, *a.* Not preceded.  
**UNPRECEDENTED**, *a.* Having no precedent or example; not preceded by a like case; not having the authority of prior example.  
**UNPRECEDENTEDLY**, *adv.* Without precedent.  
**UNPRECEDENTIAL**, *a.* Not warranted by precedent; unprecedented. [*Rarely used*.]  
**UNPRECISE**, *a.* Not precise; not exact.  
**UNPREDESTINATED**, *a.* Not predestinated.  
**UNPREDESTINED**, *a.* Not previously determined or destined.  
**UNPREDICT**, *v. t.* To retract prediction.  
**UNPREFACED**, *a.* Not prefaced.  
**UNPREFERRED**, *a.* Not preferred; not advanced.  
**UNPREGNANT**, *a.* Not pregnant.—2. Not prolific; not quick of wit.  
**UNPREJUDICATE**, } *a.* Not pre-  
**UNPREJUDICATED**, } possessed by  
settled opinions. [*Little used*.]  
**UNPREJUDICED**, *a.* Not prejudiced; free from undue bias or prepossession; not preoccupied by opinion; impartial; as, an *unprejudiced* mind.—2. Not warped by prejudice; as, an *unprejudiced* judgment.  
**UNPREJUDICEDNESS**, *n.* State of being unprejudiced. [*Rarely used*.]  
**UNRELAT/ICAL**, *a.* Unsuitable to a prelate.  
**UNRELAT/ICALLY**, *adv.* Unlike or unsuitably to a prelate.  
**UNPREMEDITATE**, } *a.* Not pre-  
**UNPREMEDITATED**, } viously medi-  
tated or prepared in the mind.—2. Not previously purposed or intended; not done by design.  
**UNPREMEDITATEDLY**, *adv.* Without premeditation.  
**UNPREOCCUPIED**, *a.* Not preoccupied.  
**UNPREPARED**, *a.* Not prepared; not ready; not fitted or furnished by previous measures.—2. Not prepared, by holiness of life, for the event of death and a happy immortality.  
**UNPREPAREDNESS**, *n.* State of being unprepared.  
**UNPREPAREDLY**, *adv.* Without preparation.  
**UNPREPOSSESSED**, *a.* Not prepossessed; not biased by previous opinions; not partial.  
**UNPREPOSSESSING**, *a.* Not having a winning appearance.  
**UNPRESCRIBED**, *a.* Not prescribed.

## UNPROFITABLE

**UNPRESENTABLE**, *a.* Not presentable.  
**UNPRESERVABLE**, *a.* That cannot be preserved.  
**UNPRESSED**, *a.* Not pressed.—2. Not enforced.  
**UNPRESUMING**, *a.* Not too confident or bold.  
**UNPRESUMPTUOUS**, *a.* [See **PRESUME**.] Not presumptuous; not rash; modest; submissive.  
**UNPRESUMPTUOUSLY**, *adv.* Without presumption.  
**UNPRETENDING**, *a.* Not claiming distinction; modest.  
**UNPRETENDINGLY**, *adv.* Without pretension.  
**UNPREVAILING**, *a.* Being of no force; vain.  
**UNPREVALENT**, *a.* Not prevalent.  
**UNPREVARICATING**, *a.* Not prevaricating.  
**UNPREVENTABLE**, *a.* Not preventable.  
**UNPREVENTED**, *a.* Not prevented; not hindered.—2. *†* Not preceded by anything.  
**UNPRIEST**, *v. t.* To deprive of the orders of a priest.  
**UNPRIESTLY**, *a.* Unsuitable to a priest.  
**UNPRINCE**, *v. t.* (unprins'c) To deprive of principality or sovereignty.  
**UNPRINCELY**, *a.* (unprins'ly.) Unbecoming a prince; not resembling a prince.  
**UNPRINCIPLED**, *a.* Not having settled principles; as, souls *unprincipled* in virtue.—2. Having no good moral principles; destitute of virtue; not restrained by conscience; profligate.  
**UNPRINCIPLEDNESS**, *n.* Want of principle.  
**UNPRINTED**, *a.* Not printed; as a literary work.—2. Not stamped with figures; white; as, *unprinted* cotton.  
**UNPRISONED**, *a.* (*s* as *z*.) Set free from confinement.  
**UNPRIVILEGED**, *a.* Not privileged; not enjoying a particular immunity.  
**UNPKIZABLE**, *a.* Not valued; not of estimation.  
**UNPRIZED**, *a.* Not valued.  
**UNPROCLAIMED**, *a.* Not proclaimed; not notified by public declaration.  
**UNPROCURABLE**, *a.* Not to be procured.  
**UNPRODUCTIVE**, *a.* Not productive; barren.—2. *More generally*, not producing large crops; not making profitable returns for labour; as, *unproductive* land.—3. Not profitable; not producing profit or interest; as capital; as, *unproductive* funds or stock.—4. Not efficient; not producing any effect.  
**UNPRODUCTIVELY**, *adv.* Barrenly; without profit.  
**UNPRODUCTIVENESS**, *n.* The state of being unproductive; as, land, stock, capital, labour, &c.  
**UNPROFANED**, *a.* Not profaned; not violated.  
**UNPROFESSED**, *a.* Not professed.  
**UNPROFESSIONAL**, *a.* Not pertaining to one's profession.—2. Not belonging to a profession.  
**UNPROFESSIONALLY**, *adv.* In opposition to professional practice.  
**UNPROFICIENCY**, *n.* Want of proficiency or improvement.  
**UNPROFITABLE**, *a.* Bringing no profit; producing no gain beyond the labour, expenses, and interest of capital; as, *unprofitable* land; *unprofitable* stock; *unprofitable* employment.—2.

## UNPROSTITUTED

Producing no improvement or advantage; useless; serving no purpose; as, an *unprofitable* life; *unprofitable* study; Job xv.—3. Not useful to others.—4. Misimproving talents; bringing no glory to God; as, an *unprofitable* servant; Matth. xxv.  
**UNPROFITABLENESS**, *n.* The state of producing no profit or good; uselessness; intility.  
**UNPROFITABLY**, *adv.* Without profit; without clear gain; as, capital *unprofitably* employed.—2. Without any good effect or advantage; to no good purpose.  
**UNPROFITED**, *a.* Not having profit or gain.  
**UNPROGRESSIVE**, *a.* Not advancing.  
**UNPROHIBITED**, *a.* Not prohibited; not forbid; lawful.  
**UNPROJECTED**, *a.* Not planned; not projected.  
**UNPROLIF/IC**, *a.* Not prolific; barren; not producing young or fruit.—2. Not producing in abundance.  
**UNPROMINENT**, *a.* Not prominent.  
**UNPROMISED**, *a.* Not promised or engaged.  
**UNPROMISING**, *a.* Not promising; not affording a favourable prospect of success, of excellence, of profit, &c.; as, an *unpromising* youth; an *unpromising* season.  
**UNPROMPTED**, *a.* Not prompted; not dictated.—2. Not excited or instigated.  
**UNPROMULGATED**, *a.* Not promulgated.  
**UNPRONOUNCEABLE**, *a.* (unpronouns'able.) That cannot be pronounced.  
**UNPRONOUNCED**, *a.* Not pronounced; not uttered.  
**UNPROPE**, *v. t.* To remove a prop from; to deprive of support.  
**UNPROPER**, *† a.* Not fit or proper. [*Improper* is the word now used.]  
**UNPROPERLY**, *† adv.* Unfitly. [See **IMPROPERLY**.]  
**UNPROPHET/IC**, } *a.* Not foresee-  
**UNPROPHETICAL**, } ing or not pre-  
dicting future events.  
**UNPROPHET-LIKE**, *a.* Not like a prophet.  
**UNPROPI/TIATED**, *a.* Not propitiated.  
**UNPROPI/TIOUS**, *a.* Not propitious; not favourable; not disposed to promote; inauspicious.  
**UNPROPI/TIOUSLY**, *adv.* Unfavourably; unkindly.  
**UNPROPI/TIOUSNESS**, *n.* State or quality of being unpropitious.  
**UNPROPORTIONABLE**, *a.* Wanting due proportion; disproportionate.  
**UNPROPORTIONABLY**, *adv.* Not in due proportion; disproportionately.  
**UNPROPORTIONATE**, *a.* Wanting proportion; disproportionate; unfit.  
**UNPROPORTIONED**, *a.* Not proportioned; not suitable.  
**UNPROPOSED**, *a.* (*s* as *z*.) Not proposed; not offered.  
**UNPROPPED**, *a.* Not propped; not supported or upheld.  
**UNPROSELYTED**, *a.* Not made a convert.  
**UNPROSPEROUS**, *a.* Not prosperous; not attended with success; unfortunate.  
**UNPROSPEROUSLY**, *adv.* Unsuccessfully; unfortunately.  
**UNPROSPEROUSNESS**, *n.* Want of success; failure of the desired result.  
**UNPROSTITUTED**, *a.* Not prostituted; not debased.

UNPROTECTED, *a.* Not protected; not defended.—2. Not countenanced; not supported.  
 UNPROTECTEDLY, *adv.* Without being protected.  
 UNPROTECTING, *a.* Not protecting; not defending.  
 UNPROTESTANTIZE, *v. t.* To divest of protestantism.  
 UNPROTRACTED, *a.* Not protracted; not drawn out in length.  
 UNPROVED, *a.* Not proved; not known by trial.—2. Not established as true by argument, demonstration, or evidence.  
 UNPROVIDE, *v. t.* To unfurnish; to divest or strip of qualifications.  
 UNPROVIDED, *pp.* Divested of qualifications.—2. *a.* Not provided; unfurnished; unsupplied.  
 UNPROVIDENT, † *a.* Improvident.  
 UNPROVISIONED, *a.* (*s as z.*) Not furnished with provisions.  
 UNPROVOKE, † *v. t.* To repel provocation.  
 UNPROVOKED, *a.* Not provoked; not incited; *applied to persons.*—2. Not proceeding from provocation or just cause; as, an *unprovoked* attack.  
 UNPROVOKEDLY, *adv.* Without provocation.  
 UNPROVOKING, *a.* Giving no provocation or offence.  
 UNPROVOKINGLY, *adv.* Without giving provocation.  
 UNPRUDENTIAL, † *a.* Imprudent.  
 UNPRUNED, *a.* Not pruned; not lopped.  
 UNPUBLIC, *a.* Not public; private; not generally seen or known.  
 UNPUBLISHED, *a.* Not made public; secret; private.—2. Not published, as a manuscript or book.  
 UNPUNCTUAL, *a.* Not punctual; not exact in time.  
 UNPUNCTUALITY, } *n.* Want of  
 UNPUNCTUALNESS, } punctuality.  
 UNPUNCTUALLY, *adv.* Not punctually.  
 UNPUNCTUATED, *a.* Not punctuated; not pointed.  
 UNPUNISHABLE, *a.* That may not be punished.  
 UNPUNISHED, *a.* Not punished; suffered to pass without punishment or with impunity; as, a thief *unpunished*; as, an *unpunished* crime.  
 UNPUNISHING, *a.* Not punishing.  
 UNPURCHASABLE, *a.* That cannot be bought.  
 UNPURCHASED, *a.* Not purchased; not bought.  
 UNPURE, † *a.* Not pure; impure. [*See IMPURE.*]  
 UNPURGED, *a.* Not purged; unpurified.  
 UNPURIFIED, *a.* Not purified; not freed from recrement or foul matter.—2. Not cleansed from sin; unsanctified.  
 UNPURPOSED, *a.* Not intended; not designed.  
 UNPURSUED, *a.* Robbed of a purse.  
 UNPURSUED, *a.* Not pursued; not followed; not prosecuted.  
 UNPUTREFIED, *a.* Not putrefied; not corrupted.  
 UNQUAFFED, *a.* Not quaffed; not drank.  
 UNQUALING, *a.* Not failing; not sinking; firm.  
 UNQUALIFIED, *a.* Not qualified; not fit; not having the requisite talents, abilities, or accomplishments.—2. Not having taken the requisite oath or oaths.—3. Not modified or restricted

by conditions or exceptions; as, *unqualified* praise.  
 UNQUALIFIEDLY, *adv.* In a manner so as not to be qualified.  
 UNQUALIFIEDNESS, *n.* Condition of being unqualified.  
 UNQUALIFY, *v. t.* To divest of qualifications. [But instead of this, *disqualify* is now used.]  
 UNQUALIFYING, *ppr.* Divesting of qualifications.  
 UNQUALIFIED, † *a.* Deprived of the usual faculties.  
 UNQUARRELLABLE, † *a.* That cannot be impugned.  
 UNQUEEN, *v. t.* To divest of the dignity of queen.  
 UNQUELLABLE, *a.* That cannot be quelled.  
 UNQUELLED, *a.* Not quelled; not subdued.  
 UNQUENCHABLE, *a.* That cannot be quenched; that will never be extinguished; inextinguishable; Matt. iii.; Luke iii.  
 UNQUENCHABLENESS, *n.* The state or quality of being inextinguishable.  
 UNQUENCHABLY, *adv.* In a manner or degree so as not to be quenched.  
 UNQUENCHED, *a.* Not extinguished.  
 UNQUESTIONABILITY, or UNQUESTIONABLENESS, *n.* State of being unquestionable.  
 UNQUESTIONABLE, *a.* Not to be questioned; not to be doubted; indubitable; certain; as, *unquestionable* evidence or truth; *unquestionable* courage.  
 UNQUESTIONABLY, *adv.* Without doubt; indubitably.  
 UNQUESTIONED, *a.* Not called in question; not doubted.—2. Not interrogated; having no questions asked; not examined.—3. Indisputable; not to be opposed.  
 UNQUESTIONING, *a.* Not calling in question; not doubting; unhesitating.  
 UNQUICK, *a.* Not quick; slow.—2. † Not alive; motionless.  
 UNQUICKENED, Not animated; not matured to vitality; as, *unquicken*ed progeny.  
 UNQUIET, *a.* Not quiet; not calm or tranquil; restless; uneasy; as, an *unquiet* person; an *unquiet* mind.—2. Agitated; disturbed by continual motion; as, the *unquiet* ocean.—3. Unsatisfied; restless.  
 UNQUIET, † *v. t.* To disquiet.  
 UNQUIETLY, *adv.* In an unquiet state; without rest; in an agitated state.  
 UNQUIETNESS, *n.* Want of quiet; want of tranquillity; restlessness; uneasiness.—2. Want of peace; as of a nation.—3. Turbulence; disposition to make trouble or excite disturbance.  
 UNQUIETUDE, † *n.* Uneasiness; restlessness. [For this *disquietude* and *inquietude* are used.]  
 UNQUOTED, *a.* Not quoted; not cited.  
 UNRACKED, *a.* Not racked; not poured from the lees.  
 UNRAISED, *a.* Not elevated or raised.  
 UNRAKED, *a.* Not raked; as, land *unraked*.—2. Not raked together; not raked up; as fire.  
 UNRANSACKED, *a.* Not ransacked; not searched.—2. Not pillaged.  
 UNRANSOMED, *a.* Not ransomed; not liberated from captivity or bondage by payment for liberty.  
 UNRAPTURED, *a.* Not enraptured.  
 UNRASH, *a.* Not rash; not presumptuous.

UNRATABLE, *a.* Not liable to assessment.  
 UNRAVAGED, *a.* Not wasted or destroyed.  
 UNRAVEL, *v. t.* To disentangle; to disengage or separate threads that are knit.—2. To free; to clear from complication or difficulty.—3. To separate connected or united parts; to throw into disorder.  
 Nature all *unravel'd*. *Dryden.*  
 4. To unfold, as the plot or intrigue of a play.  
 UNRAVEL, *v. i.* To be unfolded; to be disentangled.  
 UNRAVELLABLE, *a.* That cannot be disentangled.  
 UNRAVELLED, *pp.* Unfolded; disentangled.  
 UNRAVELLER, *n.* One who unravels.  
 UNRAVELLING, *ppr.* Disentangling; unfolding; clearing from difficulty.  
 UNRAVELMENT, *n.* The development of the plot in a play.  
 UNRAZORED, *a.* Unshaven.  
 UNREACHED, *a.* Not reached; not attained to.  
 UNREAD, *a.* (unred'd.) Not read; not recited; not perused.—2. Untaught; not learned in books.  
 UNREADABLE, *a.* Not legible; that cannot be read.  
 UNREADILY, *adv.* (unred'dly.) Not promptly; not cheerfully.  
 UNREADINESS, *n.* (unred'diness.) Want of readiness; want of promptness or dexterity.—2. Want of preparation.  
 UNREADY, *a.* (unred'dy.) Not ready; not prepared; not fit.—2. Not prompt; not quick.—3. Awkward; ungainly.  
 UNREAL, *a.* Not real; not substantial; having appearance only.  
 UNREALITY, *n.* Want of reality or real existence.  
 UNREALIZED, *a.* Not realized.  
 UNREALIZING, *a.* Not realizing; not making real.  
 UNREAPED, *a.* Not reaped; as, *unreaped* wheat; an *unreaped* field.  
 UNREASON, *n.* Want of reason.—*Abbot of unreason, or abbot of misrule*, a mock abbot who played a chief part in the Feast of Fools. [*See Sir W. Scott's "Abbot."*]  
 UNREASONABLE, *a.* (*s as z.*) Not agreeable to reason.—2. Exceeding the bounds of reason; claiming or insisting on more than is fit; as, an *unreasonable* demand.—3. Immoderate; exorbitant; as, an *unreasonable* love of life or of money.—4. Irrational. [In this sense, *see IRRATIONAL.*]  
 UNREASONABLENESS, *n.* Inconsistency with reason; as, the *unreasonableness* of sinners.—2. Exorbitance; excess of demand, claim, passion, and the like; as, the *unreasonableness* of a proposal.  
 UNREASONABLY, *adv.* In a manner contrary to reason.—2. Excessively; immoderately; more than enough.  
 UNREASONED, *a.* Not reasoned.—2. Not derived from reasoning.  
 UNREASONING, *a.* Not reasoning; not having reasoning faculties.  
 UNREAVE, *v. t.* [*See REAVE, UNREEVE, and RAVEL.*] To unwind; to disentangle; to loose.—2. † Not to rive; not to tear asunder; not to unroof.  
 UNREBATED, *a.* Not blunted.  
 UNREBUKABLE, *a.* Not deserving rebuke; not obnoxious to censure; 1 Tim. vi.  
 UNREBUKABLY, *adv.* Not rebukably.  
 UNRECALLED, *a.* Not retracted.

UNRECEIVED, *a.* Not received; not taken; as, sacraments *unreceived*.—2. Not come into possession; as, a letter *unreceived*.—3. Not adopted; not embraced; as, opinions *unreceived*.

UNRECK'ONED, *a.* Not reckoned or enumerated.

UNRECLAIMABLE, *a.* That cannot be reclaimed, reformed, or domesticated. [We now use *Irreclaimable*.]

UNRECLAIMABLY, *adv.* So as not to be reclaimable.

UNRECLAIMED, *a.* Not reclaimed; not brought to a domestic state; not tamed; as, a wild beast *unreclaimed*.—2. Not reformed; not called back from vice to virtue.

UNRECLAIMING, *a.* Not reclaiming.

UNRECLINING, *a.* Not reclining or resting.

UNRECOGNIZABLE, *a.* That cannot be recognized. [See *RECOGNIZED*.]

UNRECOGNIZED, *a.* Not acknowledged or known.

UNRECOMMENDED, *a.* Not recommended.

UNRECOMPENSED, *a.* Not recompensed; not rewarded.

UNRECONCILABLE, *a.* That cannot be reconciled; that cannot be made consistent with; as, two *unreconcilable* propositions. [In this sense, *irreconcilable* is generally used.]-2. Not reconcilable; not capable of being appeased; implacable.—3. That cannot be persuaded to lay aside enmity or opposition, and to become friendly or favourable; as, *unreconcilable* neighbours. [*Irreconcilable* is generally used.]

UNRECONCILABLY, *adv.* So as not to be reconcilable.

UNRECONCILED, *a.* Not reconciled; not made consistent.—2. Not appeased; not having become favourable.—3. In a *theological sense*, not having laid aside opposition and enmity to God; not having made peace with God through faith in Christ.

UNRECORDED, *a.* Not recorded; not registered; as, an *unrecorded* deed or lease.—2. Not kept in remembrance by public monuments.

Not *unrecorded* in the rolls of fame. *Pope*.

UNRECOUNT'ED, *a.* Not recounted; not told; not related or recited.

UNRECOVERABLE, *a.* That cannot be recovered; past recovery.—2. That cannot be regained. [We now use *Irrecoverable*.]

UNRECOVERED, *a.* Not recovered; not recalled into possession; not regained.—2. Not restored to health.

UNRECRUITABLE, *a.* That cannot be recruited.—2. Incapable of recruiting. [*Bad and not used*.]

UNRECTIFIED, *a.* Not rectified; not corrected or set right.

UNRECUMBENT, *a.* Not reclining or reposing.

UNRECURING, † *a.* That cannot be cured.

UNRECURRING, *a.* Not recurring.

UNREDEEMABLE, *a.* That cannot be redeemed.

UNREDEEMED, *a.* Not redeemed; not ransomed.—2. Not paid; not recalled to the treasury or bank by payment of the value in money; as, *unredeemed* bills, notes, or stock.

UNREDRESSED, *a.* Not redressed; not relieved from injustice; *applied to persons*.—2. Not removed; not reformed; as, *unredressed* evils.

UNREDUCED, *a.* Not reduced; not lessened in size, quantity, or amount.

UNREDUCIBLE, *a.* Not capable of reduction; irreducible.

UNREDUCIBLENESS, *n.* The quality of not being capable of reduction.

UNREELED, *a.* Not reeled, or wound on a reel, from cocoons.

UNREEVE, *v. t.* (unreev') In *marine lan.*, to withdraw or take out a rope from a block, thimble, &c. [See *UNREAVE*.]

UNREFINED, *a.* Not refined; not purified; as, *unrefined* sugar.—2. Not refined or polished in manners.

UNREFLECTED, *a.* Not reflected.

UNREFLECT'ING, *a.* Not reflecting.

UNREFORMABLE, *a.* Not capable of being put into a new form.—2. That cannot be reformed or amended.

UNREFORMED, *a.* Not reformed; not reclaimed from vice; as, an *unreformed* youth.—2. Not amended; not corrected; as, *unreformed* manners; *unreformed* vices.—3. Not reduced to truth and regularity; not freed from error; as, an *unreformed* calendar.

UNREFRACTED, *a.* Not refracted, as rays of light.

UNREFRESH'ED, *a.* Not refreshed; not relieved from fatigue; not cheered.

UNREFRESH'FUL, *a.* Not adapted to refresh.

UNREFRESH'ING, *a.* Not refreshing; not invigorating; not cooling; not relieving from depression or toil.

UNREFUSING, *a.* Not rejecting; not declining to accept.

UNREFUTED, *a.* Not proved to be false.

UNREGAL, *a.* Not regal; unworthy of a king.

UNREGARDED, *a.* Not regarded; not heeded; not noticed; neglected; slighted.

UNREGARDFUL, *a.* Not giving attention; heedless; negligent.

UNREGARDFULLY, *adv.* Not regardfully.

UNREGENERACY, *n.* State of being unregenerate or unrenewed in heart.

UNREGENERATE, } *a.* Not re-  
UNREGENERATED, } generated;  
not renewed in heart; remaining at enmity with God.

UNREGENERATION, *n.* Want of regeneration.

UNREGISTERED, *a.* Not registered; not recorded.

UNREGRET'TED, *a.* Not lamented.

UNREGULATED, *a.* Not regulated; not reduced to order.

UNREHEARSED, *a.* (unrehears'ed.) *a.* Not recited or repeated; as words.

UNREINED, *a.* Not restrained by the bridle.

UNREJECT'ED, *a.* Not rejected.

UNREJOIC'ING, *a.* Unjoyous; gloomy; sad.

UNREJOIC'INGLY, *adv.* Unjoyously; gloomily.

UNRELATED, *a.* Not related by blood or affinity.—2. Having no connection with.

UNRELATIVE, *a.* Not relative; not relating; having no relation to. [*Irrelative* is more generally used.]

UNRELATIVELY, *adv.* Without relation to. [*Little used*.]

UNRELAX'ED, *a.* Not relaxed.

UNRELAX'ING, *a.* Not slackening; not abating in severity or attention.

UNRELAX'INGLY, *adv.* Without relaxation.

UNRELENT'ED, *a.* Not relented.

UNRELENT'ING, *a.* Not relenting; having no pity; hard; cruel; as, an *unrelenting* heart.—2. Not yielding to

pity; as, *unrelenting* cruelty.—3. Not yielding to circumstances; inflexibly rigid; as, an *unrelenting* rule.

UNRELENT'INGLY, *adv.* Without relenting.

UNRELIEVABLE, *a.* Admitting no relief or succour.

UNRELIEVED, *a.* Not relieved; not eased or delivered from pain.—2. Not succoured; not delivered from confinement or distress; as, a garrison *unrelieved*.—3. Not released from duty; as, an *unrelieved* sentinel.

UNRELIG'IOUS, *a.* Not religious; irreligious.

UNREMARKABLE, *a.* Not remarkable; not worthy of particular notice.—2. Not capable of being observed.

UNREMARKABLY, *adv.* Not remarkably.

UNREMARKED, *a.* Not remarked; unobserved.

UNREME'DIABLE, *a.* That cannot be cured; admitting no remedy. [We now use *Irremediable*.]

UNREME'DIABLY, *adv.* Without remedy; irremediably.

UNREME'DIED, *a.* Not cured; not remedied.

UNREMEMBERED, *a.* Not remembered; not retained in the mind; not recollected.

UNREMEMBERING, *a.* Having no memory or recollection.

UNREMEMBRANCE, † *n.* Forgetfulness; want of remembrance.

UNREMIT'TED, *a.* Not remitted; not forgiven; as, punishment *unremitted*.—2. Not having a temporary relaxation; as, pain *unremitted*.—3. Not relaxed; not abated.

UNREMIT'TING, *a.* Not abating; not relaxing for a time; incessant; continued; as, *unremitting* exertions.

UNREMIT'TINGLY, *adv.* Without abatement or cessation.

UNREMIT'TINGNESS, *n.* State of being unremitting.

UNREMOVABLE, *a.* That cannot be removed; fixed; irremovable.

UNREMOVABLENESS, *n.* The state or quality of being fixed and not capable of being removed.

UNREMOVABLY, *adv.* In a manner that admits of no removal.

UNREMOVED, *a.* Not removed; not taken away.—2. Not capable of being removed.

Like Atlas *unremov'd*. *Millon*.

UNREMU'NERATED, *a.* Not remunerated.

UNRENEW'ED, *a.* Not made anew; as, the lease is *unrenewed*.—2. Not regenerated; not born of the Spirit; as, a heart *unrenewed*.

UNRENOWN'ED, *a.* Not renowned or eminent.

UNREPAID, *a.* Not repaid; not compensated; not recompensed; as, a kindness *unrepaid*.

UNREPAIRED, *a.* Not repaired or mended.

UNREPEALABLE, *a.* That cannot be repealed.

UNREPEALED, *a.* Not repealed; not revoked or abrogated; remaining in force.

UNREPEATED, *a.* Not repeated.

UNREPEATING, *a.* Not repeating.

UNREPENT'ABLE, *a.* Not to be repented of.

UNREPENT'ANCE, *n.* State of being impenitent. [*Little used*.]

UNREPENT'ANT, } not penitent;  
UNREPENT'ING, } not contrite for sin.

UNREPENT'ED, *a.* Not repented of.  
 UNREPENT'INGLY, *adv.* Without repentance.  
 UNREPINING, *a.* Not repining; not peevishly murmuring or complaining.  
 UNREPININGLY, *adv.* Without peevish complaints.  
 UNREPLEN'ISHED, *a.* Not replenished; not filled; not adequately supplied.  
 UNREPORTED, *a.* Not reported; not yet published; as, *unreported* law cases.  
 UNREPOSED, *a.* (s as z.) Not reposed.  
 UNREPRESENT'ED, *a.* (s as z.) Not represented; having no one to act in one's stead.  
 UNREPRIEVABLE, *a.* That cannot be reprieved or respited from death.  
 UNREPRIEVED, *a.* Not reprieved; not respited.  
 UNREPROACHABLE, *a.* Not deserving reproach; irreproachable.  
 UNREPROACHABLENESS, *n.* State of being unproachable.  
 UNREPROACHABLY, *adv.* So as not to be reproachable; irreproachable.  
 UNREPROACHED, *a.* Not upbraided; not reproached.  
 UNREPROACH'FUL, *a.* Not reproachful.  
 UNREPROACHING, *a.* Not reproaching.  
 UNREPROVABLE, *a.* Not deserving reproof; that cannot be justly censured; Col. 1.  
 UNREPROVED, *a.* Not reprovved; not censured.—2. Not liable to reproof or blame.  
 UNREPUG'NANT, *a.* Not repugnant; not opposite.  
 UNREP'UTABLE, *a.* Not reputable. [For this, *disreputable* is generally used.]  
 UNREP'UTABLY, *adv.* Disreputably.  
 UNREQUEST'ED, *a.* Not requested; not asked.  
 UNREQUIRED, *a.* Not required; not demanded; not needed.  
 UNREQUITABLE, *a.* Not to be retaliated.  
 UNREQUITED, *a.* Not requited; not recompensed.  
 UNRES'CUED, *a.* Not rescued; not delivered.  
 UNRESENT'ED, *a.* (s as z.) Not resented; not regarded with anger.  
 UNRESERVE, *n.* (unrezerv'.) Absence of reserve; frankness; freedom of communication.  
 UNRESERV'ED, *a.* Not reserved; not retained when a part is granted.—2. Not limited; not withheld in part; full; entire; as, *unreserved* obedience to God's commands.—3. Open; frank; concealing or withholding nothing; free; as, an *unreserved* disclosure of facts.  
 UNRESERV'EDLY, *adv.* Without limitation or reservation.—2. With open disclosure; frankly; without concealment.  
 UNRESERV'EDNESS, *n.* Frankness; openness; freedom of communication; unlimitedness.  
 UNRESIGN'ED, *a.* Not given up; not surrendered.—2. Not submissive to God's will.  
 UNRESIST'ED, *a.* [See Resist.] Not resisted; not opposed.—2. Resistless; such as cannot be successfully opposed.  
 UNRESIST'IBLE, *a.* Irresistible.  
 UNRESIST'ING, *a.* Not making resistance; yielding to physical force or to persuasion.—2. Submissive; humble.  
 UNRESIST'INGLY, *adv.* Without resistance.

UNRESOLV'ABLE, *a.* (s as z.) That cannot be solved or resolved.  
 UNRESOLV'ED, *a.* (s as z.) Not resolved; not determined.—2. Not solved; not cleared.  
 UNRESOLV'EDNESS, *n.* (s as z.) State of being undetermined; irresolution. [Rarely used.]  
 UNRESOLV'ING, *a.* (s as z.) Not resolving; undetermined.  
 UNRESPECT'ABLE, *a.* Not respectable.  
 UNRESPECT'ED, *a.* Not respected; not regarded with respect.  
 UNRESPECT'IVE, *a.* Inattentive; taking little notice. [See IRRESPECTIVE.]  
 UNRESPIRABLE, *a.* That cannot be breathed.  
 UNRES'PITED, *a.* Not respited.—2. Admitting no pause or intermission.  
 UNRESPONS'IBLE, *a.* Not answerable; not liable.—2. Not able to answer; not having the property to respond. [Irresponsible is also used in the like sense.]  
 UNRESPONS'IBLNESS, *n.* Irresponsibility.  
 UNRESPONS'IVE, *a.* Not responsive.  
 UNREST', *n.* Unquietness; uneasiness. [Little used.]  
 UNREST'ING, *a.* Not resting; continually in motion.  
 UNREST'INGLY, *adv.* Without rest.  
 UNRESTORED, *a.* Not restored; not having recovered health.—2. Not restored to a former place, to favour, or to a former condition.  
 UNRESTRAINABLE, *a.* That cannot be restrained.  
 UNRESTRAINED, *a.* Not restrained; not controlled; not confined; not hindered.—2. Licentious; loose.—3. Not limited; as, an *unrestrained* power; *unrestrained* truth.  
 UNRESTRAINT, *n.* Freedom from restraint.  
 UNRESTRICT'ED, *a.* Not restricted; not limited or confined.  
 UNRETRACT'ED, *a.* Not retracted; not recalled.  
 UNRETRACT'ILE, *a.* That cannot be withdrawn.  
 UNRETURN'ED, *a.* Not returned.  
 UNREVEALED, *a.* Not revealed; not discovered; not disclosed.  
 UNREVEALEDNESS, *n.* State of being unrevealed.  
 UNREVENG'ED, *a.* Not revenged; as, an injury *unrevenged*.—2. Not vindicated by just punishment. Scipio's ghost walks *unrevenged*. Addition.  
 UNREVENGEFUL, *a.* (unrevenj'ful.) Not disposed to revenge.  
 UNREVENGE'FULLY, *adv.* Without revenge.  
 UNREVENUED, *a.* Not furnished with a revenue.  
 UNREVERED, *a.* Not revered.  
 UNREVERENCED, *a.* Not revered.  
 UNREVEREND, *a.* Not reverend.—2. Disrespectful; irreverent; as, an *unreverend* tongue.  
 UNREVERENT, *a.* Irreverent. [The latter is chiefly used.]  
 UNREVERENTLY, *adv.* Irreverently,—which see.  
 UNREVERS'ED, *a.* Not reversed; not annulled by a counter decision; as, a judgment or decree *unreversed*.  
 UNREVIEW'ED, *a.* Not reviewed.  
 UNREVISED, *a.* (s as z.) Not revised; not reviewed; not corrected.  
 UNREVIVED, *a.* Not revived; not recalled into life or force.

UNREVOKED, *a.* Not revoked; not recalled; not annulled.  
 UNREWARD'ED, *a.* Not rewarded; not compensated.  
 UNRHETOR'ICAL, *a.* Not rhetorical.  
 UNRHETOR'ICALLY, *adv.* Not in a rhetorical manner.  
 UNRHYM'ED, *a.* Not put into rhyme.  
 UNRID'DEN, *a.* Not ridden.  
 UNRID'DLE, *v. t.* To solve or explain; as, to *unriddle* an enigma or mystery.—2. To explain.  
 And where you can't *unriddle*, learn to trust. Parnell.  
 UNRID'DLED, *pp.* Explained; interpreted.  
 UNRID'DLER, *n.* One who explains an enigma.  
 UNRID'DLING, *ppr.* Solving; explaining.  
 UNRIDIC'ULOUS, *a.* Not ridiculous.  
 UNRI'FLED, *a.* Not rifled; not robbed; not stripped.  
 UNRIG', *v. t.* In *mar. lan.*, to *unrig* a ship, is to strip her of both standing and running rigging, &c.  
 UNRIG'GED, *pp.* Stripped of rigging.  
 UNRIG'GING, *ppr.* Stripping of rigging.  
 UNRIGHT, *a.* Not right; wrong.  
 UNRIGHT'EOUS, *a.* (unri'chus.) [Sax. *unrihtwis*; that is, not right-wise.]  
 1. Not righteous; not just; not conformed in heart and life to the divine law; evil; wicked; *used of persons*.—2. Unjust; contrary to law and equity; as, an *unrighteous* decree or sentence.  
 UNRIGHT'EOUSLY, *adv.* (unri'chusly.) Unjustly; wickedly; sinfully.  
 UNRIGHT'EOUSNESS, *n.* (unri'chusness.) Injustice; a violation of the divine law, or of the plain principles of justice and equity; wickedness. *Unrighteousness* may consist of a single unjust act, but more generally, when applied to persons, it denotes an habitual course of wickedness; Rem. i. vi.; 2 Cor. vi.  
 Every transgression of the law is *unrighteousness*. Hall.  
 UNRIGHT'FUL, *a.* Not rightful; not just.  
 UNRIGHT'FULLY, *adv.* Wrongfully.  
 UNRIGHT'FULNESS, *n.* State of being unrightful.  
 UNRING', *v. t.* To deprive of a ring or of rings.  
 UNRING'ING, *ppr.* Depriving of a ring or rings.  
 UNRIOT'ED, *a.* Free from rioting.  
 UNRIP', *v. t.* To rip; to cut open. [An unnecessary word.] [See Rip.]  
 UNRIPE, *a.* Not ripe; not mature; not brought to a state of perfection; as, *unripe* fruit.—2. Not seasonable; not yet proper.  
 He fix'd his *unripe* vengeance to defer. Dryden.  
 3. Not prepared; not completed; as, an *unripe* scheme.—4. Too early, as, the *unripe* death of Dorianus. [Unusual.]  
 UNRIPENED, Not ripened; not matured.  
 UNRIPENESS, *n.* Want of ripeness; immaturity; as, the *unripeness* of fruit or of a project.  
 UNRIS'EN, *a.* (s as z.) Not risen; not yet risen; as, the *unrisen* sun.  
 UNRI'VALLED, *a.* Having no rival; having no competitor.—2. Having no equal; peerless.  
 UNRIV'ET, *v. t.* To loose from rivets; to unfasten.  
 UNRIVETED, *pp.* Loosed from rivets; unfastened.

UNRIVETING, *ppr.* Unfastening; loosening from rivets.  
 UNROBE, *v. t.* To strip of a robe; to undress; to disrobe.  
 UNROBED, *pp.* Undressed; disrobed.  
 UNROBING, *ppr.* Divesting of robes; undressing.  
 UNROIL'ED, *a.* Not rendered turbid; not disturbed in mind.  
 UNROLL, } *v. t.* To open what is roll-  
 UNROLL', } ed or convolved; as, to  
 unroll cloth.—2. To display.  
 UNROLLED, *pp.* Opened, as a roll; displayed.  
 UNROLLING, *ppr.* Opening, as a roll; displaying.  
 UNROMANIZED, *a.* Not subjected to Roman arms or customs.  
 UNROMAN'TIC, *a.* Not romantic; not fanciful.  
 UNROMAN'TICALLY, *adv.* Not romantically.  
 UNROOF, *v. t.* To strip off the roof or covering of a house.  
 UNROOF'ED, *pp.* Stripped of the roof.  
 UNROOF'ING, *ppr.* Stripping of the roof.  
 UNROOST'ED, *a.* Driven from the roost.  
 UNRQOT', *v. t.* To tear up by the roots; to extirpate; to eradicate; as, to unroot an oak.  
 UNRQOT', *v. i.* To be torn up by the roots.  
 UNRQOT'ED, *pp.* Extirpated; torn up by the roots.  
 UNRQOT'ING, *ppr.* Tearing up by the roots; extirpating.  
 UNROUGH, *a.* (unruff'.) Not rough; unbearded; smooth.  
 UNROUND'ED, *a.* Not made round.  
 UNROUT'ED, *a.* Not routed; not thrown into disorder.  
 UNROY'AL, *a.* Not royal; unprincipally.  
 UNROY'ALLY, *a.* Not like a king; not becoming a king.  
 UNRUF'FLE, *v. i.* To cease from being ruffled or agitated; to subside to smoothness.  
 UNRUFFLED, *a.* Calm; tranquil; not agitated.  
 Calm and unruffled as a summer's sea.  
*Addison.*  
 2. Not disturbed; not agitated; as, an unruffled temper.  
 UNRULED, *a.* Not ruled; not governed; not directed by superior power or authority.  
 UNRU'LINESS, *n.* [from *unruly*.] Disregard of restraint; licentiousness; turbulence; as, the *unruliness* of men, or of their passions.—2. The disposition of a beast to break over fences and wander from an inclosure; the practice of breaking or leaping over fences.  
 UNRU'LY, *a.* Disregarding restraint; licentious; disposed to violate laws; turbulent; ungovernable; as, an *unruly* youth.  
 The tongue can no man tame; it is an *unruly* evil; James iv.  
 2. Accustomed to break over fences and escape from enclosures; apt to break or leap fences; as, an *unruly* ox.  
 The owner of the *unruly* ox paid a sum of money, as a civil penalty for the ransom of his life. S. E. Dwight.  
 UNRU'MINATED, *a.* Not well chewed; not well digested.  
 UNRUM'PLE, *v. t.* To free from rumples; to spread or lay even.  
 UNRUM'PLED, *pp.* Freed from rumples.  
 UNSAB'BATH-LIKE, *a.* Not according to usage on the sabbath.

UNSACK'ED, *a.* Not sacked; not pillaged.  
 UNSAD'DEN, *v. t.* (unsad'n.) To relieve from sadness.  
 UNSAD'DENED, *pp.* Relieved from sadness.  
 UNSAD'DENING, *ppr.* Relieving from sadness.  
 UNSAD'DLE, *v. t.* To strip of a saddle; to take the saddle from; as, to *unsaddle* a horse.  
 UNSAD'DLED, *pp.* Divested of the saddle.—2. *a.* Not saddled; not having a saddle on.  
 UNSAFE, *a.* Not safe; not free from danger; exposed to harm or destruction.—2. Hazardous; as, an *unsafe* adventure.  
 UNSAFELY, *adv.* Not safely; not without danger; in a state exposed to loss, harm, or destruction.  
 UNSAFENESS, *n.* State of being unsafe.  
 UNSAFETY, *n.* State of being unsafe; exposure to danger.  
 UNSAID, *a.* (unsd'.) Not said; not spoken; not uttered.  
 UNSAILABLE, *a.* Not sailable; not navigable.  
 UNSAINT, *v. t.* To deprive of saintship.  
 UNSAINT'ED, *pp.* Not sainted.  
 UNSAINTLY, *a.* Not like a saint.  
 UNSALEABLE, *a.* Not saleable; not in demand; not meeting a ready sale; as, *unsaleable* goods.  
 UNSALEABLENESS, *n.* Quality of being unsaleable.  
 UNSALT'ED, *a.* Not salted; not pickled; fresh; as, *unsalted* meat.  
 UNSALUTED, *a.* Not saluted; not greeted.  
 UNSALV'ABLE, *a.* Not salvable; that cannot be saved.  
 UNSANCTIFICATION, *n.* A state of being unsanctified.  
 UNSANCTIFIED, *a.* Not sanctified; unholy.—2. Not consecrated.  
 UNSANCTIONED, *a.* Not sanctioned; not ratified; not approved; not authorized.  
 UNSAN'DALED, *a.* Not wearing sandals.  
 UNSA'TED, *a.* Not sated; not satisfied or satiated.  
 UNSATIABILITY, } *n.* Quality of  
 UNSATIABLENESS, } being insatiable. [See UNSATIABILITY, UNSATIABLENESS, the words now used.]  
 UNSATIABLE, *a.* That cannot be satisfied. [But *insatiable* is generally used.]  
 UNSATIATE,† *a.* Not satisfied. [*Insatiate* is the word now used.]  
 UNSATIATED, *a.* Not satiated.  
 UNSATIATING, *a.* Not satiating.  
 UNSA'TING, *a.* Not sating or filling.  
 UNSATISFACTION, *n.* Dissatisfaction.  
 UNSATISFACTORILY, *adv.* So as not to give satisfaction.  
 UNSATISFACTORINESS, *n.* The quality or state of not being satisfactory; failure to give satisfaction.  
 UNSATISFACTORY, *a.* Not giving satisfaction; not convincing the mind.—2. Not giving content; as, an *unsatisfactory* compensation.  
 UNSATISFIABLE, *a.* That cannot be satisfied.  
 UNSAT'ISFIED, *a.* Not satisfied; not having enough; not filled; not gratified to the full; as, *unsatisfied* appetites or desires.—2. Not content; not pleased; as, to be *unsatisfied* with the choice of an officer; to be *unsatisfied* with the wages or compensation allowed.—3. Not settled in opinion; not

resting in confidence of the truth of any thing; as, to be *unsatisfied* as to the freedom of the will.—4. Not convinced or fully persuaded. The judges appeared to be *unsatisfied* with the evidence.—5. Not fully paid.

An execution returned *unsatisfied*.

Dagget, *Wheaton's Rep.*

UNSAT'ISFIEDNESS, *n.* The state of being not satisfied or content.  
 UNSAT'ISFYING, *a.* Not affording full gratification of appetite or desire; not giving content; not convincing the mind.  
 UNSAT'ISFYINGNESS, *n.* Incapability of gratifying to the full.  
 UNSAT'URATED, *a.* Not saturated; not supplied to the full.  
 UNSAVED, *a.* Not saved; not having eternal life.  
 UNSA'VOURILY, *adv.* So as to displease or disgust.  
 UNSA'VOURINESS, *n.* A bad taste or smell.  
 UNSA'VOURY, *a.* Tasteless; having no taste; Job vi.—2. Having a bad taste or smell.—3. Unpleasing; disgusting.  
 UNSAY, *v. t.* pret. and *pp.* *Unsaid*. To recant or recall what has been said; to retract; to deny something declared.  
 Say and *unsay*, feign, flatter, or abjure.  
*Milton.*

UNSCA'LY, *a.* Not scaly; having no scales.  
 UNSEAN'NED, *a.* Not measured; not computed.  
 UNSCA'RED, *a.* Not scared; not frightened away.  
 UNSCARRED, *a.* Not marked with scars or wounds.  
 UNSCATHED, *a.* Uninjured.  
 UNSCAT'TERED, *a.* Not scattered; not dispersed; not thrown into confusion.  
 UNSCEP'TERED, *a.* Having no sceptre or royal authority; not crowned as king.  
 UNSCHOL'ARLY, *a.* Not suitable to a scholar.  
 UNSCHOLAST'IC, *a.* Not bred to literature; as, *unscholastic* statesmen.—2. Not scholastic.  
 UNSCHOOL'ED, *a.* Not taught; not educated; illiterate.  
 UNSCIENTIF'IC, *a.* Not scientific; not according to the rules or principles of science.—2. Not versed in science.  
 UNSCIENTIF'ICALLY, *adv.* In a manner contrary to the rules or principles of science.  
 UNSCIN'TILLATING, *a.* Not sparkling; not emitting sparks.  
 UNSCONC'ED, *a.* Not sconced; not fined.  
 UNSCORCH'ED, *a.* Not scorched; not affected by fire.  
 UNSC'ORIFIED, *a.* Not scorified; not converted into dross.  
 UNSCOUR'ED, *a.* Not scoured; not cleaned by rubbing; as, *unscoured* armour.  
 UNSCRATCH'ED, *a.* Not scratched; not torn.  
 UNSCREENED, *a.* Not screened; not covered; not sheltered; not protected.  
 UNSCREW, *v. t.* To draw the screws from; to loose from screws; to unfasten.  
 UNSCREW'ED, *pp.* Loosed from screws.  
 UNSCREW'ING, *ppr.* Drawing the screws from.  
 UNSCRIPT'URAL, *a.* Not agreeable to the Scriptures; not warranted by

the authority of the word of God; as, an *unscriptural* doctrine.

**UNSCRIPTURALLY, adv.** In a manner not according with the Scriptures.

**UNSCRUPULOUS, a.** Not scrupulous; having no scruples.

**UNSCRUPULOUSLY, adv.** In an unscrupulous manner.

**UNSCRUPULOUSNESS, n.** Want of scrupulousness.

**UNSCRUTABLE. See INSCRUTABLE.**

**UNSCULPTURED, pp.** Not engraved.

**UNSCUTHEONED, a.** Not honoured with a coat of arms.

**UNSEAL, v. t.** To break or remove the seal of; to open what is sealed; as, to *unseal* a letter.

**UNSEALED, pp.** Opened; as something sealed.—2. *a.* Not sealed; having no seal, or the seal broken.

**UNSEALING, ppr.** Breaking the seal of; opening.

**UNSEAM, v. t.** To rip; to cut open.

**UNSEAMED, pp.** Ripped; cut open.

**UNSEARCHABLE, a.** (unserch'able.) That cannot be searched or explored; inscrutable; hidden; mysterious.

The counsels of God are to us *unsearchable*. Rogers.

**UNSEARCHABLENESS, n.** (unserch'ableness.) The quality or state of being unsearchable, or beyond the power of man to explore.

**UNSEARCHABLY, adv.** (unserch'ably.) In a manner so as not to be explored.

**UNSEARCHED, a.** (unserch'ed.) Not searched; not explored; not critically examined.

**UNSEARCHING, a.** Not searching; not penetrating.

**UNSEARED, a.** Not seared; not hardened.

**UNSEASON, v. t.** (unsee'zn.) To make unseasonary.—2. To make unseasonable.

**UNSEASONABLE, a.** (unsee'znable.) Not seasonable; not being in the proper season or time. He called at an *unseasonable* hour.—2. Not suited to the time or occasion; unfit; untimely; ill timed; as, *unseasonable* advice; as, *unseasonable* digression.—3. Late; being beyond the usual time. He came home at an *unseasonable* time of night.—4. Not agreeable to the time of the year; as, an *unseasonable* frost.

**UNSEASONABLENESS, n.** [supra.] The quality or state of being unseasonable, ill timed, or out of the usual time.

**UNSEASONABLY, adv.** Not seasonably; not in due time, or not in the usual time; not in the time best adapted to success.

**UNSEASONED, a.** (unsee'zud.) Not seasoned; not exhausted of the natural juices and hardened for use; as, *unseasoned* wood, boards, timber, &c.—2. Not inured; not accustomed; not fitted to endure any thing by use or habit; as, men *unseasoned* to tropical climates are exposed to fevers.—3. Unformed; not qualified by use or experience; as, an *unseasoned* courtier.—4. Not salted; not sprinkled, filled, or impregnated with any thing to give relish; as, *unseasoned* meat.—5. † Unseasonable.

**UNSEAT, v. t.** To throw from the seat.

**UNSEATED, pp.** Thrown from the seat.—2. *a.* Not seated; having no seat or bottom.

**UNSEATING, ppr.** Throwing from a seat.

**UNSEAWORTHINESS, n.** The state of being unable to sustain the ordinary violence of the sea in a tempest.

**UNSEAWORTHY, a.** Not fit for a voyage; not able to sustain the violence of the sea; as, the ship is *unseaworthy*.

**UNSECONDED, a.** Not seconded; not supported. The motion was *unseconded*; the attempt was *unseconded*. 2. † Not exemplified a second time.

**UNSECRET, a.** Not secret; not close; not trusty.

**UNSECRET, † v. t.** To disclose; to divulge.

**UNSECTARIAN, a.** Not sectarian; not intended or adapted to promote a sect.

**UNSECULAR, a.** Not worldly.

**UNSECULARIZE, v. t.** To detach from secular things; to alienate from the world.

**UNSECURE, a.** Not secure; not safe. [But *insecure* is generally used.]

**UNSECURED, a.** Not secured.

**UNSEDENTARY, a.** Not accustomed to sit much; not sedentary.

**UNSEDUCED, a.** Not seduced; not drawn or persuaded to deviate from the path of duty.

**UNSEEDED, a.** Not seeded; not sown. [Local.]

**UNSEEING, a.** Wanting the power of vision; not seeing.

**UNSEEM, † v. i.** Not to seem.

**UNSEMLINESS, n.** Uncomeliness; indecency; indecorum; impropriety.

**UNSEEMLY, a.** Not fit or becoming; uncomely; unbefitting; indecent.

My sons let your *unseemly* discord cease. Dryden

**UNSEEMLY, adv.** Indecently; unbecomingly.

**UNSEEN, a.** Not seen; not discovered.

—2. Invisible; not discoverable; as, the *unseen* God.—3. † Unskilled; inexperienced.

**UNSEIZED, a.** Not seized; not apprehended.—2. Not possessed; not taken into possession.

**UNSELDOM, adv.** Not seldom.

**UNSELECTED, a.** Not selected; not separated by choice.

**UNSELECTING, a.** Not selecting.

**UNSELFISH, a.** Not selfish; not unduly attached to one's own interest.

**UNSELFISHLY, adv.** Without selfishness.

**UNSEMINAR, † v. t.** To castrate; to make barren.

**UNSENS'ED, † a.** Wanting a distinct meaning; without a certain signification.

**UNSENS'IBLE, a.** Not sensible. [But *insensible* is now used.]

**UNSENSUALIZED, a.** Not sensualized.

**UNSENT, a.** Not sent; not dispatched; not transmitted.—*Unsent for*, not called or invited to attend.

**UNSENTIENT, a.** Not sentient.

**UNSENTINELLED, a.** Without a sentinel.

**UNSEPARABLE, a.** That cannot be parted. [But *inseparable* is now used.]

**UNSEPARATED, a.** Not separated or parted.

**UNSEPULED, a.** Having no grave; unburied.

**UNSEPTURED, a.** Unburied.

**UNSERVED, a.** Not served.

**UNSERVICEABLE, a.** Not serviceable; not bringing advantage, use, profit, or convenience; useless; as, an *unserviceable* utensil or garment; an *unserviceable* tract of land; *unserviceable* muskets.

**UNSERVICEABLENESS, n.** The quality or state of being useless; unfitness for use.

**UNSERVICEABLY, adv.** Without use; without advantage.

**UNSET, a.** Not set; not placed.—2. Not sunk below the horizon.

**UNSETTLE, v. t.** To unfix; to move or loosen from a fixed state; to unhinge; to make uncertain or fluctuating; as, to *unsettle* doctrines and opinions.—2. To move from a place.—3. To overthrow.

**UNSETTLE, v. i.** To become unfixed.

**UNSETTLED, pp.** Unfixed; unhinged; rendered fluctuating.—2. *a.* Not settled; not fixed; not determined; as doctrines, questions, opinions, and the like.—3. Not established.—4. Not regular; unequal; changeable; as, an *unsettled* season; *unsettled* weather.—5. Not having a legal settlement in a town or parish.—6. Having no fixed place of abode.—7. Not having deposited its fecal matter; turbid; as, *unsettled* liquor.—8. Having no inhabitants; not occupied by permanent inhabitants; as, *unsettled* lands in America.

**UNSETTLEDNESS, n.** The state of being unfixed, unsettled, or undetermined.—2. Irresolution; fluctuation of mind or opinions.—3. Uncertainty.—4. Want of fixedness; fluctuation.

**UNSETTLEMENT, n.** Unsettled state; irresolution.

**UNSETTLING, ppr.** Unfixing; removing from a settled state.

**UNSEVERE, a.** Not severe.

**UNSEVERED, a.** Not severed; not parted; not divided.

**UNSEX, v. t.** To deprive of the sex, or to make otherwise than the sex commonly is.

**UNSEX'ED, pp.** Made otherwise than the sex commonly is.

**UNSHACKLE, v. t.** To unfasten; to loose from bonds; to set free from restraint; as, to *unshackle* the hands; to *unshackle* the mind.

**UNSHACKLED, pp.** Loosed from shackles or restraint.

**UNSHACKLING, ppr.** Liberating from bonds or restraint.

**UNSHADED, a.** Not shaded; not overspread with shade or darkness.—2. Not clouded; not having shades in colouring.

**UNSHAD'OWED, a.** Not clouded; not darkened.

**UNSHADY, a.** Not shady.

**UNSHAKABLE, † a.** That cannot be shaken.

**UNSHAKED, for Unshaken,** not in use.

**UNSHAKEN, a.** Not shaken; not agitated; not moved; firm; fixed.—2. Not moved in resolution; firm; steady.—3. Not subject to concussion.

**UNSHAKINGLY, adv.** Without wavering.

**UNSHAMED, a.** Not shamed; not ashamed; not abashed.

**UNSHAMEFACED, a.** Wanting modesty; impudent.

**UNSHAPE, v. t.** To throw out of form or into disorder; to confound; to derange. [Little used.]

**UNSHAPED, } a.** Misshapen; deformed.

**UNSHAPEN, } ed;** ugly.

**UNSHAPELY, a.** Not shapely; not well formed.

**UNSHARED, a.** Not shared; not partaken or enjoyed in common; as, *unshared* bliss.

**UNSHAVED, a.** Not shaved.

**UNSHEATH, } v. t.** To draw from the

**UNSHEATHED, } sheath or scabbard.**

*Unsheath* thy sword. Shak.

To *unsheath* the sword, to make war.

UNSHATHED, *pp.* Drawn from the sheath.  
 UNSHEATHING, *ppr.* Drawing from the scabbard.  
 UNSHED', *a.* Not shed; not spilt; as, blood *unshed*.  
 UNSHELL', *v. t.* To divest of the shell; to shell.  
 UNSHELLED', *a.* Not shelled.  
 UNSHELTERED', *a.* Not sheltered; not screened; not defended from danger or annoyance.  
 UNSHELTERING, *a.* Not protecting; not defending from danger or annoyance.  
 UNSHELVE', *v. t.* To take from a shelf.  
 UNSHENT', *a.* Not spoiled; not disgraced.  
 UNSHIELD'ED, *a.* Not defended by a shield; not protected; exposed.  
 UNSHIP', *v. t.* To take out of a ship or other water craft; as, to *unship* goods.—2. In *seamen's lan.*, to remove from the place where it is fixed or fitted; as, to *unship* an oar; to *unship* capstan bars; to *unship* the tiller, &c.  
 UNSHIPMENT, *n.* Act of unshipping.  
 UNSHIPPED', *ppr.* Removed from a ship or from its place.—2. Destitute of a ship.  
 UNSHIRT'ED, *a.* Not covered with a shirt.  
 UNSHIVERED', *a.* Not shivered or split.  
 UNSHIVERING, *a.* Not shivering.  
 UNSHIVERINGLY, *adv.* Without shivering.  
 UNSHIVERINGNESS, *n.* State of being unshivering.  
 UNSHOCK'ED, *a.* Not shocked; not disgusted; not astonished.  
 UNSHOD', *a.* Not shod; having no shoes.  
 UNSHOOK', *a.* Not shaken; not agitated.  
 UNSHORN', *a.* Not shorn; not sheared; not clipped; as, *unshorn* locks.  
 UNSHOT', *a.* Not hit by shot.—2. Not shot; not discharged.  
 UNSHOUT', *v. t.* To retract a shout.  
 UNSHOWERED', *a.* Not watered or sprinkled by showers; as, *unshowered* grass.  
 UNSHRINED', *a.* Not deposited in a shrine.  
 UNSHRINK'ING, *a.* Not shrinking; not withdrawing from danger or toil; not recoiling; as, *unshrinking* firmness.  
 UNSHRINK'INGLY, *adv.* Without shrinking.  
 UNSHRIVEN', *a.* Not shriven.  
 UNSHROUD'ED, *a.* Not shrouded or covered.  
 UNSHROUD'ING, *a.* Not shrouding.  
 UNSHRUNK', *a.* Not shrunk; not contracted.  
 UNSHUN'NABLE, *† a.* That cannot be shunned; inevitable.  
 UNSHUN'NED, *a.* Not shunned; not avoided.  
 UNSHUT', *a.* Not shut; open; unclosed.  
 UNSIFT'ED, *a.* Not sifted; not separated by a sieve.—2. Not critically examined; untried.  
 UNSIGHT, *† a.* Not seeing.  
 UNSIGHT'ED, *† a.* Not seen; invisible.  
 UNSIGHTLINESS, *n.* Disagreeableness to the sight; deformity; ugliness.  
 UNSIGHT'PLY, *a.* Disagreeable to the eye; ugly; deformed.  
 UNSIGHT UNSEEN, A vulgar phrase, denoting *unseeing unseem, or unseen repeated*; as, to buy a thing *unseen* *unseen*, that is, without seeing it.

UNSIGNALIZED, *a.* Not signalized or distinguished.  
 UNSIGNED, *a.* Not signed.  
 UNSIGNIFICANT, *† a.* Having no meaning. [See *INSIGNIFICANT*.]  
 UNSILVERED', *a.* Not covered with quicksilver; as, an *unsilvered* mirror.  
 UNSINCERE, *a.* Not sincere; hypocritical. [See *INSINCERE*.]—2. Not genuine; adulterated.—3. Not sound; not solid. [Obsolete in the two last significations, and for the first, *insincere* is generally used.]  
 UNSINCER'ITY, *† n.* Insincerity; *INSINCERENESS, †* } cheat. [See *INSINCERITY*.]  
 UNSIN'EW, *v. t.* To deprive of strength.  
 UNSIN'EWED, *pp.* or *a.* Deprived of strength or force; weak; nerveless.  
 UNSIN'EWING, *ppr.* Depriving of strength; enfeebling.  
 UNSIN'FUL, *a.* Not sinful.  
 UNSIN'FULNESS, *n.* State of being sinful.  
 UNSING'ED, *a.* Not singed; not scorched.  
 UNSINGLED, *a.* Not singled; not separated.  
 UNSINK'ABLE, *a.* That cannot be sunk.  
 UNSINK'ING, *a.* Not sinking; not failing.  
 UNSIN'NING, *a.* Committing no sin; impeccable; untaunted with sin; as, *unsinning* obedience.  
 UNSIS'TERLY, *adv.* or *a.* Not like a sister.  
 UNSIZABLE, *a.* Not being of the proper size, magnitude, or bulk.  
 UNSIZED, *a.* Not sized or stiffened; as, *unsized* paper.  
 UNSKIL'ED, *a.* Wanting skill; destitute of readiness or dexterity in performance.—2. Destitute of practical knowledge.  
 UNSKIL'FUL, *a.* Not skilful; wanting the knowledge and dexterity which are acquired by observation, use, and experience; as, an *unskilful* surgeon; an *unskilful* mechanic; an *unskilful* logician.  
 UNSKIL'FULLY, *adv.* Without skill, knowledge, or dexterity; clumsily.  
 UNSKIL'FULNESS, *n.* Want of art or knowledge; want of that readiness in action or execution, which is acquired by use, experience, and observation.  
 UNSLACK'ENED, *a.* Not slackened.  
 UNSLAIN, *a.* Not slain; not killed.  
 UNSLACK'ED, *a.* Not saturated with water; as, *unslacked* lime.  
 UNSLAKED', *a.* Not slaked; unquenched; as, *unslaked* thirst.  
 UNSLAKED', *a.* Not saturated with water. [See *UNSLACKED*.]  
 UNSLEEPING, *a.* Not sleeping; ever wakeful.  
 UNSLEPT', *a.* Not slept.  
 UNSLING', *v. t.* In *seamen's lan.*, to take off the slings of a yard, a cask, &c.  
 UNSLIP'PING, *a.* Not slipping; not liable to slip.  
 UNSLOW, *† a.* Not slow.  
 UNSLUICE, *v. t.* To open the sluice of; to open.  
 UNSLUMBERING, *a.* Never sleeping or slumbering; always watching or vigilant.  
 UNSLUMBERINGLY, *adv.* Without slumbering.  
 UNSMIRCH'ED, *a.* Not stained; not soiled or blacked.  
 UNSMOKED, *a.* Not smoked; not dried in smoke.—2. Not used in smoking, as a pipe.  
 UNSMOOTH', *a.* Not smooth; not even; rough.

UNSMOOTH'ED, *a.* Not made smooth.  
 UNSOBER, *† a.* Not sober.  
 UNSOCIABLE, *a.* Not suitable to society; not having the qualities which are proper for society, and which render it agreeable; as, an *unsocial* temper.—2. Not apt to converse; not free in conversation; reserved.  
 UNSOCIABLENESS, } *n.* State of  
 UNSOCIABILITY, } being unsociable.  
 UNSOCIABLY, *adv.* Not kindly.—2. With reserve.  
 UNSOCIAL, *a.* Not adapted to society; not beneficial to society.  
 UNSOCKET, *v. t.* To loose or take from a socket.  
 UNSOFT, *† a.* Not soft; hard.  
 UNSOFT', *† adv.* Not with softness.  
 UNSOFT'ENED, *a.* Not softened.  
 UNSOILED', *a.* Not soiled; not stained; unpolluted.—2. Not disgraced; not tainted; as character.  
 UNSOLACED, *a.* Not comforted or consoled.  
 UNSOLD, *a.* Not sold; not transferred for a consideration.  
 UNSOLDER, *v. t.* To separate what is soldered.  
 UNSOLDIERED, *† a.* Not having the qualities of a soldier.  
 UNSOLDIER-LIKE, } *a.* [See *SOL-*  
 UNSOLDIERLY, } *DIER*.] Unbecoming a soldier.  
 UNSOLEMN, *a.* Not sacred, serious, or grave.  
 UNSOLEMNIZED, *a.* Not solemnized.  
 UNSOLICITED, *a.* Not solicited; not requested; unasked.—2. Not asked for; as, an *unsolicited* favour.  
 UNSOLICIT'EDLY, *adv.* Without being earnestly requested.  
 UNSOLICITOUS, *a.* Not solicitous; not anxious; not very desirous.  
 UNSOLID, *a.* Not solid; not firm; not substantial; as, *unsolid* arguments or reasoning; an *unsolid* foundation.—2. Fluid.  
 UNSOLUBLE, *† a.* Not soluble; insoluble.  
 UNSOLVABLE, *a.* That cannot be solved; insolvable; inexplicable.  
 UNSOLVED, *a.* Not solved; not explained.  
 UNSOUNDABLE, *† a.* That cannot be sounded.  
 UNSON'SY, *a.* Unpleasant; careless; unhandsome. [*Scotch, or local.*]  
 UNSOOT, *†* for *Unsweet*.  
 UNSOPHISTICAL, *a.* Not sophisticated; rustic; simple; ignorant.  
 UNSOPHISTICATE, *a.* Unsophisticated. [*Little used.*]  
 UNSOPHISTICATED, *a.* Not adulterated by mixture; not counterfeit; pure; as, *unsophisticated* drugs; *unsophisticated* arguments.  
 UNSORROWED, *a.* Not lamented; not bewailed.  
 UNSORTED, *a.* Not separated into sorts; not distributed according to kinds or classes; as, *unsorted* types; *unsorted* ideas.  
 UNSOUGHT, *a.* (unsaut'.) Not sought; not searched for.—2. Had without searching; as, *unsought* honour; *unsought* ideas.  
 UNSOUL, *v. t.* To deprive of mind or understanding.  
 UNSOULED, *a.* Without soul; having no good principle.  
 UNSOUND', *a.* Not sound; defective; as, *unsound* timber.—2. Infirm; sickly; as, *unsound* in health; an *unsound* constitution.—3. Not orthodox; defective; as, *unsound* in faith; *unsound*

doctrine.—4. Not sound in character; not honest; not faithful; not to be trusted; defective; deceitful.—5. Not true; not solid; not real; not substantial; as, *unsound* pleasures; *unsound* delights.—6. Not close; not compact; as, *unsound* cheese.—7. Not sincere; not faithful; as, *unsound* love.—8. Not solid; not material.—9. Erroneous; wrong; deceitful; sophistical; as, *unsound* arguments.—10. Not strong; as, *unsound* ice.—11. Not fast; not calm; as, *unsound* sleep.—12. Not well established; defective; questionable; as, *unsound* credit.

UNFOUND'ED, *a.* Not sounded; not tried with the lead.

UNFOUND'LY, *adv.* Not with soundness; as, he reasons *unsoundly*; he sleeps *unsoundly*.

UNFOUND'NESS, *n.* Defectiveness; as, the *unsoundness* of timber.—2. Defectiveness of faith; want of orthodoxy.—3. Corruption; want of solidity; as, the *unsoundness* of principles.—4. Defectiveness; as, the *unsoundness* of fruit.—5. Infirmity; weakness; as, of body; as, the *unsoundness* of the body or constitution.

UNFOUNDED, *a.* Not made sour.—2. Not made morose or crabbed.

UNFOWED } *a.* Not sown; not sowed;  
UNFOWN, } as, *unsown* or *unsowed*  
ground.—2. Not scattered on land for seed; as, seed *unsown*.—3. Not propagated by seed scattered; as, *unsown* flowers.

UNFOUNDED, *a.* Not spared.

UNFOUNDED, *a.* Not parsimonious; liberal; profuse.—2. Not merciful or forgiving.

UNFOUNDEDLY, *adv.* In abundance; lavishly.

UNFOUNDEDNESS, *n.* The quality of being liberal or profuse.

UNFOUNDED, *a.* Not emitting sparks; not glittering.

UNFOUNDED, *v. t.* To recant; to retract what has been spoken.

UNFOUNDED, *a.* That cannot be uttered; that cannot be expressed; unutterable; as, *unspeakable* grief or rage; 2 Cor. xii.

*Joy unspeakable* and full of glory; 1 Pet. i.

UNFOUNDEDLY, *adv.* In a manner or degree that cannot be expressed; inexpressibly; unutterably.

UNFOUNDED, *a.* Not specified; not particularly mentioned.

UNFOUNDED, *a.* Not specious; not plausible.

UNFOUNDEDLY, *adv.* Not speciously.

UNFOUNDED, *a.* Not speculative or theoretical.

UNFOUNDED, † *a.* Not performed; not dispatched.

UNFOUNDED, *a.* Not spent; not used or wasted; as, water in a cistern *unspent*.

—2. Not exhausted; as, strength or force *unspent*.—3. Not having lost its force or impulse; as, an *unspent* ball.

UNFOUNDED, *v. t.* To remove from its orb.

UNFOUNDED, *pp.* Removed from its orb.

UNFOUNDED, *a.* Not searched; not explored.—2. Not seen; not discovered.

UNFOUNDED, † *a.* Not split; not shed.—2. Not spoiled.

UNFOUNDED, *v. t.* To depress in spirits; to dispirit; to dishearten. [*Little used.*]

[The word used is *dispirit*.]

UNFOUNDED, *pp.* Dispirited.

UNFOUNDED, *a.* Not spiritual; carnal; worldly.

UNFOUNDED, *v. t.* To deprive of spirituality.

UNFOUNDED, *pp.* Deprived of spirituality.

UNFOUNDEDLY, *adv.* Worldly; carnally.

UNFOUNDED, *a.* Not spliced. [*See Splice.*]

UNFOUNDED, *a.* Not split; as, *unsplit* wood will not season.

UNFOUNDED, *a.* Not spoiled; not corrupted; not ruined; not rendered useless.—2. Not plundered; not pillaged.

UNFOUNDED, *a.* Not spoken or uttered.

UNFOUNDED, *a.* Not like a sportsman.

UNFOUNDED, *a.* Not stained; free from spot.—2. Free from moral stain; untainted with guilt; unblemished; immaculate; as, *unspotted* reputation.

UNFOUNDEDNESS, *n.* State of being free from stain or guilt.

UNFOUNDED, *a.* Not stretched or extended; not set and furnished with provisions.

UNFOUNDED, *a.* Not made square; as, *unquared* timber.—2. Not regular; not formed.

UNFOUNDED, *v. t.* To divest of the title or privilege of an esquire.

UNFOUNDED, *a.* [L. *instabilis*.] 1. Not stable; not fixed.—2. Not steady; inconstant; irresolute; wavering; James i.

UNFOUNDEDNESS, *n.* Instability.

UNFOUNDED, *a.* Not steady; mutable; not settled in judgment; volatile; fickle; as, *unstead* youth.

UNFOUNDEDNESS, *n.* Unfixed or volatile state or disposition; mutability; fickleness; indiscretion.—2. Uncertain motion; unsteadiness.

UNFOUNDED, *a.* Not stained; not dyed.—2. Not polluted; not tarnished; not dishonoured; as, an *unstained* character.

UNFOUNDED, *a.* Not stamped or impressed.

UNFOUNDED, *a.* Not stanch; not stopped; as blood.

UNFOUNDED, *a.* Not starched.

UNFOUNDED, *v. t.* To deprive of dignity.

UNFOUNDED, *a.* Not becoming a statesman.

UNFOUNDED, *a.* Not stationed.

UNFOUNDED, *a.* Contrary to statute; not warranted by statute.

UNFOUNDED. *See* UNFOUNDED.

UNFOUNDED, *a.* Not stayed; not stopped or retarded.

UNFOUNDED, *a.* (unsted'fast.) Not fixed; not standing or being firm.—2. Not firmly adhering to a purpose.

UNFOUNDED, *adv.* Not steadfastly.

UNFOUNDEDNESS, *n.* (unsted'fastness.) Want of steadfastness; instability; inconstancy.

UNFOUNDED, *a.* Not supported; not kept from shaking.

UNFOUNDED, *a.* (unsted'dily.) Without steadiness; in a wavering, vacillating manner.—2. Inconstantly; in a fickle manner.—3. Not in the same manner at different times; variously.

UNFOUNDEDNESS, *n.* (unsted'iness.) Unstability; inconstancy; want of firmness; irresolution; mutableness of opinion or purpose.—2. Frequent change of place; vacillation.

UNFOUNDED, *a.* (unsted'y.) Not steady; not constant; irresolute.—2. Mutable; variable; changeable; as, *unsteady* winds.—3. Not adhering constantly to any fixed plan or business.

UNFOUNDED, *a.* Not steeped; not soaked.

UNFOUNDED, *a.* Not marked with disgrace.

UNFOUNDED, *a.* Not still; unquiet.

UNFOUNDED, *a.* Not stimulated; not excited; as, *unstimulated* nature.

UNFOUNDED, *a.* Not exciting motion or action.

UNFOUNDED, *v. t.* To disarm of a sting. Elegant dissertations on virtue and vice will not *unstring* calamity. *J. M. Mason.*

UNFOUNDED, *pp.* Deprived of its sting.

UNFOUNDED, *a.* Not stinted; not limited.

UNFOUNDED, *a.* (unstur'ed.) Not stirred; not agitated.

UNFOUNDED, *a.* Not moving; not agitating.

UNFOUNDED, *v. t.* To open by picking out stitches.

UNFOUNDED, *a.* Not stitched.

UNFOUNDED, *pp.* Opening by picking out stitches.

UNFOUNDED, *a.* To deprive of stock.

UNFOUNDED, *a.* Not stocked.

UNFOUNDED, *a.* Not stooping; not bending; not yielding; as, *unstooping* firmness.

UNFOUNDED, *v. t.* To free from a stopple, as a bottle or cask.—2. To free from any obstruction; to open.

UNFOUNDED, *pp.* Opened.—2. *a.* Not meeting any resistance.

UNFOUNDED, *pp.* Taking out a stopper; opening; freeing from obstruction.

UNFOUNDED, *a.* Not stored; not laid up in store; not warehoused.—2. Not supplied with stores; as, a fort *unstorea* with provisions.

UNFOUNDED, *pp.* Not related in story.

UNFOUNDED, *a.* Not assaulted; not taken by assault.

UNFOUNDED, *a.* Not strained; as, *unstrained* oil.—2. Easy; not forced; natural; as, an *unstrained* derivation.

UNFOUNDED, *a.* Not straitened; not contracted.

UNFOUNDED, *a.* Not stratified.

In *geol.*, a term applied to those rocks which are not disposed in beds or strata, as granite, greenstone, porphyry, and lava. Such rocks are also termed *igneous* or *plutonic* rocks, as they are considered to have been formed in the interior of the earth's crust, by the agency of intense heat, and thrown upwards in masses more or less of a crystalline structure. Unstratified rocks sometimes lie over those that are stratified, and are also found beneath them. Thus granite forms the basis on which repose the lowest or oldest stratified rocks, yet this rock is often found protruding through the crust of the earth, and forming the most elevated parts of mountains. The unstratified rocks are interspersed among, or laid over, the stratified rocks, not in unconnected and independent masses, but connected with veins or seams, intersecting the stratified rocks, and having their origin from beneath the lowest strata.

UNFOUNDED, *a.* Not strengthened; not supported; not assisted.

UNFOUNDED, *v. t.* To relax tension; to loosen; as, to *unstring* the nerves.—2. To deprive of strings; as, to *unstring* a harp.—3. To loose; to untie.—4. To take from a string; as, to *unstring* beads.



UNSTRING'ED, *a.* Not stringed; not having strings.—2. Unstrung.  
 UNSTRING'ING, *pp.* Depriving of strings; loosing from a string.  
 UNSTRUCK, *a.* Not struck; not impressed; not affected; as, *unstruck* with horror.  
 UNSTRUNG', *pp.* Relaxed in tension; loosed; untied; taken from a string; as beads.  
 UNSTUD'IED, *a.* Not studied; not premeditated.—2. Not laboured; easy; natural; as, an *unstudied* style.  
 UNSTU'DIOUS, *a.* Not studious; not diligent in study.  
 UNSTUFF'ED, *a.* Not stuffed; not filled; not crowded.  
 UNSTUNG', *pp.* Not stung.  
 UNSUBDU'ED, Not subdued; not brought into subjection; not conquered; as, nations or passions *unsubdued*.  
 UNSUB'JECT, *a.* Not subject; not liable; not obnoxious.  
 UNSUBJECT'ED, *a.* Not subjected; not subdued.  
 UNSUB'JUGATED, *a.* Not subjugated.  
 UNSUBLIMED, *a.* Not sublimed.  
 UNSUBMIS'SIVE, *a.* Not submissive; disobedient.  
 UNSUBMIS'SIVELY, *adv.* Not submissively.  
 UNSUBMIT'TING, *a.* Not submitting; not obsequious; not readily yielding.  
 UNSUBOR'DINATED, *a.* Not subordinated or reduced to subjection.  
 UNSUBORN'ED, *a.* Not suborned; not procured by secret collusion.  
 UNSUBSCRIBED, *a.* Not subscribed.  
 UNSUBSCRIBING, *a.* Not subscribing.  
 UNSUB'SIDIZED, *a.* Not engaged in another's service by receiving subsidies.  
 UNSUBSTAN'TIAL, *a.* Not substantial; not solid.—2. Not real; not having substance.  
 UNSUBSTANTIALITY, } *n.* Want  
 UNSUBSTANTIALNESS, } of substantiality; want of substantialness.  
 UNSUBSTANTIALIZED, *a.* Not made substantial.  
 UNSUBSTAN'TIALLY, *adv.* Without solidity or substance.  
 UNSUBSTANTIATED, *a.* Not substantiated.  
 UNSUBVERT'ED, *a.* Not overthrown; not entirely destroyed.  
 UNSUCCEED'ED, *a.* Not succeeded; not followed.  
 UNSUCCESS'FUL, *a.* Not successful; not producing the desired event; not fortunate.  
 UNSUCCESS'FULLY, *adv.* Without success; without a favourable issue; unfortunately.  
 UNSUCCESS'FULNESS, *n.* Want of success or favourable issue.  
 UNSUCCESS'IVE, *a.* Not proceeding by a flux of parts or by regular succession.  
 UNSUCK'ED, *a.* Not having the breasts drawn.  
 UNSUFFERABLE, *a.* Not sufferable; not to be endured; intolerable. [But the word now used is *insufferable*.]  
 UNSUFFERABLY, *adv.* So as not to be endured. [For this, *insufferably* is chiefly used.]  
 UNSUFFERING, *a.* Not suffering; not tolerating.  
 UNSUFFI'CIENCE, *n.* Inability to answer the end proposed. [For this, *insufficiency* is used.]  
 UNSUFFI'CIENT, *a.* Not sufficient; inadequate. [For this, *insufficiency* is now used.]

UNSUCCESSFULNESS, *n.* Insufficiency.  
 UNSUGARED, *a.* (unshoo'ared.) Not sweetened with sugar.  
 UNSUITABILITY, *n.* The quality of being unsuitable; unfitness. [Rarely used.]  
 UNSUITABLE, *a.* Not suitable; unfit; not adapted; as, timber *unsuitable* for a bridge.—2. Unbecoming; improper; as, a dress *unsuitable* for a clergyman; *unsuitable* returns for favours.  
 UNSUITABLENESS, *n.* Unfitness; incongruity; impropriety.  
 UNSUITABLY, *adv.* In a manner unbecoming or improper.—2. Incongruously; as, a man and wife *unsuitably* matched.  
 UNSUITED, *a.* Not suited; not fitted; not adapted; not accommodated.  
 UNSUITING, *a.* Not fitting; not becoming.  
 UNSULLIED, *a.* Not sullied; not stained; not tarnished.—2. Not disgraced; free from imputation of evil.  
 UNSULLIEDLY, *adv.* Without being sullied.  
 UNSUNG', *a.* Not sung; not celebrated in verse; not recited in verse.  
 UNSUN'NED, *a.* Not having been exposed to the sun.  
 UNSUPER'FLUOUS, *a.* Not more than enough.  
 UNSUPPLANT'ED, *a.* Not supplanted; not overthrown by secret means or stratagem.  
 UNSUPPLYABLE, *a.* That cannot be supplied.  
 UNSUPPLIED, *a.* Not supplied; not furnished with things necessary.  
 UNSUPPORTABLE, *a.* That cannot be supported; intolerable. [But *insupportable* is generally used.]  
 UNSUPPORTABLENESS, *n.* Insupportableness. [The latter is chiefly used.]  
 UNSUPPORTABLY, *adv.* Insupportably. [The latter is generally used.]  
 UNSUPPORTED, *a.* Not supported; not upheld; not sustained.—2. Not contented; not assisted.  
 UNSUPPRESS'ED, *a.* Not suppressed; not subdued; not extinguished.  
 UNSUPPURATIVE, *a.* Not suppurating.  
 UNSURE, *a.* [See SURE.] Not fixed; not certain.  
 UNSURGICAL, *a.* Not in a surgical manner; not according to the principles and rules of surgery.  
 UNSURMISED, *a.* Not surmised.  
 UNSURMOUNTABLE, *a.* That cannot be surmounted or overcome; insuperable. [We now use *insurmountable*.]  
 UNSURMOUNT'ED, *a.* Not surmounted.  
 UNSURPASSABLE, *a.* That cannot be surpassed.  
 UNSURPASSED, *a.* Not surpassed; not exceeded.  
 UNSURRENDERED, *a.* Not surrendered; not yielded to others.  
 UNSURVEYED, *a.* Not surveyed.  
 UNSUSCEPTIBLE, *a.* Not susceptible; not capable of admitting or receiving; as, a heart *unsusceptible* of impressions; a substance *unsusceptible* of change or of permanent colours. [Insusceptible is generally used.]  
 UNSUSCEPTIBLENESS, } *n.* Want  
 UNSUSCEPTIBILITY, } of susceptibility.  
 UNSUSCEPTIBLY, *adv.* Without susceptibility.  
 UNSUSPECT, for *Unsuspected*, is not in use.

UNSUSPECT'ED, *a.* Not suspected; not considered as likely to have done an evil act, or to have a disposition to evil.  
 UNSUSPECT'EDLY, *adv.* In a manner to avoid suspicion.  
 UNSUSPECTING, *a.* Not imagining that any ill is designed; free from suspicion.  
 UNSUSPECTINGLY, *adv.* Without suspicion.  
 UNSUSPEND'ED, *a.* Not hung up; not delayed; not held undetermined.  
 UNSUSPIC'IOUS, *a.* Having no suspicion; not indulging the imagination of evil in others; as, an *unsuspicious* youth.—2. Not to be suspected; as, *unsuspicious* testimony.  
 UNSUSPIC'IOUSLY, *adv.* Without suspicion.  
 UNSUSTAINABLE, *a.* Not sustainable; that cannot be maintained or supported; as, *unsustainable* pain; a suit in law *unsustainable*.  
 UNSUSTAINED, *a.* Not sustained; not supported; not seconded.  
 UNSUSTAINING, *a.* Not sustaining.  
 UNSWATHE, *v. t.* To take a swathe from; to relieve from a bandage.  
 UNSWATH'ED, *pp.* Relieved from a bandage.  
 UNSWAYABLE, *a.* That cannot be swayed, governed, or influenced by another. [Little used.]  
 UNSWAYED, *a.* Not swayed; not welded; as a sceptre.—2. Not biased; not controlled or influenced.  
 UNSWAYEDNESS, *n.* Steadiness; state of being unguided by another.  
 UNSWEAR, *v. t.* To recant or recall an oath.  
 UNSWEAT, *v. t.* (unswet'.) To ease or cool after exercise or toil. [A bad word, and not used.]  
 UNSWEATING, *a.* (unswet'ing.) Not sweating.  
 UNSWEET, *a.* Not sweet. [Little used.]  
 UNSWERVING, *a.* Not deviating from any rule or standard.  
 UNSWERVINGLY, *adv.* Without swerving.  
 UNSWEPT, *a.* Not cleaned with a broom; not swept; not brushed.  
 UNSWORN, *a.* Not sworn; not bound by an oath; not having taken an oath; as, the witness is *unsworn*.  
 UNSWUNG', *a.* Not suspended.  
 UNSYMMET'RICAL, *a.* Wanting symmetry or due proportion of parts.—2. In bot., unsymmetrical flowers are such as have not the segments of the calyx and corolla, and the sepals and petals, and also the stamens regular and similar.  
 UNSYMMET'RICALLY, *adv.* Not symmetrically.  
 UNSYMPATHIZABILITY, *n.* Want of ability to sympathize. [Rarely used.]  
 UNSYMPATHIZING, *a.* Not sympathizing.  
 UNSYMPATHIZINGLY, *adv.* Without sympathy.  
 UNSYSTEMAT'IC, } *a.* Not system-  
 UNSYSTEMAT'ICAL, } atic; not  
 having regular order, distribution, or arrangement of parts.  
 UNSYSTEMAT'ICALLY, *adv.* Without system.  
 UNSYSTEMATIZED, *a.* Not systematized; not arranged in due order; not formed into system.  
 UNTACK, *v. t.* To separate what is tacked; to disjoin; to loosen what is fast.  
 UNTAINTED, *a.* Not rendered impure by admixture; not impregnated with

foul matter; as, *untainted* air.—2. Not sullied; not stained; unblemished; as, *untainted* virtue or reputation.—3. Not rendered unsavoury by putrescence; as, *untainted* meat.—4. Not charged with a crime; not accused; as, he lived *untainted*.

UNTAINTEDLY, *adv.* Without spot; without blemish; without imputation of crime.

UNTAINTEDNESS, *n.* State or quality of being untainted; purity.

UNTAKEN, *n.* (unta'kn.) Not taken; not seized; not apprehended; as, a thief *untaken*.—2. Not reduced; not subdued; as, *untaken* Troy.—3. Not swallowed.—*Untaken away*, not removed; 2 Cor. iii.—*Untaken up*, not occupied; not filled.

UNTAL'ENTED, *a.* Having no talent.

UNTALK'ED OF, *a.* Not talked of; not mentioned.

UNTAMABLE, *a.* That cannot be tamed or domesticated; that cannot be reclaimed from a wild state.—2. Not to be subdued or reduced to control.

UNTAMABLY, *adv.* Not tamably.

UNTAMED, *a.* Not reclaimed from wildness; not domesticated; not made familiar with man; as, an *untamed* beast.—2. Not subdued; not brought under control; as, a turbulent, *untamed* mind.—3. Not softened or rendered mild by culture; as, an *untamed* people.

UNTA'NGIBILITY, *n.* Intangibility.

UNTA'NGIBLE, *n.* Intangible.

UNTA'NGIBLY, *adv.* Intangibly.

UNTAN'GLE, *v. t.* To disentangle; to loose from tangles or intricacy; as, to *untangle* thread.

*Untangle* th's cruel chain. *Prior.*

UNTAN'GLED, *pp.* Disentangled.

UNTAN'GLING, *ppr.* Disentangling.

UNTARNISHED, *a.* Not soiled; not tarnished; not stained; unblemished; as, *untarnished* silk; *untarnished* reputation.

UNTA'SK'ED, *a.* Not tasked.

UNTA'STED, *a.* Not tasted; not tried by the taste or tongue.—2. Not enjoyed; as, *untasted* pleasures.

UNTA'STEFUL, *a.* Having no taste; being without taste.

UNTA'STEFULLY, *adv.* Without taste or gracefulness; in bad taste.

UNTA'STING, *a.* Not tasting; not perceiving by the taste.

UNTAUGHT, *a.* (untaut') Not taught; not instructed; not educated; unlettered; illiterate.—2. Unskilled; new; not having use or practice.

A tongue *untaught* to plead for favour.

UNTA'X'ED, *a.* Not taxed; not charged with taxes.—2. Not accused.

UNTEACH, *v. t.* pret. and pp. *Untaught.* To cause to forget or lose what has been taught.

Experience will *unteach* us. *Brown.*

UNTEACHABLE, *a.* That cannot be taught or instructed; indocile.

UNTEACHABLENESS, *n.* The quality of not readily receiving instruction; indocility.

UNTEEMING, *a.* Not producing young; barren.

UNTEM'PERATE, *a.* Intemperate. [*The latter is now used.*]

UNTEM'PERED, *a.* Not tempered; not duly mixed for use; not durable or strong.

UNTEM'PERING, *a.* Not tempering.—2. † Not exciting.

UNTEM'PESTED, *n.* Free from tempests.

UNTEMPT'ED, *a.* Not tempted; not

tried by enticements or persuasions; not invited by any thing alluring.

UNTEMPT'ING, *a.* Not tempting; not adapted to tempt, invite, or allure.

UNTEMPT'INGLY, *adv.* Not in a tempting manner.

UNTE'NABLE, *a.* Not tenable; that cannot be held in possession; as, an *untenable* post or fort.—2. That cannot be maintained or supported; not defensible; as, an *untenable* doctrine; *untenable* ground in argument.

UNTE'NANTABLE, *a.* Not fit for an occupant; not in suitable repair or condition for a tenant.

UNTE'NANTED, *a.* Not occupied by a tenant; not inhabited.

UNTE'ND'ED, *a.* Not tended; not having any attendant.

UNTE'NDER, *a.* Not tender; not soft.—2. Wanting sensibility or affection.

UNTE'NDERED, *a.* Not tendered; not offered; as, *untendered* money or tribute.

UNTE'NDERLY, *adv.* Without tenderness.

UNTE'NT', *v. t.* To bring out of a tent. [*Little used.*]

UNTE'NT'ED, *a.* Not having a medical tent applied.

UNTE'RNATING, *a.* Not limiting; not ending.

UNTE'R'IP'IED, *a.* Not terrified; not affrighted; not daunted.

UNTE'ST'ED, *a.* Not tested; not tried by a standard.

UNTHANK'ED, *a.* Not thanked; not repaid with acknowledgments.—2. Not thanked with thankfulness; as, an *unthanked* reprieve. [*Unusual.*]

UNTHANK'FUL, *a.* Not thankful; ungrateful; not making acknowledgments for good received.

For he is kind to the *unthankful* and to the evil; Luke vi.

UNTHANK'FULLY, *adv.* Without thanks; without a grateful acknowledgment of favours.

UNTHANK'FULNESS, *n.* Neglect or omission of acknowledgment for good received; want of a sense of kindness or benefits; ingratitude.

Immoderate favours breed first *unthankfulness*, and afterward hate. *Hayward.*

[See Tacitus's Ann. iv. 18.]

UNTHATCH'ED, *a.* Not thatched.—*pp.* Deprived of thatch.

UNTHAW'ED, *a.* Not thawed; not melted or dissolved; as ice or snow.

UNTHEAT'RICAL, *a.* Not theatrical.

UNTHEOLOG'ICAL, *a.* Not theological.

UNTHEORET'IC, } *a.* Not de-

UNTHEORET'ICAL, } pending on theory or speculation; not speculative.

UNTHINK', *v. t.* To dismiss a thought; to think otherwise than heretofore.

UNTHINK'ING, *a.* Not thinking; not heedful; thoughtless; inconsiderate; as, *unthinking* youth.—2. Not indicating thought or reflection; as, a round *unthinking* face.

UNTHINK'INGLY, *adv.* Without reflection; thoughtlessly.

UNTHINK'INGNESS, *n.* Want of thought or reflection; habitual thoughtlessness.

UNTHORN'Y, *a.* Not thorny; free from thorns.

UNTHOUGHT', *a.* or *pp.* (unthaut'). Not thought.

UNTHOUGHT'FUL, *a.* (unthaut'ful.) Thoughtless; heedless.

UNTHOUGHT' OF, not thought of; not regarded; not heeded.

UNTHREAD, *v. t.* (unthred'.) To draw or take out a thread from; as, to *unthread* a needle.—2. To loose.

UNTHREAD'ED, *pp.* Deprived of a thread.

UNTHREAD'ING, *ppr.* Depriving of a thread.

UNTHREATENED, *a.* (unthret'ened.) Not threatened; not menaced.

UNTHRIFT', *a.* Profuse; prodigal; unthrifty.

UNTHRIFT, *n.* A prodigal; one who wastes his estate by extravagance.

UNTHRIFT'ILY, *adv.* Without frugality.

UNTHRIFT'INESS, *n.* Waste of property without necessity or use; prodigality; profusion.

UNTHRIFT'Y, *a.* Prodigal; lavish; profuse; spending property without necessity or use.—2. Not thriving; not gaining property; as, an *unthrifty* farmer.—3. Not gaining flesh; as, an *unthrifty* ox.—4. Not vigorous in growth, as a plant.

UNTHRIVING, *a.* Not thriving; not prospering in temporal affairs; not gaining property.

UNTHRONE, *v. t.* To remove from a throne, or from supreme authority; to dethrone.

UNTHRONED, *pp.* Removed from a throne; deposed.

UNTHRO'NG'ED, *a.* Not crowded by a multitude.

UNTI'DILY, *adv.* In an untidy manner.

UNTI'DINESS, *n.* Want of tidiness or neatness.—2. Unseasonableness.

UNTI'DY, *a.* Not tidy; not reasonable; not ready.—2. Not neatly dressed; not in good order.

UNTIE, *v. t.* To loosen, as a knot; to disengage the parts that form a knot.

Untie the knot.—2. To unbind; to free from any fastening; as, to *untie* an iron chain.—3. To loosen from coils or convolution; as, snakes *untied*.—4. To loose; to separate something attached; as, to *untie* the tongue.—5. To resolve; to unfold; to clear.

UNTI'ED, *pp.* Loosed; as a knot; unbound; separated; resolved.—2. *a.* Not tied; not bound or gathered in a knot; loose.—3. Not fastened with a knot.—4. Not held by any tie or band.

UNTIL', *prep.* [un and till. See TILL.] To; used of time.

He and his sons were priests of the tribe of Dan, *until* the day of the captivity; Judges xviii.

2. † To; used of objects.—3. Preceding a sentence or clause, to; that is, to the event mentioned, or the time of it; as, *until* this hour; *until* this year.

The sceptre shall not depart from Judah ... *until* Shiloh come; Gen. xlix.

4. To the point or place of.

In open prospect nothing bounds our eye, *until* the earth seems join'd unto the sky. *Dryden.*

5. To the degree that.

Thou shalt push Syria, *until* they be consumed; 2 Chron. xviii.

Note.—*Until* is always the same part of speech in fact, and has the same signification. The only difference is, that it is followed sometimes by a single word denoting time, and in other cases by a verb denoting an event, or a word denoting place or degree. The sense is in all cases to; and till may be used as its substitute, and in modern usage it is most common.

UNTILE, *v. t.* To take the tiles from; to uncover by removing tiles.

UNTILED, *a.* Stripped of tiles; not tiled.  
 UNTILING, *ppr.* Stripping of tiles.  
 UNTILLED, *a.* Not tilled; not cultivated.  
 UNTIMBERED, *a.* Not furnished with timber.—2. Not covered with timber trees; as, *untimbered* land.  
 UNTIMELINESS, *n.* State of being untimely.  
 UNTIMELY, *a.* Happening before the usual time; as, *untimely* frost.—2. Happening before the natural time; premature; as, *untimely* death; *untimely* fate.  
 UNTIMELY, *adv.* Before the natural time.  
 What is *untimely* done. *Shak.*  
 UNTIMEOUS, *a.* Untimely. [*Rarely used.*]  
 UNTINCTURED, *a.* Not tintured; not tinged, stained, mixed, or infected.  
 UNTING'ED, *a.* Not tinged; not stained; not discoloured; as, water *untinged*; *untinged* beams of light.—2. Not infected.  
 UNTIABLE, *a.* That cannot be wearied; indefatigable; unwearied.  
 UNTIABLENESS, *n.* The state of being untirable.  
 UNTIRED, *a.* Not tired; not exhausted by labour.  
 UNTRING, *a.* Not becoming tired or exhausted; as, *untriring* patience.  
 UNTITH'ABLE, *a.* Not tithable.  
 UNTITH'ED, *a.* Not subjected to tithes.  
 UNTITLED, *a.* Having no title; as, an *untitled* tyrant.  
 UNTO, *prep.* [Compound of *un*, not, and *to*.] It is used instead of *to*, but it is not in our mother tongue, nor is it used in popular discourse or in modern writings. It is therefore to be rejected, as obsolete and not legitimate.  
 UNTOLD, *a.* Not told; not related; not revealed.—2. Not numbered; as, money *untold*.  
 UNTOMB, *v. t.* (untoom'.) To disinter.  
 UNTOMBED, *pp.* Disinterred; removed from a tomb.  
 UNTOOTH', *v. t.* To deprive of teeth.  
 UNTOOTH'SOME, *a.* Not pleasant to the taste.  
 UNTORMENT'ED, *a.* Not put in pain; not teased.  
 UNTOSS'ED, } *a.* Not tossed.  
 UNTOST', }  
 UNTOUCHABLE, *a.* (untuch'able.) Not to be touched.  
 UNTOUCHED, *a.* (untuch'ed.) Not touched; not reached; not hit.—2. Not moved; not affected; as, the heart *untouched*.—3. Not meddled with; as, books *untouched* for years.  
 UNTO'WARD, *a.* Froward; perverse; refractory; not easily guided or taught; Acts ii.—2. Awkward; ungraceful; as, *untoward* words.—3. Inconvenient; troublesome; vexatious; unmanageable; as, an *untoward* event; an *untoward* vow.  
 UNTO'WARDLY, *adv.* In a froward or perverse manner; perversely; ungainly.  
 UNTO'WARDLY, *a.* Awkward; perverse; froward.  
 UNTO'WARDNESS, *n.* Awkwardness; frowardness; perverseness.  
 UNTOWERED, *a.* Not defended by towers.  
 UNTRACEABLE, *a.* That cannot be traced or followed.  
 UNTRACED, *a.* Not traced; not followed.—2. Not marked by footsteps.—3. Not marked out.  
 UNTRACK'ED, *a.* Not tracked; not

marked by footsteps.—2. Not followed by the tracks.  
 UNTRACT'ABLE, *a.* [Lat. *intractabilis*.] 1. Not tractable; not yielding to discipline; stubborn; indocile; un-governable; as, an *untractable* son.—2. Rough; difficult.—3. Not yielding to the heat or to the hammer; as an ore. [*Intractable* is more generally used.]  
 UNTRACT'ABLENESS, } *n.* Refrac-  
 UNTRACTABILITY, } toriness;  
 UNTRACTABILITY, } stubbornness; unwillingness to be gov-  
 erned, controlled, or managed.  
 UNTRADED, *a.* Not traded.—2. † Un-  
 common.  
 UNTRADING, *a.* Not engaged in com-  
 merce; as, an *untrading* country or city.  
 UNTRAINED, *a.* Not trained; not dis-  
 ciplined; not skilful.—2. Not edu-  
 cated; not instructed.  
 My wit *untrained*. *Shak.*  
 UNTRAINED, *a.* Irregular; ungovernable; as, *un-  
 trained* hope.  
 UNTRAM'ELLED, *a.* Not tram-  
 melled; not shackled.  
 UNTRAMP'LED, *a.* Not trampled.  
 UNTRAN'QUILIZED, *a.* Not tran-  
 quillized.  
 UNTRANSCRIBED, *a.* Not trans-  
 cribed.  
 UNTRANSFER'ABLE, *a.* That can-  
 not be transferred or passed from one  
 to another; as, power or right *untrans-  
 ferable*.  
 UNTRANSFER'ED, *a.* Not trans-  
 ferred; not conveyed or assigned to  
 another; as, titles or rights *untrans-  
 ferred*.  
 UNTRANSFORM'ED, *a.* Not meta-  
 morphosed; not transmuted.  
 UNTRANSLATABLE, *a.* Not capable  
 of being translated.  
 UNTRANSLATABLENESS, *n.* Im-  
 possibility of being translated.  
 UNTRANSLATED, *a.* Not translated  
 or rendered into another language.  
 UNTRANS'MIGRATED, *a.* Not trans-  
 migrated.  
 UNTRANSMIT'TED, *a.* Not trans-  
 mitted.  
 UNTRANSMUTABLE, *a.* That cannot  
 be changed into a different substance.  
 UNTRANSPARENT, *a.* Not transpa-  
 rent; not diaphanous; opaque; not per-  
 meable by light.  
 UNTRANSPASS'ABLE, † *a.* Not  
 transpassable.  
 UNTRANSPIRED, *a.* Not having es-  
 caped from secrecy.  
 UNTRANSPLANT'ED, *a.* Not trans-  
 planted.  
 UNTRANSPORTABLE, *a.* That can-  
 not be transported.  
 UNTRANSPORTED, *a.* Not trans-  
 ported.  
 UNTRANSPPOSED, *a.* (untranspo'zed.)  
 Not transposed; having the natural  
 order.  
 UNTRAV'ELLED, *a.* Not travelled;  
 not trodden by passengers; as, an *un-  
 travelled* forest.—2. Having never seen  
 foreign countries; as, an *untravelled*  
 Englishman.  
 UNTRAV'ERSED, *a.* Not traversed;  
 not passed over.  
 UNTREAD, *v. t.* (untred'.) To tread  
 back; to go back in the same steps.  
 UNTREASURED, *a.* (untrezh'ured.)  
 Not treasured; not laid up; not re-  
 posited.  
 UNTREATABLE, † *a.* Not treatable;  
 not practicable.  
 UNTREMBLING, *a.* Not trembling  
 or shaking; firm; steady.  
 UNTREMBLINGLY, *adv.* Without  
 trembling; firmly.

UNTRENCH'ED, *a.* Not cut into long  
 hollows.  
 UNTRIED, *a.* Not tried; not attempt-  
 ed.—2. Not yet experienced; as, *un-  
 tried* sufferings.—3. Not having passed  
 trial; not heard and determined in  
 law. The cause remains *untried*.  
 UNTRIM'MED, *a.* Not trimmed; not  
 pruned; not dressed; not put in order.  
 UNTRIT'URATED, *a.* Not reduced to  
 powder by rubbing or grinding.  
 UNTRI'UMPHABLE, *a.* That admits  
 no triumph. [*Barbarous and not used.*]  
 UNTRI'UMPHED, *a.* Not triumphed  
 over.  
 UNTROD', } *a.* Not having been  
 UNTROD'DEN, } trod; not passed  
 over; not marked by the feet.  
 UNROLLED, *a.* Not bowled; not  
 rolled along.  
 UNROUBLED, *a.* (untrub'led.) Not  
 troubled; not disturbed by care, sor-  
 row, or business; free from trouble.—  
 2. Not agitated; not ruffled; not con-  
 fused; free from passion; as, an *un-  
 troubled* mind.—3. Not agitated; not  
 moved; as, an *untroubled* lake.—4. Not  
 disturbed or interrupted in the natural  
 course; as, *untroubled* nature.—5. Not  
 foul; not turbid; clear; as, an *unrou-  
 bled* stream.  
 UNROUBLEDNESS, † *n.* State of  
 being free from trouble; unconcern.  
 UNTRUE, *a.* Not true; false; contrary  
 to the fact. The story is *untrue*.—  
 2. Not faithful to another; not fulfill-  
 ing the duties of a husband, wife, vassal,  
 &c.; false; disloyal.—3. Inconstant; as  
 a lover.  
 UNTRU'LY, *adv.* Not truly; falsely;  
 not according to reality.  
 UNTRUSS', *v. t.* To untie or unfasten;  
 to loose from a truss; to let out.  
 UNTRUSS'ED, *a.* Not trussed; not  
 tied up.  
 UNTRUST'ED, *a.* Not trusted; not  
 confided in.  
 UNTRUST'INESS, *n.* Unfaithfulness in  
 the discharge of a trust.  
 UNTRUST'WORTHY, *a.* Not deserving  
 of confidence.  
 UNTRUST'Y, *a.* Not trusty; not  
 worthy of confidence; unfaithful.  
 UNTRUTH, *n.* Contrariety to truth;  
 falsehood.—2. Want of veracity.—3. †  
 Treachery; want of fidelity.—4. False  
 assertion.  
 No *untruth* can possibly avail the patron  
 and defender long. *Hooker.*  
 UNTRUTH'FUL, *a.* Wanting in vera-  
 city.  
 UNTRUTH'FULLY, *adv.* Not truth-  
 fully; falsely.  
 UNTUCK', *v. t.* To unfold or undo a  
 tuck.  
 UNTUCK'ERED, *a.* Having no tucker;  
 as, an *untuckered* neck.  
 UNTUNABLE, *a.* Not harmonious;  
 not musical.—2. Not capable of making  
 music.—3. Not capable of being tuned  
 or brought to the proper pitch.  
 UNTUN'ABLENESS, *n.* Not capable  
 of being tuned, or made harmonious.  
 UNTUN'ABLY, *adv.* Inharmoniously.  
 UNTUNE, *v. t.* To make incapable of  
 harmony.  
 Untune that string. *Shak.*  
 2. To disorder.  
 Untun'd and jarring senses. *Shak.*  
 UNTONED, *pp.* Made incapable of  
 producing harmony.  
 UNTUR'BANED, *a.* Not wearing a  
 turban.  
 UNTURN'ED, *a.* Not turned. He left  
 no stone *unturnd*.

UNTOURED, *a.* Uninstructed; untaught; as, *untutored* infancy.  
 UNTWINE, *v. t.* To untwist.—2. To open; to disentangle.—3. To separate, as that which winds or clasps.  
 UNTWINED, *pp.* Untwisted; disentangled.  
 UNTWIRL, *v. t.* To undo a twirl; to untwist.  
 UNTWIST, *v. t.* To separate and open, as threads twisted; or to turn back that which is twisted.—2. To open; to disentangle; as intricacy.  
 UNTWISTED, *pp.* Separated; opened.  
 UNTWISTING, *pp.* Separating; disentangling.  
 UNTY, *v.* See UNTIE.  
 UNUNIFORM, *a.* Not uniform; wanting uniformity. [*Little used.*]  
 UNUNITED, *a.* Not united.  
 UNUPBRAIDING, *a.* Not upbraiding.  
 UNUPHELD, *a.* Not upheld; not sustained.  
 UNUPLIFTED, *a.* Not raised up.  
 UNURGED, *a.* Not urged; not pressed with solicitation.  
 UNUSED, *a.* (*s* as *z*.) Not put to use; not employed.—2. That has never been used.—3. Not accustomed; as, hands *unused* to labour; hearts *unused* to deceit.  
 UNUSEFUL, *a.* Useless; serving no good purpose.  
 UNUSUAL, *a.* (*s* as *z*.) Not usual; not common; rare; as, an *unusual* season; a person of *unusual* graces or erudition.  
 UNUSUALLY, *adv.* (*s* as *z*.) Not commonly; not frequently; rarely. The summer of 1826 was *unusually* warm.  
 UNUSUALNESS, *n.* (*s* as *z*.) Uncommonness; infrequency; rareness of occurrence.  
 UNUTTERABLE, *a.* That cannot be uttered or expressed; ineffable; inexpressible; as, *unutterable* anguish; *unutterable* joy.  
 UNUTTERABLY, *adv.* In an unutterable manner.  
 UNVACATED, *a.* Not made vacant.  
 UNVAİL. See UNVEIL.  
 UNVALUABLE, *a.* Being above price; invaluable. [But *invaluable* is the word now used.]  
 UNVALUED, *a.* Not valued; not prized; neglected.—2. Inestimable; not to be valued.—3. Not estimated; not having the value set.  
 UNVANQUISHABLE, *a.* That cannot be conquered.  
 UNVANQUISHED, *a.* Not conquered; not overcome.  
 UNVANTAGED, *a.* Not benefited.  
 UNVARIABLE, *a.* Not variable; not changeable or alterable. [But *invariable* is the word now used.]  
 UNVARIED, *a.* Not varied; not altered; not diversified.  
 UNVARIEGATED, *a.* Not variegated; not diversified.  
 UNVARNISHED, *a.* Not overlaid with varnish.—2. Not artificially coloured or adorned; not artfully embellished; plain.  
 I will a round *unvarnish'd* tale deliver.  
*Shak.*

UNVARYING, *a.* Not altering; not liable to change; uniform.  
 UNVEIL, *v. t.* To remove a veil from; to uncover; to disclose to view. She *unveiled* her face.  
 UNVEILED, *a.* Stripped of a veil; disclosed.  
 UNVEILEDLY, *adv.* Plainly; without disguise. [*Little used.*]

UNVEILER, *n.* One who unveils.  
 UNVEILING, *a.* Removing a veil from; uncovering; disclosing.  
 UNVENDIBLE, *a.* Not vendible.  
 UNVENERABLE, *a.* Not venerable; not worthy of veneration.  
 UNVENOMOUS, *a.* Free from venom.  
 UNVENTILATED, *a.* Not fanned by the wind; not purified by a free current of air.  
 UNVERDANT, *a.* Not verdant; not green; having no verdure.  
 UNVERIFIED, *a.* Not verified.  
 UNVERTABLE, *† a.* Not true.  
 UNVERSED, *a.* Not skilled; not versed; unacquainted; as, *unversed* in spinning.  
 UNVERSIIFIED, *a.* Not versified.  
 UNVEXED, *a.* Not vexed; not troubled; not disturbed or irritated.  
 UNVIGILANT, *a.* Not vigilant.  
 UNVINICATED, *a.* Not defended.  
 UNVINDICTIVE, *a.* Not vindictive.  
 UNVIOLATED, *a.* Not violated; not injured; as, *unviolated* honour.—2. Not broken; not transgressed; as, laws *unviolated*.  
 UNVIRTUOUS, *a.* Not virtuous; destitute of virtue.  
 UNVIRTUOUSLY, *adv.* Not virtuously.  
 UNVISITED, *a.* (*s* as *z*.) Not visited; not resorted to; not frequented.  
 UNVISORED, *a.* Not visored; unmasked.  
 UNVITAL, *a.* Not vital; not affecting life.  
 UNVITIATED, *a.* Not vitiated; not corrupted.  
 UNVITRIFIED, *a.* Not vitrified; not converted into glass.  
 UNVIZARD, *v. t.* (*s* as *z*.) To unmask.  
 UNVOCAL, *a.* Not vocal.  
 UNVOLATILIZED, *a.* Not volatilized.  
 UNVOTE, *v. t.* To contravene by vote a former vote; to annul a former vote.  
 UNVOUCHED, *a.* Not fully attested.  
 UNVOWED, *a.* Not consecrated by solemn promise.  
 UNVOWELLED, *a.* Having no vowels.  
 UNVOYAGEABLE, *† a.* Not to be navigated or passed over on a fluid.  
 UNVULGAR, *a.* Not common.  
 UNVULNERABLE, *a.* Not vulnerable; that cannot be wounded. [*In-vulnerable* is mostly used.]  
 UNWAFTEED, *a.* Not wafted.  
 UNWAITED ON, *a.* Not attended.  
 UNWAKENED, *† a.* Not awakened;  
 UNWAKED, } not roused from sleep or stupidity.  
 UNWALLED, *a.* Not surrounded, fortified, or supported by a wall.  
 UNWANTED, *a.* Not wanted.  
 UNWARES, *adv.* Unexpectedly. [For this, *unwares* is used.]  
 UNWARILY, *adv.* Without vigilance and caution; heedlessly.  
 UNWARINESS, *n.* Want of vigilance; want of caution; carelessness; heedlessness.  
 UNWARLIKE, *a.* [*See WAR.*] Not fit for war; not used to war; not military.  
 UNWARMED, *a.* [*See WARM.*] Not warmed.—2. Not excited; not animated.  
 UNWARNED, *a.* [*See WARN.*] Not cautioned; not previously admonished of danger.  
 UNWARP, *v. t.* [*See WARP.*] To reduce back what is warped.  
 UNWARPED, *a.* Not warped; not biased; not turned from the true direction; impartial.

UNWARPING, *a.* Not bending; unyielding; not deviating.  
 UNWARRANTABLE, *a.* Not defensible; not vindicable; not justifiable; illegal; unjust; improper.  
 UNWARRANTABLENESS, *n.* State of being unwarrantable.  
 UNWARRANTABLY, *adv.* In a manner that cannot be justified.  
 UNWARRANTED, *a.* Not warranted; not authorized.—2. Not ascertained; not assured or certain.—3. Not covenanted to be good, sound, or of a certain quality; as, an *unwarranted* horse.  
 UNWARY, *a.* Not vigilant against danger; not cautious; unguarded; precipitate.—2. *†* Unexpected.  
 UNWASHED, *a.* Not washed; not UNWASHEN, } cleansed by water; Matt. xv.  
 UNWASHED, *n.* The *unwashed* is a term applied to the common people; the dregs of society. [*Trivial, and used in scorn.*]  
 UNWASTED, *a.* Not lost by extravagance or negligence; not lavished away; not dissipated.—2. Not consumed by time or violence.—3. Not lost by exhaustion, evaporation, or other means.  
 UNWASTING, *a.* Not growing less; not decaying.  
 UNWASTINGLY, *adv.* Without waste.  
 UNWATCHED, *a.* Not guarded with vigilance.  
 UNWATCHFUL, *a.* Not vigilant.  
 UNWATCHFULNESS, *n.* Want of vigilance.  
 UNWATERED, *a.* [*See WATER.*] Not watered; dry.  
 UNWAVERING, *a.* Not wavering or unstable; firm; not fluctuating.  
 UNWAVERINGLY, *adv.* With firm constancy.  
 UNWAXED, *a.* Not waxed.  
 UNWAYED, *a.* Not used to travel. [*Bad and not used.*]  
 UNWEAKENED, *a.* Not weakened; not enfeebled.  
 UNWEALTHY, *a.* (unwalth'y.) Not wealthy.  
 UNWEANED, *a.* Not weaned.  
 UNWEAPONED, *a.* (unwep'nd.) Not furnished with weapons or offensive arms.  
 UNWEARABLE, *a.* That cannot be worn.  
 UNWEARABLE, *a.* That cannot be wearied; indefatigable. [*Little used.*]  
 UNWEARIABLY, *a.* Indefatigably.  
 UNWEARIED, *a.* Not tired; not fatigued.—2. Indefatigable; continual; that does not tire or sink under fatigue; as, *unwearied* perseverance.  
 UNWEARIEDLY, *adv.* Without tiring or sinking under fatigue.  
 UNWEARIEDNESS, *n.* State of being unwearied.  
 UNWEARY, *a.* Not weary; not tired.  
 UNWEARY, *v. t.* To refresh after fatigue.  
 UNWEARYING, *a.* Not making weary.  
 UNWEAVE, *v. t.* To unfold; to undo what has been woven.  
 UNWEAVING, *pp.* Undoing what has been woven.  
 UNWED, *a.* Unmarried.  
 UNWEDDED, *a.* Unmarried; remaining single.  
 UNWEDGEABLE, *† a.* (unwedj'able.) Not to be split with wedges.  
 UNWEEDED, *a.* Not weeded; not cleared of weeds.  
 UNWEEPED. See UNWEEP.  
 UNWEETING, *† a.* [*See WEET and WET.*] Ignorant; unknowing.

UNWEETINGLY, † *adv.* Ignorantly.  
UNWEIGHED, *a.* Not weighed; not having the weight ascertained.

Solomon left all the vessels *unweighed*; 1 Kings vii.  
2. Not deliberately considered and examined; as, to leave arguments or testimony *unweighed*.—3. Not considerate; negligent; as, words *unweighed*.

UNWEIGHING, *a.* Inconsiderate; thoughtless.

UNWEL'COME, *a.* Not welcome; not grateful; not pleasing; not well received; as, *unwelcome* news; an *unwelcome* guest.

UNWEL'COMED, *a.* Not welcomed; not cordially received.

UNWELCOMELY, *adv.* Not in a welcome manner.

UNWEL'COMENESS, *n.* State of being unwelcome.

UNWELDED, *a.* Not welded.

UNWELL', *a.* Not well; indisposed; not in good health. [It expresses less than *sick*.]

UNWELL'NESS, † *n.* State of being indisposed.

UNWELTED, *a.* Not weltered.

UNWEPT', *a.* Not lamented; not mourned. The profligate lives despoised, and dies *unwept*.

UNWET', *a.* Not wet or moist.

UNWHIP'PED, } *a.* Not whipped; not  
UNWHIPT', } corrected with the rod.

UNWHIS'PERED, *a.* Not whispered.

UNWHOLE, † *a.* [See WHOLE.] Not sound; infirm.

UNWHOLE'SOME, *a.* Not wholesome; unfavourable to health; insalubrious; as, *unwholesome* air or food.—2. Pernicious; as, *unwholesome* advice.

UNWHOLE'SOMENESS, *n.* Insalubrity; state or quality of being injurious or noxious to health; as, the *unwholesomeness* of a climate.

UNWIELDILY, *adv.* Heavily; with difficulty.

UNWIELDINESS, *n.* Heaviness; difficulty of being moved; as, the *unwieldiness* of a corpulent body.

UNWIELDY, *a.* That is moved with difficulty; unmanageable; bulky; ponderous; as, an *unwieldy* bulk; an *unwieldy* rock.

UNWILL'ED, *a.* Not willed; not produced by the will.

UNWILL'ING, *a.* Not willing; loth; disinclined; reluctant; as, an *unwilling* servant.

UNWILL'INGLY, *adv.* Not with good will; not cheerfully; reluctantly.

UNWILL'INGNESS, *n.* Lothness; disinclination; reluctance.

UNWILT'ED, *a.* Not wilted; fresh.

UNWILY, *a.* Not wily; free from cunning.

UNWIND, *v. t.* pret. and pp. *Unwound*. To wind off; to loose or separate what is wound or convolved; as, to *unwind* thread or a ball.—2. To disentangle.

UNWIND, *v. i.* To admit evolution; to become unwound.

UNWINDING, *a.* Not winding.—2. *ppr.* Winding off.

UNWING'ED, *a.* Not provided with wings.

UNWINK'ING, *a.* Not winking.

UNWIPE'D, *a.* Not cleaned by rubbing.

UNWISE, *a.* (*s* as *z*.) Not wise; not choosing the best means for the end; defective in wisdom; as, an *unwise* man; *unwise* kings.—2. Not dictated by wisdom; not adapted to the end; as, *unwise* measures.

UNWISELY, *adv.* Not wisely; not prudently; as, *unwisely* rigid; *unwisely* studious.

UNWISH', † *v. t.* To wish that which is not to be.

UNWISHED, *a.* Not wished; not sought; not desired.

UNWIST', † *a.* Not known.

UNWIT', † *v. t.* To deprive of understanding.

UNWITCH, † *v. t.* To free from the effects of witchcraft; to disenchant.

UNWITHDRAW'ING, *a.* Not withdrawing; continually liberal.

UNWITHDRAW'N, *a.* Not withdrawn.

UNWITH'ERED, *a.* Not withered or faded.

UNWITH'ERING, *a.* Not liable to wither or fade.

UNWITHSTOOD', *a.* Not opposed.

UNWIT'NESSED, *a.* Not witnessed; not attested by witnesses; wanting testimony.

UNWIT'TILY, *adv.* Without wit.

UNWIT'TINGLY, *adv.* Without knowledge or consciousness; ignorantly; as, he has *unwittingly* injured himself, or his neighbour.

UNWIT'TY, *a.* Not witty; destitute of wit.

UNWIVED, † *a.* Having no wife.

UNWÖMAN, *v. t.* To deprive of the qualities of a woman.

UNWÖMANLY, *a.* Unbecoming a woman.

UNWONT, } *a.* Unaccustomed; un-

UNWÖNTED, } used; not made familiar by practice; as, a child *unwonted* to strangers; sea calves *unwonted* to fresh water.—2. Uncommon; unusual; infrequent; rare; as, an *unwonted* meteor; *unwonted* changes.

UNWÖNTEDLY, *adv.* A state of being unaccustomed.

UNWÖNTEDNESS, *n.* Uncommonness; rareness.

UNWOOD'ED, *a.* Destitute of trees, timber or wood; not producing trees; the prairies of the west are *unwooded*.

UNWOÖ'D, *a.* Not wooped; not courted.

UNWÖRKING, *a.* Living without labour.

UNWÖRKMANLIKE, *a.* Unskillful.

UNWÖRLDLINESS, *n.* State of being unworlily.

UNWÖRLDLY, *a.* Not worlily.

UNWÖRMED, † *a.* Not wormed.

UNWÖRN, *a.* Not worn; not impaired.

UNWÖR'RIED, *a.* Not worried.

UNWÖRSHIPPED, *a.* Not worshipped; not adored.

UNWÖRSHIPPING, *a.* Not worshipping; habitually neglecting the worship of God.

UNWÖRTHILY, *adv.* [See WORTHY and WORTH.] Not according to desert; without due regard to merit; as, to treat a man *unworthily*.

UNWÖRTHINESS, *n.* Want of worth or merit.

UNWÖRTHY, *a.* Not deserving; followed by *of*. As sinners, we are utterly *unworthy* of the divine favour.—2. Not deserving; wanting merit. Receive your *unworthy* son into favour. One great evil of government is that *unworthy* men are elected or appointed to fill important offices.—3. Unbecoming; vile; base; as, *unworthy* usage or treatment.—4. Not suitable; inadequate. This opinion is *unworthy* of its author.

UNWÖUND', *pp.* of *Unwind*. Wound off; untwisted.

UNWÖUND'ED, *a.* Not wounded; not

hurt; not injured in body; as, *unwounded* enemies.—2. Not hurt; not offended; as, *unwounded* ears.

UNWÖUND'ING, *a.* Not hurting.

UNWÖVE, *pret.* of *Unweave*.

UNWÖVEN, *a.* Not woven.

UNWÖRAP', *v. t.* To open what is wrapped or folded.

UNWÖREATHE, *v. t.* To untwist or untwine.

UNWÖRENCH'ED, *a.* Not strained; not distorted.

UNWÖRIN'KLE, *v. t.* To reduce wrinkles; to smooth.

UNWÖRINK'LED, *a.* Not shrunk into furrows and ridges.

UNWÖRITE, *v. t.* To cancel what is written; to erase.

UNWÖRIT'ING, *a.* Not writing; not assuming the character of an author; as, an *unwriting* citizen.

UNWÖRIT'TEN, *a.* (*unrit'ten*.) Not written; not reduced to writing; verbal.—2. Blank; containing no writing.—

*Unwritten doctrines*, in religion, are such as have been handed down by word of mouth; oral or traditional doctrines.—

*Unwritten laws*, are such as have been delivered down by tradition or in songs. Such were the laws of the early nations of Europe. The *unwritten laws* of England, called *common law*, are such as have not the authority of statutes, not having originated from any legislative act, or originating from some act not now extant. These laws are now contained in the reports of judicial decisions. [See LAW.]

UNWÖRONG'ED, *a.* Not treated unjustly.

UNWÖROUGHT, *a.* (*unraut'*.) Not laboured; not manufactured; not reduced to due form.

UNWÖRUNG, *a.* (*unrung'*.) Not pinched.

UNYIELD'ED, *a.* Not yielded; not conceded; not given up.

UNYIELDING, *a.* Not yielding to force or persuasion; unbending; unpliant; stiff; firm; obstinate.—2. Not giving place.

UNYIELDINGLY, *adv.* Unbendingly; obstinately.

UNYIELDINGNESS, *n.* State of being unyielding.

UNYÖKE, *v. t.* To loose from a yoke; to free from a yoke.

*Unyoke* the steers. *Shak.*

2. To part; to disjoin.

UNYÖKED, *pp.* Freed from the yoke.—2. *a.* Not having worn the yoke.—3. Licentious; unrestrained.

UNYÖKING, *ppr.* Freeing from the yoke.

UNZÖNED, *a.* Not bound with a girdle; as, an *unzoned* bosom.

UP, *adv.* [Sax. *up*, *upp*; G. *auf*; D. and Dan. *op*; Sw. *up*.] 1. Aloft; on high.

But *up* or down. *Milton.*

2. Out of bed. He is *not up*.—3. Having risen from a seat.

Sir Roger was *up*. *Addison.*

4. From a state of concealment or discomfiture.—5. In a state of being built.

*Up* with my tent. *Shak.*

6. Above the horizon. The sun is *up*.

—7. To a state of excitement. He was wrought *up* to a rage.—8. To a state of advance or proficiency.

Till we have wrought ourselves *up* to this degree of Christian indifference. *Atterbury.*

9. In a state of elevation or exaltation. Those that were *up*, kept others low.

*Spenser.*

10. In a state of climbing or ascending. We went *up* to the city or town.—11. In a state of insurrection.

The gentle archbishop of York is *up*. *Shak.* My soul is *up* in arms.

*Dryden.*

12. In a state of being increased or raised. The river is *up*; the flood is *up*.—13. In a state of approaching; as, *up* comes a fox.—14. In order. He drew *up* his regiment.—15. From younger to elder years; as, from his youth *up*.—*Up and down*, from one place to another; here and there.—2. From one state or position to another; backward and forward.—*Up to*, to an equal height with; as, *up to* the chin in water.—2. To a degree or point adequate. Live *up* to the principles professed.—*Up with*, raise; lift; as, *up with* the fist; *up with* the timber.—*Up with the helm*, among seamen, the order to put the helm to the weatherside of the ship.—*Up* is much used to modify the actions expressed by verbs. It is very often useful and necessary, very often useless.—*To bear up*, to sustain.—*To go up*, to ascend.—*To lift up*, to raise.—*To get up*, to rise from bed or a seat.—*To bind up*, to bind together.—*To blow up*, to inflate; to distend; to inflame.—*To grow up*, to grow to maturity.—*Up stream*, from the mouth toward the head of a stream; against the stream; hence *up* is in a direction toward the head of a stream or river; as, *up* the country.—*Up sound*, in the direction from the sea; opposed to *down sound*, that is, in the direction of the ebb tide.—*Up* is likewise used elliptically for *get up*, expressing a command or exhortation.

And he said unto her, *Up*, let us be going; Judges xix. 28.

*UP*, *prep.* From a lower to a higher place. Go *up* the hill.

**UPAS**, } *n.* A tree common in  
**UPAS TREE**, } the forests of Java,  
and of some of the neighbouring islands. It is a species of the genus *Antiaris*, the *A. toxicaria*, nat. order Urticaceae.



Upas tree (*Antiaris toxicaria*).

Many fabulous stories were formerly propagated respecting this tree. It was said to be a large tree growing in Java, in the midst of a desert, caused by its own pestiferous qualities; its exhalations were said to cause death to all animals which approached the tree, and the juice which flowed from its stem was said to be the most deadly of poisons. To approach the tree for the purpose of wounding the stem and obtaining the juice, was stated to be so

dangerous, that none but criminals under sentence of death could be found to undertake the task. The truth is, that the upas is a tree which yields a poisonous secretion, and nothing more. The poison is called upas antiar, or bohun upas. The active principle in this secretion has been termed *Anti-arine*,—which see. *Upas tieute*, a name of the *strychnos tieute*, which is a very poisonous species of the genus *Strychnos*, and yields the greatest quantity of *Strychnia*.

**UPBEAR**, *v. t. pret.* *Upbore*; *pp.* *Upborne*. [*up* and *bear*. See **BEAR**.] 1. To raise aloft; to lift; to elevate.—2. To sustain aloft; to support in an elevated situation.

*Upborne* they fly. *Pope.*

3. To support; to sustain.  
**UPBIND**, *v. t.* To bind up.  
**UPBLOW**, } *v. t.* To blow up.

**UPBRAID**, *v. t.* [*Sax. upgebræan*, to reproach; *gebrædan*, to roast, to dilate or extend, to draw, as a sword; *brædan*, to braid; *Dan. bebrejder*, to upbraid.] 1. To charge with something wrong or disgraceful; to reproach; to cast in the teeth; followed by *with* or *for*, before the thing imputed; as, to upbraid a man for his folly or his intemperance.

Yet do not

*Upbraid* us with our distress. *Shak.*  
He upbraided them with their unbelief; Matth. xvi.

[The use of *to* and *of*, after *upbraid*,—as, to upbraid a man of his gain by iniquity, to upbraid to a man his evil practices,—has been long discontinued.]—2. To reproach; to chide.

God who giveth to all men liberally, and upbraideth not; James i.

3. To reprove with severity.  
Then he began to upbraid the cities wherein most of his mighty works were done; Matth. xi.

4. To bring reproach on.  
How much doth thy kindness upbraid my wickedness! *Sidney.*

5. † To treat with contempt.  
**UPBRAIDED**, *pp.* Charged with something wrong or disgraceful; reproached; reprovèd.

**UPBRAIDER**, *n.* One who upbraids or reproves.

**UPBRAIDING**, *ppr.* Accusing; casting in the teeth; reproaching; reprovèd.  
**UPBRAIDING**, *n.* A charging with something wrong or disgraceful; the act of reproaching or reprovèd.

I have too long borne

Your blunt upbraidings. *Shak.*

2. The reproaches or accusations of conscience.

**UPBRAIDINGLY**, *adv.* In an upbraiding manner.

**UPBRAY**, for *Upbraid*, to shame, is not in use.

**UPBREED**, *v. t.* To breed; to nurse; to train up.

**UPBROUGHT**, } *a.* (*upbraut*.) Brought up; educated.

**UP'CAST**, *a.* Cast up; a term in bowling.—2. Thrown upward; as, with *up-cast* eyes.

**UP'CAST**, *n.* In bowling, a cast; a throw.

**UPCOIL'ED**, *a.* Made into a coil.  
**UPCOIL'ING**, *a.* Winding into a coil.

**UPDRAW**, } *v. t.* To draw up.  
**UPDRAWN**, } *pp.* Drawn up.

**UPFILL**, } *v. t.* To fulfil; to make full.

**UPFILL'ING**, *a.* Filling up.  
**UPFLUNG**, *a.* Thrown up.

**UPGATH'ER**, } *v. t.* To contract.  
**UPGAZE**, } *v. t.* To gaze upwards; to look steadily upwards.

**UPGROW**, } *v. t.* To grow up.

**UP'HAND**, *a.* Lifted by the hand.

**UPHEAVED**, *a.* Piled up; accumulated.

**UPHEAVE**, *v. t.* To leave or lift up from beneath.

**UPHEAVED**, *pp.* or *a.* Heaved up; lifted or forced up by some expansive or elevating power from below; as, rocks or strata.

**UPHEAVING**, *ppr.* Heaving or lifting up.

**UPHELD**, } *pret.* and *pp.* of *Uphold*. Sustained; supported.

**UP'HERS**, *n. plur.* In *arch.*, the name given to fir poles, chiefly used for scaffolding, and for ladders. They are from 4 to 7 inches diameter, and from 20 to 40 feet in length.

**UP'HILL**, *a.* Difficult, like the act of ascending a hill; as, *uphill* labour.

**UPHÓARD**, } *v. t.* To hoard up.

**UPHOLD**, *v. t. pret.* and *pp.* *upheld*. [*Upholden* is obsolete.] 1. To lift on high; to elevate.—2. To support; to sustain; to keep from falling or slipping.

Honour shall uphold the humble in spirit; Prov. xxix.

3. To keep from declension.—4. To support in any state.—5. To continue; to maintain.—6. To keep from being lost.

Faulconbridge,

In spite of spite, alone upholds the day.

*Shak.*

7. To continue without failing.—8. To continue in being.

**UPHOLDER**, *a.* One that upholds; a supporter; a defender; a sustainer.—2. An undertaker; one who provides for funerals.—3. An upholsterer.

**UPHOLSTERER**, *n.* [*from up and hold*.] One who furnishes houses with beds, curtains, and the like.

**UPHÓLSTERY**, *n.* Furniture supplied by upholsterers.

**UP'HROE**, *n.* In *ships*, an oblong block, which is used to suspend the awnings.

**UP'LAND**, *n.* [*up* and *land*.] Highland; ground elevated above the meadows and intervals which lie on the banks of rivers, near the sea, or between hills; land which is generally dry. It is opposed to meadow, marsh, swamp, interval, &c. Uplands are particularly valuable as affording pasture for sheep.

**UP'LAND**, *a.* Higher in situation; being on upland; as, *upland* inhabitants.—2. Pertaining to uplands; as, *upland* pasturage.—3. † Rude; savage; uncivilized.

**UP'LANDER**, *n.* An inhabitant of the uplands.

**UPLAND'ISH**, *a.* Pertaining to uplands; dwelling on high lands or mountains; rustical; rude.

**UPLAY**, } *v. t.* To lay up; to hoard.

**UPLEAD**, *v. t.* To lead upward.

**UPLED**, } *pp.* Led upward.

**UPLIFT**, *v. t.* To raise aloft; to raise; to elevate; as, to *uplift* the arm. It is chiefly used in the participle; as, *uplifted* eyes; *uplifted* arms.

**UPLIFT'ED**, *pp.* Raised high; lifted; elevated.

**UPLIFT'ING**, *ppr.* Lifting up; elevating.

**UPLOCK**, } *v. t.* To lock up.

**UPLOCK'ED**, } *pp.* Closed; shut; fastened up, as by a lock.

**UPLOOK**, } *v. t.* To look up.

**UP'MÓST**, *a.* [*up* and *most*.] Highest;

topmost. [*Little used.* We generally use *uppermost*.]

**UPON**, *prep.* [Sax. *ufan, ufon, or ufe.* This is probably *up* and *on*; the Sax. *ufe* being the G. *auf, up*.] *On.* *Upon* has the sense of *on*, and might perhaps be wholly dispensed with.—1. Resting or being on the top or surface; as, being *upon* a hill, or *upon* a rock; *upon* a field; *upon* a table; *upon* a river; *upon* the altar; *upon* the roof. He has his coat *upon* his back; his hat is *upon* his head.—2. In a state of resting or dependence; as, *upon* this condition; he will contract with you *upon* these terms. *Upon* our repentance we hope to be forgiven.—3. Denoting resting, as a burden. Impose *upon* yourself this task.—4. In the direction or part of; as, *upon* the right hand.—5. Relating to. They are now engaged *upon* the affairs of the bank.—6. In consideration of; as, *upon* the whole matter.—7. Near to; as, a village *upon* the Thames.—8. With, or having received. He came *upon* an hour's warning.—9. On the occasion of; engaged in for the execution of. He sent the officer *upon* a bold enterprise.—10. In; during the time of; as, *upon* the seventh day; *upon* the first of January.—11. Noting security; as, to borrow money *upon* lands, or *upon* mortgage.—12. Noting approach or attack.

The Philistines be *upon* thee, Samson; Judges xvi.

13. Noting exposure or incurring some danger or loss. You do this *upon* pain of death, or *upon* the penalties of the law.—14. At the time of; on occasion of. What was their conduct *upon* this event?—15. By inference from, or pursuing a certain supposition. *Upon* his principles, we can have no stable government.—16. Engaged in. What is he *upon*?—17. Having a particular manner. The horse is now *upon* a hard trot.—18. Resting or standing, as on a condition. He is put *upon* his good behaviour.—19. Noting means of subsistence or support. Cattle live *upon* grass.—20. Noting dependence for subsistence; as, paupers come *upon* the parish or town.—*To take upon*, to assume.—*To assume upon*, in law, to promise; to undertake. *Upon* is, in many of its significations, now contracted into *on*. [*See On.*] Its meaning is very multifarious, but it is always connected with words expressing or implying, either literally or metaphorically, a ground, foundation, standing place, resting place, support, or the like.

**UPPER**, *a.* [*comp. from up.*] Higher in place; as, the *upper* lip; the *upper* side of a thing. An *upper* story is a higher one; the *upper* story is the highest. So the *upper* deck of a ship.—2. Superior in rank or dignity; as, the *upper* house of a legislature. In *Great Britain*, the house of lords is often termed the *upper house*, in distinction from the *lower house*, or house of commons.—*Upper hand*, advantage; superiority.—*Upper-works*, in a ship, the parts above water when the ship is properly balanced for a voyage; or that part which is above the main wale.—*Upper deck*, the highest of those decks which are continued throughout the whole of a ship of war or merchantman, without interruption.

**UPPER-HAND**, *n.* Superiority; advantage.

**UPPER-LEATHER**, *n.* The leather for the vamps and quarters of shoes.

**UPPERMOST**, *a.* [*superl.; upper and most.*] 1. Highest in place; as, the *uppermost* seats.—2. Highest in power or authority.

Whatever faction happens to be *uppermost*. *Sieft.*

3. Predominant; most powerful.

**UP-PILE**, *v. t.* To pile up; to heap.

**UP-PILED**, *a.* Piled upward.

**UP-PISH**; *a.* Proud; arrogant. [*A low word.*]

**UP-PISHNESS**, *n.* Pride; arrogance.

**UP-PRICK'ED**, *a.* Set up sharply or pointedly.

**UP-PROP**, *v. t.* To prop up; to sustain by a prop.

**UPRAISE**, *v. t.* (*s* as *z.*) [*up and raise.*] To raise; to lift up.

**UPRAISED**, *pp.* Lifted up.

**UPRAISING**, *n.* A raising or elevation.

**UPREAR**, *v. t.* [*up and rear.*] To rear up; to raise.

**UPREARED**, *pp.* Reared up; raised.

**UPRIDG'ED**, *a.* Raised up in ridges, or extended lines.

**UPRIGHT**, *a.* (*up*'rite.) [*up and right.*] This word is marked in books with the accent on the first syllable. But it is frequently pronounced with the accent on the second, and the accent on either syllable of its derivatives is admissible.]

1. Erect; perpendicular to the plane of the horizon; as, an *upright* tree; an *upright* post. Among *mech.*, plumb.—2. Erected; pricked up; shooting directly from the body.

All have their ears *upright*. *Spenser.*  
With chattering teeth and bristling hair *upright*. *Dryden.*

3. Honest; just; adhering to rectitude in all social intercourse; not deviating from correct moral principles; as, an *upright* man; Job i.—4. Conformable to moral rectitude.

Conscience rewards *upright* conduct with pleasure. *J. M. Mason.*

**UP'RIGHT**, *n.* In *arch.*, a representation or draught of the front of a building; called also an elevation, or orthography. [*Little used.*]—2. Something standing erect or perpendicular.—3. Among *carpenters*, a principal piece of timber placed vertically, and serving to support rafters.

**UP'RIGHT'EOUSLY**, *adv.* justly.

**UP'RIGHT-HEARTED**, *a.* Having an upright heart.

**UP'RIGHTLY**, *adv.* In a direction perpendicular to the plane of the horizon; in an erect position.—2. Honestly; with strict observance of rectitude; as, to live *uprightly*.

He that walketh *uprightly*, walketh surely; Prov. x.

**UP'RIGHTNESS**, *n.* Perpendicular erection.—2. Honesty; integrity in principle or practice; conformity to rectitude and justice in social dealings.

The truly upright man is inflexible in his *uprightness*. *Atterbury.*

**UPRISE**, *v. i.* (*s* as *z.*) pret. *Uprose*; pp. *Uprisen*. To rise from bed or from a seat.

*Uprose* the virgin with the morning light. *Pope.*

2. To ascend above the horizon. *Uprose* the sun. *Cowley.*

3. † To ascend, as a hill.

**UPRISE**, † *n.* A rising; appearance above the horizon.

**UPRISING**, *ppr.* Rising; ascending.

**UPRISING**, *n.* The act of rising.

Thou knowest my down-sitting and mine *uprising*; Ps. cxxxix.

**UPROAR**, *n.* [*D. uproer*; G. *aufrohr*;

*auf, up*, and *rühren*, to stir, to beat, *D. roeren*, Sw. *röra, uproer*. It is sometimes accented on the second syllable.] Great tumult; violent disturbance and noise; bustle and clamour.

The Jews who believed not...set all the city in an *uproar*; Acts xvii.

Horror thus prevailed, And wild *uproar*. *Philips.*

**UPROAR**, † *v. t.* To throw into confusion.

**UPROARIOUS**, *a.* Making a great noise and tumult.

**UPROARIOUSLY**, *adv.* With great noise and tumult.

**UPROLL**, *v. t.* [*up and roll.*] To roll up.

**UPROLLED**, *pp.* Rolled up.

**UPROOT**, *v. t.* [*up and root.*] To root up; to tear up by the roots; as, to *uproot* the hills or trees.

**UPROOT'ED**, *pp.* Torn up by the roots.

**UPROUSE**, *v. t.* (*aprouz'*.) [*up and rouse.*] To rouse from sleep; to awake.

**UPROUS'ED**, *pp.* Roused from sleep.

**UPROUS'ING**, *ppr.* Rousing from sleep.

**UPRUN**, *v. t.* To run, ascend, or mount up.

**UPS AND DOWNS**, *n. pl.* Vicissitudes; as, there are usually many *ups and downs* in an adventurer's life. [*Colloq.*]

**UPSEND**, *v. t.* To send, cast, or throw up.

**UPSET**, *v. t.* [*up and set.*] To overturn; to overthrow; to overset; as a carriage.

**UPSET**, *n.* An overturn; an overthrow, as of a carriage. [*Trivial.*]

**UPSET-PRICE**, *n.* In *Scots law*, the price at which any subject, as lands, tenements, goods, &c., is exposed to sale by auction. In such a case, the person who offers the upset price, if there be no other offerers, becomes the purchaser.

**UPSET'ING**, *a.* Assuming; conceited. [*Scotch.*]

**UPSET'ING**, *n.* The act of overturning.

**UP'SHOT**, *n.* [*up and shot.*] Final issue; conclusion; end; as, the *upshot* of the matter.

Here is the *upshot* and result of all. *Burnet.*

**UP'SIDE**, *n.* The upper side; the upper part.

**UPSIDE DOWN**. The upper part undermost. As a phrase, this denotes in confusion; in complete disorder.

**UPSNATCH'ING**, *a.* Snatching up; seizing.

**UPSOAR**, *v. i.* To soar aloft; to mount up.

**UPSPPEAR**, *v. i.* To shoot upwards like a spear.

**UPSPPEARING**, *a.* Rising up as a spear.

**UPSPRING**, † *v. i.* To spring up.

**UPSPRING**, † *n.* An upstart; a man suddenly exalted.

**UPSTAND**, † *v. i.* To be erected.

**UPSTART**, *v. i.* [*up and start.*] To start or spring up suddenly.

**UPSTART**, *n.* One that suddenly rises from low life to wealth, power, or honour.—2. Something that springs up suddenly.

**UPSTART**, *n.* A term applied by masons to the stone jamb of a door or window, when it is formed of a single stone set on its end, and not built in courses; and, generally, to any long stone set on end in a structure.

**UPSTART**, *a.* Suddenly raised.

**UPSTAY**, *v. t.* [*up and stay.*] To sustain; to support.

**UPSTAYING**, *ppr.* Supporting.

UPSWARM, † *v. t.* [*See SWARM.*] To raise in a swarm.  
 UPSWELL, † *v. i.* To swell; to rise up.  
 UPTAKE, † *v. t.* [*up and take.*] To take into the hand.—2. Perceptive power; as, he is quick in the uptake. [*Familiar, and local.*]  
 UPTEAR, *v. t.* [*up and tear.*] To tear up.  
 UPTHROW, *v. t.* To throw up; to elevate.  
 UPTRACE, *v. t.* To trace up; to investigate.  
 UPTRAIN, † *v. t.* [*up and train.*] To train up; to educate.  
 UPTURN, † *v. t.* [*up and turn.*] To turn up; to throw up; as, to *upturn* the ground in ploughing.  
 UPUPA, *n.* The hoopoe, a genus of insectivorous or perching birds, distinguished by an ornament on the head, formed of a double range of long feathers, which they can erect at will. *U. epops*, or common hoopoe, is supposed to be an inhabitant of the whole of



Ночуе (Upupa epops.)

North Africa. In summer it migrates as far north as Denmark, Sweden, and Russia; and southward, in continental Europe, it is found in Germany, Holland, France, Spain, and Italy. It is generally found in the British Islands in autumn.

UPUPIDÆ, *n.* A family of insectivorous or perching birds, of which the genus *Upupa* is the type. Besides the hoopoes, it comprises the genera *promops* and *epimachus*, Cuv.

UPWAFTED, *a.* Sustained; borne up; carried aloft.

UPWARD, *a.* [*up and ward, Sax. weard, L. versus.*] Directed to a higher place; as, with *upward* eye; with *upward* speed.

UPWARD, † *n.* The top.  
 UPWARD, } *adv.* Toward a higher  
 UPWARDS, } place; opposed to *downwards*.

*Upward* I lift my eye. *Watts.*  
 2. Toward heaven and God.  
 Looking inward, we are struck dumb; looking upward, we speak and prevail. *Hooker.*

3. With respect to the higher part.  
*Upward* man, *Milton.*  
 Downward fish.

4. More than, indefinitely. *Upwards* of ten years have elapsed; *upwards* of a hundred men were present.—5. Toward the source. Trace the stream *upwards*.  
 And trace the muses *upward* to their spring. *Pope.*

UPWHIRL, *v. i.* (upwhirl') [*up and whirl.*] To rise upward in a whirl; to whirl upward.

UPWHIRL', *v. t.* To raise upward in a whirling direction.

UPWIND, *v. t.* [*up and wind.*] To wind up.

URACHUS, *n.* [*Gr. ουραχος, from ουρα, urine.*] In *anat.*, the ligamentous cord that arises from the base of the urinary bladder, which it runs along, and terminates in the umbilical cord.

URALIAN, *a.* Relating to the river Ural, or the Ural mountains, in Russia.

URAMILE, *n.* A new chemical compound discovered by Wöhler and Liebig. It is a product of the decomposition of thionuric acid, and is obtained either in the form of a crystalline powder, or in dendritic or feathery crystallizations, of a very beautiful aspect. It dissolves in ammonia and potash, and the solution absorbs oxygen, becoming purple, and depositing green crystals of murexide, or of potassium-murexide. Uramile may be considered as uric acid, in which the urea is replaced by 1 equivalent of ammonia, and 2 of water.

URAMILIC ACID, *n.* An acid obtained by Wöhler and Liebig, by evaporating acid thionurate of ammonia, or uramile, with dilute sulphuric acid. It appeared to those chemists as fine four-sided prisms, or silky needles, very soluble in water; but it has not again been obtained, and its existence is still doubtful.

URAN-GLIMMER, *n.* An ore of uranium; uran-mica; chalcocite.

URANIA, *n.* In *Grecian myth.*, the muse of astronomy. She is generally represented with a crown of stars, in



Urania, from an antique statue.

a garment spotted with stars, and holding in her left hand a celestial globe or a lyre. *Urania* is likewise the name of the heavenly Venus, or of pure intellectual love. One of the Oceanides, or sea-nymphs, was also called *Urania*.—2. In *bot.*, a genus of plants; nat. order Musacæ. It has but one species, the *U. speciosa*, a native of Madagascar, with flowers similar to the Bananas, and leaves arranged in a fan-shape. The seeds are said to constitute a wholesome food. It may be ranked among the most splendid of our hot-house plants.

URANIC ACID, *n.* Peroxide of uranium.

URANITE, *n.* An ore or phosphate of uranium, called also uran-glimmer and uran-mica. Streok paler than the colour; colour emerald-green, grass-green, leek-green, golden-yellow, and

lemon-yellow; transparent or sub-translucent. It contains phosphoric acid, oxide of uranium, lime, silica, oxide of iron, with small quantities of magnesia, oxide of manganese and barytes, but it appears essentially to consist of the phosphates of uranium and lime. It occurs crystallized in rectangular prisms, in imperfect octahedrons, &c. Its structure is lamellar, and it yields to the knife. Uranite is found in veins of granite near Autun and Limoges, in France, and also in several parts of Saxony. A green variety, called chalcocite and uran-mica, is found in Cornwall. Its colour is owing to the presence of phosphate of copper instead of phosphate of lime.  
 URANITIC, *a.* Pertaining to uranite, or resembling it.

URANIUM, *n.* A metal discovered by Klaproth, in 1789, who named it after the planet Uranus, the discovery of which had occurred some years before. It was obtained from the mineral called *pechblende*, which consists of protoxide of uranium, and oxide of iron. It also occurs in the form of peroxide in uranite and uran-mica. Uranium appears to be of a crystalline texture, with a metallic lustre, and of a reddish-brown colour. It suffers no change from exposure to the air at common temperatures, but when heated in open vessels it absorbs oxygen, and is reconverted into the protoxide. The properties of this metal, however, are as yet known imperfectly, and, from recent researches, it would appear that what was supposed to be the metal is an oxidised body, acting, according to Péligot, the part of a metal; while, according to others, it is the protoxide of the true metal. The oxide of uranium, or what was formerly regarded as metallic uranium, is used for giving a fine black in painting on porcelain, and the peroxide and all its compounds have rich and permanent yellow colours.

URAN-MICA, *n.* Green uranite, or chalcocite. [*See URANITE.*]

URAN-O'CHRE, *n.* A yellow earthy incrustation, supposed to be the oxide of uranium, combined with carbonic acid, or a carbonate of uranium. It is also termed *uran-bloom* and *uraconise*. It occurs in silver-veins in Bohemia, forming a coating on *pechblende*. The same name is also applied to *pechblende*.

URANOGRAPHICAL, *a.* Pertaining to uranography; as, *uranographical* problems.

URANOGRAPHY, *n.* [*Gr. ουρανος, heaven, and γραφω, to describe.*] Literally, a description of the heavens. That branch of astronomy which consists in the determination of the relative situations of the heavenly bodies, and the construction of maps and globes which shall truly represent their mutual configurations, as well as of catalogues which shall preserve a precise numerical record of each.

URANOL'OGY, *n.* [*Gr. ουρανος, heaven, and λογω, discourse.*] A discourse or treatise on the heavens.

URANOS' COPUS, *n.* Star-gazer, a genus of acanthopterygious fishes of the percid family. They are very nearly related to the *weavers* of the British seas. One or two species inhabit the Mediterranean. The head is nearly cubical, and the eyes are placed in the flat summit, so that they look



upwards. The mouth is turned up in a similar manner.

**URANUS' COPY, n.** [Gr. *ουρανός*, heaven, and *εικονία*, to view.] Contemplation of the heavenly bodies.

**URANUS, n.** [Gr. *ουρανός*, heaven.] In *myth.*, a divinity, the first king of the Atlantic nation, and the father of Saturn.—2. In *astron.*, one of the primary planets, discovered by Sir William Herschel in 1781. It was the remotest known planet belonging to our system, until the discovery of the planet Neptune in 1846. It presents the appearance of a small round uniformly illuminated disc, without rings, belts, or discernible spots. To the naked eye it appears like a star of the sixth magnitude, its apparent diameter being about four seconds. Its real diameter is 35,000 miles, so that its bulk is about eighty times that of the earth. It completes its revolution round the sun in nearly 84 of our years, moving in its orbit at the rate of 15,000 miles in an hour. Its distance from the sun is 1800 millions of miles. Sir W. Herschel discovered six satellites about the planet Uranus. The existence of two of these has been clearly made out, but many have doubted the existence of the remaining four, as no one besides Herschel himself has ever been able to see one of them, except Mr. Lamont, of the observatory of Munich, who saw the sixth satellite in 1837. The orbits of the satellites of Uranus (at least of those two whose existence is certain), are nearly at right angles to the plane of the ecliptic, and their motions are retrograde, or from east to west, instead of from west to east, as is the case with every other planet and satellite. The name *Uranus* was given to this planet in allusion to the ancient mythology, according to which Uranus was the father of Saturn, as Saturn was of Jupiter, and Jupiter of Mars. It was also named Herschel in honour of the discoverer, and the Georgium Sidus, in honour of the reigning king, George III.; but the name Uranus is now universally recognised.

**URAO, n.** Another name for *Trona*,—which see.

**URATE, n.** A compound of uric acid and a base; as, *urate* of potash, *urate* of soda, *urate* of ammonia, &c. [See URIC ACID.]

**URBAN, a.** [L. *urbanus*, from *urbs*, a city.] Civil; courteous in manners; polite.—2. Of or belonging to a town or city; as, *urban* population; *urban* districts.—*Urban servitudes*, in *Scots law*, a species of predial servitudes, so named from their being connected with edifices. Of this kind is the obligation on a tenement which is under another to bear its weight; also stillicide, light, prospect, &c. [See SERVITUDE.]

**URBANE, n.** [See ABOVE.] Civil; courteous; polite; elegant in manners.

**URBANITY, n.** [Fr. *urbanité*; L. *urbanitas*, from *urbs*, a city.] 1. That civility or courtesy of manners which is acquired by associating with well bred people; politeness; polished manners.—2. Facetiousness.

**URBANIZE, v. t.** To render civil and courteous; to polish.

**URCEOLA, n.** A genus of plants; nat. order Apocynaceae. The plants of this genus inhabit the Malayan peninsula. The most important species is the *U. elastica*, or caoutchouc-vine. From wounds made in the bark of this

plant, there oozes out a milky fluid, which, on exposure to the open air, separates into an elastic coagulum and



*Uroecia elastica.*

a watery fluid. This coagulum is found to resemble Indian rubber, and to possess all its properties.

**URCEOLA'RIA, n.** A genus of crustaceous lichens. There are six British species, generally found on rocks, stones, and walls. Of these the *U. scruposa* and *U. cinerea* are used for dyeing. *U. esculenta* is a native of Tartary, and is used as an article of diet.

**URCEOLATE, a.** [L. *urceolus*, *urceus*, a pitcher.] In *bot.*, shaped like a pitcher; swelling out like a pitcher, as respects the body, and contracted at the orifice; as a calyx or corol.

**UR'CHIN, n.** [Arm. *heureuchin*; L. *erinaceus*.] 1. A name given to the hedgehog. The name of *sea-urchin* has been given to the Echinus.—2. A name of slight anger given to a child; as, the little *urchin* cried.

**URDÉE, } a.** In *her.*, a *cross urdée* is **UR'DY, }** one in which the extremities are drawn to a sharp point, instead of being cut straight.

**URE, n.** Use; practice. [Obsolete, but retained in *inure*.]

**UREA, n.** A remarkable compound which exists in large proportion in healthy urine, and is extracted from it by the action of oxalic acid, or nitric acid. It is also prepared artificially and more easily from cyanate of ammonia. In its solid and pure state, urea crystallizes in four-sided prisms resembling nitre in appearance, and also in their taste, which is saline and cooling, exactly like that of nitre. It is soluble both in water and alcohol, and, when heated, it melts, gives off much ammonia, and finally solidifies, being in a great measure converted into ammonia and cyanuric acid. It belongs to the class of organic bases, forming crystallizable compounds with several acids, such as nitric, oxalic, and acetic acids. It consists of 2 atoms of carbon, 4 of hydrogen, 2 of nitrogen, and 2 of oxygen.

**UREDO, n.** [L. *uro*, to burn.] A genus of microscopical fungi, which are very injurious to plants. The diseases called smut, brand, burnt ear, rust, &c., are caused by their ravages. Their presence is known by the burnt appearance of the part they infest.—2. In *med.*, an itching or burning sensation of the skin, which accompanies many diseases.

**URE'NA, n.** A genus of plants; nat. order Malvaceae. The species consist

of small shrubs, indigenous in India, China, Mauritius, South America, and the West Indies. They abound in strong flax-like fibres, which are well fitted for conversion into cordage.

**URE'TER, } n.** [Gr. *ουρητήρ*, from *ουρη*, **URE'TER, }** See URINE.] The excretory duct of the kidney, a tube conveying the urine from the kidney to the bladder. There are two ureters, one on each side.

**URETERITIS, n.** Inflammation of the ureter.

**URETHANE, n.** [*urea* and *ether*.] A compound formed by the action of ammonia on chlorocarbonic ether. It is a colourless pearly crystalline mass, like spermaceti. It is very soluble in water and alcohol, and yields large crystals. It may be considered as formed of 2 equivalents of carbonic ether, and 1 equivalent of urea.

**URE'THRA, n.** [Gr. *ουρηθρα*, from *ουρη*, See URINE.] The canal by which the urine is conducted from the bladder and discharged.

**URE'THREAL, a.** Pertaining to the urethra.

**URETHRITIS, n.** An inflammation in the urethra.

**URETHYLANE, n.** A compound formed by the action of ammonia on oxychlorocarbonate of oxide of methule. It is a deliquescent crystallizable mass, corresponding to *urethane*.

**URGE, v. t.** [L. *urgeo*.] This belongs probably to the family of Gr. *υρζω*, and L. *arceo*.] 1. To press; to push; to drive; to impel; to apply force to, in almost any manner.

And great Achilles *urges* the Trojan fate.

*Dryden.*

2. To press the mind or will; to press by motives, arguments, persuasion, or importunity.

My brother

Did *urges* me in his act. *Shak.*

3. To provoke; to exasperate. *Urge* not my father's anger. *Shak.*

4. To follow close; to impel. *Heir urges* heir, like wave impelling wave. *Pope.*

5. To labour vehemently; to press with eagerness.

Through the thick deserts headlong *urg'd* his flight. *Pope.*

6. To press; as, to *urges* an argument; to *urges* a petition; to *urges* the necessity of a case.—7. To importune; to solicit earnestly. *He urged* his son to withdraw.—8. To apply forcibly; as, to *urges* an ore with intense heat.

**URGE, v. i.** To press forward; as, he strives to *urges* upward.

**URG'ED, pp.** Pressed; impelled; importuned.

**URG'ENCY, n.** Pressure; importunity; earnest solicitation; as, the *urgency* of a request.—2. Pressure of necessity; as, the *urgency* of want or distress; the *urgency* of the occasion.

**URG'ENT, a.** Pressing with importunity; Exod. xii.—2. Pressing with necessity; violent; vehement; as, an *urgent* case or occasion.

**URG'ENTLY, adv.** With pressing importunity; violently; vehemently; forcibly.

**URG'ER, n.** One who urges; one who importunes.

**URG-WONDER, n.** A sort of grain.

**URG'ING, ppr.** Pressing; driving; impelling.—2. *a.* Pressing with solicitations; importunate.

**URIC ACID, n.** [Gr. *ουρη*, urine.] An acid discovered by Scheele, and some-

times called *lithic acid*. It occurs in small quantity in the healthy urine of man and quadrupeds, and in much larger quantity in the urine of birds. The semi-fluid urine of birds and serpents is principally composed of urate of ammonia, and guano, which is the decomposed excrement of aquatic birds, contains a large quantity of urate of ammonia. Uric acid occurs in combination with soda or ammonia in those gouty concretions, commonly called *chalk-stones*, and it constitutes the principal proportion of the calculi, deposited in the human bladder, and of the red gravel or sand which is voided in certain morbid states of the urine. It is best obtained from the excrement of the boar constrictor. It crystallizes in fine scales of a brilliant white colour, and silky lustre; it is inodorous and insipid, heavier than water, and nearly insoluble in it when cold, and only slightly dissolved by it when hot; but the solution reddens litmus paper, but feebly. Nitric acid dissolves uric acid, and also sulphuric acid, when concentrated. When it is dissolved in nitric acid, the solution contains alloxan, alloxantine, parabanic acid, and ammonia, and when evaporated, and treated with ammonia in excess, it acquires a purple red colour, a test by which uric acid may be recognised. It consists of 10 equivalents of carbon, 4 of nitrogen, 4 of hydrogen, and 6 of oxygen. It may be regarded as a compound of urile or cyanoxalic acid with urea. The saline compounds of uric acid are called *urates*, the most important of which are the urates of potash, soda, and ammonia.

**URILE**, } *n.* A radical supposed to  
**URYLE**, } exist in the compounds of uric acid, and to be formed of the elements of cyanogen, and those of carbonic oxide. It is also called cyanoxalic acid.

**URIM**, *n.* [Heb. אורם, *urim*.] The Urim and Thummim, among the Israelites, signify lights and perfections. These were a kind of ornament belonging to the habit of the high priest, in virtue of which he gave oracular answers to the people; but what they were has not been satisfactorily ascertained.

**URINAL**, *n.* [Fr. *urinal*; L. *urinalis*, from *urina*, urine.] 1. A bottle in which urine is kept for inspection.—2. A vessel for containing urine.

**URINANT**, *ppr.* [L. *urino*, to duck or dive under water.] In *her.*, a term applicable to the dolphin or other fish when borne with the head downwards, and the tail erect, exactly in a contrary position to what is termed *haurient*.

**URINARY**, *a.* [from *urine*.] Pertaining to urine; as, the *urinary bladder*; *urinary calculi*; *urinary abscesses*.—*Urinary calculi*, or concretions in the bladder or kidneys, consist chiefly of uric acid.—*Urinary organs*, the kidneys, the ureters, the bladder, and the urethra.

**URINARY**, } *n.* In *agriculture*, a  
**URINARIUM**, } reservoir or place for the reception of urine, &c., for manure.

**URINARY**, } *a.* [Fr. *urinoir*.] A shel-  
**URINOIR**, } tered convenience, for men's needs, set up near streets, &c., in towns; a public urinal.

**URINATIVE**, *a.* Provoking urine.

**URINATOR**, *n.* [L. from *urino*, to

dive.] A diver; one who plunges and sinks in water in search of something, as for pearls.

**URINE**, *n.* [L. *urina*; Gr. *ουρον*, from *ουρος*: G. *harn*, *harnen*.] An animal fluid or liquor secreted by the kidneys, whence it is conveyed into the bladder by the ureters, and through the urethra discharged. In its natural state it is acid, transparent, of a pale amber or straw-colour, a brackish taste, a peculiar odour, and of a specific gravity varying from 1.012 to 1.030. The character of the urine, however, is apt to be altered by a variety of circumstances, and from the variety of the substances extracted from the body through the medium of the kidneys, the urinary system may be regarded as the emunctory of the entire animal economy, in which we meet with every principle and constituent that analysis has discovered, forming the solids and fluids of the body. A knowledge of the urine in health, and of the variations to which it is subject in disease, is of the utmost importance to the medical practitioner, as the different appearances of this fluid indicate not merely the state of the urinary system, but the changes which have taken place in other parts of the animal economy. According to Berzelius, 1000 parts of healthy urine contain:—water, 933 parts; urea, 30.1; uric acid, 1; free lactic acid, lactate of ammonia, and animal matters not separable from them, 17.14; mucus of the bladder, 0.32; sulphates of potash and soda, 6.87; phosphates of soda and ammonia, 4.59; muriate of soda, 4.45; muriate of ammonia, 1.50; earthy phosphates, with a trace of fluoride of lime, 1; silica, 0.03. In addition to these ingredients, urine occasionally contains a variety of other substances, as sugar bile, albumen, fibrin, fat, blood, &c. No liquor in the human body is so variable, in respect to quantity or quality, as the urine. It varies even in its healthy state in respect to age, drink, food, medicines, the time of the year, the muscular motion of the body, and the affections of the mind.

**URINE**, } *v. i.* [supra.] To dis-  
**URINATE**, } charge urine.

**URINOMETER**, *n.* [L. *urina*, and Gr. *μετρον*, measure.] An instrument for ascertaining the specific gravity of urine. It is constructed upon the principle of the common hydrometer.

**URINOUS**, } *a.* Pertaining to urine,  
**URINOSE**, } or partaking of its qualities.

**URITHS**, *n.* The flexible rods bound around hedges. [*Provincial*.]

**URN**, *n.* [L. *urna*.] 1. A kind of vase of a roundish form, but swelling in the middle like the common pitcher. It is now seldom used but in the way of ornament over chimney pieces, in buffets, &c.—2. A vessel for water; a vessel employed to keep water boiling at the tea table, commonly called a *tea-urn*.—3. A vessel in which the ashes of the dead were formerly kept.—4. A Roman measure for liquids, containing about three gallons and a half, wine measure.—5. In *bot.*, the hollow vessel in which the spores or false seeds of mosses are lodged.

**URN**, } *v. t.* To enclose in an urn.

**URN-SHAPED**, *a.* Having the shape of an urn.

**UROS-COPY**, *n.* [Gr. *ουρον* and *σκοπιον*.] The judgment of diseases by inspection of the urine.

**UR'RY**, *n.* A sort of blue or black clay, lying near a vein of coal.

**URSA**, *n.* [L.] A bear. *Ursa major*, the great bear, one of the most conspicuous of the northern constellations, situated near the pole. It is remarkable from its well known seven stars, by two of which, called the *pointers*, the pole star is always readily found. These seven stars are popularly called the *waggon*, *Charles's wain*, and sometimes the *plough*. *Ursa minor*, the little bear, the constellation which contains the north pole, or the visible star which is nearest to the northern pole of the heavens. This constellation has seven stars placed together in a manner very much resembling those in *ursa major*, the pole-star being placed in the corner of the triangle which is farthest from the quadrangle.

**UR'SIDÆ**, *n.* A family of plantigrade carnivorous animals, comprising the true bears, the badger, the racoon, and the wolverene, or glutton.

**UR'SIFORM**, *a.* [L. *ursa*, bear, and *form*.] In the shape of a bear.

**UR'SINE**, *a.* [L. *ursinus*.] Pertaining to or resembling a bear.

**UR'SULINE**, *a.* Denoting an order of nuns who observe the rule of St. Austin; so called from their institutress, St. Ursula. They devote themselves to the succour of poverty and sickness, and the education of the young. Used also as a noun.

**UR'SUS**, [L.] The bear; a genus of plantigrade carnivorous mammals, found in various parts of the world. Various species are known, as the *U. arctos*, the brown European bear; *U. Americanus*, the North American black bear; *U. ferox*, the grisly bear; *U. maritimus*, the polar bear; *U. thibetanus*, the Thibet bear; *U. malayanus*, the Malayan bear; *U. labiatus*, the thick-lipped bear of the East Indies, &c. [See BEAR.]

**URTY-ÇA**, *n.* A genus of plants known under the common name of nettle. The effects of the venomous sting of the common nettles are well known. They are, however, not to be compared with those of some Indian species, as *U. heterophylla*, *Crenulata*, and *Stimulans*. The most important species is *U. tenacissima*, which abounds in ligneous fibre, and may be converted into very strong cordage. [See NETTLE.]

**URTICA'CEÆ**, *n.* A nat. order of incomplete dicotyledons, consisting of trees, shrubs, and herbs, yielding, in some instances, a milky juice. They are widely dispersed over every part of the world. The species are very numerous, many of them being mere weeds, whilst others are large trees yielding useful and delicious fruits. To this order belong the nettles, the poisonous *upas tree*, the fig, the banyan, hop, mulberry, the bread-fruit, the cow tree, &c.

**URTICA'RIA**, *n.* [L. *urtica*, a nettle.] In *med.*, the nettle rash; uredo.

**URTICA'TION**, *n.* [L. *urtica*, a nettle.] The whipping of a benumbed or paralytic limb with nettles, in order to restore its feeling.

**URUS**, *n.* [L. *urus*.] 1. The wild bull.—2. In *nat. hist.*, the trivial or specific name of the species of *Bos* or *Taurus* to which the common bull, or ox and cow, are considered to belong. In its wild state it formerly inhabited the central parts of Europe, and was a

perfectly wild, savage, and untameable animal. According to ancient accounts, it was an animal of great size, with large, spreading, and acute horns. Some naturalists consider what they call the *Bos Scoticus*, or wild bull of Scotland, still preserved in a few parks, as belonging to this genus, but this animal is evidently a variety of the domestic ox.

UR'VANT, } In *her.*, turned or bowed  
UR'VED, } upwards.

U. S., } An abbreviation of the words  
U. S. A. } *United States of America.*

US, *pron.* objective case of *We*.  
Give us this day our daily bread.

*Lord's Prayer.*

US'ABLE, *a.* (*s* as *z*.) That may be used.

US'AGE, *n.* (*s* as *z*.) [Fr. from *user*, to use. See *USE*.] 1. Treatment; an action or series of actions performed by one person toward another, or which directly affect him; as, good *usage*; ill *usage*; hard *usage*. Gentle *usage* will often effect what harsh *usage* will not. The elephant may be governed by mild *usage*.—2. Use, or long continued use; custom; practice. Uninterrupted *usage* for a long time, or immemorial *usage* constitutes prescription. Custom is a local *usage*; prescription is a personal *usage*. *Usage*, however, differs both from custom and prescription; no man may claim a rent, common, or other inheritance by *usage*, though he may by prescription. [See *PRESCRIPTION*.] In language, *usage* is the foundation of all rules.

Of things once received and confirmed by use, long *usage* is a law sufficient.

*Hooker.*

3 † Manners; behaviour.

US'AGER, † *n.* (*s* as *z*.) [Fr.] One who has the use of any thing in trust for another.

US'ANCE, *n.* (*s* as *z*.) [Fr.] Use; proper employment.—2. Usury; interest paid for money.—3. In *com.*, a determinate time fixed for the payment of bills of exchange, reckoned either from the day of their date, or the day of their acceptance. It is thus called because this time is settled by *usage*, or the custom of places on which the bills are drawn. In France, the *usage* for bills drawn from Spain and Portugal is sixty days. At London, the *usage* for bills drawn from Holland, Germany, or France, is one month. The *usage* is very different in different countries and cities. *Double, treble, and half usage*, are terms implying corresponding alterations on the usual period.

USE, *n.* [L. *usus*; It. *uso*; Fr. *us*, plur.] 1. The act of handling or employing in any manner, and for any purpose, but especially for a profitable purpose; as, the use of a pen in writing; the use of books in study; the use of a spade in digging. *Use* is of two kinds; that which employs a thing without destroying it or its form, as the use of a book or of a farm; or it is the employment of a thing which destroys or wastes it, as the use of bread for provision; the use of water for turning a mill.—2. Employment; application of any thing to a purpose, good or bad. It is our duty to make a faithful use of our opportunities and advantages for improvement.

Books can never teach the use of books.

*Bacon.*

3. Usefulness; utility; advantage; pro-

duction of benefit. The value of a thing is to be estimated by its *use*. His friendship has been of use to me.

'Tis use alone that sanctifies expense. *Pope.*

4. Need of employment, or occasion to employ. I have no further use for this book.—5. Power of receiving advantage. [*Unusual.*—6. Continued practice or employment. Sweetness, truth, and every grace, Which time and use are wont to teach.

*Wallers.*

7. Custom; common occurrence.

O Cesar, these things are beyond all use.

[*Unusual.*—*Shak.*

8. Interest; the premium paid for the possession and employment of borrowed money.—9. In *law*, the benefit or profit of lands and tenements. *Use* imports a trust and confidence reposed in a man for the holding of lands. He to whose use or benefit the trust is intended, shall enjoy the profits. All modern conveyances are directly or indirectly founded on the doctrine of *uses and trusts*, which has been deemed the most intricate part of the property law of England. Uses and trusts, being acts of confidence reposed, are cognizable in equity, when coupled with the performance of any act tending to the benefit of the party for whose enjoyment the use or trust was created.

*Uses*, as a term, is applied to lands of inheritance, and the party to whose use they are conveyed has the absolute possession; as if land is conveyed to A, to the use of B, B has by law the possession vested in him; but if land be conveyed to A, to the use of B in trust, to permit C to enjoy and receive the profits of the land, B has the *legal*, C the *equitable* estate; the law transferring the use into possession, or as is the more common mode, land is conveyed to A, to the use of A, in trust for B and his heirs, or to permit B to occupy, &c. Uses only apply to land of inheritance; no use can subsist of leaseholds.—*Statute of uses*, the Stat. 27 Henry VIII. cap. 10, which transfers uses into possession, or which unites the use and possession.—*Cestuy que use*, in law, the person who has the use of lands and tenements.—*Executed use*, one to which the statute applies by annexing it to the legal ownership.—*Springing use*, one limited to arise on a future event, where no preceding use is limited.—*Future or contingent use*, one limited to a person not ascertained, or upon an uncertain event, but without derogation of an use previously limited.—*Resulting use*, is one which, being limited by the deed, expires or cannot vest, and results or returns to him who raised it, after such expiration.—*Secondary or shifting use*, is that which, though executed, may change from one to another by circumstances.—*In use*, in employment; as, the book is now *in use*.—2. In customary practice or observance. Such words, rites, and ceremonies, have long been *in use*.

USE, *v. t.* (*s* as *z*.) [Fr. *user*; It. *usare*; L. *utor, usus*; Gr. *ἔω.*] 1. To employ; to handle, hold, occupy, or move for some purpose; as, to use a plough; to use a chair; to use a book; to use time. Most men use the right hand with more convenience than the left, and hence its name, *right*.—2. To waste, consume or exhaust by employment; as, to use flour for food; to use beer for drink; to use water for irrigation, or for turning the wheel of a mill.—

1145

3. To accustom; to habituate; to render familiar by practice; as, men used to cold and hunger; soldiers used to hardships and danger.—4. To treat; as, to use one well or ill; to use people with kindness and civility; to use a beast with cruelty.

Cato has us'd me ill.

*Addison.*

5. To practice customarily.

Use hospitality one to another; 1 Pet. iv.

To use one's self; to behave.

USE, *v. i.* (*s* as *z*.) To be accustomed; to practice customarily.

They use to place him that shall be their captain on a stone.

*Spenser.*

2. To be wont.

Fears used to be represented in an imaginary fashion.

*Bacon.*

3. To frequent; to inhabit.

Where never foot did use.

*Spenser.*

USED, *pp.* (*s* as *z*.) Employed; occupied; treated.

USEFUL, *a.* Producing or having power to produce good; beneficial; profitable; helpful toward advancing any purpose; as, vessels and instruments useful in a family; books useful for improvement; useful knowledge; useful arts.

USEFULLY, *adv.* In such a manner as to produce or advance some end; as, instruments or time usefully employed.

USEFULNESS, *n.* Conduciveness to some end, properly to some valuable end; as, the usefulness of canal navigation; the usefulness of machinery in manufactures.

USELESS, *a.* Having no use; unserviceable; producing no good end; answering no valuable purpose; not advancing the end proposed; as, a useless garment; useless pity.

USELESSLY, *adv.* In a useless manner; without profit or advantage.

USELESSNESS, *n.* Unserviceableness; unfitness for any valuable purpose, or for the purpose intended; as, the uselessness of pleasure.

USER, *n.* (*s* as *z*.) One who uses, treats, or occupies.

USH'ER, *n.* [Fr. *huissier*, a door-keeper, from *huis*, It. *uscio*, a door.] 1. Properly, an officer or servant who has the care of the door of a court, hall, chamber, or the like; hence, an officer whose business is to introduce strangers or to walk before a person of rank. In the king's household there are four gentlemen-ushers of the privy chamber. There is also an usher of the exchequer, who attends the barons, sheriffs, juries, &c.—*Gentlemen usher of the black rod*, the eldest of the gentlemen ushers who are daily waiters at court. During the sessions of parliament, he attends the house of peers. His badge is a black rod, with a lion in gold at the top. This rod has the authority of a mace; and to the custody of this officer all peers subjected to question for any crime are first committed. He also bears the rod before the sovereign at the feast of St. George and other solemnities.—2. An under-teacher or assistant to a schoolmaster or principal teacher, so denominated, probably, because he is entrusted with the junior classes, and introduces them to the higher branches of learning.

USH'ER, *v. t.* To introduce, as a fore-runner or harbinger; to forerun.

The stars that usher evening, rose. *Milton.*

The Examiner was ushered into the world by a letter, setting forth the great genius of the author.

*Addison.*

USH'ERANCE, † *n.* Introduction.  
 USH'ERDOM, *n.* The functions or power of ushers. [*Trivial.*]  
 USHERED, *pp.* Introduced.  
 USHERING, *ppr.* Introducing, as a forerunner.  
 USHERSHIP, *n.* Office of an usher.  
 US'KY, † *n.* [From *Usquebaugh.*] Whisky.  
 US'NEA, *n.* [Ar. *achneh*, a general name for lichens.] A genus of plants, nat. order Lichens. The species are branched and filiform in their structure, and *U. florida*, *hirta*, and *plicata*, yield a substance called usnine or usnic acid, which acts a conspicuous part by its metamorphoses and combinations in the alterations of colour of many lichens.  
 US'NINE, } *n.* A substance yielded  
 US'NIC ACID, } by lichens, of the genus Usnea, Parmelia Lecidea, &c. [See USNEA.]  
 USQUEBAUGH, *n.* [Fr. *uisge*, water, and *baqh*, life.] A compound distilled spirit, made in greatest perfection at Drogheda in Ireland. The term *usquebaugh* is applied technically to a strong compound spirit, consisting of an infusion of brandy, liquorice, raisins, cinnamon, nutmeg, aniseed, citron, thyme, rosemary, sugar candy, and other ingredients. It is chiefly taken as a dram. From this word, by contraction, we have *whisky*.  
 US'ILA'GO, *n.* A genus of fungi; smnt  
 US'TION, *n.* [Fr. *ustion*; L. *ustio*, from *uro*, *ustus*, to burn.] The act of burning; the state of being burnt.  
 US'TORIOUS, *a.* [supra.] Having the quality of burning.  
 US'TULAT'ION, *n.* [L. *ustulatus.*] 1. The act of burning or searing.—2. In *metallurgy*, ustulation is the operation of expelling one substance from another by heat, as sulphur and arsenic from ores, in a muffle.—3. In *pharmacy*, an old term for the roasting or drying of moist substances so as to prepare them for pulverizing; also, the burning of wine.  
 USUAL, *a.* (*s* as *z.*) [Fr. *usuel*; from *use*.] Customary; common; frequent; such as occurs in ordinary practice, or in the ordinary course of events. Earthquakes are not *usual* in this country.  
 Consultation with oracles was formerly a thing very *usual*. *Hooker.*  
 USUALLY, *adv.* (*s* as *z.*) Commonly; customarily; ordinarily. Men *usually* find some excuse for their vices. It is *usually* as cold in North America in the fortieth degree of latitude, as it is in the west of Europe in the fiftieth.  
 USUALNESS, *n.* (*s* as *z.*) Commonness; frequency.  
 USUCAP'TION, *n.* [L. *usus*, use, and *capio*, to take.] In the *civil law*, the same as *prescription* in the common law; the acquisition of the title or right to property by the uninterrupted and undisputed possession of it for a certain term prescribed by law.  
 USUF'RUCT, *n.* [L. *usus*, use, and *fructus*, fruit.] The temporary use and enjoyment of lands or tenements; or the right of receiving the fruits and profits of lands or other thing, without having the right to alienate or change the property.  
 USUF'RUCTUARY, *n.* A person who has the use and enjoyment of property for a time, without having the title or property.  
 USURE, † *v. i.* (*s* as *z.*) To practice usury.

USURER, *n.* (*s* as *z.*) [See USURY.] Formerly, a person who lent money and took interest for it.—2. In *present usage*, one who lends money at a rate of interest beyond that established by law.  
 USURIOUS, *a.* (*s* as *z.*) Practising usury; taking exorbitant interest for the use of money; as, a *usurious* person.—2. Partaking of usury; containing usury; as, a *usurious* contract, which by statute is void  
 USURIOUSLY, *adv.* In a usurious manner.  
 USURIOUSNESS, *n.* The state or quality of being usurious.  
 USURP', *v. t.* (*s* as *z.*) [Fr. *usurper*; L. *usurpo*.] To seize and hold in possession by force or without right; as, to *usurp* a throne; to *usurp* the prerogatives of the crown; to *usurp* power. To *usurp* the right of a patron, is to oust or dispossess him.  
 Vice sometimes *usurps* the place of virtue. *Denham.*  
 [Usurp is not applied to common dis-possession of private property.]  
 USURPA'TION, *n.* [supra.] The act of seizing or occupying and enjoying the property of another, without right; as, the *usurpation* of a throne; the *usurpation* of the supreme power.  
*Usurpation*, in a peculiar sense, denotes the absolute ouster and dispossession of the patron of a church, by presenting a clerk to a vacant benefice, who is thereupon admitted and instituted.  
 USURP'ATORY, *a.* Usurping; marked by usurpation.  
 USURP'ED, *pp.* Seized or occupied and enjoyed by violence, or without right.  
 USURP'ER, *n.* One who seizes or occupies the property of another without right; as, the *usurper* of a throne, of power, or of the rights of a patron.  
 USURP'ING, *ppr.* Seizing or occupying the power or property of another without right.  
 The worst of tyrants an *usurping* crowd. *Pope.*  
 USURP'INGLY, *adv.* By usurpation; without just right or claim.  
 USURY, *n.* (*s* as *z.*) [Fr. *usure*; L. *usura*, from *utor*, to use.] 1. Formerly, interest; or a premium paid or stipulated to be paid for the use of money. [Usury formerly denoted any legal interest, but in this sense, the word is no longer in use.]—2. In *present usage*, illegal interest; a premium or compensation paid or stipulated to be paid for the use of money borrowed or retained, beyond the rate of interest established by law. In this country, the legal interest was fixed by the Act 12 Ann, at 5 per cent., and all contracts made for the payment of any principal to be lent on usury above this rate were to be held utterly void. Usurious bargains, or rather loans *morally* usurious, are often protected by lending the money upon contingency, as annuities, or making the repayment to depend upon certain lives being in existence at a particular time. The usury laws have been relaxed by several recent statutes, and bills of exchange not having more than 12 months to run, and contracts for loans or forbearance of money above 10 pounds are no longer affected by those laws. But 5 per cent. remains the legal interest recoverable on all contracts unless otherwise specified.—3. † The practice of taking interest.

U'SUS LOQUEN'DI, [L.] The usual mode of speaking; the usage or custom of speech.  
 UT, the first note in Guido's musical scale, now usually superseded by *Do*.  
 UTEN'SIL, *n.* [Fr. *utensile*. This seems to be formed on the participle of the L. *utor*.] An instrument; that which is used; particularly, an instrument or vessel used in a kitchen, or in domestic and farming business.  
 U'TERINE, *a.* [Fr. *uterin*; L. *uterinus*, from *uterus*.] Pertaining to the womb; as, *uterine* complaints. *Uterine* brother or sister, is one born of the same mother, but by a different father.  
 UTEROGESTA'TION, *n.* Gestation in the womb from conception to birth.  
 U'TERUS, *n.* [L.] The womb.  
 U'TILE, *a.* [L.] Profitable; useful.  
 U'TILE DULCI. [L.] The useful with the agreeable.  
 UTILITA'RIAN, *a.* Consisting in or pertaining to utility; pertaining to utilitarianism.  
 UTILITA'RIAN, *n.* One who holds the doctrine of utilitarianism.  
 UTILITA'RIANISM, *n.* The doctrine that the greatest happiness of the greatest number should be the end and aim of all social and political institutions. This doctrine was propounded and inculcated by the celebrated Jeremy Bentham. The utilitarians, for the most part, confine the proposed utility so as to restrict it to that which is useful for the material and economical well being of the multitude.—2. The term has also been applied to the doctrine of Hume, that utility is the sole standard of moral conduct; or that every thing is right which appears to be useful; irrespective of the declarations of scripture.—3. The term has also sometimes been applied to the doctrine that virtue is founded in utility.  
 UTIL'ITY, *n.* [Fr. *utilité*; L. *utilitas*, from *utor*, to use.] Usefulness; production of good; profitableness to some valuable end; as, the *utility* of manures upon land; the *utility* of the sciences; the *utility* of medicines.  
 UTILIZA'TION, *n.* A making profitable; a gaining. [American.]  
 UTILIZE, *v. t.* [It. *utilizzare*; Sp. *utilizar*; from *utile*, *util*, useful.] 1. To gain profit; to acquire.—2. To turn to profitable account or use. [American.]  
 U'TILIZED, *pp.* Made profitable. [American.]  
 UTILIZING, *ppr.* Rendering profitable; gaining. [American.]  
 U'TI POSSIDE'TIS, [L. as you possess.] An interdict of the Roman law as to heritage, ultimately assimilated to the interdict *ut rubi*, as to movables, whereby the colourable possession of a *bona fide* possessor is continued until the final settlement of a contested right.—2. In *politics*, the basis or principle of a treaty which leaves belligerent parties in possession of what they have acquired by their arms during the war.  
 U'TIS, † *n.* [Fr. *huit*.] 1. The octave of a legal term or of any festival, also the festival itself.—2. † Bustle; stir; unrestrained jollity or festivity.  
 U'TMOST, *a.* [Sax. *utmost*, *utmost*; *ut* out, and *most*, most; that is, to the outermost point.] 1. Extreme; being at the furthest point or extremity; as, the *utmost* limit of North America; the *utmost* limits of the land; the *ut-*

most extent of human knowledge.—2. Being in the greatest or highest degree; as, the *utmost* assiduity; the *utmost* harmony; the *utmost* misery or happiness; the *utmost* peril.

**UT'MOST**, *n.* The most that can be; the greatest power, degree, or effort. He has done his *utmost*. Try your *utmost*.

I will be free

Even to the *utmost* as I please in words.

*Shak.*

**UTO'PIA**, *n.* [from Gr. *ευωπια*, no place.] A term invented by Sir Thomas More, and applied by him to an imaginary island, which he represents in his celebrated work (called also *Utopia*) as enjoying the utmost perfection in laws, politics, &c., in contradistinction to the defects of those which then existed. Hence,—2. A state of ideal perfection.

**UTO'PIAN**, *a.* [from More's *Utopia*.] Ideal; chimerical; fanciful; not well founded.

**UTO'PIANISM**, *n.* Chimerical schemes in theory or practice.

**UTO'PICAL**, *† a.* Utopian.

**UT'RICLE**, *n.* [L. *utriculus*, a little bag or bottle.] 1. A little bag or bladder; a little cell; a reservoir in plants to receive the sap.—2. A term applied to a one-celled, one or few seeded, superior, membranous, inflated, and indelhiscent fruit, as in *Chenopodium*. The term *primordial* or *primary* utricle is applied to the fruit cell of the embryo.

**UT'RIC'ULAR**, *a.* Containing utricles; furnished with glandular vessels like small bags, as plants.

**UTRICULA'RIA**, *n.* A genus of aquatic plants, nat. order Lenticulaceae. It is distinguished by the calyx having two equal leaves, a perianth spurred corolla, a two-lipped stigma, a globose capsule of one cell, and several seeds fixed to a central receptacle. Three species have been described, all natives of Great Britain, and known by the common name of bladder-wort. They grow in ditches and pools. The metamorphosed leaves attached to the roots are furnished with little bladders.

**UTRIC'ULUS**, *n.* In bot. [See **UTRICLE**.]

**UT'TER**, *a.* [Sax.; that is, *outer*.] Situated on the outside or remote from the centre.—2. Placed or being beyond any compass; out of any place; as, the *utter* deep.—3. Extreme; excessive; utmost; as, *utter* darkness.—4. Complete; total; final; as, *utter* ruin.—5. Peremptory; absolute; as, an *utter* refusal or denial.—6. Perfect; mere; quite; as, *utter* strangers.—*Utter* barrister, a recently admitted barrister-at-law, who was accustomed to plead without the bar; as distinguished from the *benchers*, who were permitted to plead within the bar.

**UT'TER**, *v. t.* To speak; to pronounce; to express; as, to *utter* words; to *utter* sounds.—2. To disclose; to discover; to divulge; to publish. He never *utters* a syllable of what I suppose to be intended as a secret.—3. To sell; to vend; as, to *utter* wares. [*This is obsolete, unless in the law style.*]—4. To put or send into circulation; to put off, as currency, or cause to pass in commerce; as, to *utter* coin or notes. A man *utters* a false note, who gives it in payment, knowing it to be false.

**UTTERABLE**, *a.* That may be uttered, pronounced, or expressed.

**UT'TERANCE**, *n.* The act of uttering words; pronunciation; manner of speaking; as, a good or bad *utterance*.

They began to speak with other tongues, as the Spirit gave them *utterance*; Acts ii.

2. Emission from the mouth; vocal expression; as, the *utterance* of sounds.—3. *†* [Fr. *outrance*.] Extremity; furthest part.

**UTTERED**, *pp.* Spoken; pronounced; disclosed; published; put into circulation.

**UTTERER**, *n.* One who utters; one who pronounces.—2. One who divulges or discloses.—3. One who puts into circulation.—4. A seller; a vender.

**UTTERING**, *ppr.* Pronouncing; disclosing; putting into circulation; selling.

**UTTERLY**, *adv.* To the full extent; fully; perfectly; totally; as, *utterly* tired; *utterly* debased; *utterly* lost to all sense of shame; it is *utterly* vain; *utterly* out of my power.

**UT'TERMÖST**, *a.* [*utter* and *most*.] Extreme; being in the furthest, greatest, or highest degree; as, the *uttermost* extent or end; the *uttermost* distress.

**UT'TERMÖST**, *n.* The most that can be; the greatest power, degree, or effort; that beyond which nothing is. The *uttermost* we can do is to be patient.—*To the uttermost*, in the most extensive degree; fully; Heb. vii.

**U'VA UR'SI**, *n.* The *arctostaphylos uva ursi*, (*arbutus uva ursi*, Linn.) called also red bear-berry, bear's whortleberry; nat. order, Ericaceae. It is a native of Britain, and grows in dry heaths. The whole plant is highly astringent, and the leaves have been employed in cases of stone and of mucous discharges from the bladder. The berries are eaten in the Highlands of Scotland.

**U'VEA**, *n.* [L. *uva*, an unripe grape.] The black pigment on the back part of the iris; so called by the ancients, because in beasts, which the ancients chiefly dissected, it resembles an unripe grape.

**U'VEOUS**, *a.* [L. *uva*, a grape.] Resembling a grape or a bunch of grapes.—2. Pertaining to the *uvea*, or black pigment on the back part of the iris.

**U'VULA**, *n.* [L.] The small conical fleshy substance which projects from the middle of the soft palate, and hangs over the root of the tongue. It is composed of the common integuments of the mouth, and a small muscle resembling a worm, by the contraction of which the uvula is elevated. It serves to fill up the gap which remains between the arches of the palate.

**U'VULA SPOON**, *n.* A surgical instrument like a spoon, to be held just under the uvula, for the purpose of conveying any substance into the cavity behind.

**UXO'RIOUS**, *a.* [L. *uxorius*, from *uxor*, wife.] Submissively fond of a wife.

**UXO'RIOUSLY**, *adv.* With fond or servile submission to a wife.

**UXO'RIOUSNESS**, *n.* Connubial dotage; foolish fondness for a wife.

**UZEMA**, *n.* A linear measure in the Birman empire; it is about twelve statute miles.

## V.

**V** IS the twenty-second letter of the English Alphabet, and a labial articulation, formed by the junction of the upper teeth with the lower lip, as in pronouncing *av*, *ev*, *ov*, *vain*. It is not a close articulation, but one that admits of some sound. It is nearly allied to *f*, being formed by the same organs; but *v* is vocal, and *f* is aspirate, and this constitutes the principal difference between them. *V* and *u* were formerly the same letter, derived no doubt from the Oriental *vau* or *vauv*, but they have now as distinct uses as any two letters in the alphabet, and are therefore to be considered as different letters. The Roman letter *v* was probably pronounced as a *w*, a supposition which would explain the fact that in the alphabet of that language one character is employed for both *u* and *v*. *V* has one sound only,

as in *vary*, *vote*, *lavish*.—As a numeral, *V* stands for 5. With a dash over it, in old books, *V̄*, it stands for 5000. *V. R.*, among the Romans, stood for *uti rogas*, as you desire; *V. C.* for *vir consularis*; *V. G.* for *verbi gratia*; *V. L.* for *videlicet*. In modern abbreviations, *V.* stands for *vide*, see; also for *verb*, or *verse*; *viz.* for *videlicet*, that is to say, namely. In music for instruments, *V.* stands for *violin*; *V. V.* for *violins*. *V. S.* for *volta subito*, turn over quickly. In *her.*, *V.* is used to express *vert* or *green*, in the tricking or drawing of arms with a pen and ink.

**VA.** [It.] In *music*, a term employed as a direction to proceed; as, *va crescendo*, go on increasing.

**VA'CANCE**, } [Fr. *vacances*.] Mid-  
**VA'CANCIES**, } summer holidays, in a public school. [*Scotch.*]

**VA'CANCY**, *n.* [L. *vacans*, from *vaco*,

to be empty; Fr. *vacance*; Sp. *vacancia*; W. *gwag*; Heb. *בָּהָק*, to empty.] 1. Empty space; vacuity. [In this sense, *vacuity* is now generally used.]—2. Chasm; void space between bodies or objects; as, a *vacancy* between two beams or boards in a building; a *vacancy* between two buildings; a *vacancy* between words in a writing.—3. The state of being destitute of an incumbent; want of the regular officer to officiate in a place. Hence also it signifies the office, post, or benefice which is destitute of an incumbent; as, a *vacancy* in a parish; *vacancies* in the treasury or war office. There is no *vacancy* on the bench of the supreme court.—4. Time of leisure; freedom from employment; intermission of business.

Those little *vacancies* from toils are sweet.  
*Dryden.*

5. Listlessness; emptiness of thought.—6. A place or office not occupied, or destitute of a person to fill it; as, a *vacancy* in a school.

VA'CANT, *a.* [Fr.; from *L. vacans*.] 1. Empty; not filled; void of every substance except air; as, a vacant space between houses; *vacant room*.—2. Empty; exhausted of air; as, a *vacant* receiver.—3. Free; unincumbered; unengaged with business or care.

Philosophy is the interest of those only who are *vacant* from the affairs of the world. *More.*

4. Not filled or occupied with an incumbent or possessor; as, a *vacant* throne; a *vacant* parish.—5. Being unoccupied with business; as, *vacant* hours; *vacant* moments.—6. Empty of thought; thoughtless; not occupied with study or reflection; as, a *vacant* mind.—7. Indicating want of thought or of intelligence.

The duke had a pleasant and *vacant* face. *Wotton.*

8. In *law*, abandoned; having no heir; as, *vacant* effects or goods.

VA'CANTE, *v. t.* To annul; to make void; to make of no authority or validity; as, to *vacate* a commission; to *vacate* a charter.

The necessity of observing the Jewish sabbath was *vacated* by the apostolical institution of the Lord's day. *Nelson.*

2. To make vacant; to quit possession and leave destitute. It was resolved by parliament that James had *vacated* the throne of England.—3. To defeat; to put an end to.

He *vacates* my revenge. [*Unusual.*] *Dryden.*

VA'GATED, *pp.* Annulled; made void; made vacant.

VA'GATING, *ppr.* Making void; making vacant.

VACA'TION, *n.* [Fr. from *L. vacatio*.]

1. The act of making void, vacant, or of no validity; as, the *vacation* of a charter.—2. Intermission of judicial proceedings; the space of time between the end of one term and the beginning of the next; non-term.—3. The intermission of the regular studies and exercises of a university, a college, or other seminary, when the students have a recess.—4. Intermission of a stated employment.—5. The time when a see or other spiritual dignity is vacant.

During the *vacation* of a bishoprick, the dean and chapter are guardians of the spiritualities. *Cyc.*

6. Leisure; freedom from trouble or perplexity. [*Now little used.*]

VAC'GARY, } *n.* [*L. vacca*, a cow.]

VAC'GHARY, } An old word signifying a cow house, dairy house, or a cow pasture.

VACCINA'CEÆ, *n.* A nat. order of monopetalous exogens, consisting of shrubby plants, with aqueous juices, round or angled stems and branches, alternate simple leaves, with a solitary or racemose inflorescence, the flowers regular and united; the fruit is a berry, four or five-celled, few or many seeded. The species are natives of North America, where they are abundant; in Europe they occur sparingly, but they are not uncommon on high land in the Sandwich Islands. The properties of the order closely resemble those of Ericaceæ. The bark and leaves of many of the species are astringent, slightly tonic, and stimulating. The berries of many are eaten under the names of cranberry, bilberry, whortleberry, &c. Several species are elegant

garden shrubs; as those belonging to the genus *Gaylussacia*.

VAC'GINATE, *v. t.* [*L. vacca*, a cow.] To inoculate with the cow-pox, or a virus taken from cows, called *vaccine* matter. *Cow-pox* is *small pox*, modified by affecting a cow.

VAC'GINATED, *pp.* Inoculated with the cow-pox.

VAC'GINATING, *ppr.* Inoculating with the cow-pox.

VAC'GINATION, *n.* The act, art, or practice of inoculating persons with the cow-pox, for the purpose of securing them from the contagion of small-pox. Dr. Jenner was the first who showed that the cow-pox could be propagated by inoculation, and that the inoculated disease acted as a preservative against the attacks of small-pox. It has been found that vaccination, in a great majority of instances, confers a complete and permanent security against small-pox, and that in those cases where the small-pox does occur after vaccination, it is generally divested of its formidable characters, and constitutes a comparatively mild disease. [*See Cow-pox.*]

VAC'GINATOR, } *n.* One who inocu-

VAC'GINIST, } lates with the cow-pox.

VAC'GINE, *a.* [*L. vaccinus*, from *vacca*, a cow.] Pertaining to cows; derived from cows; as, the *vaccine* disease or cow-pox.

VACCIN'TUM, *n.* A genus of plants belonging to the nat. order Vaccinaceæ, of which it is the type. The species, of which about 50 have been described, are shrubs, producing berries which are generally eatable, and are known by the common names of bilberries, whortleberries, blaberries, &c. The following are natives of Britain: *V. myrtillus*, the common bilberry or blaeberry; *V. uliginosum*, great bilberry, or bog whortleberry; *V. vitis-idaea*, red whortleberry or cow-berry; *V. oxycoccus*, marsh whortleberry or cranberry, the berries of which made into tarts are much esteemed. *V. stamineum*, green-wooded whortleberry; *V. corymbosum*, naked flowering whortleberry; and *V. frondosum*, blunt-leaved whortleberry, are natives of America.

VACH'ERY, *n.* [Fr. *vache*, a cow.] A pen or inclosure for cows.

VAC'ILLANCY, *n.* [*L. vacillans*, from *vacillo*, to waver, Eng. to *waggle*, from the root of *wag*,—*which see.*] A state of wavering; fluctuation; inconstancy.

VAC'ILLANT, *a.* [*supra.*] Wavering; fluctuating; unsteady.

VAC'ILLATE, *v. t.* [*L. vacillo*; *G. wacheln*; Eng. to *waggle*, a diminutive of *wag*. *See WAG.*] 1. To waver; to move one way and the other; to reel or stagger.—2. To fluctuate in mind or opinion; to waver; to be unsteady or inconstant.

VAC'ILLATING, *ppr.* Wavering; reeling; fluctuating.—2. *a.* Unsteady; inclined to fluctuate.

VAC'ILLATINGLY, *adv.* Unsteadily.

VACILLA'TION, *n.* [Fr. from *L. vacillatio*.] 1. A wavering; a moving one way and the other; a reeling or staggering.—2. Fluctuation of mind; unsteadiness; change from one object to another.

VAC'UATE, *v. t.* To make empty; to evacuate.

VACUA'TION, *n.* [*L. vacuo*.] The act of emptying. [*Little used.*] [*See EVACUATION.*]

VAC'UIST, *n.* [from *vacuum*.] One who holds to the doctrine of a vacuum in nature: opposed to a *plenist*.

VACU'ITY, *n.* [*L. vacuitas*, from *vacuus*.]

1. Emptiness; a state of being unfilled. Hunger is such a state of *vacuity* as to require a fresh supply. *Arbuthnot.*

2. Space unfilled or unoccupied, or occupied with an invisible fluid only.

A *vacuity* is interspersed among the particles of matter. *Bentley.*

3. Emptiness; void.

God only can fill every *vacuity* of the soul. *Rogers.*

—5. Vacuum,—*which see.*

VAC'UOUS, *a.* Empty; unfilled; void.

VAC'UOUSNESS, *n.* The state of being empty.

VAC'UUM, *n.* [*L.*] Space empty or devoid of all matter or body. Whether there is such a thing as an absolute *vacuum* in nature, is a question which has been much controverted. The existence of a vacuum was maintained by the Pythagoreans, Epicureans, and Atomists; but it was denied by the Peripatetics, who asserted that 'nature abhors a vacuum.' Descartes also denied the possibility of a vacuum, maintaining that the essence of matter consists in extension. Some philosophers have supposed that all space beyond the atmosphere of the earth and other planets, is filled with an ethereal fluid, far more fine and subtle than air. This latter opinion receives some countenance from recent observations. It has been all but proved that a comet undergoes precisely the same sort of changes in its mean motion, which would be produced if the body moved in a medium which offered a small resistance to its motion. The undulatory theory of light which is now pretty generally received, also furnishes an argument against the existence of a vacuum, for according to this theory the whole of the celestial spaces are filled with a medium of great elasticity. The term *vacuum*, is generally used to denote the interior of a close vessel, from which the atmospheric air, and every other gas have been extracted. Thus, in experiments with the air pump, the interior of the glass receiver, after the air has been extracted by the machine, is termed a vacuum. In this case, however, the vacuum is not perfect, for from the very nature of the machine, some air must always remain in the receiver, however long the exhausting process may be continued. The most perfect vacuum which can be produced artificially is the *torricellian vacuum*, or the space above the mercury in the barometer tube, but even here the vacuum is not absolutely perfect, for although the air may be entirely excluded from the space above the mercury, there is always an atmosphere of the vapour of mercury.—*In vacuo*, in a vacuum.

VADE,† *v. i.* [*L. vado*.] To vanish; to pass away.

VAD'E ME'ËUM, *n.* [*L. go with me.*] A book or other thing that a person carries with him as a constant companion; a manual or book of entertainment.

VAD'DIUM, *n.* [from *L. vas, vadis*, surety, bail.] In *Scots law*, a wad or pledge.

VAF'ROUS, *a.* [*L. vafser*.] Crafty; cunning.

VAG'ABOND, *a.* [*L. vagabundus*, from *vagor*, to wander; from the root of

*vag.*] 1. Wandering; moving from place to place without any settled habitation; as, a *vagabond* exile.—2. Wandering; floating about without any certain direction; driven to and fro. Like to a *vagabond* flag upon the stream.

*Shak.*

**VAG'ABOND, n.** [*supra.*] A vagrant; one who wanders from town to town or place to place, illegally, having no certain dwelling, or not abiding in it, and usually without the means of honest livelihood. By the law, *vagabonds* are liable to be taken up and punished.

[*See VAGRANT.*]

**VAG'ABONDAGE, n.** A state of wandering; **VAG'ABONDISM, } dering about in**  
**VAG'ABONDRY, } idleness.**

**VAG'ABONDIZE, v. t.** To wander about in idleness.

**VAGARIOUS, a.** Having vagaries; whimsical; capricious. [*Colloquial.*]

**VAGARY, n. plur.** *Vagaries.* [*Lat. vagus, wandering.*] A wandering of the thoughts; a wild freak; a whim; a whimsical purpose.

They chang'd their minds,

Flew off, and into strange *vagaries* fell.

*Milton.*

**VAGARY, † v. i.** To gad; to range.

**VAG'IENT, † a.** [*L. vagiens.*] Crying like a child.

**VAG'INA, n.** [*L. a sheath.*] In *anat.*, the canal leading from the external orifice to the uterus or womb.—2. In *bot.*, the sheath formed by the convolution of a flat petiole round a stem, as in grasses.

**VAG'INAL, a.** [*L. vagina, a sheath.* *See VAIN.*] 1. Pertaining to a sheath, or resembling a sheath; as, a *vaginal* membrane.—2. In *anat.*, pertaining to the vagina.

**VAG'INANT, a.** [*L. vagina.*] In *bot.*, sheathing; as, a *vaginant* leaf, one investing the stem or branch by its base, which has the form of a tube.

**VAG'INATE, } a.** In *bot.*, sheathed;

**VAG'INATED, } invested by the tubular base of the leaf; as a stem.**

**VAGINOPE'NOUS, a.** [*L. vagina and penna.*] Sheath-winged; having the wings covered with a hard case or sheath, as some insects.

**VAG'OUS, a.** [*L. vagus; Fr. vague.*] Wandering; unsettled. [*Little used.*]

**VAG'GRANCY, n.** [*from vagrant.*] A state of wandering without a settled home; the life and condition of wandering beggars, rogues, vagabonds, fortune-tellers and other impostors, reputed thieves, persons breaking out of legal confinement, &c.—2. In *law*, the name given to a very miscellaneous class of offences against public, police, and order. [*See VAGRANT.*]

**VAG'GRANT, a.** [*L. vagor.*] 1. Wandering from place to place without any settled habitation; as, a *vagrant* beggar.—2. Wandering; unsettled; moving without any certain direction.

That beauteous Emma *vagrant* courses took.

*Prior.*

**VAG'GRANT, n.** [*Norm. vagarant.*] An idle wanderer; a vagabond; one who strolls from place to place; a sturdy beggar; one who has no settled habitation, or who does not abide in it.

*Vagrants* and outlaws shall offend thy view.

*Prior.*

In *law*, the word *vagrant* has a much more extended meaning than that assigned to it in ordinary language, and in its application the notion of wandering is almost lost. By the law *vagrants* are divided into three classes. 1. Idle and disorderly persons; 2. Rogues and

*vagabonds*; 3. Incurable rogues. Under the first class are included, every person who refuses or neglects to maintain himself and family, he being able to do so; paupers returning without certificate to parishes from which they have been legally removed; pedlars without license, beggars, common prostitutes, &c. Under the second class, are included every person committing any offence which would constitute him an idle or disorderly person, and who has been once already convicted, fortune tellers, and other impostors; persons guilty of indecent exhibitions; persons collecting alms or money under false pretences; wanderers who have no visible means of subsistence, and cannot give a good account of themselves; persons playing at games of chance in public places; reputed thieves; persons having in their possession housebreaking implements or offensive weapons with intent to use them. Under the third class are included persons guilty of the last class of offences, having been already convicted; persons breaking out of legal confinement; every person apprehended as a rogue and vagabond, and violently resisting any constable or other peace officer, so apprehending him. For all these offences the punishment is imprisonment or hard labour for a longer or shorter period, according to the nature of the particular offence. In *Scotland*, the laws against *vagrants*, as beggars, fortune tellers, jugglers, minstrels, &c., are of a much less stringent nature, and such persons are seldom apprehended or punished, unless where police regulations are enforced, or where they are entering a parish in the face of an advertised prohibition, or where they are committing or in the notorious habit of committing petty delinquencies.

**VAG'RANTLY, adv.** In a wandering unsettled manner.

**VAG'RANTNESS, n.** Vagrancy; the state of a vagrant.

**VAG'UE, a.** [*væg.*] [*Fr. from L. vagus, wandering.*] 1. Wandering; vagrant; vagabond; as, *vague* villains. [*In this literal sense, not used.*]—2. Unsettled; unfixed; undetermined; indefinite. He appears to have very *vague* ideas of this subject.—3. Proceeding from no known authority; flying; uncertain; as, a *vague* report.

**VAG'UELY, adv.** So as to leave uncertain or unsettled.

**VAG'UENESS, n.** The state of being unsettled, unfixed, uncertain, indefinite.

**VAG'HEA, n.** A genus of plants; nat. order Apocynaceæ. *V. gummifera*, a species found in Madagascar, is said to yield an excellent kind of caoutchouc.

**VAIL, n.** A cover for the face; a disguise. [*See VEIL.*]

**VAIL, v. t.** [*Fr. avaler.*] 1. To let fall. They stiffly refused to *vail* their bonnets. [*We believe wholly obsolete.*] *Carew.*

2. † To let fall; to lower; as, to *vail* the topsail.—3. † To let fall; to sink.

**VAIL, v. i.** To yield or recede; to give place; to show respect by yielding.

Thy convenience must *vail* to thy neighbour's necessity. *South.*

**VAILER, † n.** One who yields from respect.

**VAILS, n. plur.** [*from avail.*] Money given to servants.

**VAIMURE, † n.** In *ancient fort.*, a

**VAMURE, † } fore-wall; an out-**  
**ward-wall. } [*See VAUNTMURE.*]**

**VAIN, a.** [*Fr. vain; L. vanus; Gaelic, fann, weak; fann, void; W. gwan; Sans. vana; probably allied to Eng. wan, wane, want.*] 1. Empty; worthless; having no substance, value, or importance; 1 Pet. i.

To your *vain* answer will you have recourse. *Blackmore.*

Every man walketh in a *vain* show; Ps. xxxix.

Why do the people imagine a *vain* thing? Ps. ii.

2. Fruitless; ineffectual. All attempts, all efforts were *vain*.

*Vain* is the force of man. *Dryden.*

3. Proud of petty things, or of trifling attainments; elated with a high opinion of one's own accomplishments, or with things more showy than valuable; conceited.

The minstrels play'd on every sld, *Vain* of their art. *Dryden.*

4. Empty; unreal; as, a *vain* chimera.

—5. Showy; ostentatious.

Load some *vain* church with old theatric state. *Pope.*

6. Light; inconstant; worthless; Prov. xii.—7. Empty; unsatisfying. The pleasures of life are *vain*.—8. False; deceitful; not genuine; spurious; James i.—9. Not effectual; having no efficacy.

Bring no more *vain* oblations; 1s. i.

In *vain*, to no purpose; without effect ineffectual.

In *vain* they do worship me; Matth. xv.

To take the name of God in *vain*, to use the name of God with levity or profaneness.

**VAINGLORIOUS, a.** [*vain and glorious.*] 1. *Vain* to excess of one's own achievements; elated beyond due measure; boastful.

*Vainglorious* man. *Spenser.*

2. Boastful; proceeding from vanity. Arrogant and *vainglorious* expression. *Hab.*

**VAINGLORIOUSLY, adv.** With *vainglory*, or empty pride.

**VAINGLORY, n.** [*vain and glory.*] Exclusive vanity excited by one's own performances; empty pride; undue elation of mind.

He hath nothing of *vainglory.* *Baron.*

Let nothing be done through strife or *vainglory*; Phil. ii.

**VAINLY, adv.** Without effect; to no purpose; ineffectually; in *vain*.

In weak complaints you *vainly* waste your breath. *Dryden.*

2. Boastingly; with vaunting; proudly; arrogantly.

Humility teaches us not to think *vainly* nor vauntingly of ourselves. *Delany.*

3. Idly; foolishly.

Nor *vainly* hope to be invulnerable. *Milton.*

**VAINNESS, n.** The state of being *vain*; inefficacy; ineffectualness; as, the *vainness* of efforts.—2. Empty pride; vanity.

**VAIR, } a.** [*Qu. from L. varius, of*  
**VAIRY, } different colours; spotted,**  
**VAIRE, } speckled.] In her., charged**

with *vair*; variegated with argent and azure colours, when the term is *vairy proper*; and with other colours, when it is *vair* or *vairy* composed.

**VAIR, } n.** One of

**VAIRE, } the furs used in heraldry,**

which formed doublings and linings of the robes of kings and queens in former



Vair.

times. It is represented by little shields or bell-shaped pieces, generally white and blue.

**VAIS'YA**, } *n.* The third caste among  
**VYSE**, } the Hindoos; comprehending  
merchants, traders, and cultivators.

**VÄIVODE**, *n.* [Slav.] A prince of the Dacian provinces; sometimes written *vaiwode*, for this is the pronunciation.

**VÄ'KEEL**, *n.* In *India*, an ambassador or agent sent on a special commission, or residing at a court; a native Indian law-pleader under the judicial system of the East India Company.

**VAL'ANCE**, *n.* [Qu. Fr. *avalant*, falling; Norm. *valaunt*, descending.] The fringes of drapery hanging round the tester and head of a bed; and also from the head of window curtains.

**VAL'ANCE**, *v. t.* To decorate with hanging fringes.

**VAL'ANCED**, *pp.* Decorated with hanging fringes.

**VALE**, *n.* [Fr. *val*; It. *valle*; L. *vallis*. Qu. W. *gwael*, low, and Eng. to *fall*, Fr. *avalere*.] 1. A tract of low ground or of land between hills; a valley. [*Vale* is used in poetry, and *valley* in prose and common discourse.]

In these fair *vales*, by nature form'd to please.

*Harte.*  
2. A little trough or canal; as, a pump *vale* to carry off the water from a ship's pump.—3. *Vales*, money given to servants.

**VA'LE**, *v. impers.* [L.] Farewell; adieu.  
**VALEDI'C'TION**, *n.* [L. *valedico*; *vale*, farewell, and *dico*, to say.] A farewell; a bidding farewell.

**VALEDI'C'TORIAN**, *n.* In *American colleges*, the student who pronounces the valedictory oration at the annual commencement.

**VALEDI'C'TORY**, *a.* Bidding farewell; as, a *valedictory* speech.

**VALEDI'C'TORY**, *n.* An oration or address spoken at commencements in *American colleges*, by a member of the class which receive the degree of bachelor of arts, and take their leave of college and of each other.

**VALENT'CLAUSE**, *n.* In *Scots law*, the *valent clause*, in a return of special service, is that clause in which the old and new extent of the lands is specified.

**VALENT'IA**, *n.* A stuff made of worsted, cotton, and silk, used for waistcoats.

**VALENTINE**, *n.* A sweetheart or choice made on Valentine's day.—2. A letter sent by one young person to another on Valentine's day.

**VALENTINE'S DAY**, *n.* The 14th of February, observed as a festival in the Romish church, in honour of St. Valentine. It was a very old notion, alluded to by Shakspeare, that on this day birds begin to couple. Hence, perhaps, arose the custom of sending on this day letters containing professions of love and affection.

**VALENTIN'ANS**, *n.* A sect of heretics who sprung up in the second century, and were so named from Valentinus their founder. They were only a branch of the Gnostics, who realized or personified the Platonic ideas concerning the Deity, whom they called *Pleroma* or Plenitude.

**VAL'ERATE**, *n.* A salt formed by the union of valerianic acid with a base; as, the *valerate* of oxide of ethule.

**VALERIAN**, } *n.* A genus of plants,  
**VALERIAN'A**, } the type of the nat. order Valerianaceæ. The species,

which are numerous, are shrubs, or undershrubs, with very variable leaves, and mostly reddish-white corymbose flowers. Twelve species are European, and four are British. These plants are found in abundance in many districts, both of the old and new world.

*V. officinalis*, the official or great wild valerian, is a native of Europe, and grows abundantly by the sides of rivers, and in ditches, and moist woods, in Great Britain. The root, which is the official part, has a very strong smell, which is dependent on a volatile oil. Cats and rats are very fond of it, and rat-catchers employ it to decoy rats. It is used in medicine in the form of infusion, decoction, or tincture, as a nervous stimulant and antispasmodic. For a figure of this plant, see *Triander*. *V. rubra*, or red valerian, is occasionally found wild in Britain, and is cultivated in gardens as well as many other species, on account of its elegant flowers. *V. phu* is the garden valerian, and *V. discoroidis* the ancient Greek valerian.

**VALERIANACEÆ**, *n.* A nat. order of monopetalous exogens, composed of annual or perennial herbs or undershrubs, inhabiting temperate climates or elevated positions, both in the old and new world. These plants are most nearly related to Dipsacæ, from which they are distinguished by their looser inflorescence, sensible properties, want of albumen, and the absence of an involucrellum. The principal genera are *Valeriana*, *Valerianella* (the *Fedia* of Adamson), and *Nardostachys*, or spike-nard. The name *valerian* is given to *Polemium caruleum*.

**VALERIANEL'LA**, *n.* A genus of plants; nat. order Valerianaceæ. The species of this genus have been described by Smith, Hooker, and others, under the Adamsonian genus *Fedia*; but Decandolle, Lindley, and other systematic botanists, retain *valerianella*, which is a diminutive of *valeriana*, and restrict the genus *Fedia* to a single species, the *F. cornucopia*. Four species of *valerianella* are British. *V. olitoria*, common corn-salad, or lathib's lettuce, is an annual plant, found abundantly in corn fields and cultivated ground in Great Britain. In France and Germany it is much eaten as a salad, and is frequently cultivated for that purpose in this country. The other British species may be eaten as salads.

**VALERIANIC ACID**, *n.* An acid produced by the action of caustic potash on hydrated oxide of amule, or oil of potato spirit. It is also extracted from the root of *Valeriana officinalis*; hence the name. *Valerianic acid* is a limpid oily fluid, of a disagreeable and peculiar smell. With bases it forms soluble salts, which have a sweet taste. It consists of 10 atoms carbon, 9 hydrogen, and 3 oxygen.

**VAL'EROLE**, *n.* An oil contained in the essence of valerian. It is isomeric with metacetone.

**VALET**, *n.* [Fr.; formerly written *varlet*, *vallet*, *valect*, *vallet*, &c.] 1. A waiting servant; a servant who attends on a gentleman's person. *Valets* or *varlets*, were originally the sons of knights, and afterwards, those of the nobility before they attained the age of chivalry. [See **VALET**.]—2. In the *manège*, a kind of goad or stick armed with a point of iron.

**VALET DE CHAMBRE**. [Fr.] A body servant, or personal attendant.  
**VALETUDINARIAN**, } *a.* [L. *vale-*  
**VALETUDINARIAN**, } *tudinarius*,  
from *valeudo*, from *valeo*, to be well.] Sickly; weak; infirm; seeking to recover health.

**VALETUDINARIAN**, } *n.* A person  
**VALETUDINARIAN**, } of a weak,  
infirm, or sickly constitution; one who is seeking to recover health.

*Valetudinarians* must live where they can command and scold. *Swift.*

**VALETUDINARIANISM**, *n.* A state of feeble health; infirmity.

**VALETUDINARIANNESS**, } *n.* State of  
being valetudinarian.

**VALETUDINARIOUS**, } *a.* Valetu-  
dinarian.

**VALHAL'LA**, *n.* In the *Scandinavian myth.*, the palace of immortality, inhabited by the souls of heroes slain in battle.

**VAL'ANCE**, } *n.* (val'yance.) Bra-  
**VAL'ANCY**, } very; valour.

**VAL'ANT**, *a.* (val'yant.) [Fr. *valliant* from *vallor*, *l. valeo*, to be strong.]

1. Primarily, strong; vigorous in body; as, a *valiant* fencer.—2. Brave; courageous; intrepid in danger; heroic; as, a *valiant* soldier.

Be thou *valiant* for me, and fight the Lord's battles; 1 Sam. xviii.

3. Performed with valour; bravely conducted; heroic; as, a *valiant* action or achievement; a *valiant* combat.

**VAL'ANTLY**, *adv.* Stoutly; vigorously; with personal strength.—2. Courageously; bravely; heroically.

**VAL'IA NTNESS**, *n.* Stoutness; strength.—2. *Most generally*, valour; bravery; intrepidity in danger.

Achimetes, having won the top of the walls, by the *valiantness* of the defendants was forced to retire. *Knolles.*

**VAL'ID**, *a.* [Fr. *valide*; L. *validus*, from *valeo*, to be strong. The primary sense of the root is to strain or stretch.]—

1. Having sufficient strength or force; founded in truth; sound; just; good; that can be supported; not weak or defective; as, a *valid* reason; a *valid* argument; a *valid* objection.—2. Having legal strength or force; efficacious; executed with the proper formalities; that cannot be rightfully overthrown or set aside; supportable by law or right; as, a *valid* deed; a *valid* covenant; a *valid* instrument of any kind; a *valid* claim or title; a *valid* marriage.—3. † Strong; powerful; in a *literal sense*; as, *valid* arms.

**VAL'IDATE**, *v. t.* To make valid.

**VALIDATI'ON**, *n.* The act of giving validity to.

**VALID'ITY**, *n.* [Fr. *validité*; from *valid*.] 1. Strength or force to convince; justness; soundness; as, the *validity* of an argument or proof; the *validity* of an objection.—2. Legal strength or force; that quality of a thing which renders it supportable in law or equity; as, the *validity* of a will; the *validity* of a grant; the *validity* of a claim or of a title. Certain forms and solemnities are usually requisite to give *validity* to contracts and conveyances of rights.—3. † Value.

**VAL'IDLY**, *adv.* In a valid manner; in such a manner or degree as to make firm or to convince.

**VALIDNESS**, *n.* Validity,—*which see.*

**VAL'INCH**, *n.* A tube for drawing liquors from a cask by the bung hole.

**VALISE**, *n.* [Fr.] A small leather bag



or case, opening on the side, for containing the clothes, &c., of a traveller.

VALLAN'CY, *n.* [from *valance*.] A large wig that shades the face.

VAL'LAR CROWN, } [L. *corona*  
VAL'LARY, } [L. *vallis*.] In

*antiquity*, a golden crown with a kind of palisades fixed against the rim or circle. Among the Romans it was given by the general of an army to him who first mounted the rampart, or entered the camp of the enemy.



Valar Crown.

VALLATION, *n.* [L. *vallatus*, from *vallum*, a wall.] A rampart or entrenchment.

VAL'LATORY, *a.* Fencing; enclosing, as by a rampart.

VAL'LEY, *n.* plur. *Valleys*. [Fr. *vallée*; L. *vallis*. See VALE.] 1. A hollow or low tract of land between hills or mountains.—2. A low extended plain, usually alluvial, penetrated or washed by a river. The *valley* of the Connecticut is remarkable for its fertility and beauty.

Ye mountains, sink; ye *valleys*, rise;  
Prepare the Lord his way. *Watts*.

3. In *arch.*, the internal angle formed by the meeting of the two inclined sides of a roof. The rafter which supports the valley is called the *valley rafter* or *valley piece*, and the board fixed upon it for the leaden gutter to lie upon, is termed the *valley board*. By old writers, valley rafters were termed sleepers.

VALLISNERIA, *n.* A genus of aquatic plants, nat. order Hydrocharaceæ. Several species are recorded as growing in Europe, New Holland, and America. They are plants growing at the bottom of the water, and yet the male and female flowers are separated, and the mode by which they are brought together affords a singular instance of adaptation, and is exceedingly interesting in a physiological point of view.

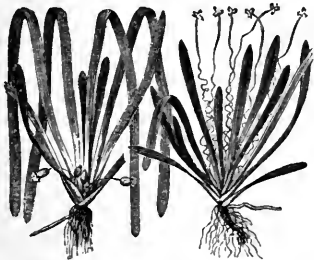

Vallisneria spiralis.

*V. spiralis* grows in Italy, in ditches near Pisa, and in the Rhone. *V. alternifolia* is one of the plants used in India, under the name of *janji*, for supplying water mechanically to sugar in the process of refining it.

VAL'LUM, *n.* [L.] A trench or wall. Among the Romans, the rampart with which they enclosed their camps. It consisted of two parts, the *agger*, or mound of earth, and the *sudes*, or palisades, that were driven into the ground to secure and strengthen it.

VALONIA, *n.* A modern Greek name, adopted in commerce for a species of acorn exported from the Morea and

Levant, for the use of tanners, as the husk or cup contains abundance of tannin. The oak which produces this acorn is the *Quercus Ægilops*, or great



Quercus Ægilops, producing Valonia.

prickly cupped oak. The acorns are sold from £12 to £15 a ton.

VALOREM, *AD*, in *com.*, according to the value; as, an *ad valorem* duty.

VAL'OROUS, *a.* Brave; courageous; stout; intrepid; as, a *valorous* knight.

VAL'OROUSLY, *adv.* In a brave manner; heroically.

VAL'OUR, *n.* [L. *valor*; Fr. *valeur*; from L. *valeo*, to be strong; to be worth.] Strength of mind in regard to danger; that quality which enables a man to encounter danger with firmness; personal bravery; courage; intrepidity; prowess.

When *valour* preys on reason,  
It eats the sword it fights with. *Shak.*

For contemplation, he and *valour* form *D.*

VAL'UABLE, *a.* [Fr. *valable*; from *value*.] 1. Having value or worth; having some good qualities which are useful and esteemed; precious; as, a *valuable* horse; *valuable* land; a *valuable* house.—2. Worthy; estimable; deserving esteem; as, a *valuable* friend; a *valuable* companion.

VAL'UABLENESS, *n.* Preciousness; worth.

VAL'UABLES, *n. pl.* Things of value; choice articles of personal property; precious merchandise of small bulk.

VALUA'TION, *n.* [from *value*.] The act of estimating the value or worth; the act of setting a price; as, the just *valuation* of civil and religious privileges.—2. Appraisal; as, a *valuation* of lands for the purpose of taxation.—3. Value set upon a thing; estimated worth.

So slight a *valuation*. *Shak.*

VAL'UATOR, *n.* One who sets a value; an appraiser.

VALUE, *n.* (val'u.) [Fr. *valoir*, *valu*; from L. *valor*, from *valeo*, to be worth; It. *valore*; Sp. *valor*.] 1. Worth; that property or those properties of a thing which render it useful or estimable; or the degree of that property or of such properties. The *real* value of a thing is its utility, its power or capacity of procuring or producing good. Hence, the *real* or *intrinsic* value of iron is far greater than that of gold. But there is, in many things, an *estimated* value, depending on opinion or fashion, such as the *value* of precious stones. The *value* of land depends on its fertility, or on its vicinity to a market, or on both.—2. Price; the rate of worth set upon a commodity, or the amount for which a thing is sold. We say, the *value* of a thing is what it will bring in

market.—3. In *political economy*, the quantity of labour, or of the product of labour, which will exchange for a given quantity of labour, or of some other product thereof. It is the labour of man alone which in ordinary circumstances creates value, and becomes the real measure of the exchangeable value of all commodities. It is necessary here to distinguish utility from value, or, as Adam Smith expresses the distinction, "*value in use*" from "*value in exchange*." The former may be defined, the power or capacity of an article to satisfy our wants or gratify our desires, while the *value in exchange* is that which will be received as an equivalent for something else which it has taken some labour to produce or obtain. What all may enjoy alike without labour may indeed be most useful and necessary, but cannot be an object of exchange, and therefore is destitute of value. Water is indispensable to existence, and has therefore a very high degree of utility or of *value in use*; but as it can generally be obtained in large quantities without much labour or exertion, it has, in most places, but a very low value in exchange. Gold, on the contrary, is of comparatively little utility; but as it exists only in limited quantities, and requires a great deal of labour on its production, it has a comparatively high exchangeable value, and may be exchanged or bartered for a proportionally large quantity of most other things. The real value of a commodity depends solely upon the quantity of labour necessary for its production, and the exchangeable value never varies materially either above or below the real value; hence it follows that the price paid for labour does not affect the exchangeable value of articles produced under similar circumstances. Every reduction in the quantity of labour required to produce a commodity diminishes its real value, and hence its value in exchange; and, upon the same principles, every increase in the quantity of labour, directly or indirectly applied, adds to the value of a commodity.—4. Worth; *applied to persons*.

Ye are all physicians of no *value*; Job xiii.

Ye are of more *value* than many sparrows; Matt. x.

5. High rate.  
Cesar is well acquainted with your virtue,  
And therefore sets this *value* on your life.

6. Importance; efficacy in producing effects; as, considerations of no value.

Before events shall have decided on the *value* of the measures. *Marshall*.

7. Import; precise signification; as, the *value* of a word or phrase.

VALUE, *v. t.* (val'u.) To estimate the worth of; to rate at a certain price; to appraise; as, to *value* lands or goods.—2. To rate at a high price; to have in high esteem; as, a *valued* poem or picture. A man is apt to *value* his own performances at too high a rate; he is even disposed to *value* himself for his humility.—3. To esteem; to hold in respect and estimation; as, to *value* one for his works or virtues.—4. To take account of.

The mind doth *value* every moment.

5. To reckon or estimate with respect to number or power.

The queen is *valu'd* thirty thousand strong.

6. To consider with respect to importance.

The king must take it ill,

So slightly *valu'd* in his messenger. *Shak.*

Neither of them *valued* their promises according to the rules of honour or integrity. *Clarendon.*

7. To raise to estimation.

Some *value* themselves to their country by jealousies to the crown.† *Temple.*  
8.† To be worth.

VAL'UED, *pp.* Estimated at a certain rate; appraised; esteemed.—*Valued policy*, in *Scots law*, in marine insurance, is a policy in which a specified value is put on the ship, goods, or effects insured. In the case of total loss or abandonment, the amount in a valued policy is considered the adjustment of the value as between the parties, but it cannot be made a shield for fraud. [See OPEN POLICY under OPEN.]

VAL'UELESS, *a.* Being of no value; having no worth.

VAL'UER, *n.* One who values; an appraiser; one who holds in esteem.

VAL'UING, *ppr.* Setting a price on; estimating the worth of; esteeming.

VALVA'TA, *n.* A genus of Gastropods belonging to the family Peristomata. They are small fresh water univalves, and occur both recent and fossil. Several species are British.

VALVATE, *a.* [See VALVE.] Having or resembling a valve; consisting of valves.

VALVE, *n.* (valv.) [L. *valvæ*, folding doors; coinciding with *volvō*.] 1. A folding door.

Swift through the *valves* the visionary fair Repass'd. *Pope.*

2. In *mech.*, a kind of movable lid, or cover adapted to the orifice of a tube, or passage into a vessel, for the purpose of regulating the admission or escape of a fluid, such as water, gas, or steam. Some valves are self-acting, that is, they are so contrived as to open in the required direction, by the pressure of the fluid upon their surface, and immediately to shut and prevent the return of the fluid when the direction of its pressure changes. Others are actuated by independent external agency. Examples of the former kind are presented in the valves of pumps, and in the safety-valves of steam boilers, and of the latter, in the slide-valves appended to the cylinder of a steam engine for the purpose of regulating the admission and escape of the steam. The construction of valves admits of an almost endless variety. [See CUP-VALVE, CLACK-VALVE, CONICAL VALVE, D-VALVE, SAFETY-VALVE, THROTTLE VALVE.]—3. In *anat.*, a membranous partition within the cavity of a vessel, which opens to allow the passage of a fluid in one direction, and shuts to prevent its regurgitation; as the *valve* of the colon, *mitral valve*, *semilunar valves*, *tricuspid valves*, &c.—4. In *bot.*, the outer coat, shell, or covering of a capsule or other pericarp, or rather one of the pieces which compose it; also, one of the leaflets composing the calyx and corol in grasses. The same term is also applied to the opening in the cells of anthers, which occurs when the pollen is about to be discharged.

—5. In *conchology*, the shell. When the whole shell is in one piece, it is called an *univalve*; when in two pieces a *bivalve*; and when of more than two pieces, a *multivalve*.

VALVED, *a.* Having valves or hinges; composed of valves.

VAL'VET, *n.* A little valve; a valvule.

VALV'LET, } *n.* A little valve; one of VALV'ULE, } the pieces which compose the outer covering of a pericarp.

VALV'ULA, *n.* [L.] A little valve. In *anat.*, applied to the valves of the venous and lymphatic system of animals.

VALV'ULAR, *a.* Containing valves.

VAM'BRACE, *n.* [Fr. *avant-bras*.] In *plate armour*, the piece of armour which covered the fore-arm from the elbow to the wrist. It is also written *vambrace*.

VAMP, *n.* [W. *gwam*, that incloses, or goes partly round.] The upper leather of a boot or shoe.

VAMP, *v. t.* To piece an old thing with a new part; to repair.

I had never much hopes. of your *vamped* play. *Swift.*

VAMP'ED, *pp.* Pieced; repaired.

VAMP'ER, *n.* One who pieces an old thing with something new.

VAMP'ING, *ppr.* Piecing with something new.

VAMP'IRE, *n.* [G. *vampyr*.] 1. According to Dom Calmet, the *vampire* is a dead man who returns in body and soul from the other world, and wanders about the earth doing every kind of mischief to the living. Generally he sucks the blood of persons asleep, and thus causes their death, while those who are destroyed in this manner become themselves vampires. The only way of getting rid of such visitors, is, according to the same author, to disinter their bodies, to pierce them with a stake cut from a green tree, to cut off their heads, and to burn their hearts. This superstition is chiefly prevalent in some parts of Eastern Europe, and especially in Hungary and its dependencies.—2. In *zool.*, the Linnean trivial or specific name of *Pteropus Edwardsii*, or the great bat of Madagascar; also, the popular name of *Phyllostoma spectrum*, or the *Vampyre bat* of New Spain; also, the popular name of the genus of *bats*, named



Vampyre (*Phyllostoma spectrum*).

*Vampyrus*. Bats of the genus *Phyllostoma* have a leaf-like appendage attached to their upper lip, whence their name. The tongue is capable of considerable extension, and is furnished at its extremity with a number of papillæ, apparently arranged so as to form an organ of suction. These animals grow to a great size, specimens having been killed measuring two feet between the tips of the wings. They attack horses and cattle, and sometimes even man, during the night, puncturing their skin, it is supposed, by means of the hooked nail of the thumb, and then abstracting the blood by the suction powers of their lips and tongue. In some parts of Brazil the ravages of these creatures

are such as to render the rearing of cattle an impossibility. It is more than probable, however, that the celebrated vampire superstition, and the blood-sucking qualities attributed to the bat, have some connection with each other.

VAMP'IRISM, *n.* The actions of a vampire; the practice of blood-sucking; *figuratively*, the practice of extortion.

VAM'PLATE, *n.* A gauntlet or iron glove; but some consider it to be the same as *vambrace*.

VAM'PLET, *n.* A plate of iron on the lower part of the staff of a tilting spear, for covering the hand. It somewhat resembles a funnel in shape. [See *figure under TOURNAMENT*.]

VAN, *n.* [The radical word from which is formed the *Fr. avant, avancer*, Eng. *advance, advantage*. It is from the root of *L. venio*, the primary sense of which is to pass.] 1. The front of an army; or the front line or foremost division of a fleet, either in sailing or in battle.—2. Any thing spread wide, and moved so as to produce a current of air; a fan for winnowing grain.—3. In *mining*, the cleansing of ore or tin stuff by means of a shovel.—4. A wing with which the air is beaten.

He wheel'd in air, and stretch'd his *vans* in vain. *Dryden.*

5. A large covered carriage for the transportation of goods.

VAN,† *v. t.* [Fr. *vanner*.] To fan. [See *FAN*.]

VANA'DIATE, *n.* A salt formed by the union of vanadic acid with a base; as, *vanadate* of lead.

VANA'DIC ACID, *n.* An acid obtained by heating vanadate of ammonia so as to expel the alkali. Its colour in the state of fine powder is a light rust yellow; but when fused, it is red with a shade of orange, and has a strong lustre. It is tasteless, nearly insoluble in water, and quite so in alcohol. With bases it forms salts, which are either red or yellow, according as they are acid or neutral salts; but the neutral vanadates of the alkalies may occur both yellow and colourless, without any known difference in composition. Vanadic acid consists of 3 equivalents of oxygen, and 1 of vanadium.

VANA'DIUM, *n.* [from *Vanadis*, a Scandinavian deity.] A metal discovered by Sefström in 1830, in iron prepared from the iron ore of Taberg, in Sweden. It was afterwards obtained by the same individual in the slag formed during the conversion of the cast-iron of Taberg into malleable iron. It has since been found in a lead ore from Wanlockhead, in Scotland, and in a similar mineral from Zimapan, in Mexico. This metal has a white colour, and a strong metallic lustre, considerably resembling silver, but still more like molybdenum. It is extremely brittle. It is not oxydized either by air or water, though by continuous exposure to the atmosphere, its lustre grows weaker, and it acquires a reddish tint. The only acid that dissolves it is aqua regia. Oxygen and vanadium combine to form two oxides, viz., the protoxide, which is a black powder, having a semi-metallic lustre, and the deutoxide, which, when anhydrous, is also black, but forms blue salts. With chlorine, vanadium forms a bichloride, and a terchloride.

VAN-COURIERS, *n.* [Fr. *avant-coureurs*.] In *armies*, light armed soldiers sent before armies to beat the road

upon the approach of an enemy; precursors.

**VAN'DAL, n.** [It signifies a wanderer.] The Vandals formed one of the most barbarous of the northern nations or tribes that invaded Rome in the 5th century, and were notorious for destroying the monuments of art and literature. Hence,—2. One hostile to the arts and literature; one who is ignorant and barbarous.

**VANDALIC, a.** Pertaining to the Vandals; designating the south shore of the Baltic, where once lived the Vandals, a nation of ferocious barbarians; hence, ferocious; rude; barbarous; hostile to the arts and literature.

**VAN'DALISM, n.** The spirit or conduct of Vandals; ferocious cruelty; hostility to the arts and literature.

**VANDEL'LIA, n.** A genus of plants; nat. order Scrophulariaceæ. The species are natives of the warm parts of the world, forming smooth or hairy herbs, with tetragonal stems, opposite leaves, and axillary flowers. *V. diffusa*, a native of Brazil, is described as emetic, and its decoction as useful in fevers and liver complaints.

**VANDYKE, n.** A pointed collar of lace or sewed work worn by both sexes during the reign of Charles I., and to be seen in portraits painted by Vandyke.

**VANE, n.** [D. *vaan*. The primary sense is extended.] A plate or thin slip of metal, wood, &c., placed on a spindle at the top of a spire, tower, &c., for the purpose of showing by its turning and direction which way the wind blows. In *ships*, a piece of bunting is used for the same purpose.—2. A broad vane or flag carried by a knight in the tournament.—3. The thin membranous part or web of a feather on the side of the shaft.—4. In *mathematical* or *philosophical instruments*, vanes are sights made to slide and move upon cross-staves, quadrants, &c.—*Dog vane*. [See among the compounds of Dog.]

**VANEL'LUS, n.** A genus of gallatodes, including the true lapwings.

**VAN-FOSS, n.** A ditch on the outside of the counterscarp.

**VANG, n.** The vangs of a ship are a sort of braces to steady the peak of a gaff to the ship's side.

**VAN'-GUARD, n.** The troops who march in van of an army; the first line.

**VANILLA, n.** A genus of orchidaceous plants, natives of tropical America;



Vanilla aromatica.

The fruit of *Vanilla aromatica* or *planifolia*, is remarkable for its fragrant odour, and for the volatile odoriferous

oil extracted from it. As a medicine, it is supposed to possess powers analogous to valerian, while, at the same time, it is far more grateful. It is employed in confectionary, in the preparation of liqueurs, and in flavouring of chocolate.

**VAN'ISH, v. i.** [L. *vanesco*; Fr. *evanouir*; from L. *vanus*, vain, or its root; Eng. to *vane*. The primary sense is to withdraw or depart.] 1. To disappear, to pass from a visible to an invisible state; as, vapour *vanishes* from the sight by being dissipated. Light *vanishes* when the rays of the illuminating body are intercepted; darkness *vanishes* before the rising sun.—2. To disappear; to pass beyond the limit of vision; as, a ship *vanishes* from the sight of spectators on land.—3. To disappear; to pass away; to be annihilated or lost. How cheering is the well founded hope of enjoying delights which can never *vanish*.—4. In *math.*, a quantity is said to *vanish*, or become evanescent, when its arithmetical value is nothing, or is denoted by 0.

**VAN'ISHED, a.** Having no perceptible existence.

**VAN'ISHING, ppr.** Disappearing; passing from the sight or possession; departing for ever.—*Vanishing point*, in *perspective*, the point in which an imaginary line passing through the eye of the observer parallel to any original line cuts the horizon. This point is situated always somewhere in an indefinitely extended line, supposed to be drawn on a level with the eye parallel to the horizon, and called from this circumstance the *vanishing line*. In

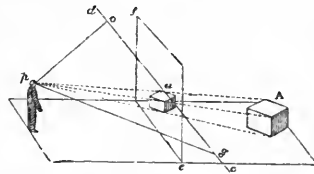

Vanishing point.

perspective drawing this imaginary line (*cd*) is formed by the intersection of the plane of projection (*ef*), or surface on which the image (*a*) falls, with the vanishing plane (*po g*), or plane supposed to pass through the eye of the spectator at (*p*), parallel to the ground or plane upon which the original object (*A*) stands. The points *o* and *g* being formed by the intersection of two lines drawn from the eye parallel to the two sides of the original object will likewise be the vanishing points of those sides.—*Vanishing fractions*, in *alge.*, those fractions in which, by giving a numerical value to any variable quantity or quantities which enter into them, both numerator and denominator become zero, and the fraction itself  $\frac{0}{0}$ .

**VAN'ISHMENT, n.** A vanishing.

**VAN'ITY, n.** [Fr. *vanité*; L. *vanitas*, from *vanus*, vain.] 1. Emptiness; want of substance to satisfy desire; uncertainty; inanity.

*Vanity of vanities*, saith the preacher; all is *vanity*; Eccles. i.

2. Fruitless desire or endeavour.

*Vanity* possesseth many who are desirous to know the certainty of things to come.

Sidney.

3. Trifling labour that produces no good.—4. Emptiness; untruth.

Here I may well show the *vanity* of what is reported in the story of Walsingham.

Davies.

5. Empty pleasure; vain pursuit; idle show; unsubstantial enjoyment.

Siu with *vanity* had fill'd the works of men. Milton.

Think not when woman's transient breath is fled,

That all her *vanities* at once are dead; Succeeding *vanities* she still regards. Pope.

6. Ostentation; arrogance.—7. The desire of indiscriminate admiration. Inflation of mind upon slight grounds; empty pride, inspired by an overweening conceit of one's personal attainments or decorations, and making its possessor anxious for the notice and applause of others. Fops cannot be cured of their *vanity*.

*Vanity* is that species of pride, which while it presumes upon a degree of superiority in some particular articles, fondly courts the applause of every one within its sphere of action, seeking every occasion to display some talent or some supposed excellency.

Cogan.

*Vanity* is the food of fools. Swift.

No man sympathizes with the sorrows of *vanity*. Johnson.

**VAN'MURE, } n.** [Fr. *avant-mure*.]  
**VANT'MURE, } A** front wall or false wall.

**VAN'QUISH, v. t.** [Fr. *vaincre*; L. *vincio*; It. *vincere*; Sp. *vincer*; probably allied to L. *vincio*, to bind.] 1. To conquer; to overcome; to subdue in battle; as an enemy.

They *vanquished* the rebels in all encounters. Clarendon.

2. To defeat in any contest; to refute in argument.

**VAN'QUISH, n.** A disease in sheep, in which they pine away.

**VAN'QUISHABLE, a.** That may be conquered.

**VAN'QUISHED, pp.** Overcome in battle; subdued; defeated.

**VAN'QUISHER, n.** A conqueror; a victor.

**VAN'QUISHING, ppr.** Conquering; subduing; defeating; refuting.

**VAN'QUISHMENT, n.** The state of being vanquished, or conquered.

**VAN'SIRE, n.** In *zool.*, the *Mangusta galera*, a digitigrade, carnivorous mammal; a small quadruped, somewhat resembling a weasel, of a deep brown colour, speckled with yellow, the tail of equal size its whole length; inhabiting Madagascar and the Isle of France.

**VANT, v. i.** [Fr. *vantier*] To boast. [See VAUNT.]

**VANTAGE, n.** [Sp. *ventaja*; from the root of L. *venio*. See ADVANTAGE and VAN.] 1. † Gain; profit.—2. † Superiority; state in which one has better means of action or defence than another.—3. † Opportunity; convenience.

**VANTAGE, † v. t.** To profit.

**VANTAGE-GROUND, n.** Superiority of state or place; the place or condition which gives one an advantage over another.

**VANT'BRACE, } † n.** [Fr. *avant-bras*.]  
**VANT'BRASS, } Armour** for the arm. [See VANDRACE.]

**VAP'ID, a.** [L. *avidus*. The radical verb is not in the Latin, but the sense must be to pass or fly off, to escape; or to strike down, L. *vapulo*. It is probably allied to *vapor*.] 1. Having lost its life and spirit; dead; spiritless;

flat; as, *vapid* beer; a *vapid* state of the blood.—2. Dull; unanimated.

**VAPIDITY**, *n.* Vapidity.

**VAPIDLY**, *adv.* In a *vapid* manner.

**VAPIDNESS**, *n.* The state of having lost its life or spirit; deadness; flatness; as, the *vapidity* of ale or cider.—2. Dulness; want of life or spirit.

**VAPORABILITY**, *n.* The quality of being capable of vaporization.

**VAPORABLE**, *a.* Capable of being converted into vapour by the agency of caloric.

**VAPORATE**, *v. i.* To emit vapour. [See **EVAPORATE**.]

**VAPORATION**, *n.* [*L. vaporatio.*] The act or process of converting into vapour, or of passing off in vapour.

**VAPORIFIC**, *a.* [*L. vapour and facio,* to make.] Forming into vapour; converting into steam, or expelling in a volatile form, as fluids.

**VAPORIZABLE**, *a.* Capable of being converted into vapour.

**VAPORIZATION**, *n.* The artificial formation of vapour.

**VAPORIZE**, *v. t.* To convert into vapour by the application of heat or artificial means.

**VAPORIZE**, *v. i.* To pass off in vapour.

**VAPORIZED**, *pp.* Expelled in vapour.

**VAPORIZING**, *ppr.* Converting into vapour.

**VAPOROUS**, } *a.* [*Fr. vapeur.*] 1. **VAPOROSE**, } Full of vapours or exhalations; as, the *vaporous* air of valleys.—2. Vain; unreal; proceeding from the vapours.—3. Windy; flatulent; as, *vaporous* food is the most easily digested.

**VAPOROUSNESS**, *n.* State of being full of vapours.

**VAPOUR**, *n.* [*L. and Sp. vapor*; *Fr. vapeur*; *It. vapore.*] It is probably from a verb signifying to depart, to fly off. 1. In a *general sense*, an invisible elastic aeriform fluid, into which any body naturally solid or liquid at ordinary temperature may be converted by the agency of heat, and which is capable of being condensed or brought back to the liquid or solid state, by reducing the temperature, or by a moderate increase of pressure. Vapours are distinguished from gases by their ready conversion into liquids or solids, whereas gases retain their elastic state more obstinately; they are always gaseous at common temperatures; and, with one or two exceptions, cannot be made to change their form, unless by being subjected to much greater pressure than they are naturally exposed to. Several of them, indeed, have hitherto resisted every effort to compress them into liquids. Different substances yield vapours with very different degrees of facility; fluids in general are more easily vaporized than solids, and solids generally pass into the liquid state before they assume the form of vapour. Some liquids, ether for instance, require to be carefully secluded from the atmosphere, to prevent their rapid conversion into vapour. The vapour which is produced by the ebullition of water is distinguished by the name of *steam*,—*which see*.—2. A visible fluid floating in the atmosphere. All substances which impair the transparency of the atmosphere, as smoke, fog, &c., are in common language called *vapours*.—3. In *meteorology*, that invisible elastic fluid which rises constantly from the surface of land and water all over the

world, at common temperatures, and which, uniting itself to the air, ascends into the higher regions of the atmosphere, and is carried by the winds to great distances. Aqueous vapour thus suspended in the atmosphere, when condensed by cold, becomes visible, forming clouds, and returning to the earth in the form of rain, snow, &c. The formation of vapour at the surface of land and water is promoted by an increase of temperature, by winds, and by the dryness of the atmosphere. When the atmosphere is already saturated with aqueous vapour, the formation of vapour goes on slowly. [See **EVAPORATION**.]—3. Substances resembling smoke, which sometimes fill the atmosphere, particularly in America during the autumn.—4. Wind; flatulence.—5. Mental fume; vain imagination; unreal fancy.—6. *Vapours*, a disease of nervous debility, in which a variety of strange images float in the brain, or appear as if visible. Hence, hypochondriacal affections and spleen are called *vapours*.—7. Something unsubstantial, fleeting, or transitory.

For what is your life? It is even a vapour, that appeareth for a little time, and then vanisheth away; James iv.

**VAPOUR**, *v. i.* [*L. vaporo.*] 1. To pass off in fumes or a moist floating substance; to steam; to be exhaled; to evaporate. [In this sense, *evaporate* is generally used.]—2. To emit fumes.

Running water vapours not so much as standing water. [*Little used.*] Bacon. 3. To bully; to boast or vaunt with a vain, ostentations display of worth; to brag. [*This is the most usual signification of the word.*]

And what in real value's wanting, Supply with vapouring and ranting.

*Hudibras.*

**VAPOUR**, *v. t.* To emit, cast off, or scatter in fumes or steam; as, to vapour away a heated fluid.

Another sighing vapours forth his soul.

*B. Johnson.*

**VAPOUR-BATH**, *n.* [*vapour and bath.*] The application of vapour or steam to the body in a close place; also the place itself.—2. In *chem.*, an apparatus for heating bodies by the vapour of water.

**VAPPOURED**, *a.* Moist; wet with vapours.—2. Splenetic; peevish.

**VAPPOURER**, *n.* A boaster; one who makes a vaunting display of his prowess or worth; a braggart.

**VAPPOURING**, *ppr.* Boasting; vaunting ostentatiously and vainly.

**VAPPOURINGLY**, *adv.* In a boasting manner.

**VAPPOURISH**, *a.* Full of vapours.—2. Hypochondriac; splenetic; affected by hysterics.

**VAPPOURY**, *a.* Vaporous; full of vapours.—2. Hypochondriac; splenetic; peevish.

**VAPULA'TION**, † *n.* [*L. vapulo.*] The act of beating or whipping.

**VARDINGALE**, *n.* The hooped petticoat of Elizabeth's reign. [See **FARTHINGALE**.]

**VARE**, † *n.* [*Sp. vara.*] A wand or staff of justice.

**VAREC**, *n.* The French name for kelp or incinerated sea weed; wrack; *Fucus vesiculosus*.

**VARI**, *n.* In *zool.*, a quadrumanous mammal, the *Prosimia catta*, or ring-tailed lemur, having its tail marked with rings of black and white; it is a native of Madagascar. The *vari* of

Buffon is the black maucauco, *Prosimia nigra*, with the neck bearded like a ruff.

**VARIABLE**, *a.* [*Fr. See VARY.*] That may vary or alter; capable of alteration in any manner; changeable; as, *variable* winds or seasons; *variable* colours.—2. Susceptible of change; liable to change; mutable; fickle; unsteady; inconstant; as, the affections of men are *variable*; passions are *variable*.

*Milton.*

*Variable quantities*, in *analysis*, are such quantities as are subject to continual increase or diminution, in opposition to those which are *constant*, remaining always the same. Thus, the abscissas and ordinates of a curve are *variable quantities*; because they vary or change their magnitudes together, and in passing from one point to another, their values increase or diminish according to the law of the curve. *Variable quantities* are usually denoted by the last letters of the alphabet, *z, y, x*, while those that are constant are denoted by the first letters, *a, b, c*. In the investigation of the relation which varying and dependent quantities bear to each other, the conclusions are more readily obtained by expressing only two terms in each proportion, than by retaining the four; but it must be kept constantly in mind that four quantities in the shape of a proportion are always understood; namely, each of the two *variable quantities* at different periods of their increase or decrease. One quantity is said to *vary directly* as another, when the two quantities depend wholly upon each other, and in such a manner that if one of them be increased or diminished, the other is increased or diminished in the same proportion. Thus, if the altitude of a triangle be invariable, the area varies directly as the base; for if the base be increased or diminished, the area is increased or diminished in the same proportion. One quantity is said to *vary inversely* as another, when the former cannot be changed in any manner, but the reciprocal of the latter is changed in the same proportion. For example, if the area of a triangle be given, the base varies inversely as the perpendicular altitude. Thus, if *A* denote the altitude of a triangle whose area is given, and *B* its base, then *A* varies as  $\frac{1}{B}$ , or  $A \propto \frac{1}{B}$ .

One quantity is said to *vary as two others jointly*, when it increases or decreases as the product of those two quantities increases or decreases. For example, the area of a triangle varies as its base and altitude jointly; thus, if *A* denote the area of a triangle, *B* its base, and *C* its altitude, then *A* varies as *B C*, or  $A \propto B C$ . One quantity is said to *vary directly*, as a second, and *inversely*, as a third, when the first cannot be changed in any manner, but the second multiplied by the reciprocal of the third, is changed in the same proportion. For example, the base of a triangle varies as the area directly, and as the perpendicular altitude inversely; thus, if *A* denote the area, *B* the base, and *C* the altitude, then *A*

varies as  $B \times \frac{1}{C}$ , or  $A \propto \frac{B}{C}$ . In general, if one quantity varies as another, it is equal to it multiplied by

some constant quantity. Thus, if  $A$  vary as  $B$ , and  $c$  be a constant quantity, then  $A = cB$ , or if  $A$  vary as  $\frac{1}{B}$ , then  $A = \frac{c}{B}$ . In *mech.*, a *variable motion* is that which is produced by the action of a force which varies in intensity.

**VARIABLE**, *n.* In *math.*, a quantity which is in a state of continual increase or decrease. The indefinitely small quantity by which a variable is continually increased or diminished, is called its *differential*, and the method of finding these quantities, the *differential calculus*.

**VARIABLENESS**, } *n.* Susceptibility  
**VARIABILITY**, } of change; li-  
ability or aptness to alter; change-  
ableness; as, the *variableness* of the  
weather.—2. Inconstancy; fickleness;  
unsteadiness; levity; as, the *variable-  
ness* of human passions.

**VARIABLY**, *adv.* Changeably; with alteration; in an inconstant or fickle manner.

**VARIANCE**, *n.* [See **VARY**.] In *law*, an alteration of something formerly laid in a writ; or a difference between a declaration and a writ, or the deed on which it is grounded. In ordinary language, a departure in the oral evidence from the statement in the pleadings, is termed a *variance*.—2. Any alteration or change of condition.—3. Difference that produces dispute or controversy; disagreement; dissension; discord. A mere *variance* may become a war. Without aspirit of condensation, there will be an everlasting *variance*.—*At variance*, in disagreement; in a state of difference or want of agreement.—2. In a state of dissension or controversy; in a state of enmity.

**VARIANT**, *a.* Different; diverse.

**VARIATE**, *v. t.* To alter; to make different.—2. To vary. [*A bad word.*]

**VARIATION**, *n.* [Fr. from *L. variatio*. See **VARY**.] 1. Alteration; a partial change in the form, position, state, or qualities of the same thing; as, a *variation* of colour in different lights; a *variation* in the size of a plant from day to day; the unceasing, though slow *variation* of language; a *variation* in a soil from year to year. Our opinions are subject to continual *variations*.

The essences of things are conceived not capable of such *variation*. *Locke.*

2. Difference; change from one to another.

In some other places are born more females than males; which, upon this *variation* of proportion, I recommend to the curious. *Graunt.*

3. In *gram.*, change of termination of nouns and adjectives, constituting what is called case, number, and gender; as, the *variation* of words.—4. Deviation; as, a *variation* of a transcript from the original.—5. In *astron.*, the variation of the moon is the third inequality in her motion; by which, when out of the quadratures, her true place differs from her place twice equated. It depends on the angular distance of the moon from the sun.—6. In *geography* and *navigation*, the deviation of the magnetic needle from the true north point, or the angle which the magnetic needle makes with the plane of the geographical meridian of a ship or station; called also *declination*. In *navigation*, the variation

of the compass is properly the angle between the magnetic axis of the needle and a meridian line passing parallel to the horizon through the centre of the compass. The variation of the compass does not remain constantly the same in the same place, but undergoes a slow and progressive change. The needle is observed to move gradually towards the west of the true meridian until it arrives at its maximum on that side; it then returns, passes over the true meridian, and moves easterly, until it arrives at its maximum towards the east, when it returns as before. In the year 1590, in London, the variation was  $11^{\circ} 15'$  East; in 1660, the needle pointed due north, since which time it has travelled about  $24\frac{1}{2}^{\circ}$  to the westward, and now it has begun to return. The variation however is very different in different parts of the globe, and it is also subject to diurnal changes in the same place.—7. In *music*, the different manner of singing or playing the same air or tune, by subdividing the notes into several others of less value, or by adding graces, yet so that the tune itself may be discovered through all its embellishments.—*Variation of curvature*, in *analytical geometry*, is that inequality or change which takes place in the curvature, in passing from one point of a curve to another. All curves are liable to this variation, with the exception of the circle in which the curvature is uniform at every point.—*Calculus of variations*, a branch of analysis, the chief object of which is to find what function of a variable will be a maximum or minimum on certain prescribed conditions. This calculus offers the only general, and frequently the only possible, means of solving those problems generally termed isoperimetrical.

**VARICELLA**, *n.* [Diminutive of *variola*, the small-pox.] In *med.*, the chicken-pox; called also the water-pox.

**VARICIFORM**, *n.* Resembling a varix, —which see.

**VARICOCELE**, *n.* [*L. varix*, a dilated vein, and *Gr. κελε*, a tumour. A bad term, being part Greek and part Latin. *Cirsocele* is the correct term, and is that which is much the most commonly used.] In *sur.*, a varicose enlargement of the veins of the spermatic cord; or more rarely a like enlargement of the veins of the scrotum.

**VARICOSE**, } *a.* [*L. varicosus*, having  
**VARICOUS**, } enlarged veins.] Pre-  
ternaturally enlarged, or permanently  
dilated; applied only to veins.

**VARIED**, *pp.* of *Vary*. Altered; partially changed; changed.

**VARIEDLY**, *adv.* Diversely.

**VARIEGATE**, *v. t.* [It. *varieggiare*; from *L. vario*, *varius*. See **VARY**.] To diversify in external appearance; to mark with different colours; as, to *variegate* a floor with marble of different colours.

The shells are filled with a white spar, which *variegates* and adds to the beauty of the stone. *Woodward.*

Ladies like *variegated* tulips show. *Pope.*  
**VARIEGATED**, *pp.* Diversified in colours or external appearance. *Variegated leaves*, in botany, are such as are irregularly marked with white or yellow spots.

**VARIEGATING**, *ppr.* Diversifying with colours.

**VARIEGATION**, *n.* The act of diversifying, or state of being diversified by different colours; diversity of colours.—2. In *bot.*, a term employed to designate the disposition of two or more colours in the petals, leaves, and other parts of plants.

**VARIETY**, *n.* [Fr. *variété*; *L. varieties*, from *vario*, to vary.] 1. Intermixture of different things, or of things different in form; or a succession of different things.

*Variety* is nothing else but a continued novelty. *South.*

The variety of colours depends on the composition of light. *Newton.*

2. One thing of many which constitute variety. In this sense, it has a plural; as, the *varieties* of a species.—3. Difference; dissimilitude.

There is a *variety* in the tempers of good men. *Atterbury.*

4. Variety; deviation; change from a former state.—5. Many and different kinds. The shopkeeper has a great *variety* of cottons and silks.

He wants to do a *variety* of good things. *Law.*

6. In *nat. hist.*, a subdivision of a species; any individual plant or animal which differs from the rest of the species to which it belongs, in some accidental circumstances, which are not permanent, nor invariable, nor essential to the species. In *bot.*, the character of the species is found in its capability of reproducing by seed a plant which is more like itself than it is like any thing else; and this under all circumstances in which the offspring is capable of being produced. The variety differs from the species in points of structure, which are developed only under certain circumstances, arising from climate, cultivation, and other influences, and which are not essential to the species. While species having the normal form and colours, are perpetuated by seed, varieties, although often also propagated in the same manner, are liable to return to the original form, or to deviate into others, so that a variety cannot be preserved without much care. All species have a tendency to form varieties, but all the natural varieties of plants are nothing like so numerous, as those which arise from cultivation. In *zool.*, varieties, are individuals of the same species, which differ from the specific type, in size, colour, form, and relative proportion of the parts of the body, owing to the operation of different causes; as, age, climate, food, locality, domestication, &c.; but which like the varieties of plants, are liable to revert to the original typical form, in successive generations.—7. Different sort; as, *varieties* of soil or land.

**VARIFORM**, *a.* Having different shapes or forms.

**VARIFORMED**, *a.* Formed with different shapes.

**VARIFORMING**, *ppr.* Making of different forms.

**VARIFY**, *v. t.* To diversify; to colour variously.

**VARIOLA**, *n.* [*L.*] The small-pox; so named from *L. varius*, spotted, from its effects upon the skin.

**VARIOLARIA**, *n.* A genus of lichens, of an ash-grey or white colour, found on the back of the trunks of various trees, on rocks, walls, or on the ground. About thirteen species are found in

Great Britain. *V. faginea*, is distinguished from all others of the genus,

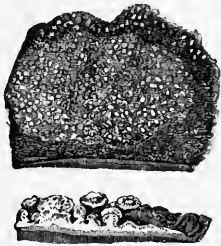

*Violaria faginea.*

by its intensely bitter taste, and is employed in France for the purpose of obtaining oxalic acid. *V. lactea*, or milky-white violaria, is an elegant species, and is collected for the purpose of being used in dyeing.

**VARIOLITE**, *n.* [*L. varius* and *Gr. λβος*, stone.] In *min.*, a kind of porphyritic rock, in which the imbedded substances are imperfectly crystallized, or are rounded, giving the stone a spotted appearance.

**VARIOLOID**, *n.* [*L. variolæ* and *Gr. υδωρ*, form.] A name recently given to a particular variety of the small pox.

**VARIOLOUS**, } *a.* [*L. variolæ*, from  
**VARIOLAR**, } *vario*, to diversify.]  
**VARIOLIC**, } Pertaining to or designating the small pox.

**VARIO'NUM**. [*L.*] *Variorum* editions of the Greek and Roman classics, (*editiones cum notis variorum*), are those in which the notes of numerous commentators are inserted. Such editions were published chiefly in Holland in the 17th and 18th centuries.

**VARIOUS**, *a.* [*L. varius*. See **VARY**.] 1. Different; several; manifold; as, men of *various* names and *various* occupations.—2. Changeable; uncertain; unfixed.

The names of mixed modes...are very *various* and doubtful. *Locke.*

3. Unlike each other; diverse.  
So many and so *various* laws are given. *Milton.*

4. Variegated; diversified.—*Various readings*, differences in the text of a work, arising from the ignorance or negligence of early transcribers of manuscripts, from critical conjecture, or wilful corruption, from the mistakes of printers, or from the changes which an author makes himself in the later editions of his works. To restore the true text or true reading of ancient works, is the business of verbal criticism, and is often of great importance, especially in the Bible.

**VARIOUSLY**, *adv.* In different ways; with change; with diversity; as, objects *variously* represented; flowers *variously* coloured. The human system is *variously* affected by different medicines.

**VARI'X**, *n.* [*L.*] An uneven dilatation of a vein; a disease known by a soft tumour on a vein, which does not pulsate.—2. In *conchology*, a term used to designate the longitudinal thickened elevations which occur at greater or less intervals on the outer surface of spiral shells, as in Triton and Murex.

**VARLET**, *n.* [Old Fr. See **VALET**.] Anciently, a page or knight's follower; a servant or footman.—2. A scoundrel; a rascal; as, an impudent *varlet*.

**VÄRLETRY**,† *n.* The rabble; the crowd.

**VÄRNISH**, *n.* [*Fr. vernis*; *It. vernice*; *Low L. vernix*; *G. firniss*; *D. vernis*.] 1. A solution of resinous matter, forming a clear limpid fluid, capable of hardening without losing its transparency, and used by painters, gilders, cabinet-makers, &c., for coating over the surface of their work, in order to give it a shining, transparent, and hard surface, capable of resisting in a greater or less degree the influences of air and moisture. The resinous substances most commonly employed for varnishes are mastic, sandarac, lac, benzoin, copal, amber, and asphaltum; and the solvents employed are alcohol, volatile oil, or fixed oil. Hence, varnishes may be divided into three classes, alcoholic or spirit varnishes, volatile-oil varnishes, and fixed-oil varnishes. But as the materials to which varnishes are applied, and the purposes they are designed to answer, differ very widely, varnishes of course vary in a similar degree, and receive different names accordingly. Amber varnish is made of amber, linseed oil, litharge, and turpentine. Black varnish, for Japanese wood and leather, is made by mixing lampblack with a proper quantity of a strong solution of lac in spirit of wine.—2. An artificial covering to give a fair appearance to any act or conduct.

**VÄRNISH**, *v. t.* [*Fr. vernisser*, *vernir*.] 1. To lay varnish on; to cover with a liquid, for giving any thing a glossy surface, and to protect it from the influences of air and moisture; as, to *varnish* a sideboard or table.—2. To cover with something that gives a fair external appearance.

Close ambition, *varnish'd* o'er with zeal. *Milton.*

3. To give a fair external appearance in words; to give a fair colouring to; as, to *varnish* errors or deformity.

Cato's voice was ne'er employ'd  
To clear the guilty, and to *varnish* crimes. *Addison.*

And bow the knee to pomp that loves to  
*varnish* guilt. *Byron.*

**VÄRNISHED**, *pp.* Covered with varnish; made glossy.—2. Rendered fair in external appearance.

**VÄRNISHER**, *n.* One who varnishes, or whose occupation is to varnish.—2. One who disguises or palliates; one who gives a fair external appearance.

**VÄRNISHING**, *ppr.* Laying on varnish; giving a fair external appearance.

**VÄRNISH TREES**, *n.* The name given to certain trees which exude resinous juices, either naturally or from incisions. These juices harden in the air, and are employed as varnishes for preserving various articles from the influence of the air, water, or insects, and also for giving them greater brilliancy. Varnish trees are found chiefly in India, Burmah, and China. Many of them belong to the nat. order Anacardiaceæ; as the marking nut (*Semecarpus anacardium*); *Stagmaria vernici-flua*, which yields the Japan lacquer; *Augia sinensis*, said to produce the genuine Chinese varnish, with which the different fancy articles are lacquered; and *Rhus vernix*, the Japan varnish of Kämpfer and Thunberg.

**VÄRR'IATED**, } *pp.* In *her.*, cut in  
**VÄRR'IATED**, } the form of *vair*;  
as, a bend *varriated* on the outsides.

**VÄRR'IES**, } *n.* In *her.*, separate pieces  
**VÄRR'YS**, } of *vair*, in form resen-  
**VÄRR'EYS**, } bling a shield. [See  
**VÄIR**.]

**VÄRTABED**, *n.* One of an order of ecclesiastics in the Armenian church. They differ from the priests by living in seclusion and celibacy. They also preach, while the priests do not.

The Armenian bishops are all taken from the order of *vartabeds*, and are ordained by them. *Coleman.*

**VÄRU'NA**, *n.* In *Hindoo myth.*, the god of the waters, the Indian Neptune, and the regent of the west division of the



Varuna.

earth. He is represented as a white man, four-armed, riding on a sea animal, with a rope in one of his hands, and a club in another.

**VÄRVELLED**, *pp.* In *heraldry*, when the leather thongs which tie on the bells to the legs of hawks are borne floatant, with rings at the ends, the bearing is then termed jessed, belled, and *varvelled*.



Varvelled.

**VÄRVELS**, } *n.* [*Fr. vervel*.] In *fal-*  
**VÄR'VELS**, } *conry*, silver rings placed  
on the legs of a hunting hawk, on which the owner's name is engraved.

**VÄRVICITE**, *n.* An oxide of manganese found native in Warwickshire. It is supposed to be a compound of two other oxides.

**VÄRY**, *v. t.* [*L. vario*, *Fr. varier*; *It. variare*; probably allied to *Eng. veer*, *Sp. birar*, *L. verto*, *Eth. bari*.] 1. To alter in form, appearance, substance, or position; to make different by a partial change; as, to *vary* a thing in dimensions; to *vary* its properties, proportions, or nature; to *vary* the posture or attitude of a thing; to *vary* one's dress.—2. To change to something else.

Gods, that never change their state,  
*Vary* oft their love and hate. *Waller.*

We are to *vary* the customs according to the time and country where the scene of action lies. *Dryden.*

3. To make of different kinds.  
God hath *varied* the inclinations of men, according to the variety of actions to be performed. *Brownie.*

4. To diversify; to varygate.  
God hath here  
*Varied* his bounty so with new delights. *Milton.*

**VÄRY**, *v. i.* To alter or be altered in any manner; to suffer a partial change.

Colours often *vary* when held in different positions. Customs *vary* from one age to another, until they are entirely changed.—2. To be changeable; to alter; as, the *varying* hues of the clouds; the *varying* plumage of a dove.—3. To differ or be different; to be unlike. The laws of different countries *vary*. The laws of France *vary* from those of England.—4. To be changed; to become different. The man *varies* in his opinions; his opinions *vary* with the times.—5. To become unlike one's self; to alter.

He *varies* from himself no less. *Pope*.  
6. To deviate; to depart; as, to *vary* from the law; to *vary* from the rules of justice or reason.—7. To alter or change in succession.

While fear and anger, with alternate grace,  
Pant in her breast, and *vary* in her face.

*Addison*.  
8. To disagree; to be at variance; as, men *vary* in opinion.—9. In *analysis*, to be subject to continual increase or decrease; as, *variable* quantities. [*See under* VARIABLE.]

VA'RY, † *n.* Alteration; change.  
VA'RYING, *ppr.* Altering; changing; deviating.

VAS, *n.* plur. *Vasa*. [*L.*] A vessel; applied in *anat.* to arteries, veins, ducts, &c.—2. In *bot.*, applied to several of the tissues of plants; as, *vasa fibrosa*, or woody tissue.

VAS'CLAR, *a.* [*L. vasculum*, a vessel, from *vas*, *id.*] 1. Pertaining to the vessels of animal or vegetable bodies; as, the *vascular* functions.—2. Full of vessels; consisting of animal or vegetable vessels, as arteries, veins, lacteals, and the like; as, the *vascular* system. Animal flesh is all *vascular*, none of it parenchymous.—*Vascular tissue*, in *bot.*, is that species of tissue which is composed of very elongated membranous tubes, tapering at each end, and having a spiral fibre within them, or having their walls marked with broken spiral lines, or dots arranged in a circular or spiral direction. There are two principal kinds of vascular tissue, namely, *spiral vessels* and *ducts*.

VAS'CLARES, *n. plur.* Plants which have stamens, pistils, and spiral vessels, and bear proper flowers, as exogens and endogens.

VASCULARITY, *n.* The state of being vascular.

VASCULIFEROUS, *a.* [*L. vasculum*, and *fero*, to bear.] *Vasculiferous plants* are such as have seed-vessels divided into cells, such as the pomegranate, *Punica granatum*; the orange, *Citrus aurantium*; the poppy, *Papaver somniferum*, &c., &c.

VASE, *n.* [*Fr.* from *L. vas, vasa*, a vessel; *It. vaso*.] 1. A vessel in general for show rather than for use; a vessel

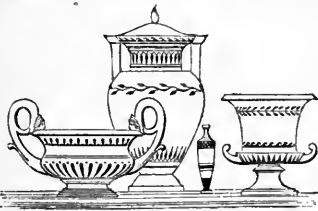

Grecian Vasa.

for use in temples; as, a *vase* for sacrifice, an urn, &c. In its widest sense,

the word comprises all vessels intended to contain fluids, whether they are made of metal, stone, or clay. Ancient vases of metal, stone, and clay, and of all varieties of shape, have come down to our time. The most numerous class are those of painted, dried or baked, clay, which have been discovered by thousands in tombs and catacombs in Etruria, Southern Italy, Sicily, Greece, and some of the Grecian islands. Many of them exhibit great beauty and elegance, and accordingly they have been much prized by antiquaries. The most ancient vases are those of the style called Egyptian.—2. In *arch.*, an ornament of sculpture, placed on socles or pedestals, representing the vessels of the ancients, as incense-pots, flower-pots, &c. They usually crown or finish façades or frontispieces.—3. The body of the Corinthian and Composite capital; called also the tambour or drum.—4. Among *florists*, the calyx of a plant.—5. Among *goldsmiths*, the middle of a church candlestick.—6. A solid piece of ornamental marble.

VAS'SAL, *n.* [*Fr. vassal*; *It. vassallo*; *W. gwads*, a boy or youth, a page, a servant; *gwastu*, to serve.] 1. A feudatory; a tenant; one who holds land of a superior, and who vows fidelity and homage to him. A *rear vassal* is one who holds of a lord who is himself a vassal.—2. A subject; a dependant.—3. A servant.—4. In *common lan.*, a bondman; a political slave. We will never be the *vassals* of a foreign prince.  
VAS'SAL, *v. t.* To subject to control; to enslave.

VAS'SAL, *a.* Servile; subservient.  
VAS'SALAGE, *n.* [*Fr. vasselage*; *Sp. vasalage*.] 1. The state of being a vassal or feudatory.—2. Political servitude; dependence; subjection; slavery. The Greeks were long held in *vassalage* by the Turks.

VAS'SALED, *pp.* or *a.* Enslaved; subjected to absolute power; as, a *vassaled* land.

VAS'SALRY, *n.* The body of vassals.

VAST, *a.* [*L. vastus*; *Fr. vaste*; *It. vasto*.] The primary sense of the root must be to part or spread, as this is connected with the verb to *waste*.] 1. Being of great extent; very spacious or large; as, the *vast* ocean; a *vast* abyss; the *vast* empire of Russia; the *vast* plains of Syria; the *vast* domains of the Almighty.—2. Huge in bulk and extent; as, the *vast* mountains of Asia; the *vast* range of the Andes.—3. Very great in numbers or amount; as, a *vast* army; *vast* numbers or multitudes were slain; *vast* sums of money have been expended to gratify pride and ambition.—4. Very great in force; mighty; as, *vast* efforts; *vast* labour.—5. Very great in importance; as, a subject of *vast* concern.

VAST, *n.* An empty waste.  
Through the *vast* of heav'n it sounded.

The watery *vast*. *Milton*.  
*Pope*.

VASTA'TION, *n.* [*L. vastatio*, from *vasto*, to waste.] A laying waste; waste; depopulation. [*Devastation* is generally used.]

VASTID'ITY, † *n.* Vastness; immensity.  
VASTITUDE, *n.* Vastness; immense extent.

VASTLY, *adv.* Very greatly; to a great extent or degree; as, a space *vastly* extended. Men differ *vastly* in their opinions and manners.

VASTNESS, *n.* Great extent; immen-

sity; as, the *vastness* of the ocean or of space.—2. Immense bulk and extent; as, the *vastness* of a mountain.—3. Immense magnitude or amount; as, the *vastness* of an army, or of the sums of money necessary to support it.—4. Immense importance.

VAS'TO, *n.* In *Eng. law*, a writ against tenants, for terms of life or years, committing waste.

VÄSTY, † *a.* Being of great extent; very spacious.

I can call spirits from the *vasty* deep. *Shak.*

VAT, *n.* [*D. vat*; *Sax. fut*; *G. fass*.] 1. A large vessel or cistern for holding; liquors in an immature state; as, *vats* for wine.

Let him produce his *vats* and tubs, in opposition to heaps of arms and standards. *Addison*.

2. A square box or cistern in which hides are laid for steeping in tan.—3. An oil measure in Holland; also, a wine measure.—4. A square hollow place on the back of a calcining furnace, in which tin ore is laid for the purpose of being dried.

VATERIA, *n.* A genus of plants, nat. order Dipteraeae. There are only two species, *V. indica*, which grows all



Vateria indica.

along the Malabar coast and in Canara; and *V. lanceafolia*, common in Sihat. Both species form large trees, valuable both for their timber, and also for the products which they yield. *V. indica*, whose timber is much employed in ship building, produces the resin, called in India *copal*, and in England *gun anime*. It also yields a fatty substance called *piney tallow*.

VAT'ICAN, *n.* [*L. vates*.] In *Rome*, the celebrated church of St. Peter; and also, a magnificent palace of the pope; situated at the foot of one of the seven hills on which Rome was built. Hence the phrase, the *thunders of the Vatican*, meaning the anathemas or denunciations of the pope. Properly speaking, the vatican is an assemblage of public buildings on the right bank of the Tiber, within the walls of modern Rome. It consists mainly of the papal palace, the court and garden of Belvedere, the library, and the museum.

VAT'ICANIST, *n.* [*From Vatican*.] A devoted adherent of the pope; a rigid papist.

VAT'ICIDE, *n.* [*L. vates*, a prophet, and *caedo*, to kill.] The murderer of a prophet.

VAT'ICINAL, *a.* [*L. vaticinor*, to prophesy; *It. vaticino*.] Containing prophecy.

VAT'ICINATE, *v. i.* [*L. vaticinor*, from *vates*, a prophet.] To prophesy; to

foretel; to practise prediction. [*Little used.*]

VATICINA'TION, *n.* Prediction; prophecy.

VAUDE'VIL, } *n.* (*vōdevil*). [*Fr.*]  
VAUDEVILLE, } A song common among the vulgar, and sung about the streets. A ballad; a trivial strain.—2. In the *French theatre*, a *vaudeville* is a piece whose dialogue is intermingled with light or comic songs, set to popular airs.

VAULT, *n.* [*Fr. voûte*; *It. volta*, a vault; *volto*, the face, visage, and a vault, *L. vultus*; a derivative of *L. volvo, volutus*; *Sp. voltear*, to turn, to tumble.] 1. In *arch.*, a continued arch, or an arched roof, so constructed that the stones, bricks, or other material of

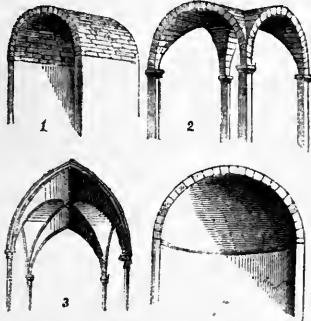

1. Cylindrical, barrel, or wagon vault.  
2. Roman vault, formed by the intersection of two equal cylinders.  
3. Gothic groined vault.  
4. Spherical or domical vault.

which it is composed, sustain and keep each other in their places. Vaults are of various kinds, cylindrical, elliptical, single, double, cross, diagonal, Gothic, &c. When a vault is of greater height than half its span, it is said to be *surmounted*, and when of less height, *sur-bassed*. A *rampant vault* is one which springs from planes not parallel to the horizon. One vault placed above another constitutes a *double vault*. A *comic vault* is formed of part of the surface of a cone, and a *spherical vault* of part of the surface of a sphere, as fig. 4. A vault is *simple*, as figs. 1 and 4, when it is formed by the surface of some regular solid, around one axis; and *compound*, as figs. 2 and 3, when compounded of more than one surface of the same solid, or of two different solids. A *groined vault*, fig. 3, is a compound vault, rising to the same height in its surfaces as that of two equal cylinders, or a cylinder with a cylindroid.—2. A cellar.

To banish rats that haunt our vaults. *Swift*.  
3. A cave or cavern.

The silent vaults of death, unknown to light. *Sandys*.

4. A repository for the dead.—5. In the *manege*, the leap of a horse.—6. A leap; a jump.

VAULT, *v. t.* To arch; to form with a vault; or to cover with a vault; as, to vault a passage to a court.

VAULT, *v. i.* [*Sp. voltear*; *It. voltare*; *Fr. vautre*.] 1. To leap; to bound; to jump; to spring.

Vaulting ambition, which o'erleaps itself. *Shak.*

Leaning on his lance, he vaulted on a tree. *Dryden*.

Lucan vaulted upon Pegasus with all the heat and intrepidity of youth. *Addison*.

2. To tumble; to exhibit feats of tumbling or leaping.

VAULT'AGE, } *n.* Vaulted work; an arched cellar.

VAULT'ED, *pp.* Arched; concave; as, a vaulted roof.—2. Covered with an arch or vault.—3. *a. In bot.*, arched like the roof of the mouth, as the upper lip of many ringent flowers.

VAULT'ER, *n.* One that vaults; a leaper; a tumbler.

VAULT'ING, *ppr.* Arching; covering with an arch.—2. Leaping; tumbling; exhibiting feats of leaping.

VAULT'ING, *n.* 1. In *arch.*, the art or operation of constructing arched roofs or vaults.—2. Vaults in general.—3. The art or practice of a vaulter.

VAULT'ING SHAFT, } *n.* In *arch.*, a VAULT'ING PILLAR, } pillar sometimes rising from the floor to the spring of the vault of the roof; more frequently, a short pillar attached to the wall, rising from a corbel, and from the top of which the ribs of the vault spring. The pillars between the triforium windows of Gothic churches rising to and supporting the vaulting, may be cited as examples.

VAULT'Y, } *a.* Arched; concave.

V'AUNT, *v. i.* [*Fr. vanter*; *It. vantarsi*, from *vanto*, a boasting, from *vano*, vain, *L. vanus*.] To boast; to make a vain display of one's own worth, attainments, or decorations; to talk with vain ostentation; to brag.

Pride ... prompts a man to vault and overvalue what he is. *Gov. of the Tongue*.

V'AUNT, *v. t.* To boast of; to make a vain display of.

My vanquisher, spoil'd of his vaulted spoil. *Milton*.

Charity vaulteth not itself; 1 Cor. xiii.

V'AUNT, *n.* Boast; a vain display of what one is or has, or has done; ostentation from vanity.

Him I seduc'd  
With other vaults and other promises. *Milton*.

V'AUNT, } *n.* [*Fr. avant*.] The first part.

V'AUNT-COURIER, *n.* [*Fr. avant-coureur*.] A precursor.

V'AUNTED, *pp.* Vainly boasted of or displayed.

V'AUNTER, *n.* A vain conceited boaster; a braggart; a man given to vain ostentation.

V'AUNTFUL, *a.* Boastful; vainly ostentations.

V'AUNTING, *ppr.* Vainly boasting; ostentatiously setting forth what one is or has.

V'AUNTINGLY, *adv.* Boastfully; with vain ostentation.

V'AUNT-MURE, *n.* [*Fr. avant-mur*.] A false wall; a work raised in front of the main wall.

VAUQUEL'INITE, *n.* Chromate of lead and copper, a mineral which occurs in small crystals on quartz, accompanying the chromate of lead, in Siberia.

VAVASOR, *n.* [This word in old books is variously written, *valvasor*, *vavasour*, *valvasour*. It is said to be from *vassal*. But *qu.*] Camden holds that the *vavasor* was next below a baron. Du Cange maintains that there were two sorts of *vavasors*; the greater, who held of the king, such as barons and counts; and the lesser, called *valvasini*, who held of the former. The dignity or rank is no longer in use, and the name is known only in books.

VAVASORY, *n.* The quality or tenure of the fee held by a *vavasor*.

VA'WARD, } *n.* [*van* and *ward*.] The fore part.

V. D. M. An abbreviation for the Latin *Verbi Dei minister*, minister of God's word.

VE'ADER, *n.* The 13th month of the Jewish ecclesiastical year, answering to our March.

VEAL, *n.* [*Fr. veau*, a calf; probably contracted from *L. vitellus*.] The flesh of a calf killed for the table.

VECK, } *n.* An old woman.

VECT'ION, } *n.* [*L. vectio*, from *veho*, to carry.] The act of carrying, or state of being carried.

VECT'IS, *n.* [*L.*] A lever.

VECTITA'TION, } *n.* [*L. vectito*.] A carrying.

VECT'OR, *n.* [*L. from veho*, to carry.] In *astron.*, commonly called *Radius vector*. [See under *RADIUS*.]

VECTURE, *n.* [*L. vectura*, from *veho*, supra.] A carrying; carriage; conveyance by carrying. [*Little used.*]

VE'DA, *n.* The generic name of the four oldest sacred books of the Hindoos, viz., the *Rig* or *Rish Veda*, the *Yajur* or *Yajush Veda*, the *Sama* or *Saman Veda*, and the *Atharva* or *Atharvana Veda*. These are believed by the Hindoos to have been directly revealed by Brahma; but the subdivisions are infinite, as are also the connected works. The *vedas* consist chiefly of prayers, precepts, or maxims, and stories. The word is sometimes written *vedam*.

VEDAN'TA, *n.* A system of philosophy among the Hindoos, founded on the revelations contained in the *vedas*.

VEDE'TTE, } *n.* [*Fr. vedette*; *It. ve-*  
VIDETTE, } *detta*, from *vedere*, *L. video*, to see.] A sentinel on horseback. A dragoon or horseman stationed on the outpost of an army, to watch an enemy and give notice of danger.

VEE'NA, *n.* The most ancient musical instrument of the Hindoos. It is of the guitar kind, with seven metallic strings, and, in good hands, is capable of yielding great melody and expression.

VEER, *v. i.* [*Fr. virer*; *Sp. birar*; *D. vieren*; allied probably to *L. vario* and *verto*. See *WARE*.] To turn; to alter its course, as a ship; to change direction; as, the wind *veers* to the west or north.

And as he leads, the following navy *veers*. *Dryden*.

And turn your *veering* heart with every gale. *Roscommon*.

To *veer* and haul, as wind, to alter its direction.

VEER, *v. t.* To turn; to direct to a different course; to cause a ship to change her course from one board to the other by turning her stern to windward, in opposition to *tacking*.—To *veer out*, to suffer to run or to let out to a greater length; as, to *veer out* a rope.—To *veer away*, to let out; to slacken and let run; as, to *veer away* the cable. This is called also *paying out* the cable.—To *veer* and haul, to pull tight and slacken alternately.

VEERABLE, } *a.* Changeable; shifting.

VEERED, *pp.* Turned; changed in direction; let out.

VEERING, *ppr.* Turning; letting out, to a greater length.

VEERING, *n.* In *navigation*, that movement of a ship, by which, in changing her course from one board to another, her head is turned to leeward, in opposition to *tacking*. The term is used in the same sense as *wearing*.



**VEERINGLY**, *adv.* Changingly; shift-  
ingly.

**VEGETABILITY**, *n.* [from *vegetable*.]  
Vegetable nature; the quality of growth  
without sensation.

**VEGETABLE**, *n.* [Fr. from *vegeter*, *L.*  
*vigeo*, to grow.] 1. A plant; an or-  
ganized body destitute of sense and  
voluntary motion, deriving its nourish-  
ment through pores on its outer sur-  
face or vessels, in most instances ad-  
hering to some other body, as the earth,  
and in general, propagating itself by  
seeds. Some vegetables have sponta-  
neous motion. Vegetables alone have  
the power of deriving nourishment from  
inorganic matter, or organic matter  
entirely decomposed. [See *PLANT*.]—  
2. In a more limited sense, vegetables  
are such plants as are used for culinary  
purposes and cultivated in gardens,  
or are destined for feeding cattle and  
sheep. Vegetables for these uses are  
such as are of a more soft and fleshy  
substance than trees and shrubs; such  
as cabbage, cauliflower, turnips, pota-  
toes, peas, beans, &c.

**VEGETABLE**, *a.* Belonging to plants;  
as, a vegetable nature; vegetable quali-  
ties; vegetable juices.—2. Consisting of  
plants; as, the vegetable kingdom.—  
3. Having the nature of plants; as, a  
vegetable body.—*Vegetable anat.*, that  
branch of botany which treats of the  
form, disposition, and structure of the  
organs of plants.—*Vegetable life*, the  
aggregate of the phenomena exhibited  
by plants, and which are similar to  
those that in animals are considered as  
characteristic of vital agency, agreeing  
with them in many essential respects,  
though they differ in others, especially  
in the absence of sensibility and volun-  
tary motion. Plants breathe, feed,  
digest, increase in their dimensions,  
produce new individuals, and perform  
various other functions, analogous to  
those of animals, and which are essen-  
tially characteristic of life.—*Vegetable*  
*earth*, soil in which decayed vegetable  
matter is in much larger proportion  
than the primitive earths.—*Vegetable*  
*kingdom*, that division of natural history  
which embraces the various or-  
ganized bodies to which we indiffer-  
ently give the names of *vegetables* and  
*plants*. The science which treats of  
these is termed *Botany*,—*which see*.—  
*Vegetable marrow*, the fruit of a species  
of gourd, *Cucurbita ovifera*, a native  
of Persia. It is used for culinary pur-  
poses, and so named from the peculiar  
tenderness and softness of its flesh.—  
*Vegetable ivory*, a close-grained and  
very hard vegetable substance, resem-  
bling the finest ivory in texture and  
colour, and often wrought into orna-  
mental work. It is the produce of a  
species of palm, *Phytelphas macrocar-  
pas*, in the form of a nut, often as large  
as a hen's egg.—*Vegetable physiology*,  
that branch of botany which treats of  
the vital actions of plants, or of the  
offices which their various organs per-  
form.—*Vegetable morphology*. [See  
*MORPHOLOGY*.]—*Vegetable tissues*.  
[See *TISSUE*.]—*Vegetable acids*, acids  
obtained from plants, as vinegar, malic,  
citric, gallic, &c., acids.—*Vegetable*  
*alkalies*, such as are obtained from  
vegetables; as, morphia, cinchona,  
strychnia, &c.—*Vegetable butters*, the  
concrete oil of certain vegetables, so  
named from its resemblance to the  
butter obtained from the milk of ani-  
mals, and from being employed for

similar purposes. The most important  
vegetable butters are produced by the  
*Bassia butyracea*, the *Coccoloba butyracea*,  
and the *Elais guineensis*.—*Vegetable*  
*oils*. [See *OIL*.]—*Vegetable wax*. [See  
*WAX*.]

**VEGETAL**, *a.* Having power to cause  
growth. As a noun, a vegetable.

**VEGETARIAN**, *n.* One who abstains  
from animal food, and lives exclusively  
on vegetables, eggs, milk, &c.—2. One  
who maintains that vegetables consti-  
tute the only proper food for man.

**VEGETARIAN**, *a.* Of or belonging to  
the diet or system of the vegetarians.

**VEGETARIANISM**, *n.* Abstinance  
from animal food; the dietetic prin-  
ciples of the vegetarians.

**VEGETATE**, *v. i.* [*L.* *vegeto*; *Fr.*  
*vegeter*; from *L. vigeo*, to flourish.]  
To sprout; to germinate; to grow; as  
plants; to grow and be enlarged by  
nutriment imbibed from the earth, air,  
or water, by means of roots and leaves.  
Plants will not *vegetate* without a cer-  
tain degree of heat; but some plants  
*vegetate* with less heat than others.  
Potatoes will *vegetate* after they are  
pared, provided what are called the  
eyes or chits are not removed or in-  
jured.

See *dying vegetables life sustain*,

See *life dissolving vegetate again*. *Pope*.

**VEGETATING**, *ppr.* Germinating;  
sprouting; growing; as plants.

**VEGETATION**, *n.* [Fr.] The process  
of growing, as plants, by means of  
nourishment derived from the earth,  
or from water and air, and received  
through roots and leaves. We observe  
that vegetation depends on heat and  
on certain substances which constitute  
the nutriment of plants. Rapid *vege-  
tation* is caused by increased heat and  
a rich soil.—2. Vegetables or plants  
in general. In June, *vegetation* in our  
climate wears a beautiful aspect.—  
*Vegetation of salts*, so called, consists in  
certain crystalline concretions formed  
by salts, after solution in water, when  
set in the air for evaporation. These  
concretions appear round the surface  
of the liquor, affixed to the sides of the  
vessel.

**VEGETATIVE**, *a.* [Fr. *vegetatif*.]

1. Growing, or having the power of  
growing, as plants.—2. Having the  
power to produce growth in plants;  
as, the *vegetative* properties of soil.

**VEGETATIVENESS**, *n.* The quality  
of producing growth.

**VEGETE**, *a.* [*L. vegetus*.] Vigorous;  
active. [*Little used*.]

**VEGETIVE**, *a.* [*L. vegeto, vigeo*.] *Vege-  
table*; having the nature of plants; as,  
*vegetive* life. [*Little used*.]

**VEGETIVE**, *a.* A vegetable.

**VEGETO-ANIMAL**, *a.* Partaking of  
the nature both of vegetable and ani-  
mal matter. *Vegeto-animal matter* is  
a term formerly applied to vegetable  
gluten, which is found in the seeds of  
certain plants, in a state of union with  
fecula or starch. It is remarkably  
elastic, and when dry, semi-transparent.  
By distillation it affords, like  
animal substances, ammonia, and an  
emphyreumatic oil.

**VEGETOUS**, *a.* Vigorous; lively;  
vegete.

**VEHEMENCE**, *n.* [Fr. *vehemence*;  
*VEHEMENCY*,] from *L. vehemens*,  
from *veho*, to carry, that is, to rush or  
drive.] 1. Violence; great force; pro-  
perly, force derived from velocity; as,  
the *vehemence* of wind. But it is ap-

plied to any kind of forcible action;  
as, to speak with *vehemence*.—2. Violent  
ardour; great heat, animated fer-  
vour; as, the *vehemence* of love or  
affection; the *vehemence* of anger or  
other passion.

I tremble at his *vehemence* of temper.

*Addition.*

**VEHEMENT**, *a.* [Fr. from *L. vehemens*.] 1. Violent; acting with great  
force; furious; very forcible; as, a  
*vehement* wind; a *vehement* torrent; a  
*vehement* fire or heat.—2. Very ardent;  
very eager or urgent; very fervent;  
as, a *vehement* affection or passion;  
*vehement* desire; *vehement* eloquence.

**VEHEMENTLY**, *adv.* With great  
force and violence.—2. Urgently; for-  
cibly; with great zeal or pathos.

**VEHICLE**, *n.* [Fr. *vehicule*; *L. vehiculum*,  
from *veho*, to carry.] 1. That  
in which any thing is or may be car-  
ried; any kind of carriage moving on  
land, either on wheels or runners.  
This word comprehends coaches, cha-  
riots, gigs, sulkies, waggons, carts of  
every kind, sleighs, and sledges. These  
are all *vehicles*. But the word is more  
generally applied to wheel carriages,  
and rarely we believe to water craft.—  
2. That which is used as the instru-  
ment of conveyance. Language is the  
*vehicle* which conveys ideas to others.  
Letters are *vehicles* of communication.

A simple style forms the best *vehicle* of  
thought to a popular assembly. *Wirt.*

3. A substance in which medicine is  
taken.—4. A menstruum, in which  
paints, gums, varnishes, &c., are dis-  
solved and prepared for use.

**VEHICLED**, *a.* Conveyed in a vehicle.

**VEHICULAR**, *a.* Pertaining to a  
vehicle.

**VEHMIC**, *a.* *Vehm*ic courts were the  
tribunals of a secret society in Ger-  
many, during the middle ages, which  
for a time held a powerful sway over  
the people by their terrible executions.

**VEIL**, *n.* [Fr. *voile*; *It. velo*; *L. velum*,  
from *velo*, to cover, to spread over;  
Gael. *falach*, a veil.] 1. Any kind of  
cloth which is used for intercepting  
the view and hiding something; as,  
the *veil* of the temple among the Is-  
raelites.—2. A piece of thin cloth or  
silk stuff, used by females to hide their  
faces. In some eastern countries,  
certain classes of females never appear  
abroad without *veils*.—3. A cover;  
that which conceals; as, the *veil* of  
oblivion.—4. In *bot.*, the horizontal  
membrane in fungi, connecting the  
margin of the pileus with the stipes.

**VEIL**, *v. t.* To cover with a veil; to  
conceal.—2. To invest; to cover.—  
3. To hide. [See *VEIL*.]

**VEILED**, *pp.* Covered; concealed.

**VEILING**, *ppr.* Covering; hiding from  
the sight.

**VEIL/LESS**, *a.* Destitute of a veil.

**VEIN**, *n.* [Fr. *veine*; *L. vena*, from the  
root of *venio*, to come, to pass. The  
sense is a passage, a conduit.] 1. In  
*anat.*, a long membranous canal which  
continually becomes wider, does not  
pulsate, and returns the blood from  
the arteries to the heart. The veins  
may be arranged in three divisions:  
1. Those that commence from the  
capillaries all over the body, and re-  
turn the blood to the heart; 2. The  
pulmonary veins; 3. The veins of the  
vena portae, in which the blood that  
has circulated through the organs of  
digestion is conveyed to the liver.  
The veins are composed, like arteries,

of three tunics or coats, which are much more slender than in the arteries, and are supplied internally with semilunar membranes or folds, called valves. All veins originate from the extremities of arteries, or, more properly speaking, from the capillary vessels which connect the veins and arteries, and terminate in the auricles of the heart. Their use is to return the blood from the arteries back to the heart.—2. In *plants*, a tube or an assemblage of tubes, through which the sap is transmitted along the leaves. The term is more properly applied to the finer and more complex ramifications, which interbranch with each other like net-work; the larger and more direct assemblages of vessels being called *ribs* and *nerves*. Veins are also found in the calyx and corol of flowers. The vessels which branch or variously divide over the surface of leaves are called *veins*.—3. In *geol.* and *mineral.*, cracks or fissures in rocks, filled up by substances different from the rock, and which may either be earthy or metallic. Veins are sometimes many yards wide, having an extent of many miles, and they ramify or branch out into innumerable smaller parts, often as slender as threads, like the veins of an animal; hence their name. Metallic veins are chiefly found in the primary, and lower, and middle secondary rocks. Many species of stones, as granite, porphyry, &c., are often found in *veins*.—4. A streak or wave of different colour, appearing in wood, marble, and other stones; variegation.—5. A cavity or fissure in the earth or in other substance.—6. Tendency or turn of mind; a particular disposition or cast of genius; as, a rich *vein* of wit or humour; a satirical *vein*.

Invoke the muses, and improve my *vein*.  
*Waller.*

#### 7. Current.

He can open a *vein* of true and noble thinking.  
*Swift.*

8. Humour; particular temper.—9. Strain; quality; as, my usual *vein*.  
VEIN, *v. t.* To mark or form with veins.  
VEINAL, *a.* Relating to the veins.  
VEINED, *a.* [from *vein*.] Full of veins; streaked; variegated; as, *veined* marble.—2. In *bot.*, having vessels branching over the surface, as a leaf.

VEINING, *a.* Forming veins.  
VEINLESS, *a.* In *bot.*, having no veins; as, a *veinless* leaf.

VEIN STONES, *n.* Gangues; the mineral substances which accompany and often enclose the metallic ores in veins.

VEINY, *a.* Full of veins; as, *veiny* marble; *veiny* leaves.

VELARIUM, *n.* [L.] The great awning which by means of tackle was hoisted over the Roman theatre or amphitheatre, to protect the spectators from the rain or the sun's rays.

VELELLA, *n.* [L. *velum*.] In *zool.*, a genus of acephalous animals, that are wafted on the water.

VELIFEROUS, *a.* [L. *velum*, a sail, and *fero*, to bear.] Bearing or carrying sails.

VELITATION, † *n.* [L. *velitatio*.] A dispute or contest; a slight skirmish.

VELIVOLANT, *a.* [L. *velum* and *volo*.] Passing under full sail.

VELL, *n.* [Qu. *fell*, a skin.] A rennet bag. [*Local*.]

VELL, *v. t.* [Qu. *fell*, a skin.] To cut off the turf or sward of land. [*Local*.]

VELLA, *n.* A genus of plants; class and order Tetradynamia siliculosa; nat. order Cruciferae. *V. annua*, annual cress rocket, is a British plant which was found growing on Salisbury plain by Lawson. It has doubly pinnatifid leaves, deflexed pouches; the flowers are pale yellow with purplish veins.

VELLETTY, *n.* [Fr. *velleté*; from L. *velle*, to will.] A term by which the schools express the lowest degree of desire.

VELLET, } † *n.* Velvet,—which see.  
VELLUTE, }

VELLIGATE, *v. t.* [L. *vellico*, from *vello*, to pull. It may be from the root of *pull*.] To twitch; to stimulate; applied to the muscles and fibres of animals; to cause to twitch convulsively.

VELLIGATED, *pp.* Twitched or caused to twitch.

VELLIGATING, *ppr.* Twitching; convulsing.

VELLICATION, *n.* The act of twitching, or of causing to twitch.—2. A twitching or convulsive motion of a muscular fibre.

VELLICATIVE, *a.* Having the power of vellicating, plucking, or twitching.

VELOPED, *pp.* In *her.*, a cock is said to be armed, crested, and *veloped*, when his spurs, comb, and gills are borne of a different tincture from the body.

VELLOU, } *n.* [Sp.] A kind of Spanish  
VELLOU, } money of account. The  
*reale de vellou* is worth about 2½d.  
English. *Murray's H. B. of Spain.*

VELLOZIA, *n.* Tree lily, a genus of plants, nat. order Bromeliaceae. They have the appearance of lilies with a perennial stem, two to ten feet high. They give a peculiar aspect to the flora of some districts of South America.

VELLUM, *n.* [Fr. *velin*. It coincides with *fell*, D. *veil*, skin; probably from the root of L. *vello*.] A fine kind of parchment made of calf's skin, and rendered clear, smooth, and white for writing on.

VELLUM-PÖST, *n.* A particular sort of superior writing paper.

VELLUMY, *a.* Resembling vellum.

VELO'CE, in *music*, quick. When this term is prefixed to a movement, it signifies that the movement is to be performed in a rapid manner.

VELOCIPEDA, *n.* [L. *velox*, swift, and *pes*, foot.] 1. A carriage for one person, having two wheels placed one before the other, in the same line, and connected by a beam, on which the person sits astride, and propels the vehicle, by striking the tips of his toes



against the earth. The front wheel may be turned at pleasure, so that the rider may give any direction to the machine. This species of vehicle was invented by M. Drais at Mannheim, in 1817. It was improved by Knight in England, who received a patent for it,

but it never came into general use.—2. A name given to a boat, car, or other vehicle, which moves with rapidity.—3. Any thing which moves with velocity.

VELOCITY, *n.* [Fr. *velocité*; L. *velocitas*, from *velox*, swift, allied to *volo*, to fly.] 1. Swiftmess; celerity; rapidity; as, the *velocity* of wind; the *velocity* of a planet or comet in its orbit or course; the *velocity* of a cannon ball; the *velocity* of light. In these phrases, *velocity* is more generally used than *celerity*. We apply *celerity* to animals; as, a horse or an ostrich runs with *celerity*, and a stream runs with *rapidity* or *velocity*; but bodies moving in the air or in ethereal space, move with greater or less *velocity*, not *celerity*. This usage is arbitrary, and perhaps not universal.—2. In *physics*, velocity is that affection of motion by which a body moves over a certain space in a certain time; or, it is the measure of the degree in which a body moves quickly or slowly; that is, one body is said to have a greater velocity than another, when it moves over a greater space in the same time, or an equal space in a less time. The velocity of a body is *uniform* when it passes through equal spaces in equal times, and it is *variable* when the spaces passed through in equal times are unequal. The velocity of a body is *accelerated* when it passes through a greater space in equal successive portions of time; and it is *retarded*, when a less space is passed through in each successive portion of time.—*Absolute velocity* is that in which the velocity of a body is considered simply in itself or as passing over a certain space in a certain time.—*Relative velocity* is that which has respect to the velocity of another moving body.—*Angular velocity*, the velocity of a body revolving about a fixed point or axis, or oscillating about a fixed point. The angular velocity of a planet is estimated by the angle described at the centre of the sun, by a straight line drawn from that point to the planet, called the *radius rector*.—*Initial velocity*, the velocity with which a body begins to move. When the motion of a body is uniform, its velocity is measured by the space described by it in a unit of time, as one second. If the motion of the body is not uniform, its velocity is measured by the space which it would describe uniformly in a given time, if the motion became and continued uniform from that instant of time. The unit of space and time taken in order to measure velocity, may be assumed of any magnitude, but in theoretical mechanics, one second is usually taken as the unit of time, and one foot as the unit of space; so that if a body is said to have a velocity of 25, it is implied that the body is moving at such a rate as would cause it to describe uniformly 25 feet in one second.—*Virtual velocities*.—[See under VIRTUAL.]  
VELVURE, † *n.* [Fr. *velours*.] Velvet.  
VELVET, † *n.* [It. *velluto*; Sp. *velludo*; Fr. *velours*; L. *vellus*, hair, nap.] A rich silk stuff, covered on the outside with a close, short, fine, soft shag or nap. It is extensively used for ladies' dresses, and various other purposes. The same name is given to cotton stuffs manufactured in the same way, which are also called *velveteens*.  
VELVET, *v. t.* To paint velvet.

VEL/VET, } *a.* Made of velvet; or  
VEL/VETY, } soft and delicate, like  
velvet; as, the skin of an animal or the  
surface of a plant.

VELVETÉEN, *n.* A kind of cloth made  
of cotton in imitation of velvet; cotton  
velvet.

VEL/VETING, *n.* The fine shag of  
velvet.

VEL/VET-PAVED, *a.* Paved with  
velvet.

VEL/VET-RUN'NER, *n.* In *zool.*, a  
bird having black and smooth feathers.

VENA, *n.* [L.] A vein. *Vena cava*, in  
*anat.*, the largest vein in the body, so  
named from its great cavity, into  
which, as a common channel, all the  
lesser veins, except the pulmonaries,  
empty themselves. This vein receives  
the blood from the extremities, and  
other parts, and transmits it to the  
heart. It is distinguished into the  
*superior* and *inferior*. *Vena porta*, the  
great vein situated at the entrance of  
the liver. It receives the blood from  
the abdominal viscera, and carries it  
into the substance of the liver. It is  
distinguished into two portions, the  
*hepatic* and *abdominal*. *Vena contracta*,  
in *hydraulics*. [See CONTRACTED VEIN.]

VENAL, *a.* [L. *vena*, a vein.] Pertaining  
to a vein or to veins; contained in  
the veins; as, *venal* blood. [See  
VENOUS, which is generally used.]

VENAL, *a.* [L. *venalis*, from *veneo*, to  
be sold.] 1. Mercenary; prostitute;  
that may be bought or obtained for  
money or other valuable consideration;  
as, a *venal* muse; *venal* services.—2.  
That may be sold; set to sale; as, all  
offices are *venal* in a corrupt govern-  
ment.—3. Purchased; as, a *venal* vote.

VENALITY, *n.* Mercenariness; the  
state of being influenced by money;  
prostitution of talents, offices, or ser-  
vices for money or reward; as, the  
*venality* of a corrupt court.

VEN'ARY, *a.* [L. *venor*, to hunt.] Relat-  
ing to hunting.

VENAT'IC, } *a.* [L. *venaticus*, from  
VENAT'ICAL, } *venor*, to hunt.] Used  
in hunting.

VENAT'ION, *n.* [L. *venatio*, from *venor*,  
to hunt.] 1. The act or practice of  
hunting.—2. The state of being hunted.  
—3. In *bot.*, the manner in which the  
veins of leaves are arranged.

VENATOR'IAL, *a.* Relating to hunt-  
ing; venatic.

VEND, *v. t.* [L. *vendo*; Fr. *vendre*; It.  
*vendere*; Sp. *vender*.] To sell; to  
transfer a thing and the exclusive  
right of possessing it, to another person  
for a pecuniary equivalent; as, to *vend*  
goods; to *vend* meat and vegetables in  
market. Vending differs from *barter*.  
We *vend* for money; we *barter* for  
commodities. *Vend* is applicable only  
to wares, merchandise, or other small  
articles, not to lands and tenements.  
We never say, to *vend* a farm, a lease,  
or a bond, a right or a horse.

VEND'ED, *pp.* Sold; transferred for  
money; as goods.

VENDEE', *n.* The person to whom  
a thing is sold. Opposed to *vendor*.

VENDEMI'AIRE, *n.* [Fr. from L.  
*vindemia*, to gather grapes.] The first  
month of the French republican calen-  
dar. It was so called from its being  
the vintage season. It began Sept.  
21 or 22, and ended Oct. 21.

VEND'ER, *n.* [Fr. *vendeur*.] A seller;  
one who transfers the exclusive right  
of possessing a thing, either his own,  
or that of another, as his agent. Auc-

tioners are the *venders* of goods for  
other men.

VENDIBILITY, } *n.* The state of  
VEND'IBLENESS, } being vendible  
or saleable.

VEND'IBLE, *a.* [L. *vendibilis*.] Sale-  
able; that may be sold; that can be  
sold; as, *vendible* goods. Vendible  
differs from *marketable*; the latter  
signifies *proper* or *fit* for *market*,  
according to the laws or customs of a  
place. *Vendible* has no reference to  
such legal fitness.

VEND'IBLE, *n.* Something to be sold  
or offered for sale.

VEND'IBLY, *adv.* In a saleable manner.

VENDIT'ATION, } *n.* [L. *venditatio*.]  
A boastful display.

VENDI'TION, *n.* [Fr. from L. *venditio*.]  
The act of selling; sale.

VEND'OR, *n.* A vender; a seller.

VENDÜE', } *n.* [Fr. *vendu*, sold.] Auc-  
tion; a public sale of any thing by out-  
cry, to the highest bidder.

VENDÜE-MÄSTER, } *n.* A salesman;  
an auctioneer.

VENDÜE-ROOMS, } *n. pl.* Sale-rooms;  
auction-rooms. [This word, and the  
preceding, once common in some parts  
of Britain, are still used in the United  
States, and the West Indies.]

VENEER, *v. t.* [G. *furnieren*.] This  
word seems to be from the root of  
*furnish*, the primary sense of which is  
to *put on*. To lay, or fix firmly, thin  
leaves of a fine or superior wood, over  
a coarse or inferior wood, so as to give  
the latter the appearance of a solid  
mass of the former.

VENEER, *n.* A thin piece of wood of a  
more valuable kind laid upon another  
of a more common sort, so that the  
whole substance appears to be of the  
more valuable sort.

VENERED, *pp.* Overlaid with a thin  
leaf of a superior wood.

VENERING, *ppr.* Overlaying with a  
thin leaf of a superior wood.

VENEERING, *n.* The operation or art  
of laying thin leaves of a superior kind  
of wood upon a ground or foundation  
of an inferior material, by which the  
whole substance has the appearance of  
the more valuable kind. In this man-  
ner articles are produced of elegant  
appearance, at smaller cost than if they  
were made solid, or composed entirely  
of the fine wood which covers their  
surface. Veneering is sometimes ap-  
plied in architecture to doors and other  
surfaces, but more usually to articles  
of furniture. *Marquetry* is a more  
complicated kind of veneering or inlaid  
work, in which pieces of various kinds  
of wood, and sometimes of horn, ivory,  
and metal, are arranged so as to pro-  
duce a complicated effect.—2. The  
covering of fine wood laid upon the  
surface of the coarser material. This  
word is also written *vaneering* and  
*fineering*.

VENERI'CAL, } *a.* [L. *veneficium*.]  
VENERI'CIOUS, } Acting by poison;  
bewitching. [Little used.]

VEN'EFICE, } *n.* [L. *veneficium*.] The  
practice of poisoning.

VENERI'CIOUSLY, *adv.* By poison  
or witchcraft. [Little used.]

VEN'EMOUS. See VENOMOUS.

VEN'ENATE, *v. t.* [L. *veneno*; *venenum*,  
poison, W. *gwenny*, from *raging*.]  
To poison; to infect with poison.

VENEN'ATION, *n.* The act of poison-  
ing.—2. Poison; venom.

VENENE, } *n.* [Fr. *venenez*.]  
VEN'ENOSE, } Poisonous; venomous.

VENERABILITY, } *n.* State or quality  
of being venerable.

VENERABLE, *a.* [Fr. from L. *venerabilis*,  
from *veneror*, to honour, to worship.]  
1. Worthy of veneration  
or reverence; deserving of honour and  
respect; as, a *venerable* magistrate; a  
*venerable* parent.—2. Rendered sacred  
by religious associations, or being con-  
secrated to God and to his worship;  
to be regarded with awe and treated  
with reverence; as, the *venerable* walls  
of a temple or church.

The places where saints have suffered  
for the testimony of Christ...rendered  
*venerable* by their death. *looker*.

VENERABLENESS, *n.* The state or  
quality of being venerable.

VENERABLY, *adv.* In a manner to  
excite reverence.

An awful pile! stands *venerably* great.  
*Addison*.

VENERATE, *v. t.* [Fr. *venerer*; L.  
*veneror*.] To regard with respect and  
reverence; to reverence; to revere.  
We *venerate* an old faithful magis-  
trate; we *venerate* parents and elders;  
we *venerate* men consecrated to sacred  
offices. We *venerate* old age or gray  
hairs. We *venerate*, or ought to *vere-  
rate*, the gospel and its precepts.  
And seem'd to *venerate* the sacred shade.  
*Dryden*.

VEN'ERATED, *pp.* Reverenced;  
treated with honour and respect.

VENERATING, *ppr.* Regarding with  
reverence.

VENERATION, *n.* [Fr. from L. *veneratio*.]  
The highest degree of respect  
and reverence; respect mingled with  
some degree of awe; a feeling or sen-  
timent excited by the dignity and su-  
periority of a person, or by the sacred-  
ness of his character, and with regard  
to place, by its consecration to sacred  
services.

We find a secret awe and *reneration* for  
one who moves about us in a regular and  
illustrious course of virtue. *Addison*.

2. Among *phrenologists*, the organ  
which produces the sentiment of  
respect and reverence; and, when  
directed to the Supreme Being, adora-  
tion. It is the source also of the ten-  
dency to look up to and admire supe-  
riors in rank and power. It is also  
the chief source of filial piety. It is  
situated at the middle of the coronal  
region of the brain, at the bregma or  
fontanel of anatomists. When too  
energetic, it leads to superstition and  
religious enthusiasm.

VEN'ERATOR, *n.* One who venerates  
and reverences.

VENE'REAL, *a.* [L. *venereus*, from  
*Venus*; W. *Gwener*, from *gwen*, white,  
fair. See VENUS.] 1. Pertaining to  
sexual intercourse.—2. Connected with  
sexual intercourse; as, a *venereal* dis-  
ease; *venereal* virus or poison.—3.  
Adapted to the cure of venereal dis-  
eases; as, *venereal* medicines.—4.  
Adapted to excite venereal desire;  
aphrodisiac.—5. † Consisting of or per-  
taining to copper, formerly called by  
chemists *Venus*.

VENE'REAN, } *a.* Venereal.

VENE'REOUS, *a.* [L. *venereus*.] Lust-  
ful; libidinous.

VENERI'CAR'DIA, *n.* A genus of  
equivalved, inequilateral, marine, ob-  
long bivalves, found at considerable  
depths in the ocean in mud and sand.

VENERIDÆ, *n.* A family of concha-  
ceous molluscs, founded upon the genus  
*Venus* of Linnaeus, and comprising

also the genera *Cyrena*, *Cyprina*, *Cytherea*, *Venericardia*.

VEN'EROUS, † for *Veneroseus*.

VEN'ERY, *n.* [from *Venus*.] Sexual intercourse.

Contentment, without the pleasure of lawful *venery*, is continence; of unlawful, chastity. *Greiv.*

VEN'ERY, *n.* [Fr. *venerie*; from *L. venor*, to hunt, that is, to drive or rush.] The act or exercise of hunting; the sports of the chase.

Beasts of *venery* and fishes. *Brown.*

VENESEC'TION, *n.* [*L. vena*, vein, and *sectio*, a cutting.] The act or operation of opening a vein for letting blood; blood-letting; phlebotomy

VENE'TIAN, *a.* Belonging to Venice.

—*Venetian chalk*, a white compact talc or steatite, used for marking on cloth, &c.—*Venetian door*, a door having long narrow side lights for lighting an entrance-hall, &c.—*Venetian window*, a window formed with three apertures, separated by slender pierces, the middle aperture being much larger than the others.—*Venetian blind*, a peculiar blind for windows, formed of slips of wood so connected and disposed as to overlap each other when close, and to show a series of open spaces for the admission of air and light when in the other position.—*Venetian school*, in *painting*, that school the distinguishing character of which is colouring, and a consummate knowledge of chiaro-oscuro; in both of which respects all is grace, spirit, and faithful adherence to nature. Titian, Paul Veronese, Giorgione, Tintoretto, and many other illustrious names, adorn the Venetian school of painting.

VEN'EY, } *n.* [Fr. *venez*, from *venir*,  
VEN'EW, } to come.] A bout; a thrust; a hit; a turn at fencing.

Three *veney*s for a dish of stewed prunes. †

VEN'GE, † *v. t.* (venj.) [Fr. *venger*.] To avenge; to punish. [See AVENGE and REVENGE.]

VEN'GEABLE, † *a.* (venj'able.) [from *venge*.] Revengeful; as, *vengeable* despite.

VEN'GEANCE, *n.* (venj'ance.) [Fr. from *venger*, to revenge, *L. vindico*.] The infliction of pain on another, in return for an injury or offence. Such infliction, when it proceeds from malice or mere resentment, and is not necessary for the purposes of justice, is revenge, and a most heinous crime. When such infliction proceeds from a mere love of justice, and the necessity of punishing offenders for the support of the laws, it is *vengeance*, and is warrantable and just. In this case, vengeance is a just retribution, recompense, or punishment. In this latter sense the word is used in Scripture, and frequently applied to the punishments inflicted by God on sinners.

To me belongeth *vengeance* and recompense; Deut. xxxii.

The Lord will take *vengeance* on his adversaries; Nah. i.

With a *vengeance*, in *familiar lan.*, signifies with great violence or vehemence; as, to strike one with a *vengeance*. Formerly, *what a vengeance*, was a phrase used for *what* emphatical.

But *what a vengeance* makes thee fly? *Hudibras*.

VEN'GEFUL, *a.* (venj'ful.) Vindictive; retributive; as, God's *vengeful* ire.—2. Revengeful.

VEN'GEFULLY, *adv.* Vindictively.

VEN'GEMENT, *n.* (venj'ment.) A vengeance; penal retribution. [*Avengement* is generally used.]

VEN'GER, † *n.* An avenger.

VEN'I, YIDI, VICI. [L.] I came, I looked, I conquered. These were the words which Cæsar used when he informed the Roman senate of his victories in Gaul.

VEN'NIABLE, † *a.* [See VENIAL.] Venial; pardonable.

VEN'NIABLY, † *adv.* Pardonably; excusably.

VEN'NIAL, *a.* [It. *veniale*; Sp. *venial*; Fr. *veniel*; from *L. venia*, pardon, leave to depart, from the root of *venio*, and signifying literally a going or passing.]

1. That may be forgiven; pardonable; as, a *venial* fault or transgression.—

*Venial sin*, in the *Roman catholic church*, a sin which weakens sanctifying grace, but does not destroy it like mortal or deadly sins. It does not, therefore, exclude from absolution or communion, when there is evidence of repentance. The reformed churches hold all sins to be *venial*, through the merits of the Redeemer; but the most trifling sins not to be *venial*, except through the righteousness and atonement of Christ.—2. In *familiar lan.*, excusable; that may be allowed or permitted to pass without censure; as, a *venial* slip or fault.—3. Allowed.

Permitting him the while

*Venial* discourse unblam'd. *Milton*.

VENIALITY, *n.* Quality of being venial.

VEN'NIALLY, *adv.* In a venial manner; pardonably.

VEN'NIALNESS, *n.* State of being excusable or pardonable.

VEN'NICE TURPENTINE, *n.* A resinous matter got from the *Abies pectinata*, or silver fir.

VEN'IRE FACIAS, or VEN'IRE. In law, a writ or precept directed to the sheriff, requiring him to cause a jury to come or appear in the neighbourhood where a cause is brought to issue, to try the same. It is also a writ in the nature of a summons, to cause the party indicted on a penal statute to appear.

VEN'I, SANCTE SPIRITUS. [L. come, Holy Spirit.] The name given to a mass, celebrated by Roman catholics to invoke the assistance of the Holy Spirit.

VENISON, *n.* (ven'izn, or ven'zn.) [Fr. *venaison*, from *L. venatio*, a hunting, from *venor*, to hunt.] The flesh of beasts of game, or of such wild animals as are taken in the chase, particularly those of the deer kind.

VEN'OM, *n.* [Fr. *venin*; It. *veneno*; L. *venenum*; W. *gweneyn*.] It appears by the Welch word and its affinities, that the primary sense is raging, furious, and hence it is to be referred to the root of *L. venor*, to hunt, to drive, or chase; *venio*, to come. See VENUS, &c.] 1. Poison; matter fatal or injurious to life. *Venom* is generally used to express noxious matter that is applied externally, or that is discharged from animals, as that of bites and stings of serpents, scorpions, &c.; and *poison*, to express substances taken into the stomach.—2. Spite; malice.

VEN'OM, *v. t.* To poison; to infect with venom. [Little used, but *evenom* is in use and elegant. *Venom* may be elegantly used in poetry.]

VEN'OMED, *pp.* Poisoned; infected with poison.

VEN'OM-MOUTH'ED, *a.* Apt to bite.

VEN'OMOUS, *a.* Poisonous; noxious to animal life; as, the bite of a serpent may be *venomous*. The sack at the base of the rattlesnake's teeth, contains *venomous* matter.—2. Noxious; mischievous; malignant; as, a *venomous* progeny.—3. Spiteful; as, a *venomous* writer.

VEN'OMOUSLY, *adv.* Poisonously; malignantly; spitefully.

VEN'OMOUSNESS, *n.* Poisonousness; noxiousness to animal life.—2. Malignity; spitefulness.

VEN'OUS, *a.* [*L. venosus*, from *vena*, a vein.] 1. Pertaining to a vein or to veins; contained in veins; as, *venous* blood, which is distinguishable from arterial blood by its darker colour.—

2. In *bot.*, veined. A *venous leaf* has vessels branching, or variously divided, over its surface.

VENT, *n.* [Fr. *vente*, Sp. *venta*, sale, from *vendre*, Sp. *vender*; from the root of *L. venio*, Eng. *wind*, &c.; properly a passage.] 1. A small aperture; a hole or passage for air or other fluid to escape; as, the *vent* of a cask.—

2. The flue or funnel of a chimney.—

3. The touch-hole or the opening in a cannon or other piece of artillery, by which fire is communicated to the charge.—*Vent-field*, that part of a gun or howitzer between the breech mouldings and the astragal.—*Vent-astragal*, that part of a gun or howitzer which determines the vent-field.—4. Passage from secrecy to notice; publication.—

5. The act of opening.—6. Emission; passage; escape from confinement; as, his smothered passions urge for *vent*.—7. Discharge; utterance; means of discharge.

Had like grief been dew'd in tears,  
Without the vent of words. *Milton*.

8. Sale; as, the *vent* of a thousand copies of a treatise.—9. Opportunity to sell; demand.

There is no *vent* for any commodity except wool. *Temple*.

10. † [Sp. *venta*.] An inn; a baiting place.—11. In *birds* and *fishes*, the place for the discharge of excrement.—To give *vent* to, to suffer to escape; to let out; to pour forth.

VENT, *v. t.* To let out at a small aperture.—2. To let out; to suffer to escape from confinement; to utter; to pour forth; as, to *vent* passion or complaint. The queen of heav'n did thus her fury *vent*. *Dryden*.

3. † To utter; to report.—4. To publish. The sectators did greatly enrich their inventions by *venting* the stolen treasures of divine letters. † *Raleigh*.

5. To sell. Therefore did those nations *vent* such spice. † *Raleigh*.

[Instead of *vent*, in the latter sense, we use *vend*.]

VENT, † *v. i.* To snuff.

VEN'TA, *n.* [Sp.] A mean inn; a way-side tavern.

VEN'TAGE, † *n.* A small hole, as of a flute.

VEN'TAIL, } *n.* [Fr. a folding door.]  
VEN'TAYLE, } The visor or movable front of a helmet which covered the entire face, and through apertures in which air was breathed. Also, called *aventail*.

VEN'TAN'NA, } *n.* [Sp. *ventana*.] A  
VENTAN'A, } window. [Not Eng-  
lish.]

VEN'TER, *n.* One who utters, reports, or publishes.

**VENT'ER**, *n.* [L.] In *anat.*, the abdomen, or lower belly; formerly applied to any large cavity containing viscera, as the head, thorax, and abdomen, called the three *venters*.—2. The womb; and hence, mother. A. has a son B. by one *venter*, and a daughter C. by another *venter*; children by different *venters*.—3. The belly of a muscle.—4. In *entom.*, the lower part of the abdomen.

**VENT'-HOLE**, *n.* A small aperture to let out the air.

**VENT'IDUCT**, *n.* [L. *ventus*, wind, and *ductus*, a canal; It. *ventidotti*.] In *arch.*, a passage for wind or air; a subterraneous passage or pipe for ventilating apartments.

**VENT'ILATE**, *v. t.* [L. *ventilo*, from *ventus*, wind; Fr. *ventiler*.] 1. To fan with wind; to open and expose to the free passage of air or wind; to supply with fresh air; as, to *ventilate* a room; to *ventilate* a cellar.—2. To cause the air to pass through; as, to *ventilate* a mine.—3. To winnow; to fan; as, to *ventilate* wheat.—4. † To examine; to discuss; that is, to agitate; as, to *ventilate* questions of policy.

**VENT'ILATED**, *pp.* Exposed to the action of the air; supplied with fresh air; fanned; winnowed; discussed.

**VENT'ILATING**, *ppr.* Exposing to the action of wind; supplying with fresh air; fanning; discussing.

**VENTILA'TION**, *n.* [Fr. from L. *ventilatio*.] 1. The act of ventilating; the art or operation of supplying buildings, apartments, and other confined places, with a necessary quantity of fresh air, so as to maintain the atmosphere in such places in a constant state of purity.—2. The act of fanning or winnowing, for the purpose of separating chaff and dust.—3. † Vent; utterance.—4. † Refrigeration.

**VENTILATOR**, *n.* An instrument or machine for expelling foul or stagnant air from any close place or apartment, and introducing that which is fresh and pure. Ventilators are of very various constructions and sizes.

**VENT'ING**, *ppr.* Letting out; uttering.

**VENTOSE'**, *a.* Windy; flatulent.

**VENT'OSE**, † *n.* A cupping glass.

**VENTOSE**, *n.* [Fr., pr. *van-tôze*; from the Lat. *ventus*, wind, on account of the usual windiness of the season thus indicated.] The sixth month of the French republican year. It was composed of thirty or of thirty-one days, beginning Feb. 20, and ending March 20, or it ran from Feb. 19 to March 20; according as the year was bissextile or otherwise.

**VENTOSITY**, *n.* [Fr. *ventosité*; from L. *ventosus*.] Windiness; flatulence.

**VENT'-PEG**, *n.* A peg to stop a vent-hole.

**VEN'TRAL**, *a.* [from L. *venter*, belly.] Belonging to the belly. The *ventral fins*, in fishes, are placed between the anus and the throat.

**VEN'TRICLE**, *n.* [L. *ventriculus*, from *venter*, belly.] In a *general sense*, a small cavity in an animal body. It is applied to the stomach. It is also applied to two cavities of the heart, distinguished as the *right* and *left ventricles*, which propel the blood into the arteries. The word is also applied to cavities in different parts of the brain.

**VENTRICOUS**, } *a.* [L. *ventricosus*,  
**VENTRICOSE**, } from *venter*, belly.]  
In *bot.*, bellied; distended; swelling out in the middle; as, a *ventricous* perianth.—2. In *conchology*, applied to

shells which are inflated, or which swell in the middle.

**VENTRIC'ULAR**, *a.* Pertaining to a ventricle; bellied; distended in the middle.

**VENTRIC'ULITES**, *n.* A genus of spongioid Zoophytes found fossil in flints, and in the chalk.

**VENTRIC'ULOUS**, *a.* [supra.] Somewhat distended in the middle.

**VENTRILOCUTION**, *n.* A speaking after the manner of a ventriloquist.

**VENTRIL'O'QUIAL**, *a.* Pertaining to ventriloquism.

**VENTRIL'OQUIISM**, } *n.* [L. *venter*,  
**VENTRIL'OQUY**, } belly and *lo-*  
*quor*, to speak.] The act, art, or practice of speaking or uttering sounds in such a manner that the voice appears to come, not from the person, but from some distant place, as from the opposite side of the room, from the cellar, &c. This was formerly supposed to be done by forming the articulations in the cavity of the chest or of the belly; hence the name. Ventriloquism may be regarded as a species of vocal mimicry of sounds, by which an illusion is produced on the hearer, who imagines that the sound comes, not from the mimic, but from some other appropriate source, at a given or varying distance, and in any or even several directions successively. To make the illusion perfect, the imitations require to be made without moving the lips, features, or body. The art of the ventriloquist is said to consist merely in this: after drawing a long breath so as to fill the lungs with air, he employs, during expiration, such organs of voice as can be used with as little movement of the lips, mouth, or cheeks as is compatible with the pronunciation of certain words or sounds. By a dexterous management of the tones of his voice in uttering such words or sounds in the way described, he easily leads his hearers to imagine that the sounds come from a person in a box, or up the chimney, or from inanimate objects, and, to aid the deception, he endeavours by various contrivances to divert the attention of his auditors. The word *Ventriloquy* is little used.

**VENTRIL'OQUIST**, *n.* One who speaks in such a manner that his voice appears to come from some distant place.

The ancient *ventriloquists* seemed to speak from their bellies. *Encyc.*

**VENTRIL'OQUOUS**, *a.* Speaking in such a manner as to make the sound appear to come from a place remote from the speaker.

**VENTURE**, *n.* [Fr. *aventure*; It. and Sp. *ventura*; from L. *venio*, *ventus*, *venturus*, to come.] 1. A hazard; an undertaking of chance or danger; the risking of something upon an event which cannot be foreseen with tolerable certainty.

I, in this *venture*, double gains pursue. *Dryden.*

2. Chance; hap; contingency; luck; an event that is not or cannot be foreseen.—3. The thing put to hazard; particularly, something sent to sea in trade.

My *ventures* are not in one bottom trusted. *Shak.*

At a *venture*, at hazard; without seeing the end or mark; or without foreseeing the issue.

A bargain at a *venture* made. *Hudibras.*

A certain man drew a bow at a *venture*; 1 Kings xxii.

**VEN'TURE**, *v. i.* To dare; to have courage or presumption to do, undertake, or say. A man *ventures* to mount a ladder; he *ventures* into battle; he *ventures* to assert things which he does not know.—2. To run a hazard or risk. Who freights a ship to *venture* on the seas. *Dryden.*

To *venture* at, to *venture* on or upon, to dare to engage in; to attempt without any certainty of success. It is rash to *venture* upon such a project.

And when I *venture* at the comic style. *Waller.*

**VEN'TURE**, *v. t.* To expose to hazard; to risk; as, to *venture* one's person in a balloon.—2. To put or send on a *venture* or chance; as, to *venture* a horse to the West Indies.

**VEN'TURED**, *pp.* Put to the hazard; risked.

**VEN'TURER**, *n.* One who ventures or puts to hazard.

**VEN'TURESOME**, *a.* Bold; daring; intrepid; as, a *venturesome* boy.

**VEN'TURESOMELY**, *adv.* In a bold, daring manner.

**VEN'TURESOMENESS**, *n.* Quality of being venturesome.

**VEN'TURING**, *ppr.* Putting to hazard; daring.

**VEN'TURING**, *n.* The act of putting to risk; a hazarding.

**VEN'TUROUS**, *a.* Daring; bold; hardy; fearless; intrepid; adventurous; as, a *venturous* soldier.

With *vent'rous* arm *Milton.*

He pluck'd, he tasted.

**VEN'TUROUSLY**, *adv.* Daringly; fearlessly; boldly.

**VEN'TUROUSNESS**, *n.* Boldness; hardness; fearlessness; intrepidity. The event made them repent of their *venturousness*.

**VEN'UE**, *n.* [L. *vicinia*; Norm. *visne*.] In *law*, a neighbourhood or near place; the place where an action is laid. The county in which the trial of a particular cause takes place, is said to be the *venue* of that cause. Originally jurors were summoned from the immediate neighbourhood where a fact happened, to try it by their own knowledge, but they are now summonable from the body of the county. In what are termed *local actions*, the actual place in which the subject matter is situated must be laid as the *venue* in the action; but in those actions termed *transitory*, that is, actions of debt, contract, for personal injuries, &c., any county may be laid as the *venue* in the action. In *criminal trials*, the *venue* is the county in which the offence charged was actually committed. The courts, however, have a discretionary power of changing the *venue*, both in civil and criminal cases.

**VEN'UE**, *n.* A thrust. [See *VENEY*.]

**VEN'ULES**, *n. plur.* [L. *venula*, a small vein.] In *bot.*, the name given to the last ramifications of the veins of a leaf, which intermingle frequently, and form the skeleton of the leaf.

**VEN'ULITE**, *n.* A petrified shell of the genus *Venus*.

**VEN'US**, *n.* [L.; W. *Gwener*, from *gwen*, white, fair, the feminine of *gwyn*, white, fair, that affords happiness; also *gwynn*, rage, violent impulse of the mind, lust, smart; *gwynnau*, to whiten; *gwynn*, wind, L. *ventus*; *gwynnawg*, full of rage; *gwent*, an open country; *gweny*, to smile; *gwenwynn*, poison, L. *venenum*, Eng. *venom*; *gwentynaw*, to poison, to fret,

or irritate. These affinities lead to the true origin of these words. The primary sense of the root is to shoot or rush, as light or wind. From light is derived the sense of white, fair, Venus, or it is from opening, parting; and from rushing, moving, comes *wind*, and the sense of raging, fury, whence *L. venenum*, poison, that which frets or causes to rage. These words all coincide with *L. venio*, which signifies to rush, to fall, to happen; *venor*, to hunt, &c. The Greeks had the same idea of the goddess of love, viz., that her name signified fairness, whiteness, and hence the fable that she sprung from froth, whence her Greek name *Αφροδιτη*, from *αφρος*, froth. But Venus may be from lust or raging.] 1. In *myth.*, the goddess of beauty and love; that is, beauty or love deified; just as the Gaelic and Irish *diana*, swiftness, impetuosity, is denominated the goddess of hunting. The poets mention two of the name Venus, the elder daughter of Uranus and the younger daughter of Jupiter and Dione, but the events in the history of the two are often confounded. She is represented by the Greeks as the highest ideal of female beauty and love, sometimes entirely naked and sometimes but slightly covered. The most famous antique statue of Venus



Venus of Canova.

is the dé Medici found in the Villa Hadriana at Tivoli, and one of the most famous modern statues of this goddess is the Venus of Canova, where she is represented as rising from the bath.—2. In *astron.*, one of the inferior planets, the second in order of distance from the sun, and the most brilliant of all the planetary bodies. From her alternate appearance in the morning and evening, she was called by the ancients *Lucifer* and *Hesperus*, the morning and evening star. The distance of Venus from the sun is about 68 millions of miles; her diameter 7700 miles; and her period of revolution round the sun about 224 mean solar days. She revolves about an axis, and the time of rotation is about 23<sup>h</sup>. 21<sup>m</sup>., the axis of rotation being inclined to the ecliptic at an angle of about 75°. Her greatest angular distance from the sun is from 45° to 47° 12'. According to her various positions relatively to the sun and earth, she changes her phases like the moon, appearing *full* at the superior conjunction, *gibbous* between that point and the points of her greatest elonga-

tion, *half-mooned* at these points, and *crescent-shaped* or horned between these and the inferior conjunction. Venus is sometimes seen to pass over the disc of the sun, and this passage is called a *transit of Venus*. [See *TRANSIT*.]—3. In the *old chemistry*, a name given to copper.—4. In *conchology*, a Linnean genus of marine bivalve molluscs, including the common clam. The species are found buried in the sand, near the shore, particularly in hot climates. Most of the animals serve as food for man, and some of the shells are so beautiful as fully to justify the name given to the genus. The shells of *V. mercenaria* are, by the N. American Indians, formed into various ornaments.

**VENUS'S COMB**, *n.* A plant of the genus Scandix, the *S. pecten veneris*; called also shepherd's needle and needle-cherivil.

**VENUS'S FLY-TRAP**, *n.* A plant, *Dionaea muscipula*. It seizes and holds fast insects which brush against its leaves. [See *DIONÆA*.]

**VENUS'S LOOK'ING-GLASS**, *n.* A plant of the genus Campanula, the *C. speculum*.

**VENUS'S NA'VEL-WÖRT**, *n.* A plant of the genus Cynoglossum, the *C. linifolium*.

**VENUST'**, *† a.* [*L. venustus*.] Beautiful. **VERACIOUS**, *a.* [*L. verax*, from *verus*, true.] 1. Observant of truth; habitually disposed to speak truth.—2. True. [*Little used*.]

**VERACITY**, *n.* [It. *veracità*; from *L. verax*, from *verus*, true.] 1. Habitual observance of truth, or habitual truth; as, a man of *veracity*. His *veracity* is not called in question. The question of the court is, whether you know the witness to be a man of *veracity*. We rely on history, when we have confidence in the *veracity* and industry of the historian. "The *veracity* of facts," is not correct language. *Truth* is applicable to men and to facts; *veracity* to men only, or to sentient beings.—2. Invariable expression of truth; as, the *veracity* of our senses.

**VERANDA**, } *n.* An Oriental word **VERAN'DAH**, } denoting a kind of open portico, or a sort of light external gallery in front of a building with a sloping roof, supported on slender pillars, and frequently partly enclosed in front with lattice-work. In India almost every house is furnished with a veranda, which serves to keep the inner rooms cool and dark.

**VERA'TRIA**, } *n.* [*L. veratrum*.] A **VERA'TRINE**, } vegetable alkaloid, found in *Veratrum sabadilla*, *Veratrum album*, &c. It is generally obtained as a crystalline powder, nearly white, very acrid and poisonous, exciting, when introduced into the nostrils, violent and even dangerous sneezing. It is insoluble in water, but very soluble in alcohol. In the form of tincture, and still more in that of ointment, veratrine is much used as an external application in cases of neuralgia and obstinate rheumatic pains.

**VERA'TRIC ACID**, *n.* The acid with which veratria exists combined in *Veratrum sabadilla*. It crystallizes in short white transparent prisms, which are soluble in water and alcohol. It forms crystallizable salts with the alkalis, which are called *veratrates*. It is sometimes called *cevadillic* or *sabadillic acid*.

**VERA'TRUM**, *n.* A well known genus of plants, belonging to the nat. order Melanthaceæ. *Veratrum album*, com-



Veratrum album.

mon white hellebore, is a native of most alpine meadows in the southern, central, and northern parts of Europe, but is not a native of Britain. Two varieties are officinal. Every part of both varieties is acrid and poisonous, especially the rhizomas. *V. sabadilla*, is the species from which the vegetable alkaloid veratrine of the pharmacopœias is directed to be prepared. The *V. viride* of North America is an acrid emetic and powerful stimulant, followed by sedative effects.

**VERB**, *n.* [*L. verbum*; Fr. *verbe*; Sp. and It. *verbo*; Ir. *fearb*; probably from the root of *L. fero*.] 1. In *gram.*, a part of speech that expresses action, motion, being, suffering, or a request or command to do or forbear any thing. The verb affirms, declares, asks, or commands; as, *I write*; he *runs*; the river *flows*; they *sleep*; we *see*; they *are deceived*; *depart*; *go*; *come*; *write*; *does he improve*? When the action expressed by a verb is exerted on an object, or terminates upon it, the act is considered as passing to that object, and the verb is called *transitive*; as, *I read Livy*. When the act expressed by the verb, terminates in the agent or subject, the verb is called *intransitive*; as, *I run*; *I walk*; *I sleep*. When the agent and object change places, and the agent is considered as the instrument by which the object is affected, the verb is called *passive*; as, *Goliath was slain* by David.—2. A word.

**VERB'AL**, *a.* [Fr.; Lat. *verbalis*.] 1. Spoken; expressed to the ear in words; not written; as, a *verbal message*; a *verbal contract*; *verbal testimony*.—2. Oral; uttered by the mouth.—3. Consisting in mere words; as, a *verbal reward*.—4. Respecting words only; as, a *verbal dispute*.—5. Minutely exact in words, or attending to words only; as, a *verbal critic*.—6. Literal; having word answering to word; as, a *verbal translation*.—7. In *gram.*, derived from a verb; as, a *verbal noun*.—8. Verbose; abounding with words. **VERB'AL**, *n.* In *gram.*, a noun derived from a verb. **VERB'ALISM**, *n.* Something expressed orally. **VERB'ALIST**, *n.* One who deals in words merely; one skilled in words. **VERBALITY**, *n.* Mere words; bare literal expressions. **VERB'ALIZE**, *v. t.* To convert into a verb.

VERB'ALLY, *adv.* In words spoken; by words uttered; orally.—2. Word for word; as, to translate *verbally*.

VERBA'RIAN, *a.* Relating to, or consisting of words.

VERBAS'CIUM, *n.* Mullein, a genus of plants; nat. order Scrophulariaceæ. [See MULLEIN.]

VERBA'TIM, *adv.* [L.] Word for word; in the same words; as, to tell a story *verbatim* as another has related it.—*Verbatim et literatim*, word for word, and letter for letter.

VERBE'NA, *n.* Vervain, a genus of plants, the type of the nat. order Verbenaceæ. Most of the species are weeds, and are generally inhabitants of Europe and North America. *V. officinalis*, common vervain, a plant common in England, was once held in great repute for its medical virtues, and entered into the composition of various charms and love philters. Two species are cultivated: the one (*V. triphylla*, or *Aloysia citrodora*.) for its lemon-scented foliage, and the other (*V. anbletia*.) for the great beauty of its flowers.

VERBENA'CEÆ, *n.* A nat. order of plants, the species of which are trees or shrubs, sometimes only herbaceous plants, with generally opposite, simple, or compound leaves without stipules. The flowers are in opposite corymbs, or spiked alternately, sometimes in dense heads, and very seldom axillary or solitary. The species are common in the tropics of both hemispheres, and in the temperate districts of South America. They are not of much importance in a medicinal or economical point of view, with the exception of the teak-tree, and the *Lantana pseudothea*, used in infusion as tea in Brazil. The properties formerly ascribed to vervain appear to have been imaginary.

VER'BENATE, *v. t.* [L. *verbena*, vervain.] Strewed with vervain.

VER'BENATED, *pp.* Strewed or sanctified with vervain, according to a custom of the ancients.

VER'BENATING, *ppr.* Strewing with vervain.

VER'BERATE, *† v. t.* [L. *verbero*.] To beat; to strike.

VER'BERATION, *n.* A beating or striking blows.—2. The impulse of a body, which causes sound.

VERBES'INA, *n.* A genus of plants, nat. order Compositæ. The species are shrubs or herbaceous plants mostly natives of Central America. From the seeds of *V. sativa* a fixed oil is obtained, which has the reputation of being anthelmintic.

VERB'TAGE, *n.* [Fr.] Verbosity; use of many words without necessity; superabundance of words.

VERBOSE, *a.* [L. *verbosus*.] Abounding in words; using or containing more words than are necessary; prolix; tedious by a multiplicity of words; as, a *verbose* speaker; a *verbose* argument.

VERBÔSELY, *adv.* Wordily.

VERBOS'ITY, } *n.* Employment of  
VERBOS'ENESS, } a superabundance  
of words; the use of more words than are necessary; as, the *verbosity* of a speaker.—2. Superabundance of words; prolixity; as, the *verbosity* of a discourse or argument.

VERD. See VERT.

VER'DANCY, *n.* [See VERDANT.] Greenness.

VER'DANT, *a.* [Fr. *verdoyant*; L. *vi-*

*ridans*, from *viridis*, from *vireo*, to be green. The radical sense of the verb is to grow or advance with strength.]

1. Green; fresh; covered with growing plants or grass; as, *verdant* fields; a *verdant* lawn.—2. Flourishing.

VERD ANTIQUE, *n.* (verd anteeq') [Fr.] Ancient green; a term given to a green incrustation on ancient coins, brass, or copper. It is a hydrated carbonate of copper.—2. In *mineral*, an aggregate of serpentine and white crystallized marble, having a greenish colour. It is beautifully mottled, takes a fine polish, and is much used for ornamental purposes.

VERD'ANTLY, *adv.* Freshly; flourishingly.

VER'DERER, } *n.* [Fr. *verdier*, from  
VER'DEROR, } *verd*, green; or Low  
L. *viridarius*.] In *England*, an officer in the royal forests, whose peculiar charge was to take care of the *vert*, that is, the trees and underwood of the forest, to keep the assizes, view, receive, and enroll attachments and presentments of all manner of trespasses.

VER'DICT, *n.* [L. *verum dictum*, true declaration.] 1. The answer of a jury given to the court concerning any matter of fact in any cause, civil or criminal, committed to their trial and examination. In criminal causes, the jury decide the law as well as the fact. Verdicts are *general* or *special*; *general*, when they decide in general terms, or in the terms of the general issue, as *no wrong*, *no disseisin*; *special*, when the jury find and state the facts at large, and as to the law, pray the judgment of the court. [See JURV.]—2. Decision; judgment; opinion pronounced; as, to be condemned by the *verdict* of the public.

These enormities were condemned by the *verdict* of common humanity. *South.*

VER'DIGRIS, } *n.* [Fr. *verd* and *gris*;  
VER'DEGRIS, } green-gray.] Diacetate of copper. It was formerly prepared almost exclusively in France, by causing the husks and stalks of the grape, after wine-making, to ferment in contact with copper plates, by which means a coat of verdigris was formed on the surface of the copper. It is now prepared in England by more direct processes, principally by alternating copper plates and pieces of coarse woollen cloth previously soaked in crude pyroligneous acid. Verdigris, when pure, is in the form of light blue acicular crystals of a silky lustre. It is decomposed by the stronger acids, by the alkalis, and by heat. It is much employed as a pigment in hat-making, dyeing black, in several processes in the chemical arts, and in medicine. Verdigris, like all the compounds into which copper enters, is poisonous. This salt is very apt to form on the surface of copper utensils by the action of vegetables. *Distilled verdigris*, a binacetate or superacetate of copper.

VER'DITER, *n.* [*verde-terre*, green earth; *terre-verte*.] A blue or bluish green pigment, generally prepared by decomposing nitrate of oxide of copper with chalk. It is a hydrated percarbonate of copper.

VER'DITURE, *n.* The faintest and palest green.

VER'DOY, *a.* In *her.*, an epithet for a border charged with vegetables; as, a *border verdoy* of trefoils, cinquefoils, &c.

VERD'URE, *n.* [Fr.; from L. *vireo*.] Green; greenness; freshness of vegetation; as, the *verdure* of the meadows in June; the *verdure* of spring.

VERD'URED, *a.* Covered with verdure.

VERD'UROUS, *a.* Covered with green; clothed with the fresh colour of vegetables; as, *verdurous* pastures.

VER'ECUND, *a.* [L. *verecundus*.] Bashful; modest. [Not much used.]

VERECUN'DIOUS, *† a.* Modest; bashful.

VERECUND'ITY, *n.* Bashfulness; modesty; blushing. [Not in much use.]

VERETIL'LUM, *n.* [L.] A kind of polygus.

VERGE, *n.* (verj.) [Fr.; It *verga*, L. *virga*, a rod, that is, a shoot.] 1. A rod, or something in the form of a rod or staff, carried as an emblem of authority; the mace of a dean.—2. The stick or wand with which persons are admitted tenants, by holding it in the hand, and swearing fealty to the lord. On this account, such tenants are called *tenants by the verge*.—3. In *law*, the compass or extent of the king's court, within which is bounded the jurisdiction of the lord steward of the king's household; so called from the verge or staff which the marshal bears.—4. The extreme side or end of any thing which has some extent of length; the brink; edge; border; margin. [This seems to be immediately connected with the L. *vergo*.]—5. Among *gardeners*, the edge or outside of a border; also, a slip of grass adjoining to gravel-walks, and dividing them from the borders in the *parterre-garden*.—6. The spindle of the balance-wheel of a watch.

VERGE, *v. i.* [L. *vergo*.] 1. To tend downward; to bend; to slope; as, a hill *verges* to the north.—2. To tend; to incline; to approach.

I find myself *verging* to that period of life which is to be labour and sorrow.

VERGE BOARDS. See BARGE BOARDS. *Swift.*

VERG'ER, *n.* He that carries the verge or mace before the bishop, dean, &c.—2. An officer who carries a white wand before the justices of either bench in England.—3. A pew-opener or attendant in a church.

VERGET'ITE, *n.* [Fr.] In *her.*, a pallet, also, a shield divided with pallets.

VERG'ING, *ppr.* Bending or inclining; tending.

VER'GOULEUSE, *n.* A variety of pear: contracted to *vergaloo*.

VERID'ICAL, *† a.* [L. *veridicus*; *verus* and *æco*.] Telling truth.

VERIFIABLE, *a.* [from *verify*.] That may be verified; that may be proved or confirmed by incontestable evidence.

VERIFIC'A'TION, *n.* [Fr. See VERIFY.] The act of verifying or proving to be true; the act of confirming or establishing the authenticity of any powers granted, or of any transaction, by legal or competent evidence.

VERIFIED, *pp.* Proved; confirmed by competent evidence.

VER'IFIER, *n.* One that proves or makes appear to be true.

VER'IFY, *v. t.* [Fr. *verifier*; L. *verus*, true, and *facio*, to make; G. *wahr*, D. *waar*, W. *gweir*, pure, true, ether, purity; *gwiraw*, to verify.] 1. To prove to be true; to confirm.

This is *verified* by a number of examples. *Bacon.*

2. To fulfil, as a promise; to confirm the truth of a prediction; to show to be true. The predictions of this venerable patriot have been *verified*; Gen. xlii; 1 Kings viii.—3. In the *U. States*, to confirm or establish the authenticity of any thing by examination or competent evidence. The first act of the house of representatives is to *verify* their powers, by exhibiting their credentials to a committee of the house, or other proper authority.

VER'IFYING, *ppr.* Proving to be true; confirming.

VER'ILY, *adv.* [from *very*.] In truth; in fact; certainly.—2. Really; truly; with great confidence. It was *verily* thought the enterprise would succeed.

VERISIM'ILAR, *a.* [L. *verisimilis*; *verus*, true, and *similis*, like.] Having the appearance of truth; probable; likely.

VERISIMIL'ITUDE, *n.* [L. *verisimilitudo*.] The appearance of truth; probability; likelihood.

*Verisimilitude* and opinion are an easy purchase; but true knowledge is dear and difficult. *Glauville.*

VERISIMIL'ITY, for *Verisimilitude*, is not in use.

VER'ITABLE, *a.* [Fr.] True; agreeable to fact.

VER'ITABLY, *adv.* In a true manner.

VERITAS CONVI'CIU. [Lat.] In law, the truth of the charge or accusation.

VER'ITY, *n.* [Fr. *vérité*; L. *veritas*, from *verus*, true; W. *gwrez*; Sans. *vartha*.] 1. Truth; consonance of a statement, proposition or other thing to fact; 1 Tim. ii.

It is a proposition of eternal *verity*, that none can govern while he is despised. *South.*

2. A true assertion or tenet.

By this it seems to be a *verity*. *Davies.*

3. Moral truth; agreement of the words with the thoughts.—*Oath of verity*. In *Scots law*, when a party in a cause refers the matter in dispute to the oath of his adversary, the oath so emitted is called an *oath of verity*.

VER'JUICE, *n.* [Fr. *verjus*, that is, *verd jus*, the juice of green fruits.] An acid liquor expressed from wild apples, sour grapes, &c., used in sauces, ragouts, and the like. It is used also in the purification of wax for candles, in poultices, &c.

VER'MEIL. See VERMILLION.

VERMEOL'OGIST, *n.* [infra.] One who treats of vermes.

VERMEOL'OGY, *n.* [L. *vermes*, worms, and Gr. *λογος*, discourse.] A discourse or treatise on vermes, or that part of natural history which treats of vermes. [*Helminthology* is the legitimate term.]

VER'MES, *n. plur.* [L.] Worms. The sixth class of animals in the Linnæan arrangement of the animal kingdom. It comprised all animals which could not be arranged under *Vertebrata* and *Insecta*. Linnæus divides the vermes into five orders, viz., *Intestina*, *Mollusca*, *Testacea*, *Lithophyta*, and *Zoophyta*. Modern naturalists have made a very different arrangement of these animals, and the term *vermes* is now limited to the Annelides, and Entozoa.

VERMICEI'LI, *n.* [It. *vermicello*, a little worm, L. *vermiculus*, from *vermis*, a worm.] A species of wheaten paste, manufactured in Italy, in the form of long, slender tubes or threads, and so named on account of its worm-like appearance. Vermicelli is the same

substance as *maccaroni*, the only difference between them being, that the latter is made into larger tubes. Both of them are prepared in the greatest perfection at Naples, where they form the principal food of the bulk of the population, and are a favourite dish of all classes. Vermicelli is used amongst us in soups, broths, &c.

VERMI'CEOUS, *a.* [L. *vermes*.] Pertaining to worms; wormy.

VERMIC'ULAR, *a.* [L. *vermiculus*, a little worm, from *vermis*, a worm.] Pertaining to a worm; resembling a worm; particularly, resembling the motion of a worm; as, the *vermicular* motion of the intestines, called also *peristaltic*.—*Vermicular* or *vermiculated work*, in *sculpt.*, a sort of ornament consisting of frets or knots in Mosaic pavements, winding and representing the tracks of worms. Also, a species of rustic work which is so wrought as to have the appearance of having been eaten into, or tracked by worms.

VERMIC'ULATE, *v. t.* [L. *vermiculatus*.] To inlay; to form work by inlaying, resembling the motion or the tracks of worms.

VERMIC'ULATE, *† a.* Full of worms or maggots.

VERMIC'ULATED, *pp.* Formed in the likeness of the motion of a worm. [See VERMICULAR.]

VERMIC'ULATING, *ppr.* Forming so as to resemble the motion of a worm.

VERMICULATION, *n.* The act or operation of moving in the form of a worm; continuation of motion from one part to another, as in the peristaltic motion of the intestines.—2. The act of forming so as to resemble the motion of a worm.

VERMIC'ULITE, *n.* A mineral composed of micaceous looking plates, cemented together by a whitish matter. When heated nearly to redness it projects out with a vermicular motion, as if it were a mass of small worms; hence the name.

VERMIC'ULOUS, } *a.* [L. *vermiculo-*  
VERMIC'ULOSE, } *sus.*] 1. Full of worms or grubs.—2. Resembling worms.

VERMIFORM, *a.* [L. *vermis*, a worm, and *forma*, form.] Having the form or shape of a worm; as, the *vermiform* process of the cerebellum.

VERMIF'UGAL, *a.* Tending to prevent or destroy vermin, or to expel worms.

VERMIFUGÉ, *n.* [L. *vermis*, a worm, and *fugo*, to expel.] A medicine or substance that expels worms from animal bodies; an anthelmintic. Calomel, gamboge, jalap, male-fern root, cowhage, iron, tin, oil of turpentine, &c., are vermifuges or anthelmintics.

VERMILION, *n.* (vermil'yon.) [Fr. *vermeil*, *vermillon*; It. *vermiglione*; from L. *vermiculus*, *vermes*; a name sometimes improperly given to the kermes. See CRIMSON.] 1. The cochineal, a small insect found on a particular plant. [*Improper or obsolete.*]—2. The red sulphuret of mercury, or *cinnabar*. It occurs in nature as a common ore of mercury, of a carmine red colour. It is procured artificially by heating sulphur with eight times its weight of mercury in an iron vessel. The compound is then sublimated, and the sublimate, which is a compact, deep red, crystalline mass, when reduced to powder is of a beautiful scarlet colour. This artificial compound, which is properly a bisulphuret of mercury, is

extensively employed on account of the beauty of its colour, in painting, in making red sealing-wax, and other purposes. Hence it is the object of an important manufacture.—3. Any beautiful red colour. In blushing, the delicate cheek is covered with *vermilion*.

VERMILION, *v. t.* (vermil'yon.) To dye red; to cover with a delicate red.

VERMIL'IONED, *pp.* or *a.* Dyed or tinged with a bright red.

VER'MILY, *† a.* Same as vermilion.

VERM'IN, *n. sing.* and *plur.*; used chiefly in the plural. [Fr. and It. *vermine*; from L. *vermes*, worms.] 1. All sorts of small animals which are destructive to grain or other produce; all noxious little animals or insects, as squirrels, rats, mice, worms, grubs, flies, &c.

These *vermin* do great injuries in the field. *Mortimer.*

2. Used of noxious human beings in contempt; as, base *vermin*.

VERM'INATE, *v. i.* [L. *vermino*.] To breed vermin.

VERMINA'TION, *n.* The breeding of vermin.—2. A gripping of the bowels.

VERM'INLY, *† adv.* or *a.* Like vermin; of the nature of vermin.

VERM'INOUS, *a.* Tending to breed vermin.

The *verminous* disposition of the body. *Harvey.*

VERM'IN PUDDLE, Puddle formed of stiff clay and small stones or gravel beaten together until it forms a mass like pudding stone. It is used in the embankments of reservoirs, to prevent, as its name implies, the inroads of water rats and other vermin.

VERMIP'AROUS, *a.* [L. *vermes*, worms, and *pario*, to bear.] Producing worms.

VERMIV'OROUS, *a.* [L. *vermes*, worms, and *voro*, to devour.] Devouring worms; feeding on worms. *Vermivorous* birds are very useful to the farmer.

VERMONT'ER, *n.* A native or inhabitant of the state of Vermont, in North America.

VERMONTÉSE, *n. sing.* and *plur.* An inhabitant, or the inhabitants of Vermont.

VERNAC'ULAR, *a.* [L. *vernaculus*, born in one's house, from *verna*, a servant.] 1. Native; belonging to the country of one's birth. English is our *vernacular* language. The *vernacular* idiom is seldom perfectly acquired by foreigners.—2. Native; belonging to the person by birth or nature. A *vernacular disease* is one which prevails in a particular country or district; more generally called *endemic*.

VERNAC'ULARISM, *n.* A vernacular idiom.

VERNAC'ULARLY, *adv.* In agreement with the vernacular manner.

VERNAC'ULOUS, *† a.* [supra.] Vernacular; also, scoffing.

VER'NAL, *a.* [L. *vernalis*, from *ver*, spring.] 1. Belonging to the spring; appearing in spring; as, *vernal bloom*.

*Vernal* flowers are preparatives to autumnal fruits. *Rambler.*

2. Belonging to youth, the spring of life.—*Vernal signs*, the signs in which the sun appears in the spring.—*Vernal equinox*, the equinox in spring or March; the time when the sun enters the first point of the sign Aries, which happens about the 21st of March; opposed to the *autumnal equinox*, in September. [See ECLIPIC, EQUINOCTIAL, EQUINOX.]



**VER'NAL GRASS**, *n.* The *Anthoxanthum odoratum*, one of the grasses which gives the odour to new made hay.

**VER'NANT**, *a.* [*L. vernans*; *verno*, to flourish.] Flourishing, as in spring; as, *vernant* flowers.

**VER'NATE**, *† v. i.* To become young again.

**VERNA'TION**, *n.* [*L. verno*.] In *bot.*, the disposition of the nascent leaves within the bud. It is called also *profoliation*, and corresponds to the terms *estivation* and *præfloration*, which are used to indicate the manner in which the parts of the flower are arranged in the flower-bud. The vernation is said to be *conduplicate*, when the leaf is folded lengthwise, one half applied against the other, so that their margins correspond; *revolute* when the leaves are rolled backwards on each side; *involute*, when the edges of the leaves are rolled inward, spirally on each side; *convolute*, when two conduplicate leaves clasp each other; *circinate*, when the leaves are rolled from the tip downwards; *plicate*, when the leaves are folded lengthwise in several plait; *equitant*, w<sup>1</sup> leaves overlap each other alternately and entirely; and *imbricate*, when the leaves overlap each other, so that the middle of the outer leaf is opposite to the edges of two inner.

**VER'NICLE**, *n.* Same as veronica.

**VER'NIER**, *n.* [From the inventor, Peter Vernier.] A small movable scale, running parallel with the fixed scale of a quadrant, barometer, or other graduated instrument, and having the effect of subdividing the divisions of that instrument into more minute parts. The diagram represents the vernier of the common barometer for measuring to the hundredth of an inch. The scale A B is divided into inches, and tenths of inches; the small movable scale C D is the vernier, and consists of a length of eleven parts of A B, divided into ten parts, each part being therefore equal to one and one-tenth of the divisions upon A B, and the difference between any division on the scale and vernier will be one-hundredth of an inch.

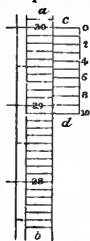

Vernier scale.

In the figure, the zero of the vernier is set to the division 30 inches, the division 10 upon the vernier corresponding with that of 28 inches 9-10ths on the scale. Hence, the vernier division 1 is one-hundredth of an inch below the scale division 29 inches 9-10ths; division 2 on the vernier is two-hundredths below 29 inches 8-10ths, and so on. Supposing the vernier were raised any number of hundredths, as two-hundredths of an inch, the division 2 would coincide with 29 inches 8-10ths. To read off the hundredths of an inch the vernier zero advances beyond any tenth on the scale; the division that coincides nearest with any on the scale, must be taken for the hundredth required.—*Chromatic vernier*, an instrument invented by Sir David Brewster, for the purpose of measuring by comparison the very minute variations of tints.

**VERNIL'ITY**, *† n.* [*L. vernilis*, from *verna*, a slave.] Servility; fawning behaviour, like that of a slave.

**VERNO'NIA**, *n.* A genus of plants, nat. order Compositæ. The species

consist of herbs or shrubs, inhabiting the tropical parts of the world, especially in Brazil, but several are found in India. *V. anthelmintica* produces



*Vernonia anthelmintica.*

dark coloured seeds, which are extremely bitter, and are considered powerfully anthelmintic. They are also employed as an ingredient in compounds prescribed in snake-bites.

**VERONI'EA**, *n.* [*vera*-icon, true image.] 1. A portrait or representation of the face of our Saviour on handkerchiefs.—2. In *bot.*, a genus of plants, Speedwell,—*which see.*

**VER'REL**, } *n.* A ring at the end of  
**VER'RULE**, } a cane, &c.; a ferrule,  
—*which see.*

**VER'RUEA**, *n.* In *medical lan.*, a wart.

**VER'RUCOSE**, } *a.* [*L. verruca*, a  
**VER'RUCOUS**, } wart; *verrucosus*,  
full of warts.] Warty; having little knobs or warts on the surface; as, a *verrucous* capsule.—2. In *entom.*, applied to the surface of insects, when studded with large smooth elevations resembling warts.—3. In *conchol.*, applied to shells beset with excrescences resembling warts.

**VERU'CULOSE**, *a.* Having minute wart-like prominences.

**VER'RY**, } *n.* In *her.*, the same as  
**VER'REY**, } *Vairy* or *Vair*,—*which see.*

**VERSABIL'ITY**, *† n.* [*L. versabilis*,  
**VERS'ABLENESS**, *†*] from *versor*, to turn.] Aptness to be turned round.

**VERS'ABLE**, *† a.* [*supra.*] That may be turned.

**VERS'AL**, *†* for *Universal*.

**VERS'ANT**, *a.* Familiar; conversant. [*Little used.*]

**VERS'ANT**, *pp.* In *her.*, erected or elevated.

**VERS'ATILE**, *a.* [*L. versatilis*, from *versor*, to turn.] 1. That may be turned round; as, a *versatile* boat or spindle.—2. Liable to be turned in opinion; changeable; variable; unsteady; as, a man of *versatile* disposition.—3. Turning with ease from one thing to another; readily applied to a new task, or to various subjects; as, a man of *versatile* genius.—4. In *bot.*, a *versatile* anther is one fixed by the middle on the point of the filament, and so poised as to turn like the needle of a compass; fixed by its side, but freely movable.

**VERS'ATILELY**, *adv.* In a versatile manner.

**VERSATIL'ITY**, } *n.* The quality  
**VERS'ATILENESS**, } of being versa-  
tile; aptness to change; readiness to be turned; variability.—2. The faculty of easily turning one's mind to

new tasks or subjects; as, the *versatility* of genius.

**VERSE**, *n.* (*vers.*) [*L. versus*; *Fr. vers*; from *L. verto*, to turn.] 1. In *poetry*, a line, consisting of a certain number of long and short syllables, disposed according to the rules of the species of poetry which the author intends to compose. Verses are of various kinds, as *hexameter*, *pentameter*, and *tetrameter*, &c., according to the number of feet in each. A verse of twelve syllables is called an *Alexandrian* or *Alexandrine*. Two or more verses form a stanza or strophe.—2. Poetry; metrical language.

Virtue was taught in *verse*. *Prior*  
3. A short division of any composition, particularly of the chapters in the scriptures. The author of the division of the Old Testament into *verses*, is not ascertained. The New Testament was divided into *verses* by Robert Stephens.—4. A piece of poetry.—5. A portion of an anthem to be performed by a single voice to each part.—*Blank verse*, poetry in which the lines do not end in rhymes.—*Heroic verse*, usually consists of ten syllables, or in English, of five accented syllables, constituting five feet.

**VERSE**, *v. t.* To tell in verse; to relate poetically.

Playing on pipes of corn, and *versing* love.

To be *versed*, [*L. versor*,] to be well skilled; to be acquainted with; as, to be *versed* in history or in geometry.

**VER'SED**, *pp.* Skilled.

**VER'SED SINE**, *n.* See *SINE*.

**VERSEHON'OURING**, *a.* Doing honour to poetry.

**VERSE'-MA'KER**, *n.* One who writes verses; a rhymist.

**VERSE'-MAN**, } *n.* [*verse* and  
**VERSE'MONGER**, } *man.*] A writer of verses; in *judicious language*.

**VER'SER**, *n.* A maker of verses; a versifier.

**VER'SET**, *† n.* [*Fr.*] A verse, as of scripture.

**VER'SICLE**, *† n.* [*L. versiculus*.] A little verse.

**VER'SIC'LOUR**, } *a.* [*L. versis-*  
**VER'SIC'LOURED**, } *color.*] Having various colours; changeable in colour.

**VER'SIC'ULAR**, *a.* Pertaining to verses; designating distinct divisions of a writing.

**VERSIFICA'TION**, *n.* [*Fr.* from *versifier*.] The act, art, or practice of composing poetic verse. Versification is the result of art, labour, and rule, rather than of invention or the fire of genius. It consists in adjusting the long and short syllables, and forming feet into harmonious measure.

**VERSIFICATOR**, *n.* A versifier. [*Little used.*] [See *VERSIFIER*.]

**VERSIFICA'TRIX**, *n.* A female versifier.

**VER'SIFIED**, *pp.* [from *versify*.] Formed into verse.

**VER'SIFIER**, *n.* One who makes verses. Not every *versifier* is a poet.—2. One who converts into verse; or one who expresses the ideas of another, written in prose; as, Dr. Watts was a *versifier* of the Psalms.

**VER'SIFY**, *v. i.* To make verses. I'll *versify* in spite, and do my best.

**VER'SIFY**, *v. t.* To relate or describe in verse; to turn into verse.

I'll *versify* the truth. *Daniel.*

2. To turn into verse; as, to *versify* the Psalms.

VERSIFYING, *ppr.* Converting into verse.

VERSION, *n.* [Fr. from L. *versio.*]

1. A turning; a change or transformation; as, the *version* of air into water. [Unusual.]—2. Change of direction; as, the *version* of the beams of light. [Unusual.]—3. The act of translating; the rendering of thoughts or ideas expressed in one language, into words of like signification in another language.

How long was Pope engaged in the *version* of Homer?—4. Translation; that which is rendered from another language. We have a good *version* of the Scriptures. There is a good *version* of the Pentateuch in the Samaritan. The Septuagint *version* of the Old Testament was made for the benefit of the Jews in Alexandria.

VERSIONIST, *n.* One who makes a version.

VERST, *n.* A Russian measure of length, containing 116½ yards, or 3500 feet; about three quarters of an English mile.

VERSUS. [L.] Against; as, John Doe *versus* Richard Roe.

VERSÛTE, *a.* Crafty; wily.

VERT, } *n.* [Fr. *verd*, green, L. *viridis.*]

VERD, } 1. In the *forest laws*, every thing within a forest that grows and bears a green leaf, which may serve as a cover for deer, but especially great and thick covers. Also a power to cut green trees or wood. To preserve *vert* and venison, is the duty of the verderer.—2. In *her.*, *vert* is used to signify a green colour. In coats of nobility it is called *emerald*, and in those of kings *venus*. It is expressed in engraving by diagonal lines, drawn from the dexter chief to the sinister base.



Vert.

VERT'ANT, } In *her.*, the same as  
REVERT'ANT, } *fleced* and *reflexed*,  
VERT'ED, } *or bowed, embowed,*  
REVERT'ED, } that is, formed like  
the letter S reverted.

VERT'EBRA, } *n. plur.* *Vert'ebrae* or  
VERT'EBRE, } *Vert'ebres.* [L. *vertebra*, from *verto*, to turn, Fr. *vertèbre.*]

A bone of the spine, or back bone of an animal. The different vertebrae which compose the spine, are divided into *true* and *false*, the former constituting the upper and longest portion, and the latter the lower portion of the spinal column, consisting of the *os sacrum* and *coccyx*. The true vertebrae are further divided into *cervical*, *dorsal*, and *lumbar*; or those of the neck, back, and loins. In man there are seven cervical vertebrae, twelve dorsal, and five lumbar. There is in every vertebra, between its body and apophyses, a foramen or hole, large enough to admit a finger. These foramina correspond with each other through all the vertebrae, and form a long bony conduit for the lodgment of the spinal marrow. The vertebrae are united together by means of a substance compressible like cork, which forms a kind of partition between them, and admits of a certain degree of motion, small between individual bones, but considerable as respects the whole spinal column. The vertebrae and their pro-

jections or processes, also afford attachments for a number of muscles and ligaments, and also passages for blood vessels, and for the nerves that pass out of the spine. In different animals the number of vertebrae varies exceedingly.

VERT'EBRAL, *a.* Pertaining to the vertebrae or joints of the spine or back bone, as *vertebral* muscles, *vertebral* artery.—2. Having a back-bone or spinal joints; as, *vertebral* animals.

VERT'EBRAL, *n.* An animal of the class which have a back bone.

VERT'EBRATE, *n.* An animal having a spine with joints.

VERT'EBRATED, *a.* [L. *vertebratus.*] Having a back-bone, or vertebral column, containing the spinal marrow, as an animal; as man, quadrupeds, fowls, reptiles, and fishes.

VERTEBRATES, } *n.* The first grand  
VERTEBRATA, } division of the  
animal kingdom, consisting of those animals which have a true back-bone, composed of vertebrae, and including man and the animals which most resemble him. The vertebrae are divided into the following classes:—*Mammalia*, *Aves*, or birds, *Reptilia*, and *Pisces* or fishes.

VERT'EX, *n.* [L. from *verto*, to turn; primarily a round point.] 1. The crown or top of the head.—2. The summit; the top of a hill or other thing. Any remarkable or principal point, particularly when that point is considered as the top or summit of a figure; as, the *vertex* of a triangle, the *vertex* of a cone or pyramid, &c. The *vertex* of an angle is the angular point, or point where the two lines meet to form the angle. The *vertex* of a curve is the point from which the diameter is drawn, or the intersection of the diameter and the curve, and this point is also called the *vertex* of the diameter. The point where the axis of a conic section meets the curve is called the *principal vertex*. In optics, the vertex of a glass is the same as its pole.—3. In *astron.*, the zenith; the point of the heavens perpendicularly over the head.

VERT'ICAL, *a.* [Fr. from L. *vertex.*] 1. Placed or being in the zenith, or perpendicularly over the head. The sun is *vertical* to the inhabitants within the tropics at certain times every year.—2. Being in a position perpendicular to the plane of the horizon.—*Vertical* leaves, in *bot.*, are such as stand so erect, that neither of the surfaces can be called the upper or under.—*Vertical* anthers, are such as terminate the filaments, and being inserted by their base, stand no less upright than the filaments themselves.—*Vertical* angles, in *geom.*, the opposite angles, made by two straight lines which intersect each other.

Thus, if the straight lines A B and C D intersect each other in the point E, the opposite angles A E C and D E B are vertical angles, as are also A E D and C E B.—*Vertical* circle, in *astron.*, a great circle passing through the zenith and the nadir. The meridian of any place is a *vertical* circle. The vertical circles are called *azimuth* circles or *azimuths*, and also circles of altitude, because the altitudes of the heavenly bodies are measured upon them. They all intersect one another in the zenith and nadir.—*Prime*



*vertical*, that vertical circle which is perpendicular to the plane of the meridian, and which passes through the zenith, and the east and west points of the horizon.—*Vertical* line, a line perpendicular or at right angles to the plane of the horizon. A plumb line hanging freely represents a vertical line. In *conics*, a *vertical* line, is a straight line drawn on the vertical plane, which passes through the vertex of the cone.

*Vertical* plane, a plane perpendicular to the plane of the horizon. In *conics*, a plane passing through the vertex of a cone and through its axis. In *perspective*, a plane perpendicular to the geometrical plane, passing through the eye, and cutting the perspective plane at right angles.

VERTICALITY, *n.* State of being vertical.

VERTICALLY, *adv.* In the zenith.

VERTICALNESS, *n.* The state of being in the zenith, or perpendicularly over the head. [*Verticality* is not used.]

VERTICIL, *n.* [L. *verticillus*, from *vertex*, supra.] In *bot.*, a whorl, a mode of inflorescence, in which the flowers surround the stem in a kind of ring, upon the same plane, as in *Hippuris vulgaris*.

VERTICILLAS'TER, *n.* In *bot.*, a name given to the cymose inflorescence of Labiate plants. There are usually two *verticillasters* in the axil of each of the opposite leaves.

VERTICIL'ATE, *a.* [supra.] In *bot.*, verticillate flowers are such as grow in a whorl, or are arranged on the same plane round the axis; as in *Hippuris vulgaris*. The term is also applied in this sense to leaves and branches. Verticillate plants are such as bear whorled flowers.

VERTICIL'LUS, *n.* In *bot.*, a ring; a whorl.

VERTIC'ITY, *n.* [from *vertex*, supra.] The power of turning; revolution; rotation.—2. That property of the loadstone or of a magnet by which it turns to some particular point, as its pole.

The attraction of the magnet was known long before its *verticity*. *Cyc.*

VERT'ICLE, *n.* [L. *verticulum.*] An axis; a hinge.

VERTIG'INOUS, *a.* [L. *vertiginosus.*] 1. Turning round; whirling; rotary; as, a *vertiginous* motion.—2. Giddy; affected with vertigo.

VERTIG'INOUSLY, *adv.* With a whirling or giddiness.

VERTIG'INOUSNESS, *n.* Giddiness; a whirling, or sense of whirling; unsteadiness.

VERT'IGO, } *n.* [L. from *verto*, to turn.]  
VERTIGO, } Giddiness; dizziness or swimming of the head; an affection of the head, in which objects appear to move in various directions, though stationary, and the person affected finds it difficult to maintain an erect posture. It is a common symptom of fulness of the vessels of the head, and of nervous and general debility; but it frequently arises from some disturbance of the digestive organs.—2. A genus of marsh or land snails.

VERTILIN'EAR, *a.* Rectilinear.

VERTUM'NUS, *n.* A deity among the Romans who presided over gardens and orchards, and who was also worshipped as the god of spring, or of the seasons in general.

VER'UCOUS. See VERUCOUS.

**VER'VAIN, n.** A plant; the popular name of some species of the genus *Verbena*. [See *VERBENA*.]

**VER'VAIN-MALLOW, n.** A species of mallow, the *Malva alcea*.

**VER'VELS, n.** [Fr. *vervelle*.] Labels tied to a hawk. [See *VARVELS*.]

**VER'Y, a.** [Fr. *vrai*; L. *verus*; G. *wahr*; D. *waar*.] True; real.

Whether thou be my very son Esau or not; Gen. xxvii.

He that repeateth a matter, separateth very friends; Prov. xvii.

So we say, in very deed, in the very heavens, this is the very man we want. In these phrases, *very* is emphatical; but its signification is true, real.

**VERY, adv.** As an adverb, or modifier of adjectives and adverbs, *very* denotes in a great degree, an eminent or high degree, but not generally the highest; as, a very great mountain; a very bright sun; a very cold day; a very pernicious war; a very benevolent disposition; the river flows very rapidly.

**VESA'NIÆ, n. plur.** [L. *vesania*, madness.] A class of diseases in which the judgment is impaired, without stupor or fever.

**VESI'CA, n.** [L.] A bladder.

**VESI'CANANT, n.** [infra.] A blistering application; an epispastic.

**VESI'CA PISCIS, n.** A name given to a symbolical representation of Christ, of a pointed oval or egg-shaped form, made by the intersection of two equal circles cutting each other in their centres. The actual figure of a fish found on the sarcophagi of the early Christians gave way, in course of time,



Vesica piscis Seal, Wimborne Minster.

to this oval-shaped ornament, which was the most common symbol used in the middle ages. It is to be met with sculptured, painted on glass, in ecclesiastical seals, &c. &c. The *auræole* or glory, in pictures of the Virgin, &c., was frequently made of this form.

**VESI'CATÉ, v. t.** [L. *vesica*, a bladder; Gr. *σφικτιν*, from *σφικτιν*, to inflate.] To blister; to raise little bladders, or separate the cuticle by inflaming the skin.

**VESI'CATÉD, pp.** Blistered.

**VESI'CATING, ppr.** Blistering.

**VESI'CA'TION, n.** The process of raising blisters or little cuticular bladders on the skin.

**VESI'CATORY, n.** [Fr. *vésicatoire*.] A blistering application or plaster; an epispastic.

**VESI'CATORY, a.** Having the property, when applied to the skin, of raising a bladder (*vesica*); blistering, as the blistering fly.

**VESI'GLE, n.** [L. *vesicula*, a little bladder.] 1. A small blister; an elevation of the cuticle, or a bladder-like tumour in any part, containing a transparent watery fluid.—2. Any small membranous cavity in animals or vegetables. The lungs consist of *vesicles* admitting air.

**VESI'GLAR, a.** Pertaining to *vesic'ulous*, } sicles; consisting of *vesic'ulose*, } vesicles.—2. Hollow; full of interstices.—3. Having little bladders or glands on the surface; as, the leaf of a plant.

**VESI'GLATE, a.** Bladdery; full of bladders.

**VES'PA, n.** The wasp; a genus of hymenopterous insects. [See *WASP*.]

**VES'PEL, n.** [L. This word and *Hesperus* are probably of one origin, and both from the root of *west*.] 1. The evening star; a name given to the planet Venus when she is to the east of the sun, and appears after sunset. Also the evening.—2. *Vespers*, in the plural, the evening song or evening service in the Romish church.—*Sicilian vespers*, the era of the general massacre of the French in Sicily, on Easter evening, 1282, at the toll of the bell for vespers.

**VES'PER, a.** Relating to the evening, or to the service of vespers; as, *vesper lamp*, *vesper bells*.

**VESPERTIL'IO, n.** The bat; a genus of cheiropterous mammalia, consisting of numerous species. The true bats are now divided into many subgenera, as *molossus noctilio*, *vampyrus*, &c. &c., distinguished by the absence or presence of a tail; the fact of its being free above the membrane or involved in it, the presence of a membrane on the nose, number of incisors, &c. &c. [See *BAT*.]

**VESPERTIL'IOIDÆ, n.** The bat family; a family of cheiropterous mammals, of which the genus *Vespertilio* is the type.

**VES'PERTINE, a.** [L. *vespertinus*. See *VESPER*.] Pertaining to the evening; happening or being in the evening.

**VES'PIARY, n.** The nest or habitation of wasps, hornets, &c.

**VES'PIDÆ, n.** A family of hymenopterous insects, of which the genus *Vespa* (wasps), is the type. Some of the species are solitary, others live in societies; some are phytophagous, and others carnivorous.

**VES'SEL, n.** [It. *vasello*, from *vaso*, a vase or vessel; Fr. *vaisseau*; Sp. *vasija*; from L. *vas*, *vasis*. This word is probably the English *vat*, in a different dialect; G. *fass*, a vat; *gefäss*, a vessel; *fassen*, to hold; allied probably to *fast*, *fasten*. The Sp. *vasija* is from the Latin; but the Spanish has also *baxel*, a general name of all floating buildings; probably of Celtic origin.] 1. A cask or utensil proper for holding liquors and other things, as a tun, a pipe, a puncheon, a hogshead, a barrel, a firkin, a bottle, a kettle, a cup, a dish, &c.—2. In *anal.*, any tube or canal, in which the blood and other humours are contained, secreted, or circulated, as, the arteries, veins, lymphatics, spermaties, &c.—3. In the *physiology of plants*, a canal or tube of very small bore, in which the sap is contained and conveyed; also, a bag or utricle, filled with pulp, and serving as a reservoir for sap; also, a spiral canal, usually of a larger bore.—4. Any structure made to float upon the water, for the purposes of commerce, war, &c., whether impelled by wind, steam, or oars.—

5. Something containing. In *scrip.*, vessels of different kinds were employed in the service of God in the temple worship, either for more or less honourable purposes, the word *vessel* is applied in scripture with the same distinction to persons; thus, *Vessels of mercy*, which God had afore prepared unto glory, designed and by his grace fitted for glory; *Vessels of wrath*, fitted for destruction; not prepared by God, but "fitted" by their guilt, depravity, and rebellion, for the place of punishment; A *chosen vessel*, such was Paul designed and selected by God, and endowed with the gifts and graces necessary for the high and honourable office of the apostleship.

**VES'SEL,† v. t.** To put into a vessel.

**VES'SETS, n.** A kind of cloth made in Suffolk.

**VES'SIGNON, } n.** [L. *vesica*.] A soft swelling on a horse's leg, called a *windgall*.

**VEST, n.** [Fr. *veste*; It. *vesta*; Lat. *vestis*, a coat or garment; *vestio*, to cover or clothe, Goth. *vestyan*; W. *gwisg*.] 1. An outer garment.—2. In *common speech*, a man's under garment; a short garment covering the body, but without sleeves, worn under the coat; called also *waistcoat*.

**VEST, v. t.** To clothe; to cover, surround, or encompass closely.

With ether *vested* and a purple sky. *Dryden*.

2. To dress; to clothe with a long garment; as, the *vested* priest.—To *vest* with, to clothe; to furnish with; to invest with; as, to *vest* a man with authority; to *vest* a court with power to try cases of life and death; to *vest* one with the right of seizing slave-ships.—

To *vest* in, to put in possession of, to furnish with; to clothe with. The supreme executive power in England is *vested* in the king; in the United States, it is *vested* in the president.—

2. To clothe with another form; to convert into another substance or species of property; as, to *vest* money in goods; to *vest* money in land or houses; to *vest* money in bank stock, or in six per cent. stock; to *vest* all one's property in the public funds.

**VEST, v. i.** To come or descend to; to be fixed; to take effect, as a title or right. Upon the death of the ancestor, the estate, or the right to the estate, *vests* in the heir at law.

**VES'TA, n.** [L.] In *myth.*, the goddess



Vesta, from an antique statue.

of the domestic hearth or of fire; worshipped both by the Greeks and

Romans. She was a virgin divinity, the daughter of Saturn and Rhea, and the patroness of chastity, as well as of domestic union and happiness. The fire burning on the domestic hearth was regarded as the symbol of Vesta; and each political community, city, or state, had its public hearth or altar of Vesta, on which a perpetual fire was kept burning. She had a temple at Rome, which contained the altar of the goddess, with her sacred fire, and the superintendence of this fire, which was never suffered to go out, was committed to six virgins called *vestals*.—2. In *astron.*, one of the asteroids or ultra-zodiacal planets. It was discovered by Dr. Olbers in 1807. It is of the fifth or sixth magnitude, and may be seen in a clear evening by the naked eye, its light being more intense, pure, and white, than that of the other asteroids. It performs its sidereal revolution in about 1326 mean solar days; its mean distance from the sun is 2·36787, the mean distance of the earth from the sun being taken as unity; and its orbit is inclined to the ecliptic in an angle of 7° 8' 9". Vesta is supposed to be the smallest of all the heavenly bodies with which we are acquainted, its magnitude being estimated to be only about the fifteenth thousandth part of that of the earth.

**VEST'AL, a.** [*L. vestalis*, from *Vesta*, the goddess of fire, Gr. *Ἑστία*.] 1. Pertaining to Vesta, the goddess of fire among the Romans, and a virgin.—2. Pure; chaste.

**VEST'AL, n.** A virgin consecrated to Vesta, and to the service of watching the sacred fire, which was to be perpetually kept burning upon her altar. The *Vestals* were six in number, and they made a vow of perpetual virginity.

**VEST'ED, pp.** Clothed; habited; covered; closely encompassed.—2. *a.* Fixed; not in a state of contingency or suspension; as, *vested* rights.—*Vested legacy*, in *law*, a legacy the right to which commences in *presenti*, and does not depend on a contingency, as a legacy to one to be paid when he attains to twenty-one years of age. This is a *vested* legacy, and if the legatee dies before the testator, his representative shall receive it.—*Vested remainder* is where the estate is invariably fixed, to remain to a determinate person, after the particular estate is spent. This is called a remainder executed, by which a present interest passes to the party, though to be enjoyed in future. [See REMAINDER.]

**VEST'IARY, n.** A wardrobe; a place in a monastery where the clothes of the monks are laid up.

**VEST'IBULAR, a.** Pertaining to or resembling a vestibule.

**VEST'IBULE, n.** [*Fr.*; *L. vestibulum*.] 1. The porch or entrance into a house, or a large open space before the door, but covered.—2. A little antechamber before the entrance of an ordinary apartment.—3. An apartment in large buildings which presents itself into a hall or suit of rooms or offices. An area in which a magnificent staircase is carried up is sometimes called a *vestibule*.—4. In *anat.*, a cavity belonging to the labyrinth of the ear, situated between the cochlea and semicircular canals.

**VEST'IGATE.** See INVESTIGATE. [*Vestigate* is not in use.]

**VEST'IGE, n.** [*Fr.*; *L. vestigium*. This word and *vestibule*, showing that some verb, signifying to tread, from which they are derived, is lost.] A track or footstep; the mark of the foot left on the earth; but mostly used for the mark or remains of something else; as, the *vestiges* of ancient magnificence in Palmyra; *vestiges* of former population.

**VEST'ING, pp.** [from *vest*.] Clothing; covering; closely encompassing; descending to and becoming permanent, as a right or title; converting into other species of property, as money.

**VEST'ING, n.** Cloth for vests; vest patterns.

**VEST'ITURE, n.** [*L. vestio*, or *vestis*.] The manufacture of cloth; the preparation of cloth.

**VEST'MENT, n.** [*L. vestimentum*, from *vestio*, to clothe; *Fr. vêtement*.] A garment; some part of clothing or dress; especially some part of outer clothing; but it is not restricted to any particular garment.

The sculptor could not give *vestments* suitable to the quality of the persons represented. Dryden.

*Ecclesiastical or sacerdotal vestments*, articles of dress or ornament worn by clergymen in the celebration of divine service; as, the cope, alb, rochet, surplice, &c.

**VEST'RY, n.** [*L. vestiarius*; *Fr. vestiaire*.] 1. A place or room appendant to a church, where the ecclesiastical vestments are kept, and where the minister robes himself. In this room, in the *Church of England*, parochial meetings are also held.—2. A parochial assembly, so called because held in the vestry. Hence, any room in which such meeting is customarily held. The minister, church wardens, and chief men of a parish, generally constitute a vestry, and the minister, whether rector, vicar, or perpetual curate, is *ex-officio* chairman of the meeting. A *general or ordinary vestry* is one to which every parishioner or outdweller assessed to or paying the church rates, or scot and lot, is admissible of common right. The powers of the vestry extend to the investigation into, and restraining of, the expenditure of the parish funds, the enlarging, repairing, or alteration of the churches or chapels within the parish, and the appointment of certain parish officers. In certain large and populous parishes, *select vestries* are chosen, either by custom or under the direction of various acts of parliament. Such vestries consist of a select number of individuals chosen by the rate-payers, to have the government of the parish, make rates, &c.

**VEST'RY BOARD, n.** The persons who manage parochial affairs.

**VEST'RY-CLERK, n.** [*vestry* and *clerk*.] An officer chosen by the vestry, who keeps the parish accounts and books.

**VEST'RY-MAN, n.** [*vestry* and *man*.] One of a vestry board.

**VES'TU, } pp.** In *REVES'TU*, } *her.*, is when an ordinary has some division on it only by lines, and signifies *clothed*, as if some garment were laid upon it, as in the cut; or a chief gules, *vestu* argent.



Vestus.

**VEST'URE, n.** [*Fr. vêtire*. See *VEST*.] 1. A garment; a robe.

There polished chests embroider'd *vesture* grac'd. Pope.

2. Dress; garments in general; habit; clothing; vestment; as, the *vesture* of priests.—3. Clothing; covering.

Rocks, precipices, and gulphs apparelled with a *vesture* of plants. Bentley.

And gild the humble *vestures* of the plain. Trumbull.

4. In *old law books*, the corn with which land was covered; as, the *vesture* of an acre.—5.† In *old books*, seisin; possession.

**VEST'URED, a.** Covered with *vesture*; dressed.

**VESU'VIAN, a.** Pertaining to Vesuvius, a volcano near Naples.

**VESU'VIAN, n.** In *mineral.*, a subspecies of pyramidal garnet, a mineral found in the vicinity of Vesuvius, classed with the family of garnets; called by Haiiy idocrase. It is generally crystallized in four-sided prisms, the edges of which are truncated, forming prisms of eight, fourteen, or sixteen sides. It sometimes occurs massive. It is composed chiefly of siliceous lime, and alumina, with a portion of oxide of iron, and oxide of manganese.

**VETCH, n.** [*Fr. vesce*; *It. veccia*; *L. vicia*; *Sp. veza*; *D. wih, wikke*, vetch, and a weight; *wikhen*, to weigh; *G. wicke*, a vetch; *wichel*, a roller; *wichtig*, weighty; *wickeln*, to wind up. We see *vetch* is from the root of *weigh*, *wag*, *wiggle*, and signifies a little roller.] A leguminous plant of the genus *Vicia*. It is a common name of most species of the genus. The name is also applied, with various epithets, to many other leguminous plants of different genera; as, the *chichling vetch*, of the genus *Lathyrus*; the *horse shoe vetch*, of the genus *Hippocrepis*; the *milk vetch*, of the genus *Astragalus*, &c. [See *VICIA*.]

**VETCH'LING, n.** [from *vetch*.] In *bot.*, a name of the *Lathyrus aphaca*, expressive of its diminutive size. The *meadow vetchling* is a wild plant common in meadows, which makes good hay. [See *LATHYRUS*.]

**VETCH'Y, a.** Consisting of vetches or of pea straw; as, a *vetchy* bed.—2. Abounding with vetches.

**VET'ERAN, a.** [*L. veteranus*, from *vetero*, to grow old, from *vetus*, old.] Having been long exercised in any thing; long practised or experienced; as, a *veteran* officer or soldier; *veteran* skill.

**VET'ERAN, n.** One who has been long exercised in any service or art, particularly in war; one who has grown old in service, and has had much experience.

Ensigns that pierced the foe's remotest lines,

The hardy *veteran* with tears resigns.

2. Among the *Romans*, a soldier who had served a certain number of campaigns; generally twenty-five.

**VETERINA'RIAN, n.** [*L. veterinarius*.] One skilled in the diseases of cattle or domestic animals.

**VET'ERINARY, a.** [*L. veterinarius*, from *veterinum*, a beast of burden.] Pertaining to the art or science of healing or treating the diseases of domestic animals, as oxen, horses, sheep, &c. Veterinary science is based upon a minute and accurate knowledge of the structure and functions of all those

animals which may require its aid, as also of the disorders and accidents to which these are exposed, and the various resources, whether natural or artificial, available for their cure. A *veterinary* college was established in England in 1792, at St. Pancras, in the vicinity of London.

**VETO**, *n.* [L. *veto*, I forbid.] A forbidding; prohibition; or the right of forbidding; applied to the right of a king or other chief magistrate or officer to withhold his assent to the enactment of a law, or the passing of a decree. Thus the king of Great Britain has a *veto* upon every act of parliament; he sometimes prevents the passing of a law by his *veto*.—2. In *Scotland*, an act passed in 1835 by the General Assembly of the Church, known by the name of the *veto act*. By this act it was decreed that no one should be admitted a minister of any vacant church, if a majority of the male heads of families, in full communion with the church, should dissent from his call. The *veto act*, however, by a decision of the Court of Session in 1838, was declared to be illegal, and *ultra vires* of the General Assembly. This decision was confirmed by the House of Lords in 1839, but the Church of Scotland, considering the admission of ministers a matter of spiritual jurisdiction, inherent in the church, according to the word of God, her original constitution, as well as ratified by the law and constitution of the country, resolved to adhere to the principles of spiritual independence, and non-intrusion; though she always professed her readiness to give effect to them in any form that would in reality secure them. The civil courts and finally the legislature, having resolved to grant the church no redress of the grievances inflicted by the violation of these principles, it ultimately led to the disruption of 1843. After this event the remanent members constituting the Assembly of the Established church rescinded the *veto* law.—3. In a *looser sense*, any authoritative prohibition.

**VETO**, *v. t.* To withhold assent to a bill for a law, and thus prevent its enactment.

**VETOIST**, *n.* One who sustains the use of the *veto*.

**VETTURA**, *n.* [It.] An Italian four-wheeled carriage.

**VETTURINO**, *n.* In *Italy*, one who conveys travellers from one place to another, in a *vettura*, at a price agreed on.

**VETUST**, *† a.* [L. *vetustus*.] Old; ancient.

**VEX**, *v. t.* [L. *vexo*; Fr. *vexer*; It. *vessare*; Sp. *vexar*.] 1. To irritate; to make angry by little provocations; a popular use of the word.—2. To plague; to torment; to harass; to afflict.

Ten thousand torments vex my heart.  
*Prior.*

3. To disturb; to disquiet; to agitate. White curl the waves, and the vex'd ocean roars.  
*Pope.*

4. To trouble; to distress.

I will also vex the hearts of many people; Ezek. xxxii.

5. To persecute; Acts xii.—6. † To stretch, as by hooks.

**VEX**, *v. i.* To fret; to be teased or irritated.

**VEXA'TION**, *n.* [Fr. from L. *vexatio*.]

1. The act of irritating, or of troubling, disquieting, and harassing.—2. State of being irritated or disturbed in mind.—3. Disquiet; agitation; great uneasiness.

Passions too violent...afford us vexation and pain.  
*Temple.*

4. The cause of trouble or disquiet. Your children were vexation to your youth.  
*Shak.*

5. Afflictions; great troubles; severe judgments.

The Lord shall send on thee cursing, vexation, and rebuke; Deut. xxviii.

6. A harassing by law.—7. A slight teasing trouble.

**VEXA'TIOUS**, *a.* Irritating; disturbing or agitating to the mind; causing disquiet; afflictive; as, a *vexatious* controversy; a *vexatious* neighbour.—2. Distressing; harassing; as, *vexatious* wars.—3. Full of trouble and disquiet.

He leads a vexatious life.  
*Digby.*

4. Teasing; slightly troublesome; provoking. A *vexatious* suit, in law, is one commenced for the purpose of giving trouble, or without cause.

**VEXA'TIOUSLY**, *adv.* In a manner to give great trouble or disquiet.

**VEXA'TIOUSNESS**, *n.* The quality of giving great trouble and disquiet, or of teasing and provoking.

**VEX'ED**, *pp.* Teased; provoked; irritated; troubled; agitated; disquieted; afflicted.

**VEX'ED QUES'TION**, *n.* [L. *questio vexata*.] An inquiry carried on in an irritating manner, or to a wearisome extent.

**VEX'ER**, *n.* One who vexes, irritates, or troubles.

**VEX'IL**, } *n.* [L. *vezillum*, a stand-  
**VEX'ILUM**, } *ard.*] A flag or stand-  
ard. In *bot.*, the upper petal of a papilionaceous flower.

**VEX'ILLARY**, *n.* A standard bearer.

**VEX'ILLARY**, *a.* Pertaining to an ensign or standard.

**VEXILLA'TION**, *n.* [L. *vezillatio*.] A company of troops under one ensign.

**VEX'ING**, *ppr.* Provoking; irritating; afflicting.

**VEX'INGLY**, *adv.* So as to vex, tease, or irritate.

**VIA**, *n.* [L.] A way or passage; a journey. In *Eng. writing*, it is generally used in the ablative case, and with the meaning *by way of*; as, *via* Falmouth, by the way of Falmouth.

**VIABIL'ITY**, *n.* The state of a child that is *viable*.

**VI'ABLE**, *a.* [Fr. likely to live, from *vie*, life, from L. *vivo*, to live.] A term adopted from the French and applied to a new-born child, to express its capability of sustaining independent life. Hence, when a fetus is properly organized, and sufficiently developed to live, it is said to be *viable*.

**VIADUCT**, *n.* [L. *via*, way, and *duco*, to lead. See *DUCE*.] The name usually given to an extensive bridge, or series of arches erected for the purpose of conducting a road or railway above the level of the ground in crossing a valley, or any place where it may be necessary to conduct the road or railway, at the requisite elevation, above the natural surface of the ground, in order to avoid interference with previously existing lines of communication. A similar structure for supporting a navigable canal is generally termed an *aqueduct*, or *aqueduct* bridge, although, strictly speaking, it is a *viaduct*; so also is an embankment, an

excavation, or a tunnel formed for a line of road.

**VI'AGE**, *† n.* [L. *via*, a way.] A voyage; a journey.

**VI'AL**, *n.* [Fr. *viole*; Gr. *φιάλη*: L. *phiala*.] A phial; a small bottle of thin glass, used particularly by apothecaries and druggists.

Samuel took a *vial* of oil, and poured it on his head; 1 Sam. x.

*Vials of God's wrath*, in scripture, are the execution of his wrath upon the wicked for their sins; Rev. xvi.

**VI'AL**, *v. t.* To put in a *vial*.

**VI'ALACTEA**, *n.* [L.] In *astron.*, the milky way,—*which see*.

**VI'ALLED**, *pp.* Put in a *vial*.

**VI'ALLING**, *ppr.* Inclosing in a *vial*.

**VI'AND**, *n.* [Fr. *vivande*; from It. *vivanda*; L. *vivendus*, *vivo*, to live.] Meat dressed; food.

*Viands* of various kinds allure the taste.  
*Pope.*

[It is used chiefly in the plural.]  
**VI'ARY**, *† a.* Happening in roads or ways.

**VI'ATECTURE**, *n.* [L. *via*, way; Gr. *τεκτων*, from *τεχω*, to fabricate.] The art of constructing roads, bridges, railways, canals, &c.; civil engineering.

**VIAT'IC**, *a.* [L. *viaticum*, from *via*, way.] Pertaining to a journey or to travelling.

**VIAT'ICUM**, *n.* [L. *supra*.] Provisions for a journey.—2. Among the *ancient Romans*, an allowance to officers who were sent into the provinces to exercise any office or perform any service, also to the officers and soldiers of the army.—3. In the *Romish church*, the communion or eucharist given to persons in their last moments.

**VIAT'OR**, *n.* [L.] A traveller; a way-faring person.—2. Among the *Romans*, an attendant or officer who summoned persons into the presence of a magistrate; an apparitor; a serjeant. Such servants were assigned both to the magistrates who had lieutors, as the dictator, consul, prætor, and especially to those who had none, as the tribunes of the people and the censors.

**VIBRATE**, *v. i.* [L. *vibro*; It. *vibrare*. This word belongs to the root of *Eng. wabble*; W. *gweibaw*, to wander, to move in a circular or serpentine direction.] 1. To swing; to oscillate; to move one way and the other; to play to and fro; as, the pendulum of a clock *vibrates* more or less rapidly, as it is shorter or longer. The chords of an instrument *vibrate* when touched.—2. To quiver; as, a whisper *vibrates* on the ear.—3. To pass from one state to another; as, a man *vibrates* from one opinion to another.

**VIBRATE**, *v. t.* To brandish; to move to and fro; to swing; as, to *vibrate* a sword or staff. The pendulum of a clock *vibrates* seconds.—2. To cause to quiver.

Breath vocalized, that is, *vibrated* or undulated, may differently affect the lips, and impress a swift tremulous motion.

*Holder.*

**VIBRATED**, *pp.* Brandished; moved one way and the other.

**VIBRATILE**, *a.* Adapted to or used for vibratory motion; as, the *vibratile* organs of radiated animals.

**VIBRATIL'ITY**, *n.* Disposition to pre-natural vibration or motion. [Not much used.]

**VIBRATING**, *ppr.* Brandishing; moving to and fro, as a pendulum or musical chord.

**VIBRA'TION**, *n.* [Fr. from *L. vibro.*] 1. The act of brandishing; the act of moving or state of being moved one way and the other in quick succession. —2 In *mech.*, a regular reciprocal motion of a body suspended; a motion consisting of continual reciprocations or returns; as, of the pendulum of a time-keeper. This is more frequently called *oscillation*. The number of *vibrations* in a given time depends on the length of the vibrating body. The number of *vibrations* performed by two pendulums of different lengths in a given time is inversely as the square roots of their lengths, and the times of their *vibrations* are directly as the square roots of their lengths. The *vibrations* of a pendulum are somewhat slower at or near the equator, than in remote latitudes, in consequence of the diminution of the force of gravity at or near the equator. The *vibrations* of the same pendulum, or of different pendulums of the same length, in the same place, in very small arcs of circles, are always performed in the same time. [See *OSCILLATION*, *PENDULUM*.] —3. In *physics*, the tremulous motion produced in a body when struck, or when its particles are disturbed by any action or impulse; sound is produced by exciting *vibrations* in the bodies emitting it. The term *vibration* is also applied to the alternate or reciprocating motion which is produced among the particles of a fluid or ethereal medium when their equilibrium is disturbed by any impulse; by which means waves or undulations are caused; as, the *vibrations* produced in water when agitated; the *vibrations* produced in the air by sounding bodies; the *vibrations* produced in a supposed ethereal medium by luminous bodies or by heat; the *vibrations* of the nervous fluid, by which sensation has been supposed to be produced, by impressions of external objects propagated thus to the brain. —4. In *music*, the regular reciprocating motion of a chord or of a body, which, when suspended, or stretched between two fixed points, swings or shakes to and fro, and thus produces musical sounds, or tones. The number of *vibrations* performed by a musical string, in a given time, is directly as the length of the string; the number of *vibrations* are also proportional to the square roots of the forces by which the strings are stretched. The times of *vibrations* of different strings are as their lengths directly, and the square roots of the tending forces inversely. The number of *vibrations* will also depend on the thickness and density of the strings, being much less in thick and heavy strings, than in small and light ones. In wind instruments, the sounds are produced by the *vibrations* of a column of air, contained in a straight or crooked tube. [See *SOUND*, *-tone*.]

**VIBRA'TIUNCLE**, *n.* A small vibration.

**VIB'RATIVE**, *a.* That vibrates.

**VIB'RATORY**, *a.* Vibrating; consisting in vibration or oscillation; as, a *vibratory* motion. —2. Causing to vibrate.

**VIB'RIO**, *n.* A genus of Infusoria, belonging to the order Homogenea, *Cur.* The body is round and slender like a bit of thread. The disease in wheat called ear-cockles is occasioned by one

of the species, *V. tritici*. The microscopic eels found in vinegar and diluted paste belong to this genus.

**VIBRIS'SÆ**, *n.* [*L. vibrissa*, a whisker.] In *mammalogy*, the stiff, long, pointed bristles which grow from the upper lip and other parts of the head; and in *ornithology*, the hairs which grow from the upper and under sides of the mouth, and stand forward like feelers, and sometimes point both upwards and downwards, as in the fly-catchers.

**VIBUR'NUM**, *n.* A genus of plants, nat. order Caprifoliaceæ. The species consist of shrubs almost all ornamental, with opposite petiolate leaves and corymbose flowers. They are natives of Europe, Asia, and America. *V. tinus*, the laurustinus, is common throughout Europe, and is much cultivated in gardens in Great Britain. There are several varieties, all hardy evergreen shrubs, and general favourites. *V. lantana*, the wayfaring tree, is a native of Europe and the west of Asia. The young shoots are used in Germany for basket-making; the wood is sometimes employed in turning and cabinet-making; the berries are used for making ink, and the bark of the root for making birdlime. *V. opulus*, the guelder rose, is native throughout Europe, and is especially frequent in Britain and Sweden. Several North American species, as *V. lentago*, *V. prunifolium*, and *V. pyrifolium*, have been introduced as ornamental shrubs into British gardens.

**VIC'AR**, *n.* [Fr. *vicaire*; It. *vicario*; *L. vicarius*, from *vici*, a turn, or its root.] 1. In a general sense, a person deputed or authorized to perform the functions of another; a substitute in office. The pope pretends to be *vicar* of Jesus Christ on earth. He has under him a grand vicar, who is a cardinal, and whose jurisdiction extends over all priests, regular and secular. —2. In the *canon law*, the priest of a parish, the predial tithes of which are impropriated or appropriated, that is, belong to a chapter or religious house, or to a layman, who receives them, and only allows the vicar the smaller tithes or a salary. [See *RECTOR*.] — *Apostolical vicars* are those who perform the functions of the pope in churches or provinces committed to their direction.

**VIC'ARAGE**, *n.* The benefice of a vicar. A vicarage by endowment, becomes a benefice distinct from the parsonage. —2. The house or residence of a vicar.

**VIC'AR-GEN'ERAL**, *n.* A title given by Henry VIII. to the Earl of Essex, with power to oversee all the clergy, and regulate all church affairs. It is now the title of an office, which, as well as that of official principal, is united in the chancellor of the diocese. The business of the vicar-general is to exercise jurisdiction over matters purely spiritual.

**VIC'ARIAL**, *a.* [from *vicar*.] Pertaining to a vicar; small; as, *vicarial* tithes.

**VIC'ARIMATE**, *a.* Having delegated power, as vicar.

**VIC'ARIMATE**, *n.* A delegated office or power.

**VIC'ARIOUS**, *a.* [*L. vicarius*.] 1. Deputed; delegated; as, *vicarious* power or authority. —2. Acting for another; filling the place of another; as, a *vicarious* agent or officer. —3. Substi-

tuted in the place of another; as, a *vicarious* sacrifice. The doctrine of *vicarious* punishment has occasioned much controversy.

**VIC'ARIOUSLY**, *adv.* In the place of another; by substitution.

**VIC'ARSHIP**, *n.* The office of a vicar; the ministry of a vicar.

**VICE**, *n.* [Fr. *vice*; *L. vitium*; *W. gwyd.*] 1. Properly, a spot or defect; a fault; a blemish; as, the *vices* of a political constitution. —2. In *ethics*, any voluntary action or course of conduct which deviates from the rules of moral rectitude, or from the plain rules of propriety; any moral unfitness of conduct, either from defect of duty, or from the transgression of known principles of rectitude. *Vice* differs from *crime*, in being less enormous. We never call murder or robbery a *vice*; but every act of intemperance, all falsehood, duplicity, deception, lewdness, and the like, is a *vice*. The excessive indulgence of passions and appetites which in themselves are innocent, is a *vice*. The smoking of tobacco and the taking of snuff, may in certain cases be innocent and even useful, but these practices may be carried to such an excess as to become *vices*. This word is also used to denote a habit of transgressing; as, a life of *vice*. *Vice* is rarely a solitary invader; it usually brings with it a frightful train of followers. —3. Depravity or corruption of manners; as, an age of *vice*.

When *vice* prevails, and impious men bear sway.

The post of honour is a private station. *Addison.*

4. A fault or bad trick in a horse. —5. In the *old English drama*, (the mysteries, &c.) a buffoon wearing a cap with ass's ears, whose office was to torment and belabour another buffoon who represented the devil. His face made of brass, like a *vice* in a game. *Tusser.*

**VICE**, *n.* [Fr. *vis*, a screw.] A kind of iron press which serves to hold fast any thing worked upon, whether it is to be filed, bent, riveted, &c. It consists chiefly of a pair of stout jaws or chaps, which are brought together by means of a screw, in order to compress or hold fast any thing placed between them. There are several kinds of *vices*; as, the *standard vice*, the *bench vice*, and the *hand vice*. — *Glazier's vice*, a machine for drawing lead into flat rods for case-windows. —2. † A gripe or grasp. —3. In *arch.*, an old term for a spiral or winding staircase.

**VICE**, † *v. t.* To press or *screw up* to a thing by a kind of violence.

**VICE**, (vi'sy.) [*L.*] *vice*, in the turn or place, is used in composition to denote one *qui vicem gerit*, who acts in the place of another, or is second in authority. — *Succeeding in the vice*, in *Scots law*, an intrusion by which one enters into possession, in the place of a tenant bound to remove; such entry being made collusively with the outgoing tenant, and without the landlord's consent.

**VICE-ADMIRAL**, *n.* In the *navy*, the second officer in command. His flag is displayed at the fore top-gallant-mast head. —2. A civil officer in Great Britain, appointed by the lords commissioners of the admiralty, for exercising admiralty jurisdiction within their respective districts.

**VICE-ADMIRALTY**, *n.* The office of a vice-admiralty; a vice-admiralty court.

**VICE-A'GENT**, *n.* [*vice* and *agent*.] One who acts in the place of another.

**VICE-CHAMBERLAIN**, *n.* An officer in court, next in command to the lord chamberlain.

**VICE-CHANCELLOR**, *n.* An officer in a university in England, a distinguished member, who is annually elected to manage the affairs in the absence of the chancellor.—2. A judge in chancery, subordinate to the lord chancellor, but trying causes in a court apart; there is an appeal from his decision to the lord chancellor. The office was created by the act 53 Geo. 3, c. 24. The number of vice-chancellors was increased to three, by the 5 Vict. c. 5; and the chief is now styled *vice-chancellor of England*.

**VICE-CONSUL**, *n.* One who acts in the place of a consul.

**VICED**, † *a.* Vicious; corrupt.

**VICE-DÓGE**, *n.* A consessor at Venice, who represented the doge when sick or absent.

**VICEGÉRENCY**, *n.* [*See* **VICÉGERENT**.] The office of a vicegerent; agency under another; deputed power; lieutenantcy.

**VICEGÉRENT**, *n.* [*L. vicem gerens*, acting in the place of another.] A lieutenant; a vicar; an officer who is deputed by a superior, or by proper authority to exercise the powers of another. Kings are sometimes called God's *vicegerents*. It is to be wished they would always deserve the appellation.

**VICEGÉRENT**, *a.* Having or exercising delegated power; acting by substitution, or in the place of another.

**VICE-LEG'ATE**, *n.* An officer employed by the pope to perform the office of spiritual and temporal governor in certain cities, when there is no legate or cardinal to command there.

**VIC'ENARY**, *a.* [*L. vicenarius*.] Belonging to twenty.

**VICENNIAL**, *a.* [*L. viceni*, twenty, and *annus*, a year.] Lasting or continuing twenty years; *Vicennial prescription*, in *Scots law*, a prescription of twenty years; one of the lesser prescriptions, which is pleadable against holograph bonds not attested by witnesses. [*See* **PRESCRIPTION**.]

**VICE-PRES'IDENCY**, *n.* The office of vice-president.

**VICE-PRES'IDENT**, *n.* (*s* as *z*.) An office-bearer next in rank below a president.

**VICE-RE'GAL**, *a.* Being in the place of a king; pertaining to a viceroy, or viceroyalty.

**VICEROY**, *n.* [*Fr. viceroi*, *L. vice*, and *Roy*, a king.] A vice-king; the governor of a kingdom or country, who rules in the name of the king with regal authority, as the king's substitute; as the lord lieutenant of Ireland. This title, however, is seldom officially given.

**VICEROY'ALTY**, *n.* The dignity, office, or jurisdiction of a viceroy.

**VICEROYSHIP**, *n.* The dignity, office, or jurisdiction of a viceroy.

**VICE-SUPPRESS'ING**, *a.* Adapted to suppress vice.

**V'ICE VER'SA**. [*L.*] Contrariwise; on the contrary. The terms or the case being reversed.

**V'ICIA**, *n.* A genus of plants, nat. order, Leguminosæ. The species are known by the common name of *vetch*; they are

usually climbing herbs with abruptly pinnate leaves, with many pairs of leaflets, the common petiole terminating in a tendril at the apex, which is mostly branched. The legume is long, compressed, pointed, one-celled, with two leathery stiffish valves. Above 100 species have been described, most of them natives of Europe. Ten species are enumerated by British botanists. Many of the species are much in use, as green crops, for feeding cattle, sheep, &c., as *V. sativa*, the common vetch or tare; *V. biennis*, biennial vetch, *V. pisiiformis*, pea-like vetch; *V. sylvatica*, the wood vetch, &c.

**V'IC'ATE**. *See* **VITATE**, the more usual orthography.

**VIC'INAGE**, *n.* [*from L. vicinia*, neighbourhood; *vicinus*, near.] Neighbourhood; the place or places adjoining or near. A jury must be of the *vicinage*, or body of the county. In *law*, common because of *vicinage*, is where the inhabitants of two townships contiguous to each other have usually inter-communed with one another; the beasts of one straying into the other's fields without molestation from either.

**VIC'INAL**, } *a.* Near neighbouring.

**VIC'INE**, } [*Little used*.]

**VICIN'ITY**, *n.* [*L. vicinitas*.] 1. Nearness in place; as, the *vicinity* of two country seats.—2. Neighbourhood; as, a seat in the *vicinity* of the metropolis.—3. Neighbouring country. Vegetables produced in the *vicinity* of the city are daily brought to market. The *vicinity* is full of gardens.

**VICIOUS'ITY**, *n.* Depravity; corruption of manners. [*But viciousness* is generally used.]

**V'IC'IOUS**, *a.* [*Fr. vicieux*; *L. vitiosus*.] 1. Defective; imperfect; as, a system of government *vicious* and unsound.—2. Addicted to vice; corrupt in principles or conduct; depraved; wicked; habitually transgressing the moral law; as, a *vicious* race of men; *vicious* parents; *vicious* children.—3. Corrupt; contrary to moral principles or to rectitude; as, *vicious* examples; *vicious* conduct.—4. Corrupt, in a physical sense; foul; impure; insalubrious; as, *vicious* air.—5. Corrupt; not genuine or pure; as, *vicious* language; *vicious* idioms.—6. Unruly; refractory; not well tamed or broken; as, a *vicious* horse.

**V'IC'IOUSLY**, *adv.* Corruptly; in a manner contrary to rectitude, moral principles, propriety, or purity.—2. Faultily; not correctly.

**V'IC'IOUSNESS**, *n.* Addictedness to vice; corruptness of moral principles or practice; habitual violation of the moral law, or of moral duties; depravity in principles or in manners. What makes a governor justly despised, is *viciousness* and ill morals. *South*.

2. Unruliness; refractoriness; as of a beast.

**VICIS'SITUDE**, *n.* [*L. vicissitudo*; from *vicis*, a turn.] 1. Regular change or succession of one thing to another; as, the *vicissitudes* of day and night, and of winter and summer; the *vicissitudes* of the seasons.—2. Change; revolution; as in human affairs. We are exposed to continual *vicissitudes* of fortune.

**VICISSITU'DINARY**, *a.* Changing in succession.

**VICISSITU'DINOUS**, *a.* Full of vicissitude.

**VICON'TIEL**, *a.* [*L. vice-comitalia*.

*See* **VISCOUNT**.] In *old law books*, pertaining to the sheriff.—*Vicontiel rents*, are certain rents for which the sheriff pays a rent to the king.—*Vicontiel writs*, are such as are triable in the county or sheriff court.

**VICON'TIELS**, *n.* Things belonging to the sheriff; particularly, farms for which the sheriff pays rent to the king.

**V'ICOUNT**, *n.* [*L. vice-comes*.] In *law books*, the sheriff.—2. A degree of nobility next below a count or earl. [*See* **VISCOUNT**.]

**VIC'TIM**, *n.* [*L. victima*; *Fr. victime*.] 1. A living being sacrificed to some deity, or in the performance of a religious rite; usually, some beast slain in sacrifice; but human beings have been slain by some nations, for the purpose of appeasing the wrath or conciliating the favour of some deity.—2. A person or thing destroyed; a person or thing sacrificed in the pursuit of an object. How many persons have fallen *victims* to jealousy, to lust, to ambition!

**VIC'TIMATE**, † *v. t.* To sacrifice.

**VIC'TIMIZE**, *v. t.* To make a victim of; to sacrifice or destroy; to make the victim of a swindling transaction. [*A cant word, but one in common use*.]

**VIC'TOR**, *n.* [*L. from vinco, victus*, to conquer, or the same root. *N* not being radical, the root is *vico* or *vigo*; *Sax. wig, wigg*, war; *veiga*, a warrior, a hero, a *victor*; *vigan*, to war, to fight. The primary sense is to urge, drive, or strive; hence to subdue.] 1. One who conquers in war; a vanquisher; one who defeats an enemy in battle. *Victor* differs from *conqueror*. We apply *conqueror* to one who subdues countries, kingdoms, or nations; as, Alexander was the *conqueror* of Asia or India, or of many nations, or of the world. In such phrases, we cannot substitute *victor*. But we use *victor*, when we speak of one who overcomes a particular enemy, or in a particular battle; as, Cæsar was *victor* at Pharsalia. The duke of Wellington was *victor* at Waterloo. *Victor* then is not followed by the possessive case; for we do not say, Alexander was the *victor* of Darius, though we say, he was *victor* at Arbela.—2. One who vanquishes another in private combat or contest; as, a *victor* in the Olympic games.—3. One who wins or gains the advantage. In love, the *victors* from the vanquish'd fly. They fly that wound, and they pursue that die. *Waller*.

4. Master; lord. These, *victor* of his health, his fortune, friends. *Pope*.

[*Not usual nor legitimate*.]

**VIC'TORESS**, *n.* A female who vanquishes.

**VIC'TORIOUS**, *a.* [*Fr. victorieux*.] 1. Having conquered in battle or contest; having overcome an enemy or antagonist; conquering; vanquishing; as, a *victorious* general; *victorious* troops; a *victorious* admiral or navy.—2. That produces conquest; as, a *victorious* day.—3. Emblematic of conquest; indicating victory; as, brows bound with *victorious* wreaths.

**VIC'TORIOUSLY**, *adv.* With conquest; with defeat of an enemy or antagonist; triumphantly; as, grace will carry us *victoriously* through all difficulties.

**VICTORIOUSNESS**, *n.* The state of being victorious.

**VIC'TORY**, *n.* [*L. victoria*, from *vinco, victus*, to conquer; *Fr. victoire*.] 1.

Conquest; the defeat of an enemy in battle, or of an antagonist in contest; a gaining of the superiority in war or combat. *Victory* supposes the power of an enemy or an antagonist to prove inferior to that of the victor. *Victory* however depends not always on superior skill or valour; it is often gained by the fault or mistake of the vanquished.

*Victory* may be honourable to the arms, but shameful to the counsels of a nation.

*Bolingbroke.*

2. The advantage or superiority gained over spiritual enemies, over passions and appetites, or over temptations, or in any struggle or competition.

Thanks be to God, who giveth us the *victory*, through our Lord Jesus Christ; 1 Cor. xv.

3. In *myth.*, a goddess who presided over victories. The Romans erected a temple to her, where they prayed the gods to give success to their arms. She was painted in the form of a woman arrayed in cloth of gold.

VIC'TRESS, *n.* A female that conquers.

VIC'TRICE, *f. n.* A victress.

VIC'TRIX, *a.* [L.] Conquering, or victorious; as, *Venus victrix.*

VICT'UAL, *f. n.* Provision of food, store for the support of life; meat; sustenance.—2. In *Scots law*, any sort of grain or corn. [See VICTUALS.]

VICTUAL, *v. t.* (vit'l.) [from *victual*, the noun.] 1. To supply with provisions for subsistence; as, to *victual* an army; to *victual* a garrison.—2. To store with provisions; as, to *victual* a ship.

VICTUALLED, *pp.* (vit'ld.) Supplied with provisions.

VICTUALLER, *n.* (vit'ler.) One who furnishes provisions.—2. One who keeps a house of entertainment.—3. A provision ship; a ship employed to carry provisions for other ships, or for supplying troops at a distance.

VICTUALLING, *ppr.* (vit'ling.) Supplying with provisions.

VICTUALLING-HOUSE, *n.* A house where provision is made for strangers to eat.

VICTUALLING-YARD, *n.* A yard generally contiguous to a dock-yard, containing magazines where provisions and other like stores for the Royal navy are deposited.

VICTUALS, *n.* (vit'lz.) [Fr. *victuailles*; *It. veltovaglia*; Sp. *vitualla*; from L. *victus*, food, from the root of *vivo*, which was *vigo* or *vico*, coinciding with *vigeo*; Basque, *vicia*, life. This word is now never used in the singular.] Food for human beings, prepared for eating; that which supports human life; provisions; meat; sustenance. We never apply this word to that on which beasts or birds feed, and we apply it chiefly to food for men when cooked or prepared for the table. We do not now give this name to flesh, corn, or flour, in a crude state; but we say, the *victuals* are well cooked or dressed, and in great abundance. We say, a man eats his *victuals* with a good relish. Such phrases as, to buy *victuals* for the army or navy, to lay in *victuals* for the winter, &c., are now obsolete. We say, to buy *provisions* or *stores*; yet we use the verb, to *victual* an army or ship.

VICUG'NA, or VICU'NA, *n.* A ruminant mammal, *Auehenia vicugna*, of the family Camelidae. It is closely allied to the llama, the guanaco, and the paco, and in size exceeds the latter two, measuring

4 ft. 1 in. from the sole of the foot to the crown of the head, and 2½ ft. to the shoulders. Its wool is short and curly, and finer than that of any of its relative species. In colour its upper parts are of a reddish yellow hue, and its



*Auehenia Vicugna.*

breast and lower parts white. It is a native of South America, and frequents lofty slopes in the Andes of Chili, &c., where some scanty vegetation is to be found, but never ventures up to the naked rocky summits, for its soft tender feet are only suited for turfy ground. It lives in herds of 6 to 15 females, and one male, the leader and protector of the herd, who, standing at a short distance, while the females are feeding, gives timely warning of danger, by a sort of whistling sound and a quick movement of the foot.

VIDAME', *n.* [L. *vice-dominus*, Fr. *vidame*.] In *ancient English law*, a bishop's deputy, in matters temporal; he ranked next to a peer.

VIDE. [L.] See.

VIDEL'ICET, *adv.* [L. for *videre licet*.] To wit; that is, namely. A term used in law pleadings. An abbreviation for this word is *viz*.

VIDE UT SUPRA. [Lat.] See as above.

VIDIMUS, *n.* [L. we have seen.] An examination or inspection; as, a *vidimus* of accounts or documents.

VIDONIA, *n.* A white wine, the produce of the island of Teneriffe, much resembling Madeira, but inferior in quality to it and of a tart flavour.

VID'UAGE, *n.* [Lat. *vidua*, a widow.] The state or class of widows.

VID'UAL, *f. a.* [L. *viduus*, deprived.] Belonging to the state of a widow.

VIDU'ITY, *f. n.* [L. *viduitas*.] Widowhood.

VIE, *v. i.* [Sax. *wigan*, to war, to contend, that is, to strain, to urge, to press. See VICOE.] To strive for superiority; to contend; to use effort in a race, contest, competition, rivalry, or strife. How delightful it is to see children *vie* with each other in diligence and in duties of obedience.

In a trading nation, the younger sons may be placed in a way of life to *vie* with the best of their family. *Addition.*

VIE, *v. t.* To show or practice in competition; as, to *vie* power; to *vie* charities. [Not legitimate].—2. To urge; to press.

She hung about my neck, and kiss and kiss She *vied* so fast † *Shak.*

VIELLE', *n.* (ve-yel') [Fr.] An old stringed instrument played by means of finger keys, and the friction of a wheel instead of a bow. In this country it is called a *hurdy-gurdy*.

VIELLEUR, *n.* A species of fly in Surinam, less than the lantern fly.

VIE'NA GREEN, *n.* A beautiful green powder much prized as a pigment. It is prepared by mixing together boiling solutions of equal weights of neutral-acetate of copper, and arsenious acid, and adding the mixture to its own volume of cold water, the whole being allowed to stand for some days.

VIENNESE', *n. sing.* and *pl.* A native of Vienna; natives of Vienna.

VI ET ARMIS. [L.] In *law*, with force and arms, words made use of in indictments and actions of trespass, to shew the violent commission of any trespass or crime.

VIEW, *v. t.* (vu.) [Fr. *vue*, from *voir*, to see, contracted from L. *videre*, Russ. *viju*, San. *vid*. The primary sense is to reach or extend to.] 1. To survey; to examine with the eye; to look on with attention, or for the purpose of examining; to inspect; to explore. *View* differs from *look*, *see*, and *behold*, in expressing more particular or continued attention to the thing which is the object of sight. We ascended mount Tabor, and *viewed* with admiration the spacious and beautiful plains of Esdraël and Galilee. We *viewed* with delight the rich and beautiful valley of Cashmere.

Go up and *view* the country; Josh. vii.

I *viewed* the walls of Jerusalem; Neh. vii.

2. To see; to perceive by the eye.—3. To survey intellectually; to examine with the mental eye; to consider.

*View* the subject in all its aspects.—*On view*, exposed to public examination; as, the articles advertised for sale are now *on view*. [Here *on view* is adverbial.]

VIEW, *n.* (vu.) Prospect; sight; reach of the eye.

The walls of Pluto's palace are in *view*. *Dryden.*

2. The whole extent seen. *View* or extensive *views* present themselves to the eye.—3. Sight; power of seeing, or limit of sight. The mountain was not within our *view*.—4. Intellectual or mental sight. These things give us a just *view* of the designs of Providence.—5. Act of seeing. The facts mentioned were verified by actual *view*.—6. Sight; eye.

Objects near our *view* are thought greater than those of larger size, that are more remote. *Locke.*

7. Survey; inspection; examination by the eye. The assessors took a *view* of the premises.

Surveying nature with too nice a *view*. *Dryden.*

8. Intellectual survey; mental examination. On a just *view* of all the arguments in the case, the law appears to be clear.—9. Appearance; show.

Graces,...

Which by the splendour of her *view* Dazzled, before we never knew. *Waller.*

10. Display; exhibition to the sight or mind.

To give a right *view* of this mistaken part of liberty. *Locke.*

11. Prospect of interest.

No man sets himself about any thing, but upon some *view* or other, which serves him for a reason. *Locke.*

12. Intention; purpose; design. With that *view* he began the expedition. With a *view* to commerce, he passed through Egypt.—13. Opinion; manner of seeing or understanding. These are my *views* of the policy which ought to



be pursued.—14. In *law*, an inspection judicially authorized. In *Scots law*, in jury causes, it is sometimes thought expedient that the jurors or a part of them, should have an opportunity of inspecting premises in dispute previous to the trial. The party wishing for the view applies to the court for a view, and where it is granted, six jurors are selected for the purpose, called *viewers*, who must be summoned by the sheriff to attend at the place in question, where the premises are pointed out to them by two persons named by the court, and technically called *shevers*. The object of the view is to render the ground of dispute more intelligible to the jury, but it is only granted where the necessity for it is made very apparent. A similar practice obtains in English law.—15. The footing, treading, or track of a fallow-deer.—*View of frankpledge*, in *law*, a court of record, held in a hundred, lordship, or manor, before the steward of the leet.—*Point of view*, the direction in which a thing is seen.

**VIEWED**, *pp.* (vu'ed.) Surveyed; examined by the eye; inspected; considered.

**VIEWER**, *n.* (vu'er.) One who views surveys or examines.—2. In *law*, *viewers* are those jurors who are authorized by a court to inspect any place in question. [See **VIEW**, No. 14.]

**VIEWING**, *ppr.* (vu'ing.) Surveying; examining by the eye or by the mind; inspecting; exploring.

**VIEWING**, *n.* (vu'ing.) The act of beholding or surveying.

**VIEWLESS**, *a.* (vu'less.) That cannot be seen; not being perceivable by the eye; invisible; as, *viewless winds*.

Swift through the valves the visionary fair  
Repass'd, and *viewless* mix'd with common  
air. *Pope.*

**VIEWLY**, *a.* Lightly; striking to the view; handsome. [*Obsolete or local.*]

**VIGESIMAL**, *a.* The twentieth.

**VIGESIMATIÓN**, *n.* [L. *vigesimus*, twentieth.] The act of putting to death every twentieth man.

**VIGIL**, *n.* [L. *vigilia*; Fr. *vigile*; L. *vigil*, waking, watchful; *vigilo*, to watch. This is formed on the root of Eng. *wake*, Sax. *wæcan*, *wecan*. The primary sense is to stir or excite, to rouse, to agitate.] 1. Watch; devotion performed in the customary hours of rest or sleep.

So they in heav'n their odes and *vigils*  
tun'd. *Milton.*

2. In *church affairs*, the eve or evening before any feast, the ecclesiastical day beginning at six o'clock in the evening, and continuing till the same hour the following evening; hence, a religious service performed in the evening preceding a holiday.—3. A fast observed on the day preceding a holiday; a wake.—4. Watch; forbearance of sleep; as, the *vigils* of the card table.—*Vigils* or *watchings* of flowers, a term used by Linnaeus to express a peculiar faculty belonging to the flowers of certain plants, of opening and closing their petals at certain hours of the day.

**VIGILANCE**, *n.* [Fr. from L. *vigilans*. See **VIEW**.] 1. Forbearance of sleep; a state of being awake.—2. Watchfulness; circumspection; attention of the mind in discovering and guarding against danger, or providing for safety. *Vigilance* is a virtue of prime importance in a general. The *vigilance* of

the dog is no less remarkable than his fidelity.—3. Guard; watch.

In at this gate none pass  
The *vigilance* here plac'd. [*Unusual.*]  
*Milton.*

**VIG'LANCY**, for *Vigilance*, is not used.

**VIG'ILANT**, *a.* [Fr. from L. *vigilans*.] Watchful; circumspect; attentive to discover and avoid danger, or to provide for safety.

Take your places and be *vigilant*. *Shak.*  
Be sober, be *vigilant*; 1 Pet. v.

2. In *her.*, a term applicable to the cat when borne in a position as if upon the watch for prey.

**VIG'ILANTLY**, *adv.* [supra.] Watchfully; with attention to danger and the means of safety; circumspectly.

**VIGINTIVIRATE**, *n.* [L. *viginti* and *vir*.] A body of officers of government, consisting of twenty men.

**VIGNETTE**, *n.* [Fr. *vignette*, from *vigne*, a vine.] Originally, a kind of flourish of vine leaves and flowers in the vacant part of the title page of a book, above the dedication, or at the end of a division. At present, however, the word signifies any small engraved embellishment for the illustration or decoration of a page of any work; and, in a more limited sense, such illustrations as are softened off at the edges, and not terminated by a definite boundary line.—2. In *arch.*, ornamental carving in imitation of vine leaves.

**VIG'OROSO**, In *music*, with energy.

**VIG'OROUS**, *a.* Full of physical strength or active force; strong; lusty; as, a *vigorous* youth; a *vigorous* body.—2. Powerful; strong; made by strength, either of body or mind; as, a *vigorous* attack; *vigorous* exertions. The enemy expects a *vigorous* campaign.

The beginnings of confederacies have been *vigorous* and successful. *Davenant.*

**VIG'OROUSLY**, *adv.* With great physical force or strength; forcibly; with active exertions; as, to prosecute an enterprise *vigorously*.

**VIG'OROUSNESS**, *n.* The quality of being vigorous or possessed of active strength.

**VIG'OUR**, *n.* [L. from *vigeo*, to be brisk, to grow, to be strong; allied to *vivo*, *vici*, to live, and to Sax. *wigan*, to carry on war, and to *wake*.] 1. Active strength or force of body in animals; physical force.

The *vigour* of this arm was never vain.  
*Dryden.*

2. Strength of mind; intellectual force; energy. We say a man possesses *vigour* of mind or intellect.—3. Strength or force in animal or vegetable motion; as, a plant grows with *vigour*.—4. Strength; energy; efficacy.

In the fruitful earth  
His beams, unactive else, their *vigour* find.  
*Milton.*

**VIG'OUR**, † *v. t.* To invigorate. [*Vigour* and all its derivatives imply active strength, or the power of action and exertion, in distinction from passive strength, or strength to endure.]

**VIKING**, *n. plur.* *Vik ingr.* A pirate. The *Vikings* were Northmen who infested the European seas in the 8th, 9th, and 10th centuries. They were generally the sons of Northern kings, who betook themselves to piracy as a means of distinguishing themselves, and of obtaining an independent command. [See **SEA KINGS**.]

**VILD**, } † *a.* Vile; wicked.

**VILED**, } † *a.* Vile; wicked.

**VILE**, *a.* [L. *vilis*; Fr. and Sp. *vil*; It. *vile*; Gr. *φωλιος*.] 1. Base; mean; worthless; despicable.

The inhabitants account gold a *vile* thing.  
*Abbot.*

A man in *vile* raiment; James ii.  
Wherefore are we counted as beasts, and reputed as *vile* in your sight? Job xviii.

2. Morally base or impure; sinful; depraved by sin; wicked; hateful in the sight of God and of good men. The sons of Eli made themselves *vile*; 1 Sam. iii.

Behold I am *vile*; what shall I answer?  
*Job* xl.

**VILED**, † *a.* Abusive; scurrilous; defamatory.

**VILELY**, *adv.* Basely; meanly; shamefully; as, Hector *vilely* dragged about the walls of Troy.—2. In a cowardly manner; 2 Sam. i.

The Volscians *vilely* yielded the town.  
*Shak.*

**VILENESS**, *n.* Baseness; meanness; despicableness.

His *vileness* us shall never awe. *Drayton.*

2. Moral baseness or depravity; degradation by sin; extreme wickedness; as, the *vileness* of mankind.

**VIL'ER**, *a. comp.* More vile.

**VIL'EST**, *a. superl.* Most vile.

**VILIFICATION**, *n.* The act of vilifying or defaming.

**VIL'IFIED**, *pp.* [from *vilify*.] Defamed; traduced; debased.

**VIL'IFIER**, *n.* One who defames or traduces.

**VIL'IFY**, *v. t.* [from *vile*.] To make vile; to debase; to degrade.

Their Maker's image  
Forsook them, when themselves they *vilified*  
To serve ungovern'd appetite. *Milton.*

2. To defame; to traduce; to attempt to degrade by slander.

Many passions dispose us to depress and *vilify* the merit of one rising in the esteem of mankind.

*Addison.*  
[This is the most usual sense of the verb.]

**VIL'IFYING**, *ppr.* Debasing; defaming.

**VIL'IPEND**, † *v. t.* [L. *vilipendo*.] To despise; to contemn; to disparage; to have in no esteem.

**VILIP'ENCY**, † *n.* Disesteem; slight.

**VIL'ITY**, † *n.* Vileness; baseness.

**VILL**, *n.* [L. *villa*; Fr. *ville*.] A village; a small collection of houses. [See **VILLAGE**.] The statute of Exeter, 14 Edward I., mentions *entire-vills*, *demi-vills*, and *hamlets*.

**VIL'LA**, *n.* [L. *villa*; Fr. *ville*; Gaelic, *bail*.] A country seat; usually one for the residence of an opulent person. Among the *Romans*, *villa* signified a country seat for an individual of the wealthier sort, with its appendages. It comprehended three different kinds of houses, the *villa urbana*, which was the residence of the proprietor, and contained all the conveniences of a mansion in the city; the *villa rustica*, containing barns, stables, &c., and lodgings for those who were employed in the operations of the farming establishment; and the *villa fructuaria*, appropriated to the preservation of the various productions of the farm. By degrees numbers of houses were built round these villas, and hence the origin of *villages*. In *Spanish* and *Portuguese*, *villa* means a town.

**VILLAGE**, *n.* [Fr.; from *villa*.] A small assemblage of houses, less than

a town or city, and inhabited chiefly by farmers and other labouring people. In *Eng.* it is said that a *village* is distinguished from a town by the want of a market.—2. In *law*, a *village*, or *vill*, is sometimes taken to signify a manor, at other times a whole parish, or a subdivision of it. Most commonly, it means the out part of a parish consisting of a few houses separate from the rest.

**VILLAGER**, *n.* An inhabitant of a village.

**VILLAGERY**, *n.* A district of villages.

**VIL'LAINE**, *n.* [*Fr. vilain*; *It. and Sp. villano*; *Norm. vilaint*. According to the French orthography, this word is formed from *vile*; but the orthography in other languages connects this word with *vill*, *village*, and this is probably the true origin.] 1. In *feudal law*, a villain or villein is one who holds lands by a base or servile tenure, or in *villanage*. Villains, who belonged principally to lords of manors, were of two sorts; *villains regardant*, that is, annexed to the manor or land, *adscriptitii glebæ*; or *villains in gross*, or at large, that is, annexed to the person of their lord, and transferable by deed from one owner to another. They could not leave their lord without his permission; but if they ran away, or were purloined from him, they might be claimed and recovered by action like beasts, or other chattels. They held indeed small portions of land to sustain themselves and families, but it was at the mere will of the lord, who might dispossess them whenever he pleased, and their tenure bound them to what were termed *villein* or ignoble services. A villain could acquire no property either in land or goods; if he purchased either the lord might seize them to his own use.—2. A vile wicked person; a man extremely depraved, and capable or guilty of great crimes. We call by the name of *villain*, the thief, the robber, the burglarian, the murderer, the incendiary, the ravisher, the seducer, the cheat, the swindler, &c.

Calm thinking *villains*, whom no faith could fix. *Pope.*

**VIL'LAINOUS**, *a.* [from *villain*.] Base; very vile.—2. Wicked; extremely depraved; as, a *villainous* person or wretch.—3. Proceeding from extreme depravity; as, a *villainous* action.—4. Sorry; vile; mischievous; in a *familiar* sense; as, a *villainous* trick of the eye. *Villainous judgment*, in *old law*, a judgment that casts reproach on the guilty person.

**VIL'LAINOUSLY**, *adv.* Basely; with extreme wickedness or depravity.

**VIL'LAINOUSNESS**, *n.* Baseness; extreme depravity.

**VIL'LAINY**, *n.* Extreme depravity; atrocious wickedness; as, the *villainy* of the thief or the robber; the *villainy* of the seducer.

The commendation is not in his wit, but in his *villainy*. *Shak.*

2. A crime; an action of deep depravity. In this sense the word has a plural.

Such *villainies* roused Horace into wrath. *Dryden.*

**VIL'LAKIN**, *n.* A little village.

**VIL'LAN**, *n.* A villain or villein.

**VIL'LANAGE**, *a.* The state of a villain; base servitude.—2. A base tenure of lands; tenure on condition of doing the meanest services for the lord; usually written *villanage*,—*which see*.—3. Baseness; infamy. [See *VIL'LAINY*.]

**VIL'LANIZE**, *v. t.* To debase; to **VIL'LANIZE**, *v. t.* degrade; to defame; to revile.

Were virtue by descent, a noble name  
Could never *villanize* his father's fame.

[*Little used.*] *Dryden.*

**VIL'LANIZED**, *pp.* Defamed; de-

**VIL'LANIZED**, *v. t.* based. [*Little used.*]

**VIL'LANIZER**, *n.* One who villainizes.

**VIL'LANIZING**, *v. t.* Defaming; de-

**VIL'LANIZING**, *v. t.* basing. [*Little used.*]

**VIL'LANOUS**, *a.* Serving; being in

**VIL'LANOUS**, *a.* a state of villenage.

**VIL'LANY**, *n.* Villenage.

**VILLAR'SIA**, *n.* A genus of aquatic

or marsh plants, nat. order Gentianaceæ. They inhabit all parts of the world, and are elegant plants when in blossom. One species, *V. nymphaeoides*, a floating plant, is a native of Europe, and is found in Great Britain in rivers and still waters, although rare. It is a beautiful plant, with a large yellow flower, curiously plaited, and easily cultivated.

**VIL'LATIC**, *a.* [*L. villaticus*.] Pertaining to a village.

Tame *villatic* fowl. *Milton.*

**VIL'LEIN**, *n.* See *VILLAIN*, No. 1.

**VIL'LENAGE**, *n.* [from *villain*.] A tenure of lands and tenements by base services. This tenure was neither strictly feudal, Norman, or Saxon, but mixed and compounded of them all. It was originally founded on the servile state of the occupiers of the soil, who were allowed to hold portions of land at the will of their lord, on condition of performing base and menial services. Where the service was base in its nature, and undefined as to time and amount, the tenure received the name of *pure villenage*, but where the service, although of a base nature, was certain and defined, it was called *privileged villenage*, and sometimes *villein socage*. It frequently happened that lands held in villenage descended in uninterrupted succession from father to son, until at length the occupiers or villeins became entitled, by prescription or custom, to hold their lands against the lord, so long as they performed the required services. And although the villeins themselves acquired freedom, or their land came into the possession of freemen, the villein services were still the condition of the tenure, according to the custom of the manor. These customs were preserved and evidenced by the rolls of the several courts—baron, in which they were entered, or kept on foot by the constant immemorial usage of the several manors in which the lands lay. And as such tenants had nothing to shew for their estates but the entries into those rolls, or copies of them authenticated by the steward, they at last came to be called *tenants by copy of court-roll*, and their tenure a *copy-hold*.

**VIL'LI**, *n. plur.* [*L. villus*.] 1. In *anat.*, fine small fibres, resembling a covering of down or the pile of velvet, as the internal coat of the intestinal canal.—2. In *bot.*, long, straight, and soft hairs on the surface of a plant.

**VIL'LOSE**, *a.* [*L. villosus*, from *vil-*

**VIL'LOUS**, *a.* *lus*, hair, *Eng. wool*.]

1. Abounding with fine hairs or wooly substance; nappy; shaggy; rough; as, a *villos* coat. The *villos* coat of the stomach and intestines is the inner

mucons membrane, so called from the innumerable villi or fine fibrils with which its internal surface is covered.—2. In *bot.*, covered with long, straight, and soft hairs.

**VIL'LUS**, *n.* [*L.*] A soft hair. [See *VILLI*.]

**VIM'INAL**, *a.* [*L. viminalis*.] Pertaining to twigs; consisting of twigs; producing twigs.

**VIMIN'EOUS**, *a.* [*L. vimineus*, from *vimen*, a twig.] Made of twigs or shoots.

In the hive's *vimineous* dome. *Prior.*  
**VINA'CEOUS**, *a.* [*L. vinaceus*.] 1. Belonging to wine or grapes.—2. Of the colour of wine.

**VINAIGRETTE**, *n.* [*Fr.*] A small box of gold, silver, &c. with perforations on the top, for holding aromatic vinegar, contained in a sponge. It is used like a smelling bottle.

**VIN'CIBLE**, *a.* [from *L. vinco*, to conquer. See *VICTOR*.] Conquerable; that may be overcome or subdued.

He not *vincible* in spirit. *Hayward.*

**VIN'CIBLENESS**, *n.* The capacity of **VINCIBILITY**, } being conquered; } conquerableness.

**VIN'CTURE**, *n.* [*L. vincitura*.] A binding.

**VIN'CEULUM**, *n.* [*L.*] A bond of union; a band or tie.—2. In *alge.*, a character in the form of a line or stroke, drawn over a factor, divisor, dividend, &c. when it consists of several letters, quantities, or terms, in order to connect them together as one quantity, and shew that they are to be multiplied, or divided, &c. together: Thus,  $a + b \times c$ , indicates that the sum of *a* and *b* is to be multiplied by *c*; whereas the expression without this character would indicate simply, that *b* is to be multiplied by *c*, and the product added to *a*. It is now more usual, however, to enclose quantities that are to be connected together, within parentheses or brackets: thus,  $(a + b + c) \times x$  or  $\{a + b + c\} \times x$ ;  $(x^2 - y^2) \div (x + y)$ , or  $\{x^2 - y^2\} \div \{x + y\}$ .—3. In *English civil law*, the marriage tie; hence a divorce, a *vinculo matrimonii*, is an entire release from the bond of matrimony, with leave to marry again.

**VINDE'MIAL**, *a.* [*L. vindemialis*, from *vindemia*, vintage; *vinca* and *demo*.] Belonging to a vintage or grape harvest.

**VINDE'MIATE**, *v. i.* [supra.] To gather the vintage.

**VINDEMIAT'ION**, *n.* The operation of gathering grapes.

**VINDE'MIATRIX**, *n.* A star of the third magnitude in the constellation Virgo.

**VINDICABILITY**, *n.* The quality of being vindicable, or capable of support or justification.

**VIN'DICABLE**, *a.* [infra.] That may be vindicated, justified, or supported.

**VINDICATE**, *v. t.* [*L. vindico*.] 1. To defend; to justify; to support or maintain as true or correct, against denial, censure, or objections.

When the respondent denies any proposition, the opponent must *vindicate* it.

Laugh where we must, be candid where we can;

But *vindicate* the ways of God to man. *Pope.*

2. To assert; to defend with success; to maintain; to prove to be just or valid; as, to *vindicate* a claim or title.

—3. To defend with arms, or otherwise; as, to *vindicate* our rights.—4. To avenge; to punish; as, a war to *vindicate* or punish infidelity.

God is more powerful to exact subjection and to *vindicate* rebellion.

*Pearson.*

[This latter use is entirely obsolete.]

**VINDICATED**, *pp.* Defended; supported; maintained; proved to be just or true.

**VINDICATING**, *ppr.* Defending; supporting against denial, censure, charge, or impeachment; proving to be true or just; defending by force.

**VINDICATION**, *n.* [Fr. from L. *vindico*.] 1. The defence of any thing, or a justification against denial or censure, or against objections or accusations; as, the *vindication* of opinions or of a creed; the *vindication* of the Scriptures against the objections and cavils of infidels.—2. The act of supporting by proof or legal process; the proving of any thing to be just; as, the *vindication* of a title, claim, or right.—3. Defence by force or otherwise; as, the *vindication* of the rights of man; the *vindication* of our liberties or the rights of conscience.

**VINDICATIVE**, *a.* Tending to vindicate.—2. Revengeful. [This is now generally *vindictive*.]

**VINDICATIVENESS**, *† n.* Vindictiveness.

**VINDICATOR**, *n.* One who vindicates; one who justifies or maintains; one who defends.

**VINDICATORY**, *a.* Punitive; inflicting punishment; avenging.

The afflictions of Job were not *vindictory* punishments.

*Bramhall.*

2. Tending to vindicate; justificatory.

**VINDICTIVE**, *a.* [Fr. *vindicatif*.]

Revengeful; given to revenge.

I am *vindictive* enough to repel force by force.

*Dryden.*

**VINDICTIVELY**, *adv.* By way of revenge; revengefully.

**VINDICTIVENESS**, *n.* A revengeful temper.—2. Revengefulness.

**VINE**, *n.* [L. *vinea*; Fr. *vigne*; from the It. *vigna*, Sp. *viña*, a vineyard; W. *gwinen*, vine, and *gwin*, wine. See **WINE**.] 1. A well known climbing plant with a woody stem, producing the grapes of commerce. It is of the genus *Vitis*, and of numerous varieties. [See **VITIS**.]—2. The long slender stem of any plant that trails on the ground, or climbs and supports itself by winding round a fixed object, or by seizing any fixed thing with its tendrils or claspers. Thus we speak of the hop *vine*, the bean *vine*, the *vines* of melons, squashes, pumpkins, and other cucurbitaceous plants.

**VINE-CLAD**, *a.* Clad or covered with vines.

**VINED**, *a.* Having leaves like those of the vine.

**VINE-DRESSER**, *n.* [vine and *dresser*.] One who dresses, trims, prunes, and cultivates vines.

**VINE-FRETTED**, *n.* [vine and *fret*.] A small insect that injures vines, the *aphis vitis*.

**VINEGAR**, *n.* [Fr. *vin*, wine, and *aigre*, sour.] 1. Dilute and impure acetic acid, obtained by the vinous fermentation. In wine countries it is obtained from the acetous fermentation of inferior wines, but in this country it is usually procured from an infusion of malt which has previously undergone the vinous fermentation. Vinegar may also be obtained from strong beer,

by the fermentation of various fruits, or of a solution of sugar mixed with yeast; in short, all liquids which are capable of the vinous fermentation may be made to produce vinegar. 120 parts of water, 12 of brandy, 3 of brown sugar, 1 of tartar, and  $\frac{1}{2}$  of sour dough, if left for some weeks in a warm place, yield a strong and pleasant vinegar. All the above vinegars yield by distillation a purer and somewhat weaker acetic acid, called *distilled vinegar*.—*Radical vinegar*, hydrated acetic acid, obtained by distilling 3 parts of dry powdered acetate of soda, with 9·7 of oil of vitriol, as pure and concentrated as possible. This vinegar, holding camphor and essential oils in solution, constitutes the *aromatic vinegar* of the shops.—*Wood vinegar*, pyroigneous acid,—*which see*. Common and distilled vinegars are used in pharmacy for preparing many remedies, and externally in medicine, in the form of lotions. The use of vinegar as a condiment is universal. It is likewise the antiseptic ingredient in pickles.— $\dagger$  Any thing really or metaphorically sour.—*Vinegar of lead*, a liquor formed by digesting ceruse or litharge with a sufficient quantity of vinegar to dissolve it.

**VINEGAR-CRUE**, *n.* A small glass bottle for holding vinegar.

**VINE-GRUB**, *n.* [vine and *grub*.] Another name for the vine-fretter, *aphis vitis*. [See **VINE-FRETTED**.]

**VINER**, *n.* An orderer or trimmer of vines.

**VINERY**, *n.* In *gardening*, a hot-house in which vines are grown.

**VINEYARD**, *n.* (vin'-yard.) [Sax. *vine-gard*; Ir. *fioghorth*.] A plantation of vines producing grapes; properly, an inclosure or yard for grape-vines.

**VINNEWED**, *† a.* [Sax. *fyntig*.] Mouldy; musty.

**VINNEWEDNESS**, *† n.* Mustiness; mouldiness.

**VINNY**, *† a.* [supra.] Mouldy; musty.

**VINOLENCY**, *† n.* [L. *violentia*, from *vinum*, wine.] Drunkenness.

**VINOLENT**, *† a.* Given to wine.

**VINOSTITY**, *n.* State or quality of being vinous.

**VINOUS**, *a.* [Fr. *vineux*, from L. **VINOSE**,] *vinum*, wine.] Having the qualities of wine; pertaining to wine; as, a *vinous* taste; a *vinous* flavour.—*Vinous fermentation*, that species of fermentation which terminates in the formation of an intoxicating liquid, or one which contains alcohol; as wine, beer, porter, cider, &c. It consists in the peculiar decomposition which the different species of sugar undergo in certain circumstances, and by which their elements combine to form new compounds, which, under similar conditions, are always the same. When a saccharine solution is placed in contact with substances in a state of decomposition or putrefaction, it is observed, after about 24 hours, if the temperature be kept between 40° and 85°, that the taste of the sugar has disappeared; pure carbonic acid is disengaged, and the liquid has acquired intoxicating qualities. It now contains alcohol, which may be separated by distillation. [See **FERMENTATION**.]

**VINQUISI**, *n.* A state of pining or languishing; a disease in sheep.

**VINTAGE**, *n.* [Fr. *vendange*, from L. *vendemia*.] 1. The produce of the vine for the season. The *vintage* is abundant.—2. The time of gathering the

crop of grapes.—3. The wine produced by the crop of grapes in one season.

**VINTAGER**, *n.* One that gathers the vintage.

**VINTAGE-SPRING**, *n.* A wine-fount.

**VINTAGER**, *n.* One who deals in wine; a wine-seller.

**VINTRY**, *n.* A place where wine is sold.

**VINUM**, *n.* [L.] Wine.

**VINY**, *a.* Belonging to vines; producing grapes.—2. Abounding in vines.

**VIOL**, *n.* [Fr. *viole*; It. and Sp. **VIO**LA,] *n.* *viola*; Ir. *biol*.] An ancient musical instrument of the same form as the violin, and which may be considered as the parent of our modern instruments of the violin kind. The viol was a stringed instrument with frets, and played on by a bow. There were three sorts, treble, tenor, and base, each having six strings. The *treble viol* was somewhat larger than our violin, and the music for it was written in the treble clef. The *tenor viol* was about the same length and breadth as the modern tenor violin, but thicker in the body, and the music for it was in the soprano, or C clef. The dimensions of the *base viol* were much the same as those of the violoncello, and the music for it was written in the base clef.—*Viol di gamba*, or *leg-viol*, an old musical instrument with six strings, so called because it was held between the legs. In form and dimensions it resembled the modern violoncello, and was the immediate predecessor of that instrument. Its tone was nasal and disagreeable.

Me softer airs befit, and softer strings  
Of lute, or viol, still more apt for mournful things.

*Milton.*

**VIOLA**, *n.* [It.] The tenor-violin, a kind of violin intermediate in size and pitch between the ordinary violin and violoncello. It has four catgut strings, of which the third and fourth are covered with silver wire. It is tuned C, D, A, G, reckoning upwards, and is an octave higher in pitch than the violoncello, and a fifth lower than the violin.

**VIOLA**, *n.* The violet; a genus of plants, the type of the nat. order Violaceæ. The species are exceedingly numerous; they are elegant low herbs, for the most part perennial, rarely annual. Eight species are enumerated by British botanists. The violets are favourite flowers in all northern and temperate climates, and many of them are among the first to make their appearance in the spring. The greatest favourites are the varieties of the *V. odorata*, or common sweet violet, and of *V. tricolor*, the pansy, or heart's ease. The flowers of *V. odorata* possess purgative or laxative properties, and *V. canina*, or dog's violet, is reputed a powerful agent for the removal of cutaneous affections.

**VIOLABLE**, *a.* [L. *violabilis*. See **VIOLATE**.] That may be violated, broken, or injured.

**VIOLACEÆ**, *n.* A nat. order of Polyptelous exogens, having the genus *Viola* for its type. The species are herbs, shrubs, or undershrubs, generally with alternate, simple leaves, furnished with stipules. The flowers are erect or drooping, axillary, seated on peduncles, which are one-flowered, solitary, or numerous, sometimes branched. The order is divided into two tribes, *Violæ* and *Alsodineæ*. *Violæ* chiefly consist of European, Siberian, and

7 K

American plants; Alsodineæ are South American and African plants. The roots of all the Violaceæ appear to be more or less emetic, a property which is strongly possessed by the South American species. Hence they form part of the herbs known under the name of Ipecaeanha.

**VIOLA'CEOUS, a.** [L. *viola*, a violet.] Resembling violets in colour.

**VIOLAS'CENT, a.** Resembling a violet in colour.

**VIOLATE, v. t.** [Fr. *violier*; L. *violo*; It. *violare*; Sp. *violar*.] 1. To injure; to hurt; to interrupt; to disturb; as, to violate sleep.

Kindness for man and pity for his fate,  
May mix with bliss and yet not violate.

*Dryden.*

2. To break; to infringe; to transgress; as, to violate the laws of the state, or the rules of good breeding; to violate the divine commands; to violate one's vows or promises. Promises and commands may be violated negatively, by non-observance.—3. To injure; to do violence to.

Forbid to violate the sacred fruit. *Milton.*

4. To treat with irreverence; to profane; as, to violate the sanctity of a holy place.—5. To ravish; to compress by force.

**VIOLATED, pp.** Injured; broken; transgressed; ravished.

**VIOLATING, ppr.** Injuring; infringing; ravishing.

**VIOLA'TION, n.** [Fr.] The act of violating or injuring; interruption, as of sleep or peace.—2. Infringement; transgression; non-observance; as, the violation of law or positive command; a violation of covenants, engagements, and promises; a violation of vows.—3. Act of irreverence; profanation or contemptuous treatment of sacred things; as, the violation of a church.—4. Ravishment; rape.

**VIOLATIVE, a.** Violating, or tending to violate.

**VIOLATOR, n.** One who violates, injures, interrupts, or disturbs; as, a violator of repose.—2. One who infringes or transgresses; as, a violator of law.—3. One who profanes or treats with irreverence; as, a violator of sacred things.—4. A ravisher.

**VIOLENCE, n.** [L. *violentia*.] 1. Physical force; strength of action or motion; as, the violence of a storm; the violence of a blow or of a conflict.—2. Moral force; vehemence. The critic attacked the work with violence.—3. Outrage; unjust force; crimes of all kinds.

The earth was filled with violence;  
Gen. vi.

4. Eagerness; vehemence.

You ask with violence. *Shak.*

5. Injury; infringement. Offer no violence to the laws, or to the rules of civility.—6. Injury; hurt.

Do violence to no man; Luke iii.

7. Ravishment; rape.—To do violence to or on, to attack; to murder.

But, as it seems, did violence on herself. *Shak.*

To do violence to, to outrage; to force; to injure. He does violence to his own opinions.

**VIOLENCE, v. t.** To assault; to injure; also, to bring by violence. [*Little used.*]

**VI'OLENT, a.** [Fr.; L. *violentus*.] 1. Forcible; moving or acting with physical strength; urged or driven with force; as, a violent wind; a vio-

lent stream; a violent assault or blow; a violent conflict.—2. Vehement; outrageous; as, a violent attack on the minister.—3. Produced or continued by force; not spontaneous or natural. No violent state can be perpetual. *Burnet.*

4. Produced by violence; not natural; as, a violent death.—5. Acting by violence; assailable; not authorized.

Some violent hands were laid on Humphry's life. *Shak.*

6. Fierce; vehement; as, a violent philippic; a violent remonstrance.

We might be reckoned fierce and violent. *Hooker.*

7. Severe; extreme; as, violent pains.—8. Extorted; not voluntary.

Vows made in pain, are violent and void. *Milton.*

**Violent presumption, in law,** is presumption that arises from circumstances which necessarily attend such facts. Such circumstances being proved, the mind infers with confidence that the fact has taken place, and this confidence is a violent presumption, which amounts to proof. *Violent profits, in Scots law,* profits made during an unlawful possession.

**VI'OLENT, † n.** An assailant.

**VI'OLENT, † v. t.** To urge with violence.

**VI'OLENTLY, adv.** With force; forcibly; vehemently; as, the wind blows violently.

Forfeitures must not be exacted violently. *Taylor.*

**VIOLES'CENT, a.** Tending to a violent colour.

**VI'OLET, n.** [Fr. *violette*; It. *violetto*; L. *viola*.] The common name of the different species of the genus *Viola*. [See **VIOLA**.]—2. A bluish purple colour, like that of the violet; one of the primitive colours.

**VI'OLET, a.** Dark blue inclining to red. *Violet-dye* is produced by a mixture of red and blue colouring matters, which are applied in succession.

**VI'OLIN, n.** [It. *violino*; Fr. *violin*; from *viol*.] A well-known musical instrument with four strings, played with a bow; a fiddle; one of the most perfect and most powerful instruments that has been invented. The finest violins are those of the old Cremona makers, Jerome, Anthony, and Nicholas Amati, and Stradivarius, and Guarnerius, and F. and T. and G. B. Ruggiero. Next in quality are those of Jacob Steiner, and of the two Klotz, father and son, Tyrolese makers. The violin is tuned G. D. A. E. reckoning upwards.

**VIOLINA, n.** In chem., a vegeto-alkali.

**VI'OLINIST, n.** A person skilled in playing on a violin.

**VI'OLIST, n.** A player on the viol.

**VIOLONCEL'LIST, n.** A performer on the violoncello.

**VIOLONCEL'LO, n.** [It.] A powerful and expressive bow instrument of the violin kind. It is a bass violin with four strings, the two lowest covered with silver-wire. It is tuned C. G. D. A. reckoning upwards, and is an octave lower than the viola, or tenor violin. The player holds it between his knees.

**VIOLONE, n.** [It.] The contra-basso, or double-bass; the largest instrument of the violin kind. It is seldom played with more than three strings, which lie an octave below the violoncello. It is chiefly used to sustain the harmony.

**VIPER, n.** [L. *vipera*; Fr. *vipere*; W. *gwiber*, from *gwib*, a quick course, a driving, flying, or serpentine motion, a

wandering.] 1. *Vipera*, a genus of venomous serpents, which produce living young, and have a head broader than the neck, and no pits behind the nostrils, as in the case of the rattlesnakes. The true vipers have the scales on the head similar to those on the back, and the nostrils very large. The minute viper, *V. brachyura*, is one of the most terrible of the genus, on account of the intensity and activity of its poison. The common viper, *V. berus*, of which there are several varieties, is the only poisonous serpent

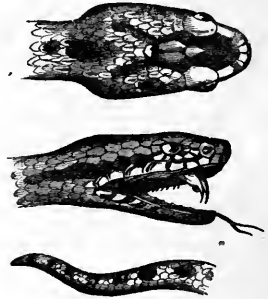

Head and Tail of Common Viper (*V. berus*).

which occurs in Britain, but it is not very common or very dangerous, except in very dry and warm parts of the country, and during the hot season. The horned viper, *V. cerastes*, the tufted viper, *V. lophophris*, and the brown and white viper, *V. hamachates*, are natives of Africa.—2. A person or thing mischievous or malignant.

**VIPER'IDÆ, n.** The family of vipers. It comprehends the true vipers, rattlesnakes, asp, &c.

**VIPERINE, a.** [L. *viperinus*.] Pertaining to a viper or to vipers.

**VIPEROUS, a.** [L. *viperous*.] Having the qualities of a viper; malignant; venomous; as, a viperous tongue.

**VIPER'S BUGLOSS, n.** A plant, the *Echium vulgare*. [See **ECHIUM**.]

**VIPER'S GRASS, n.** The common name of the different species of plants belonging to the genus *Scorzonera*. *S. hispanica*, or esculent viper's grass, is cultivated for its carrot-shaped roots, which are considered a dainty. Nat. order, Compositæ.

**VIRAGIN'IAN, a.** Having the qualities of a virago.

**VIRAGIN'ITY, n.** The qualities of a virago.

**VIRA'GŌ, n.** [L. from *vir*, a man.] 1. A woman of extraordinary stature, strength, and courage; a female who has the robust body and masculine mind of a man; a female warrior.—2. In common lan., a bold, impudent, turbulent woman; a termagant.

**VIRE, † n.** [Sp. *vira*.] An arrow for the cross-bow; a quarrel.

**VIR'ELAY, n.** [Fr. *virelai*, from *virer*, to turn.] An ancient French song or short poem, derived from Provence, of a peculiar measure, and usually of a sportive character. The modern *virelay* turns upon two sets of rhymes, the first of which prevails throughout the piece, and the other occurs only from time to time, to produce variety.

To which a lady sung a *virelay*. *Dryden.*

**VI'RENT, a.** [L. *virens*, from *vireo*, to be green.] Green; verdant; fresh.

**VIRESC'ENT, a.** Slightly green; beginning to be green.

**VIR'GATE**, *n.* (nearly *virgate*.) [*L. virga*, a rod.] In *bot.*, having the shape of a rod or wand; as, a *virgate* stem.

**VIR'GATE**, *n.* A yardland,—*which see*.  
**VIR'GE**. See **VERGE**.

**VIRGIL'IA**, *n.* A genus of plants, nat. order Leguminosæ. The species are chiefly tropical. The roots of *V. aurea*,



*Virgilia aurea.*

an Indian species, yield a yellow dye. *V. lutea*, of North America, is an elegant hardy shrub, frequently cultivated in gardens. The bark yields a yellow colouring matter.

**VIRGIL'IAN**, *a.* Pertaining to Virgil, the Roman poet; as, *virgilian* husbandry, which was the system of agriculture practised by the Romans, and which is described in the *Georgics* of Virgil.—2. Resembling the style of Virgil.

**VIR'GIN**, *n.* (nearly *virgin*.) [*It. virgine*; *Sp. virgen*; *Fr. vierge*; *L. virgo*.] 1. A woman who has had no carnal knowledge of man.—2. A woman not a mother. [*Unusual*.]—3. A person of either sex who has not been married; 1 Cor. vii. 25.—4. The sign Virgo. [*See VIRGO*.]

**VIR'GIN**, *a.* Pure; untouched; as, *virgin* gold.—2. Fresh; new; unused; as, *virgin* soil.—3. Becoming a virgin; maidenly; modest; indicating modesty; as, a *virgin* blush; *virgin* shame.—4. Pure; chaste.

**VIR'GIN**, *v. i.* To play the virgin; *a cant word*.

**VIR'GINAL**, *a.* Pertaining to a virgin; maidenly; as, *virginal* chastity.

**VIR'GINAL**, *n.* A keyed musical instrument of one string, jack and quill to each note, like a spinet, but in shape resembling the present small pianoforte. It is now entirely disused.

**VIR'GINAL**, *v. i.* To pat; to strike, as on a virginal. [*A cant word*.]

**VIR'GIN-BORN**, *a.* Born of the Virgin. [*An epithet applied to our Saviour, by Milton*.]

**VIRGIN'IAN SNAKE ROOT**, *n.* A plant of the genus *Polygala*, the *P. senega*. [*See POLYGALA*.]

**VIRGIN'ITY**, *n.* [*L. virginitas*.] Maidenhood; the state of having had no carnal knowledge of man.

**VIR'GIN'S BOWER**, *n.* A plant of the genus *Clematis*, the *C. vitalba*, called also traveller's joy, and old man's beard. [*See CLEMATIS*.]

**VIR'GO**, *n.* [*L.*] One of the twelve signs or constellations of the Zodiac, which the sun enters about the 22d of August. It is the sixth in order of the signs beginning with Aries, and contains, according to the British catalogue, 110 stars, among which are two remarkable stars; the first, *Spica Virginis*, of the first magnitude, and the second, *Vindimiatriz*, of the third magnitude. *Virgo* is usually repre-

sented with an ear of corn in her hand, intended to denote the period of harvest.

**VIR'GOLEUSE**, *n.* [*Fr.*] A variety of pear of an excellent quality; with us pronounced *virgoloa*, or *vergoloa*. [*See VERGOULEUSE*, the correct orthography.]

**VIR'ID**, *a.* Green; verdant.

**VIRID'ITY**, *n.* [*L. viriditas*, from *virreo*, to be green.] Greenness; verdure; the colour of fresh vegetables.

**VIR'IDNESS**, *n.* Viridity; greenness; verdant.

**VIR'ILE**, *a.* [*L. virilis*, from *vir*, a man, *Sax. wer*; *Sans. viras*, strong; from the root of *L. viroo*.] 1. Pertaining to a man, in the eminent sense of the word, [not to *man*, in the sense of the human race;] belonging to the male sex; as, *virile* age.—2. Masculine; not *puerile* or *feminine*; as, *virile* strength or vigour.

**VIRIL'ITY**, *n.* [*Fr. virilité*; *L. virilitas*.] 1. Manhood; the state of the male sex which has arrived to the maturity and strength of a man, and to the power of procreation.—2. The power of procreation.—3. Character of man. [*Unusual*.]

**VIRIP'OTENT**, *a.* Fit for a husband; marriageable.

**VIROLE'**, *n.* [*Fr.*] In *her.*, the hoop, ring, or mouth-piece of the bugle or hunting horn.

**VIROLLED**, *pp.* In *her.*, an epithet applied to the garnishings of the bugle horn, being the rings or rims which surround it at various parts.

**VIR'TU**, *n.* [*It. vertu*.] A love of the fine arts; a taste for curiosities.

**VIR'TUAL**, *a.* [*Fr. virtuel*; from *virtue*. See **VIRTUE**.] 1. Potential; having the power of acting or of invisible efficacy without the material or sensible part.

Every kind that lives,  
Fomented by his *virtual* power, and warm'd.  
*Milton*.

Neither an actual nor *virtual* intention of the mind, but only that which may be gathered from the outward acts.

*Stillingfleet*.  
2. Being in essence or effect, not in fact; as, the *virtual* presence of a man in his agent or substitute.—*Virtual focus*, in *optics*, the point from which rays, which have been rendered divergent by reflection or refraction, appear to issue. [*See FOCUS*.]—*Virtual velocity*, in *mech.*, the velocity which a body in equilibrium would actually acquire, during the first instant of its motion, in case of the equilibrium being disturbed. The principle of *virtual velocities* may be thus enunciated: "If any system of bodies or material points, urged each by any forces whatever, be in equilibrium, and there be given to the system any small motion, by virtue of which, each point describes an infinitely small space, which space will represent the *virtual velocity* of the point; then the sum of the forces, multiplied each by the space which the point to which it is applied describes in the direction of that force, will be always equal to zero or nothing, regarding as positive the small spaces described in the direction of the forces, and as negative those described in the opposite direction." This great principle may be considered as the golden rule of mechanics. It is easily verified by experiment with respect to the six mechanical powers, but it applies immediately and most evidently to all

questions respecting equilibrium or statical problems, and it furnishes a very easy method of ascertaining the power of any machine, or the proportion between two forces which would balance one another. For according to this principle, the power multiplied by the space through which it moves in the vertical direction, must always be equal to the weight multiplied by the space through which it moves in the vertical direction.

**VIRTUAL'ITY**, *n.* Efficacy.

**VIR'TUALLY**, *adv.* In efficacy or effect only; by means of some virtue or influence, or the instrumentality of something else. Thus the sun is *virtually* on earth by its light and heat. The citizens of an elective government are *virtually* present in the legislature by their representatives. A man may *virtually* agree to a proposition by silence or withholding objections.

**VIR'TUATE**, *v. t.* To make efficacious. **VIRTUE**, *n.* (*ver'tu*.) [*Fr. vertu*; *It. virtù*; *L. virtus*, from *viroo*, or its root. See **WORTH**.] The radical sense is strength, from straining, stretching, extending. This is the primary sense of *L. vir*, a man.] 1. Strength; that substance or quality of physical bodies, by which they act and produce effects on other bodies. In this literal and proper sense, we speak of the *virtue* or *virtues* of plants in medicine, and the *virtues* of drugs. In decoctions the *virtues* of plants are extracted. By long standing in the open air, the *virtues* are lost.—2. Bravery; valour. This was the predominant signification of *virtus* among the Romans.

Trust to thy single *virtues*.  
*Shak*.  
[*This sense is nearly or quite obsolete*.]  
3. Moral goodness; the practice of moral duties and the abstaining from vice, or a conformity of life and conversation to the moral law. In this sense, *virtue* may be, and in many instances must be, distinguished from *religion*. The practice of moral duties merely from motives of convenience, or from compulsion, or from regard to reputation, is *virtue*, as distinct from *religion*. The practice of moral duties from sincere love to God and his laws, is *virtue* and *religion*. In this sense it is true,  
That *virtue* only makes our bliss below.

*Pope*.  
*Virtue* is nothing but voluntary obedience to truth.  
*Dwight*.

4. A particular moral excellence; as, the *virtue* of temperance, of chastity, of charity.

Remember all his *virtues*.  
*Addison*.

5. Acting power; something efficacious. Jesus, knowing that *virtue* had gone out of him, turned;—Mark iii.

6. Secret agency; efficacy without visible or material action. She moves the body which she doth possess, Yet no part toucheth, but by *virtue's* touch.  
*Davies*.

7. Excellence; or that which constitutes value and merit. Terence, who thought the sole grace and *virtue* of their fable, the sticking in of sentences.  
*B. Jonson*.

8. One of the orders of the celestial hierarchy. Thrones, dominations, principedoms, *virtues*, powers.  
*Milton*.

9. Efficacy; power. He used to travel through Greece by *virtue* of this fable, which procured him reception in all the towns.  
*Addison*.

10. Legal efficacy or power; authority. A man administers the laws by *virtue* of a commission.—*In virtue*, in consequence; by the efficacy or authority.

This they shall attain, partly in *virtue* of the promise of God, and partly in *virtue* of piety.

*Atterbury.*

**VIR'TUELESS**, *a.* Destitute of virtue.—2. Destitute of efficacy or operating qualities.

*Virtueless* she wish'd all her herbs and charms.

*Fairfax.*

**VIR'TUE-PROOF**, † *a.* Irresistible in virtue.

**VIRTUO'SO**, *n.* [It.] A man skilled in the fine arts, particularly in music; or a man skilled in antiquities, curiosities and the like.

*Virtuoso* the Italians call a man who loves the noble arts, and is a critic in them.

*Dryden.*

**VIRTUO'SOSHIP**, *n.* The pursuits of a virtuoso.

**VIR'TUOUS**, *a.* Morally good; acting in conformity to the moral law; practising the moral duties, and abstaining from vice; as, a *virtuous* man.—2. Being in conformity to the moral or divine law; as, a *virtuous* action; a *virtuous* life.

The mere performance of *virtuous* actions does not denominate an agent *virtuous*.

*Price.*

3. Chaste; applied to women.—4. † Efficacious by inherent qualities; as, *virtuous* herbs; *virtuous* drugs.—5. † Having great or powerful properties; as, *virtuous* steel; a *virtuous* staff; a *virtuous* ring.—6. † Having medicinal qualities.

**VIR'TUOUSLY**, *adv.* In a virtuous manner; in conformity with the moral law or with duty; as, a life *virtuously* spent.

A child *virtuously* educated.

*Addison.*

**VIR'TUOUSNESS**, *n.* The state or character of being virtuous.

**VIR'ULENCE**, † *n.* [from *virulent*.]

**VIR'ULENCY**, † *n.* That quality of a thing which renders it extremely active in doing injury; acrimony; malignancy; as, the *virulence* of poison.—2. Acrimony of temper; extreme bitterness or malignity; as, the *virulence* of enmity or malice; the *virulence* of satire; to attack a man with *virulence*.

**VIR'ULENT**, *a.* [L. *virulentus*, from *virus*, poison, that is, strength, from the same root as *vir*, *video*. See **VENOM**.]

1. Extremely active in doing injury; very poisonous or venomous. No poison is more *virulent* than that of some species of serpents.—2. Very bitter in enmity; malignant; as, a *virulent* invective.

**VIR'ULENTED**, † *a.* Filled with poison.

**VIR'ULENTLY**, *adv.* With malignant activity; with bitter spite or severity.

**VIR'US**, *n.* [L. See **VIRULENT**.] A poison. Active or contagious matter of an ulcer, pustule, &c. In the language of *pathology*, any matter which is the product of a disease, and is capable of producing that disease in a healthy individual by inoculation or absorption through the cuticle, is called the *virus* of that disease; as the *virus* of small pox, the venereal *virus*, &c.

**VIS**, *n.* [L.] Force or power. A term used in *mech.*, chiefly by the older writers, to denote various kinds of natural forces or powers.—*Vis acceleratrix*, accelerating force; *vis absoluta*, absolute force; *vis impressa*, the force exerted on any body to change its state, whether it be at rest or moving uniformly in a straight line.—*Vis*

*inertia*, literally the force of inactivity. This term was employed by Newton to signify a power implanted in all matter, by which it resists any change endeavoured to be made in its state; that is, by which it becomes difficult to alter its state either of rest or motion. A distinction is made between *vis inertia* and *inertia*, the former implying the *resistance* itself which is given by a body to any force endeavouring to make it change its state; and the latter merely the *property* by which the resistance is given.—*Vis motrix*, moving force.—*Vis mortua* and *vis viva*, terms used by Leibnitz and his followers; the former signifying the power of pressure in a body at rest; and the latter, the force or power of a body in motion, estimated by the distance to which the body goes.—2. In *physiology*, a term applied to the vital power and its effects.—*Vis a tergo*, any moving power acting from behind.—*Vis insita*, that power by which a muscle, when wounded, touched, or irritated, contracts independently of the will of the animal which is the object of the experiment, and without its feeling pain.—*Vis medicatrix nature*, that healing power in an animated body, by which, when diseased, the body is enabled to regain its healthy actions. It is also termed *vis conservatrix*.—*Vis mortua*, that property by which a muscle, after the death of the animal, or immediately after having been cut out of the living body, contracts.—*Vis nervosa*, the power of the muscles, by which they act, when excited by the nerves, as opposed to the *vis insita*.—*Vis plastica*, the formative power or energy which spontaneously operates in animals.—*Vis vite*, the vital power or energy; the natural power of the animal machine in preserving life.—3. In *law*, violence or any kind of force.

**VIS'AGE**, *n.* (s as z.) Fr. from It. *visaggio*; from L. *visus*, *video*.] The face; the countenance or look of a person, or of other animal; chiefly applied to human beings; as, a wolfish *visage*. Love and beauty still that *visage* grace.

*Waller.*

His *visage* was so marred, more than any man; is. lii.

**VIS'AGED**, *a.* Having a visage or countenance.

**VIS'ARD**, *n.* A mask. [See **VISON**.]

**VIS'ARD**, *v. t.* To mask.

**VIS-A-VIS**, *n.* (viz'-a-vee.) [Fr. opposite, face to face.] Two persons sitting or standing face to face are said to be *vis-à-vis*. In some dances a partner is often colloquially called a *vis-à-vis*.—2. A carriage in which two persons sit face to face.

**VIS'CERA**, *n.* [L. plur. of *viscus*.] The bowels; the contents of the abdomen, thorax, and cranium. In its most general sense, the organs contained in any cavity of the body, particularly in the thorax, and abdomen.

**VIS'ERAL**, *a.* [L. *viscera*.] 1. Pertaining to the viscera.—2. Feeling; having sensibility. [Unusual.]

**VIS'ERATE**, *v. t.* [supra.] To exten-terate; to embowel; to deprive of the entrails or viscera. [Eviscerate is generally used.]

**VIS'CID**, *a.* [L. *viscidus*; *viscus*, birdlime.] Glutinous; sticky; tenacious; not readily separating; as, turpentine, tar, gums, &c., are more or less *viscid*.

**VISCID'ITY**, *n.* Glutinousness; tenacity; stickiness.—2. Glutinous concretion.

**VISCOUSITY**, } *n.* Glutinousness; }  
**VIS'COUSNESS**, } tenacity; viscosity; }  
that quality of soft substances which makes them adhere so as not to be easily parted.

**VISCOUNT**, *n.* (vi'count.) [L. *vicecomes*; Fr. *vicomte*.] 1. Literally, a *vice-count*. An officer who formerly supplied the place of the count or earl, and acted as his deputy in the management of the affairs of the county; he was in fact the sheriff of the county.—2. A degree or title of nobility next in rank to an earl, and immediately above that of baron. It is the most recently established English title, having been first conferred by letters patent on John, lord Beaumont, by Henry VI.,



Viscount's coronet.

in 1440.—The coronet of a viscount of England is composed of a circle of gold, chased; having on the edge twelve balls or pearls; the cap, of crimson velvet, turned up with ermine, and closed at the top with a rich tassel of gold.

**VISCOUNTESS**, *n.* (vi'countess.) The lady of a viscount; a peeress of the fourth order.

**VISCOUNTSHIP**, (vi'countship.) } *n.*  
**VISCOUNTY**, (vi'county.) }  
The quality and office of a viscount.

**VIS'COUS**, *a.* [Fr. *visqueux*; from L. *viscus*, birdlime.] Glutinous; clammy; sticky; adhesive; tenacious; as, a *viscous* juice.

**VIS'CIUM**, *n.* A genus of parasitical plants; the *mistletoe*,—which see.—2. Birdlime.

**VIS'CEUS**, *n.* [L. plur. *viscera*.] An entrail, one of the contents of the thorax, or abdomen.

**VISE**, (vizeh') [F.] Literally, *seen*, an indorsation made upon a passport by the properly constituted authorities, whether ambassador, consul, or police, denoting that it has been examined and found correct.

**VISH'NU**, *n.* In the *Hindoo myth.*, the name of one of the chief deities of the



Vishnu.

trimurti or triad, the other two being *Brahma* and *Siva*. He is the second

person of this unity, and a personification of the preserving powers. Hence, he is frequently called the Preserver, the other two being respectively the Creator and the Destroyer.

**VISIBILITY**, *n.* (s as z.) [from *visible*; Fr. *visibilité*.] 1. The state or quality of being perceivable to the eye; as, the *visibility* of minute particles, or of distant objects.—2. The state of being discoverable or apparent; conspicuousness; as, the perpetual *visibility* of the church.

**VIS'IBLE**, *a.* (s as z.) [Fr. from *l. visibilis*.] 1. Perceivable by the eye; that can be seen; as, a *visible* star; the least spot is *visible* on white paper; the fine dust or other matter in air agitated by heat becomes *visible*; as in the air near a heated stove, or over a dry, sandy plain, appearing like pellucid waves.

Virtue made *visible* in outward grace.

*Young.*

In *optics*, objects are said to be *visible* when they emit or reflect a sufficient quantity of light, to make a sensible impression on the eye.—2. Discovered to the eye; as, *visible* spirits.—3. Apparent; open; conspicuous. Factions at court became more *visible*.—*Visible church*, in *theol.*, the apparent church of Christ; the whole body of professed believers in Christ, as contradistinguished from the real or *invisible* church, consisting of sanctified persons.—*Visible horizon*, the line that bounds the sight. [See *HORIZON*.]

**VIS'IBLENESS**, *n.* State or quality of being visible; visibility.

**VIS'IBLY**, *adv.* In a manner perceptible to the eye. The day is *visibly* governed by the sun; the tides are *visibly* governed by the moon.

**VISIER**. See *VIZIER*.

**VIS'IGOTH**, *n.* The name of the Western Goths, or that branch of the Gothic tribes which settled in Dacia, as distinguished from the *Ostrogoths*, or Easter Goths, who had their seats in Pontus.

**VISIGOTHIC**, *a.* Pertaining to the Visigoths.

**VIS'ION**, *n.* (s as z.) [Fr. from *L. visio*, from *video*, *visus*.] 1. The act of seeing external objects; actual sight.

Faith here is turned into *vision* there.

*Hammond.*

2. In *optics*, the faculty of seeing; sight; the perception of external objects, as conveyed to the brain by means of the organs of sight. Modern philosophers agree in referring the cause of vision to the impressions of light on the eye, and the retina of the eye has usually been regarded as the seat of vision. [See *EYE*, *SIGHT*.]

*Vision* is far more perfect and acute in some animals than in man.—3. Something imagined to be seen, though not real; a phantom; a spectre; a mental or optical illusion.

No dreams, but *visions* strange. *Sidney.*

4. In *scrip.*, a revelation from God, an appearance or exhibition of something supernaturally presented to the minds of the prophets, by which they were informed of future events. Such were the *visions* of Isaiah, of Amos, of Ezekiel, &c.—5. Something imaginary; the production of fancy.—6. Any thing which is the object of sight.

**VIS'IONAL**, *a.* Pertaining to a vision.

**VIS'IONARINESS**, *n.* The quality of being visionary.

**VIS'IONARY**, *a.* [Fr. *visionnaire*.]

1. Affected by phantoms; disposed to receive impressions on the imagination.

Or lull to rest the *visionary* maid. *Pope.*

2. Imaginary; existing in imagination only; not real; having no solid foundation; as a *visionary* prospect; a *visionary* scheme or project.

**VIS'IONARY**, *n.* One whose imagination is disturbed.—2. One who forms impracticable schemes; one who is confident of success in a project which others perceive to be idle and fanciful. [Visionist, in a like sense, is not used.]

**VIS'IONLESS**, *a.* Destitute of visions.

**VISIT**, *v. t.* (s as z.) [L. *visito*; Fr. *visiter*; It. *visitare*; from *L. viso*, to go to see; W. *gwést*, *gwesta*, to visit, to go about; *gwést*, a going, a visit; *gwes*, that is, going or moving. We see the sense is to go, to move to.] 1. To go or come to see; to attend. The physician visits his patient and prescribes. One friend *visits* another from respect or affection. Paul and Barnabas *visited* the churches they had planted, to know their state and confirm their faith. Men *visit* France, Germany, or Italy in their travels.—2. To go or come to see for inspection, examination, correction of abuses, &c.; as, a bishop *visits* his diocese; a superintendent *visits* those persons or works which are under his care.—3. To salute with a present.

Samson *visited* his wife with a kid; *Judges* xv.

4. To go to and to use; as, to *visit* the springs.—5. In *naval affairs*, to enter on board a vessel for the purpose of ascertaining her character without searching her. [Fr. *droite de visite*.]

—To *visit* in *mercy*, in *scrip. lan.*, to be propitious; to grant requests; to deliver from trouble; to support and comfort. It is thus God *visits* his people; Gen. xxi.; Zech. x.; Luke xii.—To *visit with the rod*, to punish; Ps. lxxxix.—To *visit in wrath*, or *visit iniquity* or *sins upon*, to chastise; to bring judgments on; to afflict; Exod. xx.—To *visit the fatherless and widow*, or *the sick and imprisoned*, to show them regard and pity, and relieve their wants; Matth. xxv.; James i.

**VISIT**, *v. i.* To keep up the interchange of civilities and salutations; to practice going to see others. We ought not to *visit* for pleasure or ceremony on the sabbath.

**VISIT**, *n.* The act of going to see another, or of calling at his house; a waiting on; as, a *visit* of civility or respect; a *visit* of ceremony; a short *visit*; a long *visit*; a pleasant *visit*.—2. The act of going to see; as, a *visit* to the Falls of Clyde or to Niagara.—3. A going to see or attending on; as, the *visit* of a physician.—4. The act of going to view or inspect; as, the *visit* of a trustee or inspector.

**VISITABLE**, *a.* Liable or subject to be visited. All hospitals in England, built since the reformation, are *visit-able* by the king or lord chancellor.

**VISITAN'DINE**, *n.* A religieuse of the order of the visitation, founded A.D. 1520. The *visitandines* were uncloistered, and their chief secular duty was to visit and comfort the sick prisoners, &c. [See *VISITATION*, def. 7.]

**VISITANT**, *n.* One that goes or comes to see another; one who is a guest in the house of a friend.

When the *visitant* comes again he is no more a stranger. *South.*

**VISITATION**, *n.* [Fr. from *L. visito*.] 1. The act of visiting.

Nothing but peace and gentle *visitation*. *Shak.*

2. Object of visit.

O flowers!

My early *visitation* and mylast. [Unusual.] *Milton.*

3. In *law*, the act of a superior or a superintending officer, or officers, who visit a corporation, college, church, hospital, or other institution, to examine into the manner in which it is conducted, and see that its laws and regulations are duly observed and executed.—4. In *eccles. law*, the inspection by the bishop of the several parishes within his diocese, or by an archbishop of the dioceses in his province. The modern practice of episcopal visitations, however, is to summon the clergy from several parts to one convenient place, while the visitation of the ancient parochial institutions has by degrees devolved on the archdeacons. The duty of the archdeacons now is to visit their respective archdeaconries from time to time, to see that the churches are kept in repair, and that every thing is done conformably to the canons, and consistently with the decent and orderly performance of public worship; and to receive presentations from the church wardens of matters of public scandal. 5. In *scrip.*, and in a *religious sense*, the sending of afflictions and distresses on men to punish them for their sins, or to prove them. Hence afflictions, calamities, and judgments are called *visitations*.

What will ye do in the day of *visitation*? Is. x.

6. Communication of divine love; exhibition of divine goodness and mercy.—7. A church festival in honour of the visit of the Virgin Mary to Elizabeth, celebrated on the second of July.

**VISITATORIAL**, *a.* Belonging to a judicial visitor; as, *visitatorial* power. **VISITED**, *pp.* Waited on; attended; inspected; subjected to sufferings; favoured with relief or mercy.

**VISITING**, *ppr.* Going or coming to see; attending on, as a physician; inspecting officially; afflicting; showing mercy to.—2. *a.* Authorized to visit and inspect; as, a *visiting* committee.

**VISITING**, *n.* The act of going to see or of attending; visitation.

**VISITOR**, *n.* [Fr. *visiteur*.] 1. One who comes or goes to see another, as in civility or friendship.—2. A superior or person authorized to visit a corporation or any institution, for the purpose of seeing that the laws and regulations are observed, or that the duties and conditions prescribed by the founder or by law, are duly performed and executed.

The king is the *visitor* of all lay corporations. *Blackstone.*

**VISITORIAL**, *a.* [from *visitor*.] Belonging to a judicial visitor or superintendent.

An archdeacon has *visitatorial* power in parishes. *Aylife.*

**VISIVE**, † *a.* [from *L. visus*.] Pertaining to the power of seeing; formed in the act of seeing.

**VISMIA**, *n.* A genus of plants, nat. order Hypericaceæ. The bark of *V. guianensis*, a native of Guiana and Bengal, yields a gum resin, which resembles gamboge. The leaves and

fruit yield a similar secretion. It is used in medicine as a purgative; and a



Vismia guianensis.

decoction of the leaves is recommended in intermittent fever.

**VISNE**, *n.* (veen.) [Norm. from *L. vicina*.] Neighbourhood. [See **VENUE**.]

**VIS'NOMY**, † *n.* [a barbarous contraction of *physiognomy*.] Face; countenance.

**VISOR**, † *n.* (*s* as *z*.) [Fr. *visiere*; It. *visor*,] *visiera*; from *L. visus, video*; written also *visard, visar, vizard*.] 1. A head piece or mask used to disguise and disguise.

My weaker government since, makes you pull off the visor. *Sidney.*  
Swarms of knaves the visor quite disgrace. *Young.*

2. The movable and perforated face guard of a helmet.

**VISORED**, *a.* Wearing a visor; masked; disguised.

**VIS'OR-LIKE**, *a.* Resembling a visor or mask.

**VIS'TA**, *n.* [It. *sight*; from *L. visus, video*.] A view or prospect through an avenue, as between rows of trees; hence, the trees or other things that form the avenue.

The finish'd garden to the view  
Its vistas opens and its alleys green.

*Thomson.*

**VIS'UAL**, *a.* (*s* as *z*.) [Fr. *visuel*; It. *visuale*; from *L. visus*.] Pertaining to sight; used in sight; serving as the instrument of seeing; as, the *visual* nerve.

The air,

No where so clear, sharpen'd his *visual* ray. *Milton.*

*Visual point*, in *persp.*, a point in the horizontal line, in which all the visual rays unite.—*Visual rays*, lines of light, imagined to come from the object to the eye.—*Visual angle*, the angle under which an object is seen, or the angle formed at the eye by the rays of light which come from the extremities of the object. When an object is near the eye the visual angle is increased, and, when at a distance, it is diminished. Hence, objects at a distance appear smaller than when near us.

**VIS'UALIZE**, *v. t.* To make visual.

**VIS'UALIZED**, *pp.* Rendered visual.

**VITACEÆ**, *n.* A nat. order of plants, of which the genus *Vitis* is the type. The species are, for the most part, inhabitants of the warmer parts of the temperate zone, and are found in both the old and new worlds, especially in Asia. They are composed of sarmentose and climbing shrubs; the lower leaves are opposite, and the upper ones alternate, stalked, simple, lobed, or compound, with stipules at the base. The peduncles are racemose,

thyrsoid, corymbose, cymose, or umbellate, opposite the leaves, and are sometimes changed into tendrils. The most characteristic property of this order is acidity, which is most fully developed in the grape-vine. The acid of the grape is chiefly the tartaric; malic acid is, however, found in them. The dried fruit and wine are the really important products of the grape, and are yielded by no other of the order, if we except the Fox-grapes of North America. All the species are climbing plants, and some of them are supplied with hooked tendrils, by which they lay hold of the branches of trees, and thus elevate themselves above their summits.

**VITAL**, *a.* [*L. vitalis*, from *vita*, life. This must be a contraction of *victa*, for *vivo* forms *vixi, victus*; Gr. *βίος*, from *βίωσ*, contracted.] 1. Pertaining to life, either animal or vegetable; as, *vital* energies; *vital* powers.—2. Contributing to life; necessary to life; as, *vital* air; *vital* blood.—3. Containing life.

Spirits that live throughout,

*Vital* in every part. *Milton.*

And *vital* virtue infus'd, and *vital* warmth.

*Milton.*

4. Being the seat of life; being that on which life depends.

The dart flew on, and pierc'd a *vital* part.

*Pope.*

5. Very necessary; highly important; essential. Religion is a business of *vital* concern. Peace is of *vital* importance to our country.—6. So disposed as to live.

Pythagoras and Hippocrates affirm the birth of the seventh month to be *vital*.

[*Little used.*] *Brown.*

*Vital air*, oxygen gas, which is essential to animal life.—*Vital functions*, those functions or faculties of the body on which life immediately depends; as, the circulation of the blood, respiration, the heat of the body, &c.—*Vital principle*, the unknown cause of life.—*Vital fluid*, in *plants*, a peculiar fluid found in certain vessels, called *vital vessels*. It is also termed *latex*, and appears to be the same as that which is denominated the milk of plants. It has a rapid vital motion, and is supposed to be analogous to the blood in cold-blooded animals.

**VITALITY**, *n.* [from *vital*.] The principle of animation, or of life; as, the *vitality* of vegetable seeds or of eggs.—2. The act of living; animation.

**VITALIZA'TION**, *n.* The act or process of infusing the vital principle.

**VITALIZE**, *v. t.* To give life to.—2. To furnish with the vital principle; as, *vitalized* blood.

**VITALIZED**, *pp.* Supplied with the vital principle.

**VITALIZING**, *ppr.* Furnishing with the vital principle.

**VITALLY**, *adv.* In such a manner as to give life.

The organic structure of human bodies, by which they are fitted to live and move, and to be *vitally* informed by the soul, is the workmanship of a most wise and beneficent Maker. *Bentley.*

2. Essentially; as, *vitally* important. **VITALS**, *n. plur.* Parts of animal bodies essential to life, such as the viscera dependent upon the great sympathetic nerve.—2. The part essential to life, or to a sound state. Corruption of manners preys upon the *vitals* of a state.

**VIT'ELLARY**, *n.* [*L. vitellus*, the yolk

of an egg.] The place where the yolk of an egg swims in the white. [*Lit. us.*] **VIT'ELLUS**, *n.* In *bot.*, a membrane inclosing the embryo in some plants, as *Nymphaea*, *Ginger*, and *Pepper*. It seems to be the remains of the embryonic, or the sac of the amnios.

**VITEX**, *n.* A genus of plants, nat. order *Verbenaceae*. The longest known species is *V. agnus castus*, the chaste tree, a native of the south of Europe. The fruit is globular, with an acrid and aromatic taste, and is called *petit poivre*, and *poivre sauvage*, in the south of France. The leaves, in ancient times, were strewed upon beds, and supposed to preserve chastity. *V. altissima* and *V. arborea*, which grow in hot countries, yield valuable timber.

**VIT'IMATE**, *v. t.* [*L. vitio*. See **VICE**.]

1. To injure the substance or qualities of a thing, so as to impair or spoil its use and value. Thus we say, luxury *vitiate*s the humours of the body; evil examples *vitiate* the morals of youth; language is *vitiated* by foreign idioms.

This undistinguishing complaisance will *vitiate* the taste of readers. *Garth.*

2. To render defective; to destroy; as, the validity or binding force of an instrument or transaction. Any undue influence exerted on a jury *vitiate*s their verdict. Fraud *vitiate*s a contract.

**VIT'LATED**, *pp.* Depraved; rendered impure; rendered defective and void.

**VIT'TIATING**, *ppr.* Depraving; rendering of no validity.

**VITIA'TION**, *n.* The act of vitiating; depravation; corruption; as, the *vitiatio*n of the blood.—2. A rendering invalid; as, the *vitiatio*n of a contract.

**VITILL'GO**, *n.* [*L. vitulus*, a calf.] A disease of the skin, giving it a white appearance, somewhat resembling the flesh of calves.

**VITILIT'IGATE**, † *v. i.* [*L. vitiosus* and *litigo*.] To contend in law litigiously or cavilously.

**VITILITIGA'TION**, † *n.* Cavilous litigation.

**VITIO'SITY**, *n.* A corrupted state; depravation.

He charges it wholly upon the corruption, perverseness, and *vitiosity* of man's will. *South.*

**VIT'IOUS**, **VIT'IOUSLY**, **VIT'IOUSNESS**. See **VICIOUS**, and its derivatives.

**VITIS**, *n.* The vine. A genus of plants, the type of the nat. order *Vitaceæ*. The species, which are found chiefly in Asia and America, are climbing shrubs, with simple lobed, cut, or toothed, rarely compound leaves, and thyrsoid racemes of small greenish yellow flowers. The best known, and by far the most important species, is



Vine (*Vitis vinifera*).

the *V. vinifera*, the common vine, or grape-vine, of which there is a multi-



tude of varieties. The cultivation of the vine extends from near 55° north latitude to the equator, but in south latitudes it only extends to about 40°. It is rarely grown at a greater altitude than 3000 feet. In favourable seasons the vine ripens in the open air in England, and in the 11th and 12th centuries, considerable quantities of inferior wine were made from native grapes. Vineyards are now, however, unknown in this country; but the grapes raised in hot houses are excellent. The vine grows in every sort of soil; but that which is light and gravelly seems best suited for the production of fine wines. It succeeds extremely well in volcanic countries. The vine is a long-lived plant; indeed, in warm climates, the period of its existence is not known. It is propagated from seeds, layers, cuttings, grafting, and by inoculation. Several species of vine are indigenous in North America, as the *Vitis labrusca*, the wild-vine or fox-grape; *V. cordifolia*, heart-leaved vine or chicken grape; *V. riparia*, river-side or sweet-scented vine. [See WINE.]

**VITREO-ELECTRIC**, *a.* Containing or exhibiting positive electricity, or that which is excited by rubbing glass.

**VITREOUS**, *a.* [L. *vitreus*, from *vitrum*, glass or woad; W. *gwidydyr*, glass, a greenish blue colour.] 1. Pertaining to glass.—2. Consisting of glass; as, a *vitreous* substance.—3. Resembling glass; as, the *vitreous* humour of the eye, so called from its resembling melted glass. This humour occupies more than three-fourths of the interior of the eye, and is seated behind the crystalline lens. The rays of light which enter the eye undergo two refractions in passing through the aqueous humour and crystalline lens. On entering the vitreous humour they undergo a third refraction, thus acquiring their final degree of convergence, so that they form an image at a focus on the retina or very near it. *Vitreous electricity*, that produced by rubbing glass. [See ELECTRICITY.]

**VITREOUSNESS**, *n.* The quality or state of being vitreous; resemblance of glass.

**VITRES'ENCE**, *n.* [from L. *vitrum*, glass.] Glassiness, or the quality of being capable of conversion into glass; susceptibility of being formed into glass.

**VITRES'CENT**, *a.* Capable of being formed into glass; tending to become glass.

**VITRES'IBLE**, *a.* That can be vitrified.

**VITRIFICATION**, *n.* [See VITRIFY.] The act, process, or operation of converting into glass by heat; as, the *vitri-fication* of sand, flint, and pebbles with alkaline salts.

**VITRIFICATION**, *n.* The manufacture of glass, porcelain, and pottery.

**VITRIFIABLE**, *a.* [from *vitryfy*.] Capable of being converted into glass by heat and fusion. Flint and alkalis are *vitri-fiable*.—*Vitri-fiable colours*, metallic pigments, which become vitrified when laid on surfaces. Such are used in enamels, pottery, and stained glass.

**VITRIFICABLE**, † for *Vitri-fiable*.

**VITRIFICATE**, † for *Vitryfy*.

**VITRIFICATION**, for *Vitri-fication*. [See VITRIFICATION, which is generally used.]

**VITRIFIED**, *pp.* Converted into glass.—*Vitri-fied forts*, a name given to certain remarkable enclosures of stone existing in various parts of Scotland, especially in Inverness-shire. They are constructed of stones piled rudely upon one another, and firmly cemented together by some material which has been vitrified by fire, the stones themselves being also partially vitrified. They generally surround the top of some steep conical hill, and are supposed to have been intended for defensive military posts. Various hypotheses have been framed to account for the vitrified appearance of these structures, but it seems most reasonable to suppose that the material of which they are built was selected with a view to its capability of being vitrified; for the stones that have been most commonly used are granite or moorstone, limestone, sandstone, and pudding-stone, all of which are more or less easily fusible by fire, and the process of vitrification may have been rendered easy by the quantities of wood which in early times covered the Highlands.

**VITRIFORM**, *a.* [L. *vitrum*, glass, and *form*.] Having the form or resemblance of glass.

**VITRIFY**, *v. t.* [L. *vitrum*, glass, and *facio*, to make.] To convert into glass by fusion or the action of heat; as, to *vitri-fy* sand and alkaline salts.

**VITRIFY**, *v. i.* To become glass; to be converted into glass.

Chemists make vessels of animal substances calcined, which will not *vitri-fy* in the fire. *Arbutnot.*

**VITRIFYING**, *ppr.* Converting into glass.

**VITRINA**, *n.* A genus of fresh-water gastropods, having a thin shell.

**VITRIOL**, *n.* [Fr. *vitriol*; It. *vitriolo*; Sp. *vitriolo*; from L. *vitrum*, glass; from their crystalline form or their translucency.] The old chemical and still the vulgar name of sulphuric acid, and of many of its compounds, which, in certain states, have a glassy appearance.—*Green vitriol* is green sulphate of iron; *red vitriol*, or *vitriol of Mars*, is red sulphate of iron; *blue vitriol* is sulphate of copper; *white vitriol* is sulphate of zinc; *cobalt vitriol* is a sulphate of cobalt; *oil of vitriol* is sulphuric acid.

**VITRIOLATE**, *v. t.* To convert into a vitriol; as iron pyrites by the absorption of oxygen, which reduces the iron to an oxide, and the sulphur to sulphuric acid. Thus the sulphuret of iron when *vitriolated*, becomes sulphate of iron or green vitriol.

**VITRIOLATED**, *pp.* Converted into a sulphate or a vitriol.

**VITRIOLATING**, *ppr.* Turning into a sulphate or a vitriol.

**VITRIOLATION**, *n.* The act or process of converting into a sulphate or a vitriol.

**VITRIOLIC**, *a.* Pertaining to vitriol; having the qualities of vitriol, or obtained from vitriol.—*Vitriolic acid*, in *modern chem.*, is denominated *sulphuric acid*, the base of it being sulphur; one equivalent of sulphur combined with three equivalents of oxygen.

**VITRIOLIZABLE**, *a.* Capable of being converted into a vitriol.

**VITRIOLIZATION**. See VITRIOLATION.

**VITRIOLIZE**. See VITRIOLATE.

**VITRIOLIZED**. See VITRIOLATED.

**VITRIOLIZING**. See VITRIOLATING.

**VITRILOUS**, † *a.* Containing vitriol.

**VITRUVIAN SCROLL**. A name given



Vitruvian scroll.

to an architectural ornament formed of a series of scrolls joined together.

**VITTA**, *n.* [L.] A head-band, fillet, or garland.—2. The diadem of a medal.

—3. In *arch.*, ornament of a capital, frieze, &c.—4. In *bot.*, *vittæ* are the receptacles of oil which are found in the fruits of umbelliferous plants, as in those of anise, dill, fennel, caraway, &c. The same term is sometimes applied to the various stripes which are found upon leaves.

**VIT'TATE**, *a.* [from *vitta*.] In *bot.*, striped, as distinguished from *fasciate* or *banded*. Applied to leaves.

**VIT'ULINE**, *a.* [L. *vitulinus*.] Belonging to a calf, or to veal.

**VITUPERABLE**, † *a.* [See VITUPERATE.] Blameworthy; censurable.

**VITUPERATE**, *v. t.* [L. *vitupero*.] To blame; to censure.

**VITUPERATION**, *n.* [L. *vituperatio*.] Blame; censure.

**VITUPERATIVE**, *a.* Uttering or writing censure; containing censure.

The torrents of female eloquence, especially in the *vituperative* way, stem all opposition. *Chesterfield.*

**VITUPERATIVELY**, *adv.* With vituperation.

**VITUPERATOR**, *n.* A severe censor; a reviler.

**VITUPE'RIOUS**, † *a.* [L. *vituperium*.] Disgraceful.

**VIV'Á**, *inj.* [It.] An exclamation of applause or joy used in Italy, and similar in meaning to hurra or huza in English, and to vive in French; as, the king reached his palace amidst the *vivas* of the people.

**VIV'ACE**. [It.] In *music*, a term which denotes a brisk lively manner of performing.

**VIVA'CIOUS**, *a.* [L. *vivax*, from *vivo*, to live.] 1. Lively; active; sprightly in temper or conduct.—2. † Long lived.—3. Having vigorous powers of life; as, *vivacious* plants.

**VIVA'CIOUSLY**, *adv.* With vivacity, life, or spirit.

**VIVA'CIOUSNESS**, *n.* Activity; liveliness; sprightliness of temper or behaviour; vivacity.—2. † Power of living; also, long life.

**VIVAC'ITY**, *n.* [Fr. *vivacité*; L. *vivacitas*.] 1. Liveliness; sprightliness of temper or behaviour; as, a lady of great *vivacity*.—2. Air of life and activity; as, *vivacity* of countenance.—3. Life; animation; spirits; as, the *vivacity* of a discourse.—4. † Power of living.—5. † Longevity.

**VIV'ARY**, *n.* [L. *vivarium*, from *vivo*, to live.] A warren; a place for keeping living animals, as a pond, a park, &c.

**VIV'AT REGINA**. [L.] Long live the queen.

**VIV'AT RESPUBLICA**. [L.] Long live the republic.

**VIV'AT REX**. [L.] Long live the king.

**VIVA VOCE**. [L.] By word of mouth; as, to vote *viva voce*; to communicate with another person *viva voce*.

**VIVE**, † *a.* [Fr. *vif*; L. *vivus*.] Lively; forcible.

**VIVE**, (veev.) [Fr.] Long live; success to; as, *vive le roi*, long live the king;

*vive la bagatelle*, success to trifles or sport.

VIVELY, † *adv.* In a lively manner.

VIVENCY, † *n.* [L. *vivens*, from *vivo*.] Manner of supporting life or vegetation.

VIVER'RA, *n.* The civet; a genus of digitigrade and carnivorous mammalia, arranged by Cuvier between the dogs and hyenas. The *Viverra* of Linn. has been divided into six subgenera:—1. The Civets, properly so called, (*Viverra*); 2. The Genets, (*Genetta*); 3. The Paradoxure, (*Paradoxurus*); 4. The Mangoustes, (*Mangusta*); 5. The Suricattes, (*Ryzant*); 6. The Mangues, (*Crossarchus*). The true civets are characterized by a deep pouch situated between the anus and the sexual organs, divided into two bags, filled with an abundant concrete secretion of the consistence of pomadae, exhaling a strong musky odour, secreted by glands which surround the pouch. *V. civetta*, the common civet, inhabits Africa; *V. zibetha*, the zibet, inhabits the East Indies; and *V. rasse* is found in Java. The civets, in their carnivorous propensities, are next to the cats, which they approach very closely in many points of their zoological character, as well as in their predatory, nocturnal, and sanguinary habits.

VIVER'RIDĒ, *n.* The civet tribe, having for its type the genus *Viverra*.

VIVES, *n.* A disease of brute animals, particularly of horses, seated in the glands under the ear, where a tumour is formed which sometimes ends in suppuration.

VIV'ANITE, *n.* A phosphate of iron, of various shades of blue and green.

VIV'ID, *a.* [L. *vividus*, from *vivo*, to live.] 1. Bright; strong; exhibiting the appearance of life or freshness; as, the *vivid* colours of the rainbow; the *vivid* green of flourishing vegetables.

Arts which present, with all the *vivid* charms of painting, the human face and human form divine. *Sp. Hobart.*

2. Lively; sprightly; forming brilliant images, or painting in lively colours; as, a *vivid* imagination.

VIVID'ITY, *n.* Vividness.

VIV'IDLY, *adv.* With life; with strength.

Sensitive objects affect a man much more *vividly* than those which affect only his mind. *South.*

2. With brightness; in bright colours.—3. In glowing colours; with animated exhibition to the mind. The orator *vividly* represented the miseries of his client.

VIV'IDNESS, *n.* Life; strength; sprightliness.—2. Strength of colouring; brightness.

VIVIF'IC, } *a.* [L. *vivifico*; *vivus*, } See VIVIFICAL, } VIVIFY. } Giving life; reviving; enlivening.

VIVIF'ICATE, *v. t.* [L. *vivifico*; *vivus*, alive, and *facio*, to make.] 1. To give life to; to animate. [See VIVIFY.]—2. In *chem.*, to recover from such a change of form as seems to destroy the essential qualities; or to give to natural bodies new lustre, force, and vigour. [See REVIVE and REDUCE, the terms now used.]

VIVIF'ICATION, *n.* The act of giving life; revival.—2. Among *chemists*, the act of giving new lustre, force, and vigour; as, the *vivification* of mercury. [See REVIVIFICATION, which is more used.]

VIVIF'ICATIVE, *a.* Able to animate or give life.

VIV'IFIED, *pp.* Revived; endued with life.

VIVIFY, *v. t.* [Fr. *vivifier*; L. *vivifico*; *vivus*, alive, and *facio*, to make.] To endue with life; to animate; to make to be living.

Sitting on eggs doth *vivify*, not nourish. *Bacon.*

VIVIFYING, *ppr.* Enduing with life; communicating life to.

VIVIP'AROUS, *a.* [L. *vivus*, alive, and *pario*, to bear.] 1. Producing young in a living state, as all mammifers; as, distinguished from *oviparous*, producing eggs, as fowls.—2. In *bot.*, producing its offspring alive, either by bulbs instead of seeds, or by the seeds themselves germinating on the plant, instead of falling, as they usually do; as, a *vi-viparous* plant.

VIVISEC'TION, *n.* [L. *vivus* and *seco*.] The dissection of an animal while alive, for the purpose of making some physiological discovery.

VIX'EN, *n.* [*vixen* is a she fox, or a fox's cub.] A froward, turbulent, quarrelsome woman.

VIX'ENLY, *a.* Having the qualities of a vixen.

VIZ., a contraction of *videlicet*; to wit, that is, namely.

VIZ'ARD, *n.* A mask. [See VISOR.]

VIZ'ARD, † *v. t.* To mask.

VIZ'IER, } (*Veetzeer*). [Ar. from } *vizar*, } *vazara*, to bear, to sustain, to administer.] A title of honour and of office among the Turks, and various Oriental countries. Among the Turks, all the pachas of three tails; that is, the highest pachas, receive this title.

The councillors of state who sit in the divan, generally eight in number, are styled *viziers*, and the chief among them *vizier azem*, called by us grand vizier. He is the representative of the sultan, conducts the deliberations of the divan, and decides alone, being authorized to rule with absolute power in the name of the sultan.

VIZ'IERATE, *n.* The office of vizier.

VIZ'OR, *n.* That part of a helmet which defends the face, and which can be lifted up and put down at pleasure. [See VISOR.]

VO'CABLE, *n.* [L. *vocabulum*; It. *vocabolo*. See VOICE.] A word; a term; a name.

VOCAB'ULARY, *n.* [Fr. *vocabulaire*, from L. *vocabulum*, a word.] A list or collection of the words of a language, arranged in alphabetical order and explained; a word-book; the words of a science; a dictionary or lexicon. We often use *vocabulary* in a sense somewhat different from that of *dictionary*, restricting the signification to the list of words; as when we say, the *vocabulary* of Johnson is more full or extensive than that of Entick. We rarely use the word as synonymous with *dictionary*, but in other countries the corresponding word is so used, and this may be so used in English.

VOCAB'ULIST, *n.* The writer or framer of a dictionary; a lexicographer or linguist.

VO'CAL, *a.* [Fr. from L. *vocalis*. See VOICE.] 1. Having a voice. To hill or valley, fountain, or fresh shade, Made *vocal* by my song. *Milton.*

2. Pertaining to the voice or speech; uttered or modulated by the voice; as, *vocal* melody; *vocal* prayer; *vocal* praise; *vocal* sounds.—*Vocal music*, music produced by the human voice alone, or accompanied by instruments,

in distinction from instrumental music, which is produced by instruments alone; hence, music or tunes set to words, to be performed by the human voice.—*Vocal chords* or *ligaments*, in *anat.*, two ligaments which pass, one on each side, from the base of the arytaenoid cartilage, and are inserted into the thyroid cartilage. They are considered to be particularly connected with the formation of the voice.

VO'CAL, *n.* Among the Romanists, a man who has a right to vote in certain elections.

VO'CAL'IC, *a.* Consisting of the voice or vowel sounds.

VO'CALIST, *n.* A public singer distinguished by superior powers of voice.

VO'CAL'ITY, *n.* [L. *vocalitas*.] Quality of being utterable by the voice; as, the *vocality* of the letters.

VO'CALIZA'TION, *n.* Act of vocalizing.

VO'CALIZE, *v. t.* To form into voice; to make vocal.

It is one thing to give impulse to breath alone, and another to *vocalize* that breath. *Hobler.*

VO'CALIZED, *pp.* Made vocal; formed into voice.

VO'CALIZING, *ppr.* Forming into voice or sound.

VO'CALLY, *adv.* With voice; with an audible sound.—2. In words; as, to express desires *vocally*.

VO'GALNESS, *n.* The quality of being vocal.

VOC'A'TION, *n.* [Fr. from L. *vocatio*, from *voco*, to call. See VOICE.] 1. Among *divines*, a calling by the will of God; or the bestowment of God's distinguishing grace upon a person or nation, by which that person or nation is put in the way of salvation; as, the *vocation* of the Jews under the old dispensation, and of the Gentiles under the gospel.—2. Summons; call; inducement.

What can be urged for them who, not having the *vocation* of poverty to scribble, out of mere wantonness make themselves ridiculous. *Dryden.*

3. Designation or destination to a particular state or profession.

None is to enter the ecclesiastic or monastic state, without a particular *vocation*. *Cyc.*

4. Employment; calling; occupation; trade; a word that includes professions as well as mechanical occupations. Let every *divine*, every *physician*, every *lawyer*, and every *mechanic* be faithful and diligent in his *vocation*.

VO'C'ATIVE, *a.* [Fr. *vocatif*; L. *vocativus*.] Relating to calling; as, the *vocative* case in grammar.

VO'C'ATIVE, *n.* In *gram.*, the fifth case or state of nouns in the Latin language; or the case in any language in which a word is placed when the person is addressed; as, *Domine*, O Lord.

VOCIF'ERATE, *v. i.* [L. *vocifer*; *vox* and *fero*.] To cry out with vehemence; to exclaim.

VOCIF'ERATE, *v. t.* To utter with a loud voice.

VOCIF'ERATING, *ppr.* Crying out with vehemence; uttering with a loud voice.

VOCIFERA'TION, *n.* A violent outcry; vehement utterance of the voice.

VOCIF'EROUS, *a.* Making a loud outcry; clamorous; noisy; as, *vociferous* heralds.

VOCIF'EROUSLY, *adv.* With great noise in calling, shouting, &c.

**VOICIF'EROUNESS**, *n.* Clamoroussness.  
**VOE**, *n.* An inlet, bay, or creek. [*Scotch.*]  
**VOGUE**, *n.* (*vög*.) [*Fr. vogue*, a rowing; *It. voga*, a rowing, mode, fashion; *ro. vögare*, to row; *Sp. voga; vogar*, to row. See **WAG** and **WAV**. The sense of *vogue* is way, or the *going* of the world.] The way or fashion of people at any particular time; temporary mode, custom, or practice; popular reception for the time. We say, a particular form of dress is now in *vogue*; an amusing writer is now in *vogue*; such opinions are now in *vogue*. The phrase, the *vogue of the world*, used by good writers formerly, is nearly or quite obsolete. Use may revive the obsoletest word. And banish those that now are most in *vogue*.  
*Roccommon.*

**VOICE**, *n.* [*Fr. voix*; *L. vox*; *It. voce*; *Sp. voz*; *Gaelic, bagh*, a word; *baigh-ham*, to speak to; *Ir. focal*, a word; *Sans. vach*, to speak, *L. voco*. The sense of the verb is to throw, to drive out sound; and *voice* is that which is driven out.] 1. An audible sound or noise produced in the throat and mouth of an animal by peculiar organs. Voices are either *articulate* or *inarticulate*. Articulate voices are those of which several conspire together to form some assemblage or little system of sounds; such are the voices expressing the letters of an alphabet, numbers of which joined together form words. Inarticulate voices are such as are not organized or assembled into words; as, the barking of dogs, the braying of asses, the hissing of serpents, the singing of birds, &c. We say, the *voice* of a man is loud or clear; the *voice* of a woman is soft or musical; the *voice* of a dog is loud or harsh; the *voice* of a bird is sweet or melodious. The *voice* of human beings is articulate; that of beasts, inarticulate. The *voices* of men are different, and when uttered together, are often dissonant. Mammals, birds, and reptiles are the only animals which possess a voice. In mammals, the air driven by the muscles of expiration from the lungs through the trachea, strikes against the two vibratile vocal chords, which bound the sides of the glottis, and thus a voice is produced varying in different animals according to the structure of the organs, and the power which the animal possesses over them. In man, the superior organization and mobility of the tongue and lips, enable him to modify his vocal sounds so as to render them articulate, and adapted to express his ideas. The infinite varieties of sounds heard in the human voice, are all embraced under the general terms, *pitch*, *loudness*, *quality*, and *duration*. A good musical voice depends chiefly upon the soundness and power of the organs of utterance and of hearing, and the musical disposition, and is distinguished by clearness of intonation, ease, strength, duration, equality, harmoniousness and fullness of the sounds.—2. Any sound made by the breath; as, the trumpet's *voice*.—3. A vote; suffrage; opinion or choice expressed. Originally *voice* was the oral utterance of choice, but it now signifies any vote, however given. Some laws ordain, and some attend the choice  
Of holy senates, and elect by *voice*. *Dryden*.  
I have no words;  
My *voice* is in my sword. *Shak.*

4. Language; words; expression. Let us call on God in the *voice* of his church. *Fell*.  
5. In *scrip.*, command; precept. Ye would not be obedient to the *voice* of the Lord your God; *Deut. viii*.  
6. Sound. After the fire, a still small *voice*; 1 Kings xix.  
Canst thou thunder with a *voice* like him? *Job xl*.  
The floods have lifted up their *voice*; *Ps. xciii*.  
7. Language; tone; mode of expression. I desire to be present with you now, and to change my *voice*; *Gal. iv*.  
8. In *gram.*, a particular mode of inflecting or conjugating verbs; as, the active *voice*; the passive *voice*.—9. In *music*, the name given to a part assigned to a human voice or an instrument in a composition, as treble, tenor, and bass *voices*.  
**VOICE**, *v. t.* To rumour; to report; to vote.  
It was *voiced* that the king purposed to put to death Edward Plantagenet. [*Little used.*] *Shak.*  
2. To fit for producing the proper sounds; to regulate the tone of; as, to *voice* the pipes of an organ.—3. To vote.  
**VOICE**, *v. i.* To clamour; to exclaim.  
**VOICED**, *pp.* Fitted to produce the proper tones.—2. *a.* Furnished with a voice.  
**VOICELESS**, *a.* (*vois'less*.) Having no voice or vote.  
**VOIC'ING**, *n.* The act of giving to an organ—pipe its proper quality of tone.  
**VOIC'ING**, *ppr.* Fitting the pipe of an organ for producing its proper quality of tone.  
**VOID**, *a.* [*Fr. vuide*; *It. voto*; *L. viduus*; *Sw. öde*; *G. and Dan. öde*, waste, which seems to be the Eng. *void*; so *waste* and *vast* are from one root. It coincides with *Gr. ödös*, and the root of *L. divido*, *Ar. badda*, to separate.] 1. Empty; vacant; not occupied with any visible matter; as, a *void* space or place; 1 Kings xxii.—2. Empty; without inhabitants or furniture; *Gen. i.*—3. Having no legal or binding force; null; not effectual to bind parties, or to convey or support a right; not sufficient to produce its effect. Thus a deed not duly signed and sealed, is *void*. A fraudulent contract is *void*, or may be rendered *void*.  
My word shall not return to me *void*, but it shall accomplish that which I please; *Is. lv*.  
I will make *void* the counsel of Judah and Jerusalem in this place; *Jer. xix*.  
4. Free; clear; as, a conscience *void* of offence; *Acts xxiv*.—5. Destitute; as, *void* of learning; *void* of reason or common sense.  
He that is *void* of wisdom, despiseth his neighbour; *Prov. xi*.  
6. Unsupplied; vacant; unoccupied; having no incumbent.  
Divers offices that had been long *void*.  
*Camden*.  
7. Unsubstantial; vain.  
Lifeless idol, *void* and vain. *Pope*.  
*Void* space, in physics, a vacuum.—To make *void*, to violate; to transgress.  
They have made *void* thy law; *Ps. cxix*.  
2. To render useless or of no effect; *Rom. iv*.  
**VOID**, *n.* An empty space; a vacuum. Pride, where wit fails, steps in to our defence,  
And fills up all the mighty *void* of sense.  
*Pope*.  
Th' illimitable *void*. *Thomson*.

**VOID**, *v. t.* To quit; to leave.  
Bid them come down,  
Or *void* the field. *Shak*.  
2. To emit; to send out; to evacuate; as, to *void* excrementitious matter; to *void* worms.—3. To vacate; to annul; to nullify; to render of no validity or effect.  
It had become a practice...to *void* the security given for money borrowed.  
*Clarendon*.

4. To make or leave vacant.  
**VOID**, *v. i.* To be emitted or evacuated.  
**VOID'ABLE**, *a.* That may be annulled or made void, or that may be adjudged void, invalid, or of no force.  
Such administration is not void, but *voidable* by sentence. *Ayliffe*.

2. That may be evacuated.  
**VOID'ANCE**, *n.* The act of emptying.—2. The act of ejecting from a benefice; ejection.—3. Vacancy; want of an incumbent.—4. Evasion; subterfuge.  
**VOID'ED**, *pp.* Thrust out; evacuated.



Azure a saltire Voided argent.

—2. *a.* In *her.*, an ordinary is said to be *voided* when it is pierced through, or the inner part cut away, so that the field appears, and nothing remains of the charge but its outer edges, as in the cut, azure a saltire argent *voided*.

**VOID'ER**, *n.* A basket in which broken meat is carried from the table.—2. One who evacuates.—3. One who nullifies.—4. In *her.*, one of the ordinaries, whose figure is much like that of the flanch or flasque, but is not quite so circular towards the centre of the field. The term, however, is little used.—5. In *agriculture*, a provincial name of a kind of shallow basket of open work.

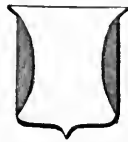

Argent two Voiders gules.

**VOID'ING**, *ppr.* Ejecting; evacuating.—2. Making or declaring void, or of no force.—3. Quitting; leaving.—4. *a.* Receiving what is ejected; as, a *voiding* lobby.

**VOID'NESS**, *n.* Emptiness; vacuity; destitution.—2. Nullity; inefficacy; want of binding force.—3. Want of substantiality.

**VOIRE DIRE**. (*vwär dër*.) [*Norm. Fr. q. d. vrai dire*; *L. veritatem dicere*.] In *law*, an oath administered to a person intended as a witness, requiring him to make true answers to questions. It is often administered to such as are supposed to be interested, or to have formed opinions to bias the mind.

**VOITURE**, *n.* [*Fr. id.*; *It. vettura*, from *L. vectus, veho*.] Carriage. [*Not English.*]  
**VOLA'CIOUS**, *a.* [*L. volo*.] Apt or fit to fly.

**VOLAL'KALI**, *n.* Volatile alkali; by contraction.



Volant.

**VO'LANT**, *a.* [*Fr. flying*, from *voler*, *Lat. volo*, to fly.]  
1. Flying; passing through the air; as, *volant* automata.—  
2. Nimble; active; as, *volant* touch.—  
3. In *her.*, represented as flying or having the wings spread.

**VOL'ARY**, † *n.* [Fr. *volière*.] A bird-cage large enough for birds to fly in.  
**VOL'ATILE**, *a.* [Fr. from *L. volatilis*, from *volo*, to fly.] 1. Flying; passing through the air on wings, or by the buoyant force of the atmosphere.—2. Having the power to fly; as, birds are *volatile* animals.—3. Capable of wasting away, or of easily passing into the aeriform state. Thus substances which affect the smell with pungent or fragrant odours, as musk, hartshorn, and essential oils, are called *volatile* substances, because they waste away on exposure to the atmosphere. Alcohol and ether are called *volatile* liquids for a similar reason, and because they easily pass into the state of vapour on the application of heat. On the contrary, gold is a *fixed* substance, because it does not suffer waste, even when exposed to the heat of a furnace; and oils are called *fixed*, when they do not evaporate on simple exposure to the atmosphere. [See **OIL**].—4. Lively; gay; full of spirit; airy; hence, fickle; apt to change; as, a *volatile* temper.  
 You are as giddy and *volatile* as ever.

*Swift.*

**VOL'ATILE**, † *n.* A winged animal.  
**VOL'ATILE ALKALI**. An old name of ammonia.

**VOL'ATILENESS**, } *n.* [Fr. *volatilité*.]  
**VOLATILITY**, } 1. Disposition to exhale or evaporate; the quality of being capable of evaporation; that property of a substance which disposes it to rise and float in the air, and thus to be dissipated; as, the *volatility* of fluids. Ether is remarkable for its *volatility*. Many or most solid bodies are susceptible of *volatility* by the action of intense heat.

By the spirit of a plant we understand that pure elaborated oil, which, by reason of its extreme *volatility*, exhales spontaneously, and in which the odour or smell consists. *Arbuthnot.*

2. Great sprightliness; levity; liveliness; whence, mutability of mind; fickleness; as, the *volatility* of youth.

**VOL'ATILIZABLE**, *a.* That may be volatilized.

**VOLATILIZATION**, *n.* [from *volatilize*.] The act or process of rendering volatile, or rather of causing to rise and float in the air.

**VOL'ATILIZE**, *v. t.* [Fr. *volatiliser*.] To render volatile; to cause to exhale or evaporate; to cause to pass off in vapour or invisible effluvia, and to rise and float in the air.

The water... dissolving the oil, and *volatilizing* it by the action. *Newton.*

**VOL'ATILIZED**, *pp.* Rendered volatile; caused to rise and float in the air.

**VOL'ATILIZING**, *pp.* Rendering volatile; causing to rise and float in the air.

**VOLCANIC**, *a.* [from *volcano*.] Pertaining to volcanoes; as, *volcanic* heat.—2. Produced by a volcano; as, *volcanic* tufa.—*Volcanic products* are numerous and diversified, but lava, scoria, enamel, and glass, comprise by far the most important and interesting of them. The substances thrown out during volcanic eruptions, whether stony, liquid, or gaseous, disclose more or less completely the nature and condition of the interior masses of the globe. In the lava, or melted rock, the most important ingredients are felspar, angite, and oxide of iron, the mass being modified by various additional minerals and me-

tallic substances. The same substances compose the ashes of scoria. The liquid products of volcanoes, besides abundance of water, contain sometimes sulphuric and muriatic acids. Sublimations of common salt, and muriate of ammonia, are also found among these products. Among the gaseous products, chlorine, azote, sulphuretted hydrogen, sulphurous acid, and carbonic acid are the most common.—*Volcanic rocks*, rocks which have been formed by volcanic agency, as *trachyte*, *pumice*, *obsidian*, *angitic*, or *felspathic rocks*, &c.—*Volcanic bombs*, the name given to detached masses of melted lava, sometimes thrown out by volcanoes, which masses, as they fall, assume rounded forms, like bomb-shells, and are often elongated into a pear shape.—*Volcanic foci*, the subterranean centres of action in volcanoes, where the heat is supposed to be in the highest degree of energy.—3. Changed or affected by the heat of a volcano.

**VOLCANICITY**, *n.* State of being volcanic; volcanic power.

**VOL'CANIST**, *n.* [from *volcano*.] One versed in the history and phenomena of volcanoes.—2. One who believes in the effects of eruptions of fire in the formation of mountains; otherwise termed a *vulcanist*.

**VOL'CANITE**, *n.* A mineral, otherwise called angite.

**VOLCANITY**, *n.* The state of being volcanic, or of volcanic origin.

**VOLCANIZATION**, *n.* [from *volcanize*.] The process of undergoing volcanic heat, and being affected by it.

**VOL'CANIZE**, *v. t.* To subject to or cause to undergo volcanic heat, and to be affected by its action.

**VOL'CANIZED**, *pp.* Affected by volcanic heat.

**VOL'CANO**, *n.* [It. from *Vulcan*.] 1. In *geol.*, an opening in the surface of the earth or frequently in a mountain, from which smoke, flames, stones, lava, or other substances are ejected. Such are seen in Etna and Vesuvius in Sicily and Italy, and Hecla in Iceland. It is vulgarly called a *burning mountain*, a name quite inapplicable, as many volcanoes are not in mountains, and some are submarine, ejecting their contents from under the sea. The eruptions from volcanoes are in general only temporary, a cessation, sometimes extending to centuries, intervening between the explosions; although, in other cases, a slow action is constantly going on with periods of increased energy, at intervals of months or years.

*Volcanoes* are called *active*, when they continue to eject melted matter, mud, or vapours at intervals; and *extinct*, when they have ceased to emit such matters within the records of history. According to Jameson, about 193 active volcanoes have been observed; of which 13 belong to Europe and its islands, 66 to Asia and its islands, 8 to the islands of Africa, and 106 to America and its islands. Volcanoes usually form series of immense extent, frequently running in right lines although widely separated from each other. Volcanic eruptions are preceded by earthquakes, and earthquakes and volcanoes may be considered as different effects produced by the agency of internal heat, arising from chemical processes going on in the bowels of the earth.—2. The mountain that ejects fire, smoke, &c.

**VOLE**, *n.* [Fr. from *voler*, to fly.] A deal at cards that draws all the tricks.

**VOLE**, *v. i.* To win all the tricks at cards.

**VOLEE**, *n.* (*volé*.) [Fr. a flying.] A rapid flight of notes in music.

**VO'LENS NO'LENS**, *a.* [L.] Willing or not willing.

**VO'LERY**, *n.* [Fr. *volière*, from *voler*, to fly.] 1. A flight of birds.—2. A large bird-cage, in which the birds have room to fly. Also written *volary*.

**VOLITA'TION**, † *n.* [L. *volitio*, dim. of *volo*, to fly.] The act of flying; flight.  
**VOLI'TION**, *n.* [L. *volitio*, from *volo*, to will. See **WILL**.] 1. The act of willing; the act of determining choice, or forming a purpose. There is a great difference between actual *volition*, and the approbation of judgment.

*Volition* is the actual exercise of the power which the mind has of considering or forbearing to consider an idea. *Locke.*

2. The power of willing or determining.  
**VOL'TIVE**, *a.* Having the power to will.

They not only perfect the intellectual faculty, but the *volative*. *Hale.*

**VOLKAMERIA**, *n.* A genus of plants; nat. order Verbenacæ. There is only one species, *V. aculeata*, a native of the West Indies, and one of the most common plants in the low lands of Jamaica in dry gravelly soil. It grows to the height of five or six feet; the leaves are oblong, acute, with spines from the rudiments of the petioles; and the flowers come out from the side of the stalk, five or six on the same peduncle.

**VOL'LEY**, *n.* [Fr. *volée*, a flight, from *voler*, to fly, L. *volo*.] 1. A flight of shot; the discharge of many small arms at once.—2. A burst or emission of many things at once; as, a *volley* of words.

But rattling nonsense in full *colleys* breaks. *Pope.*

**VOL'LEY**, *v. t.* To discharge with a volley.

**VOL'LEY**, *v. i.* To throw out or discharge at once.

**VOL'LEYED**, } *a.* [from *volley*.] Dis-  
**VOL'LIED**, } ploded; discharged with a sudden burst; as, *volleyed* thunder.

**VOLT**, *n.* [Fr. *volte*, a ring; It. *volta*, a turn; from L. *volutus*, *volvo*.] 1. A round or circular tread; a gait of two treads, made by a horse going sideways round a centre.—2. In *fencing*, a sudden movement or leap to avoid a thrust.

**VOL'TA**, in *Italian music*, signifies that the part is to be repeated one, two, or more times.

**VOL'TA-ELECTRIC**, *a.* Pertaining to voltaic electricity or galvanism; as, *volta-electric* induction. [See **INDUCTION**.]

**VOLTA'IC**, *a.* Pertaining to Volta, the discoverer of voltaism; as, the *voltaic* pile. *Voltaic electricity*, that branch of electricity to which the name of *galvanism* is generally applied, the phenomena connected with it being produced by the *voltaic* or *galvanic battery*. *Voltaic apparatus*, the apparatus used for accumulating galvanic electricity. The agent itself is denominated *galvanism*, after its discoverer, Galvani, while the instruments used for exciting and accumulating it are called *voltaic*, in honour of Volta, who first contrived this kind of apparatus. [See **GALVANIC**, **GALVANISM**.]—*Voltaic pile*, a column formed by successive pairs of

plates of two dissimilar metals, as zinc and copper, alternating with moistened flannel or pasteboard, in regular order of succession. The more negative the two metals are to each other, as zinc and silver, zinc and platinum, the more active the series.—*Voltaic battery*, the larger forms of voltaic apparatus, used for accumulating galvanic electricity.

**VOL'TAISM**, *n.* [from *Volta*, an Italian.] That branch of electrical science which has its source in the chemical action between metals and different liquids. It is so named from the Italian philosopher, Volta, whose experiments contributed greatly to the establishment of this branch of science. It is, however, more usually called *galvanism*, from Galvani, who first showed or brought into notice the remarkable influence produced on animals by this species of electricity.

**VOLTA'METER**, *n.* [*Volta*, and *Gr. μέτρον*, measure.] An instrument contrived by Faraday, for measuring the amount of voltaic electricity passing in a current through it, by means of the quantity of water decomposed in a given time. In principle, it consists of a graduated tube, *c*, closed at one end, and inserted through a wooden cap into a jar, *d*, through the bottom of which the platina electrodes, *f*, connected with the two poles of the battery, *a* and *b*, are introduced.

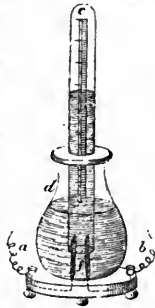

To determine the amount of any voltaic current passing through it, the tube, *c*, is taken out and filled with dilute sulphuric acid and water, then turned down into the solution in the jar, *d*, care being taken that in so doing no air is admitted into the top, and that the two platina electrodes are introduced under the mouth of the tube. The number of cubic inches of the mixed gases evolved by the current over a given time, may be read off on the scale by the depression of the fluid in the tube. This instrument is also frequently used to exhibit the analysis of water, the two gases, oxygen and hydrogen, being evolved, one at the positive and the other at the negative electrode. For this purpose the instrument is then furnished with two separate tubes, one over each electrode, to collect the respective gases. In the use of these instruments, all contact of the electrodes with each other must be carefully avoided.

**VOL'TAPLAST**, *n.* A kind of voltaic battery used in electrotyping.

**VOL'TATYPE**. The same as **ELECTROTYPE**,—*which see*.

**VOL'TI**. In *music*, a direction to turn over the leaf.

**VOL'TIGEUR**, *n.* [Fr. *voltiger*, to leap.] A foot-soldier in a select company of every regiment of French infantry. *Voltigeurs* were established by Napoleon during his consulate. Their duties, exercises, and equipment, are similar to those of our light companies.—2. In the *U. States*, a light horseman.

**VOL'TI SU'BITO**, a term directing that the leaf is to be turned over quickly.

**VOLT'ZITE**, *n.* An ore of zinc, which is an oxisulphuret of that metal. It occurs in the form of small hemispheres, divisible into thin layers. It is found in Cornwall.

**VOL'UBILATE**, } *a.* In gardening, a VOL'UBILE, } volubilate stem is one that climbs by winding or twining round another body.

**VOLUBIL'ITY**, *n.* [Fr. *volubilité*; *L. volubilitas*, from *volvo*, to roll.] 1. The capacity of being rolled; aptness to roll; as, the *volubility* of a bowl.—2. The act of rolling.

By irregular *volubility*. *Hooker*.  
3. Ready motion of the tongue in speaking; fluency of speech.

She ran over the catalogue of diversions with such a *volubility* of tongue, as drew a gentle reprimand from her father. *Female Quixote*.

4. Mutability; lability to revolution; as, the *volubility* of human affairs. [*Unusual*.]

**VOL'UBLE**, *a.* [*L. volubilis*.] 1. Formed so as to roll with ease, or to be easily set in motion; apt to roll; as, *voluble* particles of matter.—2. Rolling; having quick motion.

This less *voluble* earth. *Milton*.  
3. Nimble; active; moving with ease and smoothness in uttering words; fluent; as, a flippancy, *voluble* tongue.

—4. Fluent; flowing with ease and smoothness; as, a *voluble* speech.—5. Having fluency of speech.

Cassio, a knave very *voluble*. *Shak*.

**VOL'UBLENESS**, *n.* Quality of being voluble.

**VOL'UBLY**, *adv.* In a rolling or fluent manner.

**VOL'UME**, *n.* [Fr. from *L. volumen*, a roll; *volvo*, to roll. To make *u* long, in this word, is palpably wrong.] 1. Primarily, something rolled or convolved; a roll, as the ancients wrote on long strips of bark, parchment, or other material, which they formed into rolls or folds. Of such volumes, Ptolemy's library in Alexandria is said to have contained 700,000.—2. A roll or turn; as much as is included in a roll or coil; as, the *volume* of a serpent.—3. Dimensions; compass; space occupied; bulk, size, or solid content; as, the *volume* of an elephant's body; the *volume* of a sphere; the *volume* of a cylinder; a *volume* of gas. In *chem.*, the size or bulk of an atom of any gaseous body is termed its *atomic volume*. It is not meant, however, that we can ascertain the absolute volume of the atoms, but the relative or comparative volume of the atoms or particles of two or more gases. It is generally admitted that equal volumes or bulks of different elementary gases contain different numbers of atoms, and hence the atoms must be of different sizes: Thus, the atoms of oxygen gas are  $\frac{1}{2}$  the size, and those of sulphur  $\frac{1}{8}$  the size of the atoms of hydrogen, nitrogen, chlorine, &c. To obtain the relative atomic volume of any gas, the atomic weight is divided by the specific gravity. Thus, the atomic weight of oxygen = 8, divided by its specific gravity 16, (that of hydrogen being 1,) gives the quotient  $\frac{1}{2}$  for the atomic volume of oxygen. When two gaseous bodies combine together, it is always in such proportions by volume, that one volume of the one gas combines with one, two, or more volumes of the other, and thus the composition of gaseous bodies may be expressed by volume as well as by

weight. The theory of volumes has recently been extended to solids and liquids.—4. A swelling or spherical body.

The undulating billows rolling their silver volumes. *Irving*.

5. A book; a collection of sheets of paper, usually printed or written paper, folded and bound, or covered. A book consisting of sheets once folded, is called a folio, or a folio volume; of sheets twice folded, a quarto; and thus, according to the number of leaves in a sheet, it is called an octavo, or a duodecimo. The Scriptures or sacred writings, bound in a single volume, are called the Bible.

An odd volume of a set of books, bears not the value of its proportion to the set. *Franklin*.

6. In *music*, the compass of a voice from grave to acute; the tone or power of voice.

**VOL'UMED**, *a.* Having the form of a volume or roll; as, *volumed* mist.

**VOL'UMINOUS**, *a.* Consisting of many coils or complications.

The serpent roll'd *voluminous* and vast. *Milton*.

2. Consisting of many volumes or books. The collections of Muritori and of the Byzantine history, are very *voluminous*.

—3. Having written much, or made many volumes; as, a *voluminous* writer.

4. Copious; diffusive. He was too *voluminous* in discourse.

**VOL'UMINOUSLY**, *adv.* In many volumes; very copiously.

**VOL'UMINOUSNESS**, *n.* State of being bulky or in many volumes.

**VOL'UMIST**, *n.* One who writes a volume; an author.

**VOL'UNTARIES**, *n.* [from *voluntary*.]

A general name given to those dissenters who are opposed to all connection between church and state, and all endowments for the support of the clergy, secured or allotted to them by the law of the land. They maintain that every pastor of a congregation ought to be chosen by the free-will and consent of the members, and supported by their free-will contributions.

**VOL'UNTARILY**, *adv.* [from *voluntary*] Spontaneously; of one's own will; without being moved, influenced, or impelled by others.

To be agents *voluntarily* in our own destruction, is against God and nature.

*Hooker*.  
**VOL'UNTARINESS**, *n.* The state of being voluntary or optional.

**VOL'UNTARY**, *a.* [Fr. *volontaire*; *L. voluntarius*, from *voluntas*, will, from *volvo*. *Voluntary* is applicable only to beings that have will; *spontaneous* is applicable to *physical causes*, as well as to the will of an agent.] 1. Acting by choice or spontaneously; acting without being influenced or impelled by another.—2. Free, or having power to act by choice; not being under restraint; as, man is a *voluntary* agent.—3. Proceeding from choice or free will.

That sin or guilt pertains exclusively to *voluntary* action, is the true principle of orthodoxy. *N. W. Taylor*.

4. Willing; acting with willingness.

She fell to lust a *voluntary* prey. *Pope*.

5. Done by design; purposed; intended. If a man kills another by lopping a tree, here is a *voluntary* murder.

—6. Done freely, or of choice; proceeding from free will. He went into *voluntary* exile. He made a *voluntary* exile.

surrender.—7. Acting of his own accord; spontaneous; as, the *voluntary* dictates of knowledge.—8. Subject to the will; as, the *voluntary* motions of an animal. Thus the motion of a leg or an arm is *voluntary*, but the motion of the heart is *involuntary*. Those muscles which are thrown into action, in obedience to the will, are called *voluntary muscles*, in opposition to the *involuntary muscles*, or those which act independently of the will.—9. Pertaining to the voluntaries; as, the *voluntary* system; the *voluntary* principle. A *voluntary escape*, in law, is the escape of a prisoner by the express consent of the sheriff.—*Voluntary jurisdiction*, is that which is exercised in doing that which no one opposes; as, in granting dispensations, &c.—*Voluntary jurisdiction*, in *Scots law*, is that jurisdiction which is exercised in matters admitting of no opposition or question, and therefore cognizable by any judge, in any place, or on any lawful day; such as the judicial ratification of a married woman, briefs of tutory, general service, &c.—*Voluntary affidavit* or *oath*, is one made in an extra-judicial matter.—*Voluntary waste* is that which is committed by positive acts.

**VOLUNTARY, n.** One who engages in any affair of his own free will; a volunteer. [In this sense, *volunteer* is now generally used.]—2. In *music*, a piece played by a musician extemporarily, according to his fancy. In the *Philosophical Transactions*, we have a method of writing *voluntaries*, as fast as the musician plays the notes. This is by a cylinder turning under the keys of the organ.—3. A composition for the organ.

**VOLUNTARISM, n.** Voluntary principle or action.—2. The system of supporting any thing by voluntary contribution or assistance.—3. The opinions or principles of the voluntaries.

**VOLUNTEER, n.** [Fr. *volontaire*.] A person who enters into military or other service of his own free will. In *military affairs*, volunteers enter into service voluntarily, but when in service they are subject to discipline and regulations like other soldiers. They sometimes serve gratuitously, but often receive a compensation.

**VOLUNTEER, a** Entering into service of free will; as, *volunteer* companies.

**VOLUNTEER, v. t.** To offer or bestow voluntarily, or without solicitation or compulsion; as, to *volunteer* one's services.

**VOLUNTEER, v. i.** To enter into any service of one's free will, without solicitation or compulsion. He *volunteered* in that undertaking. [*These verbs are in respectable use.*]

**VOLUP'TUARY, n.** [L. *voluptarius*, from *voluptas*, pleasure.] A man addicted to luxury or the gratification of the appetite, and to other sensual pleasures.

**VOLUP'TUOUS, a.** [Fr. *voluptueux*; L. *voluptuosus*.] Given to the enjoyments of luxury and pleasure; indulging to excess in sensual gratifications.

Softened with pleasure and *voluptuous* life.  
Milton.

**VOLUP'TUOUSLY, adv.** Luxuriously; with free indulgence of sensual pleasures; as, to live *voluptuously*.

**VOLUP'TUOUSNESS, n.** Luxuriousness; addictedness to pleasure or sensual gratification.

Where no *voluptuousness*, yet all delight.

Donne.

**VOLUTA, n.** [Lat. a wreath.] A genus of testaceous gastropodous molluscs, including those which have a univalve spiral shell, with an aperture destitute of a beak, and somewhat effuse, and a columella twisted or plaited, generally without lips or perforation. The species are principally found in tropical seas, and from the numbers and carnivorous habits of these animals, they serve as powerful agents in keeping other mollusca and conchifera within due limits. Their shells are prized by collectors above most others for their beauty and rarity. The Linnaean genus *voluta*, comprehended numerous species, but later naturalists have distributed them into the following subgenera: *oliva*, *volvaria*, *voluta* proper, *marginella*, *mitra*, and *cancellaria*.

**VOLUTA'TION, n.** [L. *volutatio*, from *voluto*, from *volvo*, Eng. to *wallow*.] A wallowing; a rolling of the body on the earth. [See *WALLOW*.]

**VOLUTE, n.** [Fr. *volute*; It. *voluta*; from L. *volutus*, *volvo*.] 1. In *arch.*, a kind of spiral scroll, used in the Ionic and Composite capitals, of which it is a principal ornament. The number of *volute*s in the Ionic order is four; in

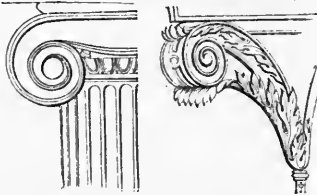

Volute of the Ionic and Corinthian Capitals.

the Composite, eight. There are also eight angular volutes in the Corinthian capital, accompanied with eight smaller ones, called *helices*.—2. A genus of testaceous gastropodous molluscs. [See *VOLUTA*.]

**VOLUTED, a.** Having a volute, or spiral scroll.

**VOLUTIDÆ, n.** A family of testaceous gastropodous molluscs, of which the genus *voluta* is the type. This family comprises numerous species both recent and fossil, and may be regarded as one of the most interesting and beautiful families of the spiral *Testacea*, whether in regard to the elegance of the shells themselves, or as exhibiting a principle of variation in their structure, hardly to be excelled. The music-shells, mitre-shells, and date-shells are examples.

**VOLUTION, n.** A spiral turn or wreath. The wreaths or turnings of the shells of univalves are termed *volutions*.

**VOLUTITE, † n.** A petrified shell of the genus *Voluta*.

**VOLVA, n.** [L.] In *bot.*, the wrapper or involucre-like base of the stem of certain fungi, as *Agaricus volvaceus*. It is the remnants of a bag that enveloped the whole plant in its earlier stages, and was left at the foot of the stem when the plant elongated and burst through it.

**VOLVARIA, n.** A genus of testaceous gastropodous molluscs, belonging to the family *Volutidæ*. The polish and

whiteness of the shells, cause them to be employed as necklaces on some coasts.

**VOLVIC, a.** Denoting a species of stone or lava.

**VOLVOX, n.** [L. from *volvo*, to roll.] A genus of globular animalcules. To the presence of one species, *V. globator*, and to its great abundance, stagnant waters owe their green colour.

**VOMER, n.** [L. a ploughshare.] In *anat.*, the slender thin bone which separates the nostrils from each other.

**VOM'IC, a.** The *vomic* nut, *nux vomica*, is the seed of the *Strychnos nux vomica*, a native of the East Indies. It is a very valuable medicine.

**VOM'ICA, n.** [L.] An abscess of the lungs.

**VOM'IC-NUT, n.** [L. *vomica*, emetic, and *nux*, a nut.] The seed of the *Strychnos nux vomica*, a medium sized tree growing in various parts of India. [See *NUX VOMICA* and *STRYCHNOS*.]

**VOMIT, v. i.** [L. *vomo*; Fr. *vomir*; It. *vomire*; Sans. *vamathu*.] Probably the Gr. *vomē* is the same word, with the loss of its first letter.] To eject the contents of the stomach by the mouth. Some animals *vomit* with ease, as cats and dogs; but horses do not *vomit*.

**VOMIT, v. t.** To throw up or eject from the stomach; to discharge from the stomach through the mouth. It is followed often by *up* or *out*, but without necessity and to the injury of the language. In the yellow fever, the patients often *vomit* dark coloured matter like coffee grounds.

The fish *vomited* out Jonah upon the dry land; Jonah ii.

2. To eject with violence from any hollow place. Volcanoes *vomit* flames, ashes, stones, and liquid lava.

**VOMIT, n.** The matter ejected from the stomach.—2. That which excites the stomach to discharge its contents; an emetic.—*Black vomit*, the dark coloured matter ejected from the stomach in the last stage of the yellow fever or other malignant disease.

**VOMITED, pp.** Ejected from the stomach through the mouth, or from any deep place through an opening.

**VOMITING, ppr.** Discharging from the stomach through the mouth, or ejecting from any deep place.

**VOMITING, n.** The act of ejecting the contents of the stomach through the mouth. *Vomiting* is essentially an inverted spasmodic motion of the muscular fibres of the esophagus, stomach, and intestines, attended with strong convulsions of the muscles of the abdomen and diaphragm. It is preceded by the sensation called *nausea*.—2. The act of throwing out substances with violence from a deep hollow, as a volcano, &c.

**VOMIT'ION, n.** The act or power of vomiting.

**VOMIT'IVE, a.** [Fr. *vomitif*.] Causing the ejection of matter from the stomach; emetic.

**VOMITO, n.** [Sp.] The yellow fever, in its worst form, when it is usually attended with the black vomit.

**VOMITORY, a.** [L. *vomitarius*.] Procuring vomiting; causing to eject from the stomach; emetic.

**VOMITORY, n.** An emetic.—2. [L. *vomitarium*.] In *arch.*, an opening gate or door in an ancient theatre and amphitheatre, which gave ingress or egress to the people.

**VORACIOUS, a.** [Fr. and It. *vorace*;



Undulated Volute (Voluta undulata).

**I. vorax**, from *voro*, to devour; Heb. and Ch. *אָרַץ*, bear, to clear away, to consume; Gr. *βρογος*, food.] 1. Greedy for eating; ravenous; very hungry; as, a voracious man or appetite.—2. Rapacious; eager to devour; as, voracious animals.—3. Ready to swallow up; as, a voracious gulf or whirlpool.  
**VORACIOUSLY**, adv. With greedy appetite; ravenously.  
**VORACIOUSNESS**, n. Greediness of appetite; ravenousness; eagerness to devour; rapaciousness.  
**VORACITY**, n. Greediness of appetite; voraciousness.

Creatures by their voracity pernicious, have commonly fewer young. *Denham.*

**VORAGINOUS**, a. [*L. voraginosus, vorago.*] Full of gulfs.

**VORTEX**, n. plur. *Vortices* or *Vortexes*. [*L. from vorto, Ant. vorto, to turn.*] 1. A whirlpool; a whirling or circular motion of water, forming a kind of cavity in the centre of the circle, and in some instances, drawing in water or absorbing other things.—2. A whirling of the air; a whirlwind.—3. In the Cartesian system, the circular motion originally impressed on the particles of matter, carrying them around their own axes, and around a common centre. Descartes supposed that God created matter of an indefinite extension, and hence concluded that there is no vacuum, but that the universe is absolutely full. He further supposed that God, when he created matter, separated it into small square portions or masses full of angles; that he impressed two motions on this matter; the one by which each part revolved about its own centre or axis; and another, by which an assemblage or system of such parts, turned round a common centre. Hence arose as many different vortices, or eddies, as there were different masses of matter, thus moving about common centres. By means of these vortices, Descartes attempted to account for the formation of the universe, but his system has long since been exploded.

**VORTICAL**, a. Whirling; turning; as, a vortical motion.

**VORTICEL**, } n. [*L. vortex.*] A  
**VORTICELLA**, } genus of wheel-animalcules, having a fixed stem, and having vibratile organs at their anterior extremity, which are constantly in rapid motion, and attract particles of food. The species are very numerous in fresh water, and are generally too small to be perceived without the aid of the microscope.

**VOTARESS**, n. A female devoted to any service, worship, or state of life. No rosary this votress needs. *Claveland.*

**VOTARIST**, n. [*See VOTARY.*] One devoted or given up to any person or thing, to any service, worship, or pursuit.

I am no idle votarist. *Shak.*

[*Votary* is now used.]

**VOTARY**, a. [*from L. votus, from voveo. See Vow.*] Devoted; promised; consecrated by a vow or promise; consequent on a vow.

*Votary* resolution is made equipollent to custom. *Bacon.*

**VOTARY**, n. One devoted, consecrated, or engaged by a vow or promise; hence more generally, one devoted, given, or addicted to some particular service, worship, study, or state of life. Every goddess of antiquity had her votaries. Every pursuit or study has now its

*votaries*. One is a votary to mathematics, another is a votary to music, and alas, a great portion of the world are votaries of sensual pleasures.

It was the coldness of the votary, not the prayer, which was in fault. *Fell.*

**VOTE**, n. [*It. and Sp. voto; L. votum, from voveo, to vow. Votum* is properly wish or will.] 1. Suffrage; the expression of a wish, desire, will, preference, or choice, in regard to any measure proposed, in which the person voting has an interest in common with others, either in electing a man to office, or in passing laws, rules, regulations, and the like. This vote or expression of will may be given by holding up the hand, by rising and standing up, by the voice, ( *viva voce*), by ballot, by a ticket, or otherwise. All these modes and others are used.—Hence, 2. That by which will or preference is expressed in elections, or in deciding propositions; a ballot; a ticket, &c.; as, a written vote.—3. Expression of will by a majority; legal decision by some expression of the minds of a number; as, the vote was unanimous.—4. † United voice in public prayer.—*Casting vote*. In public meetings, where questions are determined by vote, the chairman or presiding member is frequently entitled not only to give his deliberative vote as a member of the meeting, but also to a second vote in cases of equality, and this second vote is termed the casting vote.

**VOTE**, v. i. To express or signify the mind, will, or preference, in electing men to office, or in passing laws, regulations, and the like, or in deciding on any proposition in which one has an interest with others. In elections, men are bound to vote for the best men to fill offices, according to their best knowledge and belief.

To vote for a duelist, is to assist in the prostration of justice, and indirectly to encourage the crime. *L. Beecher.*

**VOTE**, v. t. To choose by suffrage; to elect by some expression of will; as, the citizens voted their candidate into office with little opposition.—2. To enact or establish by vote or some expression of will. The legislature voted the resolution unanimously.—3. To grant by vote or expression of will.

Parliament voted them a hundred thousand pounds. *Swift.*

**VOTED**, pp. Expressed by vote or suffrage; determined.

**VOTER**, n. One who has a legal right to vote or give his suffrage.

**VOTING**, pp. Expressing the mind, will, or preference in election, or in determining questions proposed; giving a vote or suffrage; electing, deciding, giving, or enacting by vote.

**VOTIVE**, a. [*Fr. votif; L. votivus, from votus, vowed.*] Given by vow; devoted; as, votive offerings. A votive medal is one struck in grateful commemoration of some auspicious event; as, the recovery of a prince from sickness. A votive table, picture, &c., is one dedicated in consequence of the vow [*L. ex voto*] of a worshipper. Among the Greeks and Romans such offerings were dedicated to some deity, and were deposited in temples. Among Roman Catholics, they are dedicated to saints.

Venus, take my votive glass. *Prior.*

**VOTIVENESS**, n. Quality of being votive.

**VOUCH**, v. t. [*Norm. voucher; L. voco. See VOICE.*] 1. To call to witness; to obtest.

And vouch the silent stars and conscions moon. *Dryden.*

2. To declare; to affirm; to attest; to warrant; to maintain by affirmations.

They made him ashamed to vouch the truth of the relation, and afterward to credit it. *Atterbury.*

3. To warrant; to confirm; to establish proof.

The consistency of the discourse...vouches it to be worthy of the great apostle. *Locke.*

4. In law, to call into court to warrant and defend, or to make good a warranty of title.

He vouches the tenant in tail, who vouches over the common vouchee. *Blackstone.*

**VOUCH**, v. i. To bear witness; to give testimony or full attestation. I cannot vouch for the truth of the report.

He declares he will not believe her, till the elector of Hanover shall vouch for the truth of what she has so solemnly affirmed. *Swift.*

**VOUCH**, † n. Warrant; attestation.

**VOUCHED**, pp. Called to witness; affirmed or fully attested; called into court to make good a warranty.

**VOUCHEE**, n. In law, the person who is vouched or called into court to support or make good his warranty of title in the process of common recovery.

**VOUCHER**, n. One who gives witness or full attestation to any thing.

The great writers of that age stand up together as vouchers for each other's reputation. *Spectator.*

2. In law, the act of calling in title to make good his warranty of title.—

3. A book, paper, or document which serves to vouch the truth of accounts, or to confirm and establish facts of any kind. The merchant's books are his vouchers for the correctness of his accounts. Notes, bonds, receipts, and other writings, are used as vouchers in proving facts.—In Scots law, voucher is the technical name for the written evidence of payment.

**VOUCHER**, } n. In law, the tenant in  
**VOUCHOR**, } writ of right; one who calls in another to establish his warranty of title. In common recoveries, there may be a single voucher, or double vouchers.

**VOUCHING**, pp. Calling to witness; attesting by affirmation; calling in to maintain warranty of title.

**VOUCHSAFE**, v. t. [*vouch and safe; to vouch or answer for safety.*] 1. To permit to be done without danger.—2. To condescend to grant.

Shall I vouchsafe your worship a word or two? *Shak.*

It is not said by the apostle that God vouchsafed to the heathen the means of salvation. *South.*

**VOUCHSAFE**, v. i. To condescend; to deign; to yield.

*Vouchsafe*, illustrious Ormond, to behold What pow'r the charms of beauty had of old. *Dryden.*

**VOUCHSAFED**, pp. Granted in condescension.

**VOUCHSAFEMENT**, n. Grant in condescension; as, God's greatest communicated vouchsafements.

**VOUCHSAFING**, pp. Condescending to grant; deigning.

**VOUSSOIR**, n. [*voos'wor.*] [*Fr.*] In arch., a stone in the shape of a truncated wedge which forms part of an arch. The under sides of the voussours

form the intrados or soffit of the arch, and the upper side the extrados. The

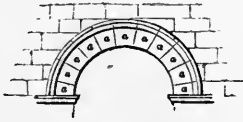

Voussoirs.

middle voussoir is termed the *key-stone*. [See ARCH.]

**VOW**, *n.* [Fr. *vœu*; It. *voto*; L. *votum*, from *voceo*, to vow; probably a contracted word] 1. A solemn promise or oath made to God, or by a pagan to his deity. The Roman generals, when they went to war, sometimes made a *vow* that they would build a temple to some favourite deity, if he would give them victory. A *vow* is a promise of something to be given or done hereafter. A person is constituted a religious by taking three *vows*, of chastity, of poverty, and of obedience. Among the Israelites, the *vows* of children were not binding, unless ratified by the express or tacit consent of their father; Num. xxx. Among the *Romans*, *vows* signified sacrifices, offerings, presents, and prayers made for the Cæsars and emperors, particularly for their prosperity, and the continuance of their empire.—2. A solemn promise; as, the *vows* of unchangeable love and fidelity. In a moral and religious sense, *vows* are promises to God, as they appeal to God to witness their sincerity, and the violation of them is a most heinous offence.

**VOW**, *v. t.* [Fr. *vouer*; L. *voceo*.] 1. To give, consecrate, or dedicate to God by a solemn promise. When Jacob went to Mesopotamia, he *vowed* to God a tenth of his substance, and his own future devotion to his service; Gen. xxviii.

When thou *vowest* a *vow*, defer not to pay it; Eccles. v.  
2. To devote.

**VOW**, *v. i.* To make *vows* or solemn promises. He that *vows*, must be careful to perform.

**VOWED**, *pp.* Solemnly promised to God; given or consecrated by solemn promise.

**VOWEL**, *n.* [L. *vocalis*, from *voco*; Fr. *voyelle*; It. *vocale*.] 1. In *gram.*, a simple sound; a sound uttered by simply opening the mouth or organs; as the sound of *a, e, o*.—2. The letter or character which represents a simple sound, and which can be pronounced by itself. Vowels are thus distinguished from consonants, which require to be sounded with the aid of a vowel. The English vowels are six in number, viz., *a, e, i, o, u, y*.

**VOWEL**, *a.* Pertaining to a vowel; vocal.—*Vowel points* are used in Hebrew, its alphabet consisting only of consonants; they are placed above and below the letters.

**VOWELISH**, *† a.* Of the nature of a vowel.

**VOWELISM**, *n.* The use of vowels.

**VOWELLED**, *a.* Furnished with vowels.

**VOWER**, *n.* One who makes a *vow*.

**VOW-FELLOW**, *n.* [*vow* and  *fellow*.] One bound by the same *vow*. [*Little used*.]

**VOWING**, *ppr.* Making a *vow*.

**VOX**, *n.* [L.] A voice; a sound,—*Vox populi*, the voice of the people; opinion or sentiment of the generality.—*Vox Dei*, the voice or command of God.—*Vox clamantis in deserto*, the voice of one crying in the wilderness (John i. 23.); applied, by extension, to cases where warnings or prophecies (like those of Cassandra) are uttered in vain.—*Vox et præterea nihil*, a voice and nothing more; a vain sound, or empty threat.

**VOYAGE**, *n.* [Fr. from *voie*, or the same root, Eng. *way*, Sax. *wag, weg*. See WAG and WAY.] 1. A passing by sea or water from one place, port, or country to another, especially a passing or journey by water to a distant place or country; as, a *voyage* to the East or West Indies. Ferdinand Magellan, a Spaniard, made the first *voyage* round the world, in the early part of the 17th century.—2. † The practice of travelling.—3. In a *low sense*, course; attempt; undertaking.

**VOYAGE**, *v. i.* To sail or pass by water.

**VOYAGE**, *v. t.* To travel; to pass over.

I with pain

*Voyag'd th' unreal, vast, unbounded deep.*

*Milton.*

**VOYAGEABLE**, *a.* Navigable.

**VOYAGER**, *n.* One who sails or passes by sea or water.

A private *voyager* I pass the main. *Pope.*

**VOYAGEUR**, *n.* [Fr.] Literally, a traveller. The Canadian name of a class of men employed by the fur companies, &c., in transporting goods by the rivers and across the land, to and from the remote stations at the northwest. These men are nearly always French Canadians.

**VOYAGING**, *n.* or *ppr.* Making a *voyage*.

**VOYOL VIOL**, *n.* In *mar. lan.*, a large rope used to unmoor or heave up the anchors of a ship, by transmitting the effort of the capstan to the cables.

**VULCAN**, *n.* [L. *vulcanus*.] In *myth.*, the god who presided over fire, and the working of metals. He was called by the Greeks *Hephaestus*, and was, according to Homer, the son of Jupiter and Juno. He married Venus, who proved unfaithful to him. In sculpture, he is represented as bearded, with a hammer and pincers, and a pointed cap, but does not appear to be lame, as the poets describe him.

**VULCANIAN**, } *a.* Pertaining to Vulcan.  
**VULCANIC**, } can, or to works in iron, &c.—2. In *geol.*, pertaining to or designating the system or theory of the *Vulcanists*, otherwise termed *Plutonists*.

**VULCANIST**, *n.* One who supports the *Vulcanian* or *Plutonian* theory, which ascribes the changes on the earth's surface to the agency of fire, and maintains that all rocks are of igneous production. The *Vulcanists* maintain that the earth was at first in a state of igneous fusion, that it gradually cooled, and became covered only at a subsequent period. They maintain that the land was raised up by a subterranean force, their regularities which diversify its surface being the effects of volcanic eruptions; and that the transported soils have been formed by the disintegrations of the higher grounds. The *Vulcanists* were opposed to the *Neptun-*

ists, who maintained that all geological formations have been precipitated from water, or from a chaotic fluid. The *Vulcanian* theory has been expanded and illustrated by Lyell, and some other geologists of the present day.

**VULCANIZATION**, *n.* A new method of treating Indian rubber, by which its valuable properties are greatly increased, and some new ones bestowed upon it. It is as follows:—The Indian rubber is immersed in a bath of fused sulphur, heated to a proper temperature, until, by absorbing a portion of the sulphur, it assumes a carbonized appearance, and eventually acquires the consistence of horn. The same state can, however, be produced by either kneading the India rubber with sulphur, and then exposing it to a temperature of 190°, or by dissolving it in any of the common solvents, as turpentine, holding sulphur in solution or suspension. The compound thus formed is properly a sulphuret of caoutchouc, and possesses the following properties. It remains elastic at all temperatures; it cannot be dissolved by the ordinary solvents, neither is it affected by heat within a considerable range of temperature; finally, it acquires extraordinary powers of resisting compression, with a great increase of strength and elasticity. Vulcanized India rubber has been employed with great success as a substitute for the spiral steel springs used for the *buffers* of railway carriages, to moderate the effects of concussion. It is also used in railways, and is laid between the rail and the sleeper, and thus prevents the rails from indicating any traces of pressure. It forms in engines a most valuable material for washers, and it is formed into a tubing of great strength and flexibility, well adapted for fire-hose, and for any apparatus required in conveying steam, water, or gas. It also forms elastic bands, trouser-straps, surgical bandages, and a number of other articles.

**VULCANIZED INDIAN RUBBER**. Indian rubber or caoutchouc combined with sulphur. [See VULCANIZATION.]

**VULCANO**. See VOLCANO.

**VULGAR**, *a.* [Fr. *vulgaire*; It. *vulgare*; L. *vulgaris*, from *vulgus*, the common people, that is, the crowd, Eng. *folk*.] 1. Pertaining to the common unlettered people; as, *vulgar* life.—2. Used or practised by common people; as, *vulgar* sports.—3. Vernacular; national.

It might be more useful to the English reader, to write in our *vulgar* language.

*Fell.*

4. Common; used by all classes of people; as, the *vulgar* version of the scriptures.—5. Public; as, *vulgar* report.—6. Mean; rustic; rude; low; unrefined; as, *vulgar* minds; *vulgar* manners.—7. Consisting of common persons.

In reading an account of a battle, we follow the hero with our whole attention, but seldom reflect on the *vulgar* heaps of slaughter. *Rambler.*

*Vulgar era*, the common era used by Christians, dating from the birth of Christ.—*Vulgar errors*, in *law*, erroneous notions entertained by the common people in regard to points of law.—*Vulgar fractions*, in *arith.*, fractions expressed by a numerator and denominator; thus  $\frac{3}{4}$ . [See FRACTIONS.]



**VUL'GAR, n.** The common people. [It has no plural termination, but has often a plural verb.]

The vulgar imagine the Pretender to have been a child imposed on the nation.

*Swift.*

**VUL'GARISM, n.** Grossness of manners; vulgarity. [Little used.]—2. A vulgar phrase or expression. [This is the usual sense of the word.]

**VULGARITY, } n.** Mean condition  
**VUL'GARNESS, }** in life; the state of the lower classes of society.—2. Grossness or clownishness of manners or language; an act of low manners; as, vulgarity of behaviour: vulgarity of expression or language. [Vulgurness is little used.]

**VUL'GARIZE, v. t.** To make vulgar.

**VUL'GARIZED, pp.** Made vulgar.

**VUL'GARIZING, ppr.** Rendering vulgar.

**VUL'GARLY, adv.** Commonly; in the ordinary manner among the common people.

Such one we vulgarly call a desperate person. *Hammond.*

2. Meanly; rudely; clownishly.  
**VUL'GATE, n.** A very ancient Latin version of the scriptures, and the only one which the Romish church admits to be authentic. It is so called from its common use in the Latin church; said to have been discovered, A.D. 218; first printed in 1462.

**VUL'GATE, a.** Pertaining to the old Latin version of the scriptures.

**VUL'NED, a.** [L. *vulnus*, a wound.] In her, an epithet applied to any animal that is wounded and bleeding; as, a hind's head *vulned*.

**VULNERABILITY, } n.** That may  
**VULNERABLENESS, }** be wounded; liable to injury; exposed to harm.

**VUL'NERABLE, a.** [Fr. from L. *vulnere*, to wound, from *vulnus*, a wound.] 1. That may be wounded; susceptible of wounds or external injuries; as, a *vulnerable* body.

Achilles was *vulnerable* in his heel; and there will never be wanting a Paris to infix the dart. *Dwight.*

2. Liable to injury; subject to be affected injuriously; as, a *vulnerable* reputation.

**VUL'NERARY, a.** [Fr. *vulnere*; L. *vulnerarius*.] Useful in healing wounds; adapted to the cure of external injuries; as, *vulnerary* plants or potions.

**VUL'NERARY, n.** Any plant, drug, or composition, useful in the cure of wounds. Certain unguents, balsams, and the like, are used as *vulneraries*.

**VUL'NERATE, † v. t.** [L. *vulnere*.] To wound; to hurt.

**VULNERA'TION, † n.** The act of wounding.

**VUL'NEROSE, a.** Full of wounds.

**VULNIFIC, a.** Causing wounds.

**VUL'NING, ppr.** Wounding; a term particularly applied in heraldry to the pelican, which is always depicted wounding or picking her breast.

**VULPE'CU'LA ET AN'SER.** [L.] The fox and the goose, a constellation of Hevelius, situated immediately above Aquila and Sagitta. According to the British catalogue, it contains 37 stars.

**VUL'PES, n.** The subgeneric name for the foxes, adopted by those zoologists who distinguish the foxes from the dogs, jackals, and wolves, to which they consequently restrict the term *Canis*. [See Fox.]

**VUL'PINE, a.** [L. *vulpinus*, from *vulpes*, a fox. *Vulpes* is our English wolf, the same word applied to a different animal.] Pertaining to the fox; cunning; crafty; artful.

**VUL'PINITE, n.** [from *Vulpino*, in Italy.] A mineral of a grayish white colour, splendid and massive; its fracture foliated. It is an anhydrous sulphate of lime, containing a little silica. It occurs along with granular foliated limestone at Vulpino, in Italy, and is sometimes employed by the Italian artists for small statues, and other ornamental work, under the name of *marino bardiglio*.

**VULSEL'LA, n.** A genus of conchiferous molluscs, the shells of which are brought from the Indian ocean and the seas of New Holland, and are generally found buried in sponge. They are subconic, elongated, flattened, irregular, inequilateral, subequivalve, the umbones nearly anterior, distant, and a little recurved. The hinge is toothless, with a prominent callosity in each valve, showing a pit for the insertion of the ligament.

**VUL'TURE, n.** [L. *vultur*.] The English name of a genus (*Vultur*) of rapacious birds, characterized by having the head and part of the neck destitute of feathers, the tarsi covered with small scales, and a rather elongated beak, of which the upper mandible is curved at the end. The strength of their talons does not correspond with their size, and they make more use of their beak than of their claws. In general, the birds belonging to this genus are of a cowardly nature, living chiefly on dead carcases and offal. Their geographical distribution is confined chiefly to warm countries, where they act as scavengers to purify the earth from the putrid carcases with which it would otherwise be encumbered. The genus *Vultur*, Linn., is now divided into the subgenera *Vultur* proper, *Cathartes*, *Sarcoramphus*, *Percnopterus*, and *Gypaetos*. The Griffon vulture (*V. fulvus*), inhabits the moun-

tainous parts of the north of Europe, Silesia, Spain, the Alps, the Pyrenees, Turkey, and the Grecian Archipelago. The cinereous or ash-vulture (*V. cinereus*), inhabits lofty mountains in



Ash Vulture (*Vultur cinereus*).

Europe, and the vast forests of Hungary, the Tyrol, and the Pyrenees, the south of Spain and Italy. The bearded vulture, or Lämmer-geyer, (*Gypaetos barbatus*), inhabits the highest mountains of Europe, Asia, and Africa. The Egyptian vulture is the *Nephron*



Egyptian Vulture (*Nephron percnopterus*).

*percnopterus*. The sociable vulture (*V. auricularis*) is a gigantic species, inhabiting the greater part of Africa. The black vulture (*Cathartes atratus*) is a native of the United States. The king vulture (*Sarcoramphus papa*) is common in Paragnay. The *Sarcoramphus gryphus* is the celebrated Condor vulture of South America.

**VULTURIDÆ, n.** The family of the vultures. [See VULTURE.]

**VUL'TURINE, a.** [Lat. *vulturinus*.] Belonging to the vulture; having the qualities of, or resembling the vulture.

**VUL'TURISII, } a.** Like a vulture;  
**VUL'TUROUS, }** rapacious.

**VY'ING, ppr.** Competing; emulating.

## W.

**W** IS the twenty-third letter of the English Alphabet. It takes its written form and its name from the union of two Vs, this being the form of the Roman capital letter which we call U. The name, *double u*, being given to it from its form or composition, and not from its sound, ought not to be retained. Every letter should be

named from its sound, especially the vowels. W is properly a vowel, a simple sound, formed by opening the mouth with a close circular configuration of the lips. It is precisely the *ou* of the French, and the *u* of the Spaniards, Italians, and Germans. With the other vowels it forms diphthongs, which are of easy pronunciation; as in

*well, want, will, dwell*; pronounced *ooell, ooant, ooill, doell*. In English, it is always followed by another vowel, except when followed by *h*, as in *when*; but this case is an exception only in writing, and not in pronunciation, for *h* precedes *w* in utterance: *when* being pronounced *hooen*. In Welsh, *w*, which is sounded as in English, is used with-

ont another vowel, as in *fwl*, a fool; *dwn*, dun; *dwb*, mortar; *gun*, a gun, and a gown. It is not improbable that the Romans pronounced *w* as we do *w*, for their *volvo* is our *wallow*; and *volo*, *velle*, is the English *will*, *G. wolen*. But this is uncertain. The German *v* has the sound of the English *f*, and *v* that of the English *v*. *W*, at the end of words, is often silent after *a* and *o*, as in *law*, *saw*, *low*, *sow*. In many words of this kind, *w* represents the Saxon *g*; in other cases it helps to form a diphthong, as in *now*, *vow*, *new*, *strew*. As an abbreviation, *W* stands for *west*; *W.N.W.*, for *west-north-west*; *W.S.W.*, for *west-south-west*, &c.

**WAB'BLE**, *v. i.* [*W. gwibiaw*, to wander, to move in a circular form.] To move from one side to the other; to vacillate; as a turning or whirling body. So it is said a top *wabbles*, when it is in motion, and deviates from a perpendicular direction; a spindle *wabbles*, when it moves one way and the other. A millstone in motion, if not well balanced, will *wabble*. [*This word is applied chiefly to bodies when turning with a circular motion, and its place cannot be supplied by any other word in the language. It is neither low nor barbarous.*]

**WAB'BLE**, *n.* A hobbling unequal motion.

**WAB'BLING**, *ppr.* or *a.* Having an irregular motion, backward and forward.

**WAB'STER**, *n.* A weaver. [*Scotch.*]

**WACK'E**, *n.* [*Ger.*] A massive mineral, intermediate between claystone and basalt, and which may be considered as a soft and earthy variety of basalt. Its colours are greenish grey, sometimes passing into blackish green, brown, and grayish black, with sometimes a shade of yellow or red. It is opaque, and occurs in amorphous masses, compact or viscidular, streak shining, soft, easily frangible. Specific gravity 2.5 to 2.9. Before the blow-pipe it fuses into an opaque porous mass. It is found more abundantly in Germany than in any other country.

**WAD**, *n.* [*G. watte*; *Dan. vat*, a wad; that is, a mass or collection.] 1. A little mass of some soft or flexible material, such as hay, straw, tow, paper, or old rope-yarn, used for stopping the charge of powder in a gun and pressing it close to the shot, or for keeping the powder and shot close.—2. A little mass, tuft, or bundle, as of hay or tow. [*See WADDING.*]

**WAD**, *n.* [*Sax. wad*, *wed*.] A pledge; a wager. [*Scotch.*]

**WAD**, *v. t.* To pledge; to bet; to wager. [*Scotch.*]

**WADD**, *n.* In *mineral*, black wadd is an ore of manganese, found in Derbyshire and Banffshire, which consists of the peroxide of manganese associated with nearly its own weight of oxide of iron. When mixed with linseed oil for a paint, it is apt to take fire.—2. A provincial name for plumbago in Cumberland.

**WAD'DED**, *a.* Formed into a wad or mass; quilted; stuffed with wadding.

**WAD'DING**, *n.* A wad, or the materials for wads; any pliable substance of which wads may be made.—2. Material for ramming down above the charge of fire arms.—3. A spongy web used for stuffing various parts of ladies' dresses. It is made with a fleece of

cotton prepared by the carding machine, the surface being covered with tissue paper, applied by a coat of size.

**WAD'DING**, *a.* Suited for wadding; as, *wadding paper*.

**WAD'DLE**, *v. i.* [This seems to be a diminutive formed on the root of *wade*, *L. wado*, to go; *G. waten*, to wade; *watscheln*, to waddle.] 1. To move one way and the other in walking; to deviate to one side and the other; to vacillate; as, a child *waddles* when he begins to walk; very fat people walk with a kind of *waddling* pace. So we say, a duck or a goose *waddles*.—2. To walk with a *waddling* motion.

And hardly *waddles* forth to cool. *Swift.*

**WAD'DLER**, *n.* One that waddles.

**WAD'DLING**, *ppr.* Moving from side to side in walking.

**WAD'DLINGLY**, *adv.* With a vacillating gait.

**WADE**, *v. i.* [*Sw. wada*; *D. waaden*; *G. waten*; *Fr. guere*, for *gueder*; *It. guadare*; *Sp. vadear*, *L. wado*, to go. *Qu. Heb.*  $\text{וַדַּע}$ , *abad*, to go.] 1. To walk through any substance that yields to the feet; as, to *wade* through water; to *wade* through sand or snow. To *wade* over a river, is to walk through on the bottom. Fowls that *wade* have long legs.—2. To move or pass with difficulty or labour; as, judges *wade* through an intricate law case. It is not my purpose to *wade* through these controversies.

The king's admirable conduct has *waded* through all these difficulties. *Davenant.*  
And *wades* through fumes, and gropes his way. *Dryden.*

**WADE**, *v. t.* To pass by walking on the bottom; as, to *wade* a river. [This is a common expression, but elliptical for *wade through a river.*]

**WA'DER**, *n.* One that wades.

**WA'DERS**, } *n.* The English  
**WADING BIRDS**, } name of the grallatores. [*See GRALLATORES.*]

**WADING**, *ppr.* Walking through a substance that yields to the feet, as through water or sand.

**WAD'SET**, } *n.* [*Sax. wad*, *wed*, *Scot.*  
**WAD'SETT**, } *wad*, a pledge; and *Sax. settan*, to set or lay.] In *Scots law*, a conveyance of land in pledge for or in satisfaction of a debt or obligation, with a reserved power to the debtor to recover his lands on payment or performance. The lender or creditor is called the *wadsetter*, and the borrower the *reverser*. This was the earliest method of granting security on land in Scotland, and though still legal, it is now seldom, if ever, practised. Wadsets are divided into two sorts, *proper* and *improper*. When the wadsetter enters on possession, and takes, in place of interest, the yearly fruits, with the risk of the seasons, it is a proper wadset. When he agrees to accept of a fixed yearly sum as interest, and accounts to the reverser for the rents, the *wadset* is improper.

**WAD'Y**, *n.* [*Ar.*] The channel of a water-course which is dry, except in the rainy season. In a more extended sense applied to a dry valley, and also to signify any valley.

**WAE'SUCKS**, *interj.* Alas! [*Scotch.*]

**WAFER**, *n.* [*D. wafel*; *G. waffel*; *Russ. vaphel*; *Fr. gauffre.*] 1. A thin cake or loaf; as, a *wafer* of bread given by the Roman catholics in the eucharist.—2. A thin round leaf of paste, or a composition of flour, the white of eggs, isinglass, and yeast, spread over

with gum water and dried; used in sealing letters. The colouring matters used in wafers are mixed with the liquid paste. Fancy wafers are made of gelatine, in a variety of forms.

**WAF'ER**, *v. t.* To seal or close with a wafer.

**WAF'ERED**, *pp.* Sealed with a wafer.

**WAF'FLE**, *n.* [*D. wafel*, *G. waffel.*] A thin cake baked hard and rolled, or a soft indented cake baked in an iron utensil on coals.

**WAF'FLE-IRONS**, *n.* An utensil for baking waffles.

**WAF'T**, *v. t.* [perhaps from *wag*; if so, it belongs to the root of *wave*.] 1. To bear through a fluid or buoyant medium; to convey through water or air; as, a balloon was *waf't* over the channel.

Speed the soft intercourse from soul to soul,

And *waf't* a sigh from Indus to the pole. *Pope.*

2. To convey; as ships.—3. To buoy; to cause to float; to keep from sinking.—4.† To beckon; to give notice by something in motion. [This verb is regular. But *waf't* was formerly used by some writers for *waf'ied*.]

**WAF'T**, *v. i.* To float; to be moved or to pass in a buoyant medium.

And now the shouts *waf't* near the citadel. *Dryden.*

**WAF'T**, *n.* A floating body; also, a signal displayed from a ship's stern, by hoisting an ensign furled in a roll, to the head of the staff.

**WAF'TAGE**, *n.* Conveyance or transportation through a buoyant medium, as air or water.

**WAF'TED**, *pp.* Born or conveyed through air or water.

**WAF'TER**, *n.* He or that which waf'ts; a passage boat.—2. The conductor of vessels at sea; an *old word*.

**WAF'TING**, *ppr.* Carrying through a buoyant medium.

**WAF'TING**, *n.* A bearing or floating in a fluid.

**WAF'TURE**, *† n.* The act of waf'ing.

**WAG**, *v. t.* [*Sax. wagian* and *wecgan*; *G. bewegen*; *D. bewegen*, to move, to stir; *wegen*, to weigh; *G. wägen*, to weigh; *Sw. väga*, *Dan. vajer*, to wag, to weigh. This is the radix of the *L. vacillo*, *Eng. fickle*, *waggon*, *wain*, *way*, *wave*, *waggle*, &c.] To move one way and the other with quick turns; to move a little way, and then turn the other way; to move lightly from side to side; to shake slightly; as, to *wag* the head.

Every one that passeth thereby shall be astonished, and *wag* his head; *Jer. xviii.*; *Matth. xxvii.*

[*Wag* expresses particularly the motion of the head and body used in buffoonery, mirth, derision, sport, and mockery. It is applied also to birds and beasts; as, to *wag* the tail.]

**WAG**, *v. i.* To be quick in ludicrous motion; to stir.

'Tis merry in hall, where beards *wag* all. *Shak.*

Tremble and start at *wagging* of a straw. *Shak.*

2. To go; to depart; to pack off. I will provoke him to't, or let him *wag*. *Shak.*

3. To be moved one way and the other; to be moved from side to side.

The resty sieve *wag'd* ne'er the more. *Dryden.*

**WAG**, *n.* [from the verb.] A droll; a man full of low sport and humour;

one full of merry frolicsome tricks; one ludicrously mischievous.

We wink at *wags*, when they offend.

*Dryden.*

The counsellor never pleaded without a piece of packthread in his hand, which he used to twist about his finger all the while he was speaking; the *wags* used to call it the thread of his discourse.

*Addison.*

WAGE, *v. t.* [*G. wagen*; *D. waagen*; *Sw.*

*waga*, to venture, to dare, to wage; *Fr. gager*, for *guager*, to lay or bet; from the root of *wag*. The sense is to throw, to lay or throw down, as a glove or gauntlet.] 1.† To lay; to bet; to throw down, as a pledge; to stake; to put at hazard on the event of a contest.—2.† To venture; to hazard.

To wake and *wage* a danger profitless.

*Shak.*

3. To make; to begin; to engage in, as by a previous pledge or determination; to carry on; that is, to go forward or advance to attack, as in invasion or aggression; used in the phrase, to *wage war*. He *waged war* with all his enemies.

He pondered, which of all his sons was fit To reign, and *wage* immortal war with wit.

*Dryden.*

4. To set to hire.

Thou must *wage*

Thy works for wealth.†

*Spenser.*

5.† To take to hire; to hire for pay; to employ for wages; as, *waged* soldiers. He was well *waged* and rewarded. [*Fr.*] To *wage one's law*, to come forward as a defendant, with others, on oath that he owes nothing to the plaintiff in manner as he has declared. [*See WAGER.*]

WAGE,† *n.* Gage; pledge; a stake.—2.† Hire; pay for service. The plural, *wages*, is now only used.

WAGED, *pp.* Laid; deposited; as a pledge; made or begun, or carried on, as war.

WAGER, *n.* A bet; something deposited, laid, or hazarded on the event of a contest or some unsettled question; something staked by each of two parties in support of his own opinion concerning a future or an unknown event. The party whose opinion proves to be correct, receives what has been staked by both.

Besides these plates for horse races, the *wagers* may be as the persons please.

*Temple.*

If any atheist can stake his soul for a *wager* against such an inexhaustible disproportion...

*Bentley.*

2. Subject on which bets are laid.—In *Eng. law*, wagers are valid, and may be made subjects of action, unless such as are rendered expressly void by law, or have an illegal or immoral tendency. In *Scots law*, all wagers are regarded as *pacta illicita*, or unlawful contracts. Hence, no action is competent for the recovery of any sum gained by betting or wagering in any form.—3. In *law*, an offer to make oath of innocence or non-indebtedness; or the act of making oath, together with the oaths of eleven compurgators, to fortify the defendant's oath.

—*Wager of law* was formerly a mode of trial, whereby in an action of debt brought upon a simple contract between the parties, without any deed or record, the defendant might discharge himself by taking an oath that he owed not the plaintiff anything; but he required to bring with him eleven

persons of his neighbours, called *compurgators*, who were to avow upon their oath that they believed in their consciences that he declared the truth. This mode of trial is no longer in use.—

*Wager of battle* was when the tenant in a writ of right offered to prove his right by the body of his champion, and throwing down his glove as a gage or pledge, thus waged or stipulated battle with the champion of the demandant, who, by taking up the glove, accepted the challenge. The champions, armed with batons, entered the list, and taking each other by the hand, each swore to the justice of the cause of the party for whom he appeared; they then fought till the stars appeared, and if the champion of the tenant could defend himself till that time, his cause prevailed. The *wager of battle*, which had been long disused, was, in 1818, demanded by the nearest relative of a murdered girl, against one Abraham Thornton, her supposed seducer and slayer; this led to its formal abolition, the year after, by the act 59 Geo. 3. c. 46.—To lay a *wager*, to lay down a pledge or surety; to bet.

WAGER, *v. t.* To lay; to bet; to hazard on the issue of a contest, or on some question that is to be decided, or on some casualty.

WAGERED, *pp.* Laid; pledged; as a bet.

WAGERER, *n.* One who wagers or lays a bet.

WAGERING, *pp.* Laying; betting.—

*Wagering policy*, or *wager policy*, in *com.*, a policy of insurance, insuring a sum of money when no property is at hazard; as, a policy to insure money on a ship when no property is on board; that is, insurance, interest or no interest: or a wagering policy may be a policy to insure property which is already insured. Such policies are by statute 19 Geo. 3. made null and void.

WAGES, *n.* plural in termination, but singular in signification. [*Fr. gage, gages.*] 1. Hire; reward; that which is paid or stipulated for services. In *ordinary lan.*, the term wages is usually restricted to the sums paid as rewards to artisans, to domestic servants, to labourers employed in manufactures, in agriculture, mines, and other manual occupations. We speak of servant's *wages*, a labourer's *wages*, or tradesmen's *wages*; and we never apply the word to the rewards given to men in office, which are called *fees* or *salary*. The money paid for military and naval services is termed *pay*, and the incomes of clergymen *stipends*.

Tell me, what shall thy *wages* be? Gen. xxix.

Be content with your *wages*; Luke iii. 2. In *political economy*, the price paid for labour; the return made or compensation paid to those employed to perform any kind of labour or service by their employers. In this sense, the term extends to the salaries of public functionaries of all sorts, to the fees of lawyers, physicians, and other professional men, as well as to the sums paid to artisans, labourers, and menials.—3. Reward; fruit; recompense; that which is given or received in return.

The *wages* of sin is death; Rom. vi. WAG'GEL, } *n.* A name given in Cornwall to the young of the great black-backed gull, the *Larus marinus*.

WAG'GERY, *n.* [from *wag*] Mischievous merriment; sportive trick or gagey; sarcasm in good humour; as, the *wagery* of a school-boy.

WAG'GING, *pp.* Moving the head one way and the other with quick turns.

WAG'GISH, *a.* Mischievous in sport; roguish in merriment or good humour; frolicsome; as, a company of *waggish* boys.—2. Done, made, or laid in *wagery* or for sport; as, a *waggish* trick.

WAG'GISHLY, *adv.* In a *waggish* manner; in sport.

WAG'GISHNESS, *n.* Mischievous sport; wanton merriment.

WAG'GLE, *v. i.* [*D. waggelen*; *G. wacheln*; *L. vacillo*, dim. of *wag*.] To waddle; to reel or move from side to side.

Why do you go nodding and *wagging* so? *L'Ettrange.*

WAG'GLE, *v. t.* To move one way and the other; as, a bird *waggles* its tail.

WAG'GON, *n.* [*D. and G. wagen*; *Sax. wægn, wæn*; *W. gwain*, a wagon, wain, or sheath, *L. vagina*, the latter being from *wag*, and signifying a passage; Gaelic, *baighin*, a wagon; Malabar, *uagahan*; Sans. *wahana*. This word is often spelt *wagon*, especially in American printed books.] 1. A vehicle moved on four wheels, and usually drawn by horses. Waggons are constructed in different forms and of various dimensions, but in general they are heavy, clumsy, and inconvenient vehicles, and suitable only for the conveyance of different sorts of heavy loads to considerable distances.

—2.† A chariot.

WAG'GON, *v. t.* To transport in a wagon. Goods are *waggoned* from New York to the interior. [*American.*]

WAG'GONAGE, *n.* Money paid for carriage in a wagon.

WAG'GONED, *pp.* Transported in waggons.

WAG'GONER, *n.* One who conducts a wagon.—2. A constellation, Charles's Wain.

WAG'GON HEADED CEILING, or VAULTING. In *arch.*, the same as *cylindric vaulting*. [*See CYLINDRIC.*]

WAG'GONING, *pp.* Transporting in a wagon.

WAG'GONING, *n.* The business of transporting in a wagon.

WAG'GON-SPOKE,† *n.* The spoke of a wagon-wheel.

WAG'GON-TRAIN, *n.* The carriage service of the British army when in campaign, including the vehicles with their equipments, for conveying munitions of war, &c. The former *royal waggon-train* now takes the official name of *field-train department*.

WAG'GON-WAY, *n.* A tram road or railroad.

WAG'TAIL, *n.* [*wag* and *tail*.] The



Common Wagtail (*Motacilla jarellii*).

English name of a sub-genus of birds (*Motacilla*, Cuv.), separated from the

genus *Motacilla*, Linn. The species of wagtails are small birds, and are chiefly confined to the European continent. They are easily distinguished by their brisk and lively motions, as well as by the great length of their tails, which they jerk up and down incessantly; hence the name. The species most common in this country is the pied wagtail, or black and white water-wagtail (*M. yarrelli*), which is to be seen wherever there are shallow springs and running waters.

WA'HABEE, } *n.* A follower of Abdel  
WA'HABITE, } Wahab, a reformer of  
Mohammedism, about 1760. His doctrines prevail particularly among the Bedouins; and the sect, though kept in check by the orthodox, influences most parts of Arabia.

WAID, *f. a.* Crushed; bent with weight.  
WAIF, } *n.* [Norm. *wef, weif*; from  
WAIFT, } *waive.*] Goods found, of which the owner is not known. These were originally such goods as a thief, when pursued, threw away to prevent being apprehended. They were forfeited to the king, or lord of the manor, having the franchise of waif; but if the owner made fresh pursuit after the felon, took him and brought him to justice within a year and a day, he was entitled to restitution. In *Scots law*, *waif cattle* are such as have strayed, and of which the owner is not known. They belong to the sovereign, where they are advertised and not claimed within a year, unless the proprietor on whose lands they were found have a grant of waifs.

WAIL, *v. t.* [Ice. *væla*; It. *guaiolare*; Gaelic, *guilam* or *uail*; W. *gwyllaw* and *wylaw*; Arm. *goela*, to howl; Heb. and Ar.  $\text{נאן}$ , *abal.*] To lament; to moan; to bewail.

Or if no more her absent lord she *waits*.  
*Pope.*

WAIL, *v. i.* To weep; to express sorrow audibly.

Therefore I will *wail* and howl; *Mic. i.*

WAIL, *n.* Loud weeping; violent lamentation.

WAILFUL, *a.* Sorrowful; mournful.  
WAILING, *ppr.* Lamenting with audible cries.

WAILING, *n.* Loud cries of sorrow; deep lamentation.

There shall be *wailing* and gnashing of teeth; *Matth. xiii.*

WAILINGLY, *adv.* In a wailing manner.

WAILMENT, *n.* Lamentation

WAIN, *n.* [Sax. *wan*, W. *gwain*; contracted. See *WAGGON*.] 1. A waggon; a carriage for the transportation of goods, or for carrying corn, hay, &c., on wheels.—2. A constellation, Charles's Wain.

WAINABLE, *a.* [Suiio-Goth. *waana*, to labour.] Capable of being tilled; as, *wainable* land.

WAINAGE, *n.* A finding of carriages.  
WAIN-BOTE, *n.* Timber for waggons or carts.

WAIN-HOUSE, *n.* A house or shed for waggons and carts. [*Local.*]  
WAIN-ROPE, *n.* A rope for binding a load on a waggon; a cart-rope.

WAINSCOT, *n.* [D. *wagenschot.*] In *arch.*, the timber-work that serves to line the walls of a room, being usually made in panels, to serve instead of hangings. The wood originally used for this purpose was a foreign oak, known by the name of *wagenschot*, and hence the name of the material came

by degrees to be corrupted into *wainscot*, and applied to the work itself. Hence, also, the name *wainscot* is often applied to oak deal.

WAINSCOT, *v. t.* To line with boards; as, to *wainscot* a hall.

Music sounds better in chambers *wain-scotted* than hanged. *Bacon.*

2. To line with different materials. The other is *wainscotted* with looking-glass. *Addison.*

WAINSCOTTED, *pp.* Lined with boards or panels.

WAINSCOTTING, *ppr.* Lining with boards.

WAINSCOTTING, *n.* Wainscot, or the material used for it.—2. The act of covering or lining walls with boards in panels.

WAIR, } *v. t.* To lay out as expense;  
WARE, } to lay out money; to expend;  
to bestow; to waste; to squander. [*Scotch.*]

WAIST, *n.* [W. *gwdsq*, pressure, squeeze, the *waist*, the part where the girle is tied; allied to *squeeze*.] 1. That part of the human body which is immediately below the ribs or thorax; or the small part of the body between the thorax and hips.—2. That part of a ship which is between the quarter deck and fore-castle. But in many ships now built, there is no quarter deck, and in such the waist is the middle part of the ship.

WAISTBAND, *n.* The band or upper part of breeches, trowsers, or pantaloons, which encompasses the waist.

WAISTCLOTHS, *n.* Coverings of canvas or tarpauling for the hammocks, stowed on the gangways, between the quarter deck and the fore-castle.

WAISTCOAT, *n.* [*waist* and *coat*.] A short coat or garment for men, extending no lower than the hips, and covering the waist; a vest.

WAISTER, *n.* In *ships*, waisters are men who are stationed in the waist in working the ship.

WAIT, *v. i.* [Fr. *guetter*; It. *guatare*; W. *gweitiaw*, to wait; *gwaid*, attendance. The sense is to stop, or to continue.] 1. To stay or rest in expectation; to stop or remain stationary, till the arrival of some person or event. Thus we say, I went to the place of meeting, and there *waited* an hour for the chairman. I will go to the hotel, and there *wait* till you come. We will *wait* for the mail.—2. To stay proceeding, or suspend any business, in expectation of some person, event, or the arrival of some hour. The court was obliged to *wait* for a witness.—3. To rest in expectation and patience.

All the days of my appointed time will I *wait*, till my change come; *Job xiv.*

4. To stay; not to depart. Haste, my dear father, 'tis no time to *wait*. *Dryden.*

5. To stay; to continue by reason of hinderance.—6. To lie in ambush, as an enemy.

Such ambush *waited* to intercept thy way. *Milton.*

To *wait on* or *upon*, to attend, as a servant; to perform menial services for; as, to *wait on* a gentleman; to *wait on* the table.—To *wait on*, to attend; to go to see; to visit on business or for ceremony. Tell the gentleman I will *wait on* him at ten o'clock.—2. To pay servile or submissive attendance.—3. To follow, as a consequence; as, the ruin that *waits on* such a supine

temper. [Instead of this we use *await*.]  
4. To look watchfully.

It is a point of cunning to *wait on* him with whom you speak, with your eye. [*Unusual.*] *Bacon*

5. To attend to; to perform. Aaron and his sons shall *wait on* their priest's office; *Numb. iii. viii.*; *Rom. xii.*

6. To be ready to serve; to obey; *Ps. xxv.*; *Prov. xx.* To *wait at*, to attend in service; to perform service at; *1 Cor. ix.* To *wait for*, to watch, as an enemy; *Job xv.*

WAIT, *v. t.* To stay for; to rest or remain stationary in expectation of the arrival of.

Aw'd with these words, in camps they still abide,

And *wait* with longing eyes their promi-s'd guide. *Dryden.*

[Elliptical for *wait for*.]—2. To attend; to accompany with submission or respect.

He chose a thousand horse, the flow'r of all His warlike troops, to *wait* the funeral. *Dryden.*

[*This use is not justifiable, but by poetical license.*]—3. To attend as a consequence of something.

Such doom *waits* luxury.† *Philips.*

[In this sense we use *attend* or *attend on*.]

WAIT, *n.* Ambush. As a noun, this word is used only in certain phrases.—To lie in *wait*, is to lie in ambush; to be secreted in order to fall by surprise on an enemy; hence figuratively, to lay snares, or to make insidious attempts, or to watch for the purpose of insnaring; *Josh. viii.*—In *wait*, is used in a like sense by *Milton*.—To lay *wait*, to set an ambush; *Jer. ix.*

WAITED, *pp.* Stayed for; attended.

WAITER, *n.* One who waits, particularly in a house of public entertainment; an attendant; a servant in attendance.

The *waiters* stand in ranks; the yeomen cry, "Make room!" as if a duke were passing by. *Swift.*

2. A server or salver; a vessel on which tea furniture, &c., is carried.

WAITING, *ppr.* Staying in expectation.—2. *a.* An epithet applied to one who waits.—*Waiting on*, attending; accompanying; serving.—*Waiting for*, staying for the arrival of.—*Waiting at*, staying or attending at in expectation or in service.—*In waiting*, in attendance.

WAITING, *n.* The act of staying in expectation; attendance.

WAITINGLY, *adv.* By waiting.

WAITING-MAID, } *n.* An upper  
WAITING-WOMAN, } servant who attends a lady.

[*Waiting-gentlewoman* is sometimes, though less commonly used.]

WAITRESS, *n.* A female attendant in a public room, or at an inn, &c. [*A useful word, of recent origin.*]

WAITS, *n.* [Goth. *wahits*, watch.] The *waits* were formerly minstrels or musical watchmen, who attended on great men, and sounded the watch at night. At present the name is given to those itinerant musicians who, in most of the large towns in England and Scotland, especially London, go round the principal streets at night for some time before Christmas, play two or three tunes, call the hour, then remove to a suitable distance, where they go through the same ceremony, and so on till four or five o'clock in the morning.

WĀIVE, † *n.* A woman put out of the protection of the law.

WĀIVE, *v. t.* [from *wāif*.] To relinquish; to forsake; not to insist on or claim; to defer for the present; as, to *wāive* a motion; to *wāive* a subject; to *wāive* a claim or privilege.—2. To put out of the protection of the law, as a woman. [See *WAVE*.]

WĀIVED, *pp.* Relinquished, as a claim; put off; omitted. In *law*, a term especially applied to a woman, who, for any crime for which a man may be outlawed, is relinquished or forsaken by the law; that is, put out of its protection.

WĀIVER, *n.* In *law*, the passing by or declining to accept a thing; applied to an estate, or to any thing conveyed to a man; also, to a plea, &c.—2. The legal process by which a woman is *wāived*, or put out of the protection of the law.

WĀIVING, *ppr.* Relinquishing, as a claim; omitting; deferring; depriving of the protection of the law, as a woman.

WĀIWODE, } A Dacian prince; a chief  
VĀIWODE. } of the Danubian provinces of Turkey.

WAKE, *v. i.* [Goth. *wahan*; Sax. *wæcan*; G. *wachen*; L. *vigil*, *vigilo*. The root *wak* is allied to *wag*. The primary sense is to stir, to rouse, to excite. The transitive verb in Saxon is written *wæcan*, *wæcan*; but both are from one root.] 1. To be awake; to continue awake; to watch; not to sleep; Ps. cxvii.

The father *waketh* for the daughter.

*Ecclus.*

Though wisdom *wakes*, suspicion sleeps.

*Milton.*

I cannot think any time, *waking* or sleeping, without being sensible of it. *Locke.*

2. To be excited or roused from sleep; to awake; to be awakened. He *wakes* at the slightest noise.—3. To cease to sleep; to awake.—4. To be quick; to be alive or active.—5. To be excited from a torpid state; to be put in motion. The dormant powers of nature *wake* from their frosty slumbers.

Gentle airs to fan the earth now *wak'd*.

*Milton.*

WAKE, *v. t.* To rouse from sleep.

The angel that talked with me, came again and *waked* me; *Zec. iv.*

2. To arouse; to excite; to put in motion or action.

Prepare war, *wake up* the mighty men; *Joel iii.*

[The use of *up* is common, but not necessary.]

To *wake* the soul by tender strokes of art. *Pope.*

3. To bring to life again, as if from the sleep of death.

To second life

*Wak'd* in the renovation of the just.

*Milton.*

To *wake a corpse*, is to watch it, to sit up with it all night. [See the *noun*.]

WAKE, *n.* The feast of the dedication of the parish church, formerly kept by watching all night. At present most fast days are popularly called *wakes* in the rural districts of England; but the peculiar *wake* of country parishes was originally the day of the week on which the church had been dedicated; afterwards the day of the year. Every rural parish had its *wake* every year, and most of them had two *wakes*, one on the day of dedication, and another on the birthday of the saint to whom the church was dedicated. The festival

of the dedication has long since been entirely discontinued, while the saint's day festival still subsists in some of the rural districts of England, in the altered form of a *country wake*.—2. Vigils; state of forbearing sleep.

Their merry *wakes* and pastimes keep.

*Milton.*

3. The watching of a dead body all night by the friends and neighbours of the deceased; a custom which prevails in Ireland, and was formerly prevalent in Scotland. It most probably originated in a superstitious notion, with respect to the danger of a dead body being carried off by some of the agents of the invisible world, or exposed to the ominous liberties of brute animals. Such *wakes* very early degenerated into scenes of festivity, extremely incongruous to the melancholy occasion.—4. Act of waking. [Old song.]—*Wake of a ship*, the track it leaves in the water, formed by the meeting of the water, which rushes from each side to fill the space which the ship makes in passing through it. This track may be seen to a considerable distance behind the ship's stern, as smoother than the rest of the sea. Hence it is usually observed by the compass, to discover the angle of lee-way. A ship is said to be in the *wake* of another, when she follows her on the same track, or a line supposed to be formed on the continuation of her keel. Two distant objects observed at sea are said to be in the *wake* of each other, when the view of the farthest is intercepted by the nearest, so that the observer's eye and the two objects are all in the same straight line.

WAKED, *pp.* Roused from sleep; put in action.

WAKEFUL, *a.* Not sleeping; indisposed to sleep.

Dissembling sleep, but *wakeful* with the flight. *Dryden.*

2. Watchful; vigilant.

WAKEFULLY, *adv.* With watching or sleeplessness.

WAKEFULNESS, *n.* Indisposition to sleep.—2. Forbearance of sleep; want of sleep.

WAKEN, *v. i.* (wa'kn.) [This seems to be the Saxon infinitive retained.] To wake; to cease to sleep; to be awakened.

Early Tyrrus *wak'nig* with the light.

*Dryden.*

WĀKEN, *v. t.* (wa'kn.) To excite or rouse from sleep.

Go, *waken* Eve. *Milton.*

2. To excite to action or motion. Then Homer's and Tyrræus' martial muse *Waken'd* the world. *Rosecommon.*

3. To excite; to produce; to rouse into action.

They introduce

Their sacred song, and *waken* raptures high. *Milton.*

WĀKENED, *pp.* Roused from sleep; excited into action.

WĀKENER, *n.* One who rouses from sleep.

WĀKENING, *ppr.* Rousing from sleep or stupidity; calling into action.

WĀKENING OF A PROCESS. In *Scots law*, where, at any time, after calling a summons, no judicial proceeding takes place in an action for a year and day, the depending process is said merely to *fall asleep*, and may then be *wakened* or revived at any time within the period of the long prescription, either by written consent

of parties through their counsel, or by an action of *wakening*. This action may be raised at the instance of either party, grounded upon the last step of procedure, and insisting against every defender of a number, in the conclusion proper to him.

WĀKER, *n.* One who watches; one who rouses from sleep.

WĀKE-ROBIN, *n.* A plant of the genus *Arum*, the *A. maculatum*. [See *ARUM*.]

WĀKING, *ppr.* Being awake; not sleeping.—2. Rousing from sleep; exciting into motion or action.—*Waking hours*, the hours when one is awake.

WĀKING, † *n.* The period of being awake.—2. Watch.

WALDEN'SES, *n.* A sect of Christians professing principles which are substantially the same as those of Protestants in general. They are most numerous in the valleys of Piedmont. They were for several centuries the subjects of a most cruel persecution instituted by the Church of Rome. According to the common opinion, the *Waldenses* owe their origin and name to Peter Waldo or Waldus, circa A. D. 1170; but some of their own writers derive the appellation from *vallée* [Fr.], *vaud* [Swiss], hence, also, *vaudois*, or dwellers in the valleys.

WALE, *n.* [This may be the *W. gviden*, a rod or twig, from the same root.]

1. In cloth, a ridge or streak rising above the rest. We say, cloth is wove with a *wale*.—2. A streak or stripe; the mark of a rod or whip on animal flesh.—*Wales of a ship*, an assemblage of strong planks, extending along a ship's sides, throughout the whole length, at different heights, and serving to strengthen the decks and form the curves. They are distinguished into the *main wale* and the *chain wale*.

WALE, *v. t.* To mark with stripes or streaks.

WĀLE, *v. t.* [Suio-Goth. *wælia*, G. *welen*, to choose.] To choose; to select. [Scotch.]

WĀLE, *n.* The act of choosing; the choice; a person or thing that is excellent; the best. [Scotch.]

WĀLED, *a.* Marked with wales.

WĀLE-KNOT, } *n.* In *seamanship*, a  
WĀLL-KNOT, } particular sort of  
large knot raised upon the end of a rope, by untwisting the strands, and interweaving them amongst each other. It is made so that it cannot slip, and serves for shuts, tacks, and stoppers.

WĀL'HĀLLĀ, *n.* (vål'hällä.) [Ger.] In *Scandinavian myth.*,—see *VALHALLA*, which is thus spelt by English writers for the sake of the pronunciation.—2. A remarkable architectural monument, built on the north bank of the Danube, near Ratisbon, intended for a national pantheon, consecrated to all Germans who have established for themselves permanent historical celebrity as warriors, statesmen, philosophers, poets, or in science, or in art. It was commenced October 18, 1830, and finished October 18, 1842, and forms externally a magnificent Doric octastyle peripteral temple, with its principal front facing the river. In the interior it is decorated with the most sumptuous splendour, executed with great originality of design.

WALK, *v. i.* (wauk.) [Sax. *wælcian*, to roll or revolve; *wælcere*, a fuller, whence the name *Walker*; D. *walhen*, to work a hat; G. *walhen*, to full, to felt hats; *walher*, a fuller, Sw. *walkare*;

Dan. *walher*, to full or mill cloth; *walker*, a fuller; *walke*, a pad or stuffed roll; *G. wallen*, to stir, to be agitated, to rove, to travel, to wander. From the same root are Russ. *valyu*, *G. wälzen*, to roll, and *wälisch*, foreign, Celtic, Welsh, that is, wanderers. The primary sense is simply to move or press, but appropriately, to roll, to press by rolling, as in hatting, and this is the origin of *walker*, for the practice of felting hats must have preceded that of fulling cloth in mills. Our ancestors appropriated the verb to moving on the feet, and the word is peculiarly expressive of that rolling or wagging motion which marks the walk of clownish people. Qu. Heb.  $\text{וָלַח}$ , *yalach*.]

1. To move slowly on the feet; to step slowly along; to advance by alternate steps moderately repeated; as animals. As applied to a horse, to move with the slowest pace. *Walking* in men differs from running only in the rapidity and length of the steps; but in quadrupeds, the motion or order of the feet is sometimes changed.

At the end of twelve months, he *walked* in the palace of the kingdom of Babylon; Dan. iv.

When Peter had come down out of the ship, he *walked* on the water, to go to Jesus; Matth. xiv.

2. To move or go on the feet for exercise or amusement. Hundreds of students daily *walk* on Downing terrace, in Cambridge.—3. To appear, as a spectre.

The spirits of the dead  
May *walk* again. *Shak.*

4. To act on any occasion.  
Do you think I'd *walk* in any plot? *B. Jonson.*

5. To be in motion, as a clamorous tongue.

Her tongue did *walk*  
In foul reproach. *Spenser.*

6. To act or move on the feet in sleep.  
When was it she last *walk'd*? *Shak.*  
[But this is unusual. When we speak of somnambulation, we say, to *walk* in sleep.]—7. To range; to be stirring.

Affairs that *walk*  
As they say spirits do at midnight. [*Unusual.*] *Shak.*

8. To move off; to depart.  
When he comes forth, he will make their cows and garrans *walk*. [*Not elegant.*] *Spenser.*

9. In *scrip.*, to live and act or behave; to pursue a particular course of life.—*To walk with God*, to live in obedience to his commands, and have communion with him; Gen. v.—*To walk in darkness*, to live in ignorance, error and sin, without comfort; 1 John i.—*To walk in the light*, to live in the practice of religion, and to enjoy its consolations; 1 John i.—*To walk by faith*, to live in the firm belief of the gospel and its promises, and to rely on Christ for salvation; 2 Cor. v.—*To walk through the fire*, to be exercised with severe afflictions; Isa. xliii.—*To walk after the flesh*, to indulge sensual appetites, and to live in sin; Rom. viii.—*To walk after the Spirit*, to be guided by the counsels and influences of the Spirit and by the word of God, and to live a life of holy deportment; Rom. viii.—*To walk in the flesh*, to live this natural life, which is subject to infirmities and calamities; 2 Cor. x.—*To walk in*, to enter, as a house. *Walk in*, gentlemen.

*WALK, v. t.* (wauk.) To pass through or upon; as, to *walk* the streets. [This is elliptical for to *walk in* or *through* the streets.]—2. To cause to walk or step slowly; to lead, drive, or ride with a slow pace. He found the road so bad he was obliged to *walk* his horse.—*To walk yarn or cloth*, is to tread it; to press it, and hence to thicken it. [*Local.*]

*WALK, n.* (wauk.) The act of walking; the act of moving on the feet with a slow pace.—2. The act of walking for air or exercise; as, a morning *walk*; an evening *walk*.—3. Manner of walking; gait; step. We often know a person in a distant apartment by his *walk*.—4. Length of way or circuit through which one walks; or a place for walking; as, a long *walk*; a short *walk*. The gardens of the Tuileries and of the Luxembourg are very pleasant *walks*.—5. An avenue set with trees.—6. Way; road; range; place of wandering.

The mountains are his *walks*. *Sandys.*  
The starry *walks* above. *Dryden.*  
7. Region; space.

He opened a boundless *walk* for his imagination. *Pope.*

8. Course of life or pursuit. This is not within the *walk* of the historian.—

9. The slowest pace of a horse, ox, or other quadruped.—10. A fish. [A mistake for *whelk*.]—11. In the *West Indies*, a plantation of canes, &c. A *sheep walk*, so called, is high and dry land where sheep are pastured.

*WALKABLE, a.* (wauk'able.) Fit to be walked on. [*Not much used.*]

*WALKER, n.* (wauk'er.) One who walks.—2. A fuller. [*Local.*]—3. In *law*, a forest officer appointed to walk over a certain space for inspection; a forester.—4. One who deports himself in a particular manner.

*WALK'ERA, n.* A genus of plants, so named in honour of Richard Walker, founder of the botanic garden at Cambridge; nat. order, Ochnaceæ. *W. serrata* is a native of Malabar and Ceylon. The roots and leaves are bitter; and are employed in Malabar in decoction, in milk or water, as a tonic, stomachic, and anthelmintic. *W. integrifolia*, the only other species, is a native of French Guiana.

*WALK'ING, ppr.* (wauk'ing.) Moving on the legs with a slow pace; moving; conducting one's self.

*WALK'ING, n.* (wauk'ing.) The act of moving on the feet with a slow pace.

*WALK'ING-STAFF, } n.* A staff or  
*WALK'ING-STICK, }* stick carried in the hand for support or amusement in walking.

*WALK'ING WHEEL, n.* A cylinder which is made to revolve about an axle, by the weight of men or animals climbing by steps either its external or internal periphery; and is employed for the purpose of raising water, grinding corn, and various other operations for which a moving power is required. [*See TREAD-WHEEL.*]

*WALK-MILL, n.* (wauk'-mill.) A fulling mill. [*Local.*]

*WALL, n.* [*L. vallum*; Sax. *weal*; *D. wal*; *G. wall*; Ir. and Gaelic, *balla* and *fal*; Russ. *val*; W. *gwal*. In *L. vallus* is a stake or post, and probably *vallum* was originally a fence of stakes, a palisade or stockade; the first rude fortification of uncivilized men. The primary sense of *vallus* is a shoot, or

that which is set, and the latter may be the sense of *wall*, whether it is from *vallus*, or from some other root.]

1. A work or structure of stone, brick, or other materials, raised to some height, serving to enclose a space, form a division, support superincumbent weights, &c., and affording a defence, shelter, or security.—*Walls* of stone, with and without mortar, are much used for fences or enclosures on farms; *walls* form the most important part of any building, serving to enclose the whole, and to support the roof, and the floors.—*Walls* are also often raised round cities and forts as a defence against enemies.—2. *Walls*, in the plural, is used for fortifications in general; works for defence.

I rush undaunted to defend the *wall*.  
*Dryden.*

3. A defence; means of security or protection; 1 Sam. xxv.—*To take the wall*, to pass next to the wall; to take the upper or most honourable place.

I will take the *wall* of any man or maid of Montague's. *Shak.*

*To keep the wall*, to pass next to the nearest wall, in public ways, when meeting other passengers; as, in large towns there is a regulation that pedestrians, when passing towards the right side, shall *keep the wall*. [*See RIGHT, def. 13.*]

*WALL, v. t.* To inclose with a wall; as, to *wall* a city.—2. To defend by walls.

And terror of his name that *walls* us in from danger. *Denham.*

3. To fill up with a wall.  
*WALL'-CREEPER, n.* A bird of the genus *Certhia*, Linn., the *C. muraria*.



Wall-creeper (*Certhia muraria*).

Its principal residence is in Italy and Spain, where it is observed to frequent ruins, the clefts and crevices of rocks, on the surfaces of which it sticks firmly. It feeds on insects, their larvæ and pupæ, and is particularly fond of spiders and their eggs; hence, it is sometimes popularly called the *spider-catcher*.

*WALL'-CRESS, n.* [*wall* and *cress.*] The common name of the different species of plants belonging to the genus *Arabis*; nat. order, Cruciferae. The species are numerous; most of them are small plants, growing in dry stony places, and on walls. Several are natives of Great Britain, and many of them are cultivated in gardens on rock-work and flower-borders, or account of their blooming early in spring.

**WALLED**, *pp.* Inclosed or fortified with a wall.

**WALLER**, *n.* One who builds walls in the country.

**WALL'ERITE**, *n.* A mineral, or variety of clay, found in small compact masses of the size of a nut, white and opaque, or yellowish and translucent.

**WALLET**, *n.* A bag for carrying the necessaries for a journey or march; a knapsack.—2. Any thing protuberant and swagging; as, *wallets* of flesh.

**WALLETEE'R**, *n.* One who bears a wallet; a trampler. [*Trivial.*]

**WALL'-EYE**, *n.* [*wall and eye.*] In horses, an eye in which the iris is of a very light gray or whitish colour.

**WALL'-EYED**, *a.* In horses, having an eye of a very light gray or whitish colour. In the *North of England*, persons are said to be *wall-eyed*, when the white of the eye is very large and distorted, or on one side. According to Richardson, *wall*, in this case, which is also found written *whall*, *whally*, is from Sax. *hwelan*, to wither, to pine away, in allusion to the faded colour or unnatural appearance of such eyes. Shakespeare uses *wall-eyed* as a term of reproach; as, *wall-eyed* rage, a *wall-eyed* wretch, alluding probably to the idea of unnatural or distorted vision. Hence a *wall-eye*, in this case, may signify one which is utterly and incurably perverted; an eye that knows no pity.

**WALL'-FLOWER**, *n.* [*wall and flower.*]

The common name of the species of plants belonging to the genus *Cheiranthus*; nat. order, Cruciferae. They are biennial or perennial herbs, or undershrubs. Many of them exhale a delicious odour, and are great favourites in gardens. The most abundant is the *C. cheiri*, or common wall-flower, which, in its wild state, grows on old walls, and stony places. In the cultivated plant the flowers are of various and brilliant colours, and attain a much larger size than in the wild plant. A number of distinct varieties have been recorded, and double and semi-double varieties are common in gardens.

**WALL'-FRUIT**, *n.* [*wall and fruit.*] Fruit which, to be ripened, must be planted against a wall.

**WALL'ING**, *ppr.* Inclosing or fortifying with a wall.

**WALL'ING**, *n.* Walls in general; materials for walls.

**WALL-KNOT**. See **WALE-KNOT**.

**WALL-LET'TUCE**, *n.* A plant of the genus *Prenanthes*, the *P. muralis*. [*See PRENANTHES.*]

**WALL'-LOUSE**, *n.* [*wall and louse.*] An insect or small bug.

**WALL'-MOSS**, *n.* A species of moss growing on walls.

**WALLOO'N**, *n.* A native of that part of Belgium situated between the rivers Scheldt and Lys.—2. The language of the same territory.

**WALLOO'N**, *a.* Relating to the *Wal-loons*; as, the *Walloon* language.

**WAL'LOP**, *v. t.* To castigate. [*Low.*]

**WAL'LOP**, *v. i.* [formed on *G. wallen* Sax. *wælan*, to boil or bubble; *D. opwallen*; Eng. to *well*. See **WELL**.] To boil with a continued bubbling or heaving and rolling of the liquor, with noise.—2. In the *Scottish dialect*, to move quickly or dance with much agitation of the body or clothes.

**WAL'LOPER**. See **POT-WALLOPERS**.

**WAL'LOPING**, *n.* A castigation. [*Vulgar.*]

**WAL'LOPING**, *ppr.* Boiling with a heaving and noise.

**WAL'LOW**, *v. i.* [*Sax. wælcian*; *Sw. wälfa*; *Goth. walugan*; *G. walzen*. The latter is the Eng. *weller*, but of the same family; *L. volvo*; *Sp. volver*; *Russ. valyu, baliayu*. This verb seems to be connected with *well*, *walk*, &c.] 1. To roll one's body on the earth, in mire, or on other substance; to tumble and roll in water. Swine *wallow* in the mire.—2. To move heavily and clumsily.

Part huge of bulk,

*Wallowing* unwieldy, enormous in their gait,

Tempest the ocean. [*Unusual.*] *Milton.*

3. To live in filth or gross vice; as, man *wallowing* in his native impurity.

**WAL'LOW**, *v. t.* To roll one's body.

*Wallow* thyself in ashes; *Jer. vi.*

**WAL'LOW**, *n.* A kind of rolling walk.

**WAL'LOWED**, *pp.* Rolled in the mire.

**WAL'LOWER**, *n.* One that rolls in mire.—2. A wheel that turns the trundle-head in a mill.

**WAL'LOWING**, *ppr.* Rolling the body on any thing.

**WAL'LOWISH**, *† a.* Filthy; grossly; sensual.

**WALL-PEL'LITORY**, *n.* A plant of the genus *Parietaria*, the *P. officinalis*. [*See PARIETARIA.*]

**WALL-PEN'NYWORT**, *n.* A plant of the genus *Cotyledon*, the *C. umbilicus*, Linn., called also *Navel-wort*,—*which* see.

**WALL'-PEPPER**, *n.* A plant of the genus *Sedum*, the *S. acre*, Linn. The whole plant is intensely acrid, and is said to be useful in scrofula. It grows on rocks and walls. [*See SEDUM.*]

**WALL'-PLATE**, *n.* In *arch.*, a piece of timber placed horizontally in or on a wall, under the ends of girders, joists, and other timbers.

**WALL'-RUE**, *n.* A plant of the genus *Asplenium*, the *A. ruta muraria*.

**WALL'-SIDED**, *n.* Having sides nearly perpendicular, as a ship.

**WALL-SPLEEN'WÖRT**, *n.* A plant of the genus *Asplenium*, the *A. trichomanes*.

**WALL'-SPRING**, *n.* A spring of water issuing from stratified rocks.

**WALL-WÖRT**, *n.* A plant, the dwarf elder or danewort; *Sambucus ebulus*.

**WALNUT**, *n.* [*D. walnoot*; *Sax. walh*, foreign, and *hnuta*, nut. The Germans call it *wälsche nuss*, Welsh nut, that is, foreign or Celtic nut.] The common name of the species of plants of the genus *Juglans*; nat. order, *Juglandaceae*. All the species are large trees. The

tive of Persia. It is a large handsome tree with strong spreading branches. In France and Germany the wood is much used by turners, cabinet-makers, joiners, coach-makers, and musical-instrument makers; but one of the most important uses of walnut timber is the making of gun-stocks, for which it is considered preferable to any other timber. In this country, however, the walnut-tree is more cultivated for its fruit than its timber. Walnuts are used for the table in almost every stage of their growth. The cotyledons of the seed of the walnut contain an oil, which is used in large quantities, especially on the Continent, by artists and also for lamps. Almost all parts of the plant possess a bitter principle, which acts as a tonic and anthelminthic. There are several distinct varieties of the walnut-tree. Two species are natives of North America, viz. *J. nigra*, or black walnut, and *J. cinerica*, or butternut.

Some woods have the velv smooth as fir and *walnut*. *Bacon.*

**WAL'RUS**, *n.* [*G. wall*, as in *walffisch*, a whale, and *ross*, a horse.] The morse, sea-horse or sea-cow, a marine carnivorous mammal, inhabiting the arctic seas, and belonging to the seal family, or Phocidæ. It is the *Trichecus rosmarus*, the only species of its genus. It surpasses the largest ox in size, attaining to the length of twenty feet. It is covered with short yellowish hair. It is sought for, on account of its oil and tusks, the ivory of which, though rough-grained, is employed in the arts. The skin is used for coach-braces.—[For a figure of walrus, see *Monse.*]

**WAL'TRON**, *n.* Another name of the walrus.

**WALTZ**, *n.* [*G. walzen*, to roll.] The name of the national German dance, and also of the species of music with which it is accompanied. It is common, however, among other nations of the Continent, and has been introduced into this country. The waltz is a gay dance, in triple time, and is performed by two persons, who, almost embracing each other, whirl rapidly round on an axis of their own, while at the same time they move quickly in a circle, whose radius is from 10 to 12 feet, according to the dimensions of the room. The music is always written in  $\frac{3}{4}$  or  $\frac{3}{8}$  time.

**WALTZ**, *v. i.* To dance a waltz.

**WALTZER**, *n.* A person who waltzes.

**WALTZ'ING**, *n.* The act of dancing a waltz.

**WA'LY**, } *a.* Beautiful; excellent;

**WA'LY**, } large; ample. [*Scotch.*]

**WA'LY**. An interjection, expressive of lamentation. [*Scotch.*]

**WAM'BLE**, } *v. i.* [*D. wemelen*; Dan.

**WAM'MLE**, } *vamlr*; *Sw. wamjaz.*]

**WAM'MEL**, } To be disturbed with

nausea; as, a *wambling* stomach.

[*Vulgar.*]

When your cold salads, without salt or vinegar, be *wambling* in your stomachs.

*Beaumont and Fletcher.*

2. In the *Scottish dialect*, to move in an undulating manner, like an eel in the water.

**WAM'BLE-CROPPED**, *a.* Sick at the stomach.

**WAME**, *n.* [*Sax. wamb.*] The belly.

[*Scotch.*]

**WAMPEE'**, *n.* A tree and its fruit, of the genus *Cookia*, the *C. punctata*, nat.



Walnut-tree (*Juglans regia*).

best known species is the royal or common walnut-tree (*J. regia*), a na-  
1197

order, Aurantiaceæ. The fruit is about the size of a pigeon's egg, grows in



Wampee (*Coccinia punctata*).

bunches, and is much esteemed in China and the Indian Archipelago. **WAMPUM**, *n.* Shells or strings of shells, used by the American Indians as money or a medium of commerce. These strings of shells, when united, form a broad belt, which is worn as an ornament or girdle. It is sometimes called wampumpeague, wompeague, or wampampeague, of which *wampum* seems to be a contraction. **WAN**, *a.* [Sax. *wan*, *wann*, deficient; *wanion*, to fail, to *wane*; *wan*, pale, that is, deficient in colour; allied probably to *vain*. Qu. W. *gwán*, weak, and *gwyn*, white. The primary sense is to withdraw or depart.] Pale; having a sickly hue; languid of look.

Sad to view, his visage pale and *wan*.  
Spenser.  
Why so pale and *wan*, fond lover.  
Suckling.

**WAN**, † for *Wan*; pret. of *Win*.  
**WANCHAN' CIE**, *a.* Unlucky. [Scotch.]  
**WAND**, *n.* [D. *vaand*.] 1. A small stick or twig; a rod. If a child runs away, a few strokes of a wand will bring him back.—2. A staff of authority; as, a silver *wand*.—3. A rod used by conjurors or diviners.

Picus bore a buckler in his hand,  
His other wav'd a long divining *wand*.  
Dryden.

**WANDER**, *v. i.* [Sax. *wandrian*; D. *wandelen*, to walk; G. *wandeln*, to wander, to walk, to change, exchange, or transform; Sw. *wanda*, to turn; *wandra*, to wander; Dan. *vandler*, to walk, to wander, to trade; *vandel*, behaviour, deportment, conversation; It. *andare*, Sp. and Port. *andar*, to go; Sans. *andara*, a wanderer.] 1. To rove; to ramble here and there without any certain course or object in view; as, to *wander* over the fields; to *wander* about the town or about the country. Men may sometimes *wander* for amusement or exercise. Persons sometimes *wander* because they have no home and are wretched, and sometimes because they have no occupation.

They *wandered* about in sheep-skins and goat-skins; Heb. xi.

He *wandereth* about for bread; Job xv.  
He was *wandering* in the field; Gen. xxxvii.

2. To leave home; to depart; to migrate.

When God caused me to *wander* from my father's house; Gen. xx.

3. To depart from the subject in discussion; as, to *wander* from the point.—4. In a moral sense, to stray; to de-

viate; to depart from duty or rectitude.

O let me not *wander* from thy commandments; Ps. cxix.

5. To be delirious; not to be under the guidance of reason; as, the mind *wanders*.

**WAND'ER**, *v. t.* To travel over without a certain course.

*Wand'ring* many a famous realm.  
[Elliptical.] Milton.

**WAND'ERED**, *pp.* Rambled; travelled over rovingly; deviated from duty.

**WAND'ERER**, *n.* A rambler; one that roves; one that deviates from duty.

**WAND'ERING**, *ppr.* or *a.* Roving; rambling; erratic; deviating from duty; disordered in mind.

**WAND'ERING**, *n.* Peregrination; a travelling without a settled course.—

2. Aberration; mistaken way; deviation from rectitude; as, a *wandering* from duty.—3. A roving of the mind or thoughts from the point or business in which one ought to be engaged.—

4. The roving of the mind in a dream.—

5. The roving of the mind in delirium.—

6. Uncertainty; want of being fixed.

**WAND'ERINGLY**, *adv.* In a wandering or unsteady manner.

**WAND'ERMENT**, † *n.* Act of wandering.

**WANDEROO'**, *n.* A baboon of Ceylon and Malabar, the *Macacus silenus* of

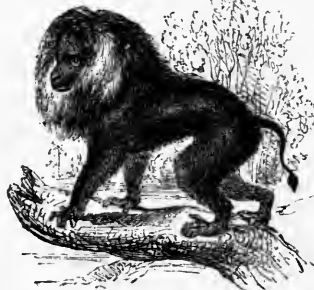

Wanderoo Baboon (*Macacus silenus*).

*Lacepede*. It has a long beard or mane of a greyish or whitish colour, which descends on each side of the face like a ruff. The rest of the body is of a deep black colour, and the tail ends in a brush of tufted hair.

**WAND'LIKE**, *n.* In *bot.*, an epithet applied to a stem, which is slender, long, straight, and tapering; as in *Althea officinalis*.

**WAND'Y**, *a.* Long and flexible, like a wand.

**WANE**, *v. i.* [Sax. *wanian*, to fail, fall off or decrease.] 1. To be diminished; to decrease; particularly applied to the illuminated part of the moon. We say, the moon *wanes*, that is, the visible or illuminated part decreases.

*Waning* moons their settled periods keep.  
Addison.

2. To decline; to fall; to sink; as, the *waning* age of life.

You saw but sorrow in its *waning* form.  
Dryden.

Land and trade ever will wax and *wane* together.  
Child.

**WANE**, † *v. t.* To cause to decrease.

**WANE**, *n.* Decrease of the illuminated part of the moon, to the eye of the

spectator.—2. Decline; failure; diminution; decrease; declension.

You are cast upon an age in which the church is in its *wane*.  
South.

**WANED**, *pp.* Caused to decrease; diminished.

**WANG**, *n.* [Sax. *wang*, *weng*, *wong*.] 1. The jaw, jaw-bone, or cheek-bone. [Little used or vulgar.]—2. † The latchet of a shoe. [Sax. *scoo-thwang*, shoethong.]

**WANGHEE'**, *n.* A species of tough, flexible cane, imported from China, sometimes called the *Japan cane*.

**WANG-TOOTH**, *n.* A jaw-tooth.

**WAN'HOPE**, † *n.* Want of hope.

**WAN'HORN**, *n.* A plant of the genus *Kæmpferia*.

**WANING**, *ppr.* Decreasing; failing; declining.

**WAN'KLE**, *a.* Weak; unstable; not to be depended on. [North of England.]

**WAN'LY**, *adv.* In a pale manner; palely.

**WAN'NED**, *a.* Made wan or pale.

**WAN'NESS**, *n.* Paleness; a sallow, dead, pale colour; as, the *wanness* of the cheeks after a fever.

**WAN'NISH**, *a.* Somewhat wan; of a pale hue.

**WANT**, *n.* (want.) [Sax. *wan*, supra; *wanian*, to fail; Goth. *wan*, deficiency, want. This seems to be primarily a participle of *wane*.] 1. Deficiency; defect; the absence of that which is necessary or useful; as, a *want* of power or knowledge for any purpose; *want* of food and clothing. The *want* of money is a common *want*; 2 Cor. viii. ix.

From having wishes in consequence of our *wants*, we often feel *wants* in consequence of our wishes.  
Rambler.

2. Need; necessity; the effect of deficiency.

Pride is as loud a beggar as *want*, and more sassy.  
Franklin.

3. Poverty; penury; indigence.

Nothing is so hard for those who abound in riches as to conceive how others can be in *want*.  
Swift.

4. The state of not having. I cannot write a letter at present for *want* of time.—5. That which is not possessed, but is desired or necessary for use or pleasure.

Habitual superfluities become actual *wants*.  
Paley.

6. A mole.

**WANT**, *v. t.* (want.) To be destitute; to be deficient in; not to have; a *word of general application*; as, to *want* knowledge; to *want* judgment; to *want* learning; to *want* food and clothing; to *want* money.—2. To be defective or deficient in. Timber may *want* strength or solidity to answer its purpose.—3. To fall short; not to contain or have. The sum *wants* a shilling of the amount of debt.

Nor think, though men were none,  
That heaven would *want* spectators, God  
*want* praise.  
Milton.

4. To be without.

The unhappy never *want* enemies.  
Richardson.

5. To need; to have occasion for, as useful, proper, or requisite. Our manners *want* correction. In winter we *want* a fire; in summer we *want* cooling breezes. We all *want* more public spirit and more virtue.—6. To wish for; to desire. Every man *wants* a little pre-eminence over his neighbour. Many *want* that which they cannot obtain,



and which, if they could obtain, would certainly ruin them.

What *wants* my son? *Addison.*  
WANT, v. i. (want.) To be deficient; not to be sufficient.

As in bodies, thus in souls, we find  
What *wants* in blood and spirits, swell'd  
with wind. *Pope.*

2. To fail; to be deficient; to belacking. No time shall find me *wanting* to my truth.  
*Dryden.*

3. To be missed; not to be present. The jury was full, *wanting* one.—4. To fall short; to be lacking.

Twelve, *wanting* one, he slew. *Dryden.*  
WANT'AGE, n. Deficiency; that which is *wanting*.

WANTED, pp. Needed; desired.

WANT'ING, ppr. Needing; lacking; desiring.—2. a. Absent; deficient. One of the twelve is *wanting*. We have the means, but the application is *wanting*.

—3. Slack; deficient. I shall not be *wanting* in exertion.

WANT'LESS, a. Having no want; abundant; fruitful.

WANTON, a. [W. *wantan*, apt to run off, variable, fickle, wanton; *wantu*, to thrust, to sever; allied probably to *wander*.] 1. Wandering or roving in gayety or sport; sportive; frolicsome; darting aside, or one way and the other. *Wanton* boys kill flies for sport.

Note a wild and *wanton* herd. *Shak.*  
2. Moving or flying loosely; playing in the wind.

She

Her unadorned golden tresses wore  
Dishevel'd, but in *wanton* ringlets wav'd.

*Milton.*

3. Wandering from moral rectitude; licentious; dissolute; indulging in sensuality without restraint; as, men grown *wanton* by prosperity.

My plenteous joys,

*Wanton* in fullness. *Shak.*  
4. More *appropriately*, deviating from the rules of chastity; lewd; lustful; lascivious; libidinous.

Thou art froward by nature, enemy to peace,

Lascivious, *wanton*. *Shak.*

Ye have lived in pleasure on the earth, and been *wanton*; James v.

5. Disposed to unchastity; indicating wantonness; Isa. iii.—6. Loose; unrestrained; running to excess.

How does your tongue grow *wanton* in her praise!

7. Luxuriant; overgrown. *Addison.*

What we by day lop overgrown,  
One night or two with *wanton* growth de-

rides,  
Tending to wild. *Milton.*

8. Extravagant; as, *wanton* dress.—9. Not regular; not turned or formed with regularity.

The quaint mazes in the *wanton* green.

*Milton.*

WANTON, n. A lewd person; a lascivious man or woman.—2. A trifter; an insignificant flutterer.—3. A word of slight endearment.

Peace, my *wanton*. [*Little used.*]

*B. Jonson.*

WANTON, v. i. To rove and ramble without restraint, rule, or limit; to revel; to play loosely.

Nature here

*Wanton'd* as in her prime. *Milton.*  
Her golden tresses *wanton* in the wind.

*Anon.*

2. To ramble in lewdness; to play lasciviously.—3. To move briskly and irregularly.

WANTON,† v. t. To make wanton.

WANTONING, ppr. Roving; flying loosely; playing without restraint; indulging in licentiousness.

WANTONIZE,† v. i. To behave wantonly.

WANTONLY, adv. Loosely; without regularity or restraint; sportively; gayly; playfully; lasciviously.

WANTONNESS, n. Sportiveness; gayety; frolicsomeness; waggery.

As sad as night,

Only for *wantonness*. *Shak.*

2. Licentiousness; negligence of restraint.

The tumults threatened to abuse all acts of grace, and turn them into *wantonness*.

*K. Charles.*

3. Lasciviousness; lewdness; Rom. xiii.; 2 Pet. ii.

WANT-WIT, n. [*want* and *wit*] One destitute of wit or sense; a fool. [*Not in much use.*]

WANTY, n. [D. *want*, cordage; tackling. Qu.] A leather tie or rope; a short waggon rope; a rope used for binding a load upon the back of a beast. [*Local.*]

WAP'ACUT, n. The spotted owl of Hudson's bay, *Strix Wapacuthu*, a nocturnal accipitrine bird of prey, about two feet long.

WAP'ED,† } a. [Sax. *wafian*, to  
WAP'ENED,† } be amazed or astonished.] Dejected; crushed; amazed. The first of these words, used by Chaucer, has certainly the foregoing import; the second, occurring in Timon of Athens, is variously interpreted.

This makes the *wappened* widow wed again.

*Shak.*

WAP'ENSHAW, } n. [Sax. *waepen*, and  
WAP'INSCHAW, } *sceawian*, to shew.] An exhibition of arms, according to the rank of the individual, made formerly at certain times in every district. These exhibitions or meetings were not designed for military exercises, but only for showing that the lieges were properly provided with arms. [*Scotch.*]

WAP'ENTAKE,† } n. [Sax. *wapen-tac*;  
WAP'ENTAC, } but it is rather Gothic, as this division of a county was peculiar to the northern counties; *wapen*, a weapon, and *tac*, *tace*, touch; Goth. *tekan*. See TOUCH.] Yorkshire is divided into *wapentakes* instead of hundreds. In some northern counties of England, a division or district, answering to the hundred or cantred in other counties. The name was first given to the meeting, supra.

WAP'ITI, n. This word is used in books



Wapiti (*Cervus canadensis*).

for the North American stag, *Cervus Canadensis*, which more nearly resem-

bles the European red deer in colour, shape, and form, than it does any other of the cervine race, though it is much larger and of a stronger make. It is, in fact, the most gigantic of the deer genus, frequently growing to the height of our tallest oxen. Its flesh is not much prized, but its hide, when made into leather, after the Indian fashion, is said not to turn hard in drying, after being wet.

WAPP, n. In a ship, the rope with which the shrouds are set taught in wale-knots.

WAPPATO, n. An esculent root of western America.

WAP'PE, } n. A species of cur, said  
WAP'PET, } to be so called from his voice. His only use is to alarm the family by barking when any person approaches the house. [*Local.*]

WAP'PER, n. A fish; a name given to the smaller species of the river gudgeon.

WAR, n. (waur.) [Sax. *wear*; Fr. *guerre*; D. *warren*, to quarrel, wrangle, entangle; Dan. *virrer*; G. *verwirren*, to perplex, embroil, disturb. The primary sense of the root is to strive, struggle, urge, drive, or to turn, to twist.] 1. A contest between nations or states, carried on by force, either for defence, or for revenging insults and redressing wrongs, for the extension of commerce or acquisition of territory, or for obtaining and establishing the superiority and dominion of one over the other. These objects are accomplished by the slaughter or capture of troops, and the capture and destruction of ships, towns, and property. Among rude nations, war is often waged and carried on for plunder. As war is the contest of nations or states, it always implies that such contest is authorized by the monarch or the sovereign power of the nation. When war is commenced by attacking a nation in peace, it is called an *offensive* war, and such attack is *aggressive*. When war is undertaken to repel invasion or the attacks of an enemy, it is called *defensive*, and a defensive war is considered as justifiable. When war arises between different portions or members of the same nation, or between the established government of a nation, and a portion of the people resisting it, it is called a *civil* war. Very few of the wars that have desolated nations and deluged the earth with blood, have been justifiable. Happy would it be for mankind, if the prevalence of Christian principles might ultimately extinguish the spirit of war, and if the ambition to be great might yield to the ambition of being good.

Preparation for war is sometimes the best security for peace. *Anon.*

2. In *poetical* lan., instrments of war  
His compliment of stores, and total war.

*Prior.*

3. *Poetically*, forces; army.  
O'er the embattled ranks the waves return  
And overwhelm their war. *Milton.*

4. The profession of arms; art of war; as, a fierce man of war; Is. ii.—5. Hostility; state of opposition or contest; act of opposition.—6. Enmity; disposition to contention.

The words of his mouth were smoother than butter, but war was in his heart; Ps. lv.

Man-of-war, in *naval* affairs, a ship of large size, armed and equipped for attack or defence.—*Holy* war, a crusade; a war undertaken to deliver the Holy

Land, or Judea, from infidels. These *holy wars* were carried on by most unholy means.—*Rights of war*, certain immunities and privileges which belligerent parties, in accordance with the law of nations, allow to each other; such as sparing the lives of those subjects of a hostile state who are not in arms, or who have submitted, the exchanging of prisoners, &c.—*Declaration of war*, an official notification given by one nation or state to another, to the effect that the former is about to engage in war with the latter. In this country, as in most monarchical governments, the right of declaring war belongs to the sovereign; but formal declarations of war are in modern times out of use, and war is now usually announced by the publication of what is termed a manifesto, the last preliminary step, short of actual hostilities, being the permission of reprisals.—*Council of war*, an assembly of great officers, called by a general or commander, to deliberate with him on enterprises and attempts to be made. The term is sometimes applied also to an assembly of officers sitting in judgment on delinquent soldiers, deserters, coward officers, &c.—*Honours of war*, distinctions granted to a vanquished enemy, as of marching out from a camp or intrenchments with all the insignia of military etiquette. Also, the compliments paid to great personages when they appear before an armed body of men; likewise, such as are paid to the remains of a deceased officer.—*Secretary-at-war*. [See SECRETARY.]

WAR, *v. i.* To make war; to invade or attack a nation or state with force of arms; to carry on hostilities; or to be in a state of contest by a violence.

He teacheth my hands to war; 2 Sam. xxii.

And they warred against the Midianites; Numb. xxxi.

Why should I war without the walls of Troy? Shak.

2. To contend; to strive violently; to be in a state of opposition.

Lusts which war against the soul; 1 Pet. ii.

WAR, *v. t.* To make war upon; as, to war the Scot.—2. To carry on a contest.

That thou mightest war a good warfare; 1 Tim. i.

WAR-BEAT, } *a.* [war and beat.]  
WAR-BEATEN, } Worn down in war; war-worn; invalid.

WAR-BEREAVED, *a* Bereaved by war.

WARBLE, *v. t.* [G. *wirbeln*, to turn, whirl, warble; *wirbel*, a whirl, a vortex; *wirbelbein*, a turning bone or joint, L. *vertebra*; Dan. *hvirvler*, Eng. to whirl. These words are all of one family; L. *verto*, Eng. *veer*, *vary*, &c.] 1. To quaver a sound or the voice; to modulate with turns or variations. Certain birds are remarkable for warbling their songs.—2. To cause to quaver.

And touch the warbled string. Milton.

3. To utter musically; to be modulated. If she be right invok'd with warbled song.

Warbling sweet the nuptial lay. Trumbull.

WARBLE, *v. i.* To be quavered or modulated.

Such strains ne'er warble in the linnet's throat. Gay.

2. To be uttered melodiously; as, warbling lays.

For warbling notes from inward cheering flow. Sidney.

3. To sing. Birds on the branches warbling. Milton.

WAR'BLE, *n.* A quavering modulation of the voice; a song.

WAR'BLE, *pp.* Quavered; modulated; uttered musically.

WAR'BLER, *n.* A singer; a songster; used of birds.

In lulling strains the feathered warblers woo. Tickel.

WAR'BLERS, *n.* The common name of a genus (*Sylvia*), or rather of a family (*Sylviadae*), of small passerine birds, comprising most of the small woodland songsters of Europe and North America, and species of them are spread over the whole globe. Their bill is slender, straight, awl-shaped, higher than it is wide at the base, and furnished with short bristles, the lower mandible straight. They are generally small, sprightly, and endowed with an incessant activity, in accordance with the subtleness of their flying insect prey. They principally inhabit forests or thickets, and some affect watery situations or reed-marshes. Many are remarkable for the melody of their song, and the sprightliness of their airs, which, in the period of incubation, they almost incessantly pour forth. The nightingales, robin-redbreasts, wheatears, whinchats, stonechats, redstarts, accentors, Dartford warbler, &c., belong to this family.

WAR'PLES, } *n.* In farriery, small  
WAR'PLETS, } hard tumours on the backs of horses, occasioned by the heat of the saddle in travelling, or by the uneasiness of its situation; also, small tumours produced by the larvae of the gad fly, in the backs of horses, cattle, &c.

WAR'BLING, *ppr.* Quavering the voice; modulating notes; singing.—2. *a.* Filled with musical notes; as, the warbling glade.

WAR'BLING, *n.* The act of shaking or modulating notes; singing.

WAR'BLINGLY, *adv.* In a warbling manner.

WAR-COUNCIL, *n.* A council of war.

WAR-CRY, *n.* A cry or alarm of war.—2. A term or phrase of recognition, or for rallying, during action.

WARD, in composition, as in *toward*, *homeward*, is the Sax. *weard*, from the root of L. *verto*, &c. It corresponds to the L. *versus*.

WARD, *v. t.* (ward.) [Sax. *weardian*;

Sw. *varda*; Dan. *værger*; probably from Sax. *varian*, *verian*; Goth. *varjan*; D. *weeren*, to defend, guard, prevent; W. *guaru*, to fend; allied to *warry*, *aware*; Fr. *garder*, for *garder*.

The primary sense is to repel, to keep off; hence to stop; hence to defend by repelling or other means.] 1. To guard; to keep in safety; to watch.

Whose gates he found fast shut, no living wight

To ward the same. Spencer.

[In this sense, *ward* is obsolete, as we have adopted the French of the same word, to *guard*. We now never apply *ward* to the thing to be defended, but always to the thing against which it is to be defended. We *ward off* a blow or dagger, and we *guard* a person or place.]—2. To defend; to protect.

Tell him it was a hand that warded him From thousand dangers.† Shak.

[See the remark, supra.]—3. To fend off; to repel; to turn aside any thing mischievous that approaches.

Now wards a falling blow, now strikes again. Daniel.

The pointed jav'lin warded off his rage. Addison.

It instructs the scholar in the various methods of *warding off* the force of objections. Watts.

[This is the present use of *ward*. To *ward off* is now the more general expression.]

WARD, *v. i.* (ward.) To be vigilant; to keep guard.—2. To act on the defensive with a weapon.

She drove the stranger to no other shift, than to ward and go back. Sidney.

And on their warding arms light bucklers bear. Dryden.

WARD, *n.* Watch; act of guarding.

Still when she slept, he kept both watch and ward. Spenser.

2.† Garrison; troops to defend a fort; as, small wards left in forts.—3. Guard made by a weapon in fencing.

For want of other ward, He lifted up his hand his front to guard. Dryden.

4. A fortress; a strong hold.—5. One whose business is to guard, watch, and defend; as, a fire-ward.—6. A certain district, division, or quarter of a town or city. There are twenty-six wards in London, each of which is committed to an alderman.—7. A name used in the counties of Durham, Westmoreland, and Cumberland, instead of the hundred of the midland counties, or the wapentake of Yorkshire, to denote a subdivision of those shires.—8. Custody; confinement under guard. Pharaoh put his butler and baker in ward; Gen. xl.—9. A minor or person under the care of a guardian. In *feudal law*, the heir of the king's tenant, in *capite*, during his nonage was called a ward, whence the term came to be applied to all infants under the power of guardians, or such as are under the control and protection of the lord—chancellor, who are called wards in *chancery*. [See Blackstone's chapter on the rights and duties of guardian and ward.]—10. The state of a child under a guardian.

I must attend his majesty's commands, to whom I am now in ward. Shak.

11. Guardianship; right over orphans.

It is inconvenient in Ireland, that the wards and marriages of gentlemen's children should be in the disposal of any of those lords. Spenser.

12. The division of a forest.—13. One of the apartments into which an hospital is divided.—14. A part of a lock which corresponds to its proper key, and prevents any other key from opening the lock. The wards of a lock serve to guard or secure it; hence the name.—*Court of wards and liveries*, a court established by Henry VIII., to superintend the inquests which were held after the death of any of the king's tenants by knight's service, in order to ascertain what rights accrued to the king in the shape of relief, primer-seizin, wardship, or marriage. It was abolished after the restoration.

WARD, *a.* Pertaining to a city or town ward; as, a ward beadle; a ward meeting. The United States' towns are overrun with ward orators.

WARD'ED, *pp.* Guarded.

WARD'ED OFF, prevented from attacking or injuring.

**WARD'EN**, *n.* A keeper; a guardian.—2. An officer who keeps or guards; a keeper; as, the *warden of the Fleet* or *Fleet prison*, now abolished.—3. A large pear.—*Warden of the cinque ports*, the governor of these havens and their dependencies, who has the authority of an admiral, and has power to hold a court of admiralty, and courts of law and equity. [See CINQUE PORTS.]—*Wardens of the marches*. [See MARCHES.]—*Warden of a university*, is the master or president.—*Warden of a church*. [See CHURCH WARDEN.]

**WARD'ENSHIP**, } *n.* The office of a  
**WARD'ENRY**, } warden.

**WARD'DEPARTMENT**, *n.* The various offices and functionaries connected with maintaining and directing an army, taken collectively; as, he holds a place in the *war-department*.

**WARD'ER**, *n.* A keeper; a guard. The *warders of the gate*. Dryden.

2. A truncheon by which an officer of arms forbade fight.—*Warders of the tower*, officers who attend state prisoners.

**WARD'HOLDING**, *n.* The ancient military tenure in Scotland, now abolished. By this tenure all vassals were at first obliged to serve the superior in war, in such manner, and as often, as his occasions called for it. The ward and marriage of the heir were two of its casualties.

**WARD'ING**, *ppr.* Guarding; defending.—*Warding and watching*, in *Scots law*, services in burgage tenure, constituting the *reddendo* of burgage holding. These services are now merely nominal. [See BURGAGE-HOLDING.]

**WARD'NOTE**, *n.* [*ward* and *Sax. mote*, meeting.] In *London*, a court held in each *ward* of the city, which has power to present defaults, in matters relating to the watch, police, &c.

**WARD'PENNY**, *n.* Money paid for watch and ward; police-tax.

**WARD'ROBE**, *n.* [*ward* and *robe*; *Fr. garde-robe*.] 1. A room or apartment where clothes or wearing apparel is kept.—2. A portable closet for hanging up wearing apparel.—3. Wearing apparel in general.

**WARD'-ROOM**, *n.* [*ward* and *room*.] In a *ship*, a room over the gun-room, where the lieutenants and other principal officers sleep and mess.

**WARD'S CASES**, } *n.* A name  
**WARD'ING CASES**, } given to portable conservatories for plants, invented by Mr. N. B. Ward.

**WARD'SHIP**, *n.* Guardianship; care and protection of a ward.—2. Right of guardianship. Wardship, under the feudal system, was one of the incidents of tenure by knight service. When the tenant died, and his heir was under the age of 21, being a male, or 14, being a female, the lord was entitled to the wardship of the heir, and was called the guardian in chivalry. This wardship consisted in having the custody of the body and lands of such heir, without any account of the profits, till the age of 21 in males, and 14 (which was afterwards advanced to 16) in females, the male heir being then considered capable of performing knight service, and the female capable of marrying. This right of wardship was abolished under the commonwealth.—3. Pupilage; state of being under a guardian.

**WARD'-STAFF**, *n.* A constable's or watchman's staff.

**WARE**, *† pret.* of *Wear*. [It is now written *Wore*.]

**WARE**, *a.* [*Sax. war*; *Dan. var*. It belongs to the root of *ward*. We never use *ware* by itself. But we use it in *aware*, *beware*, and in *wary*. It was formerly in use.] 1. Being in expectation of; provided against; 2 *Tim. iv.*—2. *Wary*; cautious.

**WARE**, *v. i.* To take heed of. Then *ware* a rising tempest on the main.† Dryden.

[We now use *beware* as a single word, though in fact it is not.]

**WARE**, *v. t.* In *seamanship*. See **WEAR**, No. 5.

**WARE**, *n. plur.* *Wares*. [*Sax. ware*; *G. waare*; *Dan. vare*.] Goods; commodities; merchandise; usually in the plural; but we say, *China ware*, *earthen-ware*, *pottery ware*. It was formerly used in the singular, and may be so used still.

Let the dark shop commend the *ware*. Cleveland.

*Sea ware*, a name given to various sea weeds, consisting of different species of *Fucus*, *Laminaria*; *Himanthalia*, *Chorda*, &c. *Sea ware* is employed as a manure, and in the manufacture of kelp and iodine.

**WARE**. In the *Scottish dialect*. See **WAIR**.

**WAREFUL**, *† a.* [from *ware*, *wary*.] *Wary*; watchful; cautious.

**WAREFULNESS**, *† n.* *Warieness*; cautiousness.

**WAREHOUSE**, *n.* [*ware* and *house*.] A storehouse for goods.

**WAREHOUSE**, *v. t.* (*s* as *z*.) To deposit or secure in a warehouse.—2. To place in the warehouse of the government or custom house stores, to be kept until duties are paid.

**WAREHOUSED**, *pp.* Placed in a store for safe keeping.

**WAREHOUSE-MAN**, *n.* One who keeps a warehouse; one who is employed in a warehouse.

**WAREHOUSING**, *ppr.* Repositing in a store for safe keeping.

**WAREHOUSING**, *n.* The act of placing goods in a warehouse, or in a custom-house store.—*Warehousing system*, a customs' regulation by which imported articles may be lodged in public warehouses at a reasonable rent, without payment of the duties on importation, until they be withdrawn for home consumption. If they are re-exported no duty is charged. This system affords valuable facilities to trade, is beneficial to the consumer, and ultimately to the public revenue.

**WARELESS**, *† a.* Unwary; incautions.—2. *† Suffered unawares*.

**WARELY**, *† adv.* Cautiously. [See **WARYLY**.]

**WAR'FARE**, *n.* [*war* and *fare*, *Sax. faran*, to go.] 1. Military service; military life; war.

The Philistines gathered their armies for *warfare*; 1 *Sam. xxviii.*

2. Contest; struggle with spiritual enemies.

The weapons of our *warfare* are not carnal; 2 *Cor. x.*

**WAR'FARE**, *v. i.* To lead a military life; to carry on continual wars.

In that credulous *warfaring* age. [Little used.] Camden.

**WAR'FARER**, *n.* One engaged in war.

**WAR'FIELD**, *n.* Field of war or battle.

**WAR'HABLE**, *† a.* [*war* and *L. habitis*.] Fit for war.

**WAR'-HORSE**, *n.* A military charger **WAR'ILY**, *adv.* [from *wary*.] Cautiously; with timorous prudence or wise foresight. Great enterprises are to be conducted *warily*. Change of laws should be *warily* proceeded in.

**WAR'INE**, *n.* A species of monkey of South America.

**WAR'INESS**, *n.* Caution; prudent care to foresee and guard against evil. The road was so slippery, and the danger so great, that we were obliged to proceed with *warieness*.

To determine what are little things in religion, great *warieness* is to be used.

*Sprat.*  
**WAR-INSU'RANCE**, *n.* Insurance on vessels in time of war, which enhances premiums.

**WAR'K**, *n.* Work; a building. [It is obsolete in English, except in *bulwarck*, but is retained in the *Scottish dialect*.]

**WAR'LIKE**, *a.* [*war* and *like*.] Fit for war; disposed for war; as, a *warlike* state.

Old Siward with ten thousand *warlike* men. Shak.

2. Military; pertaining to war; as, *warlike* toil.—3. Having a martial appearance.—4. Having the appearance of war.

**WAR'LIKENESS**, *n.* A warlike disposition or character. [Little used.]

**WAR'LING**, *† n.* One often quarrelled with; a word coined perhaps to rhyme with *darling*.

**WAR'LOCK**, } *n.* [*war-loga*, in *Saxon*,  
**WAR'LUCK**, } signifies perfidious, false to covenants. Qu. *Ice. vard-lockr*.] A male witch; a wizard. [Scotch.]

**WARM**, *a.* (*waurn*.) [Goth. *D.* and *G. waurn*; *Sax. wearm*; *Sw.* and *Dan. varn*; *Ant. L. formus*. This word is probably a derivative from the root of *L. ferveo*, whence *fermentum*, *Eng. barm*. See **SWARM**.] 1. Having heat in a moderate degree; not cold; as, *warm* blood; *warm* milk. The flesh of living animals is *warm*, if their blood is *warm*. But some animals have not *warm* blood.—2. Subject to heat; having prevalence of heat, or little or no winter; as, the *warm* climate of *Egypt*.—3. Zealous; ardent; as, to be *warm* in the cause of our country or of religion.

Each *warm* wish springs mutual from the heart. Pope.

4. Habitually ardent or passionate; keen; irritable; as, a *warm* temper.—5. Easily excited or provoked; irritable; as, *warm* passions.—6. Violent; furious; as, a *warm* contest. We shall have *warm* work to-day.—7. Busy in action; heated in action; ardent. Be *warm* in fight.—8. Fanciful; enthusiastic; as, a *warm* head.—9. Vigorous; sprightly. Now *warm* in youth, now withering in thy bloom.

Lost in a convent's solitary gloom. Pope.  
10. Rich; as, he is known to be a *warm* man. [*Colloq.*, and seems to be confined to rich elderly persons.]—11. *Warm colours*, in *painting*, are such as have yellow or yellow-red for their basis, and are opposed to *cold colours*, which are blue and its compounds.—*Warm tints*, *cold tints*, modifications of the preceding.

**WARM**, *v. t.* [*Sax. wearmian*; *Goth. warmyan*.] 1. To communicate a moderate degree of heat to; as, a stove *warms* an apartment. The sun in

summer *warms* the earth, and gives life to vegetation.—2. To make engaged or earnest; to interest; to engage; to excite ardour or zeal in; as, to *warm* the heart with love or zeal.

I formerly *warmed* my head with reading controversial writings. *Pope.*

**WARM, v. i.** To become moderately heated. The earth soon *warms* in a clear day in summer.—2. To become ardent or animated. The speaker should *warm* as he proceeds in the argument, for as he becomes animated, he excites more interest in his audience.

**WAR-MARKED, † a.** Marked or wounded in war.

**WARM'ED, pp.** Moderately heated; made ardent; excited.

**WARMER, n.** He who warms; that which warms.—*Body-warmers, stomach-warmers, feet-warmers,* vessels filled with hot water, carefully stopped, and applied to chilled or chilly parts of the frame; usually put to while the party is in bed.

**WARMER, a. comp.** More warm.

**WARM'EST, a. superl.** Most warm.

**WARM'HEARTED, a.** Noting lively interest or affection; cordial; sincere; hearty.

**WARMING, n.** See HOUSE-WARMING.

**WARMING, pp.** Making moderately hot; making ardent or zealous.

**WARMING-PAN, n.** [*warm* and *pan*.] A covered pan with a long handle, for warming a bed with ignited coals.

**WARMING-STONE, n.** [*warm* and *stone*.] A stone dug in Cornwall, which retains heat a great while.

**WARM'LY, adv.** With gentle heat.—2. Eagerly; earnestly; ardently; as, to espouse *warmly* the cause of Bible societies.

**WARMNESS, } n.** Gentle heat; as, the

**WARMTH, } *warmth* of the blood.**

—2. Zeal; ardour; fervour; as, the *warmth* of love or of piety.—3. Earnestness; eagerness. The cause of the Greeks was espoused with *warmth* by all parties in free countries.—4. Excitement; animation; as, the *warmth* of passion. The preacher declaimed with great *warmth* against the vices of the age.—5. Fancifulness; enthusiasm; as, *warmth* of head.—6. In *painting*, that glowing effect which arises from the use of warm colours, [see **WARM**,] and also from the use of transparent colours, in the process of glazing; opposed to leaden coldness.

**WARN, v. t. (waurn.)** [Sax. *warnian*; G. *warnen*; formed on the root of *ware, vary*, Sax. *varian*. This is our *garnish*, as used in law, Norm. *garnisher*; also *garner*, for *guarner*, to warn, to admonish or give notice.] 1. To give notice of approaching or probable danger or evil, that it may be avoided; to caution against any thing that may prove injurious.

Juturna *warns* the Daunian chief Of Lausus' danger. *Dryden.*

Being *warned* by God in a dream, that they should not return to Herod, they departed into their own country another way; Matth. ii.

2. To caution against evil practices; 1 Thess. v.—3. To admonish of any duty.

Cornelius...was *warned* from God by a holy angel to send for thee; Acts x.

4. To inform previously; to give notice to.

*Warn'd* of th' ensuing fight. *Dryden.*

5. To notify by authority; to summon; as, to *warn* the citizens to meet on a

certain day; to *warn* soldiers to appear on parade.—6. † To ward off.

**WARN'ED, pp.** Cautioned against danger; admonished of approaching evil; notified.

**WARNER, n.** An admonisher.

**WARNER'IA, n.** The name formerly given to a genus of plants which is now called *Hydrastis*; nat. order *Ranunculaceæ*. The only species is *H. canadensis*, a small perennial herb, with tuberous roots. It is a native of North America. The root is bitter and acts on the system as a tonic. It is also used in dyeing and gives a beautiful yellow colour; hence it has been called *yellow root*.

**WARNING, pp.** Cautioning against danger; admonishing; giving notice to; summoning to meet or appear.

**WARN'ING, n.** Caution against danger, or against faults or evil practices which incur danger.

Could *warning* make the world more just or wise. *Dryden.*

Hear the word at my mouth, and give them *warning* from me; Ezek. iii.

2. Previous notice; as, a short *warning*. He had a month's *warning*.

**WAR'OFFICE, n.** An office in which the military affairs of a country are superintended and managed.

**WARP, n. (waurp.)** [Sax. *wearp*; D. *werp*, a cast or throw. See the verb.]

1. In *manufactures*, the threads which are extended lengthwise in the loom, and crossed by the woof.—2. In a *ship*, a rope employed in drawing, towing, or removing a ship or boat; a towing line.—3. In *agriculture*, a slimy substance deposited on land by marine tides, by which a rich alluvial soil is formed. [See **WARPING**.]—4. In *cows*, a premature casting of the young. [See the verb. *Local*.]

**WARP, v. i.** [Sax. *weorpan, wurpan, wyrpan*, to throw, to return; G. *werfen*, to cast or throw, to whelp; D. *werpen*, to throw or fling, to whelp, kitten, or litter; Dan. *værper*, to lay eggs; *varper*, to tow; Sw. *värpa*, to lay eggs; Ir. and Gael. *fiaram*, to bend, twist, incline.] 1. To turn, twist, or be twisted out of a straight direction; as, a board *warp*s in seasoning, or in the heat of the sun, by shrinking.

They clamp one piece of wood to the end of another, to keep it from casting or *warping*. *Moxon.*

2. To turn or incline from a straight, true, or proper course; to deviate.

There's our commission,  
From which we would not have you *warp*. *Shak.*

Methods

My favour here begins to *warp*. *Shak.*

3. To fly with a bending or waving motion; to turn and wave, like a flock of birds or insects. The following use of *warp* is inimitably beautiful.

As when the potent rod  
Of Amram's son, in Egypt's evil day,  
Wav'd round the coast, up call'd a pitchy cloud

Of locusts *warping* on the eastern wind. *Milton.*

4. In *manufactures*, to wind yarn off bobbins to form the warp of a web.—

5. To slink; to cast the young prematurely; as, cows.

In an inclosure near a dog-kennel, eight heifers out of twenty *warp*ed. [*Local*.] *Cyc.*

**WARP, v. t.** To turn or twist out of shape, or out of a straight direction,

1202

by contraction. The heat of the sun *warp*s boards and timber.—2. To turn aside from the true direction; to cause to bend or incline; to pervert.

This first *warp'd*, nor folly *warp'd* my mind. *Dryden.*

I have no private considerations to *warp* me in this controversy. *Addison.*

Zeal, to a degree of warmth able to *warp* the sacred rule of God's word. *Locke.*

3. In *seamen's lan.*, to tow or move with a line or warp, attached to buoys, to anchors, or to other ships, &c., by which means a ship is drawn, usually in a bending course or with various turns.—4. In *rural economy*, to cast the young prematurely. [*Local*.]—

5. In *agriculture*, to inundate, as land, with sea water; or to let in the tide, for the purpose of fertilizing the ground by a deposit of warp or slimy substance. *Warp* here is the *throw*, or that which is cast by the water. [*Local in Lincolnshire and Yorkshire*.]

—6. In *rope-making*, to run the yarn off the winches into hauls to be tarred.—*To warp water*, in Shakspeare, is forced and unusual; indeed it is not English.

**WARP'ED, pp.** Twisted by shrinking or seasoning; turned out of the true direction; perverted; moved with a warp; enriched with warp or slime; as, *warp*ed land.

**WARP'ER, n.** One who warps, or prepares the warp of webs for weaving.

**WARP'ING, n.** Act of him who warps, or that which warps.—2. In *agriculture*, a mode of fertilizing lands by producing a deposition of mud on their surface. This may be practised on the borders of large rivers and estuaries, into which the tides flow, or where floods are frequent; provided, however, that in either case the waters contain alluvial matter in a state of suspension. *Warping* is practised by various proprietors and farmers on the Humber, the Trent, the Ouse, and other rivers. The waters of these rivers, from passing through a great extent of alluvial country, are, after heavy rains, muddy to an excess; and they are in that state conducted over the surface of the adjoining land, and there suffered to deposit their mud, which is technically called *warp*, to the depth of an inch or two, which adds greatly to the fertility of the soil. In order to accomplish the process of *warping*, banks of earth are raised along the course of the rivers, so high that floods or tides cannot pass over them. In these banks there are more or fewer openings, according to the extent of ground to be warped, and other circumstances; but in general, they have only two sluices; the one, called the *floodgate*, to admit, and the other, called the *clough*, to let off the water gently. The floodgate is opened at high water, and the water flows in by one or more channels, made for the purpose of conveying it over the land, and covers it to the depth of high water. The floodgate is then shut, and at low water, the clough is opened, and the water runs out slowly, leaving the sediment behind it.—3. In *arch*. [See **CASTING**.]

**WARP'ING, pp.** Turning or twisting; causing to incline; perverting; moving with a warp; enriching by overflowing with tide water.

**WARP'ING-BANK, n.** A bank or mound of earth raised round a field

for retaining the water let in from the sea or a river.

**WAR'PING-HOOK**, *n.* A hook used by ropemakers for hanging the yarn on, when warping into hauls for tarring.

**WAR'PING-MILL**, *n.* A kind of open work cylindrical machine, of light make and easy to turn, used for warping.

**WAR'PING-POST**, *n.* A strong post used in warping rope yarn.

**WAR'PLUME**, *n.* A plume worn in war.

**WAR'PROOF**, *n.* [*war and proof.*] Valour tried by war.

**WAR'RANDICE**, *n.* [*Eng. warrantise; warranty.*] In *Scots law*, the obligation by which a party conveying a subject or right is bound to indemnify the grantee, disponee, or receiver of the right, in case of eviction, or of real claims or burdens being made effectual against the subject, arising out of obligations or transactions antecedent to the date of the conveyance. *Warrantice* is either *personal* or *real*. *Personal warrantice* is that by which the grantor and his heirs are bound personally. It is *general* or *special*. *General warrantice* is interpreted by the rules of *implied warrantice*. *Special warrantice* is either, 1st, *Simple*, viz., that the grantor shall do nothing inconsistent with the grant, which is that implied in donations; 2d, *From fact and deed*, that is, that the grantor neither has done, nor shall do, any contrary deed, which is that implied in transactions; or, 3d, *Absolute*, against all deadly, whereby the grantor is liable for every defect in the right which he has granted. *Real warrantice* is that by which certain lands, called *warrantice lands*, are made over eventually in security of the lands conveyed. In *ex-cambion*, real *warrantice* is implied. [*See under IMPLIED.*]

**WAR'RANT**, *v. t.* [*Gaelic, barantas, a warrant or pledge; baranta, a warrantee or surety; W. gwarantu, to warrant or guarantee; gwarant, warrant, attestation, authority, security; said to be from gwar, smooth, placid, secure; Norm. garrantu, warranted, proved; garren, [guarren,] a warren; [Fr. garantir, [guarantir,] to warrant; garene, a warren; It. guarentire. This is from the root of guard, warren, and wary.* The primary sense of the root is to stop or hold, or to repel, and thus guard by resisting danger; as we say, to *keep off*. Hence the sense of security. The Welsh sense of smooth, placid, is derivative, either from security, or from repressing. [*See GUARD and GARRISON.*] 1. To authorize; to give authority or power to do or forbear any thing, by which the person authorized is secured or saved harmless from any loss or damage by the act. A commission *warrants* an officer to seize an enemy. We are not *warranted* to resist legitimate government, except in extreme cases.—2. To maintain; to support by authority or proof.

Reason *warrants* it, and we may safely receive it as true. *Anon.*

3. To justify.

True fortitude is seen in great exploits, That justice *warrants*, and that wisdom guides. *Addison.*

4. To secure; to exempt; to privilege. I'll *warrant* him from drowning. *Shak.*

In a place Less *warranted* than this, or less secure, I cannot be. *Milton.*

5. To declare with assurance.

My neck is as smooth as silk. I *warrant* ye. *L'Estrange.*

6. In *law*, to secure to a grantee an estate granted; to assure.—7. To secure to a purchaser of goods the title to the same; or to indemnify him against loss.—8. To secure to a purchaser the good quality of the goods sold. [*See WARRANTY.*]—9. To assure that a thing is what it appears to be, which implies a covenant to make good any defect or loss incurred by it.

**WAR'RANT**, *n.* An act, instrument, or obligation, by which one person authorizes another to do something which he has not otherwise a right to do; an act or instrument investing one with a right or authority, and thus securing him from loss or damage; a *word of general application*.—2. A precept under hand and seal directed to a proper officer, authorizing him to seize an offender and bring him to justice. A *warrant* may be issued by a justice of the peace, a sheriff, a magistrate, or judge. A general *warrant* to seize suspected persons is illegal.—3. Authority; power that authorizes or justifies any act. Those who preach the gospel have the *warrant* of Scripture. We have the *warrant* of natural right to do what the laws do not forbid; but civility and propriety may sometimes render things improper, which natural right *warrants*.—4. A commission that gives authority, or that justifies.—5. A voucher; that which attests or proves.—6. Right; legality.

There's *warrant* in that theft Which steals itself when there's no mercy left. *Shak.*

7. A writing which authorizes a person to receive money or other thing. *Warrant of attorney*, that by which a man appoints another to act in his name, or to do an act for him, on his behalf, or as his agent or deputy. The term, however, is most commonly applied to cases where a party executes an instrument called a *warrant of attorney*, authorizing another to confess judgment against him in an action for a certain amount named in the warrant. It is generally given as a security by one who is, or is about to become, the debtor of another, and enables the creditor to obtain a judgment against his debtor at once, and all the advantages of a judgment creditor, without the risk, delay, and expense of an action.—*Search warrant*, a precept authorizing a person to enter houses, shops, &c., to search for a criminal, or for stolen or smuggled goods. *Warrant officer*, an officer holding a warrant from the navy board, such as the gunner, boatswain, and carpenter of a ship. *Press warrant*, a warrant issued by the admiralty on cases of emergency, authorizing the captain or lieutenant of the impress service at any sea port, to impress such seamen belonging to the merchant service as may be found skulking about or unemployed.

**WAR'RANTABLE**, *a.* Authorized by commission, precept, or right; justifiable; defensible. The seizure of a thief is always *warrantable* by law and justice. Falsehood is never *warrantable*.

His meals are coarse and short, his employment *warrantable*. *South.*

**WAR'RANTABLENESS**, *n.* The quality of being justifiable.

**WAR'RANTABLY**, *adv.* In a manner that may be justified; justifiably.

**WAR'RANTED**, *pp.* Authorized; justified; secured; assured by covenant or by implied obligation.

**WAR'RANTEE**, *n.* The person to whom land or other thing is warranted.

**WAR'RANTER**, *n.* One who gives authority or legally empowers.—2. One who assures, or covenants to assure; one who contracts to secure another in a right, or to make good any defect of title or quality; as, the *warranter* of a horse.

**WAR'RANTING**, *ppr.* Authorizing; empowering.—2. Assuring; securing to another a right, or covenanting to make good a defect of title in lands, or of quality in goods.

**WAR'RANTISE**, *†* *n.* Authority; security; warranty.

**WAR'RANTOR**, *n.* One who warrants.

**WAR'RANTY**, *n.* In *law*, a promise or covenant by deed, made by the bargainer for himself and his heirs, to warrant or secure the bargainee and his heirs against all men in the enjoyment of an estate or other thing granted. Such warranty passes from the seller to the buyer, from the feoffor to the feoffee, and from the releaser to the releasee. Warranty is *real*, when annexed to lands and tenements granted in fee or for life, &c., and is in deed or in law; and *personal*, when it respects goods sold or their quality. The use of warranties in conveyances has long been superseded in practice by covenants for title, whereby, as the covenantor engages for his executors and administrators, his personal as well as his real assets are answerable for the performance of the covenant. In common recoveries, a fictitious person is called to warranty. In the sale of goods or personal property, the seller warrants the title; for warranty is express or implied. If a man sells goods which are not his own, or which he has no right to sell, the purchaser may have satisfaction for the injury. And if the seller expressly warrants the goods to be sound and not defective, and they prove to be otherwise, he must indemnify the purchaser; for the law implies a contract in the warranty, to make good any defect. But the warranty must be at the time of sale, and not afterward. In *Scots law*, *warranties* in insurance are absolute conditions, non-compliance with which voids the insurance. They are either express or implied.—2. Authority; justificatory mandate or precept.

If they disobey any precept, that is no excuse to us, nor gives us any *warranty* to disobey likewise. *Kettlewell.*

[In this sense, *warrant* is now used.]—3. Security.

The stamp was a *warranty* of the public. *Locke.*

**WAR'RANTY**, *v. t.* To warrant; to guarantee.

**WARRAY**, *†* *v. t.* [*Fr. guerroyer, from guerre.*] To make war upon.

**WARRE**, *†* *a.* [*Sax. werra, for warsa.*] Worse.

**WARREN**, *n.* [from the root of *wear*, an inclosed place; *Fr. garene; D. waarande; Goth. woryan, Sax. warun*, to defend. *See GUARD, WARRANT, and WARY.*] 1. A piece of ground appropriated to the breeding and preservation of rabbits.—2. In *law*, a franchise or place privileged by prescription or grant from the king, for keeping beasts and fowls of warren, which are hares, rabbits, partridges,

and pheasants, though some add quails, woodcocks, and water-fowl. The *warren* is the next franchise in degree to the park; and a forest, which is the highest in dignity, comprehends a chase, a park, and a free warren.—3. A place for keeping fish in a river.

**WAR-TENER, n.** The keeper of a warren.

**WAR-TRIANGLE, n.** A hawk.

**WAR-RIOR, n.** [from war; Fr. *guerrier*; Sp. *guerrero, guerrador*.] 1. In a general sense, a soldier; a man engaged in military life.—2. Emphatically, a brave man; a good soldier.

**WAR-RIORESS, n.** A female warrior.

**WAR-SUNK, a.** Overwhelmed in war. [Unusual.]

**WART, n.** (waurt.) [Sax. *weart*; D. *wart*; G. *warze*; L. *verruca*; Fr. *verru*.] 1. A firm, arid, harsh, insensible extubance of the common integuments; found chiefly on the hands and face.—2. In horses, warts are spongy excrescences on the hinder pasterns, which suppurate.—3. In bot., roundish glandules on the surface of plants, filled with opaque matter, which, when numerous, give the surface a kind of roughness, designated by the term *scabrous*.

**WART-CRESS, n.** The English name of a genus of plants (Coronops); nat. order Cruciferae. Two species are found in Britain, growing on waste ground.

**WART'ED, a.** In bot., having little knobs on the surface; verrucose; as, a *warted* capsule.

**WART'LESS, a.** Having no wart.

**WART-TORCH, n.** The figurative torch that kindles war.

**WART-WORT, n.** A plant of the genus Euphorbia or spurge, which is studded with hard warty knobs; also, a plant of the genus Heliotropium, and another of the genus Lapsana.

**WART'Y, a.** Having warts; full of warts; overgrown with warts; as, a *warty* leaf; a *warty* stem.—2. Of the nature of warts.

**WAR-WASTED, a.** Wasted by war; devastated.

**WAR-WHOOP, n.** The Indian yell in war; the shout which the Indians raise when they enter into battle. [See WHOOP.]

**WAR-WORN, a.** [war and worn.] Worn with military service; as, a *war-worn* coat; a *war-worn* soldier.

**WAR'Y, a.** [Sax. *war*; Ice. *var*. See WARE and WARN.] Cautions of danger; carefully watching and guarding against deception, artifices, and dangers; scrupulous; timorously prudent. Old men are usually more *wary* than the young. It is incumbent on a general in war to be always *wary*.

**WAS, (s as z)** the past tense of the substantive verb; Sax. *wesan*; Goth. *wesan*; L. *esse*, for *vesse*, to be, to exist, whence Eng. *is*, in the present tense, and *was*, in the past; as, *I was*; he *was*.

**WASE, n.** A wisp or rude cushion put on the head by porters, &c., to soften the pressure of a load. [Local.]

**WASH, v. t.** [Sax. *wæscan*; G. *waschen*; D. *waschen*.] 1. To cleanse by ablution, or by rubbing in water; as, to *wash* the hands or the body; to *wash* garments.—2. To wet; to fall on and moisten; as, the rain *washes* the flowers or plants.—3. To overflow. The tides *wash* the meadows.—4. To overflow or dash against; to cover with water; as,

the waves *wash* the strand or shore; the sea *washes* the rocks on the shore or beach.—5. To scrub in water; as, to *wash* a deck or a floor.—6. To separate extraneous matter from; as, to *wash* ore; to *wash* grain.—7. In *water-colour painting*, to spread or float colours thinly over broad masses or spaces of a picture. Thus work is *washed* with a pale red to imitate brick and tile, &c.—8. To rub over with some liquid substance; as, to *wash* trees for removing insects or diseases.—9. To squeeze and cleanse in water; as, to *wash* wool. So sheep are said to be *washed*, when they are immersed in water and their wool squeezed, by which means it is cleansed.—10. To cleanse by a current of water; as, showers *wash* the streets.—11. To overlay with a thin coat of metal; as, steel *washed* with silver.—12. To purify from the pollution of sin.

But ye are *washed*, but ye are sanctified; 1 Cor. vi.

**WASH, v. i.** To perform the act of ablution.

*Wash* in Jordan seven times; 2 Kings v. [Elliptical].—2. To perform the business of cleansing clothes in water.

She can *wash* and scour. *Shak.*  
To *wash off*, in *calico-printing*, to soak and rinse printed calicoes, to dissolve and remove the gum and paste.

**WASH, n.** Alluvial matter; substances collected and deposited by water; as, the *wash* of a river.—2. A bog; a marsh; a fen.

Neptune's salt *wash*. *Shak.*

3. A cosmetic; as, a *wash* for the face to help the complexion.—4. A lotion; a medical liquid preparation for external application.—5. A superficial stain or colour.—6. Waste liquor of a kitchen for hogs.—7. The act of washing the clothes of a family; or the whole quantity washed at once. There is a great *wash*, or a small *wash*.—8. With *distillers*, the fermentable liquor made by dissolving the proper subject for fermentation and distillation in common water. In the distillery of malt, the wash is made by mixing the water hot, with the malt ground into meal.—9. The shallow part of a river, or arm of the sea; as, the *washes* in Lincolnshire.—10. The blade of an oar; the thin part which enters the water, and by whose impulse the boat is moved.—11. A colour spread or floated thinly over broad masses or spaces of a picture to make it appear the more natural. [See the Verb, No. 7].—12. A substance laid on boards or other work for beauty or preservation.—13. A thin coat of metal.—14. In the *West Indies*, a mixture of dunder, molasses, water, and scummings, for distillation.

**WASH-BALL, n.** [*wash* and *ball*.] A ball of soap, to be used in washing the hands or face.

**WASH-BOARD, n.** [*wash* and *board*.] A broad thin plank, fixed occasionally on the top of a boat or other small vessel's side, to prevent the sea from breaking over; also, a piece of plank on the sill of a lower deck port, for the same purpose.—2. A board that goes round the bottom of the walls of a room, more correctly called *surbase*.

**WASH'ED, pp.** Cleansed in water; purified.—2. Overflowed; dashed against with water.—3. Covered over with a thin coat, as of metal.

**WASH'ER, n.** One who washes.—2. An iron ring between the nave of a wheel

and the linch-pin.—3. A piece of iron, leather, &c., in the form of a flattened ring, interposed between the surface of wood, &c.; and the head or nut of a bolt, to protect the surfaces from being damaged during the process of screwing up. Washers of leather or pasteboard are also used to render screw and other junctions air-tight or water-tight.

**WASH'ER-MAN, n.** A man who washes clothes, &c. *Washermen* are common in France.

**WASH'ER-WOMAN, n.** A woman that washes clothes for others, or for hire.

**WASH-HOUSE, n.** An apartment, usually in an out-building, for washing linen, &c.

**WASH'ING, ppr.** Cleansing with water; purifying; overflowing; overspreading.

**WASH'ING, n.** The act of cleansing with water; ablution; Heb. ix.—2. A wash; or the clothes washed. *Washing of ores*, the operation of separating, by means of water, the metallic portion of ores from the earthy matters with which they are intermixed. The metallic portion of an ore has a much greater specific gravity than the earthy matters. Hence, if the ore of any metal be pounded, and then subjected to a current of water of sufficient velocity, the lighter earthy substances will be carried away by the water, while the metallic portion remains.

**WASHING-DAY, n.** The day when family linen is washed; as, Tuesday is our *washing-day*. [Familiar.]

**WASH'ING-MACHINE, n.** A machine for cleansing linen, cloth, and various fabrics. Various machines of this kind have been contrived.

**WASH-LEA'THER, n.** Leather that will bear washing, as chamois skin, or shammy, &c.

**WASH-POT, n.** A vessel in which anything is washed.

**WASH-TUB, n.** A tub in which clothes are washed.

**WASH'Y, a.** [from *wash*.] Watery; damp; soft; as, the *washy* ooze.—2. Weak; not solid.

**WASP, n.** [Sax. *wæsp* or *wæps*; D. *wesp*; G. *wespe*; L. *vespa*; Fr. *guêpe*.] The English name applied to insects of the genus *Vespa*; order Hymenoptera. They are characterized by their geniculate *antennæ*, composed, in the males, of thirteen joints; the mandibles strong and dentated, and the clypeus large. The females and nenters are armed with an extremely powerful and



Wasp (Wasp's nest from New Guinea).

venomous sting. Wasps live in societies, composed of females, male,

and nesters. Their nests are of varied sizes, according to the number of the society by which they are inhabited. They are either constructed underground in holes in banks, or are attached to the branches of trees, or the wood-work of out-houses. The cells are of a hexagonal form, arranged in tiers with the mouth downwards, or opening sideways, in which the larvæ and pupæ are contained. Wasps are very voracious, preying upon other insects, sngar, meat, fruit, honey, &c. Several species are indigenous in Britain. The hornet, *Vespa crabro*, is the largest. It builds its nest in trees, and passes the winter in deep holes, which it excavates in decayed trees. The most common indigenous species is the *Vespa vulgaris*, which is a ground wasp, as is also the *Vespa rufa*. *V. britannica*, or *anglica*, is a tree species, and *V. borealis*, lives in fir woods, in Yorkshire and in the north of Scotland.

**WASP-BITE, n.** The bite of a wasp.

**WASP-FLY, n.** A species of fly resembling a wasp, but having no sting, and but two wings.

**WASPISH, a.** Snappish; petulant; irritable; irascible; quick to resent any trifling affront.

Much do I suffer, much, to keep in peace,  
This jealous, *waspish*, wrong-head, rhyming  
racer. Pope.

2. Having a very slender waist, like a wasp.

**WASPISH-HEAD'ED, † a.** Irritable; passionate.

**WASPISHLY, adv.** Petulantly; in a snappish manner.

**WASPISHNESS, n.** Petulance; irascibility; snappishness.

**WAS'SAIL, n.** [Sax. *was-hæl*, health-liquor.] 1. A liquor made of apples, sugar, and ale, formerly much used by English good-fellows.—2. A drunken bout; any festival, carousal, or merry-making.—3. A merry song. The term *wassail* was anciently the pledge-word in drinking, equivalent to the modern *your health*.

**WAS'SAIL, v. i.** To hold a merry, drinking meeting; to attend at wassails; to tope.

**WAS'SAIL, a.** Convivial; festive.

**WAS'SAIL-BOWL, n.** A large drinking vessel, in which the Saxons, at their public entertainments, drank health to each other. It was also a Saxon custom to go about with such a bowl, containing the liquor called *wassail*, at the time of the Epiphany, singing a festival song, and drinking the health of the inhabitants, and collecting money to replenish the bowl. In some parts of England, the *wassail-bowl* still appears at Christmas.

**WAS'SAIL-CUP, n.** A cup in which wassail was carried to the company.

**WAS'SAILER, n.** A toper; a drunkard; a feaster; a reveller.

**WAST, past tense of the substantive verb, in the second person; as, thou wast.**

**WASTE, v. i.** [Sax. *westan, awestan*; G. *verwüsten*; Lat. *vasto*; Sp. and Port. *gastar*, for *guastar*; Fr. *gâter*; Arm. *goasta*. The W. *gwastgaru*, to scatter, seems to be compound. The primary sense is probably to scatter, to spread.]

1. To diminish by gradual dissipation or loss. Thus disease *wastes* the patient; sorrows *waste* the strength and spirits.—2. To cause to be lost; to destroy by scattering or by injury. Thus cattle *waste* their fodder when fed in

the open field.—3. To expend without necessity or use; to destroy wantonly or luxuriously; to squander; to cause to be lost through wantonness or negligence. Careless people *waste* their fuel, their food, or their property. Children *waste* their inheritance.

And *wasted* his substance with riotous living; Luke xv.

4. To destroy in enmity; to desolate; as, to *waste* an enemy's country.—5. To suffer to be lost unnecessarily; or to throw away; as, to waste the blood and treasure of a nation.—6. To destroy by violence.

The Tyber  
Insults our walls, and *wastes* our fruitful  
grounds. Dryden.

7. To impair strength gradually.  
Now *wasting* years my former strength  
confounds. Broome.

8. To lose in idleness or misery; to wear out.

Here condemn'd  
To *waste* eternal days in woe and pain. Milton.

9. To spend; to consume.  
O were I able  
To *waste* it all myself, and leave you none. Milton.

10. In *law*, to impair, damage, or injure, as an estate, voluntarily, or by suffering the buildings, fences, &c., to go to decay. [See the *Noun*.]—11. To exhaust; to be consumed by time or mortality.

Till your carcases be *wasted* in the wilderness; Numb. xiv.

12. To scatter and lose for want of use or of occupiers.

Full many a flower is born to blush unseen,  
And *waste* its sweetness on the desert air. Gray.

**WASTE, v. i.** To dwindle; to be diminished; to lose bulk or substance gradually; as, the body *wastes* in sickness.

The barrel of meal shall not *waste*; 1 Kings xvii.

2. To be diminished or lost by slow dissipation, consumption, or evaporation; as, water *wastes* by evaporation; fuel *wastes* in combustion.—3. To be consumed by time or mortality.

But man dieth, and *wasteth* away; Job xiv.

**WASTE, a.** Destroyed; ruined.  
The Sophi leaves all *waste* in his retreat. Milton.

2. Desolate; uncultivated; as, a *waste* country; a *waste* howling wilderness; Deut. xxxii.—3. Destitute; stripped; as, lands laid *waste*.—4. Superfluous; lost for want of occupiers.

And strangled with her *waste* fertility. Milton.

5. Worthless; that which is rejected, or used only for mean purposes; as, *waste* wood.—6. That of which no account is taken, or of which no value is found; as, *waste* paper.—7. Uncultivated; untiled; unproductive.

There is yet much *waste* land in England. Cyc.

*Laid waste*, desolated; ruined.  
**WASTE, n.** The act of squandering; the dissipation of property through wantonness, ambition, extravagance, luxury, or negligence.

For all this *waste* of wealth, and loss of blood. Milton.

2. Consumption; loss; useless expense; any loss or destruction which is neither necessary nor promotive of a good end; a loss for which there is no equivalent; as, a *waste* of goods or money;

a *waste* of time; a *waste* of labour; a *waste* of words.

Little *wastes* in great establishments, constantly occurring, may defeat the energies of a mighty capital. L. Beecher.

3. A desolate or uncultivated country. The plains of Arabia are mostly a wide *waste*.—4. Land untilled, though capable of tillage; as, the *wastes* in England.—5. Ground, space, or place unoccupied; as, the ethereal *waste*.

In the dead waste and middle of the night. Shak.

6. Region ruined and deserted.  
All the leafy nation sinks at last,  
And Vulcan rides in triumph o'er the *waste*. Dryden.

7. Mischief; destruction.

He will never, I think, in the way of *waste*, attempt us again. Shak.

8. In *law*, spoil, destruction, or injury done to houses, woods, fences, lands, &c., by a tenant for life or for years, to the prejudice of the heir, or of him in reversion or remainder. *Waste* is *voluntary*, as by felling timber trees, pulling down houses, opening mines or pits, changing the course of husbandry, the destruction of heir-looms; or *permissive*, as the suffering of damage to accrue, for want of doing the necessary acts to keep buildings and lands in order. Whatever does a lasting damage to the freehold, is a *waste*. Tenants in tail are privileged to commit every kind of waste during their life time.

**WASTE-BOOK, n.** A book containing a regular account of a merchant's transactions, set down in the order of time in which they take place, previous to their being carried to the journal. [See *BOOK-KEEPING*.]

**WASTED, pp.** Expended without necessity or use; lost through negligence; squandered.—2. Diminished; dissipated; evaporated; exhausted.—3. Desolated; ruined; destroyed.

**WASTEFUL, a.** Lavish; prodigal; expending property, or that which is valuable, without necessity or use; applied to persons.—2. Destructive to property; ruinous; as, *wasteful* practices or negligence; *wasteful* expenses.—3. Desolate; unoccupied; untiled; uncultivated.

In wilderness and *wasteful* deserts stray'd. Spenser.

**WASTEFULLY, adv.** In a lavish manner; with prodigality; in useless expenses or consumption.

Her lavish hand is *wastefully* profuse. Dryden.

**WASTEFULNESS, n.** Lavishness; prodigality; the act or practice of expending what is valuable, without necessity or use.

**WASTE-GATE, n.** A gate to let the water of a pond pass off when it is not wanted.

**WASTEL, † n.** A particular sort of bread; fine bread or cake.

**WASTE LAND, n.** Any tract of land not in a state of cultivation, and producing little or no useful herbage or wood; a common.

**WASTENESS, n.** A desolate state; solitude.

That day is a day of wrath, a day of trouble and distress, a day of *wasteness*; Zeph. i.

**WASTE PIPE, n.** A pipe for conveying away waste water, &c. [This name is sometimes applied to what is properly speaking an *overflow pipe*.]

**WASTER, n.** One who is prodigal; one who squanders property; one who consumes extravagantly or without use.

He also that is slothful in his work, is brother to him who is a great *waster*; Prov. xviii.

Sconces are great *wasters* of candles. *Swift*.

2. † A kind of cudgel.—3. An excrement in the snuff of a candle which causes it to waste, otherwise called a *thief*.

**WASTETHRIFT, n.** [*waste* and *thrift*.] A spendthrift.

**WASTE-WEIR, n.** In canals, dams, and reservoirs, a cut made through the side for carrying off surplus water.

**WASTING, pp.** Lavishing prodigally; expending or consuming without use; diminishing by slow dissipation; desolating; laying waste.

*Wasting* and relentless war has made ravages, with but few and short intermissions, from the days of the tyrant Nimrod down to the Nimrod of our own age.

*J. Lyman.*

2. *a.* Diminishing by dissipation or by great destruction; as, a *wasting* disease.

**WASTREL, n.** A state of waste or common. [*Local*.]

**WASTREL, } n.** Waste substances;  
**WASTOREL, }** any thing cast away as bad. [*Local*.]

**WAT, n.** A Siamese term for a sacred place, within which are pagodas, monasteries, idols, tanks, &c.

**WATCH, n.** [Sax. *wæcca*, from *wæcan*, *wæccan*, to *wake*; Sw. *vacht* or *vakt*, watch, guard; *vachta*, to watch; Dan. *vagt*. It is from the same root as *wake*,—*which see*.] 1. Forbearance of sleep.—2. Attendance without sleep.

All the long night their mournful *watch* they keep. *Addison*.

3. Attention; close observation. Keep *watch* of the suspected man.—4. Guard; vigilance for keeping or protecting against danger.

He kept both *watch* and ward. *Spenser*.

5. A watchman or watchmen; men set for a guard, either one person or more, set to espy the approach of an enemy or other danger, and to give an alarm or notice of such danger; a sentinel; a guard. He kept a *watch* at the gate.

Ye have a *watch*; go your way, make it as sure as ye can; Matt. xxvii.

6. The place where a guard is kept. He upbraids Iago that he made him Brave me upon the *watch*. *Shak.*

7. Post or office of a watchman. As I did stand my *watch* upon the hill. *Shak.*

8. A period of the night, in which one person or one set of persons stand as sentinels; or the time from one relief of sentinels to another. This period, among the Israelites, seems to have been originally four hours, but was afterward three hours, and there were four watches during the night. Hence we read in scripture of the morning watch, and of the second, third, and fourth watch; the evening watch commencing at six o'clock, the second at nine, the third at twelve, and the fourth at three in the morning; Exod. xiv.; Matt. xiv.; Luke xii.—9. A well known portable machine, generally of a small size, and round flat shape, for measuring time. The moving power in a watch is a spiral spring, and the regulating power the balance wheel, having also a small

spiral spring connected with it, which performs the same office as gravity in the case of the pendulum. The most accurately constructed watches are called *chronometers*, and are used at sea for determining differences of longitude.—*Repeating watch*, or *repeater*, a watch which is supplied with mechanism, by putting which in action, the wearer is enabled, at any time, as during the night, to ascertain the time within certain limits. This is usually effected by compressing a spring which causes a hammer or hammers to strike on a bell or other substance, the hours, quarters, &c.—10. Among *seamen*, a certain number of the ship's crew who are on duty at a time. The crew of every vessel, while at sea, is usually divided into two watches; one called the *starboard watch*, which in the merchant service is the captain's watch; the other the *larboard watch* (or as it is now termed in the royal navy, the *port watch*).—11. The period of time occupied by each part of a ship's crew alternately, while on duty. The period of time called a *watch* is four hours, the reckoning beginning at noon or midnight. Between 4 and 8 p.m., the time is divided into two short or *dog-watches*, in order to prevent the constant recurrence of the same portion of the crew keeping the watch during the same hours. Thus, the period from 12 to 4 p.m. is called the *afternoon watch*, from 4 to 6 the first *dog-watch*, from 6 to 8 the second *dog-watch*, from 8 to 12 the *first night watch*, from 12 to 4 a.m. the *middle watch*, from 4 to 8 the *morning watch*, and from 8 to 12 noon the *forenoon watch*. When this alternation of watches is kept up during the 24 hours, it is termed having *watch* and *watch*, in distinction from keeping all hands at work during one or more watches.—*Anchor watch*, a small watch composed of one or two men appointed to look after the ship while at anchor or in port.—*To set the watch*, to appoint the division of the crew to enter upon the duty of the *watch*.—*To relieve the watch*, to relieve those who have been upon duty by changing the custom.—*Watch and ward*, the ancient custom of watching by night, and warding or keeping the peace by day, in towns and cities; a duty imposed upon every inhabitant in turn.

**WATCH, v. i.** [Sax. *wacian*, *wæcan*; Dan. *vækker*; G. *wachen*; Russ. *vetchayu*.] 1. To be awake; to be or continue without sleep.

I have two nights *watch'd* with you. *Shak.*

2. To be attentive; to look with attention or steadiness. *Watch* and see when the man passes.—3. To look with expectation.

My soul waiteth for the Lord more than they that *watch* for the morning; Ps. cxxx.

4. To keep guard; to act as sentinel; to look for danger.

He gave signal to the minister that *watch'd*. *Milton*.

5. To be attentive; to be vigilant in preparation for an event or trial, the time of whose arrival is uncertain.

*Watch* therefore; for ye know not what hour your Lord doth come; Matt. xxiv.

6. To be insidiously attentive; as, to *watch* for an opportunity to injure another.—7. To attend on the sick during the night; as, to *watch* with a man in a fever.—*To watch over*, to be cau-

tiously observant of; to inspect, superintend, and guard from error and danger. It is our duty constantly to *watch over* our own conduct and that of our children.

**WATCH, v. t.** To guard; to have in keeping.

Flaming ministers *watch* and tend their charge. *Milton*.

2. To observe in ambush; to lie in wait for.

Saul also sent messengers to David's house to *watch* him and to slay him; 1 Sam. xix.

3. To tend; to guard.

Paris *watch'd* the flocks in the groves of Ida. *Broome*.

4. To observe in order to detect or prevent, or for some particular purpose; as, to *watch* a suspected person; to *watch* the progress of a bill in the legislature.

**WATCH AND WARD.** See **WATCH**. **WATCH BELL, n.** In ships of war, a large bell which is struck when the half-hour glass is run out, to make known the time or division of the watch.

**WATCH BILL, n.** A list of the officers and crew of a ship, who are appointed to the watch, together with the several stations to which each man belongs.

**WATCH CASE, n.** A case for a watch.

**WATCH DOG, n.** A dog kept to watch.

**WATCH'ED, pp.** Guarded; observed with steady vigilance.

**WATCH'ER, n.** One who sits up or continues awake; particularly, one who attends upon the sick during the night.—2. † A diligent observer; as, an attentive *watcher* of the works of nature.

**WATCH'ET, a.** [Sax. *wæced*, weak.] Pale or light blue.

Who stares in Germany at *watchet eyes*? † *Dryden*.

**WATCH' FIRE, n.** A fire lighted on an eminence at night, as a signal, to notify the approach of an enemy.

**WATCH'FUL, a.** Vigilant; attentive; careful to observe; observant; cautious. It has of before the thing to be regulated; as, to be *watchful* of one's behaviour; and *against*, before the thing to be avoided; as, to be *watchful against* the growth of vicious habits.

**WATCH'FULLY, adv.** Vigilantly; heedfully; with careful observation of the approach of evil, or attention to duty.

**WATCH'FULNESS, n.** Vigilance; heedfulness; heed; suspicious attention; careful and diligent observation for the purpose of preventing or escaping danger, or of avoiding mistakes or misconduct.—2. Wakefulness; indisposition or inability to sleep.

*Watchfulness*...often precedes too great sleepiness. *Arbutnot*.

**WATCH'-GLASS, n.** [*watch* and *glass*.] In ships, an hour or half-hour glass, used to measure the time of a watch on deck.—3. A concavo-convex glass for covering the face or dial of a watch.

**WATCH'-GUN, n.** The gun which is fired on board ships of war, at the setting of the watch in the evening, and relieving it in the morning.

**WATCH'-HOUSE, n.** [*watch* and *house*.] A house in which a watch or guard is placed.—2. In cities and towns, a house where the night watchmen assemble previous to the hour at



which they enter upon their respective beats, and where disturbers of the peace, seized by them during the night, are lodged and kept in custody till morning, when they are brought before a magistrate.

**WATCHING**, *ppr.* Being awake; guarding; attending the sick; carefully observing.

**WATCH'ING**, *n.* Wakefulness; inability to sleep.

**WATCH'-LIGHT**, *n.* [*watch* and *light*.] A candle with a rush wick.

**WATCH'MAKER**, *n.* [*watch* and *maker*.] One whose occupation is to make and repair watches. Properly speaking, however, a watchmaker, in the ordinary sense of the term, is an artificer who arranges and puts together the wheels and different parts of a watch, after they are cast, and prepared by other artizans, and who cleans and repairs watches.

**WATCH'MAN**, *n.* [*watch* and *man*.] A sentinel; a guard.—2. One who guards the streets of a city or town, or a large building by night.—A *watchman's rattle* is an instrument having at the end of a handle a revolving arm, which by the action of a strong spring upon cogs, produces, when in motion, a loud, harsh, rattling sound.—*To spring a rattle*, is to put this instrument in motion, in order to call in the aid of other watchmen when such aid is necessary.

**WATCH'TOWER**, *n.* [*watch* and *tower*.] A tower on which a sentinel is placed to watch for enemies or the approach of danger.

**WATCH'WORD**, *n.* [*watch* and *word*.] The word given to sentinels, and to such as have occasion to visit the guards, used as a signal by which a friend is known from an enemy, or a person who has a right to pass the watch, from one who has not.

**WATER**, *n.* (*wau'ter*.) [*Sax. water, was*; *D. water*; *G. wasser*; *Goth. wato*; *Russ. voda*. This may be from the root of *wet*, *Gr. ὕδωρ*, *Sans. udum*. In *Ar. wadi* signifies a stream, or the channel where water flows in winter, but which is dry in summer; a thing common on the plains of Syria and Arabia.] 1. A fluid, the most abundant and most necessary for living beings of any in nature, except air. Water, when pure, is transparent, colourless, inodorous, tasteless; a powerful refractor of light, an imperfect conductor of heat and electricity; it is very slightly compressible, its absolute diminution for a pressure of one atmosphere being only about 51.3 millionths of its bulk. It assumes the solid form, that of ice or snow, at 32°, and all lower temperatures; and it takes the form of gas or vapour, that of steam, at 212°, and retains that form at all higher temperatures. It possesses the liquid form only at temperatures lying between 32° and 212°. The specific gravity of water is 1, being the unit to which the specific gravities of all solids and liquids are referred, as a convenient standard, on account of the facility with which it is obtained in a pure state; one cubic inch of water at 62°, and 30 inches, barometrical pressure, weighs 252.458 grains. It is 815 times heavier than atmospheric air. Water is at its greatest density at 40°, and in this respect it presents a singular exception to the general law of expansion by heat. If water at 40° be

cooled, it expands as it cools till reduced to 32°, when it solidifies; and if water at 40° be heated, it expands as the temperature increases in accordance with the general law. This expansion of water by cold below 40° produces very important effects in the economy of nature; for if its density increased as it approached the freezing point, large masses of water would become masses of solid ice. In a chemical point of view, water exhibits in itself neither acid nor basic properties; but it combines with both acids and bases forming *hydrates*; it also combines with neutral salts. Water also enters, as a liquid, into a peculiar kind of combination with the greater number of all known substances. Of all liquids, water is the most powerful and general solvent, and on this important property its use depends. Without water, not only the operations of the chemist, but the processes of animal and vegetable life would come to a stand. In consequence of the great solvent power of water, it is never found pure in nature. Even in rain-water, which is the purest, there are always traces of carbonic acid, ammonia, and sea-salt. Where the rain-water has filtered through rocks and soils, and reappears, as spring or river-water, it is always more or less charged with salts derived from the earth, such as sea-salt, gypsum and chalk. When the proportion of these is small the water is called *soft*, when larger it is called *hard water*. The former dissolves soap better, and is therefore preferred for washing; the latter is often pleasanter to drink. The only way to obtain perfectly pure water is to distil it. Distilled water is preserved in clean well stopped bottles, and used in chemical operations. Water is repositied in the earth in inexhaustible quantities, where it is preserved fresh and cool, and from which it issues in springs, which form streams and rivers. But the great reservoirs of water on the globe are the ocean, seas and lakes, which cover more than three-fifths of its surface, and from which it is raised by evaporation, and uniting with the air in the state of vapour, is wafted over the earth, ready to be precipitated in the form of rain, snow or hail. The old chemists regarded water as a simple element; but it is now known to be a compound substance, consisting of hydrogen and oxygen, in the proportion of 2 volumes of the former gas to one volume of the latter; or by weight, it is composed of 1 equivalent of hydrogen, 1, + 1 equivalent of oxygen, 8 = 9 its equivalent; it is in fact a protoxide of hydrogen.—2. The ocean; a sea; a lake; a river; any great collection of water; as, in the phrases, to go by *water*, to travel by *water*.—3. Urine; the animal liquor secreted by the kidneys and discharged from the bladder.—4. The colour or lustre of a diamond or pearl, sometimes perhaps of other precious stones; as, a diamond of the first *water*, that is, perfectly pure and transparent. Hence the figurative phrase, a man or a genius of the first *water*, that is, of the first excellence.—5. *Water* is a name given to several liquid substances or humours in animal bodies; as, the *water* of the pericardium, of dropsy, &c.—*Water of crystallization*, the water which unites chemically with many salts during the

act of crystallizing. It forms an essential part of the crystal, but not of the salt, and is easily expelled by heat, when the crystals generally fall to powder.—*Mineral waters* are those waters which are so highly charged with foreign matters, as to have an unpleasant taste, or to acquire medicinal virtues. There are several kinds of mineral waters; those in which iron predominates are called *chalybeate waters*; where sulphur prevails, they are called *sulphurous waters*; *acidulous waters* are those which contain much free carbonic acid; and *saline waters* are such as contain neutral salts, generally sea-salt, and sulphate of magnesia or Epsom salt. Most natural waters contain more or less of these foreign substances, but the proportion is generally too minute to affect the senses.—*Strong waters*, brandy, liquors, &c. [This term, once much in use, is now obsolete.]—*To hold water*, to be sound or tight. [*Obsolete or vulgar*.]

**WATER**, *v. t.* (*wau'ter*.) To irrigate; to overflow with water, or to wet with water; as, to water land. Showers *water* the earth.—2. To supply with water; as, a country well *watered* with rivers and rivulets.—3. To supply with water for drink; as, to *water* cattle and horses.—4. To diversify; to wet and calender; to give a wavy appearance to; as, to *water* silk.

**WATER**, *v. i.* (*wau'ter*.) To shed water or liquid matter. His eyes began to *water*.—2. To get or take in water. The ship put into port to *water*.—*The mouth water*, a phrase denoting that a person has a longing desire; from dogs which drop their slaver when they see meat which they cannot get at.

**WATER'AGE**, *n.* Money paid for transportation by water.

**WATER'-ALOE**, *n.* A perennial plant growing in water.

**WATER'-BAILIFF**, *n.* An officer of the customs in sea-port towns who searches ships, and in London has the supervision of the fish market, gathering of tolls, &c.

**WATER'-BEAN**, *n.* A plant, the *Nelumbium speciosum*. It is the Lotus of the ancients, and the Pythagorean bean. [See *NELUMBIACEÆ*.]

**WATER'-BEARER**, *n.* [*water* and *bearer*.] In *astron.*, a sign of the zodiac, called also Aquarius, from *L. aqua*, water.

**WATER'-BEARING**, *a.* Bearing or conveying water.

**WATER'-BEATEN**, *a.* Beaten by water or the waves.

**WATER'-BEETLE**, *n.* The *Dytiscus*, an insect.

**WATER'-BELLOWS**, *n.* [*water* and *bells*.] A machine for blowing air into a furnace, by means of a column of water falling through a vertical tube.

**WATER'-BETONY**, *n.* A plant of the genus *Scrophularia*, the *S. aquatica*, Linn.

**WATER'-BLINKS**, *n.* A British plant of the genus *Montia*, the *M. fontana*; also called water-chickweed. [See *MONTIA*.]

**WATER'-BOARDS**, *n.* Boards fixed up in a boat to keep off the water; called also *weather-boards*.

**WATER'-BORNE**, *a.* Borne by the water; floated; having water sufficient to float; as, ships *water-borne* by the flowing tide.

**WATER-BOUGET,** } *n.* A vessel an-  
**WATER-BUDGET,** } ciently used by  
 soldiers for carry-  
 ing water in long  
 marches and de-  
 sert places; and  
 also by water car-  
 riers, to convey  
 water from con-  
 duits to the  
 houses of the citizens. In *her.*, it is  
 a bearing frequent in English coat-  
 armour, but as  
 now generally re-  
 presented, it is very  
 different in form  
 from those figured  
 in the ancient MSS.



Ancient form of Water-  
Bougets.

**WATER-BUTT,** *n.*  
 A large open-headed  
 cask, usually set up  
 on end in an out-  
 house, or close to a  
 dwelling, serving as  
 a reservoir for  
 rain or pipe water.



Water-Bouset as de-  
picted in modern  
coat-armour.

**WATER-CALAMINT,** *n.* [*water* and  
*calamint.*] A species of mint or Men-  
 tha, the *M. aquatica*, Linn.

**WATER-CARRIAGE,** *n.* [*water* and  
*carriage.*] Transportation or convey-  
 ance by water; or the means of trans-  
 porting by water.—2. † A vessel or  
 boat.

**WATER-CÄRT,** *n.* [*water* and *cart.*]  
 A cart bearing a large cask or tank of  
 water, which, by means of a tube per-  
 forated with holes, and placed hori-  
 zontally across the lower part of the  
 back of the cart, is sprinkled on roads  
 and streets to prevent dust from rising.

**WATER-CASK,** *n.* In *ships*, a large  
 strong hooped barrel, used for holding  
 water for the use of those on board.  
*Iron tanks* are now preferred to wooden  
 casks.

**WATER-CEMENTS,** *n.* Cements which  
 possess the property of hardening un-  
 der water, and are therefore employed  
 in structures which are built under  
 water; and also for lining cisterns,  
 for coating damp walls on basement  
 stories, &c. [*See* CEMENT, PUZZOLANA,  
 TARRAS.]

**WATER-CHESTNUT,** *n.* A plant, the  
*Trapa natans*.

**WATER-CHICKWEED.** *See* WATER-  
 BLENKS.

**WATER-CIR'LED,** } *a.* Surrounded  
**WATER-GIRD'LED,** } by water.

**WATER-CLOCK,** *n.* [*water* and *clock.*]  
 The clepsydra; an instrument or ma-  
 chine serving to measure time by the  
 fall of a certain quantity of water.  
 [*See* CLEPSYDRA.]

**WATER-CLOSET,** *n.* [*water* and  
*closet.*] A closet for easing nature,  
 having a contrivance for carrying off  
 the discharges by a stream of water  
 through a waste-pipe below.

**WATER-COLOUR,** *n.* [*water* and *col-  
 our.*] Water-colours, in painting or  
 limning, are colours diluted and mixed  
 with gum-water. Water-colours are  
 so called in distinction from oil-colours.

**WATER-COLOURIST,** *n.* One who  
 paints in water-colours.

**WATER-COLOUR PAINTING,** *n.* A  
 species of painting in which the me-  
 dium of representation is water-col-  
 ours instead of oil-colours. The term  
 is now confined to drawing in water-  
 colours upon paper, vellum, and ivory.

**WATER-COURSE,** *n.* [*water* and  
*course.*] A stream of water; a river  
 or brook; Isa. xliv.—2. A channel or  
 canal for the conveyance of water;

any natural or artificial stream of  
 water.—3. In *law*, the interest or right  
 to take water in another's land, or the  
 right of conducting water through one  
 estate for the use of another. This  
 is an incorporeal hereditament of the  
 class of easements.

**WATER-CRAFT,** *n.* Vessels and boats  
 plying on water.

**WATER-CRESS,** *n.* [*water* and *cress.*]  
 An aquatic plant of the genus *Nasturtium*,  
 the *N. officinale*. It was formerly  
*Sisymbrium nasturtium*. [*See*  
*NASTURTIIUM.*]

**WATER-CROW,** *n.* The water-ouzel  
 or ouzel,—*which see.*

**WATER-CROWFOOT,** *n.* [*water* and  
*crowfoot.*] A plant, the *Ranunculus*  
*aquatilis*, on which cows are said to  
 be fond of feeding.

**WATER-DEVIL,** *n.* A name some-  
 times given to the larva of a British  
 aquatic insect, of the genus *Hydro-*  
*philus*, the *H. picus*, common in ponds  
 and ditches.

**WATER-DOCK,** *n.* A plant, the *Ru-*  
*mex aquatica*.

**WATER-DOG,** *n.* A dog accustomed  
 to the water; as the *Canis aquaticus*.  
 [*See* WATER-SPANIEL.]—*Water-dogs*,  
 a local name for small, irregular, float-  
 ing clouds in a rainy season, supposed  
 to indicate rain.

**WATER-DRAIN,** *n.* A drain or chan-  
 nel for water to run off.

**WATER-DRAINAGE,** *n.* The draining  
 off of water.

**WATER-DROP,** *n.* [*water* and *drop.*]  
 A drop of water; a tear.

**WATER-DROPWORT,** *n.* The com-  
 mon name of several British plants of  
 the genus *Oenanthe*. [*See* OENANTHE.]

**WATERED,** *pp.* Overspread or  
 sprinkled with water; made wet;  
 supplied with water; made lustrous  
 by being wet and calendered.

**WATER-ELDER,** *n.* A name given to  
 the common guelder rose, *Viburnum*  
*opulus*. [*See* VIBURNUM.]

**WATER-ELPHANT,** *n.* A name  
 given to the hippopotamus.

**WATER-ENGINE,** *n.* [*water* and *en-  
 gine.*] An engine to raise water; or  
 an engine propelled by water.

**WATERER,** *n.* One who waters.

**WATER-FALL,** *n.* [*water* and *fall.*] A  
 fall or perpendicular descent of the  
 water of a river or stream, or a de-  
 scent nearly perpendicular; a cascade;  
 a cataract; as, the *falls* of Niagara;  
 the *falls* of the Bruar in the Highlands  
 of Scotland, of Lodore in Cumberland,  
 and the Rheidol in North Wales.  
 [*See* FALL.] The name *water-falls* is  
 also given to artificial cascades formed  
 in gardens and pleasure grounds, for  
 the purpose of producing ornamental  
 and picturesque effects.

**WATER-FEATHERFOIL,** *n.* A plant  
 of the genus *Hottonia*, the *H. palustris*,  
 called also water-violet. [*See* HOR-  
 TONIA.]

**WATER-FLAG,** *n.* [*water* and *flag.*]  
 A plant of the genus *Iris*, the *I.*  
*pseudacorus*, called also corn-flag,  
 yellow-iris, and flower-de-luce. [*See*  
*IRIS.*]

**WATER-FLANNEL,** *n.* A plant, *Con-*  
*ferva crispa*; one of the algæ, which  
 forms beds of entangled filaments on  
 the surface of water.

**WATER-FLOOD,** *n.* [*water* and *flood.*]  
 A flood of water; an inundation.

**WATER-FLY,** *n.* [*water* and *fly.*] An  
 insect that is seen on the water.

**WATER-FOWL,** *n.* [*water* and *fowl.*]

A fowl that frequents the water, or  
 lives about rivers, lakes, or on or near  
 the sea; an aquatic fowl. Of aquatic  
 fowls, some are waders, or furnished  
 with long legs as the *Grallatores*;  
 others are swimmers, and are furnished  
 with webbed feet, as the pelicans,  
 swans, geese, ducks, &c.; others fly or  
 skim along the surface of the water in  
 search of their prey, as the petrels;  
 and birds of the gull kind generally;  
 and others dive into the water to seize  
 their prey; as the divers, puffins and  
 penguins.

**WATER-FOX,** *n.* [*water* and *fox.*] A  
 name given to the carp, on account of  
 its cunning.

**WATER-FRAME,** *n.* In *cotton mills*,  
 the name given to Arkwright's spinning  
 frame, on account of its having been  
 at first driven by water-wheels.

**WATER-FURROW,** *n.* [*water* and  
*furrow.*] In *agriculture*, a deep furrow  
 made for conducting water from the  
 ground and keeping it dry.

**WATER-FURROW,** *v. t.* To plough or  
 open water-furrows.

**WATER-GÄGE,** } [*n.* [*water* and *gäge.*]  
**WATER-GUÄGE,** } An instrument  
 for measuring or ascertaining the depth  
 or quantity of water.

**WATER-GALL,** *n.* A cavity made in  
 the earth by a torrent of water.—2.  
 An appearance in the rainbow.

**WATER-GAVEL,** *n.* In *law*, a rent  
 paid for fishing, or any other benefit  
 derived from some river.

**WATER-GERMANDER,** *n.* A plant  
 of the genus *Teucrium*, the *T. scordium*.  
 [*See* GERMANDER.]

**WATER-GILDER,** *n.* One who prac-  
 tises the art of water-gilding,—*which  
 see.*

**WATER-GILDING,** *n.* The gilding of  
 metallic surfaces by covering them  
 with a thin coating of amalgam of gold,  
 and then volatilizing the mercury by  
 heat. The gold is thus left adhering  
 to the surface, upon which it is after-  
 wards burnished. Brass and copper  
 buttons are gilt in this way; but before  
 the amalgam is applied the surface of  
 brass or copper is usually prepared by  
 cleaning and rubbing it over with a  
 solution of nitrate of mercury, which  
 causes the amalgam of gold, when  
 subsequently applied, to adhere to the  
 surface.

**WATER-GOD,** *n.* [*water* and *god.*] In  
*mythol.*, a deity that presides over the  
 water.

**WATER-GRU'EL,** *n.* [*water* and *gruel.*]  
 A liquid food, composed of water and  
 a small portion of meal or other farin-  
 aceous substance boiled, and seasoned  
 with salt.

**WATER-GRU'ELLED,** *a.* Supplied  
 with water-gruel.

**WATER-GUT,** *n.* The common name  
 of cryptogamic plants of the genus  
*Enteromorpha*; nat. order *Ulvacæ*.  
 These plants are chiefly inhabitants  
 of the sea or of pools and ditches of  
 salt water, and when floating in the  
 water very much resemble the intes-  
 tines of an animal, hence the name.  
 [*See* ULVACÆ.]

**WATER-HAIR-GRASS,** *n.* A species  
 of grass, the *Aira aquatica*.

**WATER-HAMMER,** *n.* A philosophical  
 toy, consisting of a column of water in  
 a vacuum, which not being supported  
 as in the air, falls against the end of  
 the vessel with a peculiar noise. It  
 may be formed by corking a vessel of  
 water while it is boiling. The vapour

condensing as it cools, a vacuum is formed.

**WATER-HEMLOCK**, *n.* A British plant of the genus *Cicuta*; the *C. virosa*. It is a poisonous plant, growing in ditches, lakes and rivers. [See *CICUTA*.]

**WATER-HEMP-AGRIMONY**, *n.* A plant of the genus *Bidens*; the *B. tripartita*, called also three-cleft bur marigold. The *Eupatorium cannabinum* is also called water-hemp-agrimony.

**WATER-HEN**, *n.* [*water* and *hen*.] A water fowl of the genus *Gallinula*, the *G. chloropus*, belonging to the family Rallidae. It is known in this country by the name of *moorhen*. The Soree or common Rail of America is also called *water-hen*.

**WATER-HOG**, *n.* [*water* and *hog*.] A rodent mammal, *Hydrochærus capybara*, the size of a two year's old hog,



Water-Hog (*Hydrochærus capybara*).

classed with the *Cavidae*, and a native of South America. It feeds on vegetables and fish, swimming after and seizing the latter like an otter. It is a tailless animal, with a large head, thick divided nose, thick body covered with short, coarse brown hair, short legs, long feet, which instead of being cloven are almost webbed. It is plentiful in Brazil, and frequents the islands at the mouth of the La Plata; and is easily tamed.

**WATER-HOREHOUND**, *n.* A British plant of the genus *Lycopus*, the *L. europæus*, called also gipsy-wort,—*which see*.

**WATER-HORSE-TAIL**, *n.* The common name of several British aquatic plants of the genus *Chara*; nat. order Characeæ. Several of them are also known by the name of *stcnewort*,—*which see*.

**WATER-HYSSOP**, *n.* A plant of the genus *Gratiola*, the *G. officinalis*, Linn. It has been employed in medicine as a cathartic and diuretic in hydropical cases.

**WATERINESS**, *n.* [from *watery*.] Moisture; humidity; a state of abounding with water.

**WATERING**, *ppr.* Overflowing; sprinkling or wetting with water; supplying with water; giving water for drink; giving a wavy appearance to.

**WATERING**, *n.* The act of overflowing or sprinkling with water; the act of supplying with water for drink or other purposes.—2. The place where water is supplied.—3. In *agriculture*, the process of irrigating land; or the application of water to the surface of land for the improvement of the soil,

and for promoting vegetation.—4. In *horticulture*, the process of applying water artificially to plants, in order to promote their growth.—5. A process to which silk and other textile fabrics are subjected, in order to make them exhibit a wavy lustre and different plays of light. This is done by sprinkling the cloth with water, and then calendering it.

**WATERING-PLACE**, *n.* 1. A place where water may be obtained, as for a ship, for cattle, &c.—2. A place to which people resort at certain seasons in order to drink mineral waters, or bathe, for the benefit of their health. A sea-bathing place is called a *watering-place*.

**WATERING-TROUGH**, *n.* A trough in which cattle and horses drink.

**WATERISH**, *a.* Resembling water; thin, as a liquor.—2. Moist; somewhat watery; as, *waterish* land.

**WATERISHNESS**, *n.* Thinness, as of a liquor; resemblance to water.

*Waterishness*, which is like the serosity of our blood. *Floyer*.

**WATER-LASHED**, *a.* Lashed by the water.

**WATER-LEAF**, *n.* [*water* and *leaf*.] The common name of plants of the genus *Hydrophyllum*.

**WATER-LEMON**, *n.* A plant of the genus *Passiflora*, the *P. laurifolia*. [See *PASSIFLORA*.]

**WATERLESS**, *a.* Destitute of water.

**WATER-LEVEL**, *n.* [*water* and *level*.] The level formed by the surface of still water.—2. A levelling instrument in which water is employed instead of mercury or spirit of wine. It consists of a glass tube containing water, open at both ends, and having the ends turned up. When the tube is placed on a horizontal surface, the water will stand at the same height in the turned up ends, and when placed in an inclined position, the water will manifestly stand highest in the depressed end. [See *LEVEL*.]

**WATER-LILY**, *n.* [*water* and *lily*.] The common name of aquatic plants of the genera *Nymphæa* and *Nuphar*, distinguished for their beautiful flowers and large floating leaves. [See *NYMPHÆA*, and *NUPHAR*.]

**WATER-LINE**, *n.* [*water* and *line*.] Water-lines, in *shipbuilding*, are those horizontal lines supposed to be described by the surface of the water on the bottom of the ship, and which are exhibited at certain depths upon the sheer-draught. The most particular of these lines are, the *light-water-line*, which shows the depression of the ship's body in the water when she is light or unladen; and the *load-water-line*, which exhibits her depression in the water when laden.

**WATER-LOGGED**, *a.* [*water* and *log*.] Lying like a log on the water. A ship is said to be *water-logged*, when by leaking and receiving a great quantity of water into her hold, she has become so heavy as not to be manageable by the helm, and to be at the mercy of the waves.

**WATERMAN**, *n.* [*water* and *man*.] A boatman; a ferryman; a man who manages water-craft.

**WATER-MARK**, *n.* [*water* and *mark*.] The mark or limit of the rise of a flood. Thus, we say *high-water-mark*, *low-water-mark*, &c.

**WATER-MEADOWS**, *n.* Meadows on low flat grounds, which are capable of

being kept in a state of fertility by being overflowed with water at certain seasons, from some adjoining river or stream.

**WATER-MEASURE**, *n.* A measure formerly in use for articles brought by water, as coals, oysters, &c. The bushel used for this purpose was larger than the Winchester bushel by about three gallons.

**WATER-MEL'ON**, *n.* [*water* and *melon*.] A plant and its fruit, of the genus *Cucurbita* or *Cucumis*, (*C. citrullus*.) This plant requires a warm climate to bring it to perfection. It also requires a dry, sandy, warm soil, and will not grow well in any other. The fruit abounds with a sweetish liquor resembling water in colour, and the pulp is remarkably rich and delicious.

**WATER-MILFOIL**, *n.* The common name of three British aquatic plants of the genus *Myriophyllum*, nat. order *Onagraceæ*, sub-order *Halorageæ*.

**WATER-MILL**, *n.* [*water* and *mill*.] A mill whose machinery is moved by water, and thus distinguished from a wind-mill.

**WATER-MINT**. See *WATER-CALAMINT*.

**WATER-MOVED**, *a.* Moved by water power.

**WATER-MURRAIN**, *n.* A disease among black cattle.

**WATER-NET**, *n.* A plant, *Hydrodictyon utriculatum*, a species of Alga, which has the appearance of a green net, composed of filaments enclosing pentagonal and hexagonal spaces.

**WATER-NEWT**, *n.* A name given to various species of reptiles of the genus *Triton*, frequenting ponds, ditches, clear, sluggish, and standing waters. They belong to the family of Salamandridæ, and in appearance resemble small lizards, though differing from them considerably in structure and habits. Like the frog, the newt begins its existence in a tadpole state, and is furnished with branchiæ for breathing water, which subsequently give place to true lungs, fitted for breathing air. The largest species found in this country is the common warty or great water-newt, *Triton cristatus*. It is



Water-Newt, male (*Triton cristatus*).

not at all uncommon, is very aquatic in its habits, attains the length of six inches, and is perfectly harmless. In colour its upper parts are blackish or yellowish brown with dark spots; under parts bright orange, with black spots and sides dotted with white. During the breeding season the male is furnished with a deep flexible indented crest.

**WATER-NUTS**, *n.* The common name of plants of the genus *Trapa*. [See *TRAPA*.]

**WATER-NYMPH**, *n.* A marine nymph; a Naiad.

**WATER-OR'DEAL**, *n.* [*water* and

*ordeal.*] A judicial trial of persons accused of crimes, by means of water; formerly in use among illiterate and superstitious nations. [See ORDEAL.]  
**WATER-OR'GAN**, *n.* A kind of organ recorded by ancient writers, which was operated on in some way by water.

**WATER-OU'SEL**, *n.* [*water* and *ou-wATER-OU'ZEL*,] *zel.*] A bird of the genus *Cinclus*, the *C. aquaticus*, belonging to the family Merulidæ or thrushes. It is also called the *Dipper*. [See *DIPPER*.]

**WATER-PARSNEP**, *n.* [*water* and *parsnep*.] The common name of British plants of the genus *Sium*. [See *SIMUM*.]

**WATER-PEP'TER**, *n.* An acrid water-plant, the *Polygonum hydropiper*, Linn.  
**WATER-PIMPERNEL**, *n.* A British aquatic plant of the genus *Samolus*, the *S. valerandi*, called also common brook-weed. [See *SAMOLUS*.]

**WATER-PIPE**, *n.* A pipe for the conveyance of water. [See *PIPE*.]

**WATER-PLANT**, *n.* Water plants are such as live entirely in water, or which require a preponderating quantity of water as the medium of their existence. All the species of the orders Nymphæaceæ, Callitrichaceæ, Ceratophyllaceæ, Podostemaceæ, Butomaceæ, Naiadaceæ, Pistiaceæ, Alismaceæ, consist of water-plants, and likewise the species of cryptogamic plants of the family Alge.

**WATER-PLANTAIN**, *n.* The common name of various species of British plants of the genus *Alisma*, nat. order Alismaceæ. One species, *A. plantago*, great water-plantain, is a common wild plant in wet ditches and by river sides. It has had the reputation of being a cure for hydrophobia.

**WATER-PO'A**, *n.* A species of grass, the *Poa aquatica*.

**WATER-POISE**, *n.* (*s* as *z*.) [*water* and *poise*.] A hydrometer or instrument for ascertaining the specific gravity of different liquids. [See *HYDROMETER*.]

**WATER-POT**, *n.* [*water* and *pot*.] A vessel for holding or conveying water or for sprinkling water on cloth in bleaching, or on plants, &c.—2. A urinal.

**WATER-POWER**, *n.* Water employed as a prime mover in machinery.

**WATER-PRIVILEGE**, *n.* The right to use running water to turn machinery. [American.]

**WATER-PROOF**, *a.* [*water* and *proof*.] Impervious to water; so firm and compact as not to admit water; as, *water-proof* cloth, leather, or felt. Cloth may be rendered *water-proof* by spreading upon its surface a solution of caoutchouc or India rubber, and then extending a similar piece of cloth upon this surface, and passing the whole between a pair of rollers. Thus the fabric consists of two pieces of cloth, with a layer of caoutchouc interposed, and uniting them together. The cloth thus prepared is so impervious to moisture or to air, that floating or hydrostatic beds for invalids are formed of it. There are various other modes of rendering cloth or textile fabrics, or leather, *water-proof*.

**WATER-PURSLANE**, *n.* An annual plant, the *Peplis portula*, Linn.

**WATER-RAIL**, *n.* [*water* and *rail*.] A fowl of the genus *Rallus*; the *R. aquaticus*.

**WATER-RAM**, *n.* A machine for raising water, otherwise called the *Hydraulic ram*, and *Montgolfier's ram*. [See the *latter term*.]

**WATER-RAT**, *n.* [*water* and *rat*.] A rodent animal of the genus *Arvicola*, the *A. amphibius* of Desmarest, and the *Mus amphibius* of Linn., which lives in the banks of streams or lakes.

**WATER-RETTED**, *a.* Watered; as hemp. [Provincial.]

**WATER-ROCKED**, *a.* Rocked by the waves.

**WATER-ROCKET**, *n.* [*water* and *rocket*.] A water-*cross*.—2. A kind of fire-work to be discharged in the water.

**WATER-ROT**, *v. t.* [*water* and *rot*.] To rot by steeping in water; as, to *water-rot* hemp or flax.

**WATER-ROTTED**, *pp.* Rotted by being steeped in water.

**WATER-ROTTING**, *ppr.* Rotting in water.

**WATER-SAIL**, *n.* [*water* and *sail*.] A small sail used under a studding sail or driver boom.

**WATER-SAPPHIRE**, *n.* [*water* and *sapphire*.] A kind of blue precious stone.

**WATER-SCORPION**, *n.* A name given to aquatic, hemipterous insects of the genus *Nepa*, Linn., (family Nepidæ,) from their fore legs being somewhat similar to those of the scorpion. They feed upon other aquatic insects.

**WATER-SHED**, *n.* A range of high land that casts the water in different directions.

**WATER-SHOOT**, *n.* [*water* and *shoot*.] A sprig or shoot from the root or stock of a tree. [*Local*.]—2. A wooden trough for discharging water from a building.

**WATER-SIDE**, *n.* The brink of water; bank of a stream or lake; the sea-shore.

**WATER-SNAKE**, *n.* [*water* and *snake*.] A snake that frequents the water; the *Coluber sipedon*, found in all parts of the United States.

**WATER-SOAK**, *v. t.* [*water* and *soak*.] To soak or fill the interstices with water.

**WATER-SOAKED**, *pp.* Soaked, or having its interstices filled with water; as, *water-soaked* wood; a *water-soaked* hat.

**WATER-SOLDIER**, *n.* A plant of the genus *Stratiotes*; the *S. aloides*. [See *STRATIOTES*.]

**WATER-SPANIEL**, *n.* [*water* and *spaniel*.] The name given to two varieties of the dog called spaniel, viz., the large *water-spaniel* and the small *water-spaniel*. The rough water-dog (*canis avarius aquaticus*), is sometimes called *water-spaniel*.

**WATER-SPEED'WELL**, *n.* A plant, the *Veronica maritima*, Linn.

**WATER-SPOUT**, *n.* [*water* and *spout*.] A remarkable meteorological phenomenon observed for the most part at sea, but sometimes over the land. Its general appearance at sea may be thus described:—Below a dense cloud the sea appears to be greatly agitated within a circular area from 100 to 120 yards in diameter, the waves tending rapidly to the centre of the agitated mass, where a vast body of water or aqueous vapour is formed: from hence there rises, with a spiral movement, towards the cloud, a column of a conical form resembling a trumpet. Vertically above this ascending column there is formed, in the cloud, but in an inverted position, a corresponding cone, whose apex gradually approaches that of the ascending column, and at length both are united, and the junction has been observed to be accompanied with a

flash of lightning. The water-spout is said to be accompanied also, during its formation, with a rumbling noise like thunder. The whole column, which after the junction of the two cones, extends from the sea to the clouds, assumes a magnificent appearance, being of a light colour near its axis, but dark along the sides. When acted on by the wind the column assumes a position oblique to the horizon, but in calm weather it maintains its vertical position, while at the same time it is carried along the surface of the sea. Sometimes the upper and lower parts move with different velocities, causing the parts to separate from each other, often with a loud report. The whole of the vapour is at length absorbed in the air, or it descends to the sea in a heavy shower of rain. When a water-spout occurs above land, there is consequently no ascending column of water to meet that which descends. Such water-spouts often burst, discharging immense torrents of rain, and causing great destruction. Water-spouts are supposed by some to be formed by whirlwinds of extreme intensity; while others ascribe their origin to electric agency.

**WATER-STANDING**, *† a.* Wet with water; as, a *water-standing* eye.

**WATER-STAR-WORT**, *n.* The common name of British plants of the genus *Callitriche*. [See *STAR-WORT*.]

**WATER-STATION**, *n.* In *railways*, a small reservoir of water, from which tanks may be replenished.

**WATER-TAB'BY**, *n.* A waved silk stuff.

**WATER-TABLE**, *n.* [*water* and *table*.] In *arch*, a string-course moulding, or other projection, so placed as to throw off water from the building.

**WATER-TATH**, *n.* In *England*, a species of coarse grass growing in wet grounds, and supposed to be injurious to sheep.

**WATER-THERMOM'ETER**, *n.* An instrument for ascertaining the precise degree of temperature at which water attains its maximum density. This is about 40°; and from that point downwards to 32°, or the freezing point, it expands, and it also expands from the same point upwards to 212°, or the boiling point. [See *WATER*.]

**WATER-THIEF**, *† n.* A pirate.

**WATER-TIGHT**, *a.* [*water* and *tight*.] So tight as to retain or not to admit water. A vessel, tube, or joint is said to be *water-tight* when it has that degree of closeness which prevents the passage of water.

**WATER-TRE'FOIL**, *n.* A plant, *Menyanthes trifoliata*. [See *MENYANTHES*.]

**WATER-VIOLET**, *n.* [*water* and *violet*.] A plant of the genus *Hottonia*; the *H. palustris*, called also *water-featherfoil*,—*which see*.

**WATER-WAG'TAIL**, *n.* See *WAG-TAIL*.

**WATER-WAL'LED**, *† a.* Encompassed by water.

**WATER-WAY**, *n.* [*water* and *way*.] In *ship building*, *water-ways* are the thick planks at the outside of the deck, wrought over the ends of the beams, and fitting against the inside of the top-timbers, to which, as well as to the ends of the beams, they are bolted, and thus form an important binding. Their inner edge is hollowed out to form a channel for water to run off the deck.

**WATER-WHEEL, n.** [*water* and *wheel*.] In *hydraulics*, an engine for raising water in large quantities; as the Persian wheel, wheels driven by water, and having cranks on their axles for working pumps.—2. A wheel moved by water, and employed to turn machinery. There are three kinds of water-wheels, the *overshot wheel*, the *undershot wheel*, and the *breast wheel*. [See *these terms*.] All water-wheels consist in common of a hollow cylinder or drum, revolving on a central axle or spindle, from which the power to be used is communicated, while their exterior surface is covered with vanes, float-boards, or cavities upon which the water is to act. Water may be made to act as a moving power against wheels by its weight, as in the overshot wheel; by its momentum, as in the undershot wheel; or by both combined, as in the breast wheel.

**WATER-WILLOW, n.** [*water* and *willow*.] A plant of the genus *Salix*, the *S. aquatica*, called also *water-sallow*.

**WATER-WINGS, n. plur.** Walls erected on the banks of rivers, next to bridges, to secure the foundations from the action of the current.

**WATER-WITH, n.** [*water* and *with*.] A tree which grows in Jamaica in parched districts, resembling a vine in size and shape. It is so full of clear sap or water, that, by cutting a piece two or three yards long, and merely holding the cut end to the mouth, a plentiful draught is obtained.

**WATER-WORKS, n. plur.** [*water* and *works*.] A term which, in its extended sense, is applied to all machines and engineering works for the purpose of raising, retaining, conducting, or distributing water; and also to contrivances for obtaining motive power from falls or currents of water. Taken in this wide sense, it would embrace aqueducts, conduits, canals, sluices, locks, fountains, pumps, water-wheels, and hydraulic engines generally. In a narrow sense, the term *water-works* is applied to the methods of simply conducting water in aqueducts, or in pipes for the supply of domestic consumption, or the working of machinery. It comprehends the methods of procuring the supplies necessary for these purposes, by means of pumps, water, or steam-engines. It also comprehends the subsequent management of the water thus conducted, whether in order to make the proper distribution of it according to the demand, or to employ it for the purpose of navigation by lockage, or other contrivances.

**WATER-WORN, n.** Worn away: rounded; smoothed by the action of running water or water in motion; as, *water-worn pebbles*.

**WATER-WÖRT, n.** The common name of two British species of aquatic plants of the genus *Elatine*. [See *ELATINE*.]

**WATERY, a.** Resembling water; thin or transparent, as a liquid; as, *watery humours*.

The oily and *watery* parts of the aliment  
*Arbuthnot.*

2. Tasteless; insipid; vapid; spiritless; as, *watery turnips*.—3. Wet; moist; abounding with water; as, *watery land*; *watery eyes*.—4. Pertaining to water; as, the *watery god*.—5. Consisting of water; as, a *watery desert*.—*Watery fusion*. In *chem.*, when a salt containing water of crystallization is exposed to heat, it is dissolved, if soluble, in its

own water, and this dissolution is termed *watery fusion*.—*Watery head*, a disease in sheep, otherwise called *staggers*, *sturdy*, *turnisick*, &c. [See *STAGGERS*.] In *her.*, *watery* is sometimes used for *wavy*, or *undic*.

**WATTLE, n.** [*Sax. watel*, a twig; allied perhaps to *withe*, *L. vitis*; that is, a shoot.] 1. Properly, a twig or flexible rod; and hence, a hurdle made of such rods.—2. The fleshy excrescence that grows under the throat of a cock or turkey, or a like substance on a fish.—3. A name given in Van Dieman's Land to various species of acacia, which yield gummy and astringent matters. *A. mollissima* is called silver wattle; *A. affinis*, black wattle.

**WATTLE, v. t.** To bind with twigs.—2. To twist or interweave twigs one with another; to plait; to form a kind of net-work with flexible branches; as, to *wattle* a hedge.

**WATTLE BIRD, n.** The *Glaucopis*, Linn., a bird of New Zealand, so called from the wattles or carbuncles under its chin.

**WATTLED, pp.** Bound or interwoven with twigs. *Wattled and combed*, in *her.*, terms used in English blazon to express the gills and comb of a cock, when borne of a different tincture from that of the body.

**WATTLING, ppr.** Interweaving with twigs.

**WAUGHT, } n.** [*Sax. weaht*.] A large  
**WAUGHT, }** draught of any liquid.  
[*Scotch*.]

**WAUL, v. i.** To cry as a cat.

**WAULING, ppr.** Crying as a cat.

**WAUR, v. t.** To overcome; to worst.  
[*Scotch*.]

**WAUR, a.** Worse. [*Scotch*.]

**WAVE, n.** [*Sax. weg, way*, a wave, a way; both the same word, and both coinciding with the root of *wag, waygon, vacillate, weigh*, &c. The sense is, a going, a moving, appropriately a moving one way and the other; *G. woge*; *Sw. vag*; *Ir. buaice*.] 1. A moving swell or volume of water; usually, a swell raised and driven by wind. A pebble thrown into still water produces *waves*, which form concentric circles, receding from the point where the pebble fell. But *waves* are generally raised and driven by wind, and the word comprehends any moving swell on the surface of water, from the smallest ripple to the billows of a tempest.

The *wave* behind impels the *wave* before.

*Pope.*

A *wave*, as it is generally observed, is an elevated portion of water travelling successively along the general surface. When the surface of water is unequally pressed upon, in parts contiguous to each other, the columns most pressed upon are shortened, and sink beneath the natural level of the surface, while those that are least pressed on are lengthened, and rise above that level. As soon as the former columns have sunk to a certain depth, and the latter have risen to a certain height, their motions are reversed, and continue so till the columns that were at first most depressed have become most elevated, and those that were most elevated have become most depressed. In this manner a reciprocating motion is produced, and a series of ridges and hollows is formed, which are called *waves*. When a *wave* of the sea is seen to ad-

vance towards the shore, the water appears to be moving in the same direction; but this is not the case, the only necessary motion of the water being in the vertical direction, so that the water may be perfectly at rest while the *wave* is moving, except this vertical ascent or descent; or it may be moving in any direction coincident with or opposed to the direction in which the *wave* is moving, without at all affecting the motion of the *wave*. The action of the wind upon the surface of the water is the principal cause of the waves which exist, and the height of the *wave* depends in a great measure on the depth of the water in which it is produced. In a sheet of water only a few feet deep the waves will rarely have a height exceeding a few inches; while the waves of the ocean frequently acquire a magnitude sufficient to hide from each other's view two vessels of the largest size, when only a small distance apart. The waves of the sea are of two kinds, *natural* and *accidental*. The natural waves are those which are exactly proportioned in size to the strength of the wind which gives rise to them. The accidental waves are those occasioned by the wind's reacting upon itself by repercussion from hills and mountains, or high shores, and by the washing of the waves themselves against rocks and shoals. Several series of waves moving in different directions may co-exist without destroying each other. Thus it may happen that while a long swell, resulting from some distant storm, is advancing in one direction, a breeze will produce a series of waves moving in the direction of the wind; and a second breeze springing up in another direction will produce a new series, which will become mixed with the former without destroying it. A third gale may also produce a series of waves intersecting the other systems. All these phenomena may be illustrated by throwing several stones into a pool of standing water, when as many series of waves, intersecting each other, will appear upon the surface. The *breadth* of a *wave* is equal to the space between the most elevated points of two adjoining waves, or between the lowest points of two adjoining hollows. A *wave* is said to have passed through its breadth when its elevated part is arrived at the place where the elevated part of the next *wave* stood before; or, the situation of two contiguous waves being given, when one of these has arrived at the place of the other; and the time which is employed in this transition is called the time of a *wave's* motion or the time of an undulation. A *wave* passes through its breadth in the time that a pendulum of half its length (that is, half the length of the surface of the water between the most elevated part of the ridge and the lowest part of the hollow) will perform two of its least vibrations. The *velocity* of a *wave* is the rate at which the points of greatest elevation or depression seem to change their places. *Tidal wave*, the great wave which is raised on the surface of the sea by the attractions of the sun and moon, and which moves from east to west. [See *TIDE*.]—*Artificial waves*, those which are produced by artificial means, as when a stone is thrown into a pool of water. Artificial waves serve to illus-

trate the phenomena of natural waves  
—2. Unevenness; inequality of surface.  
—3. The line or streak of lustre on  
cloth watered and calendered.—4. Any  
undulating motion; a motion resembling  
that of a wave.

**WAVE**, *v. i.* [Sax. *waftan*; probably a  
corrupt orthography.] 1. To play  
loosely; to move like a wave, one way  
and the other; to float; to undulate.  
His purple robes *wav'd* careless to the  
winds. *Trumbull.*

2. To be moved, as a signal.—3. † To  
fluctuate; to waver; to be in an un-  
settled state.

**WAVE**, *v. t.* [See **WAVER**.] To raise  
into inequalities of surface.—2. To  
move one way and the other; to  
brandish; as, to *wave* the hand; to  
*wave* a sword.—3. To waft; to remove  
any thing floating.—4. To beckon; to  
direct by a waft or waving motion.

**WAVE**, *v. t.* [Norm. *weyver*, to *wave* or  
*waive*; *waifnez*, *waved*; *wefes*, *welfs*,  
*waifs*.] 1. To put off; to cast off; to  
cast away; to reject; as, to *wave* goods  
stolen; usually written *waive*.—2. To  
quit; to depart from.

He resolved not to *wave* his way. *Wotton.*

3. To put off; to put aside for the  
present, or to omit to pursue; as, to  
*wave* a motion. He offered to *wave*  
the subject. [Usually written *waive*.]  
—4. To relinquish, as a right, claim, or  
privilege. [Generally written *waive*.  
See **WAIVE**.]

**WAVE-BORNE**, *a.* Thrown ashore by  
the waves.

**WAVED**, *pp.* Moved one way and the  
other; *brandished*.—2. Put off; omitted.  
[Usually written *waived*.]—3. *a.* In  
*her*., indented, undated. The same as  
*wavy* or *undée*.—4. Variegated in lustre;  
as, *waved* silk.—5. In *bot.*, undate;  
rising and falling in waves on the mar-  
gin, as a leaf.—6. In *entom.*, applied to  
insects when the margin of the body is  
marked with a succession of arched  
segments or incisions.

**WAVELESS**, *a.* Free from waves; un-  
disturbed; unagitated; as, the *wave-  
less* sea.

**WAVELET**, *n.* A small wave; a ripple  
on water.

**WAVELIKE**, *a.* Resembling a wave;  
undulating.

**WAVELLITE**, *n.* [from *Wavel*, the  
discoverer.] A mineral, a phosphate, or  
sub-phosphate of alumine; commonly  
found in crystals, which usually adhere  
and radiate, forming hemispherical or  
globular concretions, from a very small  
size to an inch in diameter. The form  
of the crystal is usually that of a rhom-  
bic prism with dihedral terminations.  
It occurs at Barnstaple in Devonshire,  
in Cornwall, near Cork, in Ireland, in  
Germany, Brazil, &c. It has also been  
called *hydrargillite*.

**WAVE-OFFERING**, *n.* In the Jewish  
ceremonial worship, an offering made  
with waving toward the four cardinal  
points; Numb. xviii.

**WAVER**, *v. i.* [Sax. *waftan*; Dan.  
*wæver*, from *wæver*, to weave, that is,  
to move one way and the other.] 1. To  
play or move to and fro; to move one  
way and the other.—2. To fluctuate;  
to be unsettled in opinion; to vacillate;  
to be undetermined; as, to *waver* in  
opinion; to *waver* in faith.

Let us hold fast the profession of our  
faith without *wavering*; Heb. x.

3. To totter; to reel; to be in danger  
of falling.

**WAVER**, *n.* A name given to a sapling  
or young timber tree. [*Local*.]

**WAVERER**, *n.* One who wavers; one  
who is unsettled in doctrine, faith, or  
opinion.

**WAVERING**, *ppr. or a.* Fluctuating;  
being in doubt; undetermined.

**WAVERINGLY**, *adv.* In a doubtful,  
fluctuating manner.

**WAVERINGNESS**, *n.* State or quality  
of being wavering.

**WAVE'SON**, *n.* A name given to goods  
which after shipwreck appear floating  
on the sea.

**WAVE-SUBJECTED**, *a.* Subject to  
be overhauled.

**WAVE-WORN**, *n.* [*wave* and *worn*]  
Worn by the waves.

The shore that o'er his *wave-worn* basis  
bow'd. *Shak.*

**WAVING**, *ppr.* Moving as a wave;  
playing to and fro; brandishing.

**WAVING**, *n.* Act of moving or playing  
loosely.

**WAVURE**, *n.* The act of waving or  
putting off.

**WAVY**, *a.* [from *wave*.] Rising or  
swelling in waves; full of waves; as,  
the *wavy* sea.—2. Playing to and fro;  
undulating.

Let her glad valleys smile with *wavy* corn.  
*Prior.*

3. Undulating on the border or on the  
surface; a botanical use.—4. In *her*.,  
formed like waves; undulating, as lines  
and charges. It is also written *wavé*,  
and is the same as *undée* or *undy*.

**WAVES** or **WAES**, † for *waves*.  
**WAWL**, † *v. i.* To cry. [See **WAWL**.]

**WAX**, *n.* [Sax. *wax*, *wex*; G. *wachs*;  
Russ. *voska*; L. *viscus, viscum*.] 1. A  
thick, viscid, tenacious substance, ex-  
creted by bees, from their bodies, and  
employed in the construction of their  
cells; usually called *bees' wax*. Its  
native colour is yellow, and it has a  
peculiar smell resembling honey, which  
is derived from the honey deposited in  
the cells. When bleached and freed  
from impurities, wax is white, brittle,  
and translucent in thin segments; it  
has neither taste nor smell; it has a  
specific gravity of from 0.960 to 0.966.  
It melts at 158° and softens at 86°,  
becoming so plastic that it may be  
moulded by the hand into any form.  
It is a mixture of two substances in  
very variable proportions; the one is  
called *cerine*, and the other *myricine*.  
Wax is extensively employed both in  
its original and bleached state; in the  
latter state it is used for candles, and  
in numerous cerates, ointments, and  
plasters. It is also used in forming  
figures or images, busts, &c., in the  
preparation of anatomical models, in  
the preparation of fruit, flowers, and  
many objects of natural history. In  
statuary it is used in making models  
for the metal cast. Wax exists also  
as a vegetable product, and may in this  
point of view be regarded as a concrete  
fixed oil. It may be obtained from the  
pollen of many flowers, and it forms a  
part of the green fecula of many plants,  
particularly of the cabbage. It appears  
as a varnish upon the fruit, and the  
upper surface of the leaves of many  
trees, as in the wax-palm and wax-  
myrtle.—2. A thick tenacious sub-  
stance excreted in the ear.—3. A sub-  
stance found on the hinder legs of  
bees, derived from the pollen of flowers.

This was long supposed to be the  
substance from which bees elaborated  
the wax for their cells, but this notion  
1212

is now found to be erroneous. The  
pollen collected by bees serves for the  
nourishment of their larvæ.—4. A  
substance used in sealing letters; called  
*sealing-wax*, or Spanish wax. This is  
a composition of lac and resin, coloured  
with some pigment.—5. A thick sub-  
stance used by shoemakers for rubbing  
their thread.—*Wax mineral*, a mineral  
like resinous wax, which is sometimes  
made into candles. It is otherwise  
called *ozocerite*.

**WAX**, *v. t.* To smear or rub with wax;  
as, to *wax* a thread or a table.

**WAX**, *v. i.* pret. *Waxed*; pp. *Waxed*  
or *Waxen*. [Sax. *waxan*; G. *wachsen*;  
Sw. *vaxa*; allied probably to L. *augeo*,  
*auxi*, Gr. *αἴξω*, and *αἴξω*.] 1. To in-  
crease in size; to grow; to become  
larger; as, the *waxing* and the *waning*  
moon.—2. To pass from one state to  
another; to become; as, to *wax* strong;  
to *wax* warm or cold; to *wax* feeble;  
to *wax* hot; to *wax* old; to *wax* worse  
and worse.

**WAX'-CANDLE**, *n.* [*wax* and *candle*.]  
A candle made of wax.

**WAX'-CHANDLER**, *n.* [*wax* and  
*chandler*.] A maker of wax-candles.

**WAX'-CLOTH**, *n.* Cloth covered with  
a coating of wax, commonly orna-  
mented with some figured pattern,  
and used as covers to tables, pianos,  
sideboards, &c. A thick kind, more  
properly styled oil-cloth, is used for  
covering lobbies, and parts of rooms,  
to protect carpets.

**WAX'ED**, *pp.* Smeared or rubbed with  
wax.

**WAX'EN**, *a.* Made of wax; as, *waxen*  
cells.

**WAX'-END**, } *n.* A thread pointed  
**WAX'ED-END**, } with a bristle, and  
covered with rosin (shoemakers' *wax*),  
used in sewing boots and shoes.

**WAX'ING**, *ppr.* Growing; increasing;  
becoming; smearing with wax.

**WAX'ING**, *n.* In *chem.*, the prepara-  
tion of any matter to render it fit for  
melting; also, the process of stopping  
out colours in calico-printing.

**WAX'-LIGHT**, *n.* A taper made of  
wax.

**WAX-MOD'ELLING**, *n.* The art of  
forming models and figures in wax;  
otherwise termed the *ceroplastic* art.  
[See **WAX**.]

**WAX'-MOTH**, *n.* A popular name  
given to various species of moths, of  
the genera *Ptychopoda*, *Emmelesia*,  
*Cabera*, &c.

**WAX-MYR'TLE**, *n.* The *Myrica ceri-  
fera*, or candleberry tree, a shrub of  
North America, the berries of which  
are covered with a greenish wax, called  
myrtle-wax, or bayberry tallow. [See  
*CANDLEBERRY-TREE* and *MYRICA-  
CEE*.]

**WAX-PAIN'TING**, *n.* Encaustic paint-  
ing. [See **ENCAUSTIC**.]

**WAX'-PALM**, *n.* A species of palm,  
the *Ceroxylon andicola*, found in South  
America. It is a native of the Andes,  
and is found chiefly between 4° and 5°  
of N. latitude, at an elevation of about  
5,000 feet above the sea-level, among  
rugged precipices. The *C. andicola*,  
unlike most other palms, avoids the  
heat of tropical plains, and thrives best  
where the temperature of the air is  
lowered by the proximity of perpetual  
snow. It is called *Palma de cera* by  
the Spaniards, and grows to the height  
of 180 feet. The trunk is marked by  
rings, caused by the falling off of the  
leaves, which are eighteen to twenty

feet long, and is covered with a thick secretion, consisting of two-thirds resin



Wax-Palm (*Ceroxylon andicola*).

and one-third wax. The only other palm which exudes wax, and that in a sort of scales from the palmate leaves, is the *Carnauba* palm, found plentifully in Brazil.

**WAX'-WING**, *n.* The common name of the species of denterostral birds, of the genus *Bombycilla*. They are so named because most of them have small, oval, horny appendages on the secondaries of the wings, of the colour of red sealing-wax. Only three species have been recorded, viz., the Bohemian wax-wing, or chattering (*B. garrula*), a migratory bird, which has a wide geographical range; the American wax-wing, or cedar-bird (*B. carolinensis*), which is confined to North America; and the red-winged chattering, or Japanese wax-wing (*B. phenicoptera*), an Oriental bird.

**WAX'-WORK**, *n.* Figures formed of wax, in imitation of real beings; also anatomical preparations in wax, preparations in wax of fruit, flowers, &c.

**WAX'Y**, *a.* Soft like wax; resembling wax; viscid; adhesive.—2. Moist; not floury; as, a *waxy* potato. [*Familiar.*]

**WAY**, *n.* [*Sax. weg, weg*; *G. and D. weg*; *L. and It. via*; *Fr. voie*; coinciding in origin with *wag, weigh, waggon, vogue, &c.*] 1. Literally, a passing; hence, a passage; the place of passing; hence a road of any kind; a highway; a private road; a lane; a street; any place for the passing of men, cattle, or other animals; a word of very comprehensive signification.—2. Length of space; as, a great way; a little way.—3. Course; direction of motion or travel. What way did he take? Which way shall I go? Keep in the way of truth and knowledge.

Mark what way I make. *Shak.*

4. Passage; room for passing. Make way for the jury.—5. Course or regular course.

And let eternal justice take the way. *Dryden.*

6. Tendency to any meaning or act. There is nothing in the words that sounds that way. *Atterbury.*

7. Sphere of observation. The general officers and the public ministers that fell in my way. *Temple.*

8. Manner of doing any thing; method; means of doing. Seek the best way of learning, and pursue it.

By noble ways we conquests will prepare.

*Dryden.*

9. Method; scheme of management. What impious ways his wishes took. *Prior.*  
10. Manner of thinking or behaviour; particular turn of opinion; determination or humour. Let him have his way, when that will not injure him, or any other person. But multitudes of children are ruined by being permitted to have their way.—11. Manner; mode. In no way does this matter belong to me. We admire a person's way of expressing his ideas.—12. Method; manner of practice. Find, if you can, the easiest way to live.

Having lost the way of nobleness. *Sidney.*

13. Method or plan of life and conduct. Instruct your children in the right way.

Her ways are ways of pleasantness, and all her paths are peace; Prov. iii.

All flesh had corrupted his way; Gen. vi.  
14. Course; process of things, good or bad. Things are in a prosperous way.

15. Right method to act or know.

We are quite out of the way. *Locke.*

16. General scheme of acting.

Men who go out of the way to hint free things, must be guilty of absurdity or rudeness. *Clarissa.*

17. Sect; denomination of a particular faith, creed or worship; Acts xix. 23.

—18. In law, a term used to denote either a right, in one person or more, of passing over the land of another, or the space over which such right is exercisable. Four species of way are known to the law:—1. A foot-way; 2. A horse-way, which includes a foot-way; 3. A carriage-way, which includes both a horse-way and a foot-way; 5. A drift-way, for driving cattle. To these may be added a water-way for ships and boats. A right of way may be either public or private. A public way is one which is open to the public, to the king, (queen), and to all persons who are either permanently or temporarily his (her) subjects. A private way is a right which particular persons or classes have of going over the land of another. This right arises either by a deed or grant, usage or prescription, custom, or some express agreement or declaration.—19. Among seamen, the progress or motion of a ship through the water.—*Bilge-ways* or *launching-ways*, a square bed of timber placed under a vessel's bilge to support her while launching.—*To make way*, to give room for passing; or to make a vacancy.—*To give way*, to recede; to make room; or to yield; to concede the place or opinion to another.—*To make one's way*, to advance in life by efforts; to advance successfully.—*By the way, en passant*, as we proceed; a phrase introducing something in discourse, not immediately connected with the subject.—*To go one's way*, or *to come one's way*, to go or come along.—*To go the way of all the earth*, to die.—*In the way*, a phrase noting obstruction. What is there in the way of your success? In scrip., the ways of God are his providential government or his works; Rom. xi.; Job xl.—*Way and ways* are used in certain phrases, in the sense of *wise*. He is no ways a match for his antagonist.

'Tis no way the interest even of the priesthood. *Pope.*

*To be under way*, in seamen's language, to be in motion, as when a ship begins to move. So a ship is said to have *head-way*, when she moves forward in her course, and *stern-way*, when she is driven astern. She is said also to *gather way*, or *to lose way*. *Lee-way* is a movement of a ship aside of her course, or to the leeward.—*Milky way*, in astron., the galaxy; a broad luminous belt or space in the heavens, supposed to be occasioned by the blended light of an immense number of stars. By means of a telescope of uncommon magnifying powers, Dr. Herschel has been able to ascertain this fact, by distinguishing the stars.—*Covert way*, in fort., a passage covered from the enemy's fire.—*Ways and means*, in legislation, means for raising money; resources for revenue. In parliament, when supplies have been voted, the house of commons resolve themselves into a committee of *ways and means*; that is, a committee to consider the ways and means of raising the sum voted.—*Way-going crop*, among farmers, is the crop which is taken from the ground the year the tenant leaves the farm.

**WAY-BAGGAGE**, *n.* The baggage or effects of a way-passenger on a railroad, or in a stage-coach. [*American.*]

**WAY-BENNET**, *n.* A British plant of the genus *Hordeum*, the *H. murinum*, called also wall-barley. [*See HORDEUM.*]

**WAY-BILL**, *n.* A list of passengers in a public vehicle.

**WAY-BREAD**, *n.* A name given to the herb plantain, (*Plantago major*.)

**WAY-FARER**, *n.* [*way and fare*, *Sax. faran*, to go.] A traveller; a passenger.

**WAYFARING**, *a.* [*supra.*] Travelling; passing; being on a journey; Judges xix.

**WAYFARING-TREE**, *n.* A shrub, a species of *Viburnum*, the *V. lantana*; called also mealy guelder-rose. [*See VIBURNUM.*]

**WAYHTES**. The same as *waits*,—*which see.*

**WAY'GOING**, *a.* In farming, the way-going crop is that which is taken from the land the year the tenant leaves a farm.

**WAYLAID**, *pp.* Watched in the way. [*See WAYLAY.*]

**WAYLAY**, *v. t.* [*way and lay.*] To watch insidiously in the way, with a view to seize, rob, or slay; to beset in ambush; as, to waylay a traveller. [*In this word there is little difference of accent.*]

**WAYLAYER**, *n.* One who waits for another in ambush, with a view to seize, rob, or slay him.

**WAY-LEAVE**, *n.* Purchased right of way. Generally applied to liberty granted for the laying of water pipes, making of sewers, &c., through private property, where the surface of the ground is only occupied by the work during their execution.

**WAYLESS**, *a.* Having no road or path; pathless; trackless.

**WAY-MAKER**, *n.* One who makes a way; a precursor.

**WAY-MARK**, *n.* [*way and mark*] A mark to guide in travelling; Jer. xxxi.

**WAYMENT**, *† v. i.* [*Sax. wa, woe.*] To lament.

**WAY-PANE**, *n.* A slip left for cartage in watered land. [*Local.*]

**WAY-PASSENGER**, *n.* A passenger on a railroad, &c., taken up at some intermediate station or place. [*American.*]

**WAYSIDE, n.** The side of the road or highway.

**WAY-THISTLE, n.** A plant of the genus *Cnicus*, the *C. arvensis*, called also field-thistle and creeping plume thistle.

**WAYWARD, a.** [*way* and *ward*.] Froward; peevish; perverse; liking his own way.

*Wayward beauty doth not fancy move.*

*Fairfax*

**WAY-WARDEN, n.** In local usage, the surveyor of a road.

**WAYWARDLY, adv.** Frowardly; perversely.

**WAYWARDNESS, n.** Frowardness; perverseness.

**WAYWISE, a.** Expert in finding or keeping the way.

**WAYWISER, n.** An instrument for measuring the distance which one has travelled on the road; called also perambulator, and podometer, or pedometer.

**WAYWODE, } n.** [Slav. *voyna*, war, *vaiwode*, } and *vodit*, to lead.] A name originally given to military commanders in various Slavonic countries, and afterwards to governors of towns or provinces. It was assumed for a time by the rulers of Moldavia and Wallachia, who are now called *Hospodars*, and it was also given to some minor Turkish officers.

**WAYWODESHIP, n.** The province or jurisdiction of a waywode.

**WAYWORN, a.** Weared by travelling.

**WE, pron. plur. of I;** or rather a different word, denoting the person speaking and another or others with him. *I* and *John*, the speaker calls *we*, or *I* and *John* and *Thomas*; or *I* and many others. In the objective case, *us*. *We* is used to express men in general, including the speaker.

Vice seen too oft, familiar with her face

*We* first endure, then pity, then embrace.

*Pope.*

**WEAK, a.** [Sax. *waac*, *wace*; G. *weich*, *schwach*.] The primary sense of the root is to yield, fail, give way, recede, or to be soft. 1. Having little physical strength; feeble. Children are born *weak*; men are rendered *weak* by disease.—2. Infirm; not healthy; as, a *weak* constitution.—3. Not able to bear a great weight; as, a *weak* bridge; *weak* timber.—4. Not strong; not compact; easily broken; as, a *weak* ship; a *weak* rope.—5. Not able to resist a violent attack; as, a *weak* fortress.—6. Soft; pliant; not stiff.—7. Low; small; feeble; as, a *weak* voice.—8. Feeble of mind; wanting spirit; wanting vigour of understanding; as, a *weak* prince; a *weak* magistrate.

To think every thing disputable, is a proof of a *weak* mind and captious temper.

*Bentley.*

9. Not much impregnated with ingredients, or with things that excite action, or with stimulating and nourishing substances; as, *weak* broth; *weak* tea; *weak* toddy; a *weak* solution; a *weak* decoction.—10. Not politically powerful; as, a *weak* nation or state.—11. Not having force of authority or energy; as, a *weak* government.—12. Not having moral force or power to convince; not well supported by truth or reason; as, a *weak* argument.—13. Not well supported by argument; as, *weak* reasoning.—14. Unfortunate; accessible; impassible; as, the *weak* side of a person.—15. Not having full conviction or confidence; as, *weak* in faith.—16. *Weak* land is land of a light thin soil.

**WEAK, † v. t.** To make weak.

**WEAK, † v. i.** To become weak.

**WEAKEN, v. t.** (wee'kn.) [Sax. *wacan*, to languish, to vacillate.] 1. To lessen the strength of, or to deprive of strength; to debilitate; to enfeeble; as, to *weaken* the body; to *weaken* the mind; to *weaken* the hands of the magistrate; to *weaken* the force of an objection or an argument.—2. To reduce in strength or spirit; as, to *weaken* tea; to *weaken* any solution or decoction.

**WEAKENED, pp.** Debilitated; enfeebled; reduced in strength.

**WEAKENER, n.** He or that which weakens.

**WEAKENING, ppr.** Debilitating; enfeebling; reducing the strength or vigour of any thing.—2. *a.* Having the quality of reducing strength.

**WEAK-EYED, a.** Having weak eyes.

**WEAK-HANDED, a.** Having little strength.

**WEAK-HEADED, a.** Having a weak intellect.

**WEAK-HEARTED, a.** Having little courage; dispirited.

**WEAKLING, n.** A feeble creature.

**WEAKLY, adv.** Feebly; with little physical strength; faintly; not forcibly; as, a fortress *weakly* defended.—2. With want of efficacy.

Was plighted faith so *weakly* seal'd above?

*Dryden.*

3. With feebleness of mind or intellect; indiscreetly; injuriously.

Beneath pretended justice *weakly* fall.

*Dryden.*

4. Timorously; with little courage or fortitude.

**WEAKLY, a.** Not strong of constitution; infirm; as, a *weakly* woman; a man of a *weakly* constitution.

**WEAKNESS, n.** Want of physical strength; want of force or vigour; feebleness; as, the *weakness* of a child; the *weakness* of an invalid; the *weakness* of a wall or bridge, or of thread or cordage.—2. Want of sprightliness. Soft without *weakness*; without glaring, gay.

*Pope.*

3. Want of steadiness.

By such a review, we shall discern and strengthen our *weaknesses*.

*Rogers.*

4. Infirmary; unhealthiness; as, *weakness* of constitution.—5. Want of moral force or effect upon the mind; as, the *weakness* of evidence; the *weakness* of arguments.—6. Want of judgment; feebleness of mind; foolishness.

All wickedness is *weakness*.

*Milton.*

7. Defect; failing; fault; with a plural.

Many take pleasure in spreading abroad the *weaknesses* of an exalted character.

*Spectator.*

**WEAKSIDE, n.** [*weak* and *side*.] Foible; deficiency; failing; infirmity; that part of a person's natural disposition by which he is most easily warped or won.

**WEAK-SIGHTED, a.** Having weak sight.

**WEAK-SPIRITED, a.** Having weak spirits.

**WEAL, n.** [Sax. *wela*; G. *wohl*; Dan. *vel*; from the same root as *well*, Sw. *väl*; L. *valere*, to be strong, to avail, to prevail. The primary sense of *weal* is strength, soundness, from the sense of straining, stretching, or advancing.]

1. A sound state of a person or thing; a state which is prosperous, or at least not unfortunate, not declining; prosperity; happiness.

As we love the *weal* of our souls and bodies.

*Bacon.*

The *weal* or wo in thee is plac'd.

*Milton.*

So we say, the public *weal*, the general *weal*, the *weal* of the nation or state.—2. Republic; state; public interest; the commonweal. [But we now use *commonwealth*, in the sense of *state*.]

**WEAL, n.** The mark of a stripe. [See *WALE*.]

**WEAL, v. t.** To mark with stripes. [See *WALE*.]

**WEALD, n.** In Saxon and other Teutonic dialects, signifies a *WALD*, wood or forest, a woody place or woody waste. It is found in names, as in *Walt-ham*, wood-house; corruptly pronounced *Wal-tham*. It is also the name given to a valley or tract of country, lying between the North and South Downs of Kent and Sussex in England.

**WEALD-CLAY, n.** The upper portion of the Wealden formation, composed of beds of clay, sandstone, calcareous sandstone, conglomerate limestone, and ironstone. The clay is of a bluish or brownish colour, tenacious, somewhat indurated and slaty. The limestone is often concretionary, and usually contains fresh-water shells of the genus *Paludina*. The weald clay forms the subsoil of the Wealds of Sussex and Kent, separating the Shanklin sands from the Hasting beds.

**WEALDEN FORMATION, } n.** The

**WEALDEN STRATA, } name** given by English geologists to a series of rocks lying beneath the greensand, and resting above the oolite, and under chalk, in the Wealds of Kent and Sussex. They form a series of sandstones and clays, with layers and nodules of limestone. The lowest part is named Purbeck limestone, and is composed of fresh-water shells, united by a calcareous cement. It is slaty, argillaceous, of a brownish colour, alternates with slaty marl, and sometimes contains beds of compact limestone. Above this series is the Hasting sand, composed of yellowish grains of sand, very loosely coherent, alternating with beds of clay and conglomerate, containing fragments of bones and scales of fishes. The shells and remains of vertebrate animals which occur in this part of the series are of fluviatile origin. The upper portion of the Wealden formation is the Weald clay. [See *WEALD-CLAY*.] The organic remains of the Wealden consist of leaves, stems, and branches of plants of a tropical character, bones of enormous reptiles of extinct genera [see *IGUANODON*], of crocodiles, turtles, flying reptiles and birds, fishes of several genera and species, and fresh-water shells. No bones of mammalia have as yet been found in the Wealden deposits.

**WEALSMAN, n.** [*weal* and *man*.] A name given sneeringly to a politician.

**WEALTH, n.** (welth.) [from *weal*; Sax. *welga*, *welga*, rich.] 1. † Prosperity; external happiness.—2. Riches; large possessions of money, goods, or land; that abundance of worldly estate which exceeds the estate of the greater part of the community; affluence; opulence. Each day new *wealth* without their care provides.

3. Among *political economists*, the means of obtaining the products of labour. An individual is said to be rich or wealthy according to the degree in which he can afford to command those necessities, conveniences, and luxuries which are the products



of human industry; and a nation is said to be rich or wealthy in the aggregate according to its means of enjoying such advantages. It is laid down as a fundamental principle by political economists, that labour is the only source of wealth; and political economy treats mainly of the means of promoting the increase of national wealth, and of removing obstructions to its development.

WEALTH'GIVING, *a.* Yielding wealth.

WEALTHIER, *a. comp.* More wealthy.

WEALTHIEST, *a. superl.* Most wealthy.

WEALTHILY, *adv.* Richly.

WEALTHINESS, *n.* State of being wealthy; richness.

WEALTHY, *a.* Rich; having large possessions in lands, goods, money, or securities, or larger than the generality of men; opulent; affluent. As wealth is a comparative thing, a man may be *wealthy* in one place, and not so in another. A man may be deemed *wealthy* in a village, who would not be so considered in London.—2. In *political economy*. [See WEALTH.]

WEAN, *v. t.* [Sax. *wenan*, *gewenan*, to accustom; from the root of *wone*, *wont*; *gewonian*, to delay; D. *wenan*, *afwennan*; G. *entwöhnen*. See WONT.] 1. To separate from the breast, or from the mother's milk as food; to accustom and reconcile, as a child or other young animal, to a want or deprivation of the breast.

And the child grew and was weaned; Gen. xxi.

2. To detach or alienate, as the affections, from any object of desire; to reconcile to the want or loss of any thing; as, to *wean* the heart from temporal enjoyments.

WEAN, *n.* An infant; a child. [Scotch.] WEANED, *pp.* Separated from the breast; accustomed or reconciled to the want of the breast or other object of desire.

WEANEL, † *n.* Same as weanling.

WEANING, *ppr.* Separating from the breast; accustoming or reconciling, as a young child or other animal, to a want of the breast; reconciling to the want of any object or desire.

WEANING, *n.* The act of separating a child from the partaking of its mother's milk as food, and of accustoming or reconciling it to the want of such food. The proper time for weaning must depend, in some measure, both on the development and health of the child, and the state and health of the mother.

WEANLING, *n.* A child or other animal newly weaned.

WEAPON, *n.* (wep'n.) [Sax. *wæpn*, *wæpn*; D. and G. *wapen*. This word seems to be from some root signifying to strike, L. *vapulo*, our vulgar *wchap*, *wchap*.] 1. Any instrument of offence; any thing used or designed to be used in destroying or annoying an enemy. The weapons of rude nations are clubs, stones, and bows and arrows. Modern weapons of war are swords, muskets, pistols, cannon, and the like.—2. An instrument for contest, or for combating enemies.

The weapons of our warfare are not carnal; 2 Cor. x.

3. An instrument of defence.—4. Weapons, in *bot.*, arms; thorns, prickles, and stings, with which plants are furnished for defence; enumerated among the *fulcres* by Linnæus.

WEAPONED, *a.* (wep'nd.) Armed; furnished with weapons or arms; equipped.

WEAPONLESS, *a.* Unarmed; having no weapon.

WEAPON-SALVE, † *n.* [*weapon* and *salve*.] A salve which was supposed to cure the wound, by being applied to the weapon that made it.

WEAR, *v. t.* pret. *Wore*; pp. *Worn*. [W. *gvariau*, to spend or consume; Sax. *weran*, *werian*, to carry, to wear, as arms or clothes.] 1. To waste or impair by rubbing or attrition; to lessen or diminish by time, use, or instruments. A current of water often wears a channel in limestone.—2. To carry appendant to the body, as clothes or weapons; as, to wear a coat or a robe; to wear a sword; to wear a crown.

On her white breast a sparkling cross she wore. Pope.

3. To have or exhibit an appearance; to bear; as, she wears a smile on her countenance.—4. To affect by degrees.

Trials wear us into a liking of what possibly, in the first essay, displeased us. Locke.

5. In navigation, to bring a vessel upon the other tack by turning her round, stern toward the wind. It is also written *Veer*.—To wear away, to consume; to impair, diminish, or destroy by gradual attrition or decay.—To wear off, to diminish by attrition or slow decay.—To wear out, to consume, to render useless by attrition or decay; as, to wear out a coat or a book.—2. To consume tediously; as, to wear out life in idle projects.—3. To harass; to tire.

He shall wear out the saints of the Most High; Dan. vii.

4. To waste the strength of; as, an old man worn out in the service of his country.

WEAR, *v. i.* To be wasted; to be diminished by attrition, by use, or by time.

Thou wilt surely wear away; Exod. xviii.

2. To be tediously spent.

Thus wore out night. Milton.

3. To be consumed by slow degrees. It is better to wear out, than to rust out.—To wear off, to pass away by degrees. The follies of youth wear off with age.

WEAR, *n.* The act of wearing; diminution by friction; as, the wear and tear of a garment.—2. The thing worn.—Wear and tear, the loss by wearing, the waste, diminution, decay, or injury which any thing sustains by ordinary use; as, the wear and tear of machinery; the wear and tear of furniture.—Wear and tear of a ship, its ordinary decay and deterioration arising from the prosecution of a voyage or voyages; and all those losses and damages which occur under ordinary circumstances, for which the insurers are not liable.

WEAR, *n.* [Sax. *wær*, *wer*; from the root of *werian*, to hold, defend, protect; D. *waeren* or *weeren*. See WARREN and GUARD.] 1. A dam in a river to stop and raise the water, for conducting it to a mill, for taking fish, for watering land, &c.—2. A fence of stakes or twigs set in a stream for catching fish. [This word is frequently spelt *weir*, and sometimes *wier*. See WEIR.]

WEARABLE, *a.* That can be worn.

WEARD, Sax. a warden, in names, de-

notes watchfulness or care; but it must not be confounded with *ward*, in *to-ward*.

WEARER, *n.* [from *wear*.] One who wears or carries as appendant to the body; as, the wearer of a cloak, a sword, or a crown.—2. That which wastes or diminishes.

WEARIABLE, *a.* That may become weary.

WEARIED, *pp.* Tired; fatigued.

WEARIFUL, *a.* Causing weariness; wearisome. [Rarely used.]

WEARIFULLY, *adv.* Wearisomely. [Rarely used.]

WEARILESS, *a.* Incessant. [Rarely used.]

WEARILY, *adv.* In a weary or tire-some manner.

WEARINESS, *n.* [from *weary*.] The state of being weary or tired; that lassitude or exhaustion of strength which is induced by labour; fatigue. With weariness and wine oppress'd.

2. Lassitude; uneasiness proceeding from continued waiting, disappointed expectation, or exhausted patience, or from other cause.

WEARING, *ppr.* Bearing on or appendant to the person; diminishing by friction; consuming.—2. *a.* Denoting what is worn; as, wearing apparel.

WEARING, † *n.* Clothes; garments.—2. In navigation. [See VEERING.]

WEARISH, † *a.* Buggy; watery.—2. † Weak; washy.

WEARISOME, *a.* [from *weary*.] Causing weariness; tiresome; tedious; fatiguing; as, a wearisome march; a wearisome day's work.

Wearisome nights are appointed to me; Job vii.

WEARISOMELY, *adv.* Tediously; so as to cause weariness.

WEARISOMENESS, *n.* The quality of exhausting strength or patience; tiresomeness; tediousness; as, the wearisomeness of toil, or of waiting long in anxious expectation.

WEARY, *a.* [Sax. *wærig*; allied perhaps to *wear*.] 1. Having the strength much exhausted by toil or violent exertion; tired; fatigued. [It should be observed however that this word expresses less than *tired*, particularly when applied to a beast; as, a *tired* horse. It is followed by *of*, before the cause of fatigue; as, to be *weary of* marching; to be *weary of* reaping; to be *weary of* study.]—2. Having the patience exhausted, or the mind yielding to discouragement. He was *weary of* asking for redress.—3. Causing weariness; tiresome; as, a *weary* way; a *weary* life.

WEARY, *v. t.* [from the adjective.] To reduce or exhaust the physical strength of the body; to tire; to fatigue; as, to *weary* one's self with labour or travelling.

The people shall weary themselves for very vanity; Hab. ii.

2. To make impatient of continuance. I stay too long by thee; I weary thee. Shak.

3. To harass by any thing irksome; as, to be *weary'd* of waiting for the arrival of the post.—To *weary out*, to subdue or exhaust by fatigue.

WEARYING, *ppr.* Exhausting the strength of the body; fatiguing.

WEASAND, *n.* (s as z) [Sax. *wæsand*, *wæsend*; perhaps from the root of *wæchee*, and Goth. *and*, Dan. *aand*, *breath*.] The windpipe or trachea;

the canal through which air passes to and from the lungs.

**WEASEL**, *n.* (*s* as *z*.) [Sax. *wesle*; *G. wiesel*; *D. weasel*. We know not the meaning of this name. In *G. wiese* is a meadow.] *Mustela*, a genus of digitigrade carnivorous animals, belonging to the family Mustelidae. The true weasels are distinguished by the length and slenderness of their bodies; the feet are short, the toes separate, and the claws sharp. The common weasel (*M. vulgaris*), inhabits many countries



Common Weasel (*Mustela vulgaris*).

of Europe, and is very abundant in North America. The body is extremely slender and arched, the head small and flattened, the neck very long, the legs short, and also the tail. It is of a reddish-brown colour above, white beneath; tail of the same colour as the body. It feeds on mice, rats, moles, and small birds, and is often useful as a destroyer of vermin in ricks, barns, and granaries. The ermine weasel, or ermine, is the *M. erminea*; the fitchet weasel, or polecat, is the *M. putorius*; the *M. martes* is the marten, and the *M. zibellina* is the sable. [See *MUSTELIDÆ*.]

**WEASEL-COOT**, *n.* A bird, the red headed smew, or *Mergus minutus*.

**WEASEL-FACED**, *a.* Having a thin sharp face like a weasel.

**WEASEL-SNOUT**, *n.* A British plant of the genus *Galeobdolon*, the *G. luteum*. [See *GALEOBDOLO*.]

**WEATHER**, *n.* (weth'er.) [Sax. *weder*, *wæder*, or *wether*; *G. wether*; *Sans. widara*, a storm. The primary sense of this word, is air, wind, or atmosphere; probably the Gr. *αἰθήρ*, whence ether.] Properly, the air; hence, 1. The state of the air or atmosphere with respect to heat or cold, wetness or dryness, calm or storm, clearness or cloudiness, or any other meteorological phenomena; as, warm *weather*; cold *weather*; wet *weather*; dry *weather*; calm *weather*; tempestuous *weather*; fair *weather*; cloudy *weather*; hazy *weather*, and the like. The investigation of the various causes which determine the state of the atmosphere, and produce those changes which are incessantly taking place in its condition, forms the subjects of *meteorology* and *climate*. The state of the weather has in all ages and in every country, occupied a large share of the attention of naturalists, as well as of ordinary observers; but the subject is so complicated, and the circumstances to be taken into account so numerous, that no theory hitherto framed, can furnish rules for determining the order in which the changes of the weather succeed each other, or for predicting the state of the weather at a future time, with any degree of certainty.—2. Change of the state of the air.—3. Storm; tempest. [These last significations are not now in use, unless by a poetic license.]—*Stress of*

*weather*, violent winds; force of tempests.

**WEATHER**, *v. t.* (weth'er.) To air; to expose to the air. [Rarely used.]—2. In *seamen's language*, to sail to the windward of something else; as, to *weather* a cape; to *weather* another ship. As this is often difficult, hence, 3. To bear up and resist, though with difficulty; as, to *weather* the storm.—4. To endure a tempest unharmed, through an exertion of nautical skill; as, the pilot that *weathered* the storm.—To *weather* a point, to gain or accomplish it against opposition.—To *weather* out, to endure; to hold out to the end; as, to *weather* out a storm.—*Weather* is used with several words, either as an adjective, or as forming part of a compound word.

**WEATHER-BEATEN**, *a.* [*weather* and *beaten*.] Beaten or harassed by the weather.

**WEATHER-BIT**, or **BITT**, *n.* A turn of the cable about the end of the windlass, so as to prevent it from slipping round the windlass when the ship is at anchor.

**WEATHER BOARD**, *n.* That side of a ship which is toward the wind; the windward side. So in other words, *weather* signifies toward the wind or windward; as, in *weather-bow*, *weather-braces*, *weather-gage*, *weather-lifts*, *weather-quarter*, *weather-shrouds*, *weather-side*, *weather-shore*, &c.—2. A board forming a close junction between the shingling of a roof, and the side of the building beneath, usually at the ends where there is no cornice.

**WEATHER-BOARD**, *v. t.* To nail boards lapping one over another, in order to prevent rain, snow, &c., from penetrating them.

**WEATHER-BOARDING**, *n.* In *Arch.*, boards nailed with a lap on each other, to prevent the penetration of the rain and snow.

**WEATHER-BOARDS**, *n.* Pieces of planks laid in the ports of a ship, when laid up in ordinary. They are fixed in an inclined position, so as to turn off the rain without preventing the circulation of air.

**WEATHER-BOUND**, *a.* Delayed by bad weather.

**WEATHER-CLOTHS**, *n.* Long pieces of canvass or tarpauling used to preserve the hammocks from injury by the weather when stowed, or to defend persons from the wind and spray.

**WEATHER-COCK**, *n.* [*weather* and *cock*.] Something in the shape of a cock placed on the top of a spire, which by turning, shows the direction of the wind; a vane, or weather-vane.—2. Any thing or person that turns easily and frequently; a fickle, inconstant person.

**WEATHER-DRIVEN**, *n.* [*weather* and *driven*.] Driven by winds or storms; forced by stress of weather.

**WEATHERED**, *pp.* Passed to the windward; passed with difficulty.—2. In *mineral*, a term applied to a specimen when the surface is altered in colour, texture, or composition, or the edges rounded off, by exposure to the weather. In *geol.*, a rock is said to be *weathered*, when its surface undergoes similar changes from the same cause.—3. In *Arch.*, a term applied to surfaces which have a small slope or inclination given to them to prevent water lodging on them; as window sills, the tops of classic cornices, and

the upper surface of most flat stone-work.

**WEATHER-FEND**, *v. t.* [*weather* and *fend*.] To shelter.

**WEATHER-GAGE**, } *n.* [*weather*  
**WEATHER-GAUGE**, } and *gage*.]  
Something that shows the weather. *Qu.*—2. In *mar. lan.*, the advantage of the wind; the state or situation of one ship to the windward of another, when in action.—3. Advantage of position; superiority. A ship is said to have the *weather-gage* of another, when she is at the windward of her.

**WEATHER-GALL**, *n.* A secondary rainbow or a portion of a rainbow, the appearance of which is said to indicate bad weather. [Local.]

**WEATHER-GLASS**, *n.* [*weather* and *glass*.] An instrument to indicate the state of the atmosphere. This word is generally applied to the barometer; but it is also applied to other instruments for measuring atmospheric changes, and indicating the state of the weather; as, the thermometer, hygrometer, manometer, and anemometer.

**WEATHER-HELM**, *n.* [*weather* and *helm*.] A ship is said to carry a *weather-helm*, when owing to her having a tendency to gripe, the helm requires to be kept a little to windward, or *a-weather*, in order to prevent her head from coming up in the wind while sailing closehauled.

**WEATHER-HOUSE**, *n.* A piece of mechanism to show the state of the weather.

**WEATHERING**, *ppr.* Passing or sailing to the windward; passing with difficulty.

**WEATHERING**, *n.* Exposure to the weather. In *geol.*, the action of the elements on a rock in altering its colour, texture, or composition, or in rounding off its edges. In *Arch.*, inclining a surface so as to throw off the water.

**WEATHERLY**, *a.* A ship is said to be *weatherly*, when she holds a good wind; that is, when she presents so great a lateral resistance to the water while sailing closehauled, that she makes very little lee-way.

**WEATHERMOST**, *a.* [*weather* and *most*.] Being furthest to the windward.

**WEATHER-MOULDINGS**, *n.* In *Arch.*, dripstones or canopies over doors and windows, intended to throw off the rain.

**WEATHER-PROOF**, *a.* [*weather* and *proof*.] Proof against rough weather.

**WEATHER-QUARTER**, *n.* The quarter of a ship which is on the windward side.

**WEATHER-ROLL**, *n.* [*weather* and *roll*.] The roll of a ship to the windward, in a heavy sea, upon the beam; opposed to *lee-lurch*.

**WEATHER-SHORE**, *n.* The shore which lies to windward of a ship.

**WEATHER-SIDE**, *n.* The *weather-side* of a ship under sail is that side upon which the wind blows, or which is to windward.

**WEATHER-SPY**, *n.* [*weather* and *spy*.] A star-gazer; one that foretells the weather. [Little used.]

**WEATHER-TIDE**, *n.* [*weather* and *tide*.] The tide which sets against the lee-side of a ship, impelling her to the windward.

**WEATHER-TILING**, *n.* In *Arch.*, tiles used to cover wooden erections to protect them from the weather.

**WEATHER-TINTED**, *a.* Tinted by the weather.

**WEATHER-WISE**, *a.* [*weather* and *wise*.] Skillful in foreseeing the changes or state of the weather.

**WEATHER-WISER**, † *n.* Something that foreshows the weather.

**WEAVE**, *v. t.* pret. *Wove*; pp. *Woven*, *wove*. The regular form, *waved*, is rarely or never used. [Sax. *wefan*; G. *weben*; D. *weeven*; Pers. *baftan*; Gr. *uφwaw*.] 1. To unite threads of any kind in such a manner as to form cloth. This is done by crossing the threads by means of a shuttle. The modes of weaving, and the kinds of texture, are various. The threads first laid in length are called the *warp*; those which cross them in the direction of the breadth, are called the *weft* or *woof*.—2. To unite any thing flexible; as, to *weave* twigs.—3. To unite by intermixture or close connection; as, a form of religion *woven* into the civil government.—4. To interpose; to insert. This *weaver* itself performe into my business.

*Shak.*

**WEAVE**, *v. i.* To practise weaving; to work with a loom.

**WEAVER**, *n.* One who weaves; one whose occupation is to weave.

**WEAVER-FISH**, *n.* A fish of the genus *Trachinus*. [See **WEEVER**.]

**WEAVERS**, or **WEAVER BIRDS**, *n.* The English name of a sub-family of Fringillidæ or finches, called Ploceinæ, and including the genera Ploceus, Euplectes, &c. The weavers are found in both hemispheres, and many of those of the Eastern build their nests with remarkable skill, by intertwining blades of grass, &c., hence the English name. Some species build their nests separate and singly, and hang them from slender branches of trees and shrubs, but others build in companies, numerous nests suspended from the branches of a tree being under one roof, though each one forms a separate compartment, and has a separate entrance. The *Ploceus heterocephalus*, or yellow-crowned weaver, is



Yellow-crowned Weaver and Nest (*P. heterocephalus*).

a native of S. Africa, and constructs an isolated pensile kidney-shaped nest, about seven inches long by four and a half broad, with an opening in the side. The *Euplectes flammeiceps*, or crimson-crowned weaver, is reputed to be a native of Senegal, having the ears and

sides of the head crimson, the chin and body beneath black, crown red, wings



Crimson-crowned Weaver (*Euplectes flammeiceps*).

and tail blackish. Naturalists are not quite agreed as to whether the nests of the weaver bird are built in their own peculiar manner, as a means of preservation against rain, or against the attacks of serpents and small quadrupeds.

**WEAVING**, *ppr.* Forming cloth by intermixture of threads.

**WEAVING**, *n.* The act or art of arranging in a machine called a loom, yarn or thread of various materials, as flax, cotton, wool, silk, &c., so as to form cloth. There are various kinds of weaving, such as *plain* weaving, *pattern* weaving, *double* weaving, *cross* weaving, *chain* weaving, *pile* weaving, &c.; but in all kinds of textile fabrics, of whatever material, one system of threads, called the *woof* or *weft*, is made to pass alternately under and over another system of threads called the *warp*, so as to resemble when held up to the light a piece of close net-work. Weaving is performed by the hand in what are called *hand-looms*, or by steam in what are called *power-looms*. Weaving, in the most general sense of the term, comprehends not only those textile fabrics which are prepared in the loom, but likewise net-work, lace-work, and hosiery. The invention of weaving is ascribed to the Egyptians, but the art has received many modifications and great improvements in modern times.—2. The task or work to be done in making cloth.

**WEAZEN**, *a.* (*wēz'n*.) Thin; lean; withered; wizened; as, a *weazen* face.

**WEB**, *n.* [Sax. *web*; Sw. *väf*. See **WEAVE**.] 1. Texture of threads; that which is woven in a loom; a sort of tissue or texture formed of threads interwoven with each other; some of which are extended in length, and are called the *warp*; others are drawn across and called the *weft* or *woof*; plexus; any thing woven. Penelope devised a *web* to deceive her wooers.—2. *Locally*, a piece of linen cloth.—3. A dusky film that forms over the eye and hinders the sight; suffusion.—4. Some part of a sword. *Qu. net-work* of the handle or hilt.—5. In *ship-building*, the thin partition on the inside of the rim, and between the spokes of a sheave.—6. In *ornithology*, the membrane which unites the toes of many waterfowls.—7. In *anat.*, applied to that which resembles a web; as the arachnid membrane; cellular tissue, &c.—8. *Spider's web*, a plexus of very delicate threads or filaments which a spider spins from its bowels, and which serves as a net to catch flies or other insects

for its food.—*Web* of a *coulter*, is the thin sharp part.

**WEB-BED**, *a.* [from *web*.] Having the toes united by a membrane or web; as, the *webbed* feet of aquatic fowls.

**WEB-BER**, † *n.* A weaver.

**WEB-BING**, *n.* A strong fabric of hemp, two or three inches wide, made for supporting the seats of stuffed chairs, sofas, &c.

**WEB-BY**, *a.* Relating to a web; resembling a web.

**WEB-FOOTED**, *a.* [*web* and *foot*.] Having the toes united by a membrane; palmped. A goose, or duck, is a *web-footed* fowl.

**WEBSTER**, † *n.* A weaver.

**WED**, *v. t.* [Sax. *weddian*, to covenant, to promise, to marry; Sw. *vädja*; Dan. *vedder*, to wager; W. *gwëez*; L. *vador*, to give bail, or *fœdus*, a league; probably both are of one family.] 1. To marry; to take for husband or for wife.

Since the day

I saw thee first, and *wedded* thee. *Milton*.

2. To join in marriage.

And Adam, *wedded* to another Eve,  
Shall live with her. *Milton*.

3. To unite closely in affection; to attach firmly. We are apt to be *wedded* to our own customs and opinions.

Men are *wedded* to their lusts. *Tillotson*.

4. To unite for ever.

Thou art *wedded* to calamity. *Shak.*

5. To espouse; to take part with.

They *wedded* his cause. † *Clarendon*.

**WED**, *v. i.* To marry; to contract matrimony.

When shall I *wed*? *Shak.*

**WED**, *n.* A pledge. [See **WAD**.]

**WED'DED**, *pp.* Married; closely attached.—2. *a.* Pertaining to matrimony; as, *wedded* life; *wedded* bliss.

**WED'DING**, *ppr.* Marrying; uniting with in matrimony.

**WED'DING**, *n.* Marriage; nuptials; nuptial ceremony; nuptial festivities.

**WED'DING-CLOTHES**, *n.* [*wedding* and *clothes*.] Garments for a bride or a bridegroom, to be worn at marriage.

**WED'DING-DAY**, *n.* [*wedding* and *day*.] The day of marriage.

**WED'DING-FEAST**, *n.* [*wedding* and *feast*.] A feast or entertainment prepared for the guests at a wedding.

**WEDGE**, *n.* [Sax. *wæcg*, *wæg*; Dan. *weg*; D. *wig*. This word signifies a mass, a lump.] 1. A mass of metal; as, a *wedge* of gold or silver; Josh. vii.

—2. A piece of wood or metal, thick at one end and sloping to a thin edge at the other, used in splitting wood, rocks, &c. The wedge is a body contained under two triangular and three rectangular surfaces; as in the figure, where the triangles *ANB*, *DCF*, are the ends, the rectangles *ADER*, *BCEP*, the sides, and the rectangle *ANDC*, the top.

The wedge is one of the mechanical powers, and is used for splitting blocks of timber and stone; for



producing great pressure, as in the oil-press; and for raising immense weights, as when a ship is raised by wedges driven under the keel, &c. If the power applied to the top were of the nature of a continued pressure, the wedge might be regarded as a double inclined plane, and the *power* would be to the *resistance* to be overcome, as the *breadth* of the *back*, *DC*, to the *length* of the *side*, *DE*, on the *supposition* that the *resistance* acts *perpendicularly* to

*the side.* But since the power is usually that of percussion with a hammer, every stroke of which causes a tremor in the wedge, which throws off for the instant the resistance on its sides, no certain theory can be laid down regarding it. To calculate the power, we require the additional elements of weight of the hammer, momentum of the blow, and the intervals between the blows; and, further, the amount of tremor in the wedge and its antagonism to the resistance on the sides. All that is known with certainty respecting the theory of the wedge is that its mechanical power is increased by diminishing the angle of penetration *D F C*. All cutting and penetrating instruments, as knives, swords, chisels, razors, axes, nails, pins, needles, &c., may be considered as wedges. The angle of the wedge in these cases is more or less acute, according to the purposes to which it is to be applied. The utility of the wedge, in many cases, depends on the great friction which arises between its surface and that of the substance which it divides; for in consequence of this friction it is retained in the position to which it is driven, and prevented from recoiling between the successive blows.—3. Something in the form of a wedge. Sometimes bodies of troops are drawn up in the form of a *wedge*.

**WEDGE**, *v. t.* To cleave with a wedge; to rive. [*Little used.*]—2. To drive as a wedge is driven; to crowd or compress closely. We were *wedged* in by the crowd.—3. To force, as a wedge forces its way; as, to *wedge* one's way.—4. To fasten with a wedge or with wedges; as, to *wedge* on a scythe; to *wedge* in a rail or a piece of timber.—5. To fix in the manner of a wedge.

*Wedge'd in the rocky shoals, and sticking fast.* Dryden.

**WEDGED**, *pp.* Split with a wedge; fastened with a wedge; closely compressed.

**WEDGE-SHAPED**, *a.* [*wedge and shape.*] Having the shape of a wedge; cuneiform. A *wedge-shaped* leaf is broad and truncate at the summit, and tapering down to the base, as in *Saxifraga cuneifolia*. [*See CUNEIFORM.*]

**WEDGEWOOD'S PYROMETER**. *See* PYROMETER.

**WEDGEWOOD-WARE**, *n.* [from the name of the inventor.] A superior kind of semivitrified pottery, without much glaze, but capable of receiving all kinds of ornament, by means of metallic oxides and ochres. Admirable imitations of Etruscan and other vases have been executed in this ware. It is manufactured in Staffordshire.

**WEDGING**, *pp.* Cleaving with a wedge; fastening with wedges; compressing closely.

**WEDLOCK**, *n.* [*Qu. wed and lock, or Sax. lac, a gift.*] Marriage; matrimony.

**WEDLOCK**, *v. t.* To marry. [*Little used.*]

**WEDLOCKED**, *pp.* United in marriage. [*Little used.*]

**WEDNESDAY**, *n.* (*wenz'day*) [*Sax. Wodensdag, Woden's day; Sw. Odensdag or Onsdag; from Woden or Odin, a deity or chief among the northern nations of Europe.*] The fourth day of the week; the next day after Tuesday, consecrated by our Scandinavian ancestors to Woden, the Mercury of northern nations.

**WEE**, *a.* [contracted from *G. wenig.*] Small; little. [*Scotch.*]

**WEEHELM**, } *n.* A species of elm.  
**WITCH-ELM**, } [*See WICH-ELM.*]  
**WEED**, *n.* [*Sax. weod.*] 1. The general name of any plant that is useless or troublesome. The word therefore has no definite application to any particular plant or species of plants; but whatever plants grow among corn, grass, or in hedges, and which are either of no use to man or injurious to crops, are denominated *weeds*.—2. Any kind of unprofitable substance among ores in mines, as mundic or marcasite. [*Local.*]

**WEED**, *n.* [*Sax. wæd, wæda, a vestment, any garment, that which is put on.*] 1. Properly, a garment, as in Spenser, but now used only in the plural, *weeds*, for the mourning apparel of a female; as, a widow's *weeds*.

—2.† An upper garment.—3. In *Scotland*, a general name for any sudden illness from cold or relapse, usually accompanied by febrile symptoms, taken by females after confinement, or during nursing.

**WEED**, *v. t.* [*Sax. weodian; D. weeden.*]

1. To free from noxious plants; as, to *weed* corn or onions; to *weed* a garden.—2. To take away, as noxious plants; as, to *weed* a writing of invectives.—3. To free from any thing hurtful or offensive; as, to *weed* a kingdom of bad subjects.—4. To root out vice; as, to *weed* the hearts of the young.

**WEED**, *pp.* Freed from weeds or whatever is noxious.

**WEEDER**, *n.* One that weeds or frees from any thing noxious.—2. A weeding tool.

**WEEDER-CLIPS**, *n.* Weeding-sheers.

I turned aside my *weeder-clips*,

And spared the symbol dear. Burns.

[*Local.*]

**WEEDERY**,† *n.* Weeds.—2. A place for weeds.

**WEED-GROWN**, *a.* Overgrown with weeds.

**WEED-HOOK**, } *n.* [*weed and*  
**WEEDING-HOOK**, } *hook.*] A hook used for cutting away or extirpating weeds.

**WEEDING**, *pp.* Freeing from weeds or whatever is noxious to growth.

**WEEDING**, *n.* The operation of freeing from noxious weeds, as a crop. Weeding is performed by the hand simply, or by the hand aided by various instruments, as pincers, forks, spuds, &c.

**WEEDING-CHISEL**, *n.* (*s* as *z*.) A tool with a divided chisel point, for cutting the roots of large weeds within the ground.

**WEEDING-FORCEPS**, } *n.* An instru-  
**WEEDING-PINCERS**, } ment for  
**WEEDING-TONGS**, } pulling up  
some sorts of plants in weeding, as  
thistles.

**WEEDING-FORK**, *n.* A strong three-pronged fork, used in clearing ground of weeds.

**WEEDING-RHIM**, *n.* An implement somewhat like the frame of a wheelbarrow, used for tearing up weeds on summer fallows, &c.; used in Kent.

**WEEDING-SHEARS**, *n.* Shears used for cutting weeds.

**WEEDING-TOOL**, *n.* An implement for pulling up, digging up, or cutting weeds.

**WEEDLESS**, *a.* Free from weeds or noxious matter.

**WEEDY**, *a.* Consisting of weeds; as, *weedy* trophies.—2. Abounding with

weeds; as, *weedy* grounds; a *weedy* garden; *weedy* corn.

**WEEK**, *n.* [*Sax. weoc; D. week; G. woche.*] 1. The space of seven days; a cycle of time which has been used from the earliest ages in Eastern countries, and is now universally adopted over the Christian and Mohammedan worlds. It has been commonly regarded as a memorial of the creation of the world in that space of time. It is besides the most obvious and convenient division of the lunar or natural month.—2. In *scripture*, a prophetic *week*, is a week of years, or seven years; Dan. ix.

**WEEK-DAY**, *n.* [*week and day.*] Any day of the week except the sabbath.

**WEEKLY**, *a.* Coming, happening, or done once a week; hebdomadary; as, a *weekly* payment of bills; a *weekly* gazette; a *weekly* allowance.

**WEEKLY**, *adv.* Once a week; by hebdomadal periods; as, each performs service *weekly*.

**WHEEL**,† *n.* [*See WELL. Sax. wæl, from weallan, to boil.*] A whirlpool.

**WHEEL**, } *n.* A kind of twigen trap  
**WEELEY**, } or snare for fish.

**WEEN**, *v. i.* [*Sax. weanan, to think, suppose, or hope, and to wean.*] The sense is to set, fix, or hold in the mind; *G. wîhnen, to imagine; D. waanen.* To think; to imagine; to fancy. [*Obsolete, except in burlesque.*]

**WEENING**,† *pp.* Thinking; imagining.

**WEEP**, *v. i.* pret. and *pp.* *Wept.* *Weeped*, we believe, is never used. [*Sax. wepan; evidently the same word as whoop. See WHOOP.*] The primary sense is to cry out.] 1. To express sorrow, grief, or anguish by outcry. This is the original sense. But in present usage, to manifest and express grief by outcry or by shedding tears.

They all *wept* sore, and fell on Paul's neck, and kissed him; Acts xx.

Phocion was rarely seen to *weep* or to laugh. *Mitford.*

2. To shed tears from any passion. Persons sometimes *weep* for joy.—3. To lament; to complain; Numb. xi.

**WEEP**, *v. t.* To lament; to bewail; to bemoan.

We wand'ring go

Through dreary wastes, and *weep* each other's woe. Pope.

2. To shed moisture; as, to *weep* tears of joy.

Groves whose rich trees *wept* od'rous gum and balm. Milton.

3. To drop; as, the *weeping* amber.—4. To abound with wet; as, *weeping* grounds.

**WEEPED**, *pp.* Lamented; bewailed; shed tears.

**WEEPER**, *n.* One who weeps; one who sheds tears.—2. A sort of white linen cuff on a mourning dress, worn as a badge of mourning.—3. A species of monkey, the *Simia capucina*.—4. In *arch.*, *weepers* are the statues at the base of a funeral monument.

**WEEPING**, *pp.* or *a.* Lamenting; shedding tears.

**WEEPING**, *n.* Lamentation.

**WEEPING-BIRCH**, *n.* A tree or shrub of the genus *Betula*, the *B. pendula*, with drooping branches. It is very common in different parts of Europe. It differs from the common birch not only in its weeping habit, but also in its young shoots being quite smooth, bright chestnut brown when ripe, and then covered with little white warts.

**WEeping-CROSSES**, *n.* In *arch.*, the name given to stone crosses at which penances were commonly finished with weeping, and signs of contrition.

**WEepingLY**, *adv.* In a weeping manner.

**WEeping-ROCK**, *n.* [*weep* and *rock*.] A porous rock from which water gradually issues.

**WEeping-SPRING**, *n.* A spring that slowly discharges water.

**WEeping-WILLow**, *n.* A species of willow, the *Salix Babylonica*, whose branches grow very long and slender, and hang down nearly in a perpendicular direction. It is a native of the Levant, and is said to have been first planted in England by the celebrated Alexander Pope.

**WEERISH**, † *a.* Insipid; weak; washy; surly.

**WEET**, † *v. i.* pret. *Wot.* [Sax. *witan*; D. *weeten*; G. *wissen*; Russ. *vidayu*; allied probably to L. *video*, Gr. *ὄω*.] To know.

**WEET**, *n.* Rain; moisture. [*Scotch.*]

**WEETLESS**, † *a.* Unknowing.

**WEEVER**, *n.* The name given to acanthopterygious fishes of the genus *Trachinus*, belonging to the perch family. About four species are well known, two of which are found in the British seas, viz., the dragon-weever or sting-bull *T. draco*, about ten or



Weever (*Trachinus draco*).

twelve inches long, and the lesser weever or sting fish. They inflict wounds with the spines of their first dorsal fin, which are much dreaded. Their flesh is esteemed.

**WEEVIL**, † [Sax. *wefl*; G. *wibel*.] The name applied to coleopterous insects of the family Curculionidæ, distinguished by the prolongation of the head, so as to form a sort of snout or proboscis. Many of the weevils are



Corn Weevil (*Calandra granaria*).

*a.* Insect natural size; *b.* Insect magnified.  
*c.* Larva; *d.* Egg, both magnified.

dangerous enemies to the agriculturist, destroying grain, fruit, flowers, leaves, and stems. The corn weevil, (*Calandra granaria*), in its larva state is exceedingly destructive to grain in granaries.

**WEEVILY**, *a.* Infested with weevils.

**WEEZEL**, *a.* Thin; sharp; as, a weezel face. [*Local.* See **WEASEL**.]

**WEFT**, *old pret.* of **WAVE**.

**WEFT**, *n.* [from *weave*.] The woof of cloth; the threads that cross the warp.

—2. A web; a thing wove.

**WEFT**, † *n.* A thing waved, waived, or cast away. [See **WAIF**.]

**WEFTAGE**, † *n.* Texture.

**WEGOTISM**, *n.* The frequent use of the pronoun *we*, weism. [*A modern cant term.*]

**WEHRGELD**. See **WEREGILD**.

**WEIGIL**, *v. t.* (wa.) Sax. *wag*, *weg*, a

balance; *wagan*, to weigh, to bear, to carry, L. *vehō*; G. *wägen*; Dan. *vejer*, to weigh; Russ. *vaga*, a balance; Amharic, *awahl*, weight. See **WAG**.]

1. To examine by the balance; to ascertain the weight, that is, the force with which a thing tends to the centre of gravity; to determine by the balance the weights of bodies by shewing their relation to the weights of some other bodies which are known, or which are assumed as general standards of weight; as, to weigh sugar; to weigh gold.—2. To be equivalent to in weight; that is, according to the Saxon sense of the verb, to lift to an equipoise a weight on the other side of the fulcrum. Thus when a body balances a weight of twenty-eight pounds avoirdupois, it lifts or bears it, and is said to weigh so much. It weighs a quarter of a hundred weight.—3. To raise; to lift; as an anchor from the ground, or any other body; as, to weigh anchor; to weigh an old hulk.—*Under-weigh*. A vessel is said to be *under-weigh*, when she has weighed anchor or left her moorings. It is also written *underway*.—4. To pay, allot, or take by weight.

They weighed for my price thirty pieces of silver; Zech. xi.

5. To ponder in the mind; to consider or examine for the purpose of forming an opinion or coming to a conclusion; as, to weigh the advantages and disadvantages of a scheme.

Regard not who it is which speaketh, but weigh only what is spoken. Hooker.

6. To compare by the scales. Here in nice balance truth with gold she weighs. Pope.

7. To regard; to consider as worthy of notice.

I weigh not you. Shak.

To weigh down, to overbalance.—2. To oppress with weight; to depress.

**WEIGH**, *v. i.* To have weight; as, to weigh lighter or heavier.—2. To be considered as important; to have weight in the intellectual balance. This argument weighs with the considerate part of the community.—3. To bear heavily; to press hard. Cleanse the stuff'd bosom that of perilous stuff,

Which weighs upon the heart. Shak.

To weigh down, to sink by its own weight.

**WEIGH**, *n.* A certain quantity or measure. [See **WEY**.]

**WEIGHABLE**, *a.* That may be weighed.

**WEIGHAGE**, *n.* A rate or toll paid for weighing goods.

**WEIGH-BRIDGE**, *n.* A weighing-machine for weighing carts and wagons with their load.

**WEIGHED**, *pp.* Examined by the scales; having the weight ascertained.

—2. Considered.—3. *a.* Experienced; as, a young man not weighed in state affairs.

**WEIGHER**, *n.* One who weighs.—2. An officer whose duty is to weigh commodities.

**WEIGH-HOUSE**, *n.* A place for testing the weight or bulk of any produce brought for sale into a city or town to be sold, in order to fix the amount of municipal dues to be paid thereon. [*Both word and custom are now disused.*]

**WEIGHING**, *ppr.* Examining by scales; considering.

**WEIGHING**, *n.* The act of ascertaining weight; the process by which the

measure of the force by which any body, or a given portion of any substance gravitates to the earth, is ascertained; the process of determining the quantity of matter; or the number of grains, ounces, pounds, hundredweights, &c., which any substance contains. This is effected by balances of various kinds. Accurate weighing is of great importance, since in general it affords one of the best practical means of ascertaining the quantity of matter in bodies, and thence the value of the greater part of the necessaries of life. It is also of great importance in many philosophical experiments. Troy weight is used in philosophical experiments, and in delicate weighing, and the weight is usually reckoned in grains.—2. As much as is weighed at once; as, a weighing of beef.

**WEIGHING-ENAGE**, *n.* A cage in which small living animals may be conveniently weighed; as pigs, sheep, calves, &c.

**WEIGHING-HOUSE**, *n.* A building furnished with a dock and other conveniences for weighing commodities and ascertaining the tonnage of boats to be used on a canal.

**WEIGHING-MACHINE**, *n.* Any contrivance by which the weight of an object may be ascertained; as the common balance, spring balance, steelyard, &c., but the term is generally applied to those contrivances which are employed for ascertaining the weight of heavy bodies; as the machine usually employed at the toll-gates on roads for the purpose of determining the weights of laden carriages; machines for weighing cattle; machines for weighing heavy goods, as large casks, bales, &c. Some of these are constructed on the principle of the lever or steelyard, others on that of a combination of levers, and others on that of the spring-balance. They are also called weigh-bridges.

**WEIGHT**, *n.* (wate.) [Sax. *wiht*; D. *wigt*; G. *gewicht*. See **WEIGHT**.] 1. The quantity of a body, ascertained by the balance; that property of bodies in virtue of which they tend towards the earth's centre of gravity. In a strictly philosophical sense, weight is the measure of the force of gravity, and not gravity itself. Gravity may be considered as a force acting on each of the elementary particles of a body urging it downwards; whereas the weight of a body is the product of the gravity of a single particle, by the number of particles. The weights of two bodies are to one another as the quantities of matter in those bodies; and two bodies are of equal weight which counterpoise each other, when placed at the ends of equal arms of a self-poising lever. As weight is the measure of the force of gravity, it follows that the weight of a body must be increased or diminished according as the force of gravity is increased or diminished. Hence a body that weighs, for instance, one pound at the level of the sea, will, if carried to the top of a mountain, weigh less than a pound, the force of gravity being inversely as the square of the distance from the earth's centre. The diminution of weight, however, at the top of the mountain, could not be indicated by a common balance, because in this instrument, both the weight and its counterpoise are in every situation equally affected by gravity; but if a body that weighs a pound at the level

of the sea, be weighed at the top of a mountain by means of an accurately constructed spring-balance, the diminution of weight which it sustains can be ascertained. It must also be remembered, when weight is to be very accurately taken, that every body is buoyed up to a certain extent by the air; and the weight of a body in air is less than it would be in a vacuum, by the weight of its own bulk of air. Now the air varies in weight in a manner depending upon the temperature, the quantity of moisture contained in it, and other causes. In measuring standards of weight, therefore, close attention must be paid to the state of the air at the time of weighing, and also to the substance weighed.—2. In *commerce*, the measure of the force by which any body, or a given portion of any substance gravitates to the earth. A mass of iron, lead, brass, or other metal, to be used for ascertaining the weight of other bodies; as, an ounce weight, a pound weight, a stone weight, &c. Three systems of weights are admitted as standards in this country; viz., Troy weight used for weighing gold, silver, and precious stones; apothecaries' weight, used for the combination of drugs; and avoirdupois weight, used for all other commodities estimated by weight.—*Standard unit of weight*, a body selected as a standard by comparison, with which the weights of other bodies may be determined, and all other weights used in commerce measured and adjusted. By the Act of Parliament, 1824, the standard brass weight of 1 pound troy, made in the year 1758, then in the custody of the clerk of the House of Commons, was declared to be the original and genuine standard measure of weight, from which all other weights were to be derived, computed and ascertained; and that  $\frac{1}{2}$  of the said pound should be reckoned an ounce,  $\frac{1}{16}$  of said ounce, a pennyweight, and  $\frac{1}{24}$  of said pennyweight a grain, so that 5760 such grains were to constitute a pound troy, also 7000 such grains were to be a pound avoirdupois. The standard pound, however, was destroyed by the burning of the houses of parliament in 1834, and since that time there has been no legal standard unit of weight.—3. In *mech.*, the resistance to be overcome by a machine, whether in raising, sustaining, or moving any heavy body. This resistance is so named, because whatever it be, a weight of equivalent effect may be found. The force which is employed to sustain or overcome the weight or resistance, is called the power.—4. A ponderous mass; something heavy.

A man leaps better with *weights* in his hands. *Bacon.*

5. Pressure; burden; as, the *weight* of grief; *weight* of care; *weight* of business; *weight* of government.—6. Importance; power; influence; efficacy; consequence; moment; impressiveness; as, an argument of great *weight*; a consideration of vast *weight*. The dignity of a man's character adds *weight* to his words.

WEIGHTILY, *adv.* Heavily; ponderously.—2. With force or impressiveness; with moral power.

WEIGHTINESS, *n.* Ponderousness; gravity; heaviness.—2. Solidity; force; impressiveness; power of convincing;

as, the *weightiness* of an argument.—3. Importance.

WEIGHTLESS, *a.* Having no weight; light.

WEIGHTY, *a.* Having great weight; heavy; ponderous; as, a *weighty* body.—2. Important; forcible; momentous; adapted to turn the balance in the mind, or to convince; as, *weighty* reasons; *weighty* matters; *weighty* considerations or arguments.—3. † Rigorous; severe; as, our *weightier* judgment.

WEIR, *n.* [Sax. *war*, *wer*; D. *waaren*, or *weeren*.] A dam erected across a river, to stop and raise the water, either for the purpose of taking fish, of conveying a stream to a mill, or of maintaining the water at the level required for navigating it, or for purposes of irrigation.—2. A fence of twigs or stakes set in a stream for catching fish. [See WEAR.]

WEIRD, *n.* A spell or charm. [Scotch.]

WEIRD, *n.* Fate; destiny; as, to die (bear) one's *weird*. [Scotch.]

WEIRD, † *a.* Skilled in witchcraft.

WEISM, *n.* The frequent use of the pronoun *we*. [A modern cant term. See VEGOTISM.]

WEIVE, † for *Waive*.

WELAWAY, † an exclamation expressive of grief or sorrow, equivalent to *alas*. It is a compound of Sax. *wa*, *wo*, and *la*, *oh*. The original is *wa-la*, which is doubtless the origin of our common exclamation, *O la*, and to this, *wa*, *wo*, is added. The true orthography would be *wa la wa*.

WELCH. See WELSH.

WELCH'GLAIVE, *n.* In *armour*, a kind of bill five or six feet long.

WELCHMAN. See WELSHMAN.

WEL'ÇÔME, *a.* [Sax. *wil-cuma*; *wel* and *come*; that is, your coming is pleasing to me.] 1. Received with gladness; admitted willingly to the house, entertainment, and company; as, a *welcome* guest.—2. Grateful; pleasing; as, a *welcome* present; *welcome* news.—3. Free to have or enjoy gratuitously. You are *welcome* to the use of my library.—*To bid welcome*, to receive with professions of kindness.

WEL'ÇÔME, is used elliptically for *you are welcome*.

*Welcome*, great monarch, to your own.

*Dryden.*

*Welcome to our house*, an herb.

WEL'ÇÔME, *n.* Salutation of a new comer.

*Welcome ever smiles.*

*Shak.*

2. Kind reception of a guest or new comer. We entered the house and found a ready *welcome*.

Truth finds an entrance and a *welcome* too.

*South.*

WEL'ÇÔME, *v. t.* [Sax. *wilcumian*.] To salute a new comer with kindness; or to receive and entertain hospitably, gratuitously, and cheerfully.

Thus we salute thee with our early song,  
And *welcome* thee, and wish thee long.

*Milton.*

WEL'ÇÔMED, *pp.* Received with gladness and kindness.

WEL'ÇÔMELY, *adv.* In a *welcome* manner.

WEL'ÇÔMENESS, *n.* Gratefulness; agreeableness; kind reception.

WEL'ÇÔMER, *n.* One who salutes or receives kindly a new comer.

WEL'ÇÔMING, *pp.* Saluting or receiving with kindness a new comer or guest.

WELD, } *n.* A plant used by dyers to  
WÖLD, } give a yellow colour, and

sometimes called *dyers' weed*. It is much cultivated in Kent for the London



Weld (*Reseda luteola*).

dyers. It is the *Reseda luteola* of the botanists.

WELD, † *v. t.* To weld.

WELD, *v. t.* [Sw. *välla*, to weld; G. *wellen*, to join; D. *wellen*, to well, to spring, to solder.] To unite or hammer into firm union, as two pieces of iron, when heated almost to fusion.

WELD'ED, *pp.* Forged or beat into union in an intense heat.

WELD'ER, *n.* One who welds iron.—2. † In *Ireland*, a manager; an actual occupant.

WELD'ING, *pp.* Uniting in an intense heat.

WELD'ING, *n.* Most usually applied to iron. The process of uniting together two or more pieces of iron, or iron and steel, when heated to whiteness, by means of pressure or hammering. This union is so complete that when two bars of iron are properly welded, the place of junction is as strong relatively to its thickness, as any other part of the bar, nor is there any appearance of junction. Iron and platinum are the only metals capable of being welded.

WELD'ING-HEAT, *n.* The heat necessary for welding iron bars, which is usually estimated at from 60° to 90° of Wedgwood's pyrometer.

WEL'FARE, *n.* [*well* and *fare*, a good going; G. *wohlfahrt*; D. *welvaart*.] 1. Exemption from misfortune, sickness, calamity, or evil; the enjoyment of health and the common blessings of life; prosperity; happiness; applied to persons.—2. Exemption from any unusual evil or calamity; the enjoyment of peace and prosperity, or the ordinary blessings of society and civil government; applied to states.

WELK, *v. i.* [G. and D. *welken*, to wither, to fade, to decay; primarily to shrink or contract, as things in drying, whence the Saxon *welc*, a whilk or welk, a shell; from its wrinkles.] To decline; to fade; to decay; to fall.

When ruddy Phœbus 'gins to *welk* in west.†

*Spenser.*

WELK, *v. t.* To contract; to shorten.

Now sad winter *welked* hath the day.

*Spenser.*

[This word is obsolete. But its signification has heretofore been misunderstood. See WILT.]

WELK, *n.* See WIELK.

WELK'ED, *pp.* or *a.* Contracted into wrinkles or ridges.

Horns *welk'd* and *wav'd* like the *cridridged* sea. † *Shak.*

WELK'IN, *n.* [*Sax. wolec, wolcen*, a cloud, the air, ether, the vault of heaven; *G. wolhe*, a cloud. *Qu. Sax. wealcen*, to roll, to full.] The visible regions of the air; the vault of heaven. [This is obsolete, unless in poetry.]—

*Welkin eye*, in *Shakespeare*, is interpreted by *Johnson*, a blue eye, from *welkin*, the sky; by *Todd*, a rolling eye, from *Sax. wealcen*, to roll; and by *Entinck*, a languishing eye. [See WELK.]

WELKING, *ppr.* Fading; declining; contracting.

WELL, *n.* [*Sax. well*, a spring or fountain; *wellan*, to well, to boil or bubble, to spring, to rise; *D. wel, wellen*, id.; *G. quelle*, a spring; *quellen*, to spring, to issue forth, to gush; to well; to swell; *wallen*, to swell. In *G. quelle* is a wave. On this word we suppose *swell* to be formed.] 1. A spring; a fountain; the issuing of water from the earth.

Begin then, sisters of the sacred *well*. *Milton.*

2. A pit or cylindrical hole, sunk perpendicularly into the earth to such a depth as to reach a supply of water, and walled with stone to prevent the earth from caving in.—*Artesian wells.* [See ARTESIAN.]—3. In *ships*, an apartment in the middle of a ship's hold, formed by bulkheads round the pumps, to keep them clear of obstructions, and protect them from injury.—4. In a *fishing vessel*, an apartment in the middle of the hold, made tight at the sides, but having holes perforated in the bottom to let in fresh water for the preservation of fish, while they are transported to market.—5. In the *milit. art*, a hole or excavation in the earth, in mining, from which run branches or galleries.—6. *Metaphorically*, a spring, source, or origin.

WELL, *v. i.* [*Sax. wellan*.] To spring; to issue forth, as water from the earth, or from a spring. [Little used.]

WELL, † *v. t.* To pour forth, as from a well.

WELL, *a.* [*Sax. wel or well; G. wohl; W. gwel*, better; *gwella*, to make better, to mend, to improve; *Arm. gwellaat*; *L. valeo*, to be strong; *Gr. εως*, and *ωλε*, to be well; *Sans. bala, bali*, strength. The primary sense of *valeo* is to strain, stretch, whence to advance, to prevail, to gain, according to the American vulgar phrase, to *get ahead*, which coincides with *prosper*, *Gr. εσπερα*. We do not find *well* used in other languages as an adjective, but it is so used in English. See *WELL*.] 1. Being in health; having a sound body with a regular performance of the natural and proper functions of all the organs; *applied to animals*; as, a *well man*; the patient has recovered, and is perfectly *well*.

While you are *well*, you may do much good. *Taylor.*

Is your father *well*? *Gen. xliii.*

2. *Fortunate*; convenient; advantageous; happy. It is *well* for us that we are requested so far from the rest of the world.

It was *well* with us in *Egypt*; *Numb. xi*

3. Being in favour.

He was *well* with *Henry the fourth*. *Dryden.*

WELL, *adv.* In a proper manner; justly; rightly; not ill or wickedly; *James ii.*

If thou doest not *well*, sin lieth at the door; *Gen. iv.*

2. *Skilfully*; with due art; as, the work is *well done*; he writes *well*; he rides *well*; the plot is *well laid*, and *well executed*.—3. *Sufficiently*; abundantly.

*Lot... beheld all the plain of Jordan*, that it was *well watered* every where; *Gen. xiii.*

4. *Very much*; to a degree that gives pleasure. I liked the entertainment *well*.—5. *Favourably*; with praise.

All the world speaks *well* of you. *Pope.*

6. *Conveniently*; suitably; advantageously. This is all the mind can *well contain*. I cannot *well attend* the meeting.—7. To a sufficient degree; perfectly. I know not *well* how to execute this task.—8. *Thoroughly*; fully. Let the cloth be *well cleansed*. Let the steel be *well polished*.

She looketh *well* to the ways of her household; *Prov. xxxi.*

9. *Fully*; adequately.

We are *well able* to overcome it; *Numb. xiii.*

10. *Far*; as, to be *well advanced* in life.—*As well as*, together with; not less than; one as much as the other; as, a sickness long *as well as* severe. London is the largest city in Europe, *as well as* the principal banking city.—*Well enough*, in a moderate degree; so as to give satisfaction, or so as to require no alteration.—*Well is him*, seems to be elliptical for *well is to him*.

—*To be well off*, to be in a good condition, especially as to property.—*Well to live*, having a competence; in comfortable circumstances. *Well* is sometimes used elliptically for *it is well*, and as an expression of satisfaction with what has been said or done; and sometimes it is merely expletive. *Well*, the work is done. *Well*, let us go. *Well, well*, be it so. *Well* is prefixed to many words, expressing what is right, fit, laudable, or not defective; as, *well-affected*; *well-designed*; *well-directed*; *well-ordered*; *well-formed*; *well-meant*; *well-minded*; *well-seasoned*; *well-tasted*.

WELL-ACCOUTRED, *a.* Fully furnished with arms or dress.

WELL'ADAY, *alas*, *Johnson* supposes to be a corruption of *Welaway*,—*which see*.

WELL-ADJUSTED, *a.* Rightly adjusted.

WELL-AIMED, *a.* Rightly aimed.

WELL-AN'CHORED, *a.* Safely moored; well established.

WELL-APPOINTED, *a.* Fully furnished and equipped; as, a *well-appointed army*.

WELL-AUTHENTICATED, *a.* Supported by good authority.

WELL-BALANCED, *a.* Rightly balanced.

WELL-BEHAVED, *a.* Courteous; civil; of good conduct.

WELLBE'ING, *n.* [*well and bring*.] Welfare; happiness; prosperity; as, virtue is essential to the *wellbeing* of men or of society.

WELL-BELOVED, *a.* Greatly beloved; *Mark xii.*

WELL-BORN, *a.* [*well and born*.] Born of a noble or respectable family; not of mean birth.

WELL-BRED, *a.* [*well and bred*.] Educated to polished manners; polite.

—2. In *agriculture*, a term applied to a horse or other domestic animal which has descended from a race of ancestors, that have, through several generations, possessed in a high degree the properties which it is the great object to obtain.

WELL'-BUILT, *a.* Built in a substantial manner.

WELL-COMPLEXIONED, *a.* Having a good complexion.

WELL-CONDITIONED, *a.* Being in a good state.

WELL-CONDUCTED, *a.* Properly led on.—2. Being of good moral conduct.

WELL-COUCHEd, *a.* Couched in proper terms.

WELL-DEFINED, *a.* Truly defined.

WELL-DESCRIBED, *a.* Truly described.

WELL-DEvised, *a.* Rightly devised.

WELL-DIGESTED, *a.* Fully digested.

WELL-DIGGER, *n.* One who makes it his employment to sink deep pits in the earth by digging or boring, in order to obtain a supply of water.

WELL-DISCERNED, *a.* Rightly discerned.

WELL-DISPOSED, *a.* Rightly disposed.

WELL-DÖER, *n.* One who performs rightly his moral and social duties.

WELL-DÖING, *n.* Performance of duties.

WELL-DÖNE, *exclam.* [*well and done*.] A word of praise; bravely; nobly; in a right manner.

WELL-DÖNE', *a.* Thoroughly cooked; as, let my steak be *well-done*.

WELL'-DRAIN, *n.* [*well and drain*.] A drain or vent for water, somewhat like a well or pit, serving to discharge the water of wet land.

WELL'-DRAIN, *v. t.* To drain land by means of wells or pits, which receive the water, and from which it is discharged by machinery.

WELL'-DRAWN, *a.* Truly drawn.

WELL-DRESS'ED, *a.* Handsomely dressed.

WELL-EDUCATED, *a.* Having a good education.

WELL-ESTABLISHED, *a.* Firmly established.

WELFARE, is now written *Welfare*.

WELL-FA'VOURED, *a.* Handsome; well formed; beautiful; pleasing to the eye; *Gen. xxix.*

WELL-FLA'VOURED, *a.* Having a high flavour.

WELL-FORMED, *a.* Rightly formed, shaped, or moulded.

WELL'-FOUNDED, *a.* Founded on good and valid reasons, or on strong probabilities.

WELL-GROUND'ED, *a.* [*well and ground*.] Well founded; having a solid foundation.

WELL-HAL'LOWED, † *a.* Sacred; just.

WELL'-HEAD, † *n.* [*well and head*.] A source, spring, or fountain.

WELL'-HOLE, † *n.* In a *flight of stairs*, *WELL*, } the space left in the middle beyond the ends of the steps.

—2. A cavity which receives a counterbalancing weight in some mechanical contrivances, and also for other purposes.

WELL-HUS'BANDED, *a.* Husbanded properly.

WELL-INFORM'ED, *a.* Correctly informed.

WELL-INSTRUCT'ED, *a.* Rightly or fully instructed.

WELL-INTEND'ED, *a.* Intended for a good purpose, or with upright motives.

WELL-INTEN'TIONED, *a.* Having upright intentions or purpose.

WELL-KNOWN, *a.* Fully known.

WELL-MAN'NERED, *a.* [well and manner.] Polite; well-bred; com-  
plaisant.

WELL-MEANER, *n.* [well and mean.] One whose intention is good.

WELL-MEANING, *a.* Having a good intention.

WELL-MEANT, *a.* Rightly intended.

WELL-MET', *exclam.* A term of salutation denoting joy at meeting.

WELL-MINDED, *a.* [well and mind.] Well disposed; having a good mind.

WELL-MORALIZED, *a.* Regulated by good morals.

WELL-NAT'URED, *a.* [well and nature.] Good natured; kind.

WELL-NIGH, *adv.* [well and nigh.] Almost; nearly.

WELL-OR'DERED, *a.* Rightly ordered.

WELL-PAINTED, *a.* Painted well.

WELL-POL'ICIED, *a.* Having a good policy.

WELL-POL'ISHED, *a.* Highly polished.

WELL-READ, *a.* Having extensive reading; well instructed in books.

WELL-REG'ULATED, *a.* Having good regulations.

WELL-ROOM, *n.* [well and room.] In a boat, a place in the bottom where the water is collected, and whence it is thrown out with a scoop.

WELL-SET, *a.* Having good symmetry of parts.

WELL-SETTLED, *a.* Fully settled; well married.

WELL-SINKER, *n.* One who digs wells.

WELL-SPED, *a.* Having good success.

WELL-SPENT, *a.* [well and spent.] Spent or passed in virtue; as, a well-spent life; well-spent days.

WELL-SPOKEN, *a.* [well and speak.] Speaking well; speaking with fitness or grace; or speaking kindly.—2. Spoken with propriety; as, well-spoken words.

WELL-SPRING, *n.* [well and spring.] A source of continual supply; Prov. xvi.

WELL-STORED, *a.* Fully stored.

WELL-SWEEP. See SWEEP.

WELL-TEMPERED, *a.* Having a good temper.

WELL-THOUGHT, *a.* Opportunely brought to mind.

WELL-TIMED, *a.* Done at a proper time.

WELL-TRAIN'ED, *a.* Correctly trained.

WELL-TRAP, *n.* The same as *stench-trap*.

WELL-TRIED, *a.* Having been fully tried.

WELL-WATER, *n.* [well and water.] The water that flows into a well from subterranean springs; water drawn from a well.

WELL-WILL'ER, *n.* [well and will.] One who means kindly.

WELL-WISH', *n.* [well and wish.] A wish of happiness.

WELL-WISH'ER, *n.* [supra.] One who wishes the good of another.

WELSH, *a.* [Sax. *weallisc*, from *wealdh*, a foreigner; *weallian*, to wander; *G. wälsch*, foreign, strange, Celtic, *Welsh*; *Walsche sprache*, the Italian language, that is, foreign, or Celtic.] Pertaining to the Welsh nation.

WELSH, *n.* The language of Wales or of the Welsh. The Welsh is a mem-

ber of the Celtic family of languages, and is one of the oldest languages in Europe. It is distinguished for the beauty of its compounds, which it possesses the capacity of forming to an almost unlimited extent.—2. The general name of the inhabitants of Wales. The word signifies foreigners or wanderers, and was given to this people by other nations, probably because they came from some distant country. The Welsh call themselves *Cymry*, in the plural, and a Welshman *Cymro*, and their country *Cymru*, of which the adjective is *Cymreig*, and the name of their language *Cymraeg*. They are supposed to be from the *Cimbri* of Judand.

WELSH-GROIN, *n.* In *arch.*, a groin formed by the intersection of two cylindrical vaults, of which one is of less height than the other.

WELSH-LUMPS, *n.* Fire bricks so named because they are made in various parts of Wales.

WELSH'MAN, } *n.* A native of the  
WELSHWO'MAN, } principality of Wales.

WELSH-RABBIT, *n.* Cheese toasted, and laid in thin slices upon slices of bread, which have been toasted and buttered.

WELSH-RAG SLATES, *n.* A kind of slates which occur in Caernarvonshire. They are much used in slating, and are reckoned next in quality to the Westmoreland slates.

WELT, *n.* [W. *gwald* from *gwael*, a fence, a wall; *gwaliau*, to inclose; *gwaldau*, to hem. See WALL.] A border; a guard; a kind of hem or edging; a fold or doubling of cloth or leather, as on a garment or piece of cloth, or on a shoe.—2. A small cord covered with cloth and sewed on seams or borders to strengthen them.—3. In *her.*, a narrow kind of border to an ordinary or charge.

WELT, *v. t.* To furnish with a welt; to sow a welt on a seam or border.

WELT, *v. i.* See WELK, WILT.

WELT'ED, *pp.* or *a.* Furnished with a welt.

WELT'ER, *v. i.* [Sax. *wæltan*; *G. walzen*; Dan. *wälter*; allied probably to *wallow*, *L. voluto*.] To roll, as the body of animals; but usually, to roll or wallow in some foul matter; as, to *wælt* in blood or in filth.

WELT'ERING, *ppr.* Rolling; wallowing; as in mire, blood, or other filthy matter.

WELT'ING, *n.* A sewed border or edging.

WEM, † *n.* [Sax.] A spot; a scar.

WEM, † *v. t.* [Sax. *wemman*.] To corrupt.

WEN, *n.* [Sax. *wenn*; *D. wen*; *Arm. guennaen*, a wart.] An encysted tumour which is movable, pulpy, and often elastic to the touch.

WENCH, *n.* [Sax. *wencle*. Qu. *G. wenig*, little.] 1. A young woman. [*Little used*.]—2. A young woman of ill fame.—3. In *America*, a black or coloured female servant; a negress.

WENCH, *v. i.* To frequent the company of women of ill fame.

WENCH'ER, *n.* A lewd man.

WENCH'ING, *ppr.* Frequenting women of ill fame.

WENCH-LIKE, *a.* After the manner or likeness of a wench, or young woman.

WEND, *v. i.* [Sax. *wendaa*.] 1. To go; to pass to or from.—2. † To turn round. [Wend and wind are from the same root.]

WEN'LOCK FORMATION or STRATA, *n.* The name given by English geologists to the lower division of the upper Silurian rocks, comprising the Wenlock limestone and Wenlock shale or slate. The former is a crystalline grey or blue limestone, abounding in marine mollusca and crustaceous animals of the Trilobite family; and the latter, a dark coloured shale, with nodules of earthy limestone, and containing mollusca and Trilobites. The Wenlock strata occur at Wenlock Edge, Shropshire; Dudley, Worcestershire.

WEN'NEL, † *n.* A weasel. [See WEANEL.]

WEN'NISH, } *a.* [from *wen*.] Having  
WEN'NY, } the nature of a *wen*.

WENT, *pret.* of the verb *Wend*. We now arrange *went* in grammar as the preterite of *go*, but in origin it has no connection with it.

WENT'LE-TRAP, *n.* [Ger. *wendeltreppe*, a winding staircase.] A name given by collectors to molluscs of the genus *Scalaria*. [See SCALARIA.]

WEPT, *pret.* and *pp.* of *Weep*.

When he had come near, he beheld the city and wept over it; Luke xix.

WERE, *pron.* (*wer*), which, when prolonged, becomes *ware*. This is used as the imperfect tense plural of *be*; we *were*, you *were*, they *were*; and in some other tenses. It is the Danish verb *været*, to be, to exist, *Sv. vara*, and in origin has no connection with *be*, nor with *was*. It is united with *be*, to supply its want of tenses, as *went* is with *go*.

WERE, *n.* A dam. [See WEIR.]

WER'EGILD, } *n.* [Sax. *wer*, man, and  
WER'EGELD, } the estimated value

WEHR'GELD, } of a man, and *gild*,  
gold, money.] Among the *Anglo-Saxons* and ancient Teutonic nations generally, a kind of fine for manslaughter, wounds, &c., by paying which the offender got rid of every further obligation or punishment. The fine or compensation due by the offender varied in amount according to his rank or station, and that of the person killed or injured, and also according to the nature of the crime. It was in general paid to the relatives of him who had been slain, or, in the case of a wound or other bodily harm, to the person who sustained the injury; but if the cause was brought before the community, the plaintiff only received part of the fine; the community, or the king, when there was one, received the other part.

WERNERIAN, *a.* Pertaining to Werner, the German mineralogist and geologist, who arranged minerals in classes, &c., according to their external characters, and advocated the theory, that the strata which compose the crust of the earth, were formed by depositions from water. The *Wernerian theory* of the earth is the same as the *Neptunian theory*. [See NEPTUNIAN.]

WERNERITE, *n.* A mineral regarded by Werner as a subspecies of scapolite; called foliated scapolite. It is a silicate of alumina, lime, and oxide of iron, and is named from that distinguished mineralogist, Werner. It is found massive, and crystallized in octahedral prisms with four-sided pyramidal terminations, disseminated in rocks of greyish or red feldspar. It is imperfectly lamellar, of a greenish, greyish, or olive green colour, with a



pearly or resinous lustre. It is softer than feldspar, and melts into a white enamel.

**WEST**, *n.* A Russian itinerary measure. [See **VERST**.]

**WERT**, the second person singular of the subjunctive imperfect tense of *be*. [See **WERE**.]

**WERTH**, } in names, signifies a farm,  
**WORTH**, } court, or village, from Sax. *weorthig*.

**WERVELS**, *n.* In *her*. See **VERVELS**.

**WE'SAND**. See **WEASAND**.

**WE'SIL**, † for *Weusand*.

**WESLEYAN**, *a* Pertaining to Wesleyanism.

**WESLEYAN**, *n.* One who adopts the principles and doctrines of Wesleyanism.

**WESLEYANISM**, *n.* Arminian Methodism; the system of doctrines and church polity inculcated by John Wesley.

**WEST**, *n.* [Sax. *west*; D. and G. *west*; Fr. *ouest*.] This word probably signifies decline or fall, or departure; as in *L. occidentis*, and in other cases. In elements, it coincides with *waste*.] 1. In *strictness*, that point of the horizon where the sun sets at the equinox, and midway between the north and south points, or any point in a direct line between the spectator or other object, and that point of the horizon; or west is the intersection of the prime vertical with the horizon, on that side where the sun sets. *West* is directly opposite to *east*, and one of the cardinal points. In a *less strict* sense, west is the region of the hemisphere near the point where the sun sets when in the equator. Thus we say, a star sets in the *west*, a meteor appears in the *west*, a cloud rises in the *west*.—2. A country situated in a region toward the sun-setting with respect to another. Thus in the United States, the inhabitants of the Atlantic states speak of the inhabitants of Ohio, Kentucky, or Missouri, and call them people of the *west*; and formerly, the empire of Rome was called the empire of the *West*, in opposition to the empire of the *East*, the seat of which was Constantinople.

**WEST**, *a.* Being in a line toward the point where the sun sets when in the equator; or in a *looser sense*, being in the region near the line of direction toward that point, either on the earth or in the heavens.

This shall be your *west* border; Num. xxxiv.

2. Coming or moving from the west or western region; as, a *west* wind.

**WEST**, *adv.* To the western region; at the westward; more westward; as, Ireland lies *west* of England.

**WEST**, † *v. i.* To pass to the west; to set, as the sun.

**WESTERING**, *a.* Passing to the west. [We believe not now used.]

**WESTERLY**, *a.* Being toward the west; situated in the western region; as, the *western* parts of England.—2. Moving from the westward; as, a *western* wind.

**WESTERLY**, *adv.* Tending, going, or moving toward the west; as, a man travelling *westernly*.

**WESTERN**, *a.* [west and Sax. *ærn*, place.] 1. Being in the west, or in the region nearly in the direction of west; being in that quarter where the sun sets; as, the *western* shore of France; the *western* ocean.—2. Moving in a line to the part where

the sun sets; as, the ship makes a *western* course.

**WESTERNMOST**, *a.* Farthest to the west.

**WEST'ING**, *n.* Space or distance westward.—2. In *navigation*, the difference of longitude a ship makes when sailing to the westward.

**WESTMINSTER ASSEMBLY**. A name given to the synod of divines and laymen, who, in the reign of Charles I., assembled, by authority of parliament, in Henry the Seventh's chapel, Westminster, for the purpose of settling the government, liturgy, and doctrine of the Church of England. The great majority of those who attended this assembly were presbyterians. Those members of episcopalian principles refrained from attending, because the king had declared against the assembly. The Westminster Assembly continued in existence for five years and a half. They signed the solemn league and covenant, drew up the Confession of Faith, a Directory for Public Worship, the Larger and Shorter Catechisms, and some other publications of temporary importance.

**WESTMOST**, *a.* Farthest to the west.

**WESTRIN'GIA**, *n.* A genus of plants, nat. order Lamiaceæ. The species are natives of New Holland, forming pretty shrubs, from one to three feet in height.

**WESTWARD**, *adv.* [Sax. *westward*; west and *ward*, L. *versus*.] Toward the west; as, to ride or sail *westward*.

**WESTWARDLY**, *adv.* In a direction toward the west; as, to pass *westwardly*.

**WET**, *a.* [Sax. *wæt*; Dan. *væde*, moisture, Gr. *ὕδατος*: L. *udus*.] 1. Containing water, as *wet* land, or a *wet* cloth; or having water or other liquid upon the surface, as a *wet* table. *Wet* implies more water or liquid than *moist* or *humid*.—2. Rainy; as, *wet* weather; a *wet* season.

**WET**, *n.* Water or wetness; moisture or humidity in considerable degree. Wear thick shoes or pattens to keep your feet from the *wet*.—2. Rainy weather; foggy or misty weather.

**WET**, *v. t.* pret. and pp. *Wet*. But *wetted* is sometimes used. [Sax. *wætan*; Sw. *våta*; Dan. *væder*.] 1. To fill or moisten with water or other liquid; to sprinkle or humectate; to cause to have water or other fluid adherent to the surface; to dip or soak in liquor; as, to *wet* a sponge; to *wet* the hands; to *wet* cloth.

*Wet* the thirsty earth with falling show'rs. Milton.

2. To moisten with drink.

**WET-DOCK**, *n.* A dock in which a uniform level of water is maintained, sufficient to keep ships afloat, and where the business of discharging and loading may proceed with convenience and safety. [See **DOCK**.]

**WETHER**, *n.* [Sax. *wether* or *wædder*. In Dan. *væder* is a ram.] A ram castrated.

**WETNESS**, *n.* The state of being wet, either by being soaked or filled with liquor, or by having a liquid adherent to the surface; as, the *wetness* of land; the *wetness* of a cloth. It implies more water or liquid than *humidness* or *moisture*.—2. A watery or moist state of the atmosphere; a state of being rainy, foggy, or misty; as, the *wetness* of weather or the season.

**WETNURSE**, *n.* A woman who nurses with the breast.

**WETSHOD**, *a.* Wet over the shoes; having wet feet.

**WET'TISH**, *a.* Somewhat wet; moist; humid.

**WEX**, *v. t.* or *i.* To grow; to wax. [Not to be used. See **WAX**.]

**WEY**, *n.* [from *weigh*.] A certain weight or measure. A *wey* of wool is 6½ tods, or 182 lbs.; a *wey* of butter or cheese varies from 2 to 3 cwt.; a *wey* of corn is 40 bushels Winchester measure.

**WE'ZAND**, for *Weasand*. [See the *latter*.]

*Note*.—In words beginning with *wh*, the letter *h*, or aspirate, when both letters are pronounced, precedes the sound of *v*. Thus *what*, *when*, are pronounced *hwat*, *hwen*. So they were written by our ancestors, and so they ought to be written still, as they are by the Danes and Swedes.

**WHACK**, *v. t.* To strike; to thwack. This is probably the primary word on which is formed *thwack*. [See **TWIR**. *Vulgar and local*.]

**WHACK**, *n.* A heavy blow; a thwack. [*Vulgar and local*.]

**WHACK'ER**, *n.* Anything uncommonly large; a great lie; the same as *Whopper*,—*which see*. [*Provincial and colloq.*]

**WHALE**, *n.* [Sax. *hwal*, *hwal*; G. *walfisch*, from *wallen*, to stir, agitate, or rove; D. *waleisch*; Sw. and Dan. *hval*.] This animal is named from roundness, or from rolling; for in Dan. *hvalt* is arched or vaulted; *hwæller*, to arch or vault, D. *welven*.] The common name of an order of aquatic mammalia, arranged by zoologists under the name of Cetacea. They are characterized by having fin-like anterior extremities, the posterior extremities having their place supplied by a large horizontal caudal fin or tail, and the cervical bones so compressed as to leave the animal without any outward appearance of a neck. In this order are comprised the largest animal forms in existence. Some of the genera are phytophagous, or feed upon plants; others are zoophagous, or feed upon animals. Their abode is in the sea or the great rivers, and they resemble the fishes so closely in external appearance, that not only the vulgar, but even some of the earlier zoologists regarded them as belonging to that class. The Cetacea are divided by Cuvier into two great tribes or families, one of which he terms *Herbivorous cetacea*, including the genera *Manatus*, *Halicore*, and *Stellerus*; and the other, *Ordinary cetacea*, comprising the genera *Delphinus*, *Phocæna*, *Monodon*, *Physeter*, and *Balæna*. The Herbivorous Cetacea, however, are rather aquatic pachydermata. The



Greenland Whale (*Balæna mysticetus*).

common or Greenland whale is the *Balæna mysticetus*, so valuable on

account of the oil and whalebone which it furnishes. It is principally found in the Arctic seas, but it is also found, in considerable numbers, in many other parts of the world. Its length is usually about 60 feet, and its greatest circumference from 30 to 40 feet. The razor-backed whale, or northern orqual, is the *Balenoptera physalis*. It is about 100 feet long, and from 30 to 35 feet in circumference. The sperm whale is the *Physeter macrocephalus*, and is about 80 feet in



Spermaceti Whale (*Physeter macrocephalus*).

length, and from 30 to 35 feet in circumference. It is principally found in the Southern ocean, on the coasts of America, Japan, New Guinea, &c., and is much valued on account of the spermaceti and the fine oil which it yields.

**WHALE BOAT, n.** A long narrow boat used with whale ships.

**WHALEBONE, n.** [*whale and bone.*] A well-known elastic horny substance, which adheres in thin parallel plates to the upper jaw of the whale. These plates or laminae vary in size from 3 to 12 feet in length; the breadth of the largest at the thick end, where they are attached to the jaw, is about a foot, and the average thickness is from four to five tenths of an inch. All above six feet in length are called *size bone*. From its flexibility, strength, elasticity, and lightness, whalebone is employed for many purposes, as for ribs to umbrellas and parasols, for stiffening stays, for the frame-work of hats, &c.

**WHALE-FISHERY, n.** The fishery or occupation of taking whales, and of procuring oil from them.

**WHALE-FISHING, n.** The act or employment of catching whales.

**WHALEMAN, n.** A man employed in the whale-fishery.

**WHALER, n.** A ship employed in the whale-fishery; a whaleman.

**WHALING, n.** The business of taking whales.

**WHALING, a.** Having a view to the pursuit of whales; as, a *whaling voyage*.

**WHALL, } n.** A disease of the eyes.  
**WHÄUL, } [See WALL-EYE.]**

**WHÄLLY, n.** Having greenish-white eyes. [*See WALL-EYE.*]

**WHAME, n.** A species of fly, tabanus, the burrel fly, that annoys horses, oxen, &c.

**WHAMMEL, } v. t.** To turn upside  
**WHEMMEL, } down. [Local or vul-**  
**WHUMMLE, } gar.] Whummle is**  
used in the same sense in Scotland, and also as a noun.

**WHANG, † n.** [*Sax. thuang.*] A leather thong; a piece of any thing. [*Local in English, but retained in the Scottish dialect.*]

**WHANG, v. t.** To beat; to flog. [*Local.*]

**WHAP, n.** A heavy blow; written also *Whop*. [*Vulgar and local.*]

**WHAP'PER, n.** Something uncommonly large of the kind. So *thumper* is connected with *thump*, to strike with a heavy blow; applied particularly to a bold lie; written also *Whopper*. [*Vulgar.*]

**WHARF, n.** (*hworf*.) *Sax. hwarf, hweorf; D. werf; Dan. verf; Russ. vorph.* In *D. werven* signifies to raise or levy.] A sort of quay, constructed of wood or stone, on the margin of a roadstead, harbour, or river, alongside of which ships or lighters are brought for the sake of being conveniently loaded or unloaded. There are two kinds of wharfs, viz., *legal wharfs and sufferance wharfs*. The former are certain wharfs in all sea ports, at which goods are required to be landed and shipped, by 1 Eliz. c. 11 (now repealed), and subsequent acts. Wharfs in docks and similar situations, are made legal by special acts of parliament; certain wharfs, as at Chepstow, Gloucester, &c., are deemed legal from immemorial usage. *Sufferance wharfs* are places where certain goods may be landed and shipped; as hemp, flax, coal, and other bulky goods, by special sufferance, granted by the crown for that purpose.

**WHARFAGE, n.** The fee or duty paid for the privilege of using a wharf for loading or unloading goods, timber, wood, &c.

**WHARF'ING, n.** Wharfs in general.

**WHARF'INGER, n.** A person who has the charge of a wharf.

**WHAT, pron. relative or substitute.** [*Sax. hwæt; Goth. waiht; D. wat; G. was; Dan. and Sw. hvad; Scot. quhat; L. quod, quid.* The *Sax. hwæt, hwat*, signifies brisk, lively, vigorous; which shows that this pronoun is the same word as *wight*, a living being, from the root of the *L. vivo*, for *vigo*. *See WIGHT.* The Gothic *h* represents the Latin *c*, in *victus*.] 1. That which. Say *what* you will, is the same as say *that which* you will.—2. Which part. Consider *what* is due to nature, and *what* to art or labour.—3. *What* is the substitute for a sentence or clause of a sentence. "I tell thee *what*, corporal, I could tear her." Here *what* relates to the last clause, "I could tear her;" this is *what* I tell you.—4. *What* is used as an adjective, of both genders, often in specifying sorts or particulars. See *what* colours this silk exhibits. I know *what* qualities you desire in a friend; that is, I know the *qualities which* you desire.—5. *What* is much used in asking questions. *What* sort of character is this? *What* poem is this? *What* man is this we see coming?—6. *What time*, at the time or on the day when.

*What time* the morn mysterious visions brings. *Pope.*

7. To how great a degree.

*What partial judges are our love and hate!* *Dryden.*

8. Whatever.

Whether it was the shortness of his foresight, the strength of his will...or *what* it was. *Bacon.*

9. Some part, or some. "The year before, he had so used the matter, that *what* by force, *what* by policy, he had taken from the Christians above thirty castles;" that is, he had taken above

thirty castles, a part or some by force, a part or some by policy; or *what* may be interpreted *partly*. Sometimes *what* has no verb to govern it, and it must be considered as adverbially used. "*What* with carrying apples and fuel, he finds himself in a hurry;" that is, partly, in part.—10. *What* is sometimes used elliptically for *what is this, or how is this?*

*What!* could ye not watch with me one hour? *Matt. xxvi.*

11. *What* is used interrogatively and elliptically, as equivalent to *what will be the consequence?* *What will follow?* as in the phrase, *what if I undertake this business myself?* *What though*, that is, grant this or that; allow it to be so. *What ho*, an exclamation of calling.

**WHAT, † n.** Fare; things; matter.

**WHATEV'ER, pron.** [*what and ever.*] Being this or that; being of one nature or another; being one thing or another; any thing that may be. *Whatever* is read, let it be read with attention. *Whatever* measure may be adopted, let it be with due caution. *Whatever* you do, let it be done with prudence.—2. All that; the whole that; all particulars that.

At once came forth *whatever* creeps.

*Milton.*

**WHAT NOT, n.** A stand, or piece of household furniture, having shelves for papers, books, &c.

**WHATSOEVER, † n.** Whatsoever.

**WHATSOEVER, a.** compound of *what, so, and ever*, has the sense of *whatever*, and is less used than the latter. Indeed it is nearly obsolete.

**WHEAL, n.** A mine, *Cornish dialect.*

**WHEAL, n.** A pustule; a small swelling filled with matter. [*See WEAL.*]

**WHEAT, n.** [*Sax. hwæte; Goth. hwit; Ice. hveitenu; G. weizen; D. weit.*] A plant of the genus *Triticum*, and the seed of the plant, which furnishes a white flour for bread, and is by far the most important species of grain cultivated in Europe. It grows readily in almost every climate; but its natural home seems to be a temperate climate, and the soils best adapted for its culture are rich clays and heavy loams. Several species of wheat are enumerated by botanists, as summer or spring wheat (*T. aestivum*); winter wheat (*T. hybernum*), common bearded wheat (*T. turgidum*), single grained wheat (*T. monococcum*), Polish wheat (*T. polonicum*), Egyptian wheat (*T. egyptiacum*), spelter wheat (*T. spelta*). Many botanists, however, consider most of these as merely varieties, and others look upon all the cultivated wheats as varieties. Of cultivated wheats there are many varieties, but there are three principal ones which claim attention, viz., *hard wheats*, which are the produce of warm climates; *soft wheats*, which grow in the northern parts of Europe, as in Belgium, England, Denmark, and Sweden; and Polish wheats, which grow in Poland. The difference in colour between red and white wheats is owing chiefly to the soil, and, in fact, the varieties of wheat are perpetually changing in consequence of variations of culture, climate, and soil. The wheats cultivated in England are mostly varieties of the winter wheat and common bearded wheat. [*See TRITICUM.*]

**WHEAT-EAR, n.** An ear of wheat.—2. A small bird, the *Motacilla cyanthe*,

Linn., and *Saxicola ananthe*, of modern ornithologists. It is also known by the names of fallow-finch, white-tail, stone-chacker, chack-bird, &c. It is very abundant in Europe. [See FALLOW-FINCH.]  
**WHEATEN**, *a.* (hwee'tn.) Made of wheat; as, *wheaten* bread.  
**WHEAT-FLY**, *n.* An insect of the genus *Cecidomyia*, the *C. tritici*. It is

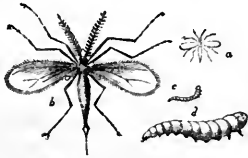

Wheat-fly (*Cecidomyia tritici*).

*a.*, Insect natural size; *b.*, Insect magnified; *c.*, Larva natural size; *d.*, Larva magnified.

a two-winged gnat, about the tenth of an inch long, and appears about the end of June. The females lay their eggs in clusters of from two to fifteen, among the chaffy flowers of the wheat, where they are hatched in about eight or ten days, producing little footless maggots, whose ravages destroy the flowers of the plant, and render it shrivelled and worthless. [See HESSIAN-FLY.]

**WHEAT-GRASS**, *n.* The common name of several British plants of the genus *Triticum*. [See TRITICUM.]

**WHEAT-PLUM**, *n.* A sort of plum.

**WHEE'DLE**, *v. t.* [Qu. Gr. *γεννηω*, or *γεννῶμαι*.] To flatter; to entice by soft words; to cajole; to coax.

To learn th' unlucky art of *wheeling* fools. *Dryden.*

**WHEE'DLE**, *v. i.* To flatter; to coax.

**WHEE'DLE**, *n.* Enticement; cajolery.

**WHEE'DLED**, *pp.* Flattered; enticed; coaxed.

**WHEE'DLER**, *n.* One who wheedles.

**WHEE'DLING**, *pp.* Flattering; enticing by soft words.

**WHEE'DLING**, *n.* The act of flattering or enticing.

**WHEEL**, *n.* [Sax. *hweol*, *hweohl*, *hweogol*; D. *wiel*; Sw. *hiul*.] A circular frame or solid disc of wood or metal turning on an axis. Wheels, as applied to carriages, usually consist of a nave, into which are inserted spokes or radii, which connect it with the periphery, or circular ring. Wheels are of various kinds; as, carriage wheels, water wheels, toothed wheels, conical wheels, fly wheels, pinions, lanterns, &c. Wheels are most important agents in machinery, being employed in a variety of forms and combinations, for the purpose of transmitting motion, regulating velocity, converting one species of motion into another, reducing friction, and equalizing the effect of forces applied in an intermittent or irregular manner.—

*Wheel and axle*, one of the mechanical powers, sometimes named the *axis in peritrochio*, consisting of a wheel with a cylindrical axis of greater or less diameter passing through its centre and turning along with it. By reference to figs. 1, 2, it will be seen that this power resolves

Fig. 1.

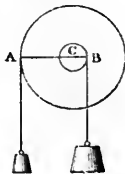

itself into a lever of the first order, in which the weight and power are at the ends, and the fulcrum between them. C is the centre, or fulcrum; AC and CB are the semi-diameters of the wheel and the axle; and on the principle of the lever the power is to the weight as AC is to CB. The wheel is grooved and carries a coil of rope; another rope is secured to the axis; and when the power is in motion, every revolution of the wheel raises the weight to a height equal to the circumference of the axis or cylinder. The power is increased by enlarging the wheel or diminishing the diameter of the cylinder; but there is a limit beyond which the increase cannot be obtained with safety. There is a modification of the wheel and axle, called the *double axis machine*, in which the power can be increased with more safety. This is shown in figure, 3 where *b* and *c* are two cylinders of different diameters, firmly fixed on the axis carrying the crank *a*. The rope is coiled round the smaller cylinder, carried through a pulley supporting the weight, and then attached to the larger cylinder in a contrary direction. When in motion, every turn of the crank lifts the weight to a height equal to half the difference between the circumferences of the two axes; and the power is therefore to the weight, as this half difference is to the circumference of the power, or the circle described by the crank *a*. Hence the power is increased by making the axes more nearly of the same diameter; but there is a limit to this increase, since if *b* and *c* come to be of equal thickness, the weight would not rise at all; the rope, in that case, wound upon *b* being only equal to that unwound from *c*. The *wheel and axle* is sometimes called the *perpetual lever*, in consequence of the power being *continued* by the revolution of the wheel. The common winch, the windlass, the capstan, and the treadmill, are so many applications of the wheel and axle; and the annexed fig. 4 shows an adaptation of the same principle to a train of wheel-work, wherein motion is regulated and power acquired. The power F is applied to the circumference of the wheel A, whose pinion drives the wheel B, which by another pinion gives motion to the wheel D, carrying an axle supporting and raising the weight W. The power in this combination is to the weight, as the continued product of the radii of all the wheels, to that of the radii of all the axes.—2. A circular body.—3. A carriage that moves on wheels.—4. An instrument for torturing criminals; as, an examination made by the rack and the *wheel*.—5. A machine for spinning

Fig. 2.

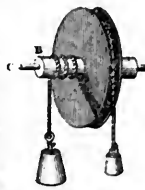

Fig. 3.

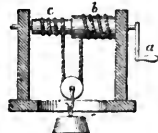
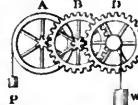

Fig. 4.



thread of various kinds.—6. Rotation; revolution; turn; as, the vicissitude and *wheel* of things.—7. A turning about; a compass. He throws his flight in many an airy *wheel*. *Milton.*  
 8. In *pottery*, a round board turned by a lathe in a horizontal position, on which the clay is shaped by the hand.  
 —9. A circular frame having handles on the periphery, and connected by the tiller-ropes or wheel-ropes with the rudder, used for steering a ship.  
**WHEEL**, *v. t.* To convey on wheels, or on a wheel-barrow; as, to *wheel* earth, stones, wood, hay, &c.—2. To put into a rotary motion; to cause to turn round; to whirl.  
**WHEEL**, *v. i.* To move on wheels; to turn on an axis; to have a rotatory motion.—2. To turn; to move round; as, a body of troops *wheel* to the right or left.—3. To fetch a compass. Then *wheeling* down the steep of heav'n he flies. *Pope.*  
 4. To roll forward. *Thunder* Must *wheel* on th' earth, devouring where it rolls. *Milton.*  
**WHEEL'-ANIMAL**, } *n.* One  
**WHEEL'-ANIMAL'-CULE**, } of a class of infusorial animals, having arms for seizing their prey resembling wheels; a rotifer. [See ROTIFERS.]  
**WHEEL-BAROMETER**. See BAROMETER.  
**WHEEL-BARROW**, *n.* [*wheel* and *barrow*.] A sort of hand-machine, consisting of a frame with two handles or trams, and frequently a box, supported on a single wheel, and rolled by a single individual. Its uses are well known.  
**WHEEL-BIRD**, *n.* A name given to a bird of the genus *Caprimulgus*, the *C. europæus*, on account of the noise made by the male during incubation, when perched, which is not unlike that of a spinning wheel. It is also known by the names of goat-sucker, night-jar, night-hawk, &c.  
**WHEEL-BOAT**, *n.* [*wheel* and *boat*.] A boat with wheels, to be used either on water or upon inclined planes or railways.  
**WHEEL-CARRIAGE**, *n.* [*wheel* and *carriage*.] A carriage moved on wheels. Under this term writers on mechanics usually include all sorts of vehicles which move on wheels, and are drawn by horses or propelled by steam; as, coaches, chaises, gigs, railway carriages, waggons, carts, &c. The use of wheels in such vehicles is twofold, viz., to lessen the friction, and to enable the vehicle more easily to overcome obstacles on the road.  
**WHEEL-CUTTING**, *n.* The operation of cutting the teeth in the wheels used by watch and clock makers, and for other mechanical purposes. This is effected by means of engines.  
**WHEELED**, *pp.* Conveyed on wheels; turned; rolled round.—2. *a.* Having wheels—used in composition; as, a *two-wheeled* carriage, a *four-wheeled* carriage.  
**WHEELER**, *n.* One who wheels; a maker of wheels; a wheel-horse, or one next the wheels of the carriage.  
**WHEELERA**, *n.* A genus of plants, nat. order Leguminosæ. *W. ebenus*, American ebony, is a native of America and the West Indies. It is cut and sent to this country under the name of ebony, although it is very different from the true ebony. The wood

is very hard, and is much employed by cabinet and musical instrument-makers.

**WHEEL-FIRE, n.** [*wheel* and *fire*.] In *chem.*, a fire which encompasses the crucible without touching it.

**WHEELING, ppr.** Conveying on wheels or in a wheel-carriage; turning.

**WHEELING, n.** The act of conveying on wheels; the act of conveying materials, as earth, stones, &c., on a wheelbarrow.—2. A turning or circular movement of troops embodied.

**WHEEL-PLOUGH, n.** A plough with a wheel or wheels added to it, for the purpose of regulating the depth of the furrow, and rendering the implement more steady to hold. [See *Plough*.]

**WHEEL-RACE, n.** The place in which a water-wheel is fixed.

**WHEEL-ROPES, n.** In *ships*, ropes which are reeved through a block on each side of the deck, and led round the barrel of the steering wheel, to assist in steering. Chains are now much more commonly used for this purpose.

**WHEEL-SHAPED, a.** [*wheel* and *shape*.] In *bot.*, rotate; monopetalous, expanding into a flat border at top, with scarcely any tube; as, a *wheel-shaped* corolla.

**WHEEL-TIRE, n.** The iron band that encircles a wooden wheel. [See *TIRE*.]

**WHEEL-WINDOW, n.** In *Gothic arch.*, a circular window with radiating mullions resembling the spokes of a wheel. [See *CATHERINE-WHEEL*.]

**WHEEL-WORK, n.** In *machinery*, the combination of wheels which communicate motion to one another. Such combinations are generally reducible to the principle of the wheel and axle, though the wheel which turns the other is not always on the same axis with it. The motion in such cases is communicated from the one wheel to the other by belts or straps passing over the circumferences of both, or by teeth cut in those circumferences, and working in one another. When the resistance of the work is not great, motion may be transmitted from one wheel to another by causing their peripheries to revolve in contact with each other, by the mere friction of the surfaces in contact. The most familiar instances of wheel-work are to be found in clocks and watches.

**WHEEL-WORN, a.** Worn by the action of moving wheel-tires.

**WHEEL-WRIGHT, n.** [*wheel* and *wright*.] A man whose occupation is to make wheels and wheel-carriages, as carts and waggons.

**WHEELY, a.** Circular; suitable to rotation.

**WHEEZE, v. i.** [Sax. *hweosan*; Arm. *chueza*; Sw. *hes*, hoarse; Sw. *hväsa*, to hiss; to *whiz*; Dan. *hvaea*, a whistling. *Wheeze*, *whiz*, and probably *whisper*, are of one family, and accord with the root of the L. *astula*.] To breathe hard and with an audible sound, as persons affected with asthma.

**WHEEZING, ppr.** Breathing with difficulty and noise.

**WHEEZING, n.** A noisy respiration, produced by obstruction of the air passages.

**WHELK, n.** A wrinkle; inequality on the surface; protuberance; a pustule, generally situated on the face. [See *WELK* and *WEAL*.]—2. A shell named the *Buccinum undatum*, or trumpet-shell, univalvular, spiral, and gibbous,

with an oval aperture ending in a short canal or gutter. It is much used for food.

**WHELK'Y, a.** Protuberant; embossed; rounded.

**WHELM, v. t.** [Sax. *ahwylfan*; Goth. *hulpan*; Ice. *wilma* or *hwilma*.] 1. To cover with water or other fluid; to cover by immersion in something that envelops on all sides; as, to *whelm* a person or a company in the sea; to *whelm* a caravan in sand or dust.—2. To cover completely; to immerse deeply; to overburden; as, to *whelm* one in sorrows.—3. † To throw over so as to cover.

**WHELM'ED, pp.** Covered, as by being plunged or immersed.

**WHELM'ING, ppr.** Covering, as by immersion.

**WHELP, n.** [Dan. *hvalp*; Sw. *valp*; D. *welp*. This word coincides in elements with *wolf*, L. *vulpes*.] 1. The young of the canine species, and of several other beasts of prey; a puppy; a cub; as, a bear robbed of her *whelps*; lion's *whelps*.—2. A son; in *contempt*.—3. A young man; in *contempt*.

**WHELP, v. i.** To bring forth young, as the female of the canine species and some other beasts of prey.

**WHELPS, n.** In *ships*, upright pieces of wood placed round the barrel of the capstan, to prevent it from being chafed, and to afford resting points for the messenger or hawsers. The same name is given to pieces of wood bolted on the main piece of a windlass or a winch, for a similar purpose.

**WHEN, adv.** [Goth. *hwan*; Sax. *hwæne*; G. *wann*; D. *wanneer*; L. *quando*; Gaelic, *cuinne*.] 1. At the time that.—2. At what time, interrogatively.

*When shall these things be?* Matt. xxiv.  
3. Which time.

I was adopted heir by his consent;  
Since *when*, his oath is broke. *Shak.*

4. After the time that. *When* the act is passed, the public will be satisfied.  
—5. At what time.

Kings may  
Take their advantage *when* and how they  
list. *Daniel.*  
*When* as, at the time when; what time. †  
*When* as sacred light began to dawn.  
*Milton.*

**WHENCE, adv.** [Sax. *hwanon*.] 1. From what place.

*Whence* and what art thou? *Milton.*

2. From what source. *Whence* shall we derive hope? *Whence* comes this honour?

*Whence* hath this man this wisdom?  
Matt. xiii.

3. From which premises, principles, or facts. These facts or principles are admitted, *whence* it follows, that judgment must be entered for the plaintiff.

—4. How; by what way or means; Mark xii.—5. In general, from which person, cause, place, principle, or circumstance.—*From whence* may be considered as tautological, *from* being implied in *whence*; but the use is well authorized, and in some cases the use of it seems to give force or beauty to the phrase. We ascended the mountain, *from whence* we took a view of the beautiful plains below.—*Of whence* is not now used.

**WHENCESOEVER, adv.** [*whence*, *so*, and *ever*.] From what place soever; from what cause or source soever.

Any idea, *whencesoever* we have it. *Locke.*

**WHENCEVER.** See *WHENCESOEVER*.

**WHENEVER, adv.** [*when* and *ever*.] At whatever time. *Whenever* you come, you will be kindly received.

**WHENSOEVER, adv.** [*when*, *so*, and *ever*.] At what time soever; at whatever time.

**WHERE, adv.** [Sax. *hwær*; Goth. *hwar*; D. *waar*.] 1. At which place or places.

She visited the place *where* first she was so happy. *Sidney.*

In all places *where* I record my name, I will come to thee and I will bless thee; Exod. xx.

2. At or in what place.  
Adam, *where* art thou? Gen. iii.

3. At the place in which.  
*Where* I thought the remnant of my age  
Should have been cheris'h'd by her child-  
like duty. *Shak.*

4. Whither; to what place or from what place. *Where* are you going? *Where* are you from? [These uses of *where* are common, and the first cannot be condemned as vulgar.]—*Any where*, in any place. I sought the man, but could not find him *any where*.—*No where*, at or in no place.

*Note*.—*Where* seems to have been originally a noun, and was so used by Spenser. "He shall find no *where* safe to him." In this sense, it is obsolete; yet it implies place, its original signification.

**WHEREABOUT, comp.** [*where* and *about*.] Near what place. *Whereabout* did you meet your friend?

2. Near which place.—3. Concerning which.

The object *whereabout* they are conversant.

It often takes the form *whereabouts*.

**WHEREABOUT, † n.** The place where one is.

**WHEREAS, comp.** (*s* as *z*.) [*where* and *as*.] When in fact or truth, implying opposition to something that precedes.

Are not those found to be the greatest zealots, who are most notoriously ignorant? *whereas* true zeal should always begin with true knowledge. *Sprat.*

2. The thing being so that; considering that things are so; implying an admission of facts, sometimes followed by a different statement, and sometimes by inferences or something consequent, as in the law style, where a preamble introduces a law.

*Whereas* wars are generally causes of poverty... *Bacon.*

3. † *Whereat*; at which place.—4. But on the contrary. [See No. 1.]

**WHEREAT, comp.** [*where* and *at*.] At which.

*Whereat* he was no less angry and ashamed, than desirous to obey *Zelmana*.

*Sidney.*

2. At what, interrogatively. *Whereat* are you offended?

**WHEREBY, comp.** [*where* and *by*.] By which.

You take my life,  
When you do take the means *whereby* I live.

*Shak.*

2. By what, interrogatively.  
*Whereby* shall I know this? *Luke* i.

**WHEREFORE, comp.** [*where* and *for*.] For which reason.

*Wherefore* by their fruits ye shall know them; *Matth.* vii.

2. Why; for what reason.  
*Wherefore* didst thou doubt? *Matth.* xiv.

**WHEREIN, comp.** [*where* and *in*.] In which; in which thing, time, respect,

book, &c. This is the thing *wherein* you have erred.—2. In what.

Yet yessay, *wherein* have we wearied him? Mal. ii.

**WHEREINTO'**, † *comp.* [*where* and *into.*] Into which.

**WERENESS**, † *n.* Ubiety; imperfect locality.

**WHEREOF**, *comp.* [*where* and *of.*] Of which. We are not guilty of the crime *whereof* we are accused.—2. † Of what. *Whereof* was this house built.

How this world, when and *whereof* created. Milton.

**WHEREON**, *comp.* [*where* and *on.*] On which; as, the ground *whereon* we tread.—2. † On what. *Whereon* do we stand?

**WHERE'SO**, † *comp.* See **WHERESOEVER**.

**WHERESOEVER**, *comp.* [*where*, *so*, and *ever.*] In what place soever; in whatever place, or in any place indefinitely. Seize the thief, *wheresoever* he may be found. [*Wherever* is the preferable word.]

**WHERE'THROUGH**, through which, is not in use.

**WHERE'TO**, *comp.* [*where* and *to.*] To which.

*Whereto* we have already attained; Phil. iii.

2. To what; to what end. [*Lit. us.*] **WHEREUNTO**, † *comp.* The same as *whereto*.

**WHEREUPON**, *comp.* Upon which. The townsmen mutilated and sent to Essex, *whereupon* he came thither.

Clarendon.

**WHEREVER**, *comp.* [*where* and *ever.*] At whatever place.

He cannot but love virtue, *wherever* it is. Atterbury.

**WEREWITH**, *comp.* [*where* and *with.*] With which.

The love *wherewith* thou hast loved me; John xvii.

2. With what, interrogatively.

*Wherewith* shall I save Israel? Judges vi.

**WEREWITHAL**, *comp.* [*See WITHAL.*] [*where*, *with*, and *all.*] The same as *wherewith*.

**WHER'RET**, † *v. t.* [*G. wirren.* Qu.] To hurry; to trouble; to tease; to give a box on the ear. [*Low.*]

**WHER'RET**, † *n.* A box on the ear.

**WHER'RY**, *n.* [a different orthography of *ferry*, formed with a strong breathing; like *whistle*, from the root of *L. fistula.*] 1. A boat used on rivers. The name is given to several kinds of light boats. It is also applied to some half decked vessels used in fishing, in different parts of Great Britain and Ireland.—2. A liquor made from the pulp of crabs after the verjuice is expressed; sometimes called *crab-wherry*. [*Local.*]

**WHET**, *v. t.* pret. and pp. *Whetted* or *Whet*. [*Sax. hwettan*; *Sw. hvässa*; *Dan. hvas*, sharp; *hwedser*, to whet; *D. wetten*; *G. wetzen.*] 1. To rub for the purpose of sharpening, as an edge tool; to sharpen by using a whetstone; to edge; as, to *whet* a scythe or an axe.—2. To provoke; to excite; to stimulate; as, to *whet* the appetite.—3. To provoke; to make angry or acrimonious.

Since Cassius first did *whet* me against Cesar.

I have not slept. Shak. To *whet on*, or *whet forward*, to urge on; to instigate. †

**WHET**, *n.* The act of sharpening by friction.—2. Something that provokes

or stimulates the appetite; as, sips, drams and *whets*.

**WHETTER**, *pronoun* or *substitute*. [*Sax. hwæther.* This word seems to be connected with *what* and the *L. uter*, the latter not being aspirated. The sense seems to be *what*, or *which* of two, referring either to persons or to sentences.] 1. Which of two.

*Whether* of them twain did the will of his father? Matth. xxi.

Here *whether* is a substitute for *one* of two, and signifies *which*; *which* of the two; but in this sense it is obsolete.—2. Which of two alternatives expressed by a sentence or the clause of a sentence, and followed by *or*. "Resolve *whether* you will go or not;" that is, you will go or not go; resolve *which*.

*Note*.—In the latter use, which is now most common, *whether* is called an adverb. This is a mistake. It is the same part of speech as in the former example. The only difference is that in the former example it represents or refers to a noun, and in the latter to a sentence or clause.

**WHETTERING**, *n.* The retention of the after birth in cows.

**WHETSTONE**, *n.* [*whet* and *stone.*] A smooth flat stone used for sharpening edged instruments by friction. Whetstones, or *hones*, as they are sometimes called, are made of various kinds of hard close-grained stone, and when used, are moistened with oil or water.

**WHETSTONE-SLATE**, † *n.* Novaculite.

**WHET-SLATE**, † *n.* lite or coticular schist, a variety of slate used for sharpening instruments of iron. The light green coloured variety from the Levant is the most valuable. It should be kept in a damp place, that it may not become too dry and hard. [*See NOVACULITE.*]

**WHETTED**, *pp.* Rubbed for sharpening; sharpened; provoked; stimulated.

**WHETTER**, *n.* He or that which whets or sharpens.

**WHETTING**, *ppr.* Rubbing for the purpose of making sharp; sharpening; provoking; inciting; stimulating.

**WHEW**, *interjection.* Begone! expressing aversion or contempt.

**WHEWER**, *n.* Another name of the widgeon. [*Local.*]

**WHEY**, *n.* [*Sax. hwæg*; *D. wei* or *hui.*] The serum or watery part of milk, separated from the more thick or coagulable part, particularly in the process of making cheese. In this process, the thick part is called *curd*, and the thin part *whey*.—2. Any thing white and thin.

**WHEY**, *a.* White or pale; as, a *whey* face.

**WHEYEY**, *a.* Partaking of whey; resembling whey.

**WHEYISH**, *a.* Having the qualities of whey.

**WHEYISHNESS**, *n.* Quality of being wheyish.

**WHICH**, *pron.* [If this is from the *Sax. hwilt* or *hwyle*, it is from the Gothic *hwelths*, which coincides with the Latin *quæ*; *D. welk*, *G. welche*, *welcher*, *Dan. hwilken*, *hwilket*, *Sw. hwilken*. This is the probable origin of the word, and its true sense is that of the Latin *quis*, *quæ*, *quicumque*. In these senses it occurs in all Saxon books. Its proper use was as a pronoun of interrogation, "Hwylc man is of eow?" what man is there of you? Matth. vii. 9. "Hwylc is min modor?" who is my mother? Mark iii. 33. Its use for

*who*, Saxon *hwa*, as in the Lord's prayer, "Our father *which* art in heaven," is an improper application of the word. In its original sense it is used for all genders; as, *which* man, *which* woman, *which* thing? As an interrogative we still use it in this manner. Its use for *who* was of long continuance, but is happily discontinued; and our present practice accords with its original use in the Saxon.] 1. A pronoun or word of interrogation, in all genders; as, *which* man is it? *which* woman was it? *which* is the house?—2. In reference to *things*, or in the neuter gender, it is a relative referring to something before mentioned; as, "God rested on the seventh day from all his work *which* he had made;" Gen. ii. 2. In some phrases, the relative may precede the noun to which it refers.—3. *Which*, like other pronouns, may be used as a substitute for another word or for a sentence. "We are bound to obey all the divine commands, *which* we cannot do without divine aid." Here *which* is a substitute for *obey all the divine commands*. The man was said to be *innocent*, *which* he was not. Here *which* is a substitute for *innocent*.—4. That which; those which; as, take *which* you will.—*The which*, by the *which*, &c., are obsolete.

**WHICHOEVER**, † *pron.* Whether **WHICHSOEVER**, † one or the other. *Whichever* road you take, it will conduct you to town.

**WHID**, *n.* A quick motion; a smart stroke; a lie. As a verb, to whisk; to move nimbly, as a hare or other small animal. [*Scotch.*]

**WHID'AIL-FINCH**. A genus, *Vidua*, of several species of beautiful birds, inhabiting India and Southern and Western Africa, and found in great abundance in the kingdom of Dahomey, near Whidah. In size of body, the Whidah-finch resembles a linnnet or canary-bird, and during the breeding season, the male is supplied with long, drooping, not elegant, but certainly disproportioned tail feathers. *V. paradisea* is of a deep brownish-black on the upper parts, but paler on the wings. The body, abdomen,



1 Broad-shafted Whidah-finch (*Vidua paradisea*), and 2 Red-billed Whidah (*Vidua erythrorhynchos*).

and thighs are of a pale buff, and a rich orange-rufon colour nearly surrounds its neck. *V. erythrorhynchos* is less than the former, and is of a deep glossy blue-black colour on the upper parts, with the sides of the head and

under parts white. These birds are commonly called *widow-birds*, but whether this be merely a translation of their Latin generic name, *Vidua*, which was probably given from the sombre hue of the plumage, or whether it be a corruption of Whidah, is uncertain.

**WHIFF**, *n.* [W. *cwif*, a whiff or puff, a hiss; *cwifaw*, to whiff, and *cwaf*, a quick gust.] 1. A sudden expulsion of air from the mouth; a puff; as the *whiff* of a smoker.

And seasons his *whiff* with impertinent jokes. *Pope*.

2. In *ichthyology*, a flat malacopterygious fish, belonging to the family Pleuronectidae. It is a British fish, of the turbot or flounder group, *Rhombus megastoma*, and in Cornwall is called *carter*. It is not highly esteemed for the table.

**WHIFF**, *v. t.* To puff; to throw out in whiffs; to consume in whiffs; to smoke. **WHIFFLE**, *v. i.* [D. *weifelen*, to waver; *zweeven*, to hover. This accords in sense with G. *zweifeln*, to doubt, which would seem to be from *zwei*, two, or its root. The G. has also *schweifeln*, to rove or wander, which seems to be allied to *sweep*. The D. has also *twyffelen*, to doubt, from *tuete*, two, or its root; Sw. *twifla*, Dan. *twivler*, from the root of *two*. Yet *whiffle* seems to be directly from *whiff*.] To start, shift, and turn; to change from one opinion or course to another; to use evasions; to prevaricate; to be fickle and unsteady.

A person of *whiffing* and unsteady turn of mind, cannot keep close to a point of a controversy. *Watts*.

**WHIFFLE**, *† v. t.* To disperse with a puff; to scatter.

**WHIFFLE**, *n.* Anciently, a pipe or small flute.

**WHIFFLER**, *n.* One who whiffles or frequently changes his opinion or course; in argument; one of no consequence; one driven about by every puff.—2. A piper or fifer.—3. A harbinger; an officer who went before processions, to clear the way by blowing the horn or trumpet.

**WHIFFLE-TREE**. See **WHIPPLE-TREE**.

**WHIFFLING**, *ppr.* Shifting and turning; prevaricating; shuffling.

**WHIFFLING**, *n.* Prevarication.

**WHIG**, *n.* [Sax. *hwæg*. See **WHEY**.] Acidulated whey, sometimes mixed with buttermilk and sweet herbs, used as a cooling beverage. [Local.] In *Scotland*, this term is applied to the thin serous liquid which lies below the cream in a churn, after it has become sour, and before it has been agitated.

**WHIG**, *n.* The designation of one of the great political parties in this country. The term is of Scottish origin, and was first used in the reign of Charles II. According to Bishop Burnet, it is derived from *whiggam*, a word which was used by the peasants of the south-west of Scotland, in driving their horses; the drivers being called *whiggamores*, contracted to *whigs*. In 1648, after the news of the Duke of Hamilton's defeat, the clergy stirred up the people to rise and march to Edinburgh, and they themselves marched at the head of their parishes. The Marquis of Argyll and his party came and headed them. This was called the *whiggamores'*

*inroad*, and ever after that all that opposed the court came, in contempt, to be called *whiggs*; and from Scotland, the word was brought to England, where it has since continued to be used as the distinguishing appellation of the political party opposed to the *Tories*. It was first assumed as a party name by that body of politicians who were most active in placing William III. on the throne of England. Generally speaking, the principles of the whigs have been of a popular character, and their measures, when in power, tending to increase the democratic influence in the constitution. [See **TORY**.] In *American hist.*, the friends and supporters of the war and the principles of the revolution, were called *whigs*, and those who opposed them were called *tories* and *royalists*.

**WHIG**, *a.* Relating to the whigs; whiggish; as, *whig* measures; a *whig* ministry.

**WHIG'GARCHY**, *n.* Government by whigs. [Cant.]

**WHIG'GERY**, *n.* The principles of the whigs; whiggism.

**WHIG'GISH**, *a.* Pertaining to whigs; partaking of the principles of whigs.

**WHIG'GISHLY**, *adv.* In a whiggish manner.

**WHIG'GISM**, *n.* The principles of the whigs.

**WHIG'LING**, *n.* A whig, in contempt. **WHILE**, *n.* [Sax. *hwile*; G. *weil*; D. *wyl*; time, while; Sw. *hwila*, repose; W. *gwyl*, a turn, Ir. *foil*. See the verb.] Time; space of time, or continued duration. He was some *while* in this country. One *while* we thought him innocent.

Pausing a *while*, thus to herself she mus'd. *Milton*.

*Worth while*, worth the time which it requires; worth the time and pains; hence, worth the expense. It is not always *worth while* for a man to prosecute for small debts.

**WHILE**, *adv.* During the time that. *While* I write you sleep.—2. As long as.

Use your memory, and you will sensibly experience a gradual improvement, *while* you take care not to overload it. *Watts*.

3. At the same time that.

**WHILE**, *v. t.* [W. *gwylaw*, to turn, to run a course, to bustle; Eth. *waala*, to pass the time, to spend the day or life, to remain; Amharic, *id.*; Dan. *hwiler*, Sw. *hwila*, to rest or repose; Ir. *foillim*, to stay, to rest, to tarry; G. *weilen*, *verweilen*, to abide, to stay; Qu. the identity of these words.] To draw out; to waste in a tedious way.—*To while away*, as time, in English, is to loiter; or more generally, to cause time to pass away pleasantly, without irksomeness; as, we *while* away time in amusements or diversions.

Let us *while away* this life. *Pope*.

**WHILE**, *v. i.* To loiter; to spend to little use; as time.

**WHILERE**, *† adv.* [while and ere.] A little while ago.

**WHILES**, *† adv.* While.

**WHILING**, *ppr.* Loitering; passing time agreeably, without impatience or tediousness.

**WHILK**, *n.* A shell. [See **WHELK**.]

**WHILK**, *pron. rel.* Which. [Scotch.] The old spelling was *quhilk*.]

Or, as the Scots say, *whilk*. *Byron*.

**WHILOM**, *† adv.* [Sax. *hwilon*.] Formerly; once; of old.

**WHILST**, *adv.* The same as *while*.

**WHIM**, *n.* [Ice. *hwima*; W. *cwim*, a brisk motion, a turn; *gwimiar*, to move round briskly; Sp. *quimera*, a whim, a wild fancy, a scuffle.] 1. Properly, a sudden turn or start of the mind; a freak; a fancy; a capricious notion. We say, every man has his *whims*. [See **FREAK** and **CAPRICE**.]

All the superfluous *whims* relate. *Swift*. 2. A low wit; a cant word.—3. A machine or large capstan worked by horses, for raising ore, water, &c., from the bottom of a mine.

**WHIM'BREL**, *n.* The *Numenius phaeopus*, a gallatorial bird closely allied to the curlew, but considerably smaller in size. It is an inhabitant of most parts of Europe, and is also found in North Africa, and in several parts of Asia. It visits this country most plentifully in May and autumn.

**WHIM'PER**, *v. i.* [G. *wimmern*.] To cry with a low, whining, broken voice; as, a child *whimpers*.

**WHIM'PERER**, *n.* One who whimpers.

**WHIM'PERING**, *ppr.* Crying with a low broken voice.

**WHIM'PERING**, *n.* [supra.] A low muttering cry.

**WHIM'PLED**, *a.* [A word used by Shakspeare, perhaps a mistake for *whimpered*.] Distorted with crying.

**WHIM'SEY**, *n.* (*s* as *z*.) [from *whim*.] A whim; a freak; a capricious notion; as, the *whimsies* of poets.

Men's follies, *whimsies*, and inconstancy. *Swift*.

**WHIM'SEY**, *† v. t.* To fill with whimses.

**WHIM'SICAL**, *a.* Full of whims; freakish; having odd fancies; capricious.

My neighbours call me *whimsical*.

**WHIM'SICALLY**, *adv.* [supra.] In a whimsical manner; freakishly.

**WHIM'SICALNESS**, or **WHIM'SICALITY**, *n.* [supra.] Freakishness; whimsical disposition; odd temper.

**WHIM'WHAM**, *† n.* A plaything; a toy; a freak or whim; an odd device.

**WHIN**, *n.* [In W. *gwyn* is a weed; L. *Genista spinosa*.] Gorse; furze; a plant of the genus *Ulex*. [See **FURZE**, **ULEX**.]—*Petty-whin*, is a species of *Genista*, the *G. anglica*.—2. A mineral. [See **WHINSTONE**.]

**WHIN'-AXE**, *n.* [whin and axe.] An instrument used for extirpating whin from land.

**WHIN'-CHAT**, *n.* A passerine bird of the genus *Saxicola*, the *S. rubetra*. It is not infrequent in the British Islands during summer, and may be commonly found on broom and furze, on the highest twigs of which it perches, and occasionally sings very sweetly. It is closely allied to the stonechat.

**WHINE**, *v. i.* [Sax. *wanian* and *cwanian*; Goth. *hwainon*; Dan. *hwiner*, to whine, and to *whinny*, as a horse; Sw. *hwina*, to squeal or squeak; W. *gwyn*, to complain; L. *hinio*, and qu. *gannio*.] To express murmurs by a plaintive drawing cry; to moan with a puerile noise; to murmur meanly.

They came ... with a *whining* accent craving liberty. *Sydney*.

Then, if we *whine*, look pale.... *Shak*.

**WHINE**, *n.* A drawing plaintive tone; the nasal puerile tone of mean complaint; mean or affected complaint.

**WHINER**, *n.* One who whines.

**WHINING**, *ppr.* Expressing murmurs by a mean plaintive tone or cant.

**WHININGLY**, *adv.* In a whining manner.

**WHIN'NY**, *a.* Abounding in whin; resembling whin.—2. Abounding in whins, or whin-bushes.

**WHIN'NY**, *v. t.* [*L. hinnio*; to stir the root of *whine*.] To utter the sound of a horse; to neigh.

**WHIN'-STONE**, *n.* [*whin* and *stone*; *Scot. gwhyn-stane*.] Whin-stone or whin is a provincial name given to basaltic rocks, and applied by miners to any kind of dark coloured and hard unstratified rock which resists the point of the pick. Veins of dark basalt, or green-stone, are frequently called *whin-dykes*.

**WHIN'-YARD**, *n.* A sword; in contempt.

**WHIP**, *v. t.* [*Sax. hweopan*, to whip, and to *weep*, that is, to *whoop* or *hoop*; *D. wippen*, to shake, to move or wag, to give the strapado; *zwoepen*, to whip; *Dan. vipper*, to swing; *W. wipwiva*, to move briskly, to *whip*; *whip*, a quick flirt or turn. The sense is well expressed by the Welsh, and we say, a man *whips* round a corner, when running he suddenly turns. It seems to be allied to *wipe* and *sweep*, and *L. vapulo*, and implies a sweeping throw or thrust.] 1. To strike with a lash or sweeping cord, or with anything tough and flexible; as, to *whip* a horse.—2. To sew slightly.—3. To drive with lashes; as, to *whip* a top.—4. To punish with the whip; to correct with lashes; as, to *whip* a vagrant; to *whip* one thirty-nine lashes; to *whip* a perverse boy.

Who, for false quantities, was *whipp'd* at school. *Dryden*.

5. To lash with sarcasm.

They would *whip* me with their fine wits. *Shak.*

6. To strike; to thrash; to beat out, as grain, by striking; as, to *whip* wheat.—7. Among *seamen*, to hoist by a whip; to secure the end of a rope from fagging by means of a seizing of twine. [*See the noun*.]—To *whip about* or *round*, to wrap; to inwrap; as, to *whip* a line round a rod.—To *whip in*, to compel to obedience or order. [*See WHIPPER IN*.]—To *whip out*, to draw nimbly; to snatch; as, to *whip out* a sword or rapier from its sheath.—To *whip from*, to take away suddenly.—To *whip into*, to thrust in with a quick motion. He *whipped* his hand into his pocket.—To *whip up*, to seize or take up with a quick motion. She *whipped up* the child, and ran off.

**WHIP**, *v. i.* To move nimbly; to start suddenly and run; or to turn and run; as, the boy *whipped* away in an instant; he *whipped* round the corner; he *whipped* into the house, and was out of sight in a moment. [*Ludicrous*.]

**WHIP**, *n.* [*Sax. hweop*.] 1. An instrument for driving horses, cattle, &c., or for correction, consisting of a lash tied to a handle or rod.—2. A coachman or driver of a carriage; as, a good *whip*.—3. In *mar. lan.*, a rope passed through a single block or pulley, used to hoist light bodies.—*Whip upon whip*, a double whip, one whip applied to the fall of another.—*Whips*, the four radii or arms of a wind-mill, to which the sails are attached.—*Whip and spur*, with the utmost haste.

**WHIP'-CORD**, *n.* [*whip* and *cord*.] Cord of which lashes are made.

**WHIP'-GRAFT**, *v. t.* [*whip* and *graft*.] To graft by cutting the scion and stock

in a sloping direction, so as to fit each other, and by inserting a tongue on the scion into a slit in the stock.

**WHIP'-GRAFTING**, *n.* The act or practice of grafting by cutting the scion and stock with a slope, to fit each other, &c.

**WHIP'-HAND**, *n.* [*whip* and *hand*] The hand that holds the whip in riding or driving.—2. Advantage over; as, he has the *whip-hand* of her.

**WHIP'-LASH**, *n.* [*whip* and *lash*.] The lash or small end of a whip.

**WHIP'-MAKER**, *n.* One who makes whips.

**WHIP'PED**, *pp.* Struck with a whip; punished; inwrapped; sewed slightly.

**WHIP'PER**, *n.* One who whips; particularly, an officer who inflicts the penalty of legal whipping.

**WHIP'PER-IN**, *n.* Among *huntsmen*, one who keeps the hounds from wandering, and *whips* them in, if necessary, to the line of chase. Hence,—2. In *parliament*, one who enforces party discipline among the supporters of the ministry, and urges their attendance on all questions of importance to the government.—3. In *general*, one who compels to obedience or order; one who subjects to the principles or measures of a party.

**WHIP'PER-SNAPPER**, *n.* A diminutive, insignificant person; a whipster.

**WHIP'PING**, *ppr.* Striking with a whip; punishing with a whip; inwrapping.

**WHIP'PING**, *n.* The act of striking with a whip, or of punishing; the state of being whipped; flagellation.

**WHIP'PING-POST**, *n.* [*whipping* and *post*.] A post to which offenders are tied when whipped.

**WHIP'PLE-TREE**, *n.* [*whip* and *tree*.] The bar to which the traces or tugs of a harness are fastened, and by which a carriage, a plough, a harrow, or other implement is drawn. It is also written *Whifle-tree*.

**WHIP'PO-WIL**, } *n.* The popular  
**WHIP-POOR-WILL**, } name of an  
American bird, the *Caprimulgus vociferus*, allied to the night-hawk or



Whip-poor-will (*Caprimulgus vociferus*).

night-jar, so called from its note, or the sounds of its voice. It appears in Georgia, Louisiana, and Virginia about the middle of March or early in April, and retires about the middle of August. It flies low, and skimming a few feet above the surface of the ground, it settles on logs and fences, from which it pursues the flying moths and insects. Its note is heard in the evening, or early in the morning, and when two or more males meet, their *whip-poor-*

*will* alterations become rapid and incessant, as if each were straining to overpower or silence the other. During the day these birds retire into the darkest woods, where they repose in silence. Like the owls, their sight seems to be deficient during the day.

**WHIP'-SAW**, *n.* [*whip* and *saw*.] A saw usually set in a frame for dividing or splitting wood in the direction of the fibres. It is wrought by two persons.

**WHIP'-SNAKE**, *n.* A species of venomous serpent, a native of the East, so named from its resemblance to a whip cord.

**WHIP'-STAFF**, *n.* [*whip* and *staff*.] In *ships*, a bar by which the rudder is turned. In small vessels this is called the *tiller*.

**WHIP'STER**, *n.* A nimble fellow.

**WHIP'-STICK**, *n.* The handle of a whip.

**WHIP'-STITCH**, *v. t.* [*whip* and *stitch*.] In *agriculture*, to half-plough or to rafter land. [*Local*.]

**WHIP'-STITCH**, *n.* A tailor; in contempt.—2. A sort of half-ploughing in *agriculture*, otherwise called raftering. [*Local*.]

**WHIP'STOCK**, *n.* [*whip* and *stock*.] The rod or staff to which the lash of a whip is fastened.

**WHIPT**, *pp.* of *Whip*; sometimes used for *Whipped*.

**WHIR**, *v. i.* (*hwur*.) To whirl round with noise; to whiz; to hurry away; to fly off with such a noise as a partridge or moor-cock makes when it springs from the ground.

**WHIRL**, *v. t.* To hurry.

**WHIRL**, *v. t.* (*hwurl*.) [*Sax. hwyrfan*; *G. wirbeln*, to whirl, *Dan. hvirvelben*, whirl-bone, vertebra; *hvirvelsoe*, whirl-sea, a whirlpool; *Sw. hvirvel*, Ice. *whirla*, a whirl. We see that *whirl* and *warble* are dialectical forms of the same word, and both probably from the root of *L. verto* and *Eng. veer*.] To turn round rapidly; to turn with velocity.

He *whirls* his sword around without delay. *Dryden*.

**WHIRL**, *v. i.* To be turned round rapidly; to move round with velocity; as, the *whirling* spindles of a cotton machine or wheels of a coach.

The wooden engine flies and *whirls* about. *Dryden*.

2. To move hastily.

But *whirl'd* away to shun his hateful sight. *Dryden*.

**WHIRL**, *n.* [*G. wirbel*; *Dan. hvirvel*.]

1. A turning with rapidity or velocity; rapid rotation or circumvolution; quick gyration; as, the *whirl* of a top; the *whirl* of a wheel; the *whirl* of time; the *whirls* of fancy.—2. Any thing that moves or is turned with velocity, particularly on an axis or pivot.—3. A hook used in twisting.—4. In *botany* and *conchology*,—see **WHORL**.

**WHIRL'-BAT**, *n.* [*whirl* and *bat*.] Any thing moved with a whirl as preparatory for a blow, or to augment the force of it. Poets use it for the ancient *cestus*. The *whirl bat* and the rapid race shall be Reserved for Cesar. *Dryden*.

**WHIRL'-BLAST**, *n.* [*whirl* and *blast*.] A whirling blast of wind.

**WHIRL'-BONE**, *n.* [*whirl* and *bone*.] The patella; the cap of the knee; the knee-pan.

**WHIRL'ED**, *pp.* Turned round with velocity.

**WHIRL'ER**, *n.* He or that which whirls.  
**WHIRL'ICOTE**, *n.* An ancient open car or chariot.  
**WHIRL'IGIG**, *n.* [*whirl* and *gig*.] A toy which children spin or whirl round.—2. In *military antiquities*, an instrument for punishing petty offenders, as sutlers, brawling women, &c.; a kind of wooden cage turning on a pivot, in which the offender was whirled round with great velocity.  
**WHIRLING**, *ppr.* Turning or moving round with velocity.  
**WHIRLING-TABLE**, } *n.* A MA-  
**WHIRLING-MACHINE**, } chine contrived for the purpose of exhibiting the principal effects of centripetal or centrifugal forces, when bodies revolve in the circumferences of circles, or on an axis. The same name is given to a machine invented by Mr. Robins, for the purpose of determining the resistance of the air against bodies moving with velocities less than those for which the resistance can be determined by the ballistic pendulum. Dr. Hutton made a series of experiments with a machine of this kind, with the view of ascertaining the resistance experienced by military projectiles in passing through the air.  
**WHIRL-PIT**, † *n.* A whirlpool.  
**WHIRLPOOL**, *n.* [*whirl* and *pool*.] An eddy of water; a vortex or gulf where the water moves round in a circle, in consequence of obstructions from banks, rocks, or islands; or the opposition of winds and currents. Whirlpools in rivers are very common, and are of little consequence. In the sea they are more rare, but often dangerous to navigation. The most celebrated whirlpools are the Euripus, near the coast of Negropont; the Charybdis, in the strait between Sicily and Italy; and the Maelstrom, off the coast of Norway.  
**WHIRL'WIND**, *n.* [*whirl* and *wind*.] A violent wind moving in a circle, or rather in a spiral form, as if moving round an axis; this axis having at the same time a progressive motion rectilinear or curvilinear, on the surface of the land or sea. Whirlwinds are produced chiefly by the meeting of currents of air which run in different directions. When they occur on land they give a whirling motion to dust, sand, part of a cloud, and sometimes even to bodies of great weight and bulk, carrying them either upwards or downwards, and scattering them about in all directions. At sea they often give rise to waterspouts. They are most frequent and violent in tropical countries.  
**WHIR'RING**; *n.* The sound of partridge's or pheasant's wings.  
**WHISK**, *n.* [G. and D. *wisch*, a wisp.] 1. A small bunch of grass, straw, hair, or the like, used for a brush; hence, a brush or small besom.—2. A bundle of peeled twigs used by cooks, for rapidly agitating or whisking certain articles, as cream, eggs, &c.—3. Part of a woman's dress; a kind of tippet.—4. A quick violent motion, a sudden gale.  
**WHISK**, *v. t.* To sweep, brush, or agitate with a light rapid motion.—2. To sweep along; to move nimbly over the ground.  
**WHISK**, *v. i.* To move nimbly and with velocity.  
**WHISK'ER**, *n.* [from *whisk*.] Long hair growing on the human cheek.—2. The

bristly hairs on the upper lip of a cat, &c. [*Used chiefly in the plural*.]  
**WHISK'ERED**, *a.* Formed into whiskers; furnished with whiskers; wearing whiskers.  
**WHISK'ET**, *n.* A basket. [*Local*.]  
**WHISK'ING**, *ppr.* Brushing; sweeping along; moving with velocity along the surface; agitating rapidly with a whisk; as cream.  
**WHISK'Y**, *n.* [Ir. *uisge*, water, whence *usquebaugh*; W. *wysg*, a stream.] An ardent spirit distilled generally from barley, but sometimes from wheat, rye, sugar, molasses, &c. It may be considered the national spirit of Scotland and Ireland.  
**WHISK'Y**, } [*Probably from whisk*.]  
**WHISK'Y**, } A kind of one horse chaise, sometimes called a *tim-whiskey*.  
**WHIS'PER**, *v. i.* [Sax. *hwisprian*; Sw. *hwiska*, to buzz, to whisper; G. *flispfern*; allied to *whistle*, *wheeze*, and L. *flistula*. The word seems by its sound to be an onomatopy, as it expresses a sibilant sound or breathing.] 1. To speak with a low hissing or sibilant voice. It is ill manners to *whisper* in company.  
The hollow *whisp'ring* breeze. Thomson.  
2. To speak with suspicion or timorous caution.—3. To plot secretly; to devise mischief.  
All that hate me *whisper* together against me; Ps. xli.  
**WHIS'PER**, *v. t.* To address in a low voice. He *whispers* the man in the ear. [But this is elliptical for *whispers to*.]  
—2. To utter in a low sibilant voice. He *whispered* a word in my ear.—3. To prompt secretly; as, he came to *whisper* Wolsey.  
**WHIS'PER**, *n.* A low soft sibilant voice; or words uttered with such a voice.  
The *whisper* cannot give a tone. Bacon.  
Soft *whispers* through th' assembly went. Dryden.  
2. A cautious or timorous speech.—3. A hissing or buzzing sound.  
**WHIS'PERED**, *pp.* Uttered in a low voice; uttered with suspicion or caution.  
**WHIS'PERER**, *n.* One who whispers.—2. A tattler; one who tells secrets; a conveyer of intelligence secretly.—3. A backbiter; one who slanders secretly; Prov. xvi.  
**WHIS'PERING**, *ppr.* or *a.* Speaking in a low voice; telling secretly; backbiting.—*Whispering gallery* or *dome*, a gallery or dome, in which the sound of words uttered in a low voice or whisper, is communicated to a greater distance than under any ordinary circumstances. Thus in an elliptical chamber, if a person standing in one of the foci, speak in a whisper, he will be heard distinctly by a person standing in the other focus, although the same sound would not be audible at the same distance, under any other circumstances, or at any other place in the chamber. The reason is that the sounds produced in one of the foci of such a chamber, strike upon the wall all round, and, from the nature of the ellipse, are all reflected to the other focus. This serves in some measure to explain the effects of whispering galleries and domes in general. There is a whispering gallery in St. Paul's cathedral, London, and one in Gloucester cathedral.  
**WHIS'PERING**, *n.* The act of speaking with a low voice; the telling of

tales, and exciting of suspicions; a backbiting.  
**WHIS'PERINGLY**, *adv.* In a low voice.  
**WHIST**, *a.* [Corn. *huist*, silence.] Silent; mute; still; not speaking; not making a noise.  
The winds with wonder *whist*,  
Smoothly the waters kiss'd. Milton.  
[This adjective, like some others, always follows its noun. We never say, *whist* wind; but the wind is *whist*.]  
**WHIST**, † *v. t.* To silence; to still.—*Whist* is used interjectionally for *be silent*. *Whist, whist*, that is, *be silent or still*.  
**WHIST**, † *v. i.* To become silent.  
**WHIST**, *n.* A well known game at cards, so called because it requires silence or close attention.  
**WHIS'TLE**, *v. i.* (*hwis'tl*.) [Sax. *hwistlan*; Dan. *hvidslær*; L. *flistula*, a whistle; allied to *whisper*.] 1. To utter a kind of musical sound, by pressing the breath through a small orifice formed by contracting the lips. While the ploughman near at hand,  
*Whistles* o'er the furrow'd land. Milton.  
2. To make a sound with a small wind instrument.—3. To sound shrill, or like a pipe.  
The wild winds *whistle* and the billows roar. Pope.  
**WHIS'TLE**, *v. t.* To form, utter, or modulate by whistling; as, to *whistle* a tune or air.—2. To call by a whistle; as, he *whistled* back his dog.  
**WHIS'TLE**, *n.* [Sax. *hwistle*; L. *flistula*.] 1. A small wind instrument.—2. The sound made by a small wind instrument.—3. Sound made by pressing the breath through a small orifice of the lips.—4. The mouth; the organ of whistling. [*Vulgar*.]—5. A small pipe, used by a boatswain to summon the sailors to their duty; the boatswain's call.—6. The shrill sound of winds passing among trees or through crevices, &c.—7. A call, such as sportsmen use to their dogs.  
**WHIS'TLED**, *pp.* Sounded with a pipe; uttered in a whistle.  
**WHIS'TLE-FISH**, *n.* A name given to the Sea Loach, or Three-bearded Rockling, *Motella vulgaris*, Cuv., a fish of the cod tribe, found in the British seas.  
**WHIS'TLER**, *n.* One who whistles.  
**WHIS'TLING**, *ppr.* Uttering a musical sound through a small orifice of the lips; sounding with a pipe; making a shrill sound, as wind.  
**WHIS'TLY**, † *adv.* Silently.  
**WHIT**, *n.* [Sax. *whit*, a creature, also a thing, something, any thing. This is probably from the root of L. *vivo*, *victum*.] A point; a jot; the smallest part or particle imaginable. It is used without a preposition. He is not a *whit* the wiser for experience.  
It does not me a *whit* displease. Cowley.  
The regular construction would be *by a whit*, or *in a whit*. In these phrases, a *whit* may be interpreted by *in the least*, in the *smallest degree*.  
**WHITE**, *a.* [Sax. *hwit*; Sw. *hvit*; D. *wit*; G. *weiss*.] 1. Being without colour; or, in a popular sense, being of the colour of pure snow; or of light; snowy; not dark; as, *white* paper; a *whiteskin*.—2. Pale; destitute of colour in the cheeks, or of the tinge of blood colour; as, *white* with fear.—3. Having the colour of purity; pure; clean; free from spot; as, *white* robed innocence.—4. Gray; as, *white* hair;



a venerable man, *white* with age.—5. Pure; unblemished.

No *whiter* page than Addison's remains.

6. In a *scriptural sense*, purified from sin; sanctified; Ps. li.

**WHITE**, *n.* One of the natural colours of bodies, whose opposite is black, but not strictly a colour, for it is produced by the combination of all the prismatic colours, mixed in the same proportions as they exist in the solar rays; destitution of all stain or obscurity on the surface; whiteness; the colour of snow. We say, bleached cloth is of a good *white*; attired in a robe of *white*.

—2. Any thing white; a white man; a white spot; the mark at which an arrow is shot.—*White of the eye*, that part of the ball of the eye surrounding the iris or coloured part. It owes its whiteness to the *tunica albuginea* or *adnata*, a partial covering of the fore part of the eye, formed by the expansion of the tendons of the muscles which move the eye-ball.—*White of an egg*, the albumen, or pellucid viscous fluid, which surrounds the vitellus or yolk. An analogous part, in the seeds of plants, is called the *albumen* or *white*. It is a farinaceous, fleshy, or horny substance, which makes up the chief bulk of some seeds, as in grasses, corn, palms, and lilies, never rising out of the ground nor performing the office of leaves, but destined solely to nourish the germinating embryo, till its roots can perform their office. It is the *perispermum* of Jussieu.—*Spanish white*, a substance used in painting, prepared from chalk, by separating from the latter its silicious impurities.—*Flake white*, oxide of bismuth.

**WHITE**, *v. t.* To make white; to whiten; to whitewash; as, *whitened* sepulchres; Mark ix.; Matt. xxiii.

**WHITE-ANTS**, *n.* The name given to neuropterous insects of the family Termitidae. [See ANT, TERMES.]

**WHITE-ARSENIC**, *n.* Arsenious acid.

**WHITE-ASH**, *n.* An American tree, the *Fraxinus Americana*.

**WHITE-BAIT**, *n.* [*white* and *bait*.] A very small delicate fish, of the genus *Clupea*, the *C. alba*. It abounds in



White-Bait (*Clupea alba*).

the Thames during spring and summer, and its flesh is much prized. It was long regarded as the young of the shad.

**WHITE-BAY**, *n.* A tree of the genus *Magnolia*, the *M. glauca*. It grows in wet ground in the eastern and some of the middle states of America. The bark and seed-cones are used as tonics.

**WHITE-BEAM**, } *n.* A tree of  
**WHITE-BEAM-TREE**, } the genus  
Pyrus, the *P. aria*. It inhabits the rocks of the west and north of England, where it forms an ornamental tree. [See PYRUS.]

**WHITE-BEAR**, *n.* [*white* and *bear*.] The bear that inhabits the polar regions. A large, fierce quadruped of a white colour. [See BEAR.]

**WHITE-BEECH**, *n.* An American tree, the *Fagus Americana*.

**WHITE-BONNET**, *n.* In *Scots law*, a person, also called a *puffer*, who attends

sales by auction, in order to raise the price of the articles exposed, by making offers; so as to lead on other offerers, while he at the same time holds an obligation, either express or implied, from the exposer of the goods, &c., that he shall be relieved of the consequences of his offer, in case the subject should fall into his hands.

**WHITE-BOTTLE**, *n.* A British plant of the genus *Silene*, the *S. inflata*, also called bladder campion. [See *SILENE*.]

**WHITE-BOY**, *n.* A name given in Ireland to certain levellers, or insurgents, who began to disturb the peace by night, in 1762. Their ordinary dress was a white frock; hence the name.

**WHITE-BOYISM**, *n.* The principles or practice of the white-boys.

**WHITE-BRANT**, *n.* [*white* and *brant*.] A species of the duck kind, the *Anas hyperborea*.

**WHITE-BUG**, *n.* [*white* and *bug*.] An insect of the bug kind, which injures vines and some other species of fruit.

**WHITE-CAMPION**, *n.* [*white* and *campion*.] A plant of the genus *Silene*, the *S. stellata*.

**WHITE-CAP**, *n.* The tree sparrow or mountain sparrow, *Pyrgita montana*.

**WHITE-EAR**, *n.* The fallow-finch.

**WHITE-CATERPILLAR**, *n.* An insect of a small size, called sometimes the borer, that injures the gooseberry bush.

**WHITE-CEDAR**, *n.* An American tree of the genus *Abies*, the *A. alba*.

**WHITE-CENTAURY**, *n.* An annual weed in woods and other places, the *Centaurea alba*. It is said to form the basis of the famous Portland powder for the gout.

**WHITE-CLOVER**, *n.* A small species of perennial clover, the *Trifolium repens*, bearing white flowers. It furnishes excellent food for cattle and horses, as well as for the honey bee. [See TRIFOLIUM.]

**WHITE-COPPER**, *n.* An alloy of copper, nickel, and zinc, sometimes with a little iron. It is used by the Chinese, and called by them *Pachfong*.

**WHITE-CROP**, *n.* White crops, in agriculture, are such as lose their green colour or become white in ripening, as wheat, rye, barley, and oats.

**WHITENED**, *pp.* Made white; whitened.

**WHITE-DARNEL**, *n.* The *Lolium arvense*, a prolific and troublesome weed, growing among corn. [See LOLIUM.]

**WHITE-EAR**, } *n.* A bird, the fallow-

**WHITE-TAIL**, } finch, or wheat-ear.

**WHITE-FACE**, } *n.* A white mark

**WHITE-BLAZE**, } in the forehead of a horse, descending almost to the nose.

**WHITE-FACED**, *a.* Having a white or pale face.

**WHITE-FILM**, *n.* A white film growing over the eyes of sheep and causing blindness.

**WHITE-FISH**, *n.* In *familiar lan.*, a general name for whittings and had-docks.—2. A small American fish, the *Clupea menhaden*, caught in immense quantities, and used for manuring land on the southern border of Connecticut, along the sound.—3. A fish of the salmon family, belonging to the genus *Coregonus*, (*Salmo albus*, Linn.) found in the lakes of North America.

**WHITE-FOOT**, *n.* A white mark on the foot of a horse, between the fetlock and the coffin.

**WHITE-FRIARS**, *n.* A common name

of several orders of friars from being clothed in a white habit. [See FRIAR.]

**WHITE-HEAT**, *n.* That degree of heat given to iron which makes it appear white.

**WHITE-HELLEBORE**, *n.* A plant of the genus *Veratrum*, the *V. album*. [See VERATRUM.]

**WHITE-HOREHOUND**, *n.* A plant of the genus *Marrubium*, the *M. vulgare*. [See HOREHOUND.]

**WHITE-LAND**, *n.* A name given to a tough clayey soil, of a whitish hue when dry, but blackish after rain.

**WHITE-LEAD**, *n.* A carbonate of lead, much used in painting. It is prepared by exposing sheets of lead to the fumes of an acid, usually vinegar, and suspending them in the air until the surface becomes incrustated with a white coat, which is the substance in question.

**WHITE-LEG**, *n.* *Phegmasia dolens*, a disease which mostly occurs to women soon after delivery.

**WHITE-LEGGED**, *a.* Having white legs.

**WHITE-LIGHT**, *n.* In *physics*, the name generally given to the light which comes directly from the sun, and which has not been decomposed by refraction in passing through a transparent prism. *White lights* are sometimes produced artificially, and used as signals, &c.

**WHITE-LILY**, *n.* A well known garden plant, the *Lilium candidum*.

**WHITE-LIMED**, *a.* Whitewashed, or plastered with lime.

**WHITE-LINE**, *n.* Among *printers*, a void space, broader than usual, left between lines. In *Scotch printing houses*, it is called a *blank-line*.

**WHITE-LIVERED**, *a.* [*white* and *liver*.] Having a pale look; feeble; cowardly.—2. Envious; malicious.

**WHITELY**, *adv.* Coming near to white.

**WHITE-MAN'GANESE**, *n.* An ore of manganese, carbonate of manganese.

**WHITE-MEAT**, *n.* [*white* and *meat*.] Meats made of milk, butter, cheese, eggs, and the like.—2. The flesh of a fowl, rabbit, &c.

**WHITE-MONEY**, *n.* Silver coin.

**WHITEN**, *v. t.* (hw'it'n.) To make white; to bleach; to blanch; as, to *whiten* cloth.

**WHITEN**, *v. i.* To grow white; to turn or become white. The hair *whitens* with age; the sea *whitens* with foam; the trees in spring *whiten* with blossoms.

**WHITENED**, *pp.* Made white; bleached.

**WHITENER**, *n.* One who bleaches or makes white.

**WHITENESS**, *n.* The state of being white; white colour, or freedom from any darkness or obscurity on the surface.—2. Paleness; want of a sanguineous tinge in the face.—3. Purity; cleanness; freedom from stain or blemish.

**WHITENING**, *ppr.* or *a.* Becoming or making white.

**WHITENING**, *n.* Whiting, — *whick see*.

**WHITE-NUN**, *n.* The smew, a bird of the genus *Mergus*. [See SMEW.]

**WHITE-OAK**, *n.* A species of oak, the *Quercus alba*, a native of the United States of America, and of parts of Canada.

**WHITE-PINE**, *n.* The *Pinus strobus*, one of the most valuable and interesting species of pines, common to Canada and the northern parts of the United

States. It is much used in domestic architecture. [See PINE.]

**WHITE-POP'LAR**, *n.* A tree of the poplar kind, sometimes called the abele tree; *Populus alba*.

**WHITE-POP'PY**, *n.* A species of poppy, sometimes cultivated for the opium which is obtained from its juice by evaporation; *Papaver somniferum*.

**WHITE-POT**, *n.* [*white* and *pot*.] A kind of food made of milk, cream, eggs, sugar, &c., baked in a pot.

**WHITE-PRECIPITATE**, *n.* Chloramide of mercury, a compound obtained by adding caustic ammonia to a solution of corrosive sublimate. It is a white insoluble powder, much used in medicine as an external application. It is sometimes called *white calyx of mercury*.

**WHITE-PUDDING**, *n.* A pudding made of milk, eggs, flour, and butter.—2. A pudding made in Scotland of oatmeal mixed with suet, and seasoned with pepper and salt.

**WHITE-PYRITES**, *n.* [*white* and *pyrites*; Fr. *sulfure blanc*.] An ore of a tin-white colour, passing into a brass-yellow and steel-grey, occurring in octahedral crystals, sometimes stalactical and botryoidal. It is a sulphuret of iron, containing 46 parts of iron, and 54 of sulphur.

**WHITER**, *a. comp.* More white.

**WHITE-RENT**, *n.* [*white* and *rent*.] In *Devon* and *Cornwall*, a rent or duty of eightpence, payable yearly by every tinner to the duke of Cornwall, as lord of the soil.—2. A kind of rent paid in silver or white money.

**WHITE-ROT**, *n.* A British plant of the genus *Hydrocotyle*, the *H. vulgaris*, called also marsh penny. [See HYDRO-COTYLE.]

**WHITES**, *n.* The fluor albus, a disease of females.

**WHITE-SALT**, *n.* Salt dried and calcined; decrepitated salt.

**WHITE-SHARK**, *n.* A species of shark, the *Squalus carcharias*. In size and voracity it is the most formidable of all the sharks, and is most abundant in the warmer latitudes. [See SHARK.]

**WHIT'EST**, *a. superl.* Most white.

**WHITESTER**, *n.* A bleacher; a *whit-ster*. [Local.]

**WHITESTONE**, *n.* In *geol.*, the *weiss stein* of Werner, and the *eurite* of some geologists; a species of rocks composed essentially of feldspar, but containing mica and other minerals.

**WHITE-SWELLING**, *n.* [*white* and *swelling*.] A term applied to a disease of the joints, on account of the unaltered colour of the skin. The term includes almost all those diseases of the joints which are the result of chronic inflammation in the bones, cartilages, or membranes constituting the joint. Such inflammations are constantly attended with swelling, which is circumscribed; the part is sometimes hard, and sometimes yields to pressure. Sometimes white swellings are attended with no pain; at other times the pain is acute and constant. They have been divided into *rheumatic* and *scrofulous*. The knee, ankle, wrist, and elbow, are the joints most subject to white swellings.

**WHITE-TAIL**, *n.* A bird, the wheat-ear. [See WHEAT-EAR.]

**WHITE-THORN**, *n.* A British plant, of the genus *Mespilus*, the *M. oxyacantha*; called also hawthorn. [See MESPILUS.]

**WHITE-THROAT**, *n.* A small singing bird, belonging to the family of warblers, the *Sylvia cinerea* (*Motacilla sylvia*, Linn.). It frequents gardens and hedges, and is a regular summer visitor to the British Islands, arriving about the middle of April, and departing in autumn. Some of its notes are harsh, others are pleasing; but it is said to sing very melodiously in captivity. The lesser white-throat is the *Sylvia curruca*. It also is a summer visitor to our islands.

**WHITE-VITRIOL**, *n.* The old name for sulphate of zinc, employed in medicine as an emetic and tonic. [See ZINC.]

**WHITE-WASH**, *n.* [*white* and *wash*.] A wash or liquid composition for whitening something; a wash for making the skin fair.—2. A composition of lime and water, or of whiting, size, and water, used for whitening the plaster of walls, ceilings, &c.

**WHITE-WASH**, *v. t.* To cover with a white liquid composition, as with lime and water, &c.—2. To make white; to give a fair external appearance.—3. To clear an insolvent or bankrupt of the debts he owes, by a judicial process. [Familiar.]

**WHITEWASHED**, *pp.* Covered or overspread with a white liquid composition.—2. Freed judicially from lawful debts.

**WHITEWASHER**, *n.* One who whitewashes the walls or ceilings of apartments.

**WHITEWASHING**, *ppr.* Overspreading or washing with a white liquid composition.—2. Freeing an insolvent, &c., from debts.

**WHITE-WATER**, *n.* A disease of sheep of a dangerous kind.

**WHITE-WATER LILY**, *n.* A British plant, of the genus *Nymphaea*, the *N. alba*. [See NYMPHÆA.]

**WHITE-WAX**, *n.* Bleached wax.

**WHITE-WILLOW**, *n.* A British tree of the genus *Salix*, the *S. alba*. [See SALEX.]

**WHITE-WINE**, *n.* Any wine of a clear transparent colour, bordering on white, as Madeira, Sherry, Lisbon, &c.; opposed to wine of a deep red colour, as Port and Burgundy.

**WHITE-WOOD**, *n.* A species of timber tree growing in North America, the *Liriodendron* or tulip tree.—2. A plant of the genus *Bignonia*, the *B. leucorylon* of Jamaica, the juice and tender shoots of which are supposed to be an antidote against the poisonous juice of the manchineel.

**WHITEFIELDIAN**, *a.* Relating to George Whitefield, the founder of the Calvinistic Methodists.

**WHIT'ER**, *adv.* [Sax. *hwyder*.] 1. To what place; interrogatively. *Whit'er* goest thou?

*Whit'er* away so fast? *Shak.*

2. To what place, absolutely. *I stray'd, I knew not whit'er.* *Milton.*

3. To which place, relatively. *Whit'er* when as they came, they fell at words. *Spenser.*

4. To what point or degree.—5. *Whit'ersoever*.

**WHIT'ERSOEVER**, *adv.* [*whit'er* and *soever*.] To whatever place. *I will go whit'ersoever* you lead.

**WHIT'ERWARD**, *adv.* Towards which place.

**WHITING**, *n.* [from *white*.] A well-known fish belonging to the Gadidae or cod tribe. It is the *Merlangus vulgaris*, Cuv., and the *Gadus merlangus*,

Linn. It abounds on all the British coasts, and comes in large shoals towards the shore in January and February. It exceeds all the other fishes of its tribe in its delicacy and lightness as an article of food, and hence it is much prized. It is readily



Whiting (*Merlangus vulgaris*).

distinguished from the cod, haddock, and bib, by the absence of the barbule on the chin, the under jaw is shorter than the upper, there is a black spot at the base of the first ray of the pectorals, and the tail is even at the end. It does not usually exceed a pound and a half in weight.—2. Chalk cleared of all stony matter, pulverized, levigated, and made up into small cakes. It is often used as a polishing material.

**WHITISH**, *a.* [from *white*.] Somewhat white; white in a moderate degree.

**WHITISHNESS**, *n.* [supra.] The quality of being somewhat white.

**WHIT'LEATHER**, *n.* [*white* and *leather*.] Leather dressed with alum, remarkable for its toughness. In common use, the ligaments of animals, when in food.

**WHITLOW**, *n.* [Sax. *hwit*, white, and *low*, a flame. Qu.] 1. In *sur.*, paronychia, a swelling or inflammation about the nails or ends of the fingers, or affecting one or more of the phalanges of the fingers, generally terminating in an abscess. There are four or five varieties of this swelling. 1. The *cutaneous paronychia*, which raises the cuticle, forming a kind of vesicle filled with a limpid serum, or bloody fluid. 2. The *subcutaneous paronychia*, a tumour attended with acute pain. It is seated in the cellular membrane under the skin. 3. The *subungual paronychia*, which occurs under the nail. It commences with inflammatory symptoms, but it is less painful than the former. 4. There is also the *paronychia of the periosteum*, and the *paronychia of the tendons or theca*.—2. In *sheep*, the whitlow is a disease of the feet, of an inflammatory kind. It occurs round the hoof, where an acrid matter is collected, which ought to be discharged.

**WHITLOW-GRASS**, *n.* The common name of several British plants of the genus *Draba*. [See DRABA.]

**WHIT'MON'DAY**, } *n.* The Mon-  
**WHIT'SUN-MON'DAY**, } day follow-  
ing Whitsunday. In *England*, &c., it is observed by most persons as a holiday.

**WHIT'RET**, *n.* [*white rat*?] The Scotch name for the weasel.

**WHIT'SOUR**, *n.* A sort of apple.

**WHIT'STER**, † *n.* A whitener; a bleacher.

**WHIT'SUL**, *n.* White meat, a provincial name of milk, sour milk, cheese, curds, and butter.

**WHIT'SUN**, *a.* Observed at Whitsunday.

**WHIT'SUNDAY**, } *n.* [*white*, *Sunday*,  
**WHIT'SUNTIDE**, } and *tide*.] The

seventh Sunday after Easter; a festival of the church in commemoration of the descent of the Holy Spirit on the day of Pentecost; so called, it is said, because in the primitive church, those who had been newly baptized appeared at church between Easter and Pentecost in white garments. In *Scotland*, *Whitsunday* is the name given to one of the legal terms for removing, both in burgh and rural tenements, and is fixed by statute to be held on the 15th May; but when that happens to be a Sunday, the following Monday is considered the term-day. Whitsunday is also one of the terms for the payment of rent, ministers' stipends, the hiring of servants, &c. [See TERM.]

**WHIT'TEN**, *n.* The small-leaved lime-tree, the *Tilia cordata*, or *parviflora*.  
**WHIT'TLE**, *n.* [Sax. *hwitel*, *hwitla*.] 1. A small pocket knife. [Local in England, but retained in the Scottish dialect.]—2. A white dress for a woman; a double blanket worn by west countrywomen in England, over the shoulders, like a cloak.

**WHIT'TLE**, *v. t.* To cut or dress with a knife. [Local in England, but retained in the Scottish dialect.]—2. † To edge; to sharpen.

**WHIT'TLED**, *pp.* Cut with a small knife. [Local.]

**WHIT'TLING**, *ppr.* Cutting with a small knife. [Local.]

**WHIT'Y-BROWN**, *a.* Of a colour between white and brown; as, *whity-brown paper*. [Local.]

**WHIZ**, *v. i.* [It seems to be allied to *hiss*.] To make a humming or hissing sound, like an arrow or ball flying through the air.

It flew, and *whizzing* cut the liquid way.  
*Dryden.*

**WHIZ**, *n.* A hissing sound.

**WHIZ'ZING**, *ppr.* Making a humming or hissing sound.

**WHIZ'ZLING**, *adv.* With a whizzing sound.

**WHO**, *pron. relative.* (ho.) [Sax. *hwa*; D. *wie*; L. *qui*; Fr. *que*; Ir. *cia*; Russ. *koj*; Pers. *ki*. *Who* is undoubtedly a contracted word in English as in Latin. See **WHAT** and **WHICH**.] 1. *Who* is a pronoun relative, always referring to persons. It forms *whose* in the genitive or possessive case, answering to the L. *cujus*, and *whom* in the objective or accusative case. *Who*, *whose*, and *whom*, are in both numbers. Thus we say, the man or woman *who* was with us; the men or women *who* were with us; the men or women *whom* we saw.—2. Which of many. Are you satisfied *who* did the mischief?—3. It is much used in asking questions; as, *Who am I? Who art thou? Who is this? Who are these?* In this case, the purpose is to obtain the name or designation of the person or character.—4. It has sometimes a disjunctive sense.

There thou tell'st of kings, and *who* aspire;  
*Who fall, who rise, who triumph, who do moan.*  
*Dryden.*

5. *Whose* is of all genders. *Whose* book is this?  
The question *whose* solution I require.

As *who* should say, elliptically for *as one who should say*.

**WHO** } exclam. Stop! stand still.

**WO** } Used by drivers of horses, carters, &c., to stop their horses. [See **WHO** is also sometimes used.]

**WHOEVER**, *pron.* [who and ever.] Any  
11.

one without exception; any person whatever. The person who trespasses shall be punished, *whoever* he may be.

**WHOLE**, *a.* (hole.) [In Sax. *walg*, *onwalg*, is whole, sound, entire. In D. *heel*, *geheel*, has a like sense, from the root of *heal*; G. *heil*; W. *oill* or *holl*; Gr. *ἰσος*, *ἰσως*: Ir. *uile*. This seems to be connected with *heal*, *hale*. Of this, the derivative *wholesome* is evidence.] 1. All; total; containing the total amount or number, or the entire thing; as, the *whole* earth; the *whole* world; the *whole* solar system; the *whole* army; the *whole* nation.—2. Complete; entire; not defective or imperfect; as, a *whole* orange; the egg is *whole*; the vessel is *whole*.—3. Unimpaired; unbroken; uninjured.

My life is yet *whole* in me; 2 Sam. i.

4. Sound; not hurt or sick.

They that are *whole* need not a physician; Matth. ix.

5. Restored to health and soundness; sound; well.

Thy faith hath made thee *whole*; Mark v.  
His hand was restored *whole*; Mark iii.

**WHOLE**, *n.* The entire thing; the entire or total assemblage of parts. The *whole* of religion is contained in the short precept, "Love God with all your heart, and your neighbour as yourself."

Fear God and keep his commandments, for this is the *whole* duty of man; Eccles. xii.

2. A system; a regular combination of parts.

**WHOLE-HOOFED**, *a.* Having an undivided hoof.

**WHOLE-LENGTH**, *a.* Extending from end to end.—2. Full length; as, a *whole-length* portrait.

**WHOLENESS**, *n.* Entireness; totality.

**WHOLESALE**, *n.* [*whole* and *sale*.] Sale of goods by the piece or large quantity; as distinguished from *retail*.

Some traders sell either by *wholesale* or *retail*.—2. The whole mass.

Some from vanity or envy, despise a valuable book, and throw contempt upon it by *wholesale*.  
*Watts.*

**WHOLESALE**, *a.* [supra.] Buying and selling by the piece or quantity; as, a *wholesale* merchant or dealer.—2. Pertaining to the trade by the piece or quantity; as, the *wholesale* price.

**WHOLE SOME**, *a.* [*whole* and *some*; G. *heilam*.] 1. Tending to promote health; favouring health; salubrious; as, *wholesome* air or diet; a *wholesome* climate.—2. Sound; contributing to the health of the mind; favourable to morals, religion, or prosperity; as, *wholesome* advice; *wholesome* doctrines; *wholesome* truths.—3. Useful; salutary; conducive to public happiness, virtue, or peace; as, a *wholesome* law.—4. That utters sound words.

A *wholesome* tongue is a tree of life;  
Prov. xv.

5. Kindly; pleasing; as, a *wholesome* answer.—*Wholesome ship*, a ship that will try, hull, and ride well.

**WHOLESOMELY**, *adv.* In a wholesome or salutary manner; salubriously.

**WHOLESOMENESS**, *n.* The quality of contributing to health; salubrity; as, the *wholesomeness* of air or diet.—2. Salutariness; conduciveness to the health of the mind or of the body politic; as, the *wholesomeness* of doctrines or laws.

**WHOLLY**, *adv.* Entirely; completely; perfectly.

Not *wholly* overcome, nor *wholly* yield.  
*Dryden.*

2. Totally; in all the parts or kinds.

They employed themselves *wholly* in domestic life.  
*Addison.*

**WHOM**, *pron.* (hoom.) The objective of *who*, coinciding with the L. *quem* and *quam*.

Whom have I in heaven but thee; Pa. lxxiii.

**WHOMSOEVER**, *pron.* [*whom* and *soever*.] Any person without exception.

With *whomsoever* thou findest thy goods, let him not live; Gen. xxxi.

**WHOO'BUB**, † for *Hubbub*.

**WHOOOP**, *n.* (hoop.) [This is the same as *hoop*, but aspirated; Goth. *wopyan*, to whoop, to call; Sax. *wheopan*, to weep, and to *whip*. The sense is to drive out the voice.] 1. A shout of pursuit.—2. A shout of war; a particular cry of troops when they rush to the attack. The Indians of America are remarkable for their war *whoop*.—3. The bird called *hoopoe* or *upupa*.

**WHOOOP**, *v. i.* To shout with a particular voice.

**WHOOOP**, *v. t.* To insult with shouts.

**WHOO'ING-COUGH**. See **HOORING-COON**.

**WHOOT**, *v. i.* (hoot.) See **HOOR**.

**WHOP**, *n.* A heavy blow; a sudden fall. [Vulgar and local.]

**WHOP**, *v. t.* To strike; to beat. [Vulgar and local.]

**WHOP'PER**, *n.* One who whops; any thing uncommonly large; applied particularly to a monstrous lie. [Vulgar and local.]

**WHORE**, *n.* (hore.) [W. *huran*, from *huriaw*, to hire; *hur*, that which is fixed or set, hire, wages; Sax. *hor-coren*, hore-woman; G. *hure*; D. *hoer*.] A harlot; a courtesan; a concubine; a prostitute; an adulteress; a strumpet.

**WHORE**, *v. i.* [supra.] To have unlawful sexual commerce; to practise lewdness.

**WHORE**, *v. t.* To corrupt by lewd intercourse. [Little used.]

**WHOREDOM**, *n.* (ho'redom.) Lewdness; fornication; practice of unlawful commerce with the other sex. It is applied to either sex, and to any kind of illicit commerce.—2. In *script.*, idolatry; the desertion of the worship of the true God, for the worship of idols.

**WHOREMASTER**, *n.* [supra.] One who practises lewdness.

**WHOREMASTERLY**, *a.* Having the character of a whoremaster; libidinous.

**WHOREMONGER**, *n.* The same as *Whoremaster*.

**WHORESÓN**, *n.* A bastard. [A word used generally in contempt.]

**WHORESÓN**, † *a.* Bastard-like; mean; scuffy.

**WHORISH**, *a.* Lewd; unchaste: addicted to unlawful sexual pleasures; incontinent.

**WHORISHLY**, *adv.* In a lewd manner.

**WHORISHNESS**, *n.* The practice of lewdness; the character of a lewd woman.

**WHORL**, *n.* [See **WHIRL**.] In *bot.*, a species of inflorescence, in which the flowers surround the stem in the form of a ring, as in *Hippuris vulgaris*. The series of leaves which constitute a flower are also termed whorls. Every complete flower is externally formed of two whorls of leaves, constituting the floral envelope or perianth; and internally of other two whorls of organs, constituting the organs of fructification.

tification. The term *whorl* is also applied to an arrangement of more leaves than two around a common centre, upon the same plane with each other.—2. In *conchology*, a volution or turn of the spire of a univalve.

WHORLED, *a.* Furnished with whorls; verticillate.

WHORT, *n.* The fruit of the whortleberry; or the shrub.

WHORTLEBERRY, *n.* [Sax. *heart-berg*, hart-berry. The Germans call it *heidel-beere*, heath-berry.] The common name of several species of plants of the genus *Vaccinium*; and also of the fruit. [See *VACCINIUM*.]

WHÓSE, *pron.* (hooz.) The possessive or genitive case of *who* or *which*; applied to persons or things. We say, the person *whose* merits are known; the garment *whose* colour is admired.

WHÓSEOEVER, *pron.* [*whose* and *soever*.] Of any person whatever; John xx.

WHÓSO, *pron.* (hooso.) Any person whatever.

WHÓSEEVER, *pron.* [*who*, *so*, and *ever*.] Any one; any person whatever.

*Whosoever* will, let him take of the water of life freely; Rev. xxii.

WHUR, *v. i.* To pronounce the letter *r* with too much force.

WHUR, *n.* The sound of a body moving through the air with velocity. [See *WHIR*.]

WHURT, *n.* A whortleberry or bilberry. [See *WHORT*.]

WHY, *adv.* [Sax. *hwi*, and *for hwi*, or *for hwi*, for why. *Hwi*, *whig*, coincides in elements with *which*. So *pourquoi* in French, is the same; *pour* and *L. quid*, *quod*; for what. The original phrase is *for what*, *for why*.]

1. For what cause or reason, interrogatively.  
Turn ye, turn ye, for *why* will ye die? Jer. xxvii.

2. For which reason or cause, relatively.  
No ground of enmity,  
*Why* he should mean me ill. Milton.

3. For what reason or cause; for which; relatively.  
Turn the discourse; I have a reason *why* I would not have you speak so tenderly. Dryden.

4. It is used sometimes emphatically, or rather as an expletive.  
If her chill heart I cannot move,  
*Why*, I'll enjoy the very love. Cowley.

WHY, *n.* A young heifer. [Local in *England*.] In *Scotland*, *Quey* is used in the same sense.

WHYNOT, *n.* A cant word for violent and peremptory procedure.

WI, from the Gothic *weiha*, signifies *holy*. It is found in some names, as in *Wibert*, *holy-bright*, or *bright-holy*, eminent for sanctity; Dan. *vien*, to consecrate, Sw. *viga*.

WIC, } a termination, denotes juris-  
WICK, } diction, as in *balliwick*. Its primary sense is a village or mansion, L. *vicus*, Sax. *wic* or *wyc*; hence it occurs in *Berwick*, *Harwich*, *Norwich*, &c. It signifies also a bay or a castle.

WICK, *n.* [Sax. *wecoc*; Sw. *vehe*, a wick or match; Ir. *buatic*, Qu. from *twisting*.] A number of threads of cotton or some spongy substance loosely twisted into a string, plaited or parallel, which by capillary action draws up the oil in lamps, or the melted tallow or wax in candles, in small successive portions, to be burned.

WICK, *v. t.* [Suiio-Goth. *wika*, to bend,

to turn.] To strike a stone in an oblique direction; a term in curling. [Scotch.]

WICK'ED, *a.* [Sw. *wika*, to decline, to err, to deviate, also to fold; Sax. *wican*, to recede, to slide, to fall away; *wice-lian*, to vacillate, to stumble. It seems to be connected in origin with *wag*, and Sax. *wicca*, witch. The primary sense is to wind and turn, or to depart, to fall away.] 1. Evil in principle or practice; deviating from the divine law; addicted to vice; sinful; immoral. This is a word of comprehensive signification, extending to every thing that is contrary to the moral law, and both to persons and actions. We say, a *wicked* man, a *wicked* deed, *wicked* ways, *wicked* lives, a *wicked* heart, *wicked* designs, *wicked* works.

No man was ever *wicked* without secret discontent. Rambler.

2. A word of slight blame; as, the *wicked* urchin.—3. Cursed; baneful; pernicious; as, *wicked* words, words pernicious in their effects. [Obs.] [This last signification may throw some light on the word *witch*.] *The wicked*, in Scripture, persons who live in sin; transgressors of the divine law; and who are unreconciled to God, unsanctified, or impenitent.

WICK'EDLY, *adv.* In a manner or with motives and designs contrary to the divine law; viciously; corruptly; immorally.

All that do *wickedly* shall be stubble; Mal. iv.

I have sinned, and I have done *wickedly*; 2 Sam. xxiv.

WICK'EDNESS, *n.* Departure from the rules of the divine law; evil disposition or practices; immorality; crime; sin; sinfulness; corrupt manners. *Wickedness* generally signifies evil practices.

What *wickedness* is this that is done among you? Judges xx.

But *wickedness* expresses also the corrupt dispositions of the heart.

Their inward part is very *wickedness*; Ps. v.

In heart, ye work *wickedness*; Ps. lviii.

WICK'EN, } *n.* The *Sorbus*  
WICK'EN-TREE, } *aucuparia*, moun-  
tain-ash, or roan-tree

WICK'ER, *n.* [See the *adj.*] A small quick-grown twig; as, a willow-wicker. In *Scotland*, it also signifies a wand; a switch. [Scotch.]

WICK'ER, *a.* [Dan. *vien*, probably contracted from *vigen*. The Eng. *twig*, G. *zweig*, D. *twigg*, are probably formed on the simple word *wig*, from the root of L. *vigeo*, to grow. The word signifies a shoot.] Made of twigs or osiers; as, a *wicker* basket; a *wicker* chair.

WICK'ERED, *a.* Made of wickers or twigs.

WICK'ER-WÖRK, *n.* A texture of twigs.

WICK'ET, *n.* [Fr. *guichet*; W. *gwiced*, a little door, from *gwig*, a narrow place, a corner.] 1. A small gate.

The *wicket*, often open'd, knew the key. Dryden.

2. A small door or gate within a larger one; also, a hole in a door through which to communicate without opening the door; or through which to view what passes without.—3. A small gate by which the chamber of canal locks is emptied.—4. A sort of little gate set up to be bowled at by cricketers.

WIC'LIFFITE, } *n.* A follower of  
WICK'LIFFITE, } Wicliffe the Eng-  
lish reformer; a lollard.

WID'DY, *n.* [Sax. *withig*.] A rope; more properly one made of withs or willows; a halter made of osiers; the gallows. [Scotch.]

WIDE, *a.* [Sax. *wid*, *wide*; D. *wyd*; G. *weit*; Sens. *vidi*, breadth; Ar. *badda*, to separate; allied to *void*, *divide*, *widow*, Ir. *feadh*, &c.] 1. Broad; having a great or considerable distance or extent between the sides; opposed to *narrow*; as, *wide* cloth; a *wide* table; a *wide* highway; a *wide* bed; a *wide* hall or entry. In this use, *wide* is distinguished from *long*, which refers to the extent or distance between the ends.—2. Broad; having a great extent each way; as, a *wide* plain; the *wide* ocean.—3. Remote; distant. This position is very *wide* from the truth.—4. Broad to a certain degree; as, three feet *wide*.

WIDE, *adv.* At a distance; far. His fame was spread *wide*.—2. With great extent; used chiefly in composition; as, *wide-skirted* meads; *wide-waving* swords; *wide-wasting* pestilence; *wide-spreading* evil.

WIDE-BRANCHED, *a.* Having spreading branches.

WIDELY, *adv.* With great extent each way. The gospel was *widely* disseminated by the apostles.—2. Very much; to a great distance; far. We differ *widely* in opinion.

WIDE'-MOUTHED, *a.* Having a wide mouth.

WIDEN, *v. t.* To make wide or wider; to extend in breadth; as, to *widen* a field; to *widen* a breach.

WIDEN, *v. i.* To grow wide or wider; to enlarge; to extend itself.

And arches *widen*, and long aisles extend. Pope.

WIDENED, *pp.* Made wide or wider; extended in breadth.

WIDENESS, *n.* Breadth; width; great extent between the sides; as, the *wideness* of a room.—2. Large extent in all directions; as, the *wideness* of the sea or ocean.

WIDENING, *ppr.* Extending the distance between the sides; enlarging in all directions.

WIDE-SPREAD, *a.* Extending far.

WIDE-SPREADING, *a.* Spreading to a great extent or distance.

WID'GEON, } *n.* A water-fowl of the  
WIG'GEON, } duck group; the *Ma-  
reca penelope*, Stephens, and the *Anas penelope*, Linn. The widgeons are mi-

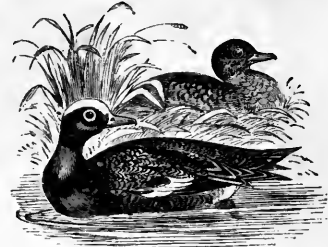

Common Widgeon (*Anas penelope*).

gratory birds which breed in the morasses of Lapland, Norway, and Sweden, which they quit on the approach of winter, and journey southward. They are very numerous in the British Islands during the winter, where they spread

themselves along the shores and over the marshes and lakes. They feed on aquatic plants, and on grass like the geese. They have always been in request for the table. The American widegon is the *Mareca Americana*. It is most abundant in Carolina, and is often called *bold-pate*, from the white on the top of the head.

WID'OW, *n.* [Sax. *widew*; G. *wittwe*; Dan. *widue*; L. *vidua*; Fr. *veuve*; Sp. *viuda*; Sans. *widhava*; Russ. *wdowa*; from the root of *wide*, *void*. [See WIDE.] A woman who has lost her husband by death.—*Widow's chamber*, in London, the apparel and furniture of the bed-chamber of the widow of a freeman, to which she is entitled.—*Widow's terce*, in Scots law.—See TERCE.

WID'OW, *v. t.* To bereave of a husband; but rarely used except in the participle.—2. To endow with a widow's right. [Unusual.]—3. To strip of any thing good.

The *widow'd* isle in mourning. *Dryden.*

WID'OW-BENCH, *n.* [*widow* and *bench*.] In *Sussex*, that share which a widow is allowed of her husband's estate, besides her jointure.

WID'OW-BIRD, *n.* The whidah-finch, —which see.

WID'OWED, *pp.* Bereaved of a husband by death.—2. Deprived of some good; stripped.

Trees of their shrivel'd fruits  
Are *widow'd*. *Philips.*

WID'OWER, *n.* A man who has lost his wife by death.

WID'OWER-HOOD, *n.* The state of a widower.

WID'OW-HOOD, *n.* The state of being a widow.—2.† Estate settled on a widow.

WID'OW-HUNTER, *n.* [*widow* and *hunter*.] One who seeks or courts widows for a jointure or fortune.

WID'OWING, *ppr.* Bereaving of a husband; depriving; stripping.

WID'OWLY, *adv.* Like a widow; becoming a widow.

WID'OW-MAKER, *n.* [*widow* and *macher*.] One who makes widows by destroying lives.

WID'OW-WAIL, *n.* A plant of the genus *Daphne*, the *D. mezereum*, or *Cneorum tricoccum*. [See DAPHNE.]

WIDTH, *n.* [from *wide*; G. *weite*; D. *wydte*.] Breadth; wideness; the extent of a thing from side to side; as, the *width* of cloth; the *width* of a door.

WIEL, *n.* [Sax. *wael*.] A small whirlpool; an eddy. [Scotch.]

WIELD, *v. t.* [Sax. *wealdan*, *waldan*; Goth. *ga-waldan*, to govern; *wald*, power, dominion; Dan. *valde*, power; *gevalt*, force, authority; Sw. *walde*, power; allied to L. *valere*, Eng. *well*. The primary sense of power and strength is to stretch or strain. This seems to be the Russ. *vladya*, to rule, and *wald* or *vlad*, in names, as *Waldemir*, *Vlademir*.] 1. To use with full command or power, as a thing not too heavy for the holder; to manage; as, to *wield* a sword; to *wield* the sceptre. Part *wield* their arms, part curb the foaming steed. *Milton.*

2. To use or employ with the hand.

Nothing but the influence of a civilized power could induce a savage to *wield* a spade. *S. S. Smith.*

3. To handle; in an ironical sense.

Base Hungarian *wight*, wilt thou the spigot *wield*? *Shak.*

To *wield* the sceptre, to govern with supreme command.

WIELD'ABLE, *a.* That may be wielded.

WIELDED, *pp.* Used with command; managed.

WIELDING, *ppr.* Using with power; managing.

WIELESS, *a.* Unmanageable.

WIELDY, *a.* That may be wielded; manageable.

WI'ERY, † *a.* Wiry, —which see.—2. [Sax. *wær*, a pool.] Wet; moist; marshy.

WIFE, *n.* plur. *Wives*. [Sax. *wif*; D. *wyf*; G. *wieb*, woman.] 1. The lawful consort of a man; a woman who is united to a man in the lawful bonds of wedlock; the correlative of *husband*. The husband of one *wife*; 1 Tim. iii.

Let every one of you in particular, so love his *wife* even as himself, and let the *wife* see that she reverence her husband; Eph. v.

2. Originally a woman simply; and in common language often still so applied.—3.† A woman of low employment; as, *strawberry wives*.

WIFEHOOD, *n.* State and character of a wife.

WIFELESS, *a.* Without a wife; unmarried.

WIFELY, *adv.* Like a wife; becoming a wife.

WIG, in *Saxon*, signifies war. It is found in some names.

WIG, *n.* [G. *wech*, wig, and *wech-butter*, roll butter. It would seem that the sense is a roll or twist interwoven.] 1. A covering for the head, consisting of hair interwoven or united by a kind of net-work, formerly much worn by men, and still worn by judges, state counsellors, &c., when they appear in an official capacity.—2. A sort of cake. [Obsolete or Local.]

WIG'EON. See WIDG'EON.

WIG'GED, *a.* Having the head covered with a wig.

WIGHT, *n.* [Sax. *wiht*, G. *wicht*, a living being, Goth. *waiht*; L. *victum*, from *vivo*, to live, originally *vigo* or *vico*, and probably allied to *vigeo*. This, in the Celtic form, would be *quic* or *quig*, Eng. *quich*, alive; and hence L. *qui*, *quæ*, *quid*, *quod*, contracted from *quic*, *quiced*, *quoced*; Scot. *quhat*. The letter *h*, in the Gothic and Scottish, representing the *c* of the Latin, proves the word to be thus contracted.] A being; a person. It is obsolete, except in irony or burlesque. [See AUGHT.]

The *wight* of all the world who lov'd thee best. *Dryden.*

WIGHT, † *a.* [Sax. *hwæt*.] Swift; nimble. [This seems to be a dialectical form of *quick*.]—2. In the *Scottish dialect*, strong; powerful. Often written *wicht*.

WIGHTLY, † *adv.* Swiftly; nimbly.—2. In the *Scottish dialect*, stoutly; with strength or power.

WIG'MAKER, *n.* One who makes wigs.

WIG'WAM, *n.* An Indian cabin or hut, so called in America. It is sometimes written *wekwam*. Mackenzie writes the Knisteneaux word, *wigwam*, and the Algonquin, *wiguwam*.

WIG'WEAVER, *n.* One who manufactures wigs.

WIKER, } *n.* A temporary mark, as WIKER', } with a twig, or tree-branchlet, used sometimes in setting out tithes. [Local.]

WILD, *a.* [Sax. *wild*; D. and G. *wild*; W. *gwyllt*; connected with Sax. *wealh*, a traveller, foreigner, or pilgrim; G.

*wilsch*, Celtic, Welsh: *wallen*, to rove, Sw. *villa*, *förvilla*. This sense is obvious.] 1. Roaming; wandering; inhabiting the forest or open field; hence not tamed or domesticated; as, a *wild* boar; a *wild* ox; a *wild* cat; a *wild* bee.—2. Growing without culture; as, *wild* parsnep; *wild* cherry; *wild* tansy.—3. Desert; not inhabited; as, a *wild* forest.—4. Savage; uncivilized; not refined by culture; as, the *wild* natives of Africa or America.—5. Turbulent; tempestuous; irregular; as, a *wild* tumult.

The *wild* winds howl. *Addison.*

6. Licentious; ungoverned; as, *wild* passions.

Valour grows *wild* by pride. *Prior.*

7. Inconstant; mutable; fickle.

In the ruling passion, there alone  
The *wild* are constant, and the cunning  
known. *Pope.*

8. Inordinate; loose.

A fop well dress'd, extravagant and *wild*.  
*Dryden.*

9. Uncouth; loose.

What are these,  
So wither'd, and so *wild* in their attire?  
*Shak.*

10. Irregular; disorderly; done without plan or order; as, to make *wild* work.—11. Not well digested; not framed according to the ordinary rules of reason; not being within the limits of probable practicability; imaginary; fanciful; as, a *wild* project or scheme; *wild* speculations.—12. Exposed to the wind and sea; as, a *wild* roadstead.—13. Made or found in the forest; as *wild* honey. *Wild* is prefixed to the names of many plants, to distinguish them from such of the name as are cultivated in gardens; as, *wild* basil, *wild* parsnep, *wild* carrot, *wild* olive, &c.

WILD, *n.* A desert; an uninhabited and uncultivated tract or region; a forest or sandy desert; as, the *wilds* of America; the *wilds* of Africa; the sandy *wilds* of Arabia.

Then Libya first, of all her moisture drain'd  
Became a barren waste, a *wild* of sand.  
*Addison.*

WILD-BASIL, *n.* A British perennial plant of the genus *Clinopodium*, the *C. vulgare*. It has large purple flowers in crowded whorls, with an aromatic smell, and grows on hills and dry bushy places; nat. order Labiata.

WILD-BÖAR, *n.* An animal of the hog kind, the *Sus scrofa*, Linn., from which the domesticated swine are descended. [See BOAR.]

WILD-BORN, *a.* Born in a wild state.

WILD-CAT, *n.* A ferocious animal of the genus *Felis*, the *F. catus*, Linn. It is supposed to be the original stock of the domestic cat. [See CAT.]—2. In America, the *Felis rufa*.

WILD-CELERY, *n.* A British biennial plant of the genus *Apium*, the *A. graveolens*. [See APIUM and CELERY.]

WILD-CHERRY, *n.* An American tree of the genus *Cerasus*, the *C. virginiana*. It bears a small astringent fruit resembling a cherry, and the wood is much used for cabinet-work, being of a light red colour and compact texture.

WILD-CHAMOMILE, *n.* A British plant of the genus *Matricaria*, the *M. chamomilla*. [See MATRICARIA.]

WILD-DUCK, *n.* An aquatic fowl of the genus *Anas*, the *A. boschas*, Linn. It is the stock of our common duck, teal, &c. [See DUCK.]

WIL'DER, *a. comp.* More wild.

WIL'DER, *v. t.* [Dan. *vilder*, from *vild*,

wild.] To lose or cause to lose the way or track; to puzzle with mazes or difficulties; to bewilder.

Long lost and *wilder'd* in the maze of fate.

Pope.

WIL'DERED, *pp.* Lost in a pathless tract; puzzled.

WIL'DERING, *ppr.* Puzzling.

WIL'DERNESS, *n.* [from *wild.*] A desert; a tract of land or region uncultivated and uninhabited by human beings, whether a forest or a wide barren plain. In the *United States*, it is applied only to a forest. In *Scripture*, it is applied frequently to the deserts of Arabia. The Israelites wandered in the *wilderness* forty years.

—2. The ocean.

The wat'ry *wilderness* yields no supply.

Waller.

3 † A state of disorder.—4. A wood in a garden, resembling a forest.

WILD'EST, *a. superl.* Most wild.

WILD-EYED, *a.* Having eyes appearing wild.

WILD-FIRE, *n.* [*wild* and *fire.*] A composition of inflammable materials, easy to take fire and hard to be extinguished. [See under FIRE.]

Brimstone, pitch, *wildfire*, burn easily, and are hard to quench. Bacon.

2. A disease of sheep, attended with inflammation of the skin; a kind of erysipelas.

WILD-FOWL, *n.* [*wild* and *fowl.*] Fowls of the forest, or untamed.

WILD-GOOSE, *n.* [*wild* and *goose.*] An aquatic fowl of the genus *Anas*, the *A. anser*, Linn., the *A. ferus*, and *A. anser* of Gesner and others; a bird of passage, and the stock of the domestic goose. These birds fly to the south in autumn, and return to the north in the spring. The term *wild-goose*, however, is promiscuously applied to several species of the goose-kind, found wild in Britain; as *A. palustris*, *A. segetum*, and *A. brachyrhynchus*. The wild-goose of North America, also migratory, is a distinct species, the *A. canadensis*.—*Wild-goose chase*, the pursuit of something as unlikely to be caught as the wild-goose.

WILD-HONEY, *n.* [*wild* and *honey.*] Honey that is found in the forest, in hollow trees or among rocks.

WILDING, *n.* That which is wild or growing without cultivation.

WILDING, *n.* A wild crab-apple.—2. A young tree that is wild, or that grows without cultivation.

WILD-LAND, *n.* [*wild* and *land.*] Land not cultivated, or in a state that renders it unfit for cultivation.—2. In *America*, forest; land not settled and cultivated.

WILDLY, *adv.* Without cultivation.—2. Without tameness.—3. With disorder; with perturbation or distraction; with a fierce or roving look; as, to start *wildly* from one's seat; to stare *wildly*.—4. Without attention; heedlessly.—5. Capriciously; irrationally; extravagantly.

Who is there so *wildly* sceptical as to question whether the sun will rise in the east?

Wilkins.

6. Irregularly.

She, *wildly* wanton, wears by night away  
The sign of all our labours done by day.

Dryden.

WILDNESS, *n.* Rudeness; rough uncultivated state; as, the *wildness* of a forest or heath.—2. Inordinate disposition to rove; irregularity of manners; as, the *wildness* of youth.—3. Savageness; brutality.—4. Savagestate;

rudeness.—5. Uncultivated state; as, the *wildness* of land.—6. A wandering; irregularity.

Delirium is but a short *wildness* of the imagination. Watt.

7. Alienation of mind.—8. State of being untamed.—9. The quality of being undisciplined, or not subjected to method or rules.

Is there any danger that this discipline will tame too much the fiery spirit, the enchanting *wildness*, and magnificent irregularity of the orator's genius? Wirt.

WILD OAT, *n.* A British plant of the genus *Avena*, the *A. fatua*. It is an annual plant, flowering in June and July, and growing among oats and barley. The twisted awn is used for making an hygrometer. [See AVENA, OAT.]—To sow one's *wild oats*, is to pass through a season of wild and thoughtless dissipation; commonly applied to youth. [Colloq.]

WILD-PARSNEP, *n.* A British plant of the genus *Pastinaca*, the *P. sativa*. [See PARSNEP.]

WILD-RICE, *n.* The *Zizania aquatica*, a large kind of grass which grows in shallow water or miry situations, in many parts of North America. It yields a palatable and nutritious food.

WILD SERVICE-TREE, *n.* A British plant of the genus *Pyrus*, the *P. torminalis*. [See PYRUS.]

WILD-SUCCORY, *n.* A British plant of the genus *Cichorium*, the *C. intybus*. [See SUCCORY.]

WILD-SWAN, *n.* The *Cygnus ferus*, an aquatic bird, called also the *whistling swan*. This noble bird appears in winter in the northern parts of Europe and Asia, and resides in summer within the arctic circles. [See SWAN.]

WILE, *n.* [Sax. *wile*; Ice. *wil*; W. *fel*, fine, subtil.] A trick or stratagem practised for insinuating or deception; a sly, insidious artifice.

That ye may be able to stand against the *wiles* of the devil; Eph. vi.

WILE, *v. t.* To deceive; to beguile. [Little used.]

WIL'FUL, *a.* [*will* and *full.*] Governed by the will without yielding to reason; obstinate; stubborn; perverse; inflexible; as, a *wilful* man.—2. Stubborn; refractory; as, a *wilful* horse.

WIL'FULLY, *adv.* Obstinate; stubbornly.—2. By design; with set purpose.

If we sin *wilfully* after that we have received the knowledge of the truth, there remaineth no more sacrifice for sins; Heb. x.

WILFULNESS, *n.* Obstinacy; stubbornness; perverseness.

Sins of presumption are such as proceed from pride, arrogance, *wilfulness*, and haughtiness of men's hearts. Perkins.

WILILY, *adv.* [from *wily.*] By stratagem; with insidious art; Josh. ix.

WYLINESS, *n.* [from *wily.*] Cunning; guile.

WILK, } *n.* [G. *welken*, to wither, or  
WHILK, } cause to wither.] A species  
of mollusc. [See WHELK.]

WILL, *n.* [Sax. *willa*; Goth. *wilja*; D. *wil* or *wille*; G. *wille*; W. *gwyll*; Ir. *ail*; Gr. *βούλη*, counsel; Slav. *volia*. See the Verb.] 1. That faculty or power of the mind by which we determine either to do or not to do, something which we conceive to be in our power; the faculty which is exercised in deciding, among two or more objects, which we shall embrace or pursue. Every man is conscious of a power to determine in things which he conceives

to depend upon his determination. To this power we give the name of *will*; and, as it is usual, in the operations of the mind, to give the same name to the power and to the act of that power, the term *will* is often put to signify the act of determining, which more properly is called *volition*. Volition, therefore, signifies the act of willing and determining, and *will* is put indifferently to signify either the power of willing or the act. Some philosophers, however, give a more extensive meaning to the term *will*, comprehending under it not only our determination to act or not to act, but every motive and incitement to action, but this tends to confound things which are very different in their nature. The *will* is directed or influenced by the judgment. The understanding or reason compares different objects, which operate as motives; the judgment determines which is preferable, and the *will* decides which to pursue. In other words, we reason with respect to the value or importance of things; we then *judge* which is to be preferred; and we *will* to take the most valuable. These are but different operations of the mind, soul, or intellectual part of man. The freedom of the *will* is essential to moral action; but respecting this subject there have been great disputes among philosophers and divines.—2. Choice; determination. It is my *will* to prosecute the trespasser.—3. Choice; discretion; pleasure.—Go, then, the guilty at thy *will* chastise.

Pope.

4. Command; direction.

Our prayers should be according to the *will* of God. Law.

5. Disposition; inclination; desire. "What is your *will*, Sir?" In this phrase, the word may also signify determination, especially when addressed to a superior.—6. Power; arbitrary disposal.

Deliver me not over to the *will* of my enemies; Ps. xxvii.

7. Divine determination; moral purpose or counsel.

Thy *will* be done. Lord's Prayer.

8. In *law*, a testament, the legal declaration of a man's intentions, as to what he wills to be performed after his death in relation to his property. In strictness of language, the term *will* is limited to land, and *testament* to personal estate. Formerly wills were either nuncupative or written; but, according to the Act I. Vict. c. 26, (passed in 1837), by which the making of wills is now regulated, no *will*, whether of real or personal estate, is to be valid, unless it be in writing, and signed at the foot or end by the testator, or by some person in his presence, and by his direction; and such signature must be made or acknowledged by the testator in the presence of two or more witnesses present at the same time, and such witnesses must attest and subscribe the *will* in the presence of the testator, but no particular form of attestation is necessary. This act, however, does not affect the wills of soldiers on actual service, or of mariners at sea. These have the power of making nuncupative wills. In the *law of Scotland*, the term *will* is not used technically, at least by itself, although it is sometimes so used in combination, as in the expression *last* or *latter will*, which is synonymous with *testament*.

In popular language, however, it is employed to signify any declaration of what a person wills, with regard to the disposal of his property, heritable or movable, and thus includes not only testaments, but all the complicated forms of deeds, granted in the prospect of death.—*Will of a summons*, or other *signet letter*, in *Scots law*, that part of the writ beginning, "*Our will is,*" &c.—*Good will*, favour; kindness.—2. Right intention; Phil. i.—*Ill will*, enmity; unfriendliness. It expresses less than *malice*.—*To have one's will*, to obtain what is desired.—*At will*. To hold an estate *at the will* of another, is to enjoy the possession at his pleasure, and be liable to be ousted at any time by the lessor or proprietor.—*Will with a wisp*, or *Will o' the wisp*, Jack with a lantern; ignis fatuus; a luminous appearance sometimes seen in the air over moist ground. [See IGNIS FATUUS.]  
 WILL, v. t. [Sax. *willan*; Goth. *wilyjan*; D. *willen*; G. *wollen*; L. *volo, velle*; Gr. *βουλομαι*; Fr. *vouloir*. The sense is to set, or to set forward, to stretch forward. The sense is well expressed by the L. *proponeo*.] 1. To determine; to decide in the mind that something shall be done or forborne, implying power to carry the purpose into effect. In this manner God *wills* whatever comes to pass. So in the style of princes: "*we will* that execution be done."

A man that sits still is said to be at liberty, because he can walk if he *wills* it.

Locke.

2. To command; to direct.

'Tis yours, O queen I to *will*  
 The work which duty bids me to fulfil.

Dryden.

3. To be inclined or resolved to have. There, there, Hortensio, *will* you any wife?

Shak.

4. To wish; to desire. What *will* you?  
 —5. To dispose of estate and effects by testament.—6. It is sometimes equivalent to *may be*. Let the circumstances be what they *will*; that is, any circumstances, of whatever nature.—7. *Will* is used as an auxiliary verb, and a sign of the future tense. When an auxiliary verb, the past tense is *would*. It has different significations in different persons.—1. *I will* go, is a present promise to go; and with an emphasis on *will*, it expresses determination.—2. *Thou wilt* go, *you will* go, express foretelling; simply stating an event that is to come.—3. *He will* go, is also a foretelling. The use of *will* in the plural is the same. *We will*, *promises*; *ye will*, *they will*, foretell. [See SHALL.]

WILL, n. The abridged form of William, a man's name. [FAMILIAR.]

WILL, v. i. To dispose of effects by will or testament.

WILL'ED, pp. Determined; resolved; desired.—2. Disposed of by will or testament.

WIL'LEMITE, n. A mineral of resinous lustre and yellowish colour. It is a silicate of zinc.

WILL'ER, n. One who wills.—2. One who wishes; as, he is my *ill-willer*. [Not much used in either sense.]

WILL'ING, ppr. Determining; resolving; desiring.—2. Disposing of by will.

WILL'ING, a. [Sw. and Dan. *willig*.] 1. Free to do or grant; having the mind inclined; disposed; not adverse.

Let every man give, who is able and *willing*.—2. Pleased; desirous.

Felix, *willing* to show the Jews a pleasure; Acts xxiv.

3. Ready; prompt.

He stoop'd with weary wings and *willing* feet.

Milton.

4. Chosen; received of choice or without reluctance; as, to be held in *willing* chains.—5. Spontaneous.

No spouts of blood run *willing* from a tree.

Dryden.

6. Consenting.

WILL'ING-HEARTED, a. Well disposed; having a free heart; Exod. xxxv.

WILL'INGLY, adv. With free will; without reluctance; cheerfully.—2. By one's own choice

The condition of that people is not so much to be envied as some would *willingly* represent it.

Addison.

WILL'INGNESS, n. Free choice or consent of the will; freedom from reluctance; readiness of the mind to do or forbear.

Sweet is the love that comes with *willingness*.

Dryden.

WIL'LOW, n. [Sax. *welig*; D. *wilge*; W. *gwial*, twigs; also *helig*, L. *salix*.] The common name of the different species of plants belonging to the genus *Salix*, the type of the nat. order *Salicaceæ*. The species of willows are very numerous, about 220 having been described, of which more than 60 are British. They are all either trees or bushes, occurring abundantly in all the cooler parts of the northern hemisphere. They grow naturally in a moist soil, and wherever planted, they should be within the reach of water. On account of the flexible nature of their shoots, and the toughness of their woody fibre, willows have always been used as materials for baskets, hoops, crates, &c. They are much used in the manufacture of charcoal, and the bark of them all contains the tanning principle. The willow is considered as the emblem of despairing love, and is often associated with *the yew* and *the cypress* in the church-yard.

WILLOW, } n. In *woollen manufacturing*, } *tures*, a machine for opening and disentangling the locks of wool, and cleansing them from sandy and other loose impurities. This operation is called *wilowing* or *willying*.

WIL'LOWED, a. Abounding with willows.

WIL'LOW-GALL, n. A protuberance on the leaves of willows.

WIL'LOW-GROUND, n. A piece of swampy land, where osiers are grown for basket-making.

WIL'LOW-HERB, n. The common name of the plants belonging to the genus *Epiobium*, natives of the cooler parts and mountainous districts of Europe, Asia, and America. They are all ornamental plants, but are of little utility. [See EPILOBIUM.]

WIL'LOWISH, a. Like the colour of the willow.

WIL'LOW-OAK, n. An American tree of the genus *Quercus*, the *Q. phellos*. The wood is of loose coarse texture, and is little used.

WIL'LOW-WEED, n. The *Polygonum lapathifolium*, a weed growing on wet light lands, with a seed like buck-wheat.

WIL'LOW-WÖRT, n. A plant.

WIL'LOW-WREN, n. The *Sylvia*

*trochilus*, one of the most abundant of the warblers. It is a summer visitant in Britain, and is found in almost every wood and copse.

WIL'LOWY, a. Abounding with willows.

WILL-WITH-A-WISP, } See under

WILL-O'-THE-WISP. } WILL.

WILL'YART, n. Wild; strange; shy.

[Scotch.]

WILSOME, a. Obstinate; stubborn.

[Obsolete or local.]

WILT, v. i. [D. and G. *welken*, to fade; that is, to shrink or withdraw.] To fade; to decay; to droop; to wither; as plants or flowers cut or plucked off.

A word often used in the United States, and provincial in England. [See WELK.]

WILY, a. [from *wile*.] Cunning; sly; using craft or stratagem to accomplish a purpose; subtle; as, a *wily* adversary.

WIM'BLE, n. [W. *guimbil*, a gimlet; *guimiau*, to move round briskly. See WHIM.] An instrument used by carpenters and joiners for boring holes; a kind of augur.

WIM'BLE, v. t. To bore, as with a wimble.

WIM'BLE,† a. Active; nimble.

WIM'BREL, n. A bird of the curlew kind, a species of *Scolopax*, *S. phæopus*.

WIM'PLE,† n. [G. *wimpel*, a pendant; Dan. *vimpel*; W. *gwempyl*, a veil, a wimple; Fr. *guimpe*, a neck handkerchief.] A hood or veil; Is. iii.

WIM'PLE, n. A winding or fold.

[Scotch.]

WIM'PLE,† v. t. To draw down, as a veil.

WIM'PLE, v. t. To wrap; to fold. As a verb neuter, to meander, as a stream.

[Scotch.]

WIN, v. t. pret. and pp. *Won*. [Sax. *winnan*, to labour, to toil, to gain by labour, to win; D. *winnen*; G. *gewinnen*; Sw. *vinna*.] 1. To gain by success in competition or contest; as, to win the prize in a game; to win money; to win a battle, or to win a country. Battles are won by superior strength or skill.

Who thus shall Canaan win.

2. To gain by solicitation or courtship.

—3. To obtain; to allure to kindness or compliance. Thy virtue won me. Win your enemy by kindness.—4. To gain by persuasion or influence; as, an orator wins his audience by argument. The advocate has won the jury.

And Mammon wins his way, where seraphs might despair.

Byron.

5. In *North Britain*, to earn; as, he wins his bread honestly.

WIN, v. i. [from *wind*.] To dry corn, hay, &c., by exposing them to the air.

[Scotch.]

WIN, v. i. To gain the victory.

Nor is it ought but just  
 That he, who in debate of truth hath won,  
 Should win in arms.

To win upon, to gain favour or influence; as, to win upon the heart or affections.—2. To gain ground.

The rabble will in time win upon power.

To win of, to be conqueror.

WIN, v. i. To get; to gain. [Scotch.]

WINCE, v. i. [Fr. *guincer*, to twist; *guingois*, crookedness, W. *gweng*; *guingaw*, to wriggle, to wince.] 1. To twist or turn, as in pain or uneasiness;

to shrink, as from a blow or from pain; to start back.

I will not stir nor *wince*. *Shak.*

2. To kick or flounce when uneasy, or impatient of a rider; as, a horse *winces*.

**WINCE**, or **WIN'GING MACHINE**, *n.* The dyer's reel, upon which he winds the piece of cloth to be dyed. It is suspended horizontally by the ends of its axis in bearings, over the edge of the vat, so that the line of the axis may be placed over the middle partition in the vessel. By this means, the piece of cloth wound upon the reel is allowed to descend alternately into either compartment of the bath, according as it is turned by hand to the right or the left.

**WIN'GER**, *n.* One that winces, shrinks, or kicks.

**WINCH**, *n.* [*Sax. wince; Fr. guincher, to twist.*] In *mech.*, the crank or rectangular lever by which the axis of a revolving machine is turned; as in the common windlass, the grindstone, &c. Also an instrument with which to turn or strain something forcibly. The term *winch* is also popularly applied to the windlass.—2. A kick from impatience or fretfulness, as of a horse; a twist or turn.

**WINCH**, *v. i.* To wince; to shrink; to kick with impatience or uneasiness. [This is a more correct orthography than *wince*.]

**WINCH AND AXLE**. Another name for the double axis machine. [*See under WHEEL AND AXLE.*]

**WIN'CHESTER BUSHEL**, *n.* The original English standard measure of capacity, established by Henry VII., and ordered to be kept in the town-hall of Winchester. It contains 2150.42 cubic inches, and is to the imperial standard bushel now established as 32 to 33 nearly.

**WINCH'ING**, *v. ppr.* Flinching; shrink-winch'ing, } ing; kicking.

**WIN'COIPE**, *n.* The vulgar name of a little flower, that, when it opens in the morning, bodes a fair day. This is probably the *Anagallis arvensis*, or common scarlet pimpernel, often called the *poor man's hour-glass* or barometer. [*See PIMPERNEL.*]

**WIND**, *n.* [*Sax. wind; D. and G. wind; W. gwynt; L. ventus; Fr. vent.* This word accords with *L. venio, ventum*, and the Teutonic *wendamm*, *Eng. went*. The primary sense is to move, flow, rush, or drive along.] 1. Air in motion with any degree of velocity, indefinitely; a current of air; a current in the atmosphere, conveying the air with greater or less velocity from one part to another; a current as coming from a particular point. When the air moves moderately, we call it a light wind or a breeze; when with more velocity, we call it a fresh breeze; and when with violence, we call it a gale, storm, tempest, or hurricane. The word *gale* is used by the poets for a moderate breeze, but seamen use it as equivalent to *storm*. The principal cause of those currents of air to which we give the name of *winds*, is the disturbance of the equilibrium of the atmosphere by the unequal distribution of heat. When one part of the earth's surface is more heated than another, the heat is communicated to the air above that part, in consequence of which the air expands, becomes lighter, and rises up,

while colder air rushes in to supply its place, and thus produces wind. As the heat of the sun is greatest in the equatorial regions, the general tendency there is for the heavier columns of air to displace the lighter, and for the air at the earth's surface to move from the poles toward the equator. The only supply for the air thus constantly abstracted from the higher latitudes must be produced by a counter-current in the upper regions of the atmosphere, carrying back the air from the equator towards the poles. The quantity of air thus transported, by these opposite currents, is so nearly equal, that the average weight of the air, as indicated by the barometer, is the same in all places of the earth. Besides the unequal distribution of heat already mentioned, there are various other causes which give rise to currents of air in the atmosphere, such as the chemical changes which are carried on in the air, the condensation of the aqueous vapours which are constantly rising from the surfaces of rivers and seas, and the agency of electricity. Winds have been divided into *fixed* or *constant*, as the trade winds; *periodical*, as the monsoons; *land and sea breezes*; and *variable winds*, or such as blow at one time from one point; at another from another point; and at another time cease altogether. [*See TRADE WINDS, MONSOONS, LAND AND SEA BREEZES.*] There are also various local winds, which receive particular names; as the *Etesian wind*, the *Sirocco*, the *Samiel* or *Simoom*, the *Harmattan*, &c. [*See these terms.*] The velocity of the wind varies from one that is hardly sensible, to one of 100 miles in an hour. *Winds* are denominated from the point of compass from which they blow; as, a *north* wind; an *east* wind; a *south* wind; a *west* wind; a *southwest* wind. &c.—2. The *four winds*, the cardinal points of the heavens.

Come from the *four winds*, O breath, and breathe upon these slain; Ezek. xxxvii. This sense of the word seems to have had its origin with the Orientals, as it was the practice of the Hebrews to give to each of the four cardinal points the name of *wind*.—3. † Direction of the wind from other points of the compass than the cardinal, or any point of compass; as, a compass of eight *winds*.—4. Breath; power of respiration.

If my *wind* were but long enough to say my prayers, I would repent. *Shak.*

5. Air in motion from any force or action; as, the *wind* of a cannon ball; the *wind* of a bellows.—6. Breath modulated by the organs or by an instrument.

Their instruments were various in their kind,

Some for the bow, and some for breathing *wind*. *Dryden.*

7. Air impregnated with scent.

A pack of dog-fish had him in the *wind*. *Shak.*

8. Any thing insignificant or light as wind.

Think not with *wind* or airy threats to awe. *Milton.*

9. Flatulence; air generated in the stomach and bowels; as, to be troubled with *wind*.—10. The name given to a disease of sheep, in which the intestines are distended with air, or rather affected with a violent inflammation.

It occurs immediately after shearing.—*Down the wind*, decaying; declining; in a state of decay; as, he went *down the wind*. †—*To take* or *have the wind*, to gain or to have the advantage.—*To take wind*, or *to get wind*, to be divulged; to become public. The story *got wind*, or *took wind*.—*In the wind's eye*, in seamen's language, toward the direct point from which the wind blows.—*All in the wind*, a term applied to a vessel when her head is too close to the wind, so that the sails are shivering.—*Between wind and water*, denoting that part of a ship's side or bottom which is frequently brought above water by the rolling of the ship, or fluctuation of the water's surface.—*To carry the wind*, in the manege, is when a horse tosses his nose as high as his ears. [In poetry, *wind* often rhymes with *find*; but the common pronunciation is with *i* short, and so let it continue.]

**WIND**, *v. t.* pret. and pp. *Wound*. [*Sax. windan; G. and D. winden; from wind, or the same root.*] 1. To blow; to sound by blowing or inflation; to sound so that the notes shall be prolonged and varied.

*Wind* the shrill horn. *Pope.*

2. To turn; to move, or cause to turn. To turn and *wind* a fiery Pegasus. *Shak.*

3. To turn round some fixed object; to bind, or to form into a ball or coil by turning; as, to *wind* thread on a reel; to *wind* thread into a ball; to *wind* a rope into a coil.—4. To turn by shifts and expedients.

He endeavours to turn and *wind* himself every way to evade the force of this famous challenge. *Waterland.*

5. To introduce by insinuation. The child *winds* himself into my affections.

They have little arts and dexterities to *wind* in such things into discourse.

*Gor. of the Tongue.*

6. To change; to vary.

Were our legislature vested in the prince, he might *wind* and turn our constitution at his pleasure. *Addison.*

7. To entwine; to enfold; to encircle.—*To wind off*, to unwind.—*To wind out*, to extricate.—*To wind up*, to bring to a small compass, as a ball of thread.

—8. To bring to a conclusion or settlement; as, to *wind up* one's affairs.—

9. To put in a state of renovated or continued motion.

Fate seem'd to *wind* him up for fourscore years. *Dryden.*

*To wind up a clock*, is to wind the cord by which the weights are suspended, round an axis or pin.—

*To wind up a watch*, is to wind the spring round its axis or pin.—10. To raise by degrees.

Thus they *wound up* his temper to a pitch. *Atterbury.*

11. To straiten, as a string; to put in tune.

*Wind up* the slacken'd strings of thy lute. *Waller.*

12. To put in order for regular action.

**WIND**, *v. t.* To nose; to perceive or follow by the wind or scent; as hounds *wind* an animal.—2. To ventilate; to expose to the wind; to winnow.—3. To drive or ride hard, as a horse, so as to render scant of wind; also, to rest, as a horse, in order to recover wind.—

*To wind a ship*, to bring it round until the head occupies the place where the stern was, so that the wind may strike the opposite side.



**WIND**, *v. i.* To turn; to change.

So swift your judgments turn and *wind*.

*Dryden.*

2. To turn around something; as, vines *wind* around a pole.—3. To have a circular direction; as, *winding* stairs.—4. To crook; to bend; to proceed in flexures. The road *winds* in various places.—5. To move round; to double; as, a hare pursued turns and *winds*.—6. To have a twist, or an uneven surface, or a surface whose parts do not lie in the same plane; as, a piece of wood.—To *wind out*, to be extricated; to escape.

Long lab'ring underneath, ere they could *wind*

Out of such prison.

*Milton.*

**WIND'AGE**, *n.* [Sp. *viento*, wind, windage.] The difference between the diameter of a gun or other piece of ordnance and that of a ball or shell.

**WIND' BEAM**, *n.* In *arch.*, an old term for a collar beam.

**WIND' BILL**, *n.* In *Scots law*, an accommodation bill; a bill of exchange granted without value having been received by the acceptors, for the purpose of raising money by discount.

**WIND'-BORE**, *n.* The extremity of the suction pipe of a pump, usually covered with a perforated plate, to prevent the intrusion of foreign substances.

**WIND'BOUND**, *a.* [*wind* and *bound*.] Prevented from sailing by a contrary wind.

**WIND'-BRO'KEN**, *a.* Diseased in the wind, or heath; as, a *wind-broken* horse.

**WIND'-CHANG'ING**, † *a.* Changeful as the wind; fickle.

**WIND'-DRIED**, *a.* Dried in the wind.

**WIND'-DROPSY**, *n.* [*wind* and *dropsy*.] A swelling of the belly from wind in the intestines; tympanites.

**WIND'-EGG**, *n.* [*wind* and *egg*.] An addle egg.

**WIND'ER**, *v. t.* To fan; to clean grain with a fan. [*Local*.]

**WIND'ER**, *n.* He or that which winds; as a bobbin-winder.—2. An instrument or machine for winding.—3. A plant that twists itself round others.

**WIND'ER-MEB**, *n.* A bird of the genus *Larus*, or gull-kind.

**WINDERS**, *n.* In *arch.*, steps of a stair while radiating from a centre, are narrower at the one end than the other.—2. Among *pugilists*, a blow that deprives of breath. [*Vulgar*.]

**WIND'FALL**, *n.* [*wind* and *fall*.] Fruit blown off the tree by wind.—2. An unexpected legacy; any unexpected advantage.

**WIND'-FALLEN**, *a.* Blown down by the wind.

**WIND'-FLOWER**, *n.* [*wind* and *flower*.] A plant, the anemone.

**WIND'-FURNACE**, *n.* [*wind* and *furnace*.] A furnace in which the air is supplied by an artificial current, as from a bellows.

**WIND'-GAGE**, *n.* [*wind* and *gage*.] An instrument for ascertaining the velocity and force of wind; an anemometer. [*See ANEMOMETER*.]

**WIND'-GALL**, *n.* [*wind* and *gall*.] A soft tumour on the fetlock joints of a horse.

**WIND'-GUN**, *n.* An air gun; a gun discharged by the force of compressed air.

**WIND'-HATCH**, *n.* [*wind* and *hatch*.] In mining, the opening or place where the ore is taken out of the earth.

**WIND'-HOVER**, *n.* [*wind* and *hover*.]

A species of hawk, the *Falco tinnunculus*, called also the *stannel*, but more usually the *kestrel*.

**WIND'INESS**, *n.* [from *windy*.] The state of being windy or tempestuous; as, the *windiness* of the weather or season.—2. Fullness of wind; flatulence.—3. Tendency to generate wind; as, the *windiness* of vegetables.—4. Tumour; puffiness.

The swelling *windiness* of much knowledge.

*Brewerwood.*

**WINDING**, *n.* Act of those persons or things that wind.

**WINDING**, *ppr.* Turning; binding about; bending.—2 *a.* Bending; twisting from a direct line or an even surface.

**WINDING**, *n.* A turn or turning; a bend; flexure; meander; as, the *windings* of a road or stream.—2. Among *workmen*, a turn or twist in any surface, so that all its parts do not lie in the same plane. When a surface is perfectly plane, it is said to be *out of winding*.—3. A call by the boatswain's whistle.

**WINDING-ENGINE**, *n.* An engine employed in mining, to draw up buckets from a deep pit.

**WINDINGLY**, *adv.* In a winding or circuitous form.

**WINDING-SHEET**, *n.* [*winding* and *sheet*.] A sheet in which a corpse is wrapped.

**WINDING-STICKS**, *n.* In *joinery*, two slips of wood, each straightened on one edge, and having the opposite edge parallel. Their use is to ascertain whether the surface of a board, &c., *winds* or is twisted. For this purpose, one of the slips is placed across one end of the board, and the other across the other end, with one of the straight-edges of each upon the surface. The joiner then looks in a longitudinal direction over the upper edges of the two slips, and if he finds that these edges coincide throughout their length, he concludes that the surface is *out of winding*; but if the upper edges do not coincide, this is a proof that the surface *winds*. [*See WINDING*.]

**WINDING-TACKLE**, *n.* [*winding* and *tackle*.] In *ships*, a tackle consisting of one fixed triple block, and one double or triple movable block, used principally to hoist up any weighty materials, as guns.

**WIND'-INSTRUMENT**, *n.* An instrument of music, played by wind, chiefly by the breath; as a flute, a clarinet, &c. Wind instruments generally produce their effects by the vibrations of a column of air in a tube, shut at one end, and either open or shut at the other. These vibrations are determined mainly by the length of the sounding column; yet inferior and subordinate ones are found to co-exist with the fundamental one. The whole column spontaneously divides itself into portions equal to the half, the third, or the fourth of its longitudinal extent, and thus different sounds are produced. The finger holes, and keys of wind instruments, are contrivances for varying the length of the sounding column, and thus producing different tones.

**WIND'LASS**, *n.* [*wind* and *lace*. Qu.] In *mech.*, a modification of the wheel and axle, used for raising weights, &c. The common windlass, such as is used for raising water from wells, &c., consists simply of an axle, which is turned by a winch. One end of a rope or

chain being attached to the axle, and the other to a weight, by turning the winch, the rope is coiled on the axle, and thus the weight is raised. The windlass used in ships for raising the anchors, or obtaining a purchase on other occasions, consists of a strong beam of wood placed horizontally, and supported at its ends by iron spindles, which turn in collars or bushes inserted in what are termed the *windlass bits*.

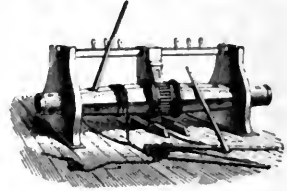

Ship's Windlass.

This large axle is pierced with holes directed towards its centre, in which long levers or handspikes are inserted, for turning it round when the anchor is to be weighed or any purchase is required. It is furnished with *pauls* to prevent it from turning backwards when the pressure on the handspikes is intermitted. It is sometimes written *windlace*. Improved patent windlasses are now extensively used in ships.—2 † A handle by which any thing is turned.

**WIND'LE**, *n.* A spindle; a kind of reel.

**WIND'LESS**, *a.* Having no wind; calm.

**WIND'LESTRAWS**, *n.* The withered flower-stalks of grasses; bents. [*Local*.] In *Scotland*, *windlestraw* is a name given to crested dog's-tail grass (*Cynosurus cristatus*).

**WIND'-MILL**, *n.* [*wind* and *mill*.] A mill which receives its motion from the impulse of the wind, and which is used for grinding corn, pumping water, &c. There are two kinds of wind-mills, the *vertical* and *horizontal*. In the former, a section of which is here given,

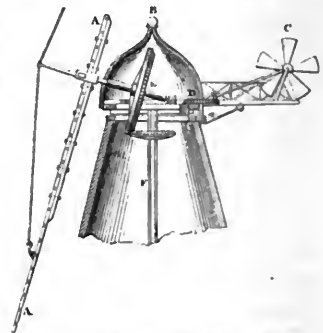

Section of upper part of Wind mill.

the wind is made to act upon sails or vanes, A (generally four in number), attached by means of rectangular frames to the extremities of the principal axis or *wind-shaft* of the mill, which is placed nearly horizontal, so that the sails, by the action of the wind, revolve in a plane nearly vertical, giving a rotatory motion to the driving wheel, E, fixed to the wind-shaft, and thus conveying motion to the vertical shaft, F, and the machinery connected with

it. The extremity of the wind-shaft must always be placed so as to point to the quarter from which the wind blows. To effect this, some mills have a self-adjusting cap, B, which is turned round by the force of the wind acting upon the fan or flyer, C, attached to the projecting frame-work at the back of the cap. By means of a pinion on its axis, motion is given to the inclined shaft, and to the wheel, D, on the vertical spindle of the pinion, A, this latter pinion engages the cogs on the outside of the fixed rim of the cap; by these means the sails are kept constantly turned to the wind, the head of the mill moving slowly round, the moment any change in the direction of the wind causes the fan, C, to revolve. In the horizontal wind-mill, the wind-shaft is vertical, so that the sails revolve in a horizontal plane. The effect of horizontal wind-mills, however, is considered to be far inferior to that of the vertical kind. The effect of wind-mills depends greatly upon the form and position of the sails.

**WIND'OW**, *n.* [Dan. *vindue*; Sp. *ventana*, from the same root as *venta*, sale, *vent* of goods. The word in Spanish signifies also a nostril, that is, a passage. *Ventaja* is advantage; *ventalla*, a valve, and *ventalle*, a fan; *ventear*, to blow. Hence we see that *vent*, L. *vento*, *wind*, *fan*, and *van*, Fr. *avant*, are all of one family. So is also the L. *fenestra*, Fr. *fenêtre*, D. *venster*, G. *fenster*, Ir. *fineog*. The vulgar pronunciation is *windor*, as it from the Welsh *gwyndor*, wind-door.] 1. An opening in the wall of a building for the admission of light, and of air when necessary. This opening has a frame on the sides, in which are set movable sashes, containing panes of glass. The sashes are generally made to rise and fall, for the admission or exclusion of air, but sometimes the sashes are made to open and shut vertically, like the leaves of a folding door.—2. An aperture or opening resembling a window.

A window shalt thou make to the ark; Gen. vi.

3. The frame or other thing that covers the aperture.

Ere I let fall the windows of mine eyes. *Shak.*

4. An aperture; or rather the clouds or water-spouts.

The windows of heaven were opened; Gen. vii.

5. Lattice or casement; or the net work of wire used before the invention of glass; Judges v.—6. Lines crossing each other.

Till he has windows on his bread and butter. *King.*

**WIND'OW**, *v. t.* To furnish with windows.—2. To place at a window. [*Unusual.*]—3. To break into openings. [*Unusual.*]

**WIND'OW-BLIND**, *n.* [*window* and *blind*.] A blind to intercept the light of a window. [*See BLIND.*]

**WIND'OW-CURTAIN**, *n.* A curtain, usually decorative, hung over the window recess inside a room. [*See CURTAIN.*]

**WIND'OWED**, *pp.* Furnished with windows.—2. Having many openings or rents.

Your loop'd and window'd raggedness. *Shak.*

**WIND'OW-FRAME**, *n.* [*window* and

*frame.*] The frame of a window which receives and holds the sashes.

**WIND'OW-GLASS**, *n.* [*window* and *glass.*] Panes of glass for windows.

**WIND'OWLESS**, *n.* Destitute of windows.

**WIND'OW-SASH**, *n.* [*window* and *sash.*] The sash or light frame in which panes of glass are set for windows. [*See SASH.*]

**WIND'OW-SHUTTER**, *n.* A wooden frame or door to close up a window. [*See SHUTTER.*]

**WIND'OW-SILL**, *n.* In arch. *See SILL.*

**WIND'OW-TAX**, } *n.* An import  
**WIND'OW-DU'TY**, } levied on all houses in cities, towns, &c., based on the number of windows, or openings for light in each house, and commencing upon the eighth window. It is one of the assessed taxes of Great Britain, but is not imposed in Ireland.

**WIND'OWY**, *† a.* Having little crossings like the sashes of a window.

**WIND PIPE**, *n.* [*wind* and *pipe.*] The passage for the breath to and from the lungs; the trachea.

**WIND'-PUMP**, *n.* [*wind* and *pump.*] A pump moved by wind, useful in draining lands.

**WIND'-RODE**, *n.* A term used by seamen to signify a ship when riding with wind and tide opposed to each other, driven to the leeward of her anchor.

**WIND'-ROW**, *n.* [*wind* and *row.*] A row or line of hay, raked together for the purpose of being rolled into cocks or heaps.—2. The green border of a field, dug up in order to carry the earth on other land to mend it.—3. A row of peats set up for drying; or a row of pieces of turf, sod, or sward, cut in paring and burning.

**WIND'ROW**, *v. t.* To rake or put into the form of a windrow.

**WIND'-SAIL**, *n.* [*wind* and *sail.*] A wide tube or funnel of canvas, used to

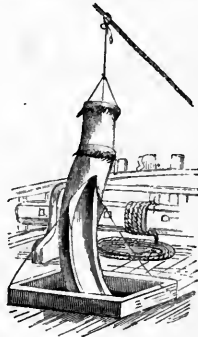

Wind-sail suspended from jib-stay.

convey a stream of air into the lower apartments of a ship.—2. One of the vanes or sails of a wind-mill.

**WIND'SEED**, *n.* A plant of the genus *Arctotis*.

**WIND'-SHOCK**, *n.* [*wind* and *shock.*] A sort of bruise or shiver in a tree.

**WIND'SOR-BEAN**, *n.* The broad-bean, or kidney-bean,—*which see.*

**WIND'SOR-CHAIR**, *n.* A sort of low wheel-carriage.

**WIND'SOR KNIGHT**, }  
**POOR KNIGHT OF WIND'SOR**, }

*n.* One of a body of military pensioners, having their residence within the precincts of Windsor Castle. They are

now called the military knights of Windsor.

**WIND'SOR-SOAP**, *n.* In *perfumery*, a kind of fine scented soap, the chief manufacture of which was once confined to Windsor.

**WIND'-TIGHT**, *a.* [*wind* and *tight.*] So tight as to prevent the passing of wind.

**WIND'WARD**, *n.* [*wind* and *ward.*] The point from which the wind blows; as, to ply or sail to the *windward*.

**WIND'WARD**, *a.* [*wind* and *ward.*] Being on the side toward the point from which the wind blows; as, the *windward* shrouds.

**WIND'WARD**, *adv.* Toward the wind.—*To lay an anchor at the windward*, to adopt previous measures for success or security.

**WIND'WARD-TIDE**, *n.* The tide that sets to windward.

**WIND'Y**, *a.* Consisting of wind; as, a *windy* tempest.—2. Next the wind; as, the *windy* side.—3. Tempestuous; boisterous; as, *windy* weather.—4. Puffy; flatulent; abounding with wind.—5. Empty; airy; as, *windy* joy.

**WINE**, *n.* [Sax. *win*; G. *wein*; D. *wijn*; W. *guin*; Russ. *vinu*; L. *vinum*; Fr. *vin*; Ir. *fiun*; Gr. *oivos*; Eolic, *ἄνω*; Heb. *יַיִן*, *ain*. This Oriental word seems to be connected with *יַיִן*, *ain*, a fountain, and *אָנָה*, *anah*, to thrust, to press, or press out.] 1. The fermented juice of the grape, or of the fruit of the vine, (*vitis vinifera*. *See VITIS*). Wines are distinguished practically, by their colour, hardness or softness on the palate, their flavour, and their being still or effervescing. The differences in the quality of wines depend partly upon differences in the vines, but more on the differences of the soils in which they are planted, in the exposure of the vineyards, in the treatment of the grapes, and the mode of manufacturing the wines. When the grapes are fully ripe, they generally yield the most perfect wine as to strength and flavour. The leading character of wine, however, must be referred to the alcohol which it contains, and upon which its intoxicating powers principally depend. The most celebrated ancient wines were those of Lesbos and Chios among the Greeks, and the Falernian and Cecuban among the Romans. The principal modern wines are Port, Sherry, Claret, Champagne, Madeira, Hock, Marsala, Cape, with their varieties. The wines most used in this country are Port and Sherry, especially the former. The wines intended for the English market, are mixed with a large quantity of brandy. Genuine unmixed port wine is very rarely met with in this country.

—2. The juice of certain fruits, prepared with sugar, sometimes with spirits, &c. as, currant *wine*; gooseberry *wine*.—3. Any spirituous product of fermentation.—4. Intoxication. Noah awoke from his *wine*; Gen. ix.

5. Drinking.

They that tarry long at the *wine*; Prov. xxiii.

*Corn and wine*, in Scripture, are put for all kinds of necessities for subsistence; Ps. iv.—*Bread and wine*, in the Lord's supper, are symbols of the body and blood of Christ.—*Spirit of wine*, alcohol,—*which see.*

**WINE-BIBBER**, *n.* One who drinks much wine; a great drinker; Prov. xxiii.

**WINE-CASK**, *n.* [*wine* and *cash*.] A cask in which wine is or has been kept.

**WINE-CELLAR**, *n.* An apartment or cellar for stowing wine. Wine cellars are generally underground, on the basement story of a building, in order that the wine may be kept cool and at an equal temperature.

**WINE-COOLER**, *n.* A porous vessel of earthenware, which being dipped in water, absorbs a considerable quantity of it. A bottle of wine is placed in the vessel, and the evaporation which takes place from the vessel, abstracts heat from the wine. *Wine coolers* for the table are usually made of silver, or of plated metal, and are provided with a chamber in which evaporation is carried on by means of a chemical mixture.

**WINE-GLASS**, *n.* [*wine* and *glass*.] A small glass in which wine is drunk.

**WINELESS**, *a.* Destitute of wine; as, *wineless life*.

**WINE-MAKING**, *n.* The process of manufacturing wines.

**WINE-MEASURE**, *n.* [*See MEASURE*.] An old English measure by which wines and other spirits were sold. In this measure the gallon contained 231 cubic inches, and was to the imperial standard gallon as 5 to 6 nearly.

**WINE-MERCHANT**, *n.* A merchant who deals in wines.

**WINE-PRESS**, *n.* [*wine* and *press*.] A place where grapes are pressed.

**WINE-STONE**, *n.* A deposit of crude tartar or *argal*, which settles on the sides and bottoms of wine casks.

**WING**, *n.* [*Sax. gehwing*; *Sw.* and *Dan. ving*.] The word signifies the side, end, or extremity. 1. The limb of a fowl by which it flies. In a few species of fowls, the wings do not enable them to fly; as is the case with the dodo, ostrich, great auk, and penguin; but in the two former, the wings assist the fowls in running.—2. The limb of an insect by which it flies.—3. Figuratively, care or protection.—4. In *bot.*, the side petal of a papilionaceous corolla, of which there are two; also, an appendage of seeds, by means of which they are wafted in the air and scattered; also, any membranous or leafy dilatation of a footstalk, or of the angles of a stem, branch, or flower-stalk, or of a calyx.—5. Flight; passage by the wing; as, to be on the wing; to take wing.—6. Means of flying; acceleration. Fear adds wings to flight.—7. Motive or incitement of flight. Then fiery expedition be my wing. *Shak.*

8. † A fan to winnow.—9. The flank or extreme body or part of an army.—10. Any side-piece.—11. In *gardening*, a side-shoot.—12. In *arch.*, a side building, less than the main edifice.—13. In *fort.*, the longer sides of horn-works, crown-works, &c.—14. In a *fleet*, the ships on the extremities, when ranged in a line, or when forming the two sides of a triangle.—15. In a *ship*, the wings are those parts of the hold and orlop deck, which are nearest the sides. The term *wing* is also applied to the projecting part of the deck of a steam vessel, before and abaft each of the paddle boxes.—16. In *Script.*, protection; generally in the plural; *Ps.* lxxiii; *Exod.* xix.—*On the wings of the wind*, with the utmost velocity; *Ps.* xviii.

**WING**, *v. t.* To furnish with wings; to enable to fly or to move with celerity. Who heaves old ocean, and who wings the storms. *Pope.*

2. To supply with side bodies; as, on

either side well winged.—3. To transport by flight.

1, an old turtle.

Will wing me to some wither'd bough.

*Shak.*  
Edge the keen sword, and wing th' unerring ball. *Trumbull.*

4. To wound in the wing. [*A term among sportsmen.*]—*To wing a flight*, to exert the power of flying.

**WING'-CASE**, } *n.* The case or shell  
**WING'-SHELL**, } which covers the wings of coleopterous insects; as the beetle, &c.

**WING-COVERING**, *a.* Covering the wings.

**WING'ED**, *pp.* Furnished with wings; transported by flying.—2. *a.* Having wings; as, a winged fowl; *Gen.* i.—3. Swift; rapid; as, with winged haste.—4. In *bot.*, alate; furnished with longitudinal membranous appendages, as a winged stalk or stem; or with downy or hairy appendages, as winged seeds.—*Winged petiole*, having a thin membrane or border on each side, or dilated on the sides.—*Winged leaf*, a pinnate leaf; a species of compound leaf, wherein a simple leaf has several leaflets fastened to each side of it.—5. In *her.*, represented with wings, or having wings of a different colour from the body.—6. Fanned with wings; swarming with birds.—7. Hurt or disabled in the wing; as, that bird cannot fly far, for it has been winged.

**WING'ED-PEA**, *n.* A plant.

**WING'ERS**, *n.* A name for casks stowed in the wings of a vessel.

**WING'-FOOTED**, *a.* [*wing* and *foot*.] Having wings attached to the feet; as, wing-footed mercury.—2. Swift; moving with rapidity; fleet.

**WING'LESS**, *a.* Having no wings; not able to ascend or fly.

**WING'LET**, *n.* A little wing.

**WING-STROKE**, *n.* A blow with a bird's expanded wing; as, a swan's wing-stroke may break a man's leg.

**WING'-SWIFT**, *a.* Swift on the wing; of rapid flight.

**WING'-TRANSOM**, *n.* In *ships*, the uppermost or longest transom, called also the *main-transom*. [*See TRANSOM*.]

**WING'Y**, *a.* Having wings; rapid; as, wingy speed.

**WINK**, *v. i.* [*Sax. wincian*; *G. winken*; *W. gwincan*, a wink; *gwincan*, to wriggle, to wink, to wince. *Wink* and *wince* are radically one word.] 1. To shut the eyes; to close the eyelids.

They are not blind, but they wink.

2. To close and open the eyelids.—3. To give a hint by a motion of the eyelids.

*Wink* at the footman to leave him without a plate. *Swift.*

4. To close the eyelids and exclude the light.

Or wink as cowards and afraid. *Prior.*

5. To be dim; as, a winking light.—*To wink at*, to connive at; to seem not to see; to tolerate; to overlook, as something not perfectly agreeable; as, to wink at faults.

**WINK**, *n.* The act of closing the eyelids. I lay awake and could not sleep a wink.

I could eclipse and cloud them with a wink. *Donne.*

2. A motion of the eye.—3. A hint given by shutting the eye with a significant cast.

**WINKER**, *n.* One who winks.—2. One of the blinds of a horse.

**WINK'ING**, *ppr.* Shutting the eyes; shutting and opening the eyelids; hinting by closing the eye; conniving at; overlooking.

**WINK'INGLY**, *adv.* With the eye almost closed.

**WIN'NER**, *n.* [*from win*.] One who gains by success in competition or contest.

**WIN'NING**, *ppr.* [*from win*.] Gaining by success in competition or contest.—2. *a.* Attracting; adapted to gain favour; charming; as, a winning address.

**WIN'NING**, *n.* The sum won or gained by success in competition or contest. [This word is seldom used except in its plural form, *winnings*.]

**WIN'NINGLY**, *adv.* In a winding manner.

**WIN'NOW**, *v. t.* [*L. evanno*, from *vannus*, a fan; *D.* and *G. wannen*; from the root of *fan* and *wind*. The *Sax.* has *windician*, to wind.] 1. To separate and drive off the chaff from grain by means of wind. Grain is winnowed by a fan, or by a machine, or by pouring it out of a vessel in a current of air.—2. To fan; to beat as with wings.—3. To examine; to sift for the purpose of separating falsehood from truth.

*Winnow* well this thought. *Dryden.*

4. To separate, as the bad from the good.

**WIN'NOW**, *v. i.* To separate chaff from corn.

*Winnow* not with every wind. *Ecclus.*

**WIN'NOWED**, *pp.* Separated from the chaff by wind; sifted; examined.

**WIN'NOWER**, *n.* One who winnows.

**WIN'NOWING**, *ppr.* Separating from the chaff by wind; examining.

**WIN'NOWING**, *n.* The act of separating the chaff from grain, by means of the wind, or by an artificial current of air.

**WIN'SOME**, *a.* Cheerful; merry; gay; comely; agreeable; engaging. [*Scotch.*]

**WIN'TER**, *n.* [*Sax. G. D. Sw.* and *Dan.* from *wind*, or its root; *Goth. wintrus*.] 1. The cold season of the year. Astronomically considered, winter commences in northern latitudes when the sun enters Capricorn, or at the solstice about the 21st of December, and ends at the equinox in March; but in ordinary discourse, the three winter months are December, January, and February. Our Saxon ancestors reckoned the years by winters; as, ten winters; thirty winters. In tropical climates, there are two winters annually; but they cannot be said to be cold. In the temperate and frigid climates, there is one winter only in the year.—2. The part of a printing press which sustains the carriage.

**WIN'TER**, *v. i.* To pass the winter. He wintered in Italy. Cattle winter well on good fodder.

**WIN'TER**, *v. t.* To feed or manage during the winter. To winter young cattle on hay is not profitable. Delicate plants must be wintered under cover.

**WIN'TER**, *a.* Pertaining to winter. [*See the following compounds.*]

**WINTERACEÆ**, *n.* A small nat. order of polypetalous exogenous plants. The plants of this order are small trees or shrubs, closely allied to Magnoliaceæ, from which they differ chiefly in their dotted leaves and aromatic qualities. About ten species have been enumerated, of which two inhabit New Holland, two are found in

the hotter parts of America, two in South America, two in North America, one in China and Japan, and one in New Zealand. *Illicium anisatum*, the Chinese anise-seed tree, yields the Chinese anise, which is frequently used to give an agreeable aromatic flavour to certain dishes, and also to flavour the liquor called *Anisette de Bordeaux*. *Illicium floridanum*, the Florida anise-seed tree, yields, by distillation, a volatile oil, which has a spicy aromatic taste and smell. *Drimys winteri* yields the winter's bark, which is known for its resemblance to that of cinnamon. *Drimys granatensis*, New Granada winter's bark, is a large tree, the bark of which is aromatic and stimulating, and is much used by the natives where it grows, both as a medicine, and for seasoning their food.

**WINTER-ACONITE**, *n.* A plant of the genus *Eranthis*, the *E. hiemalis*, a small stemless, tuberous plant, inhabiting shady places in the midland parts of Europe. It is cultivated in gardens on account of its cup-like flowers of bright yellow, which it puts forth in early spring. [See **ERANTHIS**.]

**WINTER-APPLE**, *n.* [winter and apple.] An apple that keeps well in winter.

**WINTER-BARLEY**, *n.* [winter and barley.] A kind of barley which is sowed in autumn.

**WINTER-BEATEN**, *a.* [winter and beat.] Harassed by the severe weather of winter.

**WINTER-BERRY**, *n.* [winter and berry.] The common name of North American plants of the genus *Prinos*. [See **PRINOS**.]

**WINTER-BLOOM**, *n.* [winter and bloom.] A plant of the genus *Azalea*.

**WINTER-CHERRY**, *n.* [winter and cherry.] A plant of the genus *Physalis*, the *P. alkekengi*, and its fruit, which is of the size of a cherry. The other species of the genus *Physalis* are also known by the name of winter-cherry. [See **PHYSALIS**.]

**WINTER-CITRON**, *n.* [winter and citron.] A sort of pear.

**WINTER-CRESS**, *n.* [winter and cress.] The common name of two British eruciferous plants of the genus *Barbarea*, formerly included in the genus *Erysimum*. Bitter winter-cress (*B. vulgaris*), called also yellow rocket, grows on the banks of ditches and rivers, and about hedges and walls. It is bitter and sharp to the taste, and is sometimes used as a salad.

**WINTER-CROP**, *n.* [winter and crop.] A crop which will bear the winter, or which may be converted into fodder during the winter.

**WINTERED**, *pp.* Kept through the winter; lived through the winter.

**WINTER-FALLOW**, *n.* [winter and fallow.] Ground that is fallowed in winter.

**WINTER-GARDEN**, *n.* [winter and garden.] An ornamental garden for winter.

**WINTER-GREEN**, *n.* [winter and green.] The common name of plants of the genus *Pyrola*, and of its allies. [See **PYROLA**.]

**WINTERING**, *ppr.* Passing the winter; keeping in winter.

**WINTERING**, *n.* The act of passing the winter; the act of keeping, feeding, or preserving during the winter.

**WINTER-KILL**, *v. t.* [winter and kill.] In America, to kill by means of the

weather in winter; as, to *winter-kill* wheat or clover.

**WINTER-LODGE**, } *n.* [winter  
**WINTER-LODGMET**, } and lodge.]

In bot., the hybernacle of a plant, which protects the embryo or future shoot from injuries during the winter. It is either a bud or a bulb.

**WINTERLY**, *a.* Such as is suitable to winter. [Little used.]

**WINTER-PEAR**, *n.* [winter and pear.] Any pear that keeps well in winter.

**WINTER-PROUD**, *a.* Too green and luxuriant in winter; applied to wheat. [Local.]

**WINTER-QUARTERS**, *n.* [winter and quarters.] The quarters of an army during the winter; a winter residence or station.

**WINTER-RIG**, *v. t.* [winter and rig.] To fallow or till in winter. [Local.]

**WINTER'S BARK**, *n.* [Capt. W. Winter, who first brought it to this country.] A plant of the nat. order *Winteraceæ*, and genus *Drimys*, a native of South America. *D. winteri*, or *Winteria aromatica*, of older botanists, true



Winter's Bark (*Drimys Winteri*).

winter's bark, is a native of the Straits of Magelhaens, where it grows to the height of from six to forty feet. The bark is of a pale greyish red colour externally, has an agreeable, pungent, aromatic taste, and contains an acid resin, an acid volatile oil and some tannin. It is an excellent aromatic, but not easily procured, other substances, particularly the bark of the *Canella alba*, being substituted for it.—*D. granatensis*, New Granada winter's bark, is inferior to the former in its aromatic properties, and grows in New Granada and Brazil, where it is indigenous, to about twenty feet high.

**WINTER-SOLSTICE**, *n.* [winter and solstice.] The solstice of the winter, which takes place when the sun enters Capricorn, December 21st. [See **SOLSTICE**.]

**WINTER-WEED**, *n.* The ivy-leaved speedwell.

**WINTERY**, *† a.* Pertaining to winter; suitable to winter; brumal; hyemal; cold; stormy.

**WINTLE**, *v. i.* To stagger; to reel; to roll or tumble gently over. [Scotch.]

**WINTLE**, *n.* A staggering motion; a gentle rolling tumble. [Scotch.]

**WINTRY**, instead of *Wintery*.

**WINY**, *a.* [from wine.] Having the taste or qualities of wine.

**WINZE**, *n.* In mining, a small shaft sunk from one level to another for the purpose of ventilation.

**WINZE**, *n.* A curse or imprecation. [Scotch.]

**WIPE**, *v. t.* [Sax. *wipian*.] 1. To rub with something soft for cleaning; to clean by rubbing; as, to *wipe* the hands or face with a towel; Luke vii.—2. To strike off gently.

Some nat'l tears they dropp'd but *wip'd* them soon. Milton.

3. To cleanse from evil practices or abuses; to overturn and destroy what is foul and hateful.

I will wipe Jerusalem as a man *wipeth* a dish; 2 Kings xxi.

4. To cheat; to defraud.—*To wipe away*, to cleanse by rubbing or tension; as, to *wipe away* a stain or reproach.—*To wipe off*, to clear away.—*Wipe off* this foul stain; *wipe off* the dust.—*To wipe out*, to efface; to obliterate. *Wipe out* the blot.

**WIPE**, *n.* The act of rubbing for the purpose of cleaning.—2. A blow; a stroke.—3. A gibe; a jeer; a severe sarcasm.—4. A bird. [Sw. *wipa*, the lapwing.]

**WIPE D**, *ppr.* Rubbed for cleaning; cleaned by rubbing; cleared away; effaced.

**WIPER**, *n.* One who wipes.—2. The instrument used for wiping.—3. *Wipers*, in machinery, are pieces projecting generally from horizontal axles, for the purpose of raising stampers, pounders, or pistons, in a vertical direction, and letting them fall by their own weight. They are employed in fulling mills, stamping mills, oil mills, powder mills, &c.

**WIPER-SHAFT**, *n.* In mech., a shaft carrying wipers for lifting, as in fulling mills.—2. In a marine steam-engine, the shaft on which the end of the slide-valve lever is fixed, and also the end of the gab-lever. It is also termed the *weigh-shaft*.

**WIPING**, *ppr.* Rubbing with a cloth or other soft thing for cleaning; clearing away; effacing.

**WIRE**, *n.* [Sw. *vir*; Ice. *wjir*.] A thread of metal; any metallic substance drawn to an even thread, or slender cylindrical rod. The term *wire* has also a plural signification, being frequently used, as well as the regular plural *wires*, to designate a number of metallic threads.

*Wire* is frequently drawn so fine as to be only the three-thousandth part of an inch in diameter. The metals most commonly drawn into wire are gold, silver, copper, and iron; but the finest wire is made from platina.—*Wire of Lapland*, a shining slender substance made from the sinews of the rein-deer, soaked in water, beaten, and spun into a sort of thread of great strength. These threads are dipped in melted tin, and drawn through a horn with a hole in it. The Laplanders use this wire in embroidering their clothes.

**WIRE**, *v. t.* To bind with wire; to apply wire to, as in bottling liquors.

**WIRE-DRAW**, *v. t.* [wire and draw.] To draw a metal into wire, which is done by drawing it through a hole in a plate of steel.—2. To draw into length.—3. To draw by art or violence.

My sense has been *wiredrawn* into biasphemy. Dryden.

4. To draw or spin out to great length and tenuity; as, to *wiredraw* an argument.

**WIREDRAWER**, *n.* One who draws metal into wire.

**WIREDRAWING**, *ppr.* Drawing a metal into wire.—2. Drawing to a great length or fineness.

**WIREDRAWING**, *n.* The act or art

of extending ductile metals into wire. The metal to be extended into wire is first hammered into a bar, and then it is passed successively through a series of holes in a hardened steel plate, successively diminishing in diameter, until the requisite degree of fineness is attained. Extremely fine wires of platinum, gold, or silver, are sometimes formed by drawing the metals through holes in a diamond or ruby.

**WIREDRAWN**, *pp.* Drawn into wire; drawn out to great length or fineness.

**WIRE-GAUZE**, *n.* A texture of finely interwoven wire, resembling gauze. It is employed for lanterns, sieves, flour-dressing machines, screens, window-blinds, covering safety-lamps, &c. It is also formed into dish-covers, baskets, and other useful and ornamental articles.

**WIRE-GRATE**, *n.* [*wire and grate.*] A grate or contrivance of fine wire work to keep insects out of vinerias, hot-houses, &c.

**WIRE-GRUB**, *n.* The wire-worm,—*which see.*

**WIRE-HEEL**, *n.* [*wire and heel.*] A defect and disease in the feet of a horse or other beast.

**WIRE-PULLER**, *n.* One who pulls the wires, as of a puppet; hence, one who operates by secret means; an intriguer.

**WIRE-PUL'LING**, *n.* The act of pulling the wires; as of a puppet; hence, secret influence or management; intrigue.

**WIRE-ROPE**, *n.* A rope formed of wire, usually iron-wire wound round a hempen core. Wire-ropes are found to be very superior in strength to those made of hemp, weight for weight.

**WIRE-WORM**, *n.* [*wire and worm.*] A name given by farmers to the larvæ or grubs, of several insects, which are species of the coleopterous genus *Elater*. They are very destructive to corn fields, and also to vegetables, by attacking the roots. *Hemerhipus segetis*, is another insect, the larva of which is called wire-worm. It destroys plants of all kinds.

**WIRY**, *a.* Made of wire; like wire. It is sometimes written *Wiery*.

**WIS**, *v. t. pret.* *Wist*. [*G. wissen*; *D. weeten*; *Dan. vider*; *Sw. veta*. This is the Sax. *witan*, to wit.] To think; to suppose; to imagine; to know.

**WIS'ALLS**, *n.* The leaves or tops of **WISOMES**, } carrots and parsneps. [*Local.*]

**WIS'ARD**. See **WIZARD**.

**WIS'DOM**, *n.* (*s* as *z*.) [*Sax. id.*; *wise and dom*; *G. weisheit*, [*wiseness*]; *D. wysheid*; *Sw. visdom and visheit*; *Dan. visdom or visdom*. See **WISE**. *Wisdom*, it seems, is from the Gothic dialect.] 1. The right use or exercise of knowledge; the choice of laudable ends, and of the best means to accomplish them. This is wisdom in *act*, *effect*, or *practice*. If wisdom is to be considered as a *faculty* of the mind, it is the faculty of discerning or judging what is most just, proper, and useful; and if it is to be considered as an *acquisition*, it is the knowledge and use of what is best, most just, most proper, most conducive to prosperity or happiness. Wisdom in the first sense, or *practical wisdom*, is nearly synonymous with *discretion*. It differs somewhat from *prudence*, in this respect; *prudence* is the exercise of sound judgment in avoiding evils; *wisdom* is the exercise of sound judg-

ment either in avoiding evils or attempting good. *Prudence* then is a species, of which *wisdom* is the genus.

*Wisdom* gained by experience, is of inestimable value. *Scott.*

It is hoped that our rulers will act with dignity and *wisdom*; that they will yield every thing to reason, and refuse every thing to force. *Amer.*

2. In *scripture*, human learning; erudition; knowledge of arts and sciences.

"Moses was learned in all the *wisdom* of the Egyptians; Acts vii.

3. Quickness of intellect; readiness of apprehension; dexterity in execution; as, the *wisdom* of Bezaleel and Aholiab; Exod. xxxi.—4. Natural instinct and sagacity; Job xxxix.—5. In *scripture theol.*, *wisdom* is true religion; godliness; piety; the knowledge and fear of God, and sincere and uniform obedience to his commands. This is the *wisdom* which is from above; Pa. xc.; Job xxviii.—6. Profitable words or doctrine; Ps. xxxvii.—*The wisdom of this world*, mere human erudition; or the carnal policy of men, their craft and artifices in promoting their temporal interests; called also *fleshly wisdom*; 1 Cor. ii.; 2 Cor. i.—*The wisdom of words*, artificial or affected eloquence; or learning displayed in teaching; 1 Cor. i. ii.

**WISE**, *a.* (*s* as *z*.) [*Sax. wis, wise*; *G. weise*; *D. wys*; *Sw. vis*; *Dan. viis*; *Sax. wissan*, *G. wissen*, to know; *Sans. vid*. This in Dutch, is *veeten*, to know, which is the Goth. *witan*, *Sax. witan*, *Eng. to wit*, perhaps *Gr. wida*. So that *wise, wit, weet, wot*, are all from one root, or dialectical forms of the same word; *Ir. fois, feas*, knowledge; *W. guys, gwyz*, *Sans. wida*, intelligence. In general, the radical sense of *know*, is to reach or to hold, from extension, stretching. In this case, it may be to show, to disclose, from a like sense; for in *Sw. visa*, *Dan. viser*, *G. weisen*, *D. wysen*, is to show. In this case, *L. video, visum*, which seems to be connected with this word, may coincide in origin with *wide*. *Wistful*, attentive, eager, is from reaching forward.] 1. Properly, having knowledge; hence, having the power of discerning and judging correctly, or of discriminating between what is true and what is false; between what is fit and proper and what is improper; as, a *wise* prince; a *wise* magistrate. Solomon was deemed the *wisest* man. But a man may be *speculatively* and not *practically* wise. Hence,—2. Discreet and judicious in the use or application of knowledge; choosing laudable ends, and the best means to accomplish them. This is to be *practically* wise; Gen. xli.—3. Skillful; dextrous.

They are *wise* to do evil, but to do good they have no knowledge; Jer. iv.

4. Learned; knowing; as, the *wise* and the unwise; Rom. i.—5. Skilled in arts, science, philosophy, or in magic and divination; 2 Sam. xiv.—6. Godly; pious; Prov. xiii.

The holy Scriptures, which are able to make thee *wise* to salvation; 2 Tim. lii.

7. Skilled in hidden arts; *a sense somewhat ironical*; as, the *wise* woman of Brainford.—8. Dictated or guided by wisdom; containing wisdom; judicious; well adapted to produce good effects; *applicable to things*; as, a *wise* saying; a *wise* scheme or plan; *wise* conduct or management; a *wise* determination.

—9. Becoming a wise man; grave; discreet; as, *wise* deportment.

**WISE**, *n.* (*s* as *z*.) [*Sax. wise*; *G. weise*; *D. wys*; *Fr. guise*; *It. guisa*; *Arm. gwis.*] Manner; way of being or acting.

This song she sings in most commanding *wise*. *Sidney.*

In fittest *wise*. *Spenser.*

In the foregoing form this word is obsolete. The use of it is now very limited. It is common in the following phrases.—1. In *any wise*.

If he that sanctified the field will in *any wise* redeem it; Lev. xxvii.

Fret not thyself in *any wise*; Ps. xxxvii.

2. On *this wise*.

On *this wise* ye shall bless the children of Israel; Numb. vi.

3. In *no wise*.

He shall in *no wise* lose his reward; Matth. x.

It is used in composition, as in *like-wise*, *otherwise*, *lengthwise*, &c. By mistake, *ways* is often used for it; as, *lengthways*, for *lengthwise*.

**WISEACRE**, *n.* [*G. weise*, *wise*, and *sagen*, to say; *G. weissager*, a foreteller. The proper English word would be *wise-sayer*.] One who makes pretensions to great wisdom; hence, in *contempt or irony*, a fool; a simpleton; a dunce.

**WISE-HEARTED**, *a.* [*wise and heart.*] *Wise*; knowing; skilful; Exod. xxviii.

**WISELING**, *n.* One who pretends to be wise.

**WISELY**, *adv.* Prudently; judiciously; discreetly; with wisdom; Prov. xvi. xxi.—2. Craftily; with art or stratagem.

Let us deal *wisely* with them; Exod. i.

**WISENESS**, *n.* Wisdom.

**WISE-SAYER**, *n.* [*G. weissager*, a foreteller.] 1. A foreteller; one who is noted for predicting the weather.—2. A wiseacre,—*which see.*

**WISH**, *v. i.* [*Sax. Wiscan*; *Cimbriæ, oska*. In all the other Teutonic and Gothic dialects, the corresponding word is written with *n*; *D. wenschen*; *G. wunschen*; *Dan. ønsker*; *Sw. önska*. This is probably the same word.] 1. To have a desire, or strong desire, either for what is or is not supposed to be obtainable. It usually expresses less than *long*; but sometimes it denotes to long or wish earnestly. We often *wish* for what is not obtainable.

This is as good an argument as an antiquary could *wish* for. *Arbutnot.*

They have more than heart could *wish*; Ps. lxxiii.

I *wish* above all things that thou mayest prosper; 3 John 2.

They cast four anchors out of the stern, and *wished* for the day; Acts xxvii.

2. To be disposed or inclined; as, to *wish* well to another's affairs.—3. It sometimes partakes of hope or fear. I *wish* the event may prove fortunate, or less calamitous than we apprehend.

**WISH**, *v. t.* To desire. I *wish* your prosperity.

Let them be driven backward and put to shame, that *wish* me evil; Ps. xl.

2. To long for; to desire eagerly or ardently. It has this sense when expressed with emphasis.—3. To recommend by wishing.

I would not *wish* them to a fairer death. *Shak.*

4. To imprecate; as, to *wish* curses on an enemy.—5. To ask; to express desire.

WISH, *n.* Desire; sometimes eager desire; Job xxxiii.—2. Desire expressed.

Blister'd be thy tongue

For such a wish. *Shak.*

3. Thing desired. He has his wish.

The difference between *wish* and *desire* seems to be, that *desire* is directed to what is obtainable, and a *wish* may be directed to what is obtainable or not. *Kames.*

WISH'ED, *pp.* Desired; or ardently desired.

WISH'ER, *n.* One who desires; one who expresses a wish.

WISH'FUL, *a.* Having desire, or ardent desire.—2. Showing desire; as, *wishful eyes*.—3. Desirable; exciting wishes. [*Bad.*]

WISH'FULLY, *adv.* With desire or ardent desire.—2. With the show of desiring.

WISH'FULNESS, *n.* The state of showing or having desire.

WISHING, *ppr.* Desiring.

WISH'LY, *adv.* With longing; with desire; wishfully. [*Local.*]

WISH-WASH, *n.* Any sort of weak, thin drink.

WISH'Y-WASH'Y, *a.* Resembling wish-wash; very thin and weak; diluted; feeble; not solid; as, a *wishy-washy* speech. [*See WASHY*, from which this word is formed by reduplication.] [*Colloq.*]

WISK'ET, *n.* A basket; a whisket. [*Local.*]

WISP, *n.* [*Dan. vish*, a wisp, a whisk; *visher*, to whisk, to rub or wipe; *G.* and *D. wisch*.] A small bundle of straw or other like substance; as, a *wisp* of straw; a *wisp* of hay; a *wisp* of herbs.

WIST,† *pret.* of *Wis*.

WISTA'RIA, *n.* A genus of plants, nat. order Leguminosæ. The species are deciduous twining shrubs, natives of China and North America. Several (as *Wistaria chinensis*) have been introduced into England, and, when in flower, they form the handsomest ornaments of the garden.

WIST'FUL, *a.* [*from wist*. The sense is stretching or reaching toward.] Full of thoughts; earnest; attentive; eager. 2. Wishful.

Why dost thou so wistful seem? *Gay.*

WIST'FULLY, *adv.* Attentively; earnestly.

WIST'TIT, *n.* The striated monkey; a small species of monkey from South



Wistit (*Hapales jacchus*).

America, with sharp claws and squirrel-like habits, the *ovistiti* of Buffon; and the *hapales jacchus* of Illiger.

WIST'LY,† *adv.* Earnestly.

WISTONWITH, *n.* The *Arctomys ludovicianus*, a rodent quadruped of America, of a dark-brown colour,

found on the banks of the Missouri and its tributaries; called also *bark-*



Wistonwith (*Arctomys ludovicianus*).

*ing squirrel*, *burrowing squirrel*, and *prairie dog*.

WIT, *v. i.* [*Sax. witan*, *Goth. witan*, *D. weeten*, *G. wissen*, to know; *Sans. vid. See WISE.*] To know; to be informed; to be known. This verb is used only in the infinitive, to *wit*, when it is an adverbial phrase, signifying, namely, that is to say. [*L. videlicet*, i. e. *videre licet*.] In *law*, it is used as a formal expression, by which a county or other district is called upon to *know* or to *witness* the legal setting forth of something that follows. [*See VIDELICET.*]

WIT, *n.* [*Sax. wit* or *ge-wit*; *G. witz*; *Dan. vid. See the verb and WISE.*]—1. Primarily, the intellect; the understanding or mental powers collectively.

Wit puts in practice what the wit deviseth. *Davies.*

For wit and power their last endeavours bend *Dryden.*

2. The association of ideas in a manner natural, but unusual and striking, so as to produce surprise joined with pleasure. Wit is defined

What oft was thought, but ne'er so well express'd. *Pope.*

Wit consists in assembling and putting together with quickness, ideas in which can be found resemblance and congruity, by which to make up pleasant pictures and agreeable visions in the fancy. *Locke.*

Wit consists chiefly in joining things by distant and fanciful relations, which surprise us because they are unexpected.

*Kames.*

Wit is a propriety of thoughts and words; or in other terms, thoughts and words elegantly adapted to the subject. *Dryden.*

3. The faculty of associating ideas in a new and unexpected manner.—4. A man of genius; as, the age of Addison abounded with wits.

A wit herself, Amelia weds a wit. *Young.*

5. A man of fancy or wit.

Intemperate wits will spare neither friend nor foe. *L'Estrange.*

6. Sense; judgment.

He wants not wit the danger to decline. *Dryden.*

7. Faculty of the mind.—8. Wits, in the plural, soundness of mind; intellect not disordered; sound mind. No man in his wits would venture on such an expedition. Have you lost your wits? Is he out of his wits?—9. Power of invention; contrivance; ingenuity. He was at his wits' end.—10. Among *phrenologists*, the faculty which produces the sentiment of the ludicrous; and gives the tendency to view objects in that light. When combined with *destructiveness* it produces satire, and

when combined with *secretiveness* it produces humour. Its organ is situated at the side of the upper part of the forehead, between causality and ideality.

*Note.*—It is difficult to give any strict definition of the term *wit*, its precise boundaries being still too unsettled. It has passed through a greater variety of significations in the course of the last two centuries than most other terms in the English language. Originally, *wit* signified wisdom; and anciently, a man of *witte* was a wise man. In the reign of Elizabeth, a man of pregnant *wit*, or of great *wit*, was a man of vast judgment. In the reign of James I. *wit* was used to signify the intellectual faculties or mental powers collectively. In the time of Cowley it came to signify a superior understanding, and more particularly a quick and brilliant reason. By Dryden it is used as nearly synonymous with talent or ability. According to Locke, it consists in quickness of fancy and imagination. Pope defined *wit* to be a quick conception and an easy delivery; according to which, a man of *wit*, or a *wit*, is a man of brilliant fancy; a man of genius. At present, *wit* is used to designate a peculiar faculty of the mind, connected with the more comprehensive faculty of the imagination; and also the effect produced by this faculty, which consists in the display of remote resemblances between dissimilar objects, or an unexpected combination of remote resemblances; in the exhibition or perception of ludicrous points of analogy or resemblance among things in other respects dissimilar. Hence, a man of *wit*, or a *wit*, is considered to be a man in whom a readiness for such exercise of the mind is remarkable. It is evident that *wit* excites in the mind an agreeable surprise, and that arising, not from any thing marvellous in the subject, but solely from the imagery employed or the strange assemblage of related ideas presented to the mind. This end is effected, 1, by debasing things pompous or seemingly grave; 2, by aggrandizing things little and frivolous; or, 3, by setting ordinary objects in a particular and uncommon point of view, by means not only remote, but apparently contrary. Hence arise a great many kinds of wit. Wit is often joined with humour, but not necessarily so; it often displays itself in the keenest satire; but when it is not kept under proper control, or when it becomes the habitual exercise of the mind, it is apt to impair the nobler powers of the understanding, to chill the feelings, to check friendly and social intercourse, and to break down those barriers which have been established by courtesy. At the same time, when kept within its proper sphere, and judiciously used, it may be rendered very effective in attacking pedantry, pretension, or folly, and may also be employed as a powerful weapon against error.

WITCH, *n.* [*Sax. wicca. See WICKED.*]

1. A woman supposed to have formed a compact with the devil, or with evil spirits, and by their means to operate supernaturally; one who practises sorcery or enchantment.—2. A woman who is given to unlawful arts.—3.† [*Sax. wic*.] A winding, sinuous bank.—4. A piece of conical paper which is placed in a vessel of lard, and being lighted,

answers the purpose of a taper. [Qu. *witch*. *Local*.]

**WITCH**, *v. t.* To bewitch; to fascinate; to enchant.

I'll witch sweet ladies with my words and looks. *Shak.*

**WITCH'GRÄFT**, *n* [*witch* and *craft*.]

The practices of witches; sorcery; enchantments; intercourse with the devil; a supernatural power, which persons were formerly supposed to obtain possession of by entering into compact with the devil. Indeed it was fully believed that they gave themselves up to him, body and soul, while he engaged that they should want for nothing, and be able to assume whatever shape they pleased, to visit and torment their enemies, and accomplish their infernal purposes. As soon as the bargain was concluded, the devil was said to deliver to the witch an imp or familiar spirit, to be ready at call, and to do whatever it was directed. By the aid of this imp and the devil together, the witch, who was almost always an old woman, was enabled to transport herself through the air on a broomstick or a spit, and to transform herself into various shapes, particularly those of cats and hares; to inflict diseases on whomsoever she pleased, and to punish her enemies in a variety of ways. The belief in witchcraft is very ancient. It was universally believed in Europe till the 16th century, and even maintained its ground with tolerable firmness till the middle of the 17th century. Vast numbers of reputed witches were condemned to be burned every year, so that in England alone it is computed that no fewer than 30,000 of them suffered at the stake.—2. Power more than natural.

He hath a *witchcraft*

Over the king in 's tongue. *Shak.*

**WITCH'ED**, *pp.* Bewitched; fascinated. *WITCH'ELM*. See *WYCH ELM*.

**WITCH'ERY**, *n.* Sorcery; enchantment.—2. Fascination.

**WITCH'HAZEL**. See *WYCH HAZEL*.

**WITCHING**, *pp.* Fascinating; enchanting.

**WITCHING**, *a.* Bewitching; suited to enchantment or witchcraft; as, the *witching* time of night.

**WITCH'RIDDEN**, *a.* Ridden by witches.

**WITCH TREE**, *n.* The roan-tree or mountain-ash; *Pyrus aucuparia*.

**WIT'-CRAÇKER**, *† n.* [*wit* and *cracker*.] One who breaks jests; a joker.

**WIT'-CRÄFT**, *† n.* [*wit* and *craft*.] Contrivance; invention.

**WITE**, *v. t.* [Sax. *witan*; the root of *twit*.] To reproach; to blame. [*Scotch*.]

**WITE**, *n.* Blame; reproach. [*Scotch*.]

**WITLESS**, *a.* Blameless. [*Scotch*.]

**WITENAG'EMOTE**, *n.* [Sax. *witan*, to know, and *gemoth*, an assembly.] Literally, an assembly of wise men. Among the *Anglo-Saxons*, the great national council or parliament, consisting of nobles, or chiefs, the largest landholders, and the principal ecclesiastics. The meetings of this council were frequent; they formed the highest court of judicature in the kingdom; they were summoned by the king in any political emergency; their concurrence was necessary to give validity to laws, and treaties with foreign states were submitted to their approval. They had even power to elect the king, and if the sceptre descended

in his race, it was by means of the formal recognition of the new king by the nobles, bishops, &c., in an assembly convened for the purpose.

**WIT'-FISH**, *n.* [whitefish; D. *witwisch*.] An East Indian fish of the size of a whiting; also, another East Indian fish, the *Albula Indica* of Ray.

**WITH**, *prep.* [Sax. *with*, near or against; Goth. *ga-withan*, to join. The primary sense is to press, or to meet, to unite; hence in composition it denotes opposition, as in *withstand* and *withdraw*; hence against, Sax. *wither*, G. *wider*.] 1. By, noting cause, instrument, or means. We are distressed *with* pain; we are elevated *with* joy. *With* study men become learned and respectable. Fire is extinguished *with* water.—2. On the side of, noting friendship or favour.

Fear not, for I am *with* thee; Gen. xxvi.

3. In opposition to; in competition or contest; as, to struggle *with* adversity. The champions fought *with* each other an hour. He will lie *with* any man living.—4. Noting comparison. The fact you mention compares well *with* another I have witnessed.—5. In company. The gentlemen travelled *with* me from Paris to Rome.—6. In the society of. There is no living *with* such neighbours.—7. In connection, or in appendage. He gave me the bible, and *with* it the warmest expressions of affection.—8. In mutual dealing or intercourse.

I will buy *with* you, sell *with* you.

9. Noting confidence. I will trust you *with* the secret.—10. In partnership. He shares the profits *with* the other partners. I will share *with* you the pleasures and the pains.—11. Noting connection.

Nor twist our fortunes *with* your sinking fate. *Dryden*.

12. Immediately after.

*With* this he pointed to his face. *Dryden*.

13. Among. I left the assembly *with* the last.

Tragedy was originally *with* the ancients a piece of religious worship. *Rymer*.

14. Upon.

Such arguments had invincible force *with* those pagan philosophers. *Adair*.

15. In consent, noting parity of state. See I where on earth the flow'ry glories lie, *With* her they flourish'd, and *with* her they die. *Pope*.

*With* and *by* are closely allied in many of their uses, and it is not easy to lay down a rule by which their uses may be distinguished. It is observed by Johnson that *with* seems rather to denote an instrument, and *by* a cause; as, he killed an enemy *with* a sword, but he died *by* an arrow. But this rule is not always observed. *With*, in composition, signifies sometimes opposition, privation; or separation, departure.

**WITHAL**, *adv.* (withal'.) [*with* and *all*.] *With* the rest; together with; likewise; at the same time.

If you choose that, then I am yours *withal*. *Shak.*

How modest in exception, and *withal* How terrible in constant resolution! *Shak.*

2. It was formerly used as a preposition instead of *with*, and was placed after the objective case; as, the most perfect rule of life that ever the world was acquainted *withal*.

**WITHAMITE**, *n.* A variety of epidote

found at Glencoe in Scotland. It occurs crystallized, and is of vitreous lustre, and red or yellow colour.

**WITHDRAW'**, *v. t.* [*with* and *draw*.] To take back; to take from; to be-leave. [*With* here has the sense of *contrary*; to *withdraw* is to draw the *contrary* way. See **WITHR**.]

It is impossible that God should *withdraw* his presence from any thing. *Hooker*. We say, to *withdraw* capital from a bank or stock in trade, to *withdraw* aid or assistance.—2. To recall; to cause to retire or leave; to call back or away. It is reported that Russia has *withdrawn* her troops from the Caucasus.

**WITHDRAW'**, *v. i.* To retire; to retreat; to quit a company or place. We *withdrew* from the company at ten o'clock.

She from her husband soft *withdrew*.

**WITHDRAW'AL**, *n.* Act of withdrawing or taking back; a recalling.

**WITHDRAW'ER**, *n.* One who withdraws.

**WITHDRAW'ING**, *pp.* Taking back; recalling; retiring.

**WITHDRAW'ING-ROOM**, *n.* A room behind another room for retirement. It is now contracted to *drawing-room*,—*which* see.

**WITHDRAW'MENT**, *n.* The act of withdrawing or taking back; a recalling.

Their *withdrawment* from the British and Foreign Bible Society, would tend to paralyze their exertions. *Simeon*

**WITHDRAWN'**, *pp.* of **Withdraw**. Recalled; taken back.

**WITHE**, *n.* [Sax. *withig*; G. *weide*, a *WITIL*, } willow; L. *vitis*, *vitex*.] 1. A willow twig.—2. A band consisting of a twig, or twigs twisted.—3. In *arch*, the partition between two chimney flues.

**WITH'ED**, *a.* Bound with a wither.

**WITHER**, *v. i.* [*W. gweiz*, dried; *withered*; *gwezoni*, to wither; Sax. *gewitherod*, *withered*; Ir. *fothadh*.]

1. To fade; to lose its native freshness; to become sapless; to dry.

It shall *wither* in all the leaves of her spring; Ezek. xvii.

2. To waste; to pine away; as, animal bodies; as a *withered* hand; Matth. xii.

—3. To lose or want animal moisture. Now *scorn* in love, now *with'ring* in the grave. *Dryden*.

**WITHER**, *v. t.* To cause to fade and become dry; as, the sun *withereth* the grass; James i.—2. To cause to shrink, wrinkle, and decay, for want of animal moisture.

Age cannot *wither* her. *Shak.*

**WITHER-BAND**, *n.* [*withers* and *band*.] A piece of iron laid under a saddle near a horse's withers, to strengthen the bow.

**WITHER'ED**, *pp.* Faded; dried; shrunk.

**WITHER'EDNESS**, *n.* The state of being withered.

**WITHER'ING**, *pp.* Fading; becoming dry.

**WITHER'INGLY**, *adv.* In a manner tending to wither or cause to shrink.

**WITHERITE**, *n.* In *mineral*, a native carbonate of baryta, first discovered by Dr. Withering, at Anglesark in Lancashire. It is white, gray, or yellow. It is also called *Barolite*,—*which* see.

**WITHERNAM**, *n.* [Sax. *wither*, against, and *naman* to take.] In *withernam*, in

law, a second or reciprocal distress, in lieu of a first distress which has been elozined; reprisal.

**WITHERS**, *n.* [This seems to signify a joining, from the root of *with*.] The juncture of the shoulder bones of a horse, at the bottom of the neck and mane, towards the upper part of the shoulder.

**WITHER-WRUNG**, *a.* Injured or hurt in the withers, as, a horse.

**WITHHELD**, *pret.* and *pp.* of *Withhold*.

**WITHHOLD**, *v. t. pret.* and *pp.* *Withheld*. [*with* and *hold*.] 1. To hold back; to restrain; to keep from action. *Withhold...* your hasty hand. *Spenser*. If our passions may be *withheld*. *Kettlewell*.

2. To retain; to keep back; not to grant; as, to *withhold* assent to a proposition. The sun does not *withhold* his light.

**WITHHOLDEN**, *pp.* The old participle of *withhold*; now obsolete. We use *withheld*.

**WITHHOLDER**, *n.* One that withholds.

**WITHHOLDING**, *ppr.* Holding back; restraining; retaining; not granting.

**WITHHOLDMENT**, *n.* Act of withholding.

**WITHIN**, *prep.* [*Sax. withiman*.] 1. In as opposed to something out; in the inner part; as, the space *within* the walls of a house; a man contented and happy *within* himself.—2. In the limits or compass of; not beyond; used of place and time. The object is *within* my sight; *within* the knowledge of the present generation; *within* a month or a year.—3. Not reaching to any thing external.

Were every action concluded *within* itself. *Locke*.

4. In the compass of; not longer ago than.

*Within* these five hours Hastings liv'd untainted. *Shak*.

5. Not later than; as, *within* five days from this time, it will be fair weather.—6. In the reach of.

Both he and she are still *within* my pow'r. *Dryden*.

7. Not exceeding. Keep your expenses *within* your income.—8. In the heart or confidence of. [*Inlegant*.]—9. In the house; in any inclosure.

**WITHIN**, *adv.* In the inner part; inwardly; internally.

The wound festers *within*. *Carew*.

2. In the mind.

Ills from *within* thy reason must prevent. *Dryden*.

**WITHINSIDE**, *adv.* [*within* and *side*.] In the inner parts. [*Bad*.]

**WITHOUT**, *prep.* [*Sax. withutan*; *with* and *out*.] 1. Not with; as, *without* success.—2. In a state of destitution or absence from.

There is no living with thee nor *without* thee. *Tatler*.

3. In a state of not having, or of destitution. How many live all their life *without* virtue, and *without* peace of conscience.—4. Beyond; not within.

Eternity, before the world and after, is *without* our reach. *Burnet*.

5. Supposing the negation or omission of.

*Without* the separation of the two monarchies, the most advantageous terms from the French must end in our destruction. *Addison*.

6. Independent of; not by the use of. Men like to live *without* labour.

Wise men will do it *without* a law. *Bacon*.

7. On the outside of; as, *without* the gate; *without* doors.—8. With exemption from. That event cannot happen *without* great damage to our interests.—9. Unless; except.—*Without*, when it precedes a sentence or member of a sentence, has been called a conjunction. This is a mistake. "You will not enjoy health, *without* you use much exercise." In this sentence, *without* is a preposition still, but followed by a member of a sentence, instead of a single noun. It has no property of a connective or conjunction, and does not fall within the definition. You will not enjoy health, this fact following being removed, or not taking place; *you use exercise*. This use of *without*, is nearly superseded by *unless* and *except*, among good writers and speakers; but is common in popular discourse or parlance.

**WITHOUT**, *adv.* Not on the inside; not within.

These were from *without* the growing miseries. *Milton*.

2. Out of doors.—3. Externally; not in the mind.

*Without* were fightings, within were fears; 2 Cor. vii.

**WITHOUT-DOOR**, *a.* Being out of door; exterior.

**WITHOUTEN**, for *Withoutan*, the Saxon word, is obsolete.

**WITHSTAND**, *v. t.* [*with* and *stand*. See *STAND*.] To oppose; to resist, either with physical or moral force; as, to *withstand* the attack of troops; to *withstand* eloquence or arguments.

When Peter was come to Antioch, I *withstood* him to his face; Gal. ii.

**WITHSTANDER**, *n.* One that opposes; an opponent; a resisting power.

**WITHSTANDING**, *ppr.* Opposing; making resistance.

**WITHSTOOD**, *pp.* Opposed; resisted.

**WITH-VINE**, } *n.* A local name for  
**WITH-WINE**, } the couch-grass.

**WITHWIND**, *n.* A plant. [*L. convolvulus*.]

**WITHY**, *n.* [*Sax. withip*.] A large species of willow.—2. A withe; a twig; an osier.

**WITHY**, *a.* Made of withes; like a withe; flexible and tough.

**WITLESS**, *a.* [*wit* and *less*.] Destitute of wit or understanding; inconsiderate; wanting thought; as, a *witless* swain; *witless* youth.—2. Indiscreet; not under the guidance of judgment; as, *without* bravery.

**WITLESSLY**, *adv.* Without the exercise of judgment.

**WITLESSNESS**, *n.* Want of judgment.

**WITLING**, *n.* [*dim.* from *wit*.] A person who has little wit or understanding; a pretender to wit or smartness.

A beau and *witling* perish'd in the throng. *Pope*.

**WITNESS**, *n.* [*Sax. witnessse*, from *witan*, to know.] 1. Testimony; attestation of a fact or event.

If I bear *witness* of myself, my *witness* is not true; John v.

2. That which furnishes evidence or proof.

Laban said, This heap is a *witness* between me and thee this day; Gen. xxxi.

3. A person who knows or sees any thing; one personally present; as, he was *witness*; he was an eye-*witness*; 1 Pet. v.

Upon my looking round, I was *witness* to appearances which filled me with melancholy and regret. *Rob. Hall*, 2, 349.

4. One who sees the execution of an instrument, and subscribes it for the purpose of confirming its authenticity by his testimony.—5. One who gives testimony.—6. In law, a person who gives testimony or evidence in a judicial proceeding, and is sworn to "speak the truth, the whole truth, and nothing but the truth." Persons convicted of infamous crimes, persons outlawed for criminal offences, idiots, madmen, and children, those who have no idea of a God or a future state, parties interested in the event of the verdict or who are parties to the suit, are disqualified or rendered incompetent as witnesses.—*With a witness*, effectually; to a great degree; with great force, so as to leave some mark as a testimony behind. He struck *with a witness*. [*Low*.]

**WITNESS**, *v. t.* To see or know by personal presence; to be a witness of; to observe.

Every one has *witnessed* the effects of the voltaic fluid. *Good, Lect. x.*

Gen. Washington did not live to *witness* the restoration of peace. *Marshall*.

This is but a faint sketch of the incalculable calamities and horrors we must expect, should we ever *witness* the triumphs of modern infidelity. *Rob. Hall*.

We have *witnessed* all the varieties moulded to such a perfect accommodation. *Bridg. Treatise*.

Angels that make thy church their care, Shall *witness* my devotion there. *Watts*, Ps. cxxxviii.

We have lived to *witness* that surprising paradox. *Hannah More*.

2. To attest; to give testimony to; to testify to something.

Behold, how many things they *witness* against thee; Mark xv.

3. To see the execution of an instrument, and subscribe it for the purpose of establishing its authenticity; as, to *witness* a bond or a deed. In the *imperative mode*, see, in evidence or proof; as, *witness* the habeas corpus, the independence of judges, &c.

**WITNESS**, *v. i.* To bear testimony.

The men of Belia *witnessed* against him, even against Naboth; 1 Kings xxi.

2. To give evidence.

The shew of their countenance doth *witness* against them; Isa. iii.

**WITNESSED**, *pp.* Seen in person; testified; subscribed by persons present; as, a deed *witnessed* by two persons.

**WITNESSER**, *n.* One who gives or bears testimony.

**WITNESSING**, *ppr.* Seeing in person; bearing testimony; giving evidence.

**WIT-SNAPPER**, } *n.* [*wit* and *snap*.]  
One who affects repartee.

**WIT-STARVED**, *a.* Barren of wit; destitute of genius.

**WITTED**, *a.* Having wit or understanding; as, a quick *witted* boy.

**WITENA-GEMOTE**. See **WITENAGEMOTE**.

**WITVICISM**, *n.* [*from wit*.] A sentence or phrase which is affectively witty; a witty remark; a low kind of wit.

He is full of conceptions, points of epigram, and *witvicisms*; all which are below the dignity of heroic verse. *Addison*.

**WIT'ILY**, *adv.* [*from wit*.] With wit; with a delicate turn or phrase, or with an ingenious association of ideas.—2. Ingeniously; cunningly; artfully.

Who his own harm so *witilly* contrives. *Dryden*.

**WIT'TINESS**, *n.* [*from witty*.] The quality of being witty.



WIT'TINGLY, *adv.* [See WIT.] Knowingly; with knowledge; by design.

He knowingly and *wittingly* brought evil into the world. *More.*

WIT'TOL, *n.* [Sax. from *witan*, to know.] A man who knows his wife's infidelity and submits to it; a tame cuckold.

WIT'TOLLY, *adv.* Like a tame cuckold. WIT'TY, *a.* [from *wit*.] Possessed of wit; full of wit; as, a *witty* poet.—2. † Imaginative; judicious; ingenious; inventive.—3. Sarcastic; full of taunts.

Honeycomb was unmercifully *witty* upon the women. *Spectator.*

WIT'WALL, *n.* A bird, the golden oriole; also the great spotted woodpecker.

WIT'WORM, † *n.* [*wit* and *worm*.] One that feeds on wit.

WIVE, † *v. i.* [from *wife*.] To marry.

WIVE, † *v. t.* To match to a wife.—2. To take for a wife.

WIVEHOOD, † *n.* Behaviour becoming a wife. [It should be *wifehood*.]

WIVELESS, *a.* Not having a wife. [It should be *wifeless*.]

WIVELY, *a.* Pertaining to a wife. [It should be *wifely*.]

WIVER, } *n.* A kind of heraldic WIVERN, } dragon. [See WYVERN.]

WIVES, *plur.* of *Wife*.

WIZ'ARD, *n.* [from *wise*.] A conjurer; an enchanter; a sorcerer; a male witch; Lev. xx.

The wily *wizard* must be caught. *Dryden.*

2. † A wise or learned man. This is the original meaning of the term.

WIZ'ARD, *a.* Enchanting; charming.—2. Haunted by wizards.

WIZ'ARDRY, *n.* The art or practices of wizards; sorcery.

WIZ'EN, } *v. i.* [Sax. *wisnian*, weos- WIZ'ZEN, } *nian*.] To wither; to become dry and hard. [Scotch.]

WIZ'EN, } *v. t.* To wither; to cause WIZ'ZEN, } to fade; to make dry. [Scotch.]

WIZ'EN, } *n.* The throat; the wind- WIZ'ZEN, } pipe; the weasand. [Scotch.]

WOAD, *n.* [Sax. *wad* or *waad*; G. *waid*, *waid*; Fr. *guede*. Supposed to be derived from Guadum, now Gualdo, the name of a town in the Roman states, where it was long ago extensively culti-

great extent in Britain, on account of the blue dye extracted from it. It is now, however, nearly superseded by indigo, which gives a stronger and finer blue. It is still cultivated to a considerable extent in the south of France and Flanders, and the dye which it furnishes is said to improve the quality and colour of indigo, when mixed with it in a certain proportion. The colouring matter is obtained from the leaves of the plant. These are first dried, then ground or bruised by machinery, and formed into a sort of paste. This paste is formed into balls, which are allowed to ferment and fall into a dry powder, which is sold to the dyer. The ancient Britons are said to have tintured their bodies with the dye procured from the woad plant.—*Wild woad*, *weld*, or *wold*, is the *Reseda luteola*, a British plant, which yields a beautiful yellow dye. [See *RESEDA*.]

WOAD-MILL, *n.* A mill for bruising and preparing woad.

WOAD WAXEN, *n.* A British plant of the genus *Genista*, the *G. tinctoria*, also called dyer's green-weed. It yields a good yellow colour. [See *GENISTA*.]

WODA'NIUM, *n.* A metal of a bronze-yellow colour, found in a species of pyrites in Hungary.

WODE, *a.* Mad. [Local.]

WODEN, *n.* An Anglo-Saxon deity, supposed to correspond to the Mercury of the Greeks and Romans. From Woden, Wednesday derives its name.

WOE, *n.* [Sax. *wa*; L. *væ*; Gr. *ωω*.] *W. gwæ*; G. *wch*; D. *wee*; Sw. *ve*.]

1. Grief; sorrow; misery; a heavy calamity.

One *woe* is past; and behold there come two *woes* more hereafter; Rev. ix.

They weep each other's *woe*. *Pope.*

2. A curse.

Can there be a *woe* or curse in all the stores of vengeance, equal to the malignity of such a practice? *South.*

3. *Woe* is used in denunciation, and in exclamations of sorrow.

*Woe* is me; for I am undone; Isa. vi.

This is properly the Saxon dative, "*woe is to me*." "*Woe worth the day*." This is also the dative; *woe be to the day*; Sax. *wurthan*, *weorthan*, or *wyrthan*, to be, to become. *Woe* is a noun, and if used as an adjective, it is improperly used.

"*Woe to you that are rich*." "*Woe to that man, by whom the offence cometh*," that is, misery, calamity, be or will be to him. It is also written *Wo*.

WOEBEGONE, *a.* [*woe*, *be*, and *gone*.] Overwhelmed with *woe*; immersed in grief and sorrow.

So *woebegone* was he with pangs of love. *Fairfax.*

WOE-SHAKEN, *a.* Shaken by *woe*.

WOESOME, † *a.* (wo'sum.) Woful.

WOE'-WEARIED, † *a.* Tired out with *woe*.

WOFT, † for *Woft*.

WOFUL, *a.* Sorrowful; distressed with grief or calamity; afflicted.

How many *woful* widows left to bow To sad disgrace! *Daniel.*

2. Sorrowful; mournful; full of distress; as, *woful* day; Jer. xvii.—3. Bringing calamity, distress, or affliction; as, a *woful* event; *woful* want.—4. Wretched; paltry.

What *woful* stuff this madrigal would be. *Pope.*

WOFULLY, *adv.* Sorrowfully; mournfully; in a distressing manner.—2. Wretchedly; extremely; as, he will be *wofully* deceived.

WOFULNESS, *n.* Misery; calamity.

WOLD, in Saxon, is the same as *wald* and *weald*, a wood, sometimes perhaps a lawn or plain. *Wald* signifies also power, dominion, from *waldan*, to rule. These words occur in names.

WOLF, *n.* A plant. [See *WALD*.]

WOLF, *n.* (wolf.) [Sax. *wulf*; G. and D. *wolf*; Russ. *wolk*; L. *ulpes*, a fox, the same word differently applied. The Gr. is *αλφειος*.] 1. The *Canis lupus*, Linn., a ferocious quadruped, belonging to the digitigrade carnivora, in



Common Wolf (*Canis lupus*.)

habits and physical development closely related to the dog. The common European wolf is yellowish or fulvous-gray; the hair is harsh and strong, the tail straight, or nearly so, and there is a blackish band or streak on the fore-legs above the carpus. The height at the shoulder from 27 to 29 inches. The wolf is a crafty, greedy, and ravenous animal; the sheep-cote and the farm-yard become the scenes of his ravages, and the size and speed of the elk and of the stag are not sufficient to protect them from his violence, his swiftness, and his cunning. When pressed by famine, he becomes dangerous to man, falling at unawares upon the solitary and unprotected traveller, and carrying off the defenceless children of the villager. Sometimes wolves pursue their prey in companies, which separate again as soon as the object of the pursuit is attained. The common wolf infests the western countries of Europe, and once lurked in the uncleared woody districts of Britain. There are several species of wolf; as, the *black-wolf* of Southern Europe, and particularly of the Pyrenees, and south of those mountains; the *red-wolf* of South America. Several varieties of the common wolf are found in North America.—2. Any thing ravenous or destructive.—3. A small white worm or maggot, which infests granaries.—4. An eating ulcer.—5. In *musical instruments*, such as the piano-forte, a term applied by some writers to the bad fifth which exists in the worst key, when the temperament is allowed to favour some keys at the expense of others. Other writers, however, apply the name *wolf* to the interval from the false octave, obtained by the fifths, to the true one. [See *TEMPERAMENT*.]

WOLF'-DOG, *n.* A large kind of dog of several varieties, kept to guard sheep, cattle, &c., and destroy wolves.—2. A dog supposed to be bred between a dog and a wolf.

WOLF'-FISH, *n.* An acanthoptery-



Woad (*Isatis tinctoria*).

vated.] A plant of the genus *Isatis*, the *I. tinctoria*, formerly cultivated to a

gious fish, the *Anarrhichas lupus* of Linn.; a fierce voracious fish of the

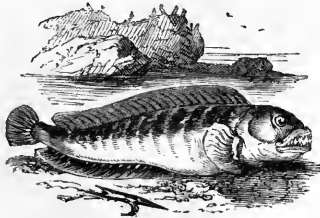

Wolf-fish (*Anarrhichas lupus*).

northern seas. This fish is called also sea-cat, cat-fish, and sea-wolf.

**WOLF'ISH, a.** Like a wolf; having the qualities or form of a wolf; as, a *wolfish visage*; *wolfish designs*.

**WOLF'ISHLY, adv.** Like a wolf; in a wolfish manner.

**WOLF'-NET, n.** A kind of net used in fishing, which takes great numbers.

**WOLFRAM, n.** In *mineral*, a native tungstate of iron and manganese. Its colour is generally a brownish or grayish black; when cut with a knife, it gives a reddish brown streak. It occurs massive and crystallized, and in concentric lamellar concretions.

**WOLF'S-BANE, n.** A poisonous plant of the genus *Aconitum*; the *A. napellus*. It is a perennial herbaceous plant



Wolf's-bane (*Aconitum napellus*).

with a turnip-shaped root, and flowers in long stiff spikes, and of a deep blue colour. It is a native of alpine pastures in Switzerland and other mountainous parts of Europe. It is a common plant in flower borders, and is found in a wild state in one or two parts of England. All the parts of the plant are extremely acrid, especially the roots. The juice of the leaves introduced into the stomach is said to occasion death in a short time, but the powdered root is far more energetic. The poison acts upon the nervous system, especially the brain, producing a sort of phrenzy. The plant is used in medicine in cases of neuralgia.

**WOLF'S-CLAW, n.** A cryptogamous plant of the genus *Lycopodium*; the *L. clavatum*.

**WOLF'S-PEACH, n.** A plant of the genus *Lycopersicum*, the *L. esculentum*; also called *Love-apple*.

**WOLLASTONITE, n.** A species of prismatic angite, or a silicate of lime; a mineral found in Peru, of a yellowish brown colour; so called from Dr. Wollaston.

**WOLVERENE, } n.** A carnivorous  
**WOLVERINE, } mammal, the *Gulo***  
***Luscus*, or *vulgatus*, a quadruped**  
inhabiting the coasts of the Arctic Sea. It is also known by the name of glut-ton,—*which see*.

**WOLF'ISH, a.** More properly *Wolfish*,—*which see*.

**WÖMAN, n. plur. Women.** [According to some etymologists, *woman* is a compound of *womb* and *man*, literally the *wombman*; hence the plural would be *wombmen*. Others, however, derive the word from the Sax. *wif-man*, plur. *wif-men*; Sax. *wif*; Dan. *wiif*, *wiiven*; G. *weib*, from *weben*, to weave. According to this latter etymology, *wifman* would signify the *web* or *woofman*, this name having been given to the female from her employment at the *woof*, and in support of this we find in the *Anglo-Saxon* version of the scriptures, Matt. xix. 4, the male called *wapman*, the *weapon-man*, from his occupation in weapons of war, the female being called *wifman*.] 1. The female of the human race; an adult or grown up female, as distinguished from a child or girl.

And the rib, which the Lord God had taken from the man, made he a *woman*; Gen. ii.

*Women* are soft, mild, pitiful, and flexible.

*Shak.*  
We see every day *women* perish with infamy, by having been too willing to set their beauty to show. *Rambler.*

I have observed among all nations that the *women* ornament themselves more than the men; that wherever found, they are the same kind, civil, obliging, humane, tender beings, inclined to be gay and cheerful, timorous and modest. *Ledyard.*

2. A female attendant on a person of rank.

**WÖMAN, v. t.** To make pliant like a woman.

**WÖMAN-BORN, a.** Born of woman; having had a mother.

**WÖMANED, † a.** Accompanied or united with a woman.

**WÖMAN-HATE, n.** [*woman* and *hater*.] One who has an aversion to the female sex.

**WÖMAN-HEAD, † n.** Womanhood.

**WÖMANHOOD, n.** [*woman* and *hood*.]

The state, character, or collective qualities of a woman.

**WÖMANISH, a.** Suitable to a woman; having the qualities of a woman; feminine; as, *womanish habits*; *womanish tears*; a *womanish voice*.

**WÖMANISHLY, adv.** In a womanish manner.

**WÖMANISHNESS, n.** State or quality of being womanish.

**WÖMANIZE, † v. t.** To make effeminate; to make womanish; to soften.

**WÖMANKIND, n.** [*woman* and *kind*.] The female sex; the race of females of the human kind.

**WÖMANLESS, a.** Destitute of women.

**WÖMANLIKE, a.** Like a woman.

**WÖMANLINESS, n.** Quality of being womanly.

**WÖMANLY, a.** Becoming a woman; suiting a woman; feminine; not masculine; not childish; as, *womanly behaviour*.

A blushing *womanly* discovering grace.

*Donne.*  
**WÖMANLY, adv.** In the manner of a woman.

**WÖMAN-TIRED, † a.** Hen-pecked.

**WÖMB, n.** (*woom*.) [Sax. *wamb*; Goth. *wamba*; Scot. *wame*; G. *wampe*, belly, a dewlap; D. *wam*.] 1. The uterus of

a female; that part where the young of an animal is conceived and nourished till its birth.—2. The place where any thing is produced.

The *womb* of earth the genial seed receives. *Dryden.*

3. Any large or deep cavity.—*Womb of the morning*, in *scrip.*, the clouds which distil dew: supposed to be emblematic of the church bringing forth multitudes to Christ; Ps. ex.

**WÖMB, † v. t.** To inclose; to breed in secret.

**WÖMB'AT, n.** A marsupiate mammal, *Phascolomys Wombat*, a native of Australia and Van Dieman's Land. It is



Wombat (*Phascolomys wombat*).

about the size of a badger, being about three feet in length, and it has moderately long, very coarse, almost bristly fur, of a general gray tint, mottled with black and white. It burrows, feeds on roots, is not very active, and its flesh, which is coarse and red, is said in fatness and flavour to resemble pork.

**WÖMBY, † a.** (*woom'y*.) Capacious.

**WÖMEN, n. plur. of Woman.** (pron. *wim'en*.) [See **WÖMAN**.]

**WÖN, pret. and pp. of Win**; as, victories *won*.

**WÖN, † } v. i.** [Sax. *wunian*; G. *woh-*  
**WÖNE, † } nen**; D. *woonen*, to dwell, to continue; Ir. *fanaim*.] To dwell; to abide; to have abode. Its participle is retained in *wont*, that is, *woned*.

**WÖN, † n.** A dwelling; habitation.

**WÖNDER, n.** [Sax. *wunder*; G. *wunder*; D. *wonder*; Sw. and Dan. *under*; qu. Gr. *φανω*, to show; and hence a sight; or from the root of Sp. *espanto*, a panic.] 1. That emotion which is excited by novelty, or the presentation to the sight or mind of something new, unusual, strange, great, extraordinary, or not well understood; something that arrests the attention by its novelty, grandeur, or inexplicableness. *Wonder* expresses less than *astonishment*, and much less than *amazement*. It differs from *admiration*, in not being necessarily accompanied with love, esteem, or approbation, nor directed to persons. But *wonder* sometimes is nearly allied to *astonishment*, and the exact extent of the meaning of such words can hardly be graduated.

They were filled with *wonder* and amazement; Acts iii.  
*Wonder* is the effect of novelty upon ignorance. *Johnson.*

2. Cause of wonder; that which excites surprise; a strange thing; a prodigy.

To try things oft, and never to give over, doth *wonders*. *Bacon.*

I am as a *wonder* to many; Ps. lxxi.

3. Any thing mentioned with surprise. Babylon, the *wonder* of all tongues. *Milton.*

4. A miracle; Exod. iii.—5. Among *phrenologists*, a faculty of the mind which produces the sentiment of *won-*

der, surprise, or astonishment, and gives the love of the new and the strange. Its organ is situated above *ideality* and before *hope*.—*Wonders of the world*. The seven wonders of the world were the Egyptian pyramids, the mausoleum erected by Artemisia, the temple of Diana at Ephesus, the walls and hanging gardens of Babylon, the colossus at Rhodes, the statue of Jupiter Olympius, and the Pharos or watch-tower of Alexandria.

**WONDER**, *v. i.* [Sax. *wundrian*.] To be struck with wonder; to be affected by surprise or admiration.

I could not sufficiently wonder at the inaptitude of these diminutive mortals.

*Swift*.

We cease to wonder at what we understand.

*Johnson*.

2. To doubt; as, I wonder whether he will be here. [*Colloq.*]

**WONDERER**, *n.* One who wonders.

**WONDERFUL**, *a.* Adapted to excite wonder or admiration; exciting surprise; strange; astonishing; Job xlii.

**WONDERFULLY**, *adv.* In a manner to excite wonder or surprise.

I will praise thee, for I am fearfully and wonderfully made; Ps. cxxxix.

**WONDERFULNESS**, *n.* The state or quality of being wonderful.

**WONDERING**, *ppr.* Indulging or feeling wonder; Gen. xxiv.; Luke xxiv.

**WONDERINGLY**, *adv.* In a wondering manner.

**WONDERMENT**, *n.* Surprise; astonishment; a wonderful appearance. [*Vulgar.*]

**WONDERSTRUCK**, *a.* [*wonder* and *struck*.] Struck with wonder, admiration, and surprise.

**WONDER-WORKER**, *n.* One who performs wonders, or surprising things.

**WONDER-WORKING**, *a.* Doing wonders or surprising things.

**WONDEROUS**, *a.* Admirable; marvelous; such as may excite surprise and astonishment; strange.

That I may publish with the voice of thanksgiving, and tell of all thy wondrous works; Ps. xxvi.

**WONDEROUS**, *adv.* In a wonderful or surprising degree; as, a place wondrous deep; you are wondrous fair; wondrous fond of peace. These phrases of Cowley, Dryden, and Pope, are admissible only in the ludicrous and burlesque style.

**WONDEROUSLY**, *adv.* In a strange or wonderful manner or degree.

Chloe complains, and wondrously 'a agriev'd.

*Glanville*.

**WONDEROUSNESS**, *n.* Quality of being wondrous.

**WON'T**, *a.* a contraction of *woll not*, that is, *will not*.

**WONT**, *a.* [*wont* is strictly the participle passive of *won*, *wone*; Sax. *wunian*, to dwell, to remain, to endure, to exist, to consist; G. *wohnen*, D. *woonen*. But the D. has *wennen*, Sw. *vania*, Dan. *vænner*, to accustom; Ir. *fainim*, to remain. In English, the verb is obsolete; but we retain the participle in use, and form it into a verb. See the *Verb*.] Accustomed; habituated; using or doing customarily.

If the ox were wont to push with his horn; Exod. xxi.

They were wont to speak in old time, saying... 2 Sam. xx. See Math. xxvii. 15; Luke xxii. 39.

**WÖNT**, *† n.* Custom; habit; use.

II.

**WÖNT**, *v. i.* To be accustomed or habituated; to use; to be used.

A yearly solemn feast she *wont* to make.

*Spenser*.

Wherewith he *wont* to soar so high.

*Waller*.

**WONTED**, *pp. or a.* Accustomed; used. Again his *wonted* weapon prov'd.

*Spenser*.

2. Accustomed; made familiar by use. She was *wonted* to the place and would not remove.

*L'Estrange*.

**WONTEDNESS**, *n.* The state of being accustomed.

**WONTLESS**, *† a.* Unaccustomed; unused.

**WOO**, *v. t.* [Sax. *wogan*, whence *awogod*, *wooded*.] 1. To court; to solicit in love.

My proud rival *wooes*

Another partner: to his throne and bed.

*Philips*.

Each, like the Grecian artist, *wooes*

The image he himself has wrought.

*Prior*.

2. To court solicitously; to invite with importunity.

These, chantress, oft the woods among,  
I *woo* to hear thy even song.

*Milton*.

**WOO**, *v. i.* To court; to make love.

**WOOD**, *† a.* [Sax. *wod*.] Mad; furious; raging; in a state of insanity. [In the Scottish dialect, this word is written *Wud*.]

**WOOD**, *n.* [Sax. *wuda*, *wudu*; D. *woud*; W. *gwyz*.] 1. A large and thick collection of trees; a forest.

Light thickens, and the crow

Makes wing to the rooky *wood*.

*Shak.*

2. The substance of trees; the hard fibrous substance which composes the body of a tree and its branches, and which exists between the pith and the bark. In dicotyledonous plants, the wood is composed externally of the *alburnum* or sap-wood, and internally of the *duramen* or hard-wood. In monocotyledonous plants or endogens, the hardest part of the wood is nearest the circumference, while the interior is composed of cellular tissue.—3. Timber; the trunks or main stems of trees which attain such dimensions as to be fit for architectural and other purposes. In this sense, the word implies not only standing trees suitable for buildings, &c., but also such trees cut into beams, rafters, boards, planks, &c. [See *TIMBER*.]—4. Trees cut or sawed for fuel. *Wood* is yet the principal fuel in the United States.—5. An idol; Hab. ii.

**WOOD**, *v. i.* To supply or get supplies of wood.

**WOOD-ANEMONE**, *n.* A plant, *Anemone nemorosa*. [See *ANEMONE*.]

**WOOD-ASHES**, *n.* [*wood* and *ashes*.] The remains of burnt wood or plants.

**WOOD-BIND**, *n.* A name given to **WOOD-BINE**, the honeysuckle, a plant belonging to the genus *Caprifolium*, of various species.

**WOOD-BIRD**, *n.* A bird which inhabits woods.

**WOOD-BOUND**, *a.* [*wood* and *bound*.] Encumbered with tall woody hedgerows.

**WOOD-BRICKS**, *n.* In *arch.*, blocks of wood of the shape and size of bricks, inserted in the interior walls of a building as holds for the joinery.

**WOOD-CHAT**, *n.* A species of butcher bird or shrike, *Lanius rufus*.

**WOOD-CHOIR**, *n.* Songsters in a wood.

**WOOD-CHUCK**, *n.* [*wood* and Persian *chuk*, a hog. See *ЧУК*.] In New England, the popular name of a rodent

mammal, a species of the Marmot tribe of animals, the *Arctomys monax*. The ground hog. It burrows, and is dormant in winter.

**WOOD-COAL**, *n.* [*wood* and *coal*.] Charcoal; also lignite or brown coal.

**WOOD-COCK**, *n.* [*wood* and *cock*.] A fowl of the genus *Scolopax*, the *S. rusticola*, allied to the snipe tribe, but



Wood cock (*Scolopax rusticola*).

with a more robust bill, and shorter legs. It is widely distributed. It breeds not unfrequently in Great Britain, especially in Scotland. Its nest is placed on the ground, in a dry warm spot, among herbage, and is loosely fabricated of dead leaves. Its flight is very rapid, and its flesh highly esteemed.

**WOOD-COCK SHELL**, *n.* A name given to the shells of certain molluscs of the genus *Rumex*, which have a very long tube with or without spines, but especially to the *M. haustellum*.

**WOOD-CRACKER**, *n.* A name given to the common nuthatch, *Sitta Europæa*.

**WOOD-CRAFT**, *† n.* Skill in the chase; especially in hunting deer, &c. [*This word has been revived by Sir Walter Scott*.]

**WOOD-CRICKET**, *n.* A species of cricket.

**WOOD-CUL'VER**, *n.* The wood-pigeon.

**WOOD-CUT**, *n.* An engraving on wood, or a print or impression from such engraving.

**WOOD-CUTTER**, *n.* A person who cuts wood.—2. A name applied to engravers on wood.

**WOOD-CUTTING**, *ppr.* Cutting wood.—2. Engraving on wood; as, the art of *wood-cutting*.

**WOOD-CUTTING**, *n.* The art or employment of cutting wood by means of saws, or by the application of knife-edge machinery.—2. Wood-engraving, —which see.

**WOOD-DRINK**, *n.* [*wood* and *drink*.] A decoction or infusion of medicinal woods; as saffras.

**WOOD-ECHO**, *n.* An echo from the wood.

**WOOD'ED**, *a.* Supplied or covered with wood; as, land *wooded* and watered.

**WOOD'EN**, *a.* [from *wood*.] Made of wood; consisting of wood; as, a *wooden* box; a *wooden* leg; a *wooden* horse.—2. Clumsy; awkward.

When a bold man is put out of countenance, he makes a very *wooden* figure on it.

*Collier*.

**WOOD-ENGRAVER**, *n.* An artist who engraves on wood.

**WOOD-ENGRAVING**, *n.* The art of engraving on wood, or of producing raised surfaces, by excision, on blocks of wood, from which impressions can

be transferred, by means of a coloured pigment, to paper or other suitable material. It is generally applied to pictorial representations of objects. The wood generally used by wood engravers is box, the blocks being cut directly across the grain. Wood-engraving is now generally used in illustrating publications of all kinds. [See ENGRAVING.]

WOOD'-EN-SPOON, *n.* A name applied to the last junior optime in the University of Cambridge.

WOOD'-FRETTER, *n.* [wood and fret.] An insect or worm that eats wood.

WOOD'-GOD, † *n.* A pretended Sylvan deity.

WOOD'-GROUSE, *n.* A bird, the *Tetrao urogallus*; called also cock of the mountain, cock of the wood, and in Scotland capercaillie.

WOOD'-HOLE, *n.* [wood and hole.] A place where wood is laid up.

WOOD'-HOUSE, *n.* [wood and house.] In the *U. States*, a house or shed in which wood is deposited and sheltered from the weather.—2. A house constructed of wood.

WOOD'INESS, *n.* State of being woody.

WOOD'ING, *ppr.* Getting or supplying with wood.

WOOD'-LAND, *n.* [wood and land.] Land covered with wood, or land on which trees are suffered to grow, either for fuel or timber.

WOOD'LAND, *a.* Relating to woods; sylvan; as, *woodland* echoes.

WOOD'LARK, *n.* [wood and lark.] A bird, a species of lark, the *Alauda arboræ*, which is found near the borders of woods, and which perches on trees, where it sometimes sings, but it pours out its song chiefly when on the wing. It sings much more melodiously than the sky-lark, but its song does not consist of so great a variety of notes.

WOOD'-LAYER, *n.* [wood and layer.] A young oak or other timber plant, laid down in a hedge among the white thorn or other plants used in hedges.

WOOD'LESS, *a.* Destitute of wood.

WOOD'LESSNESS, *n.* State of being destitute of wood.

WOOD'-LOCK, *n.* [wood and lock.] In *ship-building*, a piece of elm, close fitted and sheathed with copper, in the throating or score of the pintle, to keep the rudder from rising.

WOOD'-LOUSE, *n.* [wood and louse.] An insect, the millipede, belonging to the genus *Oniscus*. [See MILLIPEDE.]

WOODLY, *adv.* Madly. [Obsolete or local.]

WOOD'MAN, } *n.* [wood and man.] A  
WOODS'MAN, } forest officer, appointed to take care of the king's wood; a forester.—2. A sportsman; a hunter.—3. One who fells timber.

WOOD'-MEIL, *n.* A coarse hairy stuff made of Iceland wool, used to line the ports of ships of war.

WOOD'-MITE, *n.* [wood and mite.] A small insect found in old wood.

WOOD'-MONGER, *n.* [wood and monger.] A wood seller.—2. A member of the company of *wood-mongers*, in the corporation of London.

WOOD'-MOTE, *n.* [wood and mote.] In England, the ancient name of the forest court; now the court of attachment.

WOOD'NESS, † *n.* Anger; madness; rage.

WOOD'-NIGHTSHADE, *n.* [See WOODY-NIGHTSHADE.]

WOOD'-NOTE, *n.* [wood and note.] Wild music.

Or sweetest Shakspeare, fancy's child,  
Warble his native *wood-notes* wild. *Milton*.

WOOD'-NYMPH, *n.* [wood and nymph.] A fabled goddess of the woods; a dryad.

The *wood-nymphs* deck'd with daisies trim. *Milton*.

WOOD'-OFFERING, *n.* Wood burnt on the altar; Neh. x.

WOOD'-OPAL, *n.* A striped variety of opal, having some resemblance to wood. It is in reality opalized vegetable matter.

WOOD'PECKER, *n.* [wood and peck.] The common name of the scansorial birds belonging to the genus *Picus*, Linn., and forming the *Picidæ* of modern ornithologists. These birds receive the name of woodpeckers from their habit of piercing the bark of trees with their sharp bills, in order to get at their food, which consists of insects and their eggs lodged below the bark. [See *PICUS*.]

WOOD'-PIGEON, *n.* [wood and pigeon.] The ring-dove, (*Columba palumbus*.)

WOOD'-PILE, *n.* A stack of piled up wood, for fuel.

WOOD'-PU'CKERON, *n.* [wood and puckeron.] The plant-louse, an insect of the genus *Aphis* which infests plants.

WOOD'REEVE, *n.* [wood and reeve.] In England, the steward or overseer of a wood.

WOOD'ROCK, *n.* A name for ligniform asbestos.

WOOD'-ROOF, } *n.* [wood and roof or  
WOOD'-RUFF, } *ruff*.] The common name of several plants of the genus *Asperula*, nat. order *Rubiaceæ*. The sweet wood-ruff, (*A. odorata*), is found plentifully in Britain in woods and shady places. It has been admitted into the garden from the beauty of its whorled leaves and simple blossom, but chiefly from the fragrance of its leaves. The odour is only perceptible when the leaves are crushed by the fingers, or when they are dried. The dried leaves give out their odour very strongly, and for a long period. They are used to scent clothes, and also to preserve them from the attacks of insects.

WOOD'RUSH, *n.* The common name of several British plants of the genus *Luzula*. [See *LUZULA*.]

WOOD'-SAGE, *n.* [wood and sage.] A plant of the genus *Teucrium*, the *T. scorodonia*, having the smell of garlic. The whole plant is bitter, and is said to answer instead of hops in making beer. [See *TEUCRUM*.]

WOOD'-SARE, † *n.* A kind of froth seen on herbs.

WOOD'-SCREW, *n.* The common screw made of iron, and used by carpenters and joiners for fastening together pieces of wood, or wood and metal.

WOOD'-SERE, † *n.* The time when there is no sap in a tree.

WOOD'-SHOCK, *n.* The wejack, a quadruped of the weasel kind in North America. It is the *Mustela Canadensis* of Linnæus, a digitigrade carnivorous mammal, sometimes called *Pekah*, *Otchok*, *Fisher Weasel*, &c. It is found from Pennsylvania to the Great-Slave-Lake, and across the continent to the shores of the Pacific.

WOOD'SIA, *n.* A genus of ferns having

circular sori, with an inferior involucre, divided at the edges into numerous capillary segments. *W. ivensis* is one of the rarest of our British ferns, being found only on Snowdon in Wales and Ben-Lawers in Scotland, where it takes root in the fissures of rocks.

WOOD'-SOOT, *n.* [wood and soot.] Soot from burnt wood, which has been found useful as a manure.

WOOD'-SORREL, *n.* [wood and sorrel.] The common name of two British plants of the genus *Oxalis*. [See *OXALIS*.]

WOOD'-SPITE, *n.* [wood and spite.] A name given in some parts of England to the green woodpecker.

WOOD'-STONE, *n.* [wood and stone.] Petrified wood.

WOOD'-SWALLOWS, *n.* A name given by the colonists of Australia, to birds belonging to the genus *Lanius*, Linn. They constitute the genus *Artamas* of Vieillot, and the swift shrieks of Swainson.

WOOD'-TIN, *n.* A fibrous nodular variety of oxide of tin, found hitherto only in Cornwall, and Mexico. [See *TIN*.]

WOOD'-WARBLER, } *n.* A migratory  
WOOD'-WREN, } bird of the genus *Sylvia*, the *S. sylvicola* of Pennant. It visits England in the spring, and departs in September. It sings in the woodlands in the spring and during the greater part of summer, its note resembling the word *tee*, sounded very long, and repeated several times in succession.

WOOD'-WARD, *n.* [wood and ward.] A forester; a land-reeve.

WOOD'-WASH, } *n.* Names given  
WOOD'-WAX, } to dyer's weed,  
WOOD'-WAXEN, } *Genista tinctoria*. [See *WOOD WAXEN*.]

WOOD'-WORK, *n.* Work formed of wood; that part of any structure which is made of wood.

WOOD'-WORM, *n.* [wood and worm.] A worm that is bred in wood.

WOOD'Y, *a.* [from wood.] Abounding with wood; as, *woody* land; a *woody* region.

Secret shades

Of *woody* Ida's inmost grove. *Milton*.

2. Consisting of wood; ligneous; as, the *woody* parts of plants.—3. Pertaining to woods; sylvan; as, *woody* nymphs.

WOOD'-Y-FIBRE, } *n.* In *bot.*, that  
WOOD'-Y-TISSUE, } which constitutes the basis of the wood in trees. It is composed of bundles of elongated cells or tubes of a woody nature, generally pointed at both ends, and lying close together, but having no direct communication with each other. [See *TISSUE*.]

WOOD'-Y-NIGHT-SHADE, *n.* The common name of two British plants of the genus *Solanum*. [See *SOLANUM*.]

WOOD'-Y-STEM, *n.* In *bot.*, a stem of a hard or woody nature, and which lasts for many years; as the trunks of trees.

WOOD'ED, *ppr.* Courted; solicited in love.

WOOD'ER, *n.* [from *woo*.] One who courts, or solicits in love.

WOOF, *n.* [Sax. *wefl*, from *wefan*, to weave; Sw. *wäf*; Gr. *ωφ*.] 1. The threads that cross the warp in weaving; the weft.—2. Texture; cloth; as, a *wool* of softest *woof*.

WOOF'ING, *ppr.* [from *woo*.] Courting; soliciting in love.

WOOL'ING, *n.* The act of courting or soliciting.

WOOL'INGLY, *adv.* Enticingly; with persuasiveness; so as to invite to stay.

WOOL, *n.* [Sax. *wul*; G. *wolle*; D. *wol*; Russ. *volna*; Basque, *ulea*. Qn. Gr. *ωλες*, soft; *ωλες*, down; or L. *vellus*, from *vellō*, to pull off.] 1. That soft species of hair which grows on sheep and some other animals, as rabbits, beavers, racoons, wild cats, some species of goats, &c., which in fineness sometimes approaches to fur. The word generally signifies the fleecy coat of the sheep, which constitutes a most essential material of clothing in all cold and temperate climates. Wool is divided into two classes: *short or clothing wool*, and *long or combing wool*, each class being subdivided into a variety of sorts, according to their fineness and soundness of the staple. The finest wools are of short staple, and the coarser wools usually of long staple. Wools which unite a high degree of fineness and softness, with considerable length of staple, bear a high price. Of all European wools those of Saxony are pre-eminent in point of softness, but all the European wools yield to those of India in this respect. Fine wools are produced in Spain, and also in England.—2. Short thick hair.—3. In *bot.*, a sort of pubescence, or a clothing of dense curling hairs on the surface of certain plants.—4. The fibre of the cotton plant.

WOOL'-BALL, *n.* A ball or mass of wool found in the stomach of sheep.

WOOL'-BEARING, *a.* Producing wool.

WOOL'-COMBER, *n.* One whose occupation is to comb wool.

WOOL'-COMBING, *n.* The act of combing wool.

WOOLD. See WELD.

WOOLD, *v. t.* [D. *woelen*, *bewoelen*; G. *wühlen*.] To wind, particularly to wind a rope round a mast or yard, when made of two or more pieces, at the place where they are fished, for confining and supporting them.

WOOLD'ED, *pp.* Bound fast with ropes; wound round.

WOOLD'ER, *n.* A stick used in wooling.

WOOLD'ING, *ppr.* Binding fast with ropes; winding round.

WOOLD'ING, *n.* The act of winding, as a rope round a mast.—2. The rope used for binding masts and spars.

WOOL'-DRIVER, *n.* [wool and driver.] One who buys wool and carries it to market.

WOOLENETTE', *n.* A thin woollen stuff.

WOOL'FEL, *n.* [wool and fel, L. *pellis*.] A skin with the wool; a skin from which the wool has not been sheared or pulled.

WOOL'-GATH'ERING, *a.* or *n.* A term applied to a vagrant idle exercise of the imagination, often leading to the neglect of present objects; as, his *wits* have gone a *wool-gathering*.

WOOL'-GRÖWER, *n.* [wool and grow.] A person who raises sheep for the production of wool.

WOOL'-GROWING, *a.* Producing sheep and wool.

WOOL'LED, *a.* Having wool; as, fine-woolled.

WOOL'LEN, *a.* Made of wool; consisting of wool; as, woollen cloth.—2. Pertaining to wool; as, woollen manufactures.—3. Coarse; of little value.

WOOL'LEN, *n.* Cloth made of wool; woollen goods.

WOOL'LEN-DRA'PER, *n.* A retail dealer in woollen cloths, flannels, &c.; a man-mercier.

WOOL'LINESS, *n.* [from woolly.] The state of being woolly.

WOOL'LY, *a.* Consisting of wool; as, a woolly covering; a woolly fleece.—

2. Resembling wool; as, woolly hair.—

3. Clothed with wool; as, woolly breeders.—4. In *bot.*, clothed with a pubescence resembling wool.

WOOL'LY-PASTINUM, *n.* A name given in the East Indies to a species of red orpiment or arsenic.

WOOL'-MAN, *n.* A dealer in wool.

WOOL'-MILL, *n.* A mill for manufacturing wool, and woollen cloth.

WOOL'PACK, *n.* [wool and pack.] A pack or bag of wool.—2. Any thing bulky without weight.

WOOL'-PACK'ER, *n.* One who puts up wool into packs or bales.

WOOL'SACK, *n.* [wool and sack.] A sack or bag of wool.—2. The seat of the lord chancellor in the house of lords, being a large square bag of wool, without back or arms, covered with green cloth.—3. Any thing bulky and light.

WOOL'-SHEARS, *n.* An instrument for shearing sheep.

WOOL'-SORTER, *n.* One who sorts wools according to their qualities. The English sorters make out of a single fleece not fewer than eight or ten different sorts, varying from each other in fineness, and known by the following names:—*prime, choice, super, head, downrights, seconds, fine abb, second abb, livery, short coarse, or breech wool.*

WOOL'-STAPLE, *n.* [wool and staple.] A city or town where wool used to be brought to the king's staple for sale.—

2. The thread or pile of wool. [See STAPLE.]

WOOL'-STA'PLER, *n.* A dealer in wool; a wool-factor. [The term is obsolete, except as applying to *wholesale* dealers.]—2. A sorter of wool.

WOOL'-TRADE, *n.* [wool and trade.] The trade in wool.

WOOL'WARD, † *adv.* In wool.

WOOL'WINDER, *n.* [wool and wind.] A person employed to wind or make up wool into bundles to be packed for sale.

WOOL'RALY POISON. See OURART.

WOOS, *n.* A plant; a sea weed.

WOOTZ, *n.* Indian steel, a metallic substance imported from the East Indies, and considered as peculiarly excellent for some cutting instruments. It has in combination a minute portion of silicium and aluminum.

WORD, *n.* [Sax. *word* or *wyrd*; G. *wort*; D. *woord*; Dan. and Sw. *ord*; Sans. *wartha*. This word is probably the participle of a root in *Br.* and radically the same as L. *verbum*; Ir. *abairim*, to speak. A word is that which is uttered or thrown out.] 1. An articulate or vocal sound, or a combination of articulate and vocal sounds, uttered by the human voice, and by custom expressing an idea or ideas; a single component part of human speech or language. Thus *a* in English is a word; but few words consist of one letter only. Most words consist of two or more letters, as *go, do, shall*, called monosyllables, or of two or more syllables, as *honour, goodness, amiable*.—

2. The letter or letters, written or

printed, which represent a sound or combination of sounds.—3. A short discourse.

Shall I vouchsafe your worship a word or two? *Shak.*

4. Talk; discourse. Why should calamity be full of words? *Shak.*

Be thy words severe. *Dryden.*

5. Dispute; verbal contention; as, some words grew between us.—6. Language; living speech; oral expression. The message was delivered by word of mouth.—7. Promise. He gave me his word he would pay me.

Obeys thy parents; keep thy word justly. *Shak.*

8. Signal; order; command; military token.

Give the word through. *Shak.*

9. Account; tidings; message. Bring me word what is the issue of the contest.—10. Declaration; purpose expressed.

I know you brave, and take you at your word. *Dryden.*

11. Declaration; affirmation. I desire not the reader should take my word. *Dryden.*

12. The scripture; divine revelation, or any part of it. This is called the word of God.—13. Christ; John i.—

14. A motto; a short sentence; a proverb.—*Compound word*, a word formed of two or more simple words; as, *writing-desk, penknife, nevertheless*, &c.—*A good word*, commendation; favourable account.

And gave the harmless fellow a good word. *Pope.*

In word, in declaration only. Let us not love in word only, neither in tongue; but in deed and in truth; 1 John iii.

WORD, *v. i.* To dispute. [Little used.]

WORD, *v. t.* To express in words; to style; to phrase. Take care to word ideas with propriety.

The apology for the king is the same, but worded with greater deference to that great prince. *Addison.*

2. To produce an effect upon by words; to overpower by words.

WORD'-BOOK, *n.* A vocabulary; a dictionary.

WORD'-CATCHER, *n.* One who cavils at words.

WORDED, *pp.* Expressed in words.

WORDER, † *n.* A speaker.

WORD'ILY, *adv.* In a verbose or wordy manner.

WORDINESS, *n.* [from wordy.] The state or quality of abounding with words.

WORDING, *ppr.* Expressing in words.

WORDING, *n.* The act of expressing in words.—2. The manner of expressing in words. The *wording* of the ideas is very judicious.

WORDISH, † *a.* Respecting words.

WORDISHNESS, † *n.* Manner of wording.

WORDLESS, *a.* Not using words; not speaking; silent.

WORDY, *a.* Using many words; verbose; as a wordy speaker; a wordy orator.—2. Containing many words; full of words.

We need not lavish hours in wordy periods. *Philips.*

WORE, *pret.* of Wear. He wore gloves.

WORE, *pret.* of Wear or Ware (a nautical term); as, he wore ship.

WORK, *v. i.* pret. and pp. Worked or Wrought. [Sax. *weorcan, wircan, wyrkan*; Goth. *wearkyan*; G. *wirken*; Gr. *εργάζεσθαι*.] 1. In a general sense,

to move with labour, and with some particular purpose or tendency; to move one way and the other; to perform; as in popular language it is said, a mill or machine *works* well.—2. To labour; to toil; to be occupied in performing manual labour, whether severe or moderate. One man *works* better than another; one man *works* hard; another *works* lazily.—3. To be in action or motion; as, the *working* of the heart.—4. To act; to carry on operations.

Our better part remains

To *work* in close design. *Milton*

5. To operate; to carry on business; to be customarily engaged or employed in. Some *work* in the mines, others in the loom, others at the anvil.

They that *work* in fine flax; *Isa. xix.*

6. To act internally; to ferment; as, unfermented liquors *work* violently in hot weather. In this sense the regular *pret.* and *pp.* are used.—7. To operate; to produce effects by action or influence.

All things *work* together for good to them that love God; *Rom. viii.*

This so wrought upon the child that afterward he desired to be taught. *Locke.*

8. To obtain by diligence. [*Little used.*]

—9. To act or operate on the stomach and bowels; as a cathartic.—10. A ship is said to *work*, when she strains and labours heavily in a tempestuous sea, so as to loosen her joints or timbers; or when, in consequence of her fastenings at any part having become slack, she strains and yields in the pitching and rolling motions.—11. To be tossed or agitated.

Confus'd with *working* sands and rolling waves. *Addison.*

12. To enter by working; as, to *work* into the earth.—To *work* on, to act on; to influence.—To *work* up, to make way.

Body shall up to spirit *work.* *Milton.*

To *work* to windward, among seamen, to sail or ply against the wind; to beat.

WORK, *v. t.* To move; to stir and mix; as, to *work* mortar.—2. To form by labour; to mould, shape, or manufacture; as, to *work* wood or iron into a form desired, or into an utensil; to *work* cotton or wool into cloth.—3. To bring into any state by action. A foul stream, or new wine or cider *works* itself clear.—4. To influence by acting upon; to manage; to lead.

And *work* your royal father to his ruin. *Philips.*

5. To make by action, labour or violence. A stream *works* a passage or a new channel.

Sidelong he *works* his way. *Milton.*

6. To manage or direct in a state of motion; as, to *work* a mill; to *work* a machine.—7. To produce by action, labour, or exertion.

We might *work* any effect...only by the unity of nature. *Bacon.*

Each herb he knew, that *works* or good or ill. *Harte.*

8. To effect by labour in some particular manner, as by the needle; to embroider.—9. To *work* a ship, is to direct her movements by the management of the sails and rudder. The term is especially applicable to the shifting of the sails and rudder at the proper time in the process of tacking.—10. To put to labour; to exert.

*Work* every nerve. *Addison.*

11. To cause to ferment, as liquor.—12. To *work* a horse, in the manege, to

exercise him at pace, trot, or gallop, and ride him at the manege.—To *work* a horse upon volts, or head and haunches in or between two heels, is to passage him or make him go sideways upon parallel lines.—To *work* out, to effect by labour and exertion.

*Work* out your own salvation with fear and trembling; *Phil. ii.*

2. † To erase; to efface.—3. To solve, as a problem.—To *work* up, to raise; to excite; as, to *work* up the passions to rage.

The sun that rolls his chariot o'er their heads,

*Works* up more fire and colour in their cheeks. *Addison.*

2. To expend in any work, as materials. They have *worked* up all the stock.—To *work* double tides, in the language of seamen, to perform the labour of three days in two; a phrase taken from the practice of working by the night tide as well as by the day.—To *work* into, to make way, or to insinuate; as, to *work* one's self into favour or confidence.—To *work* a passage, among seamen, to pay for a passage by doing duty on board of the ship.

WORK, *n.* [*Sax. weorc*; *D. and G. werk*; *Gr. ἔργον.*] 1. Labour; employment; exertion of strength; particularly in man, manual labour; toil.—2. State of labour; as, to be at *work*.—3. Awkward performance. What *work* you make!—4. That which is made or done; the effect of labour; the product of labour; as, good *work*, or bad *work*.—5. Embroidery; flowers or figures wrought with the needle.—6. Any fabric or manufacture.—7. The matter on which one is at work. In rising she dropped her *work*.—8. Action; deed; feat; achievement; as, the *works* of bloody Mars.—9. Operation.

As to the composition or dissolution of mixed bodies, which is the chief *work* of elements. *Digby.*

10. Effect; that which proceeds from agency.

Fancy

Wild *work* produces oft, and most in dreams. *Milton.*

11. Management; treatment.—12. That which is produced by mental labour; a composition; a literary performance; a book; as, the *works* of Addison.—13. *Works*, in the plural, walls, trenches, and the like, made for fortifications.—14. A piece of mechanism; as the *works* of a clock or watch.—15. A manufacturing establishment; also any establishment where labour is carried on extensively and in different departments.—16. In *theol.*, moral duties or external performances, as distinct from grace.—To set to *work*, or to set on *work*, to employ; to engage in any business.

WORKABLE, *a.* That can be worked, or that is worth working; as, a *workable* mine; *workable* coal.

WORK-BAG, *n.* A small bag used by ladies for containing needle-work, &c.; a reticule.

WORK-BOX, *n.* A small box for holding needle-work, &c.

WORK-DAY, *n.* A day for work; a working day, not Sunday.

WORK'ED, *pp.* Moved; laboured; performed; managed; fermented.

WORKER, *n.* One that works; one that performs.

WORK-FELLOW, *n.* One engaged in the same work with another; *Rom. xvi.*

WORK-FOLK, } *n. plur.* Persons that  
WORK-FOLKS, } labour.

WORKHOUSE, *n.* A house for work; a manufactory.—2. Under the old *poor-laws* of England a poor-house; also an establishment in each parish, partaking of the character of a bridewell, where indigent, vagrant, and idle people were set to work, and supplied with food and clothing, or what is termed *in-door relief*. Workhouses were employed for two different purposes. Some were used as prisons for vagrant or sturdy beggars, who were there confined and compelled to labour; whilst others, sometimes called *poor-houses*, were large alms houses, for the maintenance and support of the indigent and such able-bodied persons as were out of employment. Previous to the passing of the poor-law amendment act in 1834, these workhouses were described as generally speaking, nurseries of idleness, ignorance, and vice. By the act alluded to, parishes were united for the better management of workhouses, which gave rise to the poor-law unions. New workhouses, capable of containing from 100 to 500 inmates, have been erected in nearly every poor-law union. In these establishments, a suitable classification of the pauper inmates has been effected, and proper government and discipline instituted. The paupers of the several classes, are kept employed according to their capacity and ability. Religious and secular instruction is supplied, habits of industry, cleanliness, and order are enforced; and wholesome food and sufficient clothing are furnished.

WORKING, *pp.* or *a.* Moving; operating; labouring; fermenting.—*Working point*, in machinery, is that part of a machine at which the effect required is produced. The object of a machine is to transmit and modify the force communicated by the first or *prime mover* to the *working point*, in such a way as to produce the effect intended.

WORKING, *n.* Motion; the act of labouring.—2. Fermentation.—3. Movement; operation; as, the *workings* of fancy.

WORKING, *a.* Devoted to bodily toil; as, the *working* classes.

WORKING-DAY, *a.* Common; coarse; gross.

WORKING-DAY, *n.* [*work* and *day.*] Any day of the week, except the Sabbath.

WORKING-DRAWINGS, *n.* In engineering and the mechanical arts, generally the drawings given to the workman to guide him in the execution of the work.

WORKING-HOUSE, *n.* A workhouse.

WORKMAN, *n.* [*work* and *man.*] Any man employed in manufacturing labour.—2. By way of eminence, a skilful artificer or mechanic.—3. A labourer.

WORKMANLIKE, *a.* Skilful; well performed.

WORKMANLY, *a.* Skilful; well performed; workmanlike.

WORKMANLY, *adv.* In a skilful manner; in a manner becoming a workman.

WORKMANSHIP, *n.* Manufacture; something made, particularly by manual labour; *Exod. xxxi.*—2. That which is effected, made, or produced; *Eph. ii.*—3. The skill of a workman; or the execution or manner of making any thing. The *workmanship* of this cloth is admirable.—4. Art; dexterity.

**WÖRK'MÄSTER, n.** [*work* and *master*.] The performer of any work.

**WÖRK-PEOPLE, } n.** Those who  
**WÖRKING-PEOPLE, }** labour in  
mechanical or menial operations.

**WÖRKSHOP, n.** [*work* and *shop*.] A shop where a workman, a mechanic, or artificer, or a number of such individuals, carry on their work.

**WÖRK-TÄBLE, n.** A small table containing drawers and other conveniences for ladies, in respect of their needle-work.

**WÖRK'WÖMAN, n.** A woman who performs any work; or one skilled in needle-work.

**WÖRKY-DÄY, n.** [a corruption of *working day*.] A day not the Sabbath. [*Vulgar*.]

**WÖRLD, n.** [Sax. *weorold*, *woruld*; D. *waereld*; Sw. *verld*. This seems to be a compound word, and probably is named from roundness, the vault; but this is not certain.] 1. The universe; the whole system of created globes or vast bodies of matter.—2. The earth; the terraqueous globe; sometimes called the *lower world*.—3. The heavens; as when we speak of the heavenly *world*, or upper *world*.—4. System of beings; or the orbs which occupy space, and all the beings which inhabit them; Heb. xi. God...hath in these last days spoken to us by his Son, whom he hath appointed heir of all things; by whom also he made the *worlds*; Heb. i.

There may be other *worlds*, where the inhabitants have never violated their allegiance to their Almighty sovereign.

W. B. Sprague.

5. Present state of existence; as, while we are in the world.

Behold these are the ungodly who prosper in the *world*; Ps. lxxiii.

6. A secular life. By the *world* we sometimes understand the things of this world, its pleasures and interests. A great part of mankind are more anxious to enjoy the *world* than to secure divine favour.—7. Public life or society; as, banished from the *world*.—8. Business or trouble of life.

From this *world*-wearing flesh. *Shak*.

9. A great multitude or quantity; as, a *world* of business; a *world* of charms.—10. Mankind; people in general; in an indefinite sense. Let the *world* see your fortune.

Whose disposition, all the *world* well knows. *Shak*.

11. Course of life. He begins the *world* with little property, but with many friends.—12. Universal empire. This through the east just vengeance hurl'd, And lost poor Antony the *world*. *Prior*.

13. The customs and manners of men; the practice of life. A knowledge of the *world* is necessary for a man of business; it is essential to politeness.—14. All the world contains.

Had I a thousand *worlds*, I would give them all for one year more to devote to God. *Law*.

15. The principal nations or countries of the earth. Alexander conquered the *world*.—16. The Roman empire.—17. A large tract of country; a wide compass of things.

I must desery new *worlds*. *Cowley*.

18. Any large portion of the earth; as the *old world*, the *new world* (America.) The *old world* is also used to signify the earth before the flood.—19. The inhabitants of the earth; the whole human race; John iii.—20. The carnal state or corruption of the earth; as,

the present evil *world*; the course of this *world*; Gal. i.; Eph. ii.—21. The ungodly part of the world.

I pray not for the *world*, but for them that thou hast given me; John xvii.

22. Time; as in the phrase, *world* without end.—23. † A collection of wonders; a wonder.—In the *world*, in possibility. All the precaution in the *world* would not save him.—For all the *world*, exactly. [*Little used*.]—2. For any consideration.

**WÖRLD'HÄRDENED, a.** Hardened by the love of worldly things.

**WÖRLDLINNESS, n.** [from *world*.] A predominant passion for obtaining the good things of this life; covetousness; aedictness to gain and temporal enjoyments.

**WÖRLDLING, n.** A person whose soul is set upon gaining temporal possessions; one devoted to this world and its enjoyments.

If we consider the expectations of futurity, the *worldling* gives up the argument.

Rogers.

**WÖRLDLY, a.** Secular; temporal; pertaining to this world or life, in contradistinction to the life to come; as, *worldly* pleasures; *worldly* affairs; *worldly* estate; *worldly* honour; *worldly* lusts; Tit. ii.—2. Devoted to this life and its enjoyments; not attentive to a future state; bent on gain; as, a *worldly* man; a *worldly* mind.—3. Human; common; belonging to the world; as, *worldly* actions; *worldly* maxims.

**WÖRLDLY, adv.** With relation to this life.

Subverting *worldly* strong and *worldly* vice By simply meek. *Milton*.

**WÖRLDLY-MINDED, a.** Devoted to the acquisition of property and to temporal enjoyments.

**WÖRLDLY-MINDEDNESS, n.** A predominating love and pursuit of this world's goods, to the exclusion of piety and attention to spiritual concerns.—2. State of being worldly-minded.

**WÖRLD-SHÄRER, † n.** A sharer of the earth.

**WÖRLD-WEÄRIED, a.** Tired of the world.

**WÖRM, n.** [Sax. *wyrm*; G. *wurm*; D. *worm*; Dan. *orm*; Sw. *id*, a serpent. This word is probably named from a winding motion, and the root of *swarm*.] 1. In common usage, any small creeping animal, or reptile, either entirely without feet, or with very short ones, including a great variety of animals of different classes and orders, viz., certain small serpents, as the blind-worm or slow-worm; the larvæ of insects, viz., grubs, caterpillars, and maggots, as the wood-worm, canker-worm, silk-worm, (the larva of a moth, *Phalæna*, which spins the filaments of which silk is made,) the grub that injures corn, grass, &c., the worms that breed in putrid flesh, the bots in the stomach of horses, and many others; certain wingless insects, as the glow-worm; the intestinal worms, or such as breed in the cavities and organs of living animals, as the tape-worm, the round-worm, the fluke, &c.; and numerous animals found in the earth, and in water, particularly in the sea, as the earth-worm or *lumbricus*, the hair-worm or *gordius*, the *teredo*, or worm that bores into the bottom of ships, &c. *Worms*, in the plural, in common usage, is used for intestinal worms, or those which breed in the stomach and bowels, particularly the round and thread worms,

(*ascarides* and *oxyurides*), which are often found there in great numbers; as we say, a child has *worms*.—2. In *zool*, the term *Vermes* or *worms* has been applied to different divisions of invertebral animals, by different naturalists. Linnæus's class of *Vermes* includes the following orders, viz., *Intestina*, including the proper intestinal worms, the earth-worm, the hair-worm, the *teredo*, and some other marine worms; *Mollusca*, including the slug, and numerous soft animals inhabiting the water, particularly the sea; *Testacea*, including all the proper shell-fish; *Zoophyta*, or compound animals, including corals, polypes, and sponges; and *Infusoria*, or simple microscopic animalcules. His character of the class is,—spiracles obscure, jaws various, organs of sense usually tentacula, no brain, ears, nor nostrils, limbs wanting, frequently hermaphrodite. This class includes all the invertebral animals, except the insects and *crustacea*. The term *Vermes* has been since greatly limited, particularly by the French naturalists. Lamarck confined it to the intestinal worms, and some others, whose organization is equally simple. The character of his class is, suboviparous, body soft, highly reproductive, undergo no metamorphosis; no eyes, nor articulated limbs, nor radiated disposition of internal organs. [See *VERMES*.]—3. Remorse; that which incessantly gnaws the conscience; that which torments.

Where their *worm* dieth not; Mark ix.

4. A being debased and despised.

I am a *worm*, and no man; Ps. xxii.

5. An instrument resembling a double cork-screw fixed on the end of a staff or rammer, used for drawing wads and cartridges from cannon or small arms.—6. Something spiral, vermiculated, or resembling a worm; as, the threads of a screw.—7. In *chem*, and *distilleries*, a spiral leaden pipe placed in a tub of water, through which the vapour passes in distillation, and in which it is cooled and condensed. It is called also a *serpentine*.—8. A small worm-like part situated beneath a dog's tongue.

**WÖRM, v. i.** To work slowly, gradually, and secretly.

When debates and fretting jealousy Did *worm* and work within you more and more,

Your colour faded. *Herbert*.

**WÖRM, v. t.** To expel or undermine by slow and secret means.

They find themselves *wormed* out of all power. *Swift*.

2. To cut something, called a worm, from under the tongue of a dog.—3. To draw the wad or cartridge from a gun; to clean by the worm.—4. In *marine lan*, to wind a rope spirally round a cable, between the strands; or to pass spun yarn or other small stuff between the strands of a smaller rope, in order to render the surface smooth for parcelling and serving.—To *worm one's self into*, to enter gradually by arts and insinuations; as, to *worm one's self into* favour.

**WÖRM, a.** Having reference to worms; good against worms; vermifuge; as, *worm medicines*.

**WÖRM-EÄTEN, a.** [*worm* and *eat*.] Gnawed by worms; having a number of internal cavities made by worms; as, *worm-eaten* boards, planks, or timber.—2. Old; worthless.

**WORM-EATENNESS**, *n.* State of being worm-eaten; rottenness.

**WORMED**, *pp.* Cleared by a worm or screw.—2. In *ships*, the state of timber or plank when a number of holes or cavities are made in it by the ship worm, *Teredo navalis*. [See **TEREDO**.]

**WORM-FENCE**, *n.* A zigzag fence, made by placing the ends of the rails upon each other; sometimes called a stake fence.

**WORM-GRASS**, } *n.* Names given to  
**WORM-SEED**, } plants of the genus  
*Spigelia*. [See **SPIGELIA**.]

**WORM-HOLE**, *n.* A hole made by the gnawing of a worm.

**WORM'ING**, *ppr.* Entering by insinuation; drawing, as a cartridge; clearing, as a gun.

**WORM'ING**, *n.* An operation performed on puppies, which consists in the removal of a small worm-like ligament, situated under the tongue. This operation is ignorantly supposed to prevent madness, but in reality it only weans the animal from the habit of gnawing everything that comes in its way.—2. In *mar. lan.*, stuff wound spirally round ropes between the strands. Also the operation of winding this stuff round ropes.

**WORM-LIKE**, *a.* Resembling a worm; spiral; vermicular.

**WORM-POWDER**, *n.* A powder used for expelling worms from the stomach and intestines.

**WORM-SEED**, *n.* A seed which has the property of expelling worms from the stomach, bowels, and intestines. It is brought from the Levant, and is the produce of a species of *Artemisia*, the *A. santonica*, which is a native of Tartary and Persia.—2. A plant of the genus *Spigelia*. [See **SPIGELIA**.]

**WORM-TINCTURE**, *n.* A tincture prepared from earth-worms dried, pulverized, and mixed with oil of tartar, spirit of wine, saffron, and castor.

**WORM'UL**, *n.* [Probably a corruption of *worm-ill*.] A warble or tumour on the back of cattle. [See **WORNIL**.] It is sometimes called *puckeridge*, from its appearance on the hide.

**WORMWOOD**, *n.* [Sax. *wermud*; G. *wermuth*.] The common name of several plants of the genus *Artemisia*. Common wormwood, *A. absinthium*, a

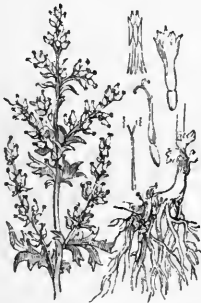

Wormwood (*Artemisia absinthium*).

well-known plant, is celebrated for its intensely bitter, tonic, and stimulating qualities, which have caused it to be an ingredient in various medicinal preparations, and even in the preparation of liqueurs. It is also useful in destroying worms in children; hence the name.

**WORMWOOD-FLY**, *n.* A small black fly, found on the stalks of wormwood.

**WORMY**, *a.* Containing a worm; abounding with worms.—2. Earthy; grovelling.

**WORN**, *pp.* of *Wear*; as, a garment long worn.—*Worn out*, quite consumed; destroyed or much injured by wear; trite.

**WORNIL**, } *n.* A tumour on the backs  
**WORNAL**, } of cattle, occasioned by a dipterous insect, which punctures the skin and deposits its eggs in each puncture. When the eggs are hatched, and the larvæ or maggots have arrived at their full size, they make their way out and leave a large hole in the hide, to prevent which the eggs should be destroyed by nipping the tumour, or thrusting in a hot wire.

**WORN'AL**, *n.* An animal of the lizard kind, about four feet long and eight inches broad, with a forked tongue. It feeds on flies, and is harmless. It is found in Egypt.

**WORRIED**, *pp.* [from *worry*.] Harassed; fatigued.

**WORRIER**, *n.* [from *worry*.] One that worries or harasses.

**WORRY**, *v. t.* [Sax. *werig*, malign vexatious; *werigan*, *werian*, to disturb, to tease, to harass, to weary; or Dan. *uroe*, trouble, Sw. *oro*. The sense of *tearing* does not properly belong to this word. It may have that sense as secondary.] 1. To tease; to trouble; to harass with impertinence, or with care and anxiety. Persons are often *worried* with care and solicitude.

Let them rail  
And then *worry* one another at their pleasure. *Rowe*.

*Worry* him out till he gives his consent. *Swift*.

A church *worried* with reformation. *South*.  
2. To fatigue; to harass with labour; a popular sense of the word.—3. To harass by pursuit and barking; as, dogs *worry* sheep.—4. To tear; to mangle with the teeth.—5. To vex; to persecute brutally.

**WORRYING**, *ppr.* Teasing; troubling; harassing; fatiguing; tearing.

**WORRYINGLY**, *adv.* Teasingly; harassingly.

**WORSE**, *a.* [Sax. *wæsse*; *wyrse*; Dan. *verre*, Sw. *vårre*. This adjective has the signification of the comparative degree, and as *bad* has no comparative and superlative, *worse* and *worst* are used in lieu of them, although radically they have no relation to *bad*.] 1. More evil; more bad or ill; more depraved and corrupt; *in a moral sense*.

Evil men and seducers shall wax *worse* and *worse*; 2 Tim. iii.

There are men who seem to believe they are not bad, while another can be found *worse*. *Rambler*.

2. In a *physical sense*, in regard to health, more sick.

She was nothing bettered, but rather grew *worse*; Mark v.

3. More bad; less perfect or good. This carriage is *worse* for wear.—*The worse*, the loss; the disadvantage.

Judah was put to *the worse* before Israel; 2 Kings xiv.

2. Something less good. Think not *the worse* of him for his enterprise.

**WORSE**, *adv.* In a manner more evil or bad.

We will deal *worse* with thee than with them; Gen. xix.

**WORSE**, to put to disadvantage, is not in use. [See **WORST**.]

**WORSEN**, *v. t.* To worse; to make worse; to obtain advantage of.

**WORSEN**, *v. i.* To grow worse.  
**WORSER**, is a vulgar word for *worse*, and not used in good writing or speaking.

**WORSHIP**, *n.* [Sax. *wæorthscype*; *worth* and *ship*; the state of worth or worthiness. See **WORTH**.] 1. Excellence of character; dignity; worth; worthiness.

Elfin born of noble state,  
And muckle *worship* in his native land. *Spenser*.

In this sense, the word is nearly or quite obsolete; but hence,—2. A title of honour, used in addresses to certain magistrates and others of rank or station.

My father desires your *worship's* company. *Shak*.

3. A term of ironical respect.—4. *Chiefly* and *eminently*, the act of paying divine honours to the Supreme Being; or the reverence and homage paid to him in religious exercises, consisting in adoration, confession, prayer, thanksgiving, and the like.

The *worship* of God is an eminent part of religion. *Tillotson*.

Prayer is a chief part of religious *worship*. *Tillotson*.

5. The homage paid to idols or false gods by pagans; as, the *worship* of Isis.—6. Honour; respect; civil deference.

Then shalt thou have *worship* in the presence of them that sit at meat with thee; Luke xiv.

7. Idolatry of lovers; obsequious or submissive respect.

**WORSHIP**, *v. t.* To adore; to pay divine honours to; to reverence with supreme respect and veneration.

Thou shalt *worship* no other God; Ex. xxxiv.

Adore and *worship* God supreme. *Milton*.

2. To respect; to honour; to treat with civil reverence.

Nor *worship'd* with a waxen epitaph. *Shak*.

3. To honour with extravagant love and extreme submission; as a lover.

With bended knees I daily *worship* her. *Cæcæ*.

**WORSHIP**, *v. i.* To perform acts of adoration.—2. To perform religious service.

Our fathers *worshipped* in this mountain; John iv.

**WORSHIPABLE**, *a.* That may be worshipped.

**WORSHIPFUL**, *a.* Claiming respect; worthy of honour from its character or dignity.

This is *worshipful* society. *Shak*.

2. A term of respect, specially applied to magistrates and corporate bodies; sometimes a term of ironical respect.

**WORSHIPFULLY**, *adv.* Respectfully.

**WORSHIPFULNESS**, *n.* The quality of being worshipful.

**WORSHIPPED**, *pp.* Adored; treated with divine honours; treated with civil respect.

**WORSHIPPER**, *n.* One who worships; one who pays divine honours to any being; one who adores.

**WORSHIPPING**, *ppr.* Adoring; paying divine honours to; treating with supreme reverence; treating with extreme submission.

**WORST**, *a.* [*superl.* of *Worse*,—which



see.] 1. Most bad; most evil; in *a moral sense*; as, the *worst* man; the *worst* sinner.—2. Most severe or dangerous; most difficult to heal; as, the *worst* disease.—3. Most afflictive, pernicious, or calamitous; as, the *worst* evil that can befall a state or an individual.

**WÖRST**, n. The most evil state; in *a moral sense*.—2. The most severe or aggravated state; the height; as, the disease is at the *worst*.—3. The most calamitous state. Be armed against the *worst*.

**WÖRST**, v. t. To get the advantage over in contest; to defeat; to overthrow. It is madness to contend, when we are sure to be *worsted*.

**WÖRSTED**, pp. Defeated; overthrown. **WÖRSTED**, n. [The origin of this word is uncertain. It is usually supposed to take its name from a town in Norfolk, England.] Yarn spun from combed wool, and which, in the spinning, is twisted harder than ordinary. It is knit or woven into stockings, caps, &c. **WÖRST'ED**, a. Consisting of worsted; made of worsted yarn; as, *worsted* stockings.

**WÖRT**, n. [Sax. *wyr*t; G. *wurz*; Fr. *vert*, *verd*; from the root of *L. vireo*, to grow; *viridis*, green.] 1. A plant; an herb; now used chiefly or wholly in compounds; as in *mugwort*, *liverwort*, *spleenwort*.—2. A plant of the cabbage kind.—3. New beer unfermented, or in the act of fermentation; the sweet infusion of malt or grain.

**WÖRTH**, a termination, signifies a farm or court; as in *Wordsworth*.

**WÖRTH**, v. i. [Sax. *weorthan*, to be or to become, to cause to be or to become.] This verb is now used only in the phrases *we worth the day*, *we worth the man*, &c., in which the verb is in the imperative mode, and the noun in the dative; *we be to the day*.

**WÖRTH**, n. [Sax. *weorth*, *wurth*, *wyr*th; G. *wert*h; D. *waarde*; W. *gwerth*; L. *virtus*, from the root of *vireo*. The primary sense is strength.] 1. Value; price; rate; that quality of a thing which renders it useful, or which will produce an equivalent good in some other thing. The *worth* of a day's labour may be estimated in money, or in goods. The *worth* of labour is settled between the hirer and the hired. The *worth* of commodities is usually the price they will bring in market; but *price* is not always *worth*.—2. Value of mental qualities; desert; merit; excellence; virtue; usefulness; as, a man or magistrate of great *worth*.

As none but she, who in that court did dwell,

Could know such *worth*, or *worth* describe  
so well. *Walter*

All *worth* consists in doing good, and in the disposition by which it is done.

*Dwight*.

3. Importance; valuable qualities; *applied to things*; as, these things have since lost their *worth*.

**WÖRTH**, a. Equal in price to; equal in value to. Silver is scarce *worth* the labour of digging and refining. In one country, a day's labour is *worth* five shillings; in another, the same labour is not *worth* one shilling. It is *worth* while to consider a subject well before we come to a decision.

If your arguments produce no conviction, they are *worth* nothing to me. *Beattie*.

2. Deserving of; in a good or bad sense,

but chiefly in a good sense. The castle is *worth* defending.

To reign is *worth* ambition, though in hell.

*Milton*.

This is life indeed, life *worth* preserving.

*Addison*.

3. Equal in possessions to; having estate to the value of. Most men are estimated by their neighbours to be *worth* more than they are. A man *worth* ten thousand pounds, in one country or place, is called rich, but not so in another.—*Worthiest of blood*, an expression in law, denoting the preference of sons to daughters in the descent of estates.

**WÖRTHIER**, a. comp. More worthy.

**WÖRTHIEST**, a. *superl.* Most worthy.

**WÖRTHILY**, adv. In a manner suited to; as, to walk *worthily* of our extraction. [*Bad.*—2. Deservedly; according to merit.

You *worthily* succeed not only to the honours of your ancestors, but also to their virtues. *Dryden*.

3. Justly; not without cause.

I affirm that some may very *worthily* deserve to be hated. *South*.

**WÖRTHINESS**, n. Desert; merit.

The prayers which our Saviour made, were for his own *worthiness* accepted.

*Hooker*.

2. Excellence; dignity; virtue.

Who is sure he hath a soul, unless

It see and judge and follow *worthiness*? *Donne*.

3. Worth; quality or state of deserving.

**WÖRTHLESS**, a. Having no value; as, a *worthless* garment; a *worthless* ship.

—2. Having no value of character or no virtue; as, a *worthless* man or woman.—3. Having no dignity or excellence; as, a *worthless* magistrate.

**WÖRTHLESSLY**, adv. In a worthless manner.

**WÖRTHLESSNESS**, n. Want of value; want of useful qualities; as, the *worthlessness* of an old garment or of barren land.—2. Want of excellence or dignity; as, the *worthlessness* of a person.

**WÖRTHY**, a. [G. *würdig*; D. *waardig*; Sw. *värddig*.] 1. Deserving; such as merits; having worth or excellence; equivalent; with *of*, before the thing deserved. She has married a man *worthy* of her.

Thou art *worthy* of the sway. *Shak*.  
I am not *worthy* of the least of all the mercies; Gen. xxxii.

2. Possessing worth or excellence of qualities; noble; illustrious; virtuous; estimable; as, a *worthy* citizen; a *worthy* magistrate; a *worthy* prince.

Happier thou may'st be, *worthier* canst not be. *Milton*.

This *worthy* mind should *worthy* things embrace. *Dantes*.

3. Suitable: having qualities suited to; either in a good or bad sense; equal in value; as, flowers *worthy* of paradise.—4. Suitable to any thing bad.

The merciless Macdonald,

*Worthy* to be a rebel. *Shak*.  
5. Deserving of ill; as, things *worthy* of stripes; Luke xii. It is often used in an ironical sense.

**WÖRTHY**, n. A man of eminent worth; a man distinguished for useful and estimable qualities; a man of valour; a word much used in the plural; as, the *worthies* of the church; political *worthies*; military *worthies*.

**WÖRTHY**, † v. i. To render worthy; to exalt.

**WÖT**, † v. i. [originally *wat*; the primitive of the obsolete verb *weet*, Sax.

*witan*, to know; formerly used also in the present, and in perfect tenses.]

To know; to be aware. [See *WERT*.]

**WÖULD**, (wood.) pret. of *Will*. [G. *wollen*; L. *volo*.] *Would* is used as an auxiliary verb in conditional forms of speech implying inclination, wish, or desire. "I *would* go, if I could." This form of expression denotes *will* or *resolution*, under a condition or supposition. You *would* go, or he *would* go, denote simply an *event*, under a condition or supposition. The condition implied in *would* is not always expressed. "By pleasure and pain, I *would* be understood to mean what delights or molests us;" that is, if it *should* be asked what I mean by pleasure and pain, I *would* thus explain what I wish to have understood. In this form of expression, which is very common, there seems to be an implied allusion to an inquiry, or to the supposition of something not expressed. *Would* has the sense of *wish* or *pray*, particularly in the phrases, "I *would* to God," "I *would* God we had died in Egypt," "I *would* that ye knew what conflict I have;" that is, I could *wish* such a thing, if the wish could avail. Here also there is an implied condition. *Would* is used also for *wish* to do, or to have. What *wouldst* thou? What *would* he?

**WÖULD' BE**, a. Wishing to be; vainly pretending to be; as, a *would be* philosopher. [*Colloq.*]

**WÖULD'ING**, † n. Motion of desire.

**WÖULD'INGNESS**, † n. Willingness.

**WÖULFE'S APPARATUS**, n. An apparatus named after the inventor, consisting of a series of bottles with several necks, used in the chemical laboratory in distillation, and for impregnating water and other liquids with gases or vapours. A common form of the apparatus is shown annexed: *a* is the

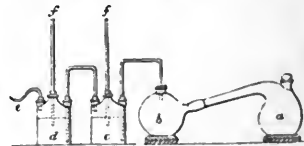

Woulfe's apparatus.

retort, into which the materials required to generate the gas or vapour are introduced. It communicates with a receiver *b*, connected with the three necked bottles *c* and *d*, by means of bent tubes. These bottles are about half filled with the fluid to be impregnated, the gas flowing through one into the other, until it escapes by the bent pipe *e*, and is again collected under a pneumatic trough. In order to compensate for the pressure of the external air, when any absorption takes place which might tend to force the fluid from the bottles back into the receiver *b*, each one is provided with a safety tube *f*, open at the top, which dipping little more than half an inch under the surface of the fluid, permits sufficient air to enter as a compensation for absorption.

**WÖUND**, n. (woound.) [Sax. *wund*; D. *wunde*; G. *wunde*; W. *gwuanu*, to thrust, to stab.] 1. A breach of the skin and flesh of an animal, or of the bark and wood of a tree, or of the bark and substance of other plants, caused by violence or external force. The self-healing power of living beings, animal

or vegetable, by which the parts separated in *wounds* tend to unite and become sound, is a remarkable proof of divine benevolence and wisdom.—2. In *sur.*, a *wound* is defined a solution of continuity in any of the soft parts of the body, occasioned by external violence, and attended with a greater or less amount of bleeding. Wounds are distinguished into *incised, punctured, contused, lacerated, and poisoned*. Wounds heal by *adhesion*, or by *suppuration, granulation, and cicatrization*.—3. Injury; hurt; as, a *wound* given to credit or reputation.

WOUND, *v. t.* (wood.) To hurt by violence; to cut, slash, or lacerate; as, to *wound* the head or the arm; to *wound* a tree.

He was *wounded* for our transgressions; Is. liii.

WOUND, *pret.* and *pp.* of *Wind*.

WOUND'ED, *pp.* Hurt; injured. [*Wounded* is used plurally as a substantive in such phrases; as, the killed and *wounded*; but the sense is plainly adjective, the suppressed word *persons* being understood.]

WOUND'ER, *n.* One that wounds.

WOUNDILY, *adv.* Excessively. [*Justic* or *hilarious*.]

WOUND'ING, *ppr.* Hurting; injuring.

WOUND'ING, *n.* Hurt; injury; Gen. iv.

WOUND'LESS, *a.* Free from hurt or injury.

WOUND'WORT, *n.* The common name of several British plants of the genus *Stachys*. [See *STACHYS*.]

WOUND'Y, *a.* Excessive. [*An old vulgar word*.]

WOURALI, } *n.* A corruption of Urari,  
WOORALI, } the native S. American  
OURARI, } name of a very virulent  
poison, used on arrows and other weapons, and made by the Indians by a peculiar process of decoction, cooling, mixing, and reboiling from the bark and juices of several plants. The substance which enters most largely into its composition, and which is probably the only essential ingredient, is the bark of *Strychnos toxifera*, called the Urari



Woorali poison tree (*Strychnos toxifera*).

vine, hence the name. Some accounts state ants, snake-fangs, and red pepper to be ingredients, but these do not at all events seem to be essential. The effects of this poison are very extraordinary, acting virulently when affecting the blood; while in small quantities it may be taken into the stomach with impunity. A well fed ox, inoculated with the poison in three non-vital parts of the body, died in twenty-five minutes. It has been suggested as likely to prove useful, when taken medicinally, in curing lock-jaw and hydrophobia.

WOU WOU, *n.* The Sumatra name for the long armed ape, the *Ungla puti* or *Hyllobates agilis*.

WOVE, *pret.* of *Weave*, sometimes the participle. *Woven* is also used. [See *WEAVE*.]

WOX, WOX'EN,† for *Waxed*.

WRACK, } *n.* [See *WRECK*.] A popular  
WRECK, } name for sea-weeds generally, but more especially when thrown ashore by the waves. Those found most plentifully on our shores are the *Fucus vesiculosus*, and the *Fucus nodosus*, which are extensively gathered for manuring land.—2. In a more restricted sense, confined to such sea-weeds as kelp is made from, chiefly belonging to the genus *Fucus*. The *grass wrack* is of the genus *Zostera*.—*Wrack*, and *to wrack*. [See *WRECK*.]  
WRACK'FUL, *a.* Ruinous; destructive.

*Note.*—*W* before *r* is always silent. WRAIN-BOLT. See *WRING-BOLT*.

WRAITH, *n.* An apparition in the exact likeness of a person, supposed by the vulgar to be seen before or soon after the person's death. [*Scotch*.]

WRANG, *n.* Wrong; injury. [*Scotch*.]

WRAN'GLE, *v. i.* [from the root of *uring*, Sw. *vränga*; that is, to wring—to twist, to struggle, to contend; or it is from the root of *ring*, to sound.] To dispute angrily; to quarrel peevishly and noisily; to brawl; to altercation.

For a score of kingdoms you should *wrangle*. *Shak.*  
He did not know what it was to *wrangle* on indifferent points. *Addison.*

2. In *old times*, in the *universities*, to dispute publicly; that is, to defend, or oppose a thesis. Hence the term *wrangler*, still retained in the university of Cambridge.

WRAN'GLE, *v. t.* To involve in contention, quarrel, or dispute. [*Little used*.]

WRAN'GLE, *n.* An angry dispute; a noisy quarrel.

WRAN'GLER, *n.* An angry disputant; one who disputes with heat or peevishness; as, a noisy contentious *wrangler*.—*Senior wrangler*, in the university of Cambridge, the student who passes the best examination for the degree of Bachelor of Arts in the senate house. Then follow the second, third, &c., wranglers. At the close of the last day of examination, those who have distinguished themselves most, are divided into three classes, viz., *wranglers*, *senior optimes*, and *junior optimes*. The wranglers are the first in merit, and the individual who distinguishes himself most, is termed the *senior wrangler*, and is the most distinguished mathematician of his year. All who are in these three lists, (which are collectively called the *tripsos*), are said to take the Bachelor's degree *with honours*, or to *go out* in honours. The remainder are called the *ἰ παλλοι*, or the *Pol*, literally, *the multitude*.

WRAN'GLERSHIP, *n.* In the *university of Cambridge*, the honour conferred on those whose names are inscribed in the list of wranglers.

WRAN'GLESOME, *a.* Contentious; quarrelsome.

WRAN'GLING, *ppr.* Disputing or contending angrily.

WRAN'GLING, *n.* The act of disputing angrily; altercation.

WRAP, *v. t.* *pret.* and *pp.* *Wrapped* or *Wrapt*. 1. To wind or fold together; John xx.—2. To involve; to cover by

winding something round; often with *up*; as, to *wrap up* a child in its blanket; *wrap* the body well with flannel in winter.

I, *wrapt* in mist  
Of midnight vapour, glide obscure. *Milton*.  
3. To involve; to hide; as, truth *wrapt* in tales.—4. To comprise; to contain.

Leontine's young wife, in whom all his happiness was *wrapped up*, died in a few days after the death of her daughter. *Addison*.

5. To involve totally. Things reflected on in gross and transiently, are thought to be *wrapped* in impenetrable obscurity. *Locke*.

6. To inclose.—7. To snatch up; to transport. This is an error. It ought to be *rapt*. [See *RAP* and *RAPT*.]

WRAP'PAGE, *n.* That which wraps; act of wrapping.

WRAPPED, } *pp.* Wound; folded;  
WRAPT, } inclosed.

WRAPPER, *n.* One that wraps.—2. That in which any thing is wrapped or inclosed; an envelope.—3. A loose upper garment; applied sometimes to a lady's undress, and sometimes to a loose over-coat.

WRAP'PING, *ppr.* Winding; folding; involving; in covering.—2. *a.* Used or designed for wrapping or covering; as, *wrapping paper*.

WRAP'PING, *n.* That in which any thing is wrapped; a cover; an envelope; act of one who wraps; a wrapper.

WRAP'RASCAL, *n.* A cant term for a coarse upper-coat.

WRAPT. [This word is often erroneously used for *rapt*, a term of a totally different meaning. See *RAPT*.]

WRASSE, *n.* The English name of various species of fish, inhabiting the rocky parts of the coast, and belonging to the family Labridæ, (genus *Labrus*, Linn). They are prickly-spined, hard-boned fishes, with oblong scaly bodies and a single dorsal fin; their lips are large, double, and fleshy; hence the generic name *Labrus*; and their teeth strong, conical, and sharp. Many of the species present vivid colours, particularly in spring, just before the spawning season. Several species are natives of the British seas; as the Ballan wrasse, or old wife (*L. tinca*), which in length



Ballan wrasse (*Labrus tinca*).

is often 18 inches; the green-streaked wrasse (*L. lineatus*); the cook wrasse, or blue striped wrasse, (*L. variegatus*); the rainbow wrasse (*Julis vulgaris*), &c. As articles of food they are not much valued in this country.

WRATH, *n.* [Sax. *wrath*, *wræth*; W. *irad*, of which *L. ira* is a contraction; Ar. *eratha*; Gr. *ἔραθος*, to provoke.] 1. Violent anger; vehement exasperation; indignation; as, the *wrath* of Achilles.

When the *wrath* of king Ahasuerus was appeased; *Esth. ii.*

O Lord, revive thy work in the midst of the years, in the midst of the years make known; in *wrath* remember mercy; Hab. iii. 2.

2. The effects of anger; Prov. xxvii.—  
 3. The just punishment of an offence or crime; Rom. xiii.—*God's wrath*, in Scripture, is his holy and just indignation against sin; Rom. i.

**WRATHFUL**, *a.* Very angry; greatly incensed. The king was very *wrathful*.—2. Springing from wrath, or expressing it; as, *wrathful* passions; a *wrathful* countenance.

**WRATHFULLY**, *adv.* With violent anger.

**WRATHFULNESS**, *n.* Vehement anger.

**WRATHILY**, *adv.* With great anger. [*Colloq.*]

**WRATHLESS**, *a.* Free from anger.

**WRATHY**, *a.* Very angry; a *colloquial* word.

**WRAWL**, *† v. i.* [*Sw. vråla, to bawl.*] To cry as a cat.

**WREAK**, *v. t.* [*Sax. wræcan, wræccan*; *D. wreekan*; *G. rüchen*; perhaps allied to *break*. The sense is to drive or throw, to dash with violence.] 1. To execute; to inflict; to hurl or drive; as, to *wreak* vengeance on an enemy. On me let death *wreak* all his rage.

*Millon.*

2. To revenge. Come *wreak* his loss, whom bootless ye complain.

*Fairfax.*

Another's wrongs to *wreak* upon thyself.

*Spenser.*

[*This latter sense is nearly or quite obsolete.*]

**WREAK**, for *Reck*, to care, is a mistake.

**WREAK, † n.** Revenge; vengeance; furious passion.

**WREAKFUL**, *a.* Revengeful; angry.

**WREAKLESS**, *a.* Unrevengeful; weak.

**WRATH**, *n.* [*Sax. wræth, wreoth.* See *WRITE*.] 1. Something twisted or curled; as, a *wreath* of flowers. Hence,—2. A garland; a chaplet; an ornamental twisting bandage.

*Anon.*

3. In *her.*, a roll of fine linen or silk, like that of a Turkish turban, consisting of the colours borne in the escutcheon, placed in an achievement between the helmet and the crest, and immediately supporting the crest.

**WRATH,** } *v. t. pret. Wreathed; pp.*  
**WRATH,** } *Wreathed, Wreathen.*

1. To twist; to convolve; to wind one about another; as, to *wreath* a garland of flowers.—2. To interweave; to entwine; as, chains of *wreathed* work.—3. To encircle, as a garland.

*Prior.*

The flowers that *wreath* the sparkling bowl.

4. To encircle as with a garland; to dress in a garland.

*Dryden.*

And with thy winding ivy *wreaths* her lance.

5. † To writhe.

**WRATH,** } *v. i.* To be interwoven or  
**WRATH,** } entwined; as, a bower of  
**WRATH,** } *wreathing* trees.

**WRATHED**, *pp.* Twisted; entwined; interwoven.—*Wreathed column*, in *arch.*, a column twisted in the form of a screw; called also a *contorted column*.

**WRATHING**, *pp.* Twisting; entwining; encircling.

**WRATHING**, *n.* Act of twisting or encircling; a wreath.

**WRATHLESS**, *a.* Destitute of a wreath.

**WRATHY**, *a.* Twisted; curled; spiral; as, a *wrathy* spire.

**WRECK**, *n.* [*Dan. vrag, a wreck, shipwreck*; *Sw. vrak, refuse*; *Sax. wrac, wracca*, an exile, a wretch; *D.*

*wrah*, broken, a wreck. This word signifies properly that which is cast, driven, or dashed, or that which is broken.] 1. Destruction; properly, destruction by sea; the destruction of a ship or vessel by being driven on rocks, shallows, &c. Hence,—2. The ruins of a ship stranded; a ship dashed against rocks or land and broken, or otherwise rendered useless by violence and fracture; any ship or goods driven ashore or found floating at sea in a deserted or unmanageable condition.

In the legal sense of the term, *wreck* must have come to land; when at sea, it is distinguished by the terms *flotsam, jetsam, and ligan*. Goods thrown on land, after a shipwreck, belong, at common law, to the crown, or to the lord of the manor, who enjoys the franchise of wreck, if they are not claimed within a year and a day. The plundering and stealing from wrecks is a felony.—3. Dissolution by violence; ruin; destruction.

The *wreck* of master and the crush of worlds.

*Addison.*

4. The remains of any thing ruined; dead weeds and grass.—5. In *metallurgy*, the vessel in which ores are washed the third time.—6. In a *moral sense*; as, his mind is the mere *wreck* of what it was.—7. *Wreck*, for *Wreak*, is less proper. [See also *RECK*.]

**WRECK, v. t.** [*Sw. vråka, to throw away.*] 1. To strand; to drive against the shore, or dash against rocks, and break or destroy.—2. To ruin; as, they *wreck* their own fortunes.—3. *Wreck*, for *wreak*, is improper.

**WRECK, v. i.** To suffer wreck or ruin.

**WRECKAGE**, *n.* The act of wrecking; the ruins or remains of a ship or cargo that has been wrecked.

**WRECKED**, *pp.* Dashed against the shore or on rocks; stranded and ruined.

**WRECKER**, *n.* One who plunders the wrecks of ships.—2. One who, by delusive lights or other signals, causes ships to mistake their course and be cast ashore, that he may obtain plunder from the wreck.

**WRECKFUL**, *a.* Causing wreck.

**WRECKING**, *pp.* Stranding; running on rocks or on shore; ruining.

**WRECK-MASTER**, *n.* Master of wrecks.

**WREN**, *n.* [*Sw. wrenna*; *Ir. drean.*] One of a group of small insessorial birds, placed by Linnaeus in the genus *Motacilla*. According to the arrangement of Cuvier, the common wrens are of the genus *Troglodytes*, and the gold-crested wrens of the genus *Regulus*.

Wrens feed chiefly on insects, and are often very familiar with man. The common wren (*T. vulgaris*), is a well known favourite little bird, of very brisk and lively habits.

During winter it approaches near the dwellings of man, taking shelter in the roofs of houses, barns, and in hay stacks. In spring it betakes itself to the woods, where it builds its nest. The American house-wren, *T. domesticus*, is also a very familiar bird, and a general favourite in America.

**WRENCH, v. t.** [*G. verrenken*; *D. verwringen.* See *WRING*. *Qu. Ir. freanc.*] 1. To pull with a twist; to wrest, twist, or force by violence; as, to *wrench* a sword from another's hand.—2. To strain; to sprain; to distort.

You *wrenched* your foot against a stone.

*Swift.*

**WRENCH, n.** A violent twist, or a pull

with twisting.—2. A sprain; an injury by twisting; as, in a joint.—3. An instrument for screwing or unscrewing iron work.—4. † Means of compulsion.—5. † In the plural, sleights; subtleties.

**WRENCH'ED**, *pp.* Pulled with a twist; sprained.

**WRENCH'ING**, *pp.* Pulling with a twist; wresting violently; spraining.

**WREST, v. t.** [*Sax. wræstan*; *G. reissen*, to wrest, to snatch or pull, to burst, to tear; *Dan. vrister. Qu. L. restis*, a rope.] 1. To twist or extort by violence; to pull or force from by violent wringing or twisting; as, to *wrest* an instrument from another's hands.—2. To take or force from by violence. The enemy made a great effort, and *wrested* the victory from our hands.

But fate has *wrested* the confession from me.

*Addison.*

3. To distort; to turn from truth or twist from its natural meaning by violence; to pervert.

*Wrest* once the law to your authority. *Shak.*

Thou shalt not *wrest* the judgment of the poor; *Exod. xxiii.*

Which they that are unlearned and unstable *wrest*, as they do also the other scriptures, to their own destruction; 2 *Pet. iii.*

**WREST, n.** Distortion; violent pulling and twisting; perversion.—2. † Active or moving power.—3. An instrument to tune with.

**WREST'ED**, *pp.* Pulled with twisting; distorted; perverted.

**WRESTER**, *n.* One who wrests or perverts.

**WREST'ING**, *pp.* Pulling with a twist; distorting; perverting.

**WRESTLE, v. t.** (*res'1.*) [*Sax. wræstlian* or *wrazlian*; *D. worstelen.*] 1. To contend by grappling, and trying to throw down; to strive with arms extended, as two men, who seize each other by the collar and arms, each endeavouring to throw the other by tripping up his heels and twitching him off his centre.

Another, by a fall in *wrestling*, started the end of the clavicle from the sternum.

*Wiseman.*

2. To struggle; to strive; to contend. We *wrestle* not against flesh and blood; *Eph. vi.*

**WRESTLE, v. t.** (*res'1.*) To overcome in wrestling.

**WRESTLER**, *n.* One who wrestles; or one who is skillful in wrestling.

**WRESTLING**, *pp.* Striving to throw; contending.

**WRESTLING, n.** Strife; struggle; contention.—2. An athletic exercise between two persons unarmed, who grapple with each other, body to body, to prove their strength and dexterity, and try which can throw his opponent on the ground.

Wrestling is an exercise of very great antiquity and fame. It was in use in the heroic age, and formed one of the athletic exercises among the Greeks from the earliest times. It had considerable rewards and honours assigned to it at the Olympic games.

**WRETCH, n.** [*Sax. wræcca*, one who is driven, an exile. See *WRECK*.] 1. A miserable person; one sunk in the deepest distress; as, a forlorn wretch.—2. A worthless mortal; as, a contemptible *wretch*.—3. A person sunk in vice; as, a profligate *wretch*.—4. It is sometimes used by way of slight or ironical pity or contempt.

Poor *wretch* was never frightened so.

*Drayton.*

5. It is sometimes used to express tenderness; as we say, *poor thing*.

WRETCH'ED, *a.* Very miserable; sunk into deep affliction or distress, either from want, anxiety, or grief.

The *wretched* find no friends. *Dryden*.  
2. Calamitous; very afflicting; as, the *wretched* condition of slaves in Algiers.—3. Worthless; paltry; very poor or mean; as, a *wretched* poem; a *wretched* cabin.—4. Despicable; hatefully vile and contemptible. He was guilty of *wretched* ingratitude.

WRETCH'EDLY, *adv.* Most miserably; very poorly. The prisoners were *wretchedly* lodged.—2. Unhappily; as, two wars *wretchedly* entered upon.—3. Meantly; despicably; as, a discourse *wretchedly* delivered.

WRETCH'EDNESS, *n.* Extreme misery or unhappiness, either from want or sorrow; as, the *wretchedness* of poor mendicants.

We have, with the feeling, lost the very memory of such *wretchedness* as our forefathers endured. *Raleigh*.

The prodigal brought nothing to his father but his rags and *wretchedness*. *Dwight*.  
2. Meanness; despicableness; as, the *wretchedness* of a performance.

WRETCH'LESS, for *Reckless*, is improper.

WRETCH'LESSNESS, for *Recklessness*, is improper.

WRIG, † for *Wriggle*.

WRIG'GLE, *v. i.* [*W. wrigglaw*, to move briskly; *D. wriggelen* or *wriikken*.] To move the body to and fro with short motions.

Both he and his successors would often *wriggle* in their seats, as long as the cushion lasted. *Swift*.

WRIG'GLE, *v. t.* To put into a quick reciprocating motion; to introduce by a shifting motion.

*Wriggling* his body to recover

His seat, and cast his right leg over.

*Hudibras*.

WRIG'GLE, † *a.* Pliant; flexible.

WRIG'GLER, *n.* One who wriggles.

WRIG'GLING, *ppr.* Moving the body one way and the other with quick turns.

WRIGHT, *n.* [*Sax. wryhta*; from the root of *work*.] An artificer; one whose occupation is some kind of mechanical business; a workman; a manufacturer. This word is now chiefly used in compounds, as in *shipwright*, *wheelwright*.

WRIGHTIA, *n.* A genus of plants, nat.



Wrightia tinctoria.

order Apocynaceæ. The species are chiefly natives of the East and West

Indies; they are erect shrubs, or small trees, with opposite leaves, and corymbs of mostly white flowers. *W. antidiysenterica* furnishes the conessi bark, said to be a specific in dysentery. The wood is used by the turner and cabinet-maker. Scarlet wrightia (*W. coccinea*), yields a very light and firm wood, used by turners, and also for making palankeens. *W. tomentosa* yields, when wounded, a yellow juice, which, when mixed with water, dyes clothes, dipped into it, of a yellow colour. *W. tinctoria* is used as a substitute for indigo.

WRING, *v. t.* pret. and pp. *Wringed* and *Wrung*. The latter is chiefly used. [*Sax. teringan*; *G. ringen*; *D. wringen*; *Dan. ringer*. The sense is to strain.]  
1. To twist; to turn and strain with violence; as, to *wring* clothes in washing.—2. To squeeze; to press; to force by twisting; as, to *wring* water out of a wet garment.—3. To writhe; as, to *wring* the body in pain.—4. To pinch.

The king began to find where his shoe did *wring* him. † *Bacon*.

If he had not been too much grieved and *wrung* by an uneasy and strait fortune. † *Clarendon*.

5. To distress; to press with pain.

Didst thou taste but half the griefs  
That *wring* my soul, thou couldst not talk  
thus coldly. *Addison*.

6. To distort; to pervert.

How dare these men thus *wring* the  
Scriptures? *Whitgift*.

7. To persecute with extortion.  
These merchant adventurers have been  
often wronged and *wringed* to the quick.

*Hayward*.

8. To bend or strain out of its position; as, to *wring* a mast.—*To wring off*, to force off or separate by wringing; as, to *wring off* the head of a fowl.—*To wring out*, to force out; to squeeze out by twisting; as, to *wring out* dew or water; *Judges vi*.—2. To free from a liquor by wringing; as, to *wring out* clothes.—*To wring from*, to force from by violence; to extort; as revenues *wrung from* the poor; to *wring from* one his rights; to *wring a secret from* one.

WRING, *v. i.* To writhe; to twist; as with anguish.

WRING, † *n.* Action of anguish; torture.

WRING'-BOLT, *n.* [*wring and bolt*.] A bolt used by shipwrights, to bend and secure the planks against the timbers till they are fastened by bolts, spikes, and tree-nails. It is also called a *ring-bolt*.

WRING'ED, *pp.* Twisted; pressed; distressed; extorted.

WRING'ER, *n.* One who wrings; one that forces water out of any thing by wringing.

WRING'ING, *ppr.* Twisting; writhing; extorting.

WRING'ING, *n.* The act of pressing and twisting the hands in anguish; a twisting or writhing.

WRING'ING-WET, *a.* So wet as to require wringing, or that water may be wrung out.

WRING'-STAVES, *n.* Strong bars of wood used in applying wring-bolts, for the purpose of setting-to the planks. They are also called *wrain-staves* and *dwang-staves*.

WRINK'LE, *n.* [*Sax. wrinle*; *Sw. rynka*; *Dan. rynke*. This coincides with *ring*, a circle. The Dutch write this word *krinkle*, and *kring* is *ring*.

The *G. runzel* is probably of the same family, formed on *Rg*; *Ir. rang*. If *n* is casual, the root coincides with *L. ruga*, a wrinkle, and *W. rhyg*, a furrow.] 1. A small ridge or prominence, or a furrow, formed by the shrinking or contraction of any smooth substance; corrugation; a crease; as, *wrinkles* in the face or skin.—2. A fold or rumple in cloth.—3. Roughness; unevenness.

Not the least *wrinkle* to deform the sky. *Dryden*.

WRINK'LE, *v. t.* [*Sax. wrinleian*; *Sw. rynka*; *Dan. rynker*.] 1. To contract into furrows and prominences; to corrugate; as, to *wrinkle* the skin; to *wrinkle* the brow.

Her *wrinkled* form in black and white array'd. *Pope*.

2. To make rough or uneven.

A keen north wind, blowing dry,

*Wrinkled* the face of deluge, as decay'd. *Milton*.

WRINK'LE, *v. i.* To shrink into furrows and ridges.

WRINK'LED, *pp.* Contracted into ridges and furrows.

WRINK'LED, *a.* Having wrinkles; as, a *wrinkled* face; corrugated.

WRINK'LING, *ppr.* Shrinking; contracting into furrows and ridges.

WRINK'LY, *a.* Somewhat wrinkled; having a tendency to be wrinkled.

WRIST, *n.* [*Sax. wrist*; allied probably to *wrest* and *wrestle*; that is, a twist or junction.] 1. The carpus; the joint by which the hand is united to the arm, and by means of which the hand moves on the forearm. It consists of eight bones disposed in two rows, four in each row. These bones are connected to each other, and to the metacarpal bones, by numerous ligaments. Their motions on the forearm may be described as those of *flexion*, *extension*, *abduction*, and *circumduction*.—2. In the *manege*, the *bridle wrist* is that of the horseman's left hand.

WRIST BAND, *n.* [*wrist and band*.] That band or part of a shirt sleeve which covers the wrist.

WRIST'LET, *n.* An elastic bandlet worn round a lady's wrist, to confine the upper part of a glove.

WRIT, *n.* [from *write*.] That which is written. In this sense, *writ* is particularly applied to the Scriptures, or books of the Old and New Testament; as, holy *writ*; sacred *writ*.—2. In *law*, a precept under seal, in the name of the king, judge, or other person, having jurisdiction in the particular subject matter, and directed to some public officer, or private person, commanding him to do something in relation to a suit or action. A writ may be considered the process connected with the origin and progress of a civil or criminal proceeding. Civil writs are divided into *original* and *judicial*. Original writs issue out of the court of chancery, and give authority to the courts in which they are returnable to proceed with the cause. Judicial writs issue out of the court in which the action is pending. Original writs have been superseded by the *writ of summons*, except in regard to a few real actions. Writs, in English law, are so multifarious, that to enumerate them even by name would occupy a large space. Some of the more important are, the writ to the sheriff of a county to elect a member, or members, of parliament; writs of *habeas corpus*; writs

of *subpœna ad testificandum*, and of *subpœna duces tecum*; writ of *privilege*; writs of *prohibition*, *mandamus* and *quo warranto*.—*Patent writs*, the same as letters patent.—*Close writs*, those which are, or are supposed to be, sealed up, and are directed to some officer or other individual subject. In *Scots law*, the term *writ* is sometimes used to signify a writing, a deed, &c.—3. A legal instrument.

WRIT, *pret.* of *Write*, is not now used. [See *WRITE* and *WROTE*.]

WRITATIVE, *a.* Disposed to write; having desires towards authorship. [*Sportive* or *scornful*.]

WRITE, *v. t. pret.* *Write*; *pp.* *Written*. *Writ* for the *pret.* and part. is no longer used, and *wrote* for the part. is also discontinued. [Sax. *writan*, *awritan*, *geowitan*; Ice. *rita*; Goth. *writs*, a letter. The sense is to scrape, to scratch, to rub; probably from the root of *grate*, and *L. rado*.] 1. To form by a pen on paper or other material, or by a graver on wood or stone; as, to *write* the characters called letters; to *write* figures. We *write* characters on paper with pen and ink; we *write* them on stone with a graving tool.—2. To express by forming letters and words on paper or stone; as, to *write* a deed; to *write* a bill of divorce. The ten commandments were *written* with the finger of God on tables of stone; Exod. xxxi.—3. To engrave. [See the preceding definition.]—4. To impress durably. *Write* useful truths on the heart.—5. To compose or produce, as an author.—6. To copy; to transcribe.—7. To communicate by letter.

I chose to *write* the thing I durst not speak to her I lov'd. *Prior*.

WRITE, *v. i.* To perform the act of forming characters, letters, or figures, as representatives of sounds or ideas. Learn to *write* when young.—2. To be employed as a clerk or amanuensis. A *writes* for B. D *writes* in one of the public offices.—3. To play the author; as, he thinks, he speaks, he *writes*, he sings.—4. To recite or relate in books. Josephus *wrote* of the wars of the Jews.—5. To send letters.

He *wrote* for all the Jews concerning their freedom. *Esdra*s.

6. To call one's self; to be entitled; to use the style of.

Those who began to *write* themselves men, but thought it no shame to learn. *Fell*.

7. To compose; to frame or combine ideas and express them in words.

They can *write* up to the dignity and character of their authors. *Felton*.

WRITER, *n.* One who writes or has written.—2. An author.—3. A clerk or amanuensis; a scribe.—4. A penman.—5. In *Scotland*, a legal practitioner; a solicitor; a term of nearly the same import as attorney in England.—*Writers to the signet*, a numerous society of lawyers in Scotland, equivalent to the highest class of attorneys in England. Their peculiar privilege is that of preparing the writs which pass the royal signet. They also enjoy the privilege of conducting cases before the court of session, the court of justiciary, and the commission of teinds. [See *SIGNET*.]—*Writer of the tallies*, formerly an officer of the exchequer of England; a clerk to the auditor of the receipt, who wrote upon

the tallies the whole of the tellers' bills. [See *TALLY*.]

WRITERSHIP, *n.* The office of writer. *WRITHE*, *v. t.* [Sax. *writan*; Sw. *wrida*; Dan. *wriden*.] 1. To twist; to distort.

Her mouth she *writhe'd*. *Dryden*.

2. To twist with violence; as, to *writhe* the body.—3.† To wrest; to distort; to torture; as, to *writhe* words.

WRITHE, *v. t.* To twist; to be distorted; as, to *writhe* with agony.

WRITHE, *pp.* Twisted; distorted.

WRITHING, *ppr.* Twisting; distorting.

WRITHE,† *v. t.* [from *writhe*.] To wrinkle.

WRITING, *ppr.* Forming, as characters, with a pen, style, or graver.—2. *a.* Used or intended for writing; as, *writing* paper.—*Writing materials*, such articles as are requisite for writing; as paper, pen, and ink.

WRITING, *n.* The act or art of forming letters and characters on paper, wood, stone, the inner bark and leaves of certain trees, or other material, for the purpose of recording the ideas which characters and words express, or of communicating them to others by visible signs. We hardly know which to admire most, the ingenuity or the utility of the art of *writing*.—2. Any thing written or expressed in letters; hence, any legal instrument, as a deed, a receipt, a bond, an agreement, &c.—3. A book; a manuscript; any written composition; a pamphlet; as, the *writings* of Addison.—4. An inscription; John xix.—5. *Writings*, plur. conveyances of lands; deeds; or any official papers.

WRITING-BOOK, *n.* A blank paper book for practice in penmanship; a copy-book.

WRITING-DESK, *n.* A table, with a sloped top, used in schools for learning to write on.—2. Any desk used for writing on. [See *DESK*.]

WRITING-MASTER, *n.* One who teaches the art of penmanship.

WRITING-SCHOOL, *n.* A school or an academy where hand-writing or calligraphy is taught.

WRITING-TABLE, *n.* A table used for writing on, having commonly a desk part, drawers, &c.

WRITING-TEN, *pp.* Expressed in letters.—*Written laws*, statutes; laws enacted by the supreme power and recorded; as, contradistinguished from *unwritten* or *common law*.

WRITZLED,† for *Writhled*.

WROKEN,† for *Wreaked*.

WRONG, *a.* [Sw. *wrang*; Dan. *wrang*; properly the participle of *wring*, Sw. *wringa*, Dan. *wrænger*.] Literally, *wring*, twisted, or turned from a straight line or even surface. Hence, 1. Not physically right; not fit or suitable; as, the *wrong* side of a garment. You hold the book the *wrong* end uppermost. There may be something *wrong* in the construction of a watch or an edifice.—2. Not morally right; that deviates from the line of rectitude prescribed by God; not just or equitable; not right or proper; not legal; erroneous; as, a *wrong* practice; *wrong* ideas; a *wrong* course of life; *wrong* measures; *wrong* inclinations and desires; a *wrong* application of talents; *wrong* judgment; Hab. i.—3. Erroneous; not according to truth; as, a *wrong* statement.

WRONG, *n.* Whatever deviates from

moral rectitude; any injury done to another; a trespass; a violation of right. Wrongs are *private* or *public*. *Private* wrongs are civil injuries, immediately affecting individuals; *public* wrongs are crimes and misdemeanours which affect the community.

Sarai said to Abraham, My *wrong* be on thee; Gen. xvi.

Friend, I do thee no *wrong*; Matth. xx. The obligation to redress a *wrong*, is at least as binding as that of paying a debt.

*E. Everett*.

WRONG, *adv.* Not rightly; amiss; morally ill; erroneously.

Tea censure *wrong* for one that writes amiss. *Pope*.

WRONG, *v. t.* To injure; to treat with injustice; to deprive of some right, or to withhold some act of justice from. We *wrong* a man, when we defraud him and when we trespass on his property. We *wrong* a man when we neglect to pay him his due; Philemon 18.—2. To do injustice to by imputation; to impute evil unjustly. If you suppose me capable of a base act, you *wrong* me.

WRONG-DÖER, *n.* One who injures another, or does wrong.

WRONG-DÖING, *n.* Evil or wicked act or action.

WRONG'ED, *pp.* Treated unjustly; injured.

WRONG'ER, *n.* One who injures another.

WRONG'FUL, *a.* Injurious; unjust; as, a *wrongful* taking of property; *wrongful* dealing.

WRONG'FULLY, *adv.* Unjustly; in a manner contrary to the moral law or to justice; as, to accuse one *wrongfully*; to suffer *wrongfully*.

WRONG'FULNESS, *n.* Quality of being wrong or wrongful; injustice.

WRONG HEAD, *n.* A person of a misapprehending mind and an obstinate character.

WRONG-HEAD'ED, *a.* [*wrong* and *head*.] Wrong in opinion or principle; having a perverse understanding; perverse.

WRONG-HEAD'EDNESS, *n.* Perverseness; erroneousness.

WRONG'ING, *ppr.* Injuring; treating with injustice.

WRONG'LESS,† *a.* Void of wrong.

WRONG'LESSLY,† *adv.* Without injury to any one.

WRONG'LY, *adv.* In a wrong manner; unjustly; amiss. He judges *wrongly* of my motives.

WRONG'NESS, *n.* Wrong disposition; error.

WRONGOUS, *n.* Not right; unjust; illegal. *Wrongous imprisonment*, in *Scots law*, false or illegal imprisonment; a trespass committed against a person by arresting and imprisoning or detaining him without just cause, and contrary to law.

WRONG'-TIMED, *a.* Done at an improper time.

WROTE, *pret.* of *Write*. He *wrote* a letter yesterday. Herodotus *wrote* his history more than two thousand years ago.

*Note*.—*Wrote* is not now used as the participle.

WROTH, *a.* (rauth.) Sax. *wæth*, *wrath*, See *WRATH*. Very angry; much exasperated.

Caio was very *wroth*, and his countenance fell; Gen. iv.

I was *wroth* with my people; Is. xlviii. [*An excellent word, and not obsolete*.]

WROUGHT, *pret.* and *pp.* of *Work*. (*raut.*) [*Sax. worhte*, the *pret.* and *pp.* of *wircan, weorecan*, to work.] 1. Worked; formed by work or labour; manufactured.—2. Effected; performed.

She hath wrought a good work upon me; *Matth.* xxvi.

3. Effected; produced. He wrought the public safety. A great change was wrought in his mind.

This wrought the greatest confusion in the unbelieving Jews. *Addison.*

4. Used in labour. The elders of that city shall take a heifer that hath not been wrought with; *Deut.* xxi.

5.† Worked; driven; as, infection wrought out of the body.—6. Actuated. Vain Morat, by his own rashness wrought. *Dryden.*

7. Worked; used; laboured in. The mine is still wrought.—8. Formed; fitted.

He that hath wrought us for the same thing is God; 2 *Cor.* v.

9.† Guided; managed.—10. Agitated; disturbed.

My dull brain was wrought,

With things forgot. *Shak.*

Wrought iron, iron deprived of its carbon, usually by the process called *puddling*,—*which see*. By this process the iron is rendered tough, flexible, malleable, and ductile.—*Wrought on or upon*, influenced; prevailed on. His mind was wrought upon by divine grace. *Wrought to or up to*, excited; inflamed. Their minds were wrought up to a violent passion. She was wrought up to the tenderest emotions of pity.

WRUNG, *pret.* and *pp.* of *Wring*.

WRY, *a.* [*Goth. wraicwa*, or *Dan. vrier*,

to twist, contracted from *wriðer*, Eng. to *writhe*.] 1. Twisted; turned to one side; distorted; as, a wry neck; a wry mouth.—2. Deviating from the right direction; as, wry words.—3. Wrested; perverted; as, to put a wry sense on an author's words.

WRY,† *v. i.* To be writhed or distorted.

WRY,† *v. t.* To distort; to wrest.

WRY'NECK, *n.* [*wry* and *neck*.] A twisted or distorted neck; a deformity in which the neck is drawn to one side, and at the same time somewhat forward.—2. A disease of the spasmodic kind in sheep, in which the head is drawn to one side.—3. In *ornithology*, a small migratory bird resembling the woodpeckers, the *Yunz torquilla*; so



Wryneck (*Yunz torquilla*).

called from the singular manner in which, when surprised, it turns its head over its shoulders. It is found in various parts of Europe; and generally precedes the cuckoo a few

days. It is remarkable for its long tongue, its power of protruding and retracting it, and the writhing snake-like motion which it can impart to its neck, without moving the rest of the body. It is also known by the names of *long-tongue*, *emmet-hunter*, *snake-bird*, *cuckoo's mate*, &c.

WRY'NECKED, *a.* Having a distorted neck.

WRY'NESS,† *n.* The state of being wry or distorted.

WUKF, } *n.* In the *East Indies*, an endowment; land granted for some charitable or pious purpose.

WYCH'-ELM, *n.* A British plant of the genus *Ulmus*, the *U. montana*. It is a large spreading tree with large broadly elliptical leaves, and grows in woods in England and Scotland. [*See Ulmus.*]

WYCH'-HAZEL, *n.* The common name of plants of the genus *Hamamelis*, the type of the nat. order *Hamamelaceæ*. They are small trees, with alternate leaves on short petioles, and yellow flowers, disposed in clusters in the axils of the leaves, and surrounded by a three-leaved involucre. They are natives of North America, Persia, or China, but their properties are unknown.



Wyvern.

WYND, *n.* An alley; a lane. [*Scotch.*]

WY'VERN, *n.* In *her.*, an imaginary animal, a kind of flying serpent, sometimes represented in coats of arms.

## X.

**X**, THE twenty-fourth letter of the English Alphabet, is borrowed from the Greek. In the middle and at the end of words, it has the sound of *ks*, as in *wax, lax, luxury*. At the beginning of a word, it has precisely the sound of *z*. It is used as an initial, in a few words borrowed from the Greek. As a numeral, X stands for ten. It represents one V, which stands for five, placed on the top of another. When laid horizontally, thus X, it stands for a thousand, and with a dash over it, thus X̄, it stands for ten thousand. As an abbreviation, X, stands for *Christ*, as in *Xn. Christian*; *Xm. Christmas*.

XANG'TI, *n.* In *China*, a name for God.

XAN'THATE, *n.* A compound formed by the union of xanthic acid with a salifiable base; as, *xanthate* of potash.

XAN'THIC, *a.* [*Gr. ξανθος*, yellow.] Tending towards a yellow colour.

XAN'THIC ACID, *n.* The name formerly given to a sulpho-carbonate of ethule and water, from the yellow colour of its salts. It is a heavy oily liquid.

XAN'THIC-OXIDE, *n.* Uric oxide, a very rare ingredient of urinary calculi, and said to occur in small quantities in some kinds of guano.

XANTHINE, *n.* The yellow dyeing matter contained in madder.

XAN'THITE, *n.* A mineral composed of silica, lime, alumina, with small portions of the peroxides of iron and manganese, and also magnesia and water. It occurs in Orange county, North Carolina.

XAN'THIUM, *n.* Bur-weed, a genus of plants; nat. order *Compositæ*. *X. strumarium*, broad-leaved bur-weed, is a British plant. It is rank and weed-like, and remarkable for the curious structure of its flowers, and the prickly involucres which surround the fertile ones, enlarging and becoming part of the fruit. It is found in waste ground in the south of England.

XAN'THO, *n.* [*Gr. ξανθος*, yellow.] Leach's name for a genus of brachyurous crustaceans.

XANTHOCHY'MUS, *n.* A genus of plants, nat. order *Guttiferæ*. *X. pictorius*, is a native of the East Indies, with white flowers and yellow fruit. The fruit yields a resinous juice of a yellow colour, which is used as a water colour, either alone for yellow, or with blues to form a green. The gamboge of commerce is supposed to be yielded by this plant.

XANTHOGEN, } *n.* The base of hy-XANTHOGENE, } droxanthic acid procured by the action and re-action of carburet of sulphur and potash, and taking its name from the yellowish colour of some of its compounds.

XAN'THOPHYLLE, *n. Bot.* A peculiar waxy matter, to which some attribute the yellow colour of some leaves.

XANTHOPRO'TEIC ACID, *n.* An acid formed when proteine or any of its modifications is digested in nitric acid. It is of a yellow colour, and seems to combine both with acids and bases.

XANTHOR'NUS, *n.* Cuvier's name for a genus of *Orioles*. [*See ORIOLE.*]

XANTHORRHE'A, *n.* A genus of plants, nat. order *Liliaceæ*. The species are called grass-trees and are found in Australia. They yield a resinous matter, and the bases of the leaves are used for food. They give a peculiar feature to the vegetation of the countries in which they grow.

XANTHORRHIZ'A, *n.* A genus of North American plants, nat. order *Ranunculaceæ*. [*See YELLOW-ROOT.*]

XANTHOXYLACE'Æ, *n.* A nat. order of polypetalous exogenous plants, found chiefly in America, especially in the tropical parts. The species are trees or shrubs, with extipulate, alternate or opposite leaves, furnished with pellucid dots. The flowers are either axillary or terminal, and of a gray green, or pink colour. All the plants of the order to a greater or less extent possess aromatic and pungent properties, especially the species belonging to the genera *Xanthoxylum*, *Brucea*, *Ptelea*, *Toddalia*, and *Ailanthus*.

**XANTHOXYLUM**, *n.* A genus of plants, the type of the nat. order Xanthoxyloaceæ. The species are trees or shrubs, with the petioles, leaves, and branches usually furnished with prickles. On account of their aromatic and pungent properties, they are known in the countries where they grow under the name of *peppers*. *X. fraxineum*



*Xanthoxylum fraxineum.*

is called toothache-tree, as its bark and capsular fruit are much used as a remedy for toothache. The same name is also given to all the other species of the genus.

**XEBEC**, *n.* A small, three masted

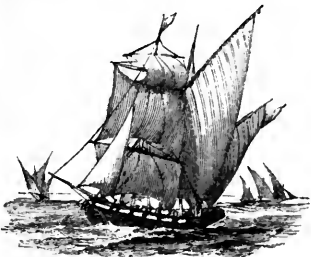

Xebec.

vessel, used in the Mediterranean sea. With a fair wind, in good weather, it

carries two large square sails; when close hauled, it carries large lateen sails.

**XENIUM**, *n.* [L.] A present given to a guest or stranger, or to a foreign ambassador.

**XENODOCHEUM**, *n.* [Gr. ξενδοχημιον.] A name given by the ancients to a building for the reception of strangers.

**XENODOCHY**, or **XENODOCHIA**, *n.* [Gr. ξενοδοχια.] Reception of strangers; hospitality.

**XENOTIME**, *n.* A native phosphate of yttria, having a yellowish brown colour.

**XERASIA**, *n.* In *med.*, a disease of the hair.

**XEROCOLLYRIUM**, *n.* [Gr. ξηρος, dry, and κολλυριον.] A dry collyrium or eye-salve.

**XERODES**, *n.* [Gr. ξηρος, dry.] Any tumour attended with dryness.

**XEROMYRUM**, *n.* [Gr. ξηρος, dry, and μυρον, ointment.] A dry ointment.

**XEROPHAGY**, *n.* [Gr. ξηρος, dry, and φαγω, to eat.] The eating of dry meats, a sort of fast among the primitive Christians.

**XEROPHTHALMY**, } *n.* [Gr. ξηρος, XEROPHTHALMIA, } dry, and οφθαλμια.] A dry, red soreness or itching of the eyes, without swelling or a discharge of humours.

**XEROTES**, *n.* [Gr. ξηροτης, dryness.] A dry habit or disposition of the body.

**XIPHIAS**, *n.* [Gr. from ξιφος, a sword.] 1. The sword-fish. In *nat. hist.*, the name of a genus of fishes, to which the *X. Gladius*, or common sword-fish belongs. [See **SWORD-FISH**.]— 2. A comet shaped like a sword.

**XIPHOID**, *a.* [Gr. ξιφος, a sword, and ωιδος, likeness, i. e. sword-like.] The *xiphoid* or *ensiform cartilage*, is a small cartilage placed at the bottom of the breast bone.

**XIPHOSURA**, *n.* [Gr. ξιφος, a sword, and ουρα, a tail.] A tribe of crustaceans, so called from the long sword-like appendage with which the body terminates.

**XYLANTHRAX**, *n.* [Gr. ξυλος, wood, and ανθραξ, coal.] Wood coal, bovey coal.

**XYLITE**, *n.* [Gr. ξυλος, wood.] A liquid obtained by distilling commercial

pyroxylic spirit from chloride of calcium. It strongly resembles alcohol, and when partially decomposed, gives rise to three products, viz. *xylic acid*, *xylic naphtha*, and *xylic oil*.

**XYLOBALSAMUM**, *n.* The wood of the balsam tree.

**XYLOGRAPHER**, *n.* One who engraves on wood.

**XYLOGRAPHIC**, } *a.* Relating to  
**XYLOGRAPHICAL**, } xylography.

**XYLOGRAPHY**, *n.* [Gr. ξυλος, wood, and γραφω, to engrave.] Wood-engraving; the act or art of cutting figures in wood, in representation of natural objects.

**XYLOPHAGA**, *n.* [See **XYLOPHAGOUS**.] A genus of small conchiferous molluscs, found in light wood, which they penetrate to the depth of about an inch.

**XYLOPHAGI**, *n.* A family of coleopterous insects, which live generally in wood, which is perforated and channelled in various directions by their larvæ. They are distinguished from the weevils by the absence of a proboscis.

**XYLOPHAGOUS**, *a.* [Gr. ξυλος, wood, and φαγω, to eat.] Eating or feeding on wood.

**XYLOPHILI**, *n.* [Gr. ξυλος, and φιλω, to love.] A tribe of gigantic coleopterous insects, which live on decayed wood. They chiefly inhabit tropical countries.

**XYLOPIA**, *n.* A genus of plants, nat. order Annonaceæ. The species are trees or shrubs, natives chiefly of South America. The wood of all is bitter; hence they are called *bitter-woods*.

**XYLOPYROGRAPHY**, *n.* [Gr. ξυλος, wood, πυρω, to burn, and γραφω, engraving.] The art or practice of engraving on charred wood.

**XYST**, } *n.* [Gr. ξυστας.] In ancient  
**XYSTOS**, } *arch.*, a sort of covered  
**XYSTUS**, } portico or open court, of great length in proportion to its width, in which the athletes performed their exercises.

**XYSTARCH**, *n.* An Athenian officer who presided over the gymnastic exercises of the xystos.

**XYSTER**, *n.* [Gr. ξυστηρας, from ξυς, to scrape.] A surgeon's instrument for scraping bones.

## Y.

**Y**, THE twenty-fifth letter of the English Alphabet, is taken from the Greek *ν*. At the beginning of words, it is called an articulation or consonant, and with some propriety perhaps, as it brings the root of the tongue in close contact with the lower part of the palate, and nearly in the position to which the close *g* brings it. Hence it has happened that in a great number of words, *g* has been changed into *y*, as the Sax. *gear*, into *year*; *geornian*, into *yearn*; *gyllan*, into *yell*; *gealew*, into *yellow*. In the middle and at the end of words, *y* is precisely the same as *i*. It is sounded as *i* long, when accented, as in *defy*, *rely*; and as *i* short, when unaccented, as in *vanity*, *glory*, *synonymous*. This latter sound is a vowel. At the beginning

of words, *y* answers to the German and Dutch *j*. *Y*, as a numeral, stands for 150, and with a dash over it, *Y*, for 150,000.

**YACHT**, *n.* (yot.) [D. *jagt*; G. *jacht*, from *jagen*.] It is properly a boat drawn by horses.] A light and elegantly fitted up vessel, used either for pleasure or passage, or as a vessel of state to convey kings, princes, &c., from one place to another by sea. It is either propelled by steam, or by wind acting on the sails, and may be rigged according to taste, as a cutter, schooner, brig, &c.

**YACHTER**, *n.* One who commands a yacht; one who sails in a yacht.

**YACHTING**, *n.* Sailing on pleasure excursions in a yacht.

**YACHT'ING**, *a.* Relating to a yacht or yachts; as, a *yachting* voyage.

**YAGERS**, *n.* [Ger. *Jäger*, a huntsman.] A title of honour given to certain regiments of light infantry, in the armies of various German states. Such regiments were originally composed of *Jäger* or huntsmen, whence the name. *Jäger* is also a name applied to a footman who stands behind a carriage, corresponding with the English *tiger*. It is likewise the general name for a huntsman; as, *Jäger chor*, the Huntsman's chorus.

**YAHOO**, *n.* A name given by Swift, in one of his imaginary voyages, to a race of brutes, having the form of man and all his degrading passions. They are placed in contrast with the *Houyhnhnms*, or horses endowed with reason, the whole being designed as a satire on the human race. Chesterfield uses

the term *yahoo* for a savage, or one resembling a savage.

**YAK**, *n.* A ruminant mammal of the bovine tribe, the *Bos poepagus*, or *Poepagus grunniens*, a small species of ox, with cylindrical horns curving outward, long pendent hair, and villous, horse-like tail; the grunting ox of Pennant. This animal is found in Thibet among the mountains; its bushy tail, when white, is much prized, and is used in India as an emblem of authority and greatness, and as a distinguishing mark of wealth.

**YAM**, *n.* A large esculent tuber or root produced by various plants of the genus *Dioscorea*, growing in tropical climates. The common West Indian yam is produced by *D. alata*; the East Indian yams are produced by *D. globosa*



Yam (*Dioscorea globosa*).

*rubella*, and *purpurea*. The *D. atropurpurea* grows in Malacca, and produces tubers which, like those of *D. purpurea*, are of a purple colour. Yams, when roasted or boiled, form a wholesome, palatable, and nutritious food. The yam sometimes grows to the length of three feet, and weighs thirty pounds. [See **DISCOREA**.]

**YAM'A**, or **DEHERMARA JAH**, *n.* The Hindoo Pluto, regent of the south or lower division of the world, mythologically called *Patala*, or the infernal



Yama.

regions. He is described as being of a green colour, with red garments, having

a crown on his head, his eyes inflamed, and sitting on a buffalo with a club in his hand.

**YAM'ER**, } *v. i.* [G. *jammeren*.] To  
YAM'ER, } shriek; to yell; to cry  
YAM'OUR, } aloud. [Scotch.]

**YAN'KEE**, *n.* [Supposed to be a corrupt pronunciation of the word *English*, by the native Indians of America, or more probably of the French word *Anglais*.] A cant name for the citizens of New England, but sometimes applied by foreigners to all the inhabitants of the United States, indiscriminately.

**YAN'KEE DOODLE**, *n.* The name of a tune, adopted as the national air of the United States.

**YAN'OLITE**, *n.* A mineral, called also axinite or thumerstone, whose crystals resemble an axe.

**YAP**, to bark, is not a legitimate word.  
**YAP'ON**, *n.* The cassine or South Sea tea. The *Ilex cassine*, or youpon, is a shrub growing in the southern states of America, used as tea and as medicine.

**YAR'AGE**, † *n.* Furniture; equipage; tackling.

**YARD**, *n.* [Sax. *geard*, *gerd*, *gyrd*, a rod, that is, a shoot.] 1. A measure of three feet or 36 inches.—2. [Sax. *gyrdan*, to inclose; Dan. *gierde*, a hedge, an inclosure; *gierder*, to hedge in, Sw. *gård*.] The British standard measure of length, equal to three feet or 36 inches. A square yard contains nine square feet, and a cubic yard 27 cubic feet.—2. A pole or rod three feet long for measuring a yard. The yard in front of a house is called a *court*, and sometimes a *court-yard*. A small piece of inclosed ground, particularly adjoining a house.—3. An enclosure within which any work or business is carried on; as a *brick-yard*, a *wood-yard*, a *tanning-yard*, &c.—4. In *ships*, a long cylindrical piece of timber, having a rounded taper toward each end, and slung by its centre to a mast. The use of the yards is for spreading square sails upon. All yards are either *square* or *lateen*, the former being suspended across the masts at right angles, the latter obliquely.—**Yard of land**. [See **YARD-LAND**.]

**YARD-ARM**, *n.* [*yard* and *arm*.] Either half of a ship's yard, from the centre or mast to the end.—*Yard-arm* and *yard-arm*, the situation of two ships lying along side of each other, so near that their yard-arms cross or touch.

**YARD-LAND**, *n.* A quantity of land, in England, different in different counties. In some counties it was 15 acres; in others 20, or 24, and even 40 acres.

**YARD-STICK**, or **YARD-MEASURE**, *n.* [*yard* and *stick*.] A stick or rod three feet in length, used as a measure of cloth, &c.

**YARD-WAND**, *n.* [*yard* and *wand*.] A measure of a yard; now *yard-stick*.

**YARE**, † *a.* [Sax. *gearu*, prepared; from the root of *gear*. See **EAGER**.] Ready; quick; dextrous; eager. A term used by sailors; as, be *yare* at the helm.

**YARELY**, † *adv.* Readily; dextrously; skillfully.

**YARN**, *n.* [Sax. *gearn*; G. Ice. and Sw. *garn*; D. *garen*.] 1. Spun wool; woollen thread; but it is applied also to other species of thread, as to cotton and linen.—2. In *rope-making*, one of the threads of which a rope is composed. It is spun from hemp.—3. Among *seamen*, a story spun out by a sailor for the amusement of his com-

panions; thus, to spin a long *yarn*, is to tell a long story.

**YARR**, † *v. i.* [Low L. *hirrio*; Celtic, *gar*, W. *garu*, rough.] To growl or snarl, as a dog.

**YARRISH**, *a.* Having a rough dry taste. [Local.]

**YAR'ROW**, *n.* [Sax. *gearwe*; Sp. *yaro*.] A name given to several British plants of the genus *Achillaea*. They are also known by the name of *Mitfoil*,—*which see*.

**YAT'AGHAN**, *n.* A sort of curved knife or short scimitar, much worn in Turkey. It is also written *Ataghan*.

**YATE**, in the north of England, is used for *gate*. [Scotch *yett*.]

**YAUP**, *v. i.* [Old Eng. *yawlp*.] To yelp; to cry out like a child or a bird. [Scotch.]

**YAUP**, *a.* Hungry. [Scotch.]

**YAW**, *n.* The African name of a raspberry.

**YAW**, *v. i.* To rise in blisters, breaking in white froth, as cane juice in the sugar works. [Qu. *yew*. See **YEW**.]—2. In *navigation*, to deviate from the line of her course in steering, as a ship.

**YAW**, *n.* A temporary deviation of a ship or vessel from the direct line of her course.

**YAWL**, *n.* A small ship's boat, usually rowed by four or six oars.—2. The smallest boat used by fishermen.

**YAWL**, *v. i.* To cry out. [See **YELL**.]

**YAWN**, *v. i.* [Sax. *geonan*, *gymian*; G. *gähnen*; W. *agenu*; Gr. *χαίνω*.] 1. To gape; to oscitate; to have the mouth open involuntarily through drowsiness or dulness.

The lazy, yawning drone. *Shak.*  
And while above he spends his breath,  
The yawning audience nod b-neath.

*Trumbull.*

2. To open wide; as, wide *yawns* the gulf below.—3. To express desire by yawning; as, to *yawn* for fat livings.

**YAWN**, *n.* A gaping; an involuntary opening of the mouth from drowsiness; oscitation.

One person yawning in company will produce a spontaneous *yawn* in all present.

*N. Chipman.*

2. An opening wide.

**YAWN'ED**, *pp.* Gaped; opened wide.

**YAWN'ING**, *pp.* Gaping; opening wide.—2. *a.* Sleepy; drowsy; dull.

**YAWN'ING**, † *a.* Sleepy; slumbering.—2. Opening widely; as, a *yawning* gulf or abyss.

**YAWNING**, *n.* The act of gaping or opening wide.

**YAWN'INGLY**, *adv.* In a yawning manner.

**YAWS**, *n.* [African *yaw*, a raspberry.] A disease called, by Good, *Rubula*, from *rubus*, a raspberry. It is characterized by cutaneous tumours, numerous and successive; gradually increasing from specks to the size of a raspberry; one, at length, growing larger than the rest; core, a fungous excrescence; fever slight, and probably irritative merely. It is commonly supposed to be contagious, and to occur but once during life; but both of these points are doubtful. It is sometimes called *frambesia*, a barbarous name, derived from the French *framboise*, a raspberry. There are two varieties of this disease, which differ considerably; the one occurring in Africa, the other in America. It is scarcely known in Europe.

**YCLAD**, *pp.* Clad. [This word and the following retain the *y*, which is the



remains of the Saxon *ge* prefixed to verbs. But it is obsolete, except in poetry, and perhaps in burlesque only.] **YCLEP'ED**, *pp.* of Sax. *ge-clypian*, *clepan*, to call. [*See YCLAD.*] Called; named. It is obsolete, except in burlesque.

**YDRAD**, † *pp.* Dreaded.

**YE**, *pron.* [Sax. *ge.*] The nominative plural of the second person, of which *thou* is the singular. But the two words have no radical connection. *Ye* is now used only in the sacred and solemn style. In common discourse and writing, *you* is exclusively used.

But *ye* are washed, but *ye* are sanctified; 1 Cor. vi.

**YEA**, *adv.* (*yē* or *yā.*) [Sax. *gea*, *geac*; G. D. and Dan. *ja*; Sw. *jaka*, to consent. Qu. G. *bejaken*, to affirm.] 1. Yes; a word that expresses affirmation or assent. Will you go? *yea*. It sometimes introduces a subject, with the sense of indeed, verily, truly, it is so.

*Yea*, bath God said, Ye shall not eat of every tree in the garden? Gen. iii.

Let your communication be *yea*, *yea*; nay, nay; Matth. v.

2. It sometimes enforces the sense of something preceding; not only so, but more.

Therein I do rejoice; *yea*, and will rejoice; Phil. i.

3. In Scripture, it is used to denote certainty, consistency, harmony, and stability.

All the promises of God in him are *yea*, and in him are amen; 2 Cor. i.

[In this use, the word may be considered a noun.] *Yea* is used only in the sacred and solemn style. [*See YES.*]

**YEA**, *n.* (*yē* or *yā.*) An affirmative vote; one who votes in the affirmative. It is equivalent to *Ay* or *Aye*. The *yeas* and *nays* are those members of a legislative body, who vote in the affirmative and in the negative of a proposition.

**YEAD**, } † *v. i.* To go.

**YEDE**, }

**YEAN**, *v. i.* [Sax. *eanian*.] To bring forth young, as a goat or sheep; to lamb. [*Obsolete or local.*]

**YRANED**, *pp.* Brought forth.

**YEANLING**, *n.* The young of sheep; a lamb. [*Obsolete or local.*]

**YEAR**, *n.* [Sax. *gear*; G. *jahr*; Sans. *jairan*; probably a course or circle; the root *gar*, *ger*, signifying to run.]

1. The period of time during which the earth makes one complete revolution in its orbit, or it is the space or period of time which elapses between the sun's leaving either equinoctial point, or either tropic, and his return to the same. This is the solar year, and the year, in the strict and proper sense of the word. It is called also the tropical year. This period comprehends what are called the twelve calendar months. It is not quite uniform, but its mean length is about 365 days, 5 hours, 48 minutes, and 48 seconds. The return of the seasons depends upon it. In popular usage, however, the year consists of 365 days, and every fourth year of 366; a day being added to February, on account of the excess of the solar year above it.—2. The time in which any planet completes a revolution; as, the year of Jupiter or of Saturn.—3. The time in which the fixed stars make a revolution, is called the great year.—4. Years, in the plural, is sometimes equivalent to age or old age; as, a man in years. In popular language, year is

often used for years. The horse is ten year old.—*Sideral year*, the time between the sun's leaving any point among the fixed stars and his return to the same; that is, the time of the sun's apparent revolution in the ecliptic. This is 365 days, 6 hours, 9 minutes, and 11.5 seconds. The excess of the sidereal above the solar year, arises from the retrograde motion of the equinoctial points, owing to which the sun returns to either equinoctial point or either tropic, before returning to the same fixed star.—*Anomalous year*, the time that elapses from the sun's leaving its apogee, till it returns to it; which is 365 days, 6 hours, 14 minutes nearly.—*Civil year*, the year of the calendar, consisting of 365 days, and every fourth year of 366 days.—*Bis-sextile or leap year*, the year consisting of 366 days.—*Lunar year*, consists of 12 lunar months.—*Lunar astronomical year*, consists of 12 lunar synodical months, or 354 days, 8 hours, 48 minutes, 36 seconds.—*Common lunar year*, consists of 12 lunar civil months, or 354 days.—*Embolismic or intercalary year*, consists of 13 lunar civil months, and contains 384 days.—*Julian year*, established by Julius Cesar, consists of 365 days, 6 hours.—*Gregorian year*, is the Julian year corrected, and is the year now generally used in Europe. From the difference between this and the Julian year, arises the distinction of Old and New Style. [*See STYLE.*]

—*Sabbatic year*, among the Israelites, was every seventh year, when their land was suffered to lie untilled. The civil or legal year, in England, formerly commenced on the 25th day of March. This practice continued throughout the British dominions till the year 1752. [*See TIME.*]—*A year and day*, in law, the lapse of a year with a day added to it, a period which determines a right, or works prescription; as in the case of an estray, if the owner does not claim it within that time, it becomes forfeited to the lord; so of a wreck, &c. In Scots law, the lapse of a year and day, has several important effects, as in the case of marriage, adjudications, *annus deliberandi*, &c. &c.

**YEAR-BOOK**, *n.* [*year* and *book*.] A book containing annual reports of cases adjudged in the courts of England, from the time of Edward II. to that of Henry VII., published annually. [This name has since been applied to various periodical publications, calendars, &c.; as, the Year-book of facts, &c.]

**YEARED**, † *a.* Containing years.

**YEARLING**, *n.* A young beast one year old, or in the second year of his age.

**YEARLING**, *a.* Being a year old; as, a yearling heifer.

**YEARLY**, *a.* Annual; happening, accruing, or coming every year; as, a yearly rent or income.—2. Lasting a year; as, a yearly plant.—3. Comprehending a year; as, the yearly circuit or revolution of the earth.

**YEARLY**, *adv.* Annually; once a year; as, blessings yearly bestowed.

**YEARN**, *v. i.* [Sax. *geornian*, *giernan*, *gyrnan*, *earnian*, to desire; to yearn; Sw. *gerna*, willingly; Dan. *gierne*, G. *gern*, D. *gaerne*. The sense is to strain, or stretch forward. We have earnest from the same root.] 1. To be strained; to be pained or distressed; to suffer.

Falstaff, he is dead, And we must yearn therefore. Shak.

**YEARNING**, *a.* Being a year old; as, a yearling heifer.

**YEARNING**, *a.* Annual; happening, accruing, or coming every year; as, a yearly rent or income.—2. Lasting a year; as, a yearly plant.—3. Comprehending a year; as, the yearly circuit or revolution of the earth.

**YEARNING**, *adv.* Annually; once a year; as, blessings yearly bestowed.

**YEARN**, *v. i.* [Sax. *geornian*, *giernan*, *gyrnan*, *earnian*, to desire; to yearn; Sw. *gerna*, willingly; Dan. *gierne*, G. *gern*, D. *gaerne*. The sense is to strain, or stretch forward. We have earnest from the same root.] 1. To be strained; to be pained or distressed; to suffer.

Falstaff, he is dead, And we must yearn therefore. Shak.

**YEARNING**, *a.* Being a year old; as, a yearling heifer.

2. Usually, to long; to feel an earnest desire; that is, literally, to have a desire or inclination stretching toward the object or end; to feel great internal uneasiness from longing desire, from tenderness or pity; 1 Kings iii.

Joseph made haste, for his bowels did yearn upon his brother; Gen. xlii.

Your mother's heart yearns toward you  
Addison.

Anticlus, unable to control,  
Spoke loud the language of his yearning  
soul. Pope.

**YEARN**, *v. t.* To pain; to grieve; to vex.

She laments for it, that it would  
Yearn your heart to see it. Shak.

It yearns me not if men my garments wear.†  
Shak.

**YEARN'FUL**, † *a.* Mourning; distressing.

**YEARN'ING**, *ppr.* or *a.* Longing; having longing desire.

**YEARNING**, *n.* Strong emotions of desire, tenderness, or pity; state of being moved with tenderness, pity, or longing desire.

**YEARNINGLY**, *adv.* With yearning.

**YEAST**, *n.* [Sax. *gist*, yeast, a guest, also a storm; *yst*, a storm; G. *güsch*, yeast, and *gast*, a guest, *güsch*, to foam or froth; D. *gist*, yeast; *gisten*, to ferment. This coincides with *gas* and *ghost*. The primary sense of the noun is wind, spirit, flatulence, or froth, from rushing; Ch. גָּזָז, *gasas*, to inflate.] 1. Barm; ferment; the substance produced during the fermentation of wine, beer, and vegetable juices. It rises partly to the surface in the form of a frothy flocculent, and somewhat viscid matter, insoluble in water and alcohol, and gradually putrifying in a warm atmosphere. It is employed to produce fermentation in saccharine and mucilaginous solutions. It is also used for raising dough for bread or cakes, and making it light and puff. [*See FERMEN, FERMENTATION.*]—2.† Spume or foam of water.

**YEASTY**, *a.* Frothy; foamy; spumy; like yeast; containing yeast.

**YEDE**, † *v. i.* To go; to march.

**YELDE**, } *a.* Barren; as, a yeld heifer;

**YELL**, } not giving milk; as, a yell cow. [*Scotch*]

**YELK**, † *n.* [Sax. *gealew*, yellow; G. *gelb*, yellow. *See GOLD* and *YELLOW.*] The yellow part of an egg; the vitellus. [*See YOLK.*]

**YELL**, *v. i.* [Sax. *giellan*, *gyllan*; D. *gillen*; Sw. *gälla*, to ring. It agrees in elements with *call*.] To cry out with a hideous noise; to cry or scream as with agony or horror. Savages yell most frightfully when they are rushing to the first onset of battle.

Nor the night raven, that still deadly yells.  
Spenser.

**YELL**, † *v. t.* To utter with a yell.

**YELL**, *n.* A sharp, loud, hideous outcry; a scream or cry of horror.

Their hideous yells  
Rend the dark welkin. Philips.

**YELL'ED**, *pp.* Uttered hideous cries; shrieked.

**YELL'ING**, *ppr.* or *a.* Uttering hideous outcries; shrieking; as, yelling monsters.

**YELL'ING**, *n.* The act of screaming hideously.

**YELL'OW**, *a.* [Sax. *gealew*, yellow; *gealla*, gall; G. *gelb*; D. *geel*; Dan. *gul*; Sw. *gul*, *gul*. Hence gold, Dan. *guld*. The Fr. *jaune* is the same word,

contracted from *jaulne*, as it is written in the Norman; It, *giallo*; Russ. *jeltnu*, to become yellow; *jeltmie*, yellow; *L. galbanus*. Qu. *gilvus*. The root is the Celtic *gal*, great, bright. See G.O.R.D.] Being of a great colour; of the colour of gold.

**YEL'LOW**, *n.* A bright colour; the colour of gold; a golden hue. Yellow reflects the most light of any colour after white. It is one of the simple or primitive colours. In *painting*, yellow is of a great many varieties, as, *Naples yellow*, *king's yellow*, *patent yellow*, &c. [See these terms in their proper places.]

**YEL'LOW**, *v. t.* To render yellow.

**YEL'LOW**, *n. i.* To grow yellow.

**YEL'LOW-BIRD**, *n.* A small singing bird common in the United States, the *Fringilla tristis*, Linn. The summer dress of the male is of a lemon yellow, with the wings, tail, and fore part of the head black. The female and male, during winter, are of a brown olive colour. When caged, the song of this bird greatly resembles that of the canary.

**YEL'LOW-BLOSSOMED**, *a.* Furnished or adorned with yellow flowers.

**YEL'LOW-BOY**, *n.* A cant name for a guinea or other gold coin.

**YEL'LOW-BUNTING**, *n.* The yellow-hammer,—which see.

**YEL'LOW-DYE**, *n.* A yellow colouring matter, obtained from vegetables and minerals. The principal vegetable yellow dyes are *annotto*, *dyer's broom*, *fustic*, *French berries*, *fustet*, *quercitron bark*, *turmeric*, *saw-wort*, *weld*, and *willow leaves*. Those of the mineral kingdom, are *chromate of lead*, *iron-oxide*, *nitric acid*, *sulphuret of antimony*, and *sulphuret of arsenic*.

**YEL'LOW-EARTH**, *n.* A soft yellow mineral found at Wehrav, in Upper Lusatia, united with clay and argillaceous iron-stone.

**YEL'LOW-FEVER**, *n.* A malignant febrile disease of warm climates, which is often attended with yellowness of the skin, of some shade between lemon-yellow and the deepest orange-yellow, and often also with what is called black-vomit.

**YEL'LOW-GOLDS**, *n.* A flower.

**YEL'LOW-HAIRED**, *a.* Having yellow hair.

**YEL'LOW-HAMMER**, *n.* A passerine bird of the genus *Emberiza*, the *E. citrinella*, Linn.; called also yellow bunting and yellow teedring. The head, cheeks, front of the neck, belly, and lower tail coverts are of a bright yellow. On the breast and sides there are reddish spots; the feathers on the top of the back are blackish in the middle, and the tail feathers are also blackish. The yellow-hammer is a resident in this country, and generally throughout Europe. In summer the well known notes of the male are almost incessantly heard from the roadside hedge.

**YEL'LOWISH**, *a.* Somewhat yellow; as, amber is of a *yellowish* colour.

**YEL'LOWISHNESS**, *n.* The quality of being somewhat yellow.

**YEL'LOW-LEAVED**, *a.* Having yellow leaves.

**YEL'LOWNESS**, *n.* The quality of being yellow; as, the *yellowness* of an orange.—2† Jealousy.

**YEL'LOW-NUPHAR**, *n.* The yellow-water-lily, *Nuphar lutea*. [See NUPHAR]

**YEL'LOW-PINE**, *n.* A North Ameri-

can tree of the genus *Pinus*, *P. mitis*. The wood is compact and durable, and is universally employed in the countries where it grows for domestic purposes. It is also extensively imported to Britain and the West Indies. [See PINE.]

**YEL'LOW-RATTLE**, *n.* A British plant of the genus *Rhinanthus*, the *R. crista-gall.* [See RHINANTHUS.]

**YEL'LOW-ROCKET**, *n.* A British plant of the genus *Barbarea*, the *B. vulgaris*, called also bitter winter-cress. [See WINTER-CRESS.]

**YEL'LOW-ROOT**, *n.* A plant of the genus *Xanthorrhiza*, the *X. apifolia*. It is a small North American shrub, having creeping roots of a yellow colour. The bark of the root is intensely bitter, and is used in America as a tonic.

**YEL'LOWS**, *n.* A disease of horses, in which the skin becomes yellow. It is a chronic inflammation of the liver, or a kind of jaundice.

**YEL'LOW-THROAT**, *n.* A small North American singing bird of the genus *Sylvia*, a species of warbler.

**YEL'LOW-TOP**, *n.* A species of grass, called also white-top.

**YEL'LOW-WATER-LILY**, *n.* See NUPHAR.

**YEL'LOW-WEED**, *n.* The common name of British plants of the genus *Reseda*. [See RESEDA.]

**YEL'LOW-WILLOW**, *n.* A plant of the genus *Salix*, the *S. vitellina*; called also golden osier. It is a tree of moderate height, with smooth, shining, yellow branches, and is used for making baskets.

**YEL'LOW-WOOD**, *n.* A plant of the genus *Xanthoxylum*.

**YEL'LOW-WORT**, *n.* A British plant of the genus *Chlora*, the *C. perfoliata*, nat. order Gentianaceæ. It is an annual plant, with a stem about a foot high. It is very glaucous, with remote leaves, panicled above, and bearing many bright yellow flowers. It grows on chalky or hilly pastures.

**YELP**, *v. i.* [Sax. *gealpan*, to bray; Dan. *gyper*, to croak.] To bark, as a beagle-hound after his prey, or as other dog.

**YELP'ING**, *ppr.* Barking in a particular manner.

**YELP'ING**, *n.* The repeated bark of a young dog.—2. Repetitory cries or reproaches of a young person. [Vulgar.]

**YENITE**, *n.* A mineral found in the isle of Elba, and in other places, of a brown or brownish black colour. It is arranged with the chrysolite family, but differs much from other species of it. It resembles hornblend, or rather black epidote. It occurs both crystallized and massive; the form of the crystals being that of a rhomboidal prism. It consists chiefly of silic, lime, and oxide of manganese. This mineral is called yenite or jenite, in commemoration of the battle of Jena, and lievrite, from its discoverer.

**YEOMAN**, *n.* [Sax. *gemane*, common, Sw. *gemen*, Dan. *gemeen*. See COMMON.]

1. A man of small estate in land; a farmer; a gentleman farmer. According to Camden, a yeoman is at the head of the classes beneath gentlemen, and in legal understanding he is one who is possessed of a forty shilling freehold.—2. An upper servant in a nobleman's family.—3. An officer in the king's household, of a middle rank between the sergeant and the groom.—4. In *ships of war*, an inferior officer under

the boatswain, appointed to assist in attending to the boatswain's stores.—5. *Yeomen of the guard*, a body guard of the sovereign, consisting of 100 men habited in the costume of Henry VIII's time, and commanded by a captain and other officers. They are known by the vulgar name of *beef-eaters*. [See BEEF-EATER.]

**YEOMAN-LIKE**, *a.* Like yeoman.

**YEOMANLY**, *a.* Pertaining to a yeoman.

**YEOMANRY**, *n.* The collective body of yeomen; the collective body of farmers.—*Yeomanry cavalry*, a name given to certain troops of horse that were embodied in almost every county as volunteers, during the French war, whilst this country was threatened with invasion. A large portion of this force consisted of gentlemen or wealthy farmers (yeomen). It was subject to the same regulations, when on service, as the militia. The men were mounted, and in most respects equipped at their own expense, but they received pay when in actual service. They were commanded by the lord-lieutenant of the county, who granted commissions to the subaltern officers. Many of these yeomanry regiments still exist, although they are rather maintained for the purpose of amusement and good fellowship, than for any practical service.

**YER'BA**, *n.* A name given to YER'BA-MA'TE, } Paraguay tea, the produce of *Ilex Paraguensis*. It yields theine.

**YERK**, *v. t.* [This seems to be the Heb. and Ch.  $\text{פָּרַח}$ , *yarach*, Eth. *waraha*, to spit, that is, to thrust out. It is the same as *jerk*.] To throw or thrust with a sudden smart spring; as, horses *yerk* their heels; to jerk.—2.† To lash; to strike; to beat. [In this latter sense, the word is used in the Scottish dialect.]

**YERK**, *v. i.* To jerk; to move as with jerks.

**YERK**, *n.* A sudden or quick thrust or motion.

**YERK'ING**, *ppr.* Thrusting with a quick spring.

**YERN**. See YEARN.

**YER-NUT**, *n.* A kind of nut; earth-YER-NUT, } nut; pig-nut.

**YES**, *adv.* [Sax. *yise*.] A word which expresses affirmation or consent; opposed to *no*; as, are you married, madam? *yes*. It is used like *yea*, to enforce by repetition or addition, something which precedes. You have done all this; *yes*, you have done more.

*Yes*, you despise the man to books confin'd. Pope.

[Walker's pronunciation of this word as *yis*, is now considered vulgar. It is now pronounced, by polite speakers, *yès*, the *e* having the short sound, as in *met*.]

**YES'AWAL**, *n.* In *India*, a state messenger.

**YEST**. See YEAST.

**YESTER**, *a.* [G. *gestern*; D. *gisteren*; Sax. *gystern*; L. *hesternus*.] Last; last past; next before the present; as, *yester sun*.

*Note*.—This is seldom used except in the compounds which follow.

**YESTERDAY**, *n.* [Sax. *gyrstan-dæg*, *gyrsterlic dæg*. See YESTER.] 1. The day last past; the day next before the present.

All our *yesterdays* have lighted fools  
The way to dusty death. Shaks.  
We are but of *yesterday*, and know nothing; Job viii.

**2.** *Yesterday* is used generally without a preposition; as, I went to town *yesterday*. *Yesterday* we received letters from our friends. In this case, a preposition is understood; as, *on yesterday*, or *during yesterday*. The word may be considered as adverbially used.

**YES'TEREVE,** } *n.* The even-  
**YES'TEREVENING,** } ing last past.  
**YES'TERN,** *a.* Relating to the day last past.

**YES'TERNIGHT,** *n.* [*yester and night.*] The night last past.—**2.** It is used without a preposition. My brother arrived *yesternight*; where on or *during* is understood, but it may be considered as adverbially used.

**YEST'Y.** See **YEASTY.**

**YET,** *conj.* [*Sax. yet, gut; Gr. ετι; W. etto.* It seems to be from the root of the verb *yet.*] Nevertheless; notwithstanding; however. I come to you in the spirit of peace; *yet* you will not receive me.

*Yet, I say to you, that Solomon in all his glory, was not arrayed like one of these; Matth. vi.*

**YET,** *adv.* Beside; over and above. There is one reason *yet* further to be alleged.—**2.** Still; the state remaining the same.

They attest facts they had heard while they were *yet* heathens. *Addison.*  
**3.** At this time; so soon. Is it time to go? Not *yet*.—**4.** At least; at all.

A man that would form a comparison between Quintillian's declamations, if *yet* they are Quintillian's. *Baker.*

**5.** It is prefixed to words denoting extension of time or continuance. A little longer; *yet* a little longer. *Dryden.*

**6.** Still; in a new degree. The crime becomes *yet* blacker by the pretence of piety.—**7.** Even; after all; a kind of emphatical addition to a negative.

Men may not too rashly believe the confessions of witches, nor *yet* the evidence against them. *Bacon.*

**8.** Hitherto. You have *yet* done nothing. In this sense it sometimes takes *as* before it; as, you have *as yet* done less than was expected.

**YETT,** *n.* A gate. [*Scotch.*]

**YEVEN,** for *Given*, is not in use.

**YEW,** *n.* [*Sax. iwo; W. yw or ywen; G. eibe or eibenbaum; D. iebenboom; Fr. if.*] An evergreen tree of the genus *Taxus*, nat. order *Taxaceæ*. The common yew is *T. baccata*, indigenous on



Yew (*Taxus baccata*.)

most parts of Europe, and found in most parts of Great Britain and Ireland. It is a low tree, usually rising three or four feet from the ground, and then sending out numerous spreading branches, forming a dense head of

foliage, often 30 to 40 feet high. It is frequently planted in church-yards; its wood was extensively used in the manufacture of bows previous to the discovery of gunpowder, and now, on account of its hard, compact, close grain, it is much employed by cabinet-makers and turners.

**YEW,** *v. i.* To rise, as *scnm* on the brine in boiling at the salt works. [*See YAW.*]

**YEW,** *a.* Relating to yew-trees; made of the wood of the yew-tree.

**YEW'EN,** *† a.* Made of yew.

**YEX,** *n.* [*Sax. geocsa. See Hiccough.*] A hiccough. [*Little used.*]

**YEX,** *v. i.* To hiccough.

**YEZDEGER'DIAN,** *a.* Noting an era, dated from the overthrow of the Persian empire, when Yezdegerd was defeated by the Arabians, in the eleventh year of the Hegira, A. D. 636.

**YEZ'DEES,** *n. plur.* A small tribe bordering on the Euphrates, whose religion is said to be a mixture of the worship of the devil, with some of the doctrines of the Magi, Mohammedans, and Christians.

**YFERE,** *† adv.* Together.

**YIELD,** *v. t.* [*Sax. giellan, gildan, gyl-dan,* to render, to pay. But the word seems to be directly from the *W. gildiau,* to produce, to yield, to concede, to contribute. The sense is obvious.]

**1.** To produce, as land, stock, or funds; to give in return for labour, or as profit. Lands *yield* not more than three per cent. annually; houses *yield* four or five per cent. Maize on good land, *yields* two or three hundred fold—**2.** To produce, in general. Most vegetable juices *yield* a salt.—**3.** To afford; to exhibit. The flowers in spring *yield* a beautiful sight.—**4.** To allow; to concede; to admit to be true; as, to *yield* the point in debate. We *yield* that there is a God.—**5.** To give, as claimed of right; as, to *yield* due honours; to *yield* due praise.—**6.** To permit; to grant.

Life is but air,

That *yields* a passage to the whistling sword. *Dryden.*

**7.** To emit; to give up. To *yield* the breath, is to expire.—**8.** To resign; to give up; sometimes with *up* or *over*; as, to *yield up* their own opinions. We *yield* the place to our superiors.—**9.** To surrender; sometimes with *up*; as, to *yield* a fortress to the enemy; or to *yield up* a fortress.

**YIELD,** *v. i.* To give up the contest; to submit.

He saw the fainting Grecians *yield*.

*Dryden.*

**2.** To comply with; as, I *yielded* to his request.—**3.** To give way; not to oppose. We readily *yield* to the current of opinion; we *yield* to the customs and fashions.—**4.** To give place, as inferior in rank or excellence. They will *yield* to us in nothing.

Tell me in what more happy fields  
The thistle springs, to which the lily *yields*?  
*Pope.*

**YIELD,** *n.* Amount yielded; product; return; applied particularly to products resulting from growth or cultivation.

**YIELDABLENESS,** *n.* Disposition to comply. [*A bad word and not used.*]

**YIELDANCE,** *† n.* Act of producing; concession.

**YIELDED,** *pp.* Produced; afforded; conceded; allowed; resigned; surrendered.

**YIELDER,** *n.* One who yields.

**YIELDING,** *ppr.* Producing; affording; conceding; resigning; surrendering; allowing.—**2.** *a.* Inclined to give way or comply; flexible; accommodating; as, a *yielding* temper.

**YIELDING,** *n.* Act of producing; act of surrendering; submission.

**YIELDINGLY,** *adv.* With compliance.

**YIELDINGNESS,** *n.* Disposition to comply; quality of yielding.

**YIELDLESS,** *† a.* Unyielding.

**YIRD,** *n.* Earth. [*Scotch.*]

**YIRK,** *v. i.* To snarl; to growl; as, a dog. [*Scotch.*]

**YO'GA,** *n.* Among the *Hindoos*, a species of asceticism, which consists in a complete abstraction from all worldly objects, by which the *Hindoo* ascetic expects to obtain final emancipation from further migrations, and union with the universal spirit. Those who practise the *Yoga* are called *Yogis*, and the horrible tortures which they commit on themselves have been often described.

**YO'JAN,** *n.* In the *East Indies*, a measure or distance of five miles.

**YOKE,** *n.* [*Sax. geoc or ioc; D. juh; G. joeh; Sans. yuga or yuy; Pers. yugh, yoo; W. jau; Fr. joug; L. jugum; Gr. ζυγος; Slav. Russ. ygo; Ch. Syr. and Ar. ܙܘܓ, zug, to join, L. jungo, Gr. ζυγω.*]

**1.** A piece of timber, hallowed or made curving near each end, and fitted with bows for receiving the necks of oxen; by which means two are connected for drawing. From a ring or hook in the bow, a chain extends to the thing to be drawn, or to the yoke of another pair of oxen behind.—**2.** A mark of servitude; slavery; bondage.

Our country sinks beneath the *yoke*.

*Shak.*

**3.** A frame of wood fitted to a person's shoulders for carrying a pail, &c. suspended on each side.—**4.** A chain; a link; a bond of connection; as, the *yoke* of marriage.—**5.** A couple; a pair; as, a *yoke* of oxen.—**6.** Service.

My *yoke* is easy; Matth. xi.

**7.** A frame of wood or metal with two arms, made to slip on the head of a boat's rudder, and having a line, called the *yoke-rope*, attached to each end, by pulling on which the boat is steered.

**YOKE,** *v. t.* To put a yoke on; to join in a yoke; as, to *yoke* oxen, or a pair of oxen.—**2.** To couple; to join with another.

Cassius, you are *yoked* with a lamb.

*Shak.*

**3.** To enslave; to bring into bondage. **4.** To restrain; to confine. Libertines like not to be *yoked* in marriage.

The words and promises that *yoke*

The conqueror, are quickly broke.

*Hudibras.*

**YOKE,** *† v. i.* To be joined together.

**YOKED,** *pp.* Confined in a yoke; joined; coupled.

**YOKE-ELM,** *n.* A tree.

**YOKE-FELLOW,** } *n.* [*yoke and fel-*  
**YOKE-MATE,** } *low or mate.*] An associate or companion.—**2.** A mate; a fellow.

**YOKE'LET,** *n.* A small farm. [*Local.*]

**YOKING,** *ppr.* Putting a yoke on; joining; coupling.

**YOKING,** *n.* The act of putting a yoke on; the act of joining or coupling.—**2.** In *agriculture*, the harnessing of draught animals, as horses and oxen, to carts, ploughs, &c.—**3.** In *Scotland*, as much work as is done by draught

animals at one time, whether it be by cart or plough.

**YOLD**, † for *Yielded*.

**YOLK**, *n.* 1. The yellow part of an egg; the vitellus. [See *YELK*.]—2. The unctuous secretion from the skin of sheep, which renders the pile soft and pliable.—3. The *vitellus*, a part of the seed of plants, so named by Gærtner, from its supposed analogy with the yolk of an egg. It is characterized as very firmly and inseparably connected with the embryo, yet never rising out of the integuments of the seed in germination, but absorbed, like the *albumen*, [see *WHITE* and *PERISPERM*.] for the nourishment of the embryo. When the albumen is present, it is always situated between it and the embryo. In the grasses it forms a scale between the embryo and albumen. It is considered by Smith as a subterraneous cotyledon.

**YON**, } *a.* [Sax. *geond*. This seems to be formed from *gan*, **YONDER**, † } to go, or its root, and signifies properly *gone*; or it is from *geonan*, to open; whence distant. The *G. jener*, and *D. gins*, *ginder*, may be the same word or from the same root.] Being at a distance within view.

*Yonder* men are too many for an embassy. *Bacon*.  
Read thy lot in *yon* celestial sign. *Milton*.  
*Yon* flowery arbors, *yonder* alleys green. *Milton*.

*Note.*—*Yon* is obsolete, except in poetry.

**YON**, † } *adv.* At a distance within **YONDER**, † } view. When we use this word, we often point the hand or direct the eye to the place or object.

First and chiefest, with thee bring Him that *yon* soars on golden wing. *Milton*.

*Yonder* are two apple-women scolding. *Arbutnot.*

**YOND**, † *a.* Mad; furious, or alienated in mind; that is, *gone*, wandering, and allied to the preceding.

**YONKER**, *n.* A youngster; a younker.  
**YOKE**, † *adv.* [Sax. *geara*. It probably signifies past, gone, from the root of *year*.] Long.—Of *yore*, of old time; long ago; as, in times or days of *yore*. But Satan now is wiser than of *yore*. *Pope*.  
**YOTE**, † *v. t.* To fasten; to rivet.—**YOAT**, † } 2. To water; to pour water on. [First, *obs.*; second, *local*.]

**YOU**. [Sax. *eow*, *iu*, *iuch*; *G. euch*; *Arm. chuy*; *D. gu* or *yu*, thou.] 1. The nominative and objective plural of *thou*. Although it is strictly applicable only to two or more persons, it is commonly used when a single person is addressed, instead of *thou* and *thee*; but properly with a plural construction; as, *you are*, *you were*, &c. When emphatical, it is pronounced with its full open sound, so as to rhyme with *view*; but when not emphatical, it falls into the sound of the antiquated form *ye*.  
In vain you tell your parting lover,  
You wish fair winds may waft him over. *Prior*.

He that despiseth *you*, despiseth me; Luke x.

2. *You* is used, like *on* in French, for any one. This at a distance looks like a rock; but as *you* approach it, *you* see a little cabin.

**YOUNG**, *a.* (*young*). [Sax. *iong*, *geong*; *G. jung*; *Arm. yaouneq*; *W. ieuanc*; *Sans. yuwana*; *L. juvenis*. *Qu. Ch. Syr. Heb.* and *Sam. p. yunah*, to suck, or *Goth. yuggs*, young. The Welsh

makes the word a compound, and the origin is not evident.] 1. Not having been long born; being in the first part of life; not old; *used of animals*; as, a *young* child; a *young* man; a *young* fawn.—2. Being in the first part of growth; as, a *young* plant; a *young* tree.—3. Ignorant; weak; or rather, having little experience.

Come, elder brother, thou 'rt too *young* in this. *Shak.*

**YOUNG**, *n.* The offspring of animals, either a single animal, or offspring collectively. The cow will take care of her *young*, as will the hen. Animals make provision for their *young*.

**YOUNGER**, *a. comp.* (*yun'ger*.) Not so old as another. A person of ninety years old is *younger* than one of a hundred, though certainly not a *young* man, nor in the first part of life.

**YOUNGEST**, *a. superl.* (*yun'gest*.) Having the least age. There are three persons living, the *youngest* of whom is ninety years old.

**YOUNGISH**, *a.* (*young'ish*.) Somewhat young.

**YOUNGLING**, *n.* (*young'ling*.) [Sax. *geungling*.] Any animal in the first part of life.

**YOUNGLING**, † *a.* Young; youthful.

**YOUNGLY**, † *a.* (*young'ly*.) Youthful.

**YOUNGLY**, *adv.* (*young'ly*.) Early in life.

—2. Ignorantly; weakly. [Little used.]

**YOUNGSTER**, *n.* (*young'ster*.) A young person; a lad; a colloquial word.

**YOUNGTH**, for *Youth*, is not in use.

**YOUNK'ER**, *n.* A youngster. [*Colloq.*] Among *seamen*, a stripling in the service.

**YOUR**, *a. pronom.* (*yure*.) [from *you*; *Sax. eover*; *G. euer*.] 1. The possessive form of *you* when the thing possessed follows; as, *your* book, otherwise the possessive form is *yours*; as, this book is *yours*; I have no pen, give me *yours*. When emphatical it is always pronounced full and open, like the noun *ever*; but when not emphatical, it generally sinks into *yur*, like the last syllable of *law-ye*. The same remark applies to *yourself*, *yourselves*.—2. Belonging to you; equally applicable to both numbers; as, *your* father; *your* heart; *your* prince; *your* subjects.—3. It is used indefinitely.

*Your* medalist and *your* critic are much nearer related than the world imagine. *Addison*.

**YOURSELF**, *pron. plur.* *Yourselves*. [*your* and *self*.] A word added to *you*, to express distinction emphatically between you and other persons. This work you must do *yourself*; or you *yourself* must do it; that is, *you* and no other person. Sometimes it is used without *you*.

Allow obedience, if *yourselves* are old. *Shak.*

2. It is used as the reciprocal pronoun. You love only *yourself*; you have brought this calamity on *yourselves*; be but *yourselves*.

**YOUTH**, *n.* (*yüth*.) [Sax. *iuguth*, *iugoth*, *iogoth*, *geogath*; *Goth. yuggs*; *G. jugend*; *D. joudg*.] 1. The part of life that succeeds to childhood. In a general sense, youth denotes the whole early part of life, from infancy to manhood; but it is not unusual to divide the stages of life into *infancy*, *childhood*, *youth*, and *manhood*. In this sense, the word can have no plural.

Those who pass their *youth* in vice, are justly condemned to spend their age in folly. *Rambler*.

2. A young man. In this sense it has a plural.  
Seven *youths* from Athens yearly sent. *Dryden*.

3. A young person, male or female.—4. Young persons, collectively.

It is fit to *youth* to read the best authors first. *B. Jonson*.

**YOUTHFUL**, *a.* Young; as, two *youthful* knights.—2. Pertaining to the early part of life; as, *youthful* days; *youthful* age.—3. Suitable to the first part of life; as, *youthful* thoughts; *youthful* sports.—4. Fresh; vigorous; as in youth.

**YOUTHFULLY**, *adv.* In a youthful manner.

**YOUTHFULNESS**, *n.* Fulness of youth.

**YOUTH'HOOD**, † *n.* Youth.

**YOUTHLY**, † *a.* Young; early in life.

**YOUTHY**, *a.* Young. [*Bad, and not used*.]

**YPIGHT**, † *a.* Fixed, that is, pitched.

**YPOINT'ING**, † *a.* Pointing; directed to.

Heaven *ypointing* pyramid. *Milton*.

**YT'TRIA**, *n.* [so called from *Ytterby*, a quarry in Sweden.] A metallic oxide, or earth, having the appearance of a white powder, which is insipid, insoluble in water, and infusible. It dissolves in acids, forming sweetish salts, which have often an amethyst colour. It has no action on vegetable colours. *Ytria* seems to be a protoxide of yttrium, its metallic base. It was discovered in 1794, by Professor Gadolin, in a mineral found at *Yterby*, called from him *gadolinite*. It also occurs in *yttrio-cerite* and *yttrio-tantalite*.

**YT'TRIOUS**, *a.* Pertaining to *yttria*; containing *yttria*; as, the *yttrious* oxide of columbium.

**YT'TRIUM**, *n.* The metallic base of *yttria*. It was first obtained pure in 1828, by Wöhler. Its texture is scaly, its colour grayish-black, and its lustre perfectly metallic. It is a brittle metal, and is not oxidized either in air or water, but when heated to redness it burns with splendour, even in atmospheric air, and with far greater brilliancy in oxygen gas. This metal, or rather its oxide, is so rare as not to admit of any useful application.

**YTTRIO-CERITE**, *n.* A mineral occurring very sparingly at *Finbo* and *Brodbo*, near *Fahlun* in Sweden, imbedded in quartz. Its colour is violet-blue, inclining to gray and white. It is sometimes white. These colours generally alternate in layers, in the same specimen. It occurs crystallized and massive, and consists of fluoric acid, *yttria*, oxide of cerium, and lime. Before the blow-pipe it is infusible, but loses its colour and becomes white. It is acted on by acids, and the solution gives a precipitate soluble in carbonate of ammonia.

**YTTRIO-COLUMBITE**, } *n.* A mine-  
**YTTRIO-TANTALITE**, } ral species, of which there are three varieties—the yellow, the dark, and the black—found at *Ytterby*, in Sweden. They are composed of *columbic acid*, *tungstic acid*, *yttria*, lime, oxide of uranium, and oxide of iron, the principal ingredients being *columbic acid* and *yttria*. The whole are infusible before the blow-pipe; but they decrepitate, and assume a light colour. They dissolve with *borax*; but are not acted upon by acids.

**YU**, *n.* The Chinese name for nephrite or jad,—*which see*.

**YUC'EA**, *n.* A genus of American plants, nat. order Liliaceæ. The spe-



*Yucca gloriosa.*

cies are handsome plants, with copious white paniced flowers, extremely ele-

gant, but destitute of odour. The leaves are long, numerous, simple, rigid or coriaceous, and pungent. There are several species, known by the name of Adam's needle. *Y. gloriosa*, or common Adam's needle, is much prized on account of its panicle of elegant flowers, which attain a height of ten or twelve feet.

**YUCK**, *v. i.* To itch. [*Local.*]

**YUCK**, *n.* The itch, or scabies. [*Vulgar Scotch.*]

**YUFTS**, *n.* Russia leather, prepared from ox hides in a peculiar manner.

**YUG**, } *n.* In the mythology of India, an  
**YOG**, } age; one of the ages into which the Hindoos divide the duration or existence of the world.

**YU'LAN**, *n.* A beautiful flowering tree of China. The *Magnolia yulan*, a tree of thirty or forty feet, in its native country; but, in European gardens, of not more than twelve feet.

**YULE**, *n.* [*Sax. iule, geohol, gehul, geol; Arm. goul, goul, a feast; W. geyl, a holiday.*] The common Scottish name for Christmas, or the feast of the na-

tivity of our Saviour. In ancient times it was the current name for Christmas in England, and also for the feast at Lammas-tide.

*Note.*—It would appear to have been originally one of the three great festivals in the year, observed by the ancient Goths, namely *Yule* or *Jul*, celebrated at the time of the winter solstice, in honour of the sun.

Masks, singing, dancing, *yule-games*.

*Buxton, Anat. of M-l.*

The mistletoe ceremonial of the *yule* festival continued from the time of the Druids. [*Stukely.*]

**YULE-LOG**, } *n.* A large block of  
**YULE-BLOCK**, } wood, often a tree-root, forming the basis of a Christmas fire in the olden time.

**YUNX**, *n.* A genus of scansorial birds; the wryneck,—*which see.*

**YURT**, *n.* The name given to houses or huts, whether permanent or movable, of the natives of northern Asia or Siberia.

**YUX**, } *n.* [*Sax. yecox.*] A hiccough.

**YUX**, } *v. i.* To hiccough.

## Z.

**Z**, THE last letter of the English Alphabet, is a sibilant articulation, and is merely a vocal *S*. It bears the same relation to *s*, as *v* does to *f*. With us it has not a compound sound, nor is it a double consonant, as in the Italian and German. It is as simple in its sound as *S*. The words in English which begin with *z*, are all derived from other languages, mostly from the Greek. As a numeral, *Z* stands for 2000, and with a dash over it, *Z*, for 2,000,000. It is pronounced *zed*, and its vulgar or local name is *izzard*.

**Z'ABAISM**. See **SABIANISM**.

**ZABUCA'JO NUTS**, *n.* The fruit of *Lecythis zabucajo*, a South American plant, having a peculiar seed vessel which opens by a lid. [*See PRXIDUM.*] The nuts are occasionally used as a dessert.

**ZAC'CHO**, *n.* The lowest part of the pedestal of a column.

**ZAFFAR**, *n.* Impure oxide of cobalt.

**ZAFFIR**, } The residuum of cobalt,  
**ZAFFRE**, } after the sulphur, arsenic, and other volatile matters, have been expelled by calcination; so that it is a gray or dark gray oxide of cobalt, mixed with a portion of silix. Zaffre is employed for painting pottery ware and porcelain of a blue colour. The blue of zaffre is the most solid and fixed of all the colours that can be employed in vitrification. It is also used in the manufacture of cobalt.

**ZAIM**, *n.* A Turkish chief or leader.

**ZAM'BO**, *n.* The child of a mulatto and a negro; also sometimes of an Indian and a negro.

**ZAM'IA**, *n.* A genus of plants, nat. order Cycadaceæ. The species are found in the tropical parts of America, and also at the Cape of Good Hope and in New Holland. They consist of trees with a single cylindrical trunk, increasing by the development of a single terminal bud, and covered by the scaly bases of the leaves. The stems of all the *Zamias* abound in a

muclilaginous juice which has a nauseous odour, and an unpleasant taste, arising from the existence in it of a peculiar proximate principle. This may be removed by boiling, roasting, &c., when some of them form a nutritious article of food. The pith of *Z. cycadis*, Bread-tree *Zamia*, after being prepared in a particular way, is formed into cakes, baked, and eaten by the Caffres and Hottentots. *Z. spiralis* produces large cones composed of nuts about the size of a chestnut, which are eaten by the natives of New Holland.

**ZAM'ITE**, *n.* A fossil plant of the genus *Zamia*.

**ZANNICHEL'LIA**, *n.* A genus of plants, nat. order Naiadaceæ. There is but a single species, *Z. palustris*, marsh horned-pond-weed; a native of ponds, ditches, and rivulets in most parts of Europe. The stem is from twelve to eighteen inches long, thread-shaped, branched, and floating.

**ZANO'NIA**, *n.* A genus of plants, nat. order Cucurbitaceæ. There is but a single species, *Z. indica*, the climbing Indian cucumber, the fruit of which has the flavour of the cucumber.

**ZANTHOPI'CRINE**, } *n.* A bitter  
**XANTHOPI'CRINE**, } crystalline substance, obtained from the bark of *Xanthoxylum clava Herculis*. Its properties are little known.

**ZAN'TIOTE**, } *n.* A native of Zante,  
**ZAN'TIOT**, } one of the Ionian islands.

**ZAN'NY**, *n.* [*It. zanni, a buffoon.*] A merry-andrew; a buffoon.

**ZAN'NY**, *v. t.* To mimic.

**ZAN'NYISM**, *n.* The state or character of a zany.

**ZAPH'ARA**, *n.* A mineral used by potters to produce a sky colour in their wares.

**ZAP'OTE**, *n.* In *Mexico*, the general name of fruits which are roundish and contain a hard stone.

**ZAR'NICH**, *n.* [*See ARSENIC.*] A name given to the native sulphurets of ar-

senic, sandarach or realgar, and orpiment.

**ZAX**, *n.* An instrument used by slaters for cutting and dressing slates.

**ZAYAT**, *n.* A Burman caravansary or resting place for travellers.

**ZEA**, *n.* In *nat. hist.*, the generic name of maize. Two species only of *Zea* are known; viz., *Z. mays* and *Z. caragua*. The former is common *Indian-corn*; the latter is quite different as respects the ear and seeds. [*See MAIZE.*]

**ZEAL**, *n.* [*Gr. zelos; L. zelus.*] Passionate ardour in the pursuit of any thing. Excessive zeal may rise to enthusiasm. In general, zeal is an eagerness of desire to accomplish or obtain some object, and it may be manifested either in favour of any person or thing, or in opposition to it, and in a good or bad cause.

*Zeal, the blind conductor of the will.*

*Dryden.*

They have a *zeal* of God, but not according to knowledge; Rom. x.

A *zeal* for liberty is sometimes an eagerness to subvert, with little care what shall be established. [*Johnson.*]

**ZEAL**, *v. i.* To entertain zeal.

**ZEALÉD**, } *n.* Filled with zeal.

**ZEALÉSS**, } *n.* Wanting zeal.

**ZEALOT**, *n.* (*zel'ot.*) One who engages warmly in any cause, and pursues his object with earnestness and ardour. It is generally used in dispraise, or applied to one whose ardour is intemperate and censurable. The fury of *zealots* was one cause of the destruction of Jerusalem.

**ZEALOT'ICAL**, *a.* Ardently zealous [*Little used.*]

**ZEAL'OTISM**, *n.* The character or conduct of a zealot.

**ZEAL'OTRY**, *n.* Behaviour of a zealot. [*Rarely used.*]

**ZEALOUS**, *a.* (*zel'us.*) Warmly engaged or ardent in the pursuit of an object.

Being thus saved himself, he may be zealous in the salvation of souls. [*Luce.*]

**ZEALOUSLY**, *adv.* (zel'usly.) With passionate ardour; with eagerness.

It is good to be *zealously* affected always in a good thing; Gal. iv.

**ZEALOUSNESS**, *n.* (zel'usness.) The quality of being zealous; zeal.

**ZE'BRA**, *n.* A pachydermatous mammal, the *Equus zebra*, a quadruped of



Zebra (*Equus zebra*).

Southern Africa, nearly as large as a horse, white, with numerous brownish-black bands of greater or less intensity, and lighter down the middle of each band. The zebras graze in herds on the steep hill side, and seek the wildest and most sequestered spots, so that they are extremely difficult of approach, not only from their watchful habits and great swiftness of foot, but also from the inaccessible nature of their abode. They are incapable of being tamed, unless they are taken very young. There is another species of zebra, *E. burchellii*, which inhabits the plains of South Africa, beyond the Orange river. It is a beautiful animal, having the ears and tail more like those of the horse than the preceding species, which approaches the ass in these particulars. It admits of being tamed to a certain extent, but even in its most tractable state it is described as wicked, treacherous, obstinate, and fickle. The zebras belong to the family that contains the horse and the ass.

**ZE'BRA PLANT**, *n.* The *Calathea zebrina*, called *zebra plant* from the stripes on its leaves.

**ZE'BRA WOOD**, *n.* A kind of wood used by cabinet-makers, produced by the *Omphalobium lamberti*, belonging to the nat. order Connaraceæ.

**ZE'BU**, *n.* A ruminant mammal of the bovid tribe, the *Taurus indicus* or *Bos indicus* of the naturalists. This bovine



Zebu (*Taurus indicus*).

quadruped varies in size, from a large mastiff dog to a full grown European bull. It is ordinarily furnished with a fatty excrescence or hump on the shoulders, which has been said sometimes to reach the weight of fifty pounds. It is found extensively in India, and also in Northern Africa.

It is often called the *Indian bull* or *ox*, and *cow*. The zebus are used as beasts of burden, and their flesh is used as an article of food, especially the hump, which is esteemed as a great delicacy.

**ZE'BUB**, *n.* A large and noxious fly of Abyssinia.

**ZE'CHIN**, *n.* [It. *zecchino*; Fr. *sequin*.]

A Venetian gold coin, worth about nine shillings sterling; usually written *Sequin*,—which see. If named from *Zecha*, the place where minted, this is the correct orthography.

**ZECHSTEIN**, *n.* [Ger.] In *geol.*, a magnesian limestone. It lies immediately under the red sandstone and above the marl slate of the magnesian limestone formation.

**ZED**, } The names of the letter Z.

**ZED OARY**, *n.* A medicinal root, belonging to *Curcuma zedoaria*, a plant growing in the East Indies, whose leaves resemble those of ginger, only they are longer and broader. It comes in oblong pieces, about the thickness of the little finger, and two or three inches in length. It is a warm stomachic.

**ZEIN**, } *n.* The gluten of maize; a  
**ZEINE**, } substance of a yellowish colour, soft, insipid, and elastic, procured from the seeds of *Zea mays* or Indian corn. It is said to differ essentially from the gluten of *wheat*.

**ZEMIN'DAR**, *n.* [from *zem*, *zemin*, land.] In *India*, a feudatory or landholder who governs a district of country and collects the revenues of his district for the government. To assist him in the collection of these, the police of the district is under his control, and he holds a police court. A portion of land is assigned to him as subsistence-allowance, and as collector of the revenue he has a per centage (generally ten per cent.) upon the amount collected. In those districts, however, which are in the possession of the British government, the zemindars are recognized as hereditary proprietors of the soil, and the amount of revenue to be paid to government is settled at a fixed rate.

**ZEMIN'DARY**, } *n.* The office or  
**ZEMIN'DAREE**, } jurisdiction of a zemindar; the land possessed by a zemindar.

**ZENA'NA**, *n.* The apartments of the ladies of a Mahomedan family; a seraglio.

**ZEND**, *n.* A language that formerly prevailed in Persia.

**ZEND'AVESTA**, *n.* [Pers. living word.] The sacred book of the Guebbers or Parsees, ascribed to Zoroaster, and revered as a bible, or sole rule of faith and practice. It is written in the Zend language, and is often called *Zend*, by contraction.

**ZEN'DIK**, *n.* In *Arabia*, an infidel; an atheist.

**ZE'NIK**, *n.* In *zool.*, a quadruped; the suricate or four-toed weasel.

**ZE'NITH**, *n.* [Fr.; It. *zenit*; Sp. *zenit* or *cenit*.] We have not found the oriental original.] The top of the heaven or vertical point; the upper pole of the celestial horizon; that point in the visible celestial hemisphere, which is vertical to the spectator, and from which a line drawn perpendicular to the plane of the horizon, would, if produced, pass through the earth's centre, supposing the earth a perfect sphere.

The opposite pole of the celestial horizon is termed the *nadir*, and a vertical line or plane will, if produced, pass through the zenith and nadir, the spectator's place being considered as the centre of the celestial sphere. A plumb line, hanging freely and at rest, is directed to the zenith and nadir. All vertical circles or azimuths necessarily pass through the zenith.

**ZE'NITH DISTANCE**, *n.* The zenith distance of a heavenly body is its distance from the zenith measured on the vertical circle which passes through the body. It is equal to the complement of the altitude when the body is above the horizon, and to the depression increased by 90° when the body is below the horizon.

**ZE'NITH SECTOR**, *n.* An astronomical instrument for measuring with great accuracy the zenith distances of stars which pass near the zenith. It is also used in trigonometrical surveys for determining the difference of latitude of two stations, by observing the difference of the zenith distances of the same star, at the two stations, as it passes the meridian. It consists essentially, as its name implies, of a portion of a divided circle. [See SECTOR.]

**ZE'OLITE**, *n.* [Gr. *ζωο*, to boil, to foam, and *λίθος*, stone.] A class of earthy minerals, so named originally by Cronstedt, from their boiling and swelling when heated by the blow-pipe. Many substances have been confounded under this name, particularly such as are fusible by the blowpipe without addition, and exhibit a phosphoric brilliancy at the moment of fusion. Haüy makes two species of zeolite, which he calls mesotype and stilbite. Werner makes four subspecies, which he calls mealy zeolite, fibrous zeolite, radiated zeolite, and foliated zeolite. He makes zeolite a generic name, and Jameson, who adopts this theory, arranges in this family prehnite, zeolite, apophyllite, cubicite, called by Haüy analcime, chabasite, cross-stone, laumonite, di-pyre, natrolite, and wavelite. According to Dr. Thomson, the zeolites, chemically considered, are, double hydrous, aluminous silicates. Under this head are included apophyllite, talc, harmotome, itnerite, karpholite, levyne, laumonite, mesolite, natrolite, pyrophyllite, steatite, thomsonite, agalmatolite, analcime, chabasite, comptonite, stilbite, zeuxite, and various other minerals.

**ZEOLIT'IC**, *a.* Pertaining to zeolite; consisting of zeolite, or resembling it.

**ZEOLIT'IFORM**, *a.* Having the form of zeolite.

**ZEPHYR**, } *n.* [L. *zephyrus*; Gr.  
**ZEPHYRUS**, } *Ζεφυρος*] The west wind; and poetically, any soft, mild, gentle breeze. The poets personify Zephyrus, and make him the most mild and gentle of all the sylvan deities.

Mild as when Zephyrus on Flora breathes.

**ZER'DA**, *n.* An animal of the canine genus, found in the desert of Zaara, beyond mount Atlas. It is about ten inches in length, with a pointed nose, long whiskers, large black vivid eyes, and remarkably swift of foot. Its colour is a yellowish pale brown. It belongs to the genus *Megalotis* of Illiger.

**ZE'RO**, *n.* [It.] Cipher; nothing. The point of a thermometer from which it is graduated. *Zero*, in the thermo-

meters of Celsius and Reaumur, is at the point at which water congeals. The zero of Fahrenheit's thermometer is fixed at the point at which the mercury stands when immersed in a mixture of snow and common salt, and is 32° below the freezing point of water. In Wedgwood's pyrometer, the zero corresponds with 1077° on Fahrenheit's scale. [See THERMOMETER.]

**ZEST**, *n.* [Pers. *zistan*, to peel.] 1. A piece of orange or lemon peel, used to give flavour to liquor; or the fine thin oil that spurts out of it when squeezed; also, the woody thick skin quartering the kernel of a walnut.—2. Relish; something that gives a pleasant taste; or the taste itself.

**ZEST**, *v. t.* To give a relish or flavour to; to heighten taste or relish.—2. To cut the peel of an orange or lemon from top to bottom into thin slips; or to squeeze the peel over the surface of any thing.

**ZETA**, *n.* A Greek letter, Z, ζ, or ζ, and corresponding to our *zed*. It is the sixth letter in the Greek alphabet.—2. A little closet or chamber, with pipes running along the walls, to convey into it fresh air, or warm vapour from below.

**ZETETIC**, *a.* [Gr. ζητω, to seek.] That seeks; that proceeds by inquiry. The *zetetic* method in mathematics, is that used in investigation, or the solution of algebraical problems. [The term is now disused.]

**ZETETIC**, *n.* A seeker. [This name was taken by some Pyrrhonists.]

**ZETETICS**, *n.* A name given to that part of Algebra which consists in the direct search after unknown quantities. It is now disused.

**ZETICULA**, *n.* A small withdrawing room.

**ZEUGLONDON**, *n.* An extinct species of whale.

**ZEUGMA**, *n.* [Gr. ζευγμα, from ζευω, to join. See YOKE.] A figure in grammar by which an adjective or verb which agrees with a nearer word, is, by way of supplement, referred to another more remote. Thus in Virgil, "Hic illius arma, hic currus fuit," where *fuit*, which agrees directly with *currus*, is referred also to *arma*.

**ZEUS**, *n.* A genus of acanthopterygious fishes, remarkable for their roundish or oval compressed form. To this genus belongs the species, called *doree*, *dory*, and *John Dory*, (*Z. fuber*.) It grows to about 12 or 15 inches in length, and is well known on our coasts. Its flesh is esteemed delicious food. [See DOREE.] Another species is the *Z. opah*, or *opah dory*, which inhabits the seas of warm and temperate regions, and has occasionally been found in those of Britain. It measures between four and five feet in length.

**ZEUXITE**, *n.* A zeolitic mineral found in Cornwall.

**ZEUZERA**, *n.* A genus of nocturnal moths, belonging to the family Hepialidae. A British species, *Z. æsculi*, is known to collectors under the name of the wood leopard.

**ZEYLANITE**, *In mineral*, Ceylanite, — which see.

**ZIBET**, } *n.* [See CIVET.] A digiti-  
**ZIBETH**, } grade carnivorous mam-  
mal, belonging to the genus Viverra, the *V. zibetha*. This is a small quadruped somewhat resembling a weasel. It is found on the Asiatic coast, and in some of the larger islands

of the Indian Archipelago. It differs in several respects from its African congener the civet, (*V. civetta*), but it secretes an odoriferous substance which resembles that of the civet, and is perhaps equally prized.

**ZIBETHUM**, *n.* A name given to the unctuous odoriferous substance secreted by the zibet.

**ZIGZAG**, *a.* Having sharp and quick turns or flexures.—*Zig-zag moulding*, in *arch*, a species of moulding much used in early Norman architecture. It consists of diagonal lines placed in alternate order. It is also termed *chevron* and *dancette*. [See these terms.]—*Zig-zag stem*, in *bot.*, a stem which forms angles alternately from right to left, and the reverse, as in *stactice reticulata*.

**ZIGZAG**, *n.* Something that has short turns or angles, as a line, the stem of a plant, &c.

**ZIGZAG**, *v. t.* To form with short turns or angles.

**ZIGZAGGED**, *pp.* Formed with short turns.

**ZIGZAGGING**, *ppr.* Forming with short turns.

**ZILLAH**, *n.* In the *East Indies*, a local division of a country; a shire or county.

**ZIMB**, *n.* [Arab.] An insect translated *hornet* in scripture, and which is considered to be identical with the *zimb* or



Zimb, from Bruce's Travels.

dog-fly of Abyssinia, as described by Bruce. It is supposed to be a species of Tabanus.

**ZIMENT WATER**, } *n.* A name given  
**COPPER WATER**, } to water found in copper mines; water impregnated with copper.

**ZIMOME**. See ZYMOME.

**ZINC**, *n.* [G. Sw. and Dan. *zink*.] A metal frequently called *spelter* in commerce. It has a strong metallic lustre, and a bluish white colour. Its texture is lamellated and crystalline, and its specific gravity about 7. It is a hard metal, being acted on by the file with difficulty; and its toughness is such as to require considerable force to break it when the mass is large. At low or high degrees of heat it is brittle, but between 250° and 300°, it is both malleable and ductile, and may be rolled or hammered into sheets of considerable thinness, and drawn into wire. Its malleability is considerably diminished by the impurities which the zinc of commerce contains. It fuses at 773°, and when slowly cooled, crystallizes in four or six sided prisms. Zinc undergoes little change by the action of air and moisture. When fused in open vessels, it absorbs oxygen and forms the white oxide called *flowers of zinc*. Heated strongly in air it takes fire and burns with a beautiful white light, forming oxide of zinc. Zinc is found in considerable abundance. It does not occur in the native state, but is obtained from its ores which are chiefly the sulphuret, or *zinc blende*, and the carbonate or *calamine*. The oxide of zinc is a fine white powder insoluble in water, but very soluble in acids which

it neutralizes, being a very powerful base, of the same class as magnesia. It combines also with some of the alkalies. Several of the salts of zinc are employed in medicine, as the sulphate or *white vitriol*, the chloride or *butter of zinc*, the acetate and the cyanuret. Sheet-zinc is now largely employed for lining water cisterns, baths, &c., for making spouts, pipes, for covering roofs, and several other architectural purposes. Plates of this metal are used as generators of electricity in voltaic batteries, &c.; they have also been recently employed in the operation of transferring printing. Zinc is much employed in the manufacture of brass and other alloys. A new application of this metal has been lately announced, namely, that of producing what is termed the *electric light*, to be used as a substitute for gas.

**ZINCIFEROUS**, *a.* [zinc and L. *fero*.] Producing zinc; as, *zinciferous ore*.

**ZINCKY**, *a.* Pertaining to zinc, or having its appearance.

Some effervesce with acids. some not, though soluble therein, as to the *zinky* part.

*Kirwan.*  
The *zinky* ores are said to be grayer than other ores.

**ZINC'ODE**, *n.* The positive pole of a galvanic battery.

**ZINCOGRAPHER**, *n.* [zinc, and Gr. *γραφο*, to write or engrave.] One who draws or writes on zinc plates.

**ZINCOGRAPHIC**, } *a.* Relating  
**ZINCOGRAPHICAL**, } to zincography.

**ZINCOGRAPHY**, *n.* The art of drawing or writing on zinc plates as a substitute for stones.

**ZINC'OUS**, *a.* Pertaining to zinc, or to the positive pole of a voltaic battery.

**ZINGIBER**, *n.* Ginger, a genus of plants, nat. order Zingiberaceæ. The species are natives of hot climates, but the one best known to us, is the *Z. officinalis*, the root of which is the well known Jamaica ginger of the shops. [See GINGER.]

**ZINGIBERACEÆ**, *n.* A nat. order of plants, of which the genus Zingiber is the type. The species are all tropical plants or nearly so, the greater number inhabiting various parts of the East Indies. They are generally objects of great beauty, on account of the development of their floral envelopes, and the rich colours of their bracts; but they are chiefly valued for the sake of the aromatic and stimulating properties of the rhizoma or root, such as are found in ginger, galangale, zedoary, cardamoms, &c.

**ZINKENITE**, *n.* A steel-gray ore of antimony and lead.

**Z'ON**, *n.* A mount or eminence in Jerusalem, the royal residence of David and his successors. Hence,—2. The theocracy or church of God.

**ZIR'CON**, *n.* Called also jargon of Ceylon, a mineral originally found in Ceylon, in the sands of rivers, along with spinel, sapphire, tourmalin, and iron sand. Zircon, hyacinth, and zirconite, are regarded as varieties of the same species. They are essentially composed of zirconia, with silex, and a minute portion of iron. The primitive form of the crystals is an octahedron, composed of two four-sided prisms. The common form is a rectangular four-sided prism.

**ZIRCONIA**, *n.* An oxide of the metal zirconium, discovered by Klaproth,

the year 1780, in the *zircon* of Ceylon, and subsequently in the hyacinth of Expailly in France. It resembles *alumine* in appearance. It is so hard as to scratch glass. When pure it is a white powder. It forms salts with acids.

**ZIRCONITE**, *n.* A variety of the zircon.

**ZIRCONIUM**, *n.* The metallic basis of zirconia. Berzelius first obtained *zirconium* in 1824; but Davy had previously rendered its existence quite probable. It is commonly obtained in the form of a black powder. Its metallic character is questioned by some.

**ZIVOLLO**, *n.* A bird resembling the yellow hammer, and by some considered as the same species.

**ZIZANIA**, *n.* The Greek name of *Lolium temulentum* or darnel. [See DARNEL.]

**ZIZEL**, *n.* A rodent mammal, the *Arctomys citillus*. It is found in Russia and Germany, and also in Asia. It is the *suslik*, often called the earless marmot. It is a small quadruped.

**ZIZYPHUS**, *n.* A genus of plants, natural order Rhamnaceæ. The species are shrubs with alternate leaves, spiny stipules, and mucilaginous fruit, which is edible. *Z. vulgaris*, or common



*Zizyphus vulgaris.*

jujube, is a native of Syria, and is now cultivated in many parts of Europe. In Spain and Italy, the fruit is eaten as a dessert, and in the winter season as a dry sweetmeat. *Z. spina Christi*, is known under the name of Christ's thorn. It is a native of North Africa, Palestine, Ethiopia and Egypt. There are numerous other species.

**ZOANTHARIA**, *n.* [Gr. ζῶον, a living animal, and ἄνθος, a flower.] Animal flowers, the third class of Zoophytes, according to Blainville, corresponding with the *Zoophyta Helianthoida* of Johnston. They are flower-shaped, more or less elongated, very contractile, and have a terminal opening with variously shaped tentacula. They include four families, Lucernariadæ, Actiniadæ, Zoanthidæ, and Madreporidæ.

**ZOANTHUS**. [See ZOANTHARIA.] A genus of Zoophytes, type of the group Zoantharia,—which see.

**ZOC'CO**, } *n.* [It. *zoccolo*; from *L.* }  
**ZOC'CLE**, } *soccus*, a sock.] A square }  
**ZOC'COLO**, } body under the base of }  
 a pedestal, &c., serving for the support }  
 of a bust, statue or column.

**ZODIAC**, *n.* [Fr. *zodiaque*; It. *sp. zodiaco*; *L.* *zodiacus*; Gr. ζῳδιακος, from ζῶον, an animal.] 1. An imaginary belt or zone in the heavens,

extending about 8° on each side of the ecliptic. It is divided into 12 equal parts, called signs. [See SIGN.] It was distinguished by the ancients because the apparent places of the sun, moon, and the planets known to them were not always within it. This, however, is not true of all the newly discovered planets.—2. A girdle.

**ZODIACAL**, *a.* Pertaining to the zodiac; as, *zodiacal signs*; *zodiacal planets*.—*Zodiacal light*, a luminous track of an elongated triangular figure, lying nearly in the ecliptic, its base being on the horizon, and its apex at varying altitudes. In the evening after twilight, it is in this latitude most conspicuous about the months of April and May, or at the opposite seasons before sun-rise. Its nature is unknown.

**ZOHAR**, *n.* [Heb.] A Jewish book of cabalistic commentaries on scripture, and highly esteemed by the rabbis.

**ZOISITE**, *n.* [from *Van Zois*, its discoverer.] A mineral regarded as a variety of epidote. It occurs in deeply striated rhomboidal prisms, much compressed and rounded; its colours gray, yellowish or bluish gray, brown, grayish yellow, or reddish white.

**ZOLLVEREIN**, *n.* [Ger. *zoll*, toll, custom, duty; and *verein*, union or association.] The Prussian or German commercial or customs union, founded, through the example and efforts of the government of Prussia, in the year 1834, and having for its object the establishment of a uniform rate of customs duties throughout the various states joining the union.

**ZONE**, *n.* [*L.* *zonus*; Gr. ζώνη.] 1. A girdle.

An embroider'd zone surrounds her waist.

*Dryden.*

2. In *geography*, a division of the earth, with respect to the temperature of different latitudes. The zones are five, the torrid zone, extending from tropic to tropic; two temperate or variable zones, situated between the tropics and polar circles; and two frigid zones, situated between the polar circles and the poles.—3. In *nat. hist.*, a band or stripe running round an object.—4. Circuit; circumference.—5. In *bot.*, applied to the circles of wood in dicotyledonous or exogenous stems. Also different belts of vegetation which occur in mountains.—*Ciliary zone*, in *anat.*, the black impression of the ciliary processes on the vitreous humour of the eye.

**ZONED**, *a.* Wearing a zone.—2. Having zones or concentric bands.

**ZONELESS**, *a.* Destitute of a zone.

**ZON'NAR**, } *n.* A belt or girdle which }  
**ZON'NAR**, } the Christians and Jews in }  
 the Levant are obliged to wear, to }  
 distinguish them from the Mahomedans.

**ZOOCEARP**. See ZOOSPHERE.

**ZOOCEARPIA**, *n.* In *bot.*, a genus of plants.

**ZOOGRAPHER**, *n.* [See ZOOGRAPHY.] One who describes animals, their forms and habits.

**ZOOGRAPHICAL**, *a.* Pertaining to the description of animals.

**ZOOGRAPHER**, *n.* One who describes or depicts animals.—2. A zoologist.

**ZOOGRAPHY**, *n.* [Gr. ζῶον, an animal, and γραφω, to describe.] A description of animals, their forms and habits.

[But *zoology* is generally used.]

**ZOOLOGY**, *n.* [Gr. ζῶον, an animal,

and λατρεω, to worship.] The worship of animals.

**ZOOLITE**, *n.* [Gr. ζῶον, an animal, and λίθος, stone.] An animal substance petrified or fossil.

**ZOOL'OGER**, } *n.* A zoologist.

**ZOOLOGICAL**, *a.* [from *zoology*.] Pertaining to zoology, or the science of animals.

**ZOOLOGICALLY**, *adv.* According to the principles of zoology.

**ZOOLOGIST**, *n.* [from *zoology*.] One who is well versed in the natural history of animals, or who describes animals.

**ZOOLOGY**, *n.* [Gr. ζῶον, an animal, and λογος, discourse.] That part of natural history which treats of the structure, habits, classification, habitations, &c., of all animals, from man to the lowest of all the tribes. Thus zoology treats of all those beings comprehended in the term "animal kingdom." It embraces *comparative anatomy*, *animal physiology*, and all the great questions relating to the succession of species of animals upon the earth, the parts which they play in the theatre of nature, and the geographical distribution of existing species; another branch, termed *descriptive zoology*, is restricted to the outward characters, habits, properties, and the classification of animals. Various systems of classification have been framed by zoologists. Linnæus divided the animal kingdom into six classes, viz., *mammalia*, *birds*, *fishes*, *amphibians*, *insects*, and *worms* (vermes). Cuvier gives a more definite arrangement. He divides the animal kingdom into four sub-kingsdoms, viz., *vertebrata*, *mollusca*, *articulata*, and *radiata*. [See *these terms*.] The term *zoology* is sometimes used in a more restricted sense, to signify the natural history of quadrupeds or mammalia, which, however, is more correctly termed *therology*, and is thus distinguished from *ornithology*, *ichthyology*, *entomology*, &c.

**ZOONIC**, *a.* [Gr. ζῶον, an animal.] Pertaining to animals; obtained from animal substances.—*Zoonic acid*, a name given by Berthollet to acetic acid, combined with animal matter, and obtained by distilling animal matter.

**ZOONOMY**, *n.* [Gr. ζῶον, an animal, and νόμος, law.] The laws of animal life, or the science which treats of the phenomena of animal life, their causes and relations.

**ZOOPI'AGA**, *n.* A name given to those tribes of animals which attack and devour living animals, such as the lion, the tiger, the wolf, &c.

**ZOOPI'AGAN**, *n.* One of the zoophaga.

**ZOOPI'AGOUS**, *a.* [Gr. ζῶον, an animal, and φαγω, to eat.] Feeding on animals.

**ZOOPHITE**. See ZOOPLANT.

**ZOOPHORIC**, *a.* [Gr. ζῶον, an animal, and φορος, to bear.] The zoophoric column is one which supports the figure of an animal.

**ZOOPH'ORUS**, *n.* [supra.] In *ancient arch.*, the same with the *frieze* in modern architecture; a part between the architrave and cornice; so called from the figures of animals carved upon it.

**ZOOPHYTE**, *n.* [Gr. ζῶον, an animal, and φυτον, a plant.] 1. In *nat. hist.*, a body resembling an animal and a vegetable, and once supposed to partake of the nature of both, such as madrepores, millepores, corallines, &c.—2. The



*zoophytes*, or *zoophyta*, form a great division of the animal kingdom, comprehending beings which are always evidently more simple in organization than in the other divisions, and which have their parts more or less distinctly arranged round an axis, a disposition which frequently gives them the shape of flowers, and hence the name, which signifies *living plants*, or *plant-like animals*. This division contains the starfishes and sea-eggs, as well as the actiniae, corals, and corallines. Cuvier applies the name *radiata* to the zoophytes, and arranges them under five classes, viz., *echinodermata*, *entozoa*, or intestinal worms, *acalepha*, or sea-nettles, *polypi*, and *infusoria*.

ZOOPHYTIC, } a. Relating to zoophytes.

ZOOPHYTICAL, } phytes.

ZOOPHYTOLOGICAL, a. Pertaining to zoophytology.

ZOOPHYTOLOGY, n. [*zoophyte*, and Gr. *λογος*, discourse.] The natural history of zoophytes.

ZOOSPERM. See ZOOSPORE.

ZOOSPORE, n. A spore occurring in cryptogamic plants, having cilia or moving processes projecting from its surface. Such spores move about in water for a certain length of time.

ZOOTOMICAL, a. [See ZOOTOMY.] Pertaining to zootomy.

ZOOTOMIST, n. [See ZOOTOMY.] One who dissects the bodies of animals; a comparative anatomist.

ZOOTOMY, n. [Gr. *ζωο*, an animal, and *τομή*, to cut.] The anatomy of the lower animals; that branch of anatomical science which relates to the structure of brute animals; comparative anatomy.

ZOPHORUS. See ZOOPHORUS.

ZOPIS'SA, n. A sort of pitch scraped off the sides of ships, and tempered with wax and salt.

ZORILL, } n. A fetid animal, a mere

ZORILLE, } variety of the *Mephitis Americana*, or skunk, found in South America. [In Sp. *zorro* is a fox, and *zorillo* the whelp of a fox.]

ZOSTER, n. [L. from Gr. *ζώνη*, to gird.] In *med.*, a kind of erysipelas, which goes round the body like a girdle.

ZOSTERA, n. The grass-wrack or sea-wrack, a genus of plants. [See GRASS-WRACK.]

ZOSTERITE, n. A fossil plant of the genus *Zostera*.

ZOSTEROPS, n. A genus of perching birds, closely allied to the warblers, and seemingly intermediate between them and the titmice. One distinguishing characteristic of the species belonging to this genus is, that the eyes are encircled by a ring of snow-white feathers. Hence they have been named *white-eye*. They are small birds, found chiefly in Africa, Asia, and Australia.

ZOTHE'CA. [Gr.] In *ancient arch.*, a small apartment or alcove.

ZOUNDS. An exclamation, contracted from "God's wounds;" formerly used as an oath, and an expression of anger or wonder.

ZOZYMIUS, n. The name given by Leach to a genus of brachyurous crustaceans.

ZUF'FOLO, n. [It. *zufolo*, from *zufolare*, to hiss or whistle, L. *sufflo*.] A little flute or flageolet, especially that which is used to teach birds.

ZUMATE. See ZYMATE.

ZUMBOO'RUK, n. [*Zumboor*, a wasp.] In the East, a small cannon supported by a swivelled rest on the back of a camel, whence it is fired. There were many such in the Sikh armies.

ZUMIE. See ZYMIC ACID.

ZUMOLOGICAL, a. [See ZUMOLOGY.] Pertaining to zumology. [This word should be written *Zymological*.]

ZUMOLOGIST, n. One who is skilled in the fermentation of liquors. [This word should be written *Zymologist*.]

ZUMOLO'GY, n. [Gr. *ζυμω*, ferment, from *ζυμαω*, to ferment, and *λογος*, discourse.] A treatise on the fermentation of liquors, or the doctrine of fermentation. [This word should be written *Zymology*.]

ZUMOMETER, } n. [Gr. *ζυμαω*,

ZUMOSIMETER, } fermentation, or *ζυμω*, ferment, and *μετρον*, to measure.] An instrument proposed by Swammerdam for ascertaining the degree of fermentation occasioned by the mixture of different liquids, and the degree of heat which they acquire in fermentation. [This should be written *Zymometer* or *Zymosimeter*.]

ZUR'LITE, n. A newly discovered Vesuvian mineral, whose primitive form is a cube, or according to some authors, a rectangular prism.

ZYGÆ'NA, n. A genus of chondropterygious fishes, belonging to the shark family, and distinguished by the horizontally flattened head, truncated in front, its sides extending transversely like the head of a hammer; whence the species have received the common name of *hammer-headed sharks*. They are found in the Mediterranean and Indian seas.

ZYGE'NIDÆ, n. A tribe of lepidopterous insects, of the family *Crepuscularia*, Cuvier. The antennæ, which are always terminated in a point destitute of a tuft, are sometimes simple in both sexes, fusiform or resembling a rani's horn, &c. The caterpillars live exposed on various leguminous plants. The *Zygena filipendula* is a common British species.

ZYGODACTYLI, } n. The name

ZYGODACTYLES, } given by Temnick and others, to an order of perching birds which have their feet composed of two anterior and two posterior toes, the external toe of the two latter being capable of a direction either

forward or backward. The parrots, woodpeckers, toucans, cuckoos, &c., belong to this order.

ZYGODACTYLIC, } a. [Gr. *ζυμαω*,

ZYGODACTYLOUS, } to join, and *δακτυλος*, a finger.] Having the toes disposed in pairs; distinguishing an order of fowls which have the feet furnished with two toes before and two behind, as the parrot, woodpecker, &c.

ZYGO'MA, n. In *anat.*, the process of the cheek-bone, a bone of the upper jaw.

ZYGOMATIC, a. [Gr. *ζυγωμα*, a joining.] Pertaining to a bone of the head, called also *os jugale*, or cheek bone, or to the bony arch under which the temporal muscle passes. The term *zygoma* is applied both to the bone and the arch.—*Zygomatic arch*. [See ZYGOMATIC.]—*Zygomatic bone*, the cheek bone.—*Zygomatic muscles*, two muscles of the face, which rise from the zygomatic bone, and are inserted into the corner of the mouth.—*Zygomatic processes*, the processes of the temporal and cheek bones, which unite to form the zygomatic arch.—*Zygomatic suture*, the suture which joins the zygomatic processes of the temporal and cheek bones.

ZYGOPHYLLA'CEÆ, n. A nat. order of polypetalous exogenous plants, nearly related to Oxalidaceæ and Rutaceæ. The species are herbs, shrubs, and trees, having a very hard wood, and the branches often articulated. The greater part of them are distributed throughout the temperate regions. To the order belong the Caltrops (*Tribulus*), the Bean-caper (*Zygophyllina*), *Lignum vitæ* (*Guaiacum*), honey-flower (*Melanthus*), &c.

ZYGOSTAT'ES, n. [Gr. *ζυγμα* and *στατος*.] The clerk of a market who examines the weights and measures.

ZYM'ATE, } n. A supposed compound

ZUMATE, } of the imaginary *zymic acid* with a base. As there is no such acid there can be no such salt.

ZYMIC-ACID, } n. [Gr. *ζυμω*, ferment.]

ZUMIC-ACID, } A supposed peculiar acid obtained by the acetous fermentation of vegetable substances. No such peculiar acid exists.

ZYMOLOGY, n. See ZUMOLOGY, &c.

ZYM'OME, } n. [Gr. *ζυμω*.] One of

ZIM'OME, } the supposed proximate principles of the gluten of wheat. It is a tough substance, insoluble in alcohol. There are doubts as respects the existence of *zymome* as a truly distinct substance.

ZYMO'METER. See ZUMOMETER.

ZYTBEP'SARY, n. A brewery, or brew-house.

ZYTHUM, n. [Gr. *ζυθω*, to boil.] A beverage; a liquor made from malt and wheat.

THE END.

