

BERKELEY
LIBRARY
UNIVERSITY OF
CALIFORNIA

INFINITESIMAL ANALYSIS.



INFINITESIMAL ANALYSIS

BY

WILLIAM BENJAMIN SMITH

PROFESSOR OF MATHEMATICS IN TULANE UNIVERSITY

VOL. I.

ELEMENTARY: REAL VARIABLES



New York

THE MACMILLAN COMPANY

LONDON : MACMILLAN AND CO., LIMITED

1898

All rights reserved

53141714

Cart/sep
MATH

74704

QA 303

S653

1898

v. 1

MATH

PREFACE.

THIS volume has been written on what appeared, in the light of ten years' experience in teaching the Calculus, to be lines of least resistance. The aim has been, within a prescribed expense of time and energy, to penetrate as far as possible, and in as many directions, into the subject in hand,—that the student should attain as wide knowledge of the matter, as full comprehension of the methods, and as clear consciousness of the spirit and power of this analysis as the nature of the case would admit. Accordingly, what seemed to be natural suggestions and impulses towards near-lying extensions or generalizations have often been followed, and even allowed to direct the course of the discussion. Hereby, necessarily, the exposition has suffered in symmetry and in systematic character; but everything has the defects of its own qualities.

The aim already stated, no less than the plan of its pursuit, has excluded Weierstrassian rigor from many investigations and compelled the postponement of important discussions as too subtle for an early stage of study; in particular, no attempt has been made to deal with Series, unless the most familiar, or to follow in the wake of the masters of ϵ -methods. But real difficulties have not been knowingly disguised, and the reader is

often warned that the treatment given is only provisional and must await further precision or delimitation.

It has also resulted that some topics have been merely mentioned, it appearing at once that further investigation would lead straightway beyond the prescribed limits of the volume, or into difficulties for which the reader was not prepared. But it is believed that the glimpses thus afforded of wider and higher fields have a distinct value, and may attract the student with promise of richer reward for renewed effort. The book is, in fact, written for such as feel genuine interest in the subject, whose minds are open to such inspiration.

It was in the original scheme of this volume to add an Appendix, in which certain purely algebraic assumptions of the text, as the Exponential Theorem and Decomposition into Part-Fractions, should be carefully grounded; but the volume having grown beyond expectation, such addenda have been omitted, as in any case dispensable. Though the discussion has been confined to real variables, an occasional passing employment of the Eulerian i has seemed unavoidable.

The illustrations and exercises have been chosen with frequent reference to practical or theoretic importance, or to historic interest, and without any pretence of novelty. The author acknowledges in full his great indebtedness to the works of Amstein, Byerly, Edwards, Greenhill, Gregory, Harnack, Johnson, Sohncke, Stolz, Todhunter, Williamson, and others, from which the examples, in particular, have been mostly culled.

He desires also to return thanks publicly to Professor Dr. Carlo Veneziani for patient and painstaking revision both of the MS. and of the proof-sheets. Such services would under any circumstances have been valuable; but

under the peculiar embarrassments that have beset every stage of the composition of this volume they have been invaluable. Thanks are also due to the author's colleague, Mr. J. E. Lombard, for assistance in proof-reading, and especially in drawing the figures.

The author will be grateful for indication of errors, either of pen or of type. If, in spite of all such, the book shall prove useful, whether by enlightening or by inciting, and shall advance the mastery of the most powerful weapon of thought yet devised by the wit of man, its end will be in some measure attained.

W. B. S.

NEW ORLEANS,

Christmas, 1897.

CONTENTS.

CHAPTER I.

FUNDAMENTAL NOTIONS AND OPERATIONS.

ARTICLES	PAGES
1, 2. The Notion of Limit : Illustrations - - -	1
3-5. Definitions - - - - -	2, 3
6-11. Theorems on Limits - - - - -	3-5
12, 13. Definition, Notation, and Classification of Functions -	5, 6
14, 15. Correspondences, Continuity - - - - -	7, 8
16-18. Difference-Quotient : Illustrations - - - - -	9, 10
19-22. Derivative and Differential Coefficient - - -	11, 12
23-29. Theorems on Derivatives - - - - -	12-15
30, 31. Geometrical Illustration. Exceptional Cases - -	15, 16
32. Problem of Tangents - - - - -	17
33, 34. Illustration from Mechanics - - - - -	18, 19
35, 36. Further Considerations - - - - -	19, 20
37-41. Elementary Derivations - - - - -	21-23
42-44. Geometric Proof, Ratio of Chord and Arc - - -	24-26
45. Other modes of Proof - - - - -	27
46. Other Trigonometric Functions - - - - -	28
47. Sense of Derivative - - - - -	28
48, 49. Inverse Functions - - - - -	28, 29
Exercises - - - - -	30-32
50, 51. Tangent, Normal, etc. - - - - -	32
52. Derivative of the Arc - - - - -	33
53. Polar Coordinates - - - - -	34
54. Infinitesimals of Higher Order - - - - -	36
55. Additional Formulae - - - - -	37
56. Angle between two Curves - - - - -	38
57-59. Pedal Curves - - - - -	38
Exercises - - - - -	39, 40

ARTICLES	PAGES
60. Pencils and Parameters - - - -	41
61. Intersection of Elements - - - -	42
62. Intersection of Consecutives - - - -	43
63, 64. Envelopes - - - -	43, 44
65. Parameters with Conditions - - - -	45, 46
Exercises - - - -	47
66-68. Higher Derivatives - - - -	48-50
69. Theorem of Leibnitz - - - -	51
70, 71. Derivatives of e^{ax} and $e^{ax}X$ - - - -	52
72. Meaning of Operator - - - -	53
73. Application to Sine and Cosine - - - -	53
74. Extension of Leibnitz' Theorem - - - -	54
75, 76. Operator xD - - - -	54
77, 78. Anti-operators - - - -	55, 56
79. Indefiniteness of Inverse Operations - - - -	57
Exercises - - - -	58-60

CHAPTER II.

INTEGRATION.

80, 81. Problem of Areas, Illustration - - - -	61, 62
82. Integration not Summation - - - -	63
83. Deductions - - - -	64, 65
84. Theorem of Mean Value - - - -	66
85. Derivation of Integral as to Extremes - - - -	67
86-90. Various Quadratures - - - -	68-73
91-94. Need of better Method. Integration and Derivation	73-75
95. Definite and Indefinite Integrals - - - -	76
96. Fundamental Forms - - - -	77-78
97. Change of Variable - - - -	79
98. Integration by Parts—Illustrations - - - -	80-81
99. Circle and Equiaxial Hyperbola - - - -	82
100. Anti-functions Re-defined - - - -	83
101, 102. Hyperbolic Cosine and Sine - - - -	84
103. Anti-hyper-functions - - - -	85
104. The Arguments pure Numbers - - - -	86
105. Relations of the Functions - - - -	86
106. Exponentials - - - -	87
107-109. Other Hyper-functions. Gudermannians. Geometric Property - - - -	88-90
110. Ellipse and Hyperbola - - - -	91
111. Logarithmic Expression - - - -	91

CONTENTS.

xi

ARTICLES	PAGES
112. Imaginary Exponentials - - - -	92
113. Reduction to Standard Forms - - - -	92
Exercises - - - -	93
114, 115. Powers of Sine and Cosine, Secant and Cosecant -	93, 94
116, 117. Odd and Even Powers - - - -	95
118-121. Tangent and Special Integrals - - - -	96, 97
122. Simple Fractions - - - -	97
123. Rational Algebraic Functions - - - -	98
124. Irrational Quadratics - - - -	99, 100
125. Higher Functions - - - -	101
126. Exponentials and Trigonometric Functions -	102
127. Illustrations and Exercises - - - -	103-112

CHAPTER III.

APPLICATIONS.

128, 129. Bernoulli's Series. Taylor's Series - - - -	113, 114
130. Lagrange's and Cauchy's Forms - - - -	114
131. Interpretation of the Series - - - -	115
132, 133. Stirling's Series. Relations of the Series -	116
134, 135. Development of Logarithm - - - -	117, 118
136, 137. Expansion of Anti-tangent - - - -	119
138. Binomial Theorem - - - -	120
139. Newton's Method - - - -	120
140, 141. Bernoulli's Numbers - - - -	121
Exercises - - - -	122, 123

EVANESCENTS.

142-144. Removal of Factors - - - -	124, 125
145. Illustrations - - - -	126
146. Application of Taylor's Series - - - -	127
147. Simplifications - - - -	128
148, 149. Other Illusory Forms - - - -	128
150. Illustrations - - - -	129-131
Exercises - - - -	132-134

MAXIMA AND MINIMA.

151, 152. Definitions. Relativity - - - -	134
153, 154. Conditions - - - -	135
155. Continued Vanishing of Derivatives - - - -	136
156. Use of Taylor's Theorem - - - -	137
157. Geometric Interpretation - - - -	138

ARTICLES	PAGES
158. Rule for Practice - - - - -	139
159, 160. Exceptional Cases. Discontinuities - -	139
161. Geometric Problems - - - - -	140
162. Simplifications - - - - -	141
Exercises - - - - -	141-148

CHAPTER IV.

GEOMETRIC INTERPRETATION OF HIGHER DERIVATIVES.

163. Order of Contact - - - - -	149
164. Tangency of Curves - - - - -	150
165. Concavity and Convexity - - - - -	151
166, 167. Curvature - - - - -	152, 153
168-170. Uniform Curvature, Standard of Curvature, Centre of Curvature - - - - -	154-156
171, 172. Evolute and Involute - - - - -	157, 158
173. Centre of Curvature redefined - - - - -	159
174, 175. Higher and Closest Contact - - - - -	159-161
176, 177. Exceptional Points. Maximal and Minimal Curva- ture - - - - -	162, 163
178. Osculatory Circle - - - - -	164
179. Application to the Conic - - - - -	164
180. Illustrations - - - - -	165-170

CHAPTER V.

VARIOUS PROBLEMS OF INTEGRATION.

181. Quadrature - - - - -	171, 172
182. Rectification - - - - -	173
183. Cubature - - - - -	173, 174
184. Quadrature of Revolutes - - - - -	175, 176
185, 186. Averages. Mass-centre - - - - -	177-179
187, 188. Moments - - - - -	180
189. Radius of Gyration - - - - -	181
190, 191. Parallel Axes. Normal Axes - - - - -	181, 182
192. Density - - - - -	182
193, 194. Theorems of Pappus - - - - -	183
195, 196. Choice of Elements. Symmetry - - - - -	184
197. Illustrations - - - - -	185-191

CHAPTER VI.

PARTIAL DERIVATION.

ARTICLES	PAGES
198. Double Dependence - - - -	192
199. Geometric Depiction - - - -	193
200. Parallel Sections - - - -	193
201. Tangency - - - -	194
202. Partial Derivatives - - - -	195
203. Equation of Tangent Plane - - - -	196
204. Equations of Normal - - - -	197
205. Simultaneous Changes - - - -	197, 198
206, 207. Theorem of Total Differential. Limitations - - - -	199
207*. Tortuous Curves - - - -	200-207
208. Use of Third Variable - - - -	207
209, 210. Higher Derivatives.—Formation - - - -	208, 209
211, 212. Taylor's Theorem extended. Application - - - -	210-212
213, 214. Osculating Paraboloid, Indicatrix - - - -	213
215. Illustration - - - -	214
216, 217. Curvature. Solid Angles - - - -	215-217
218, 219. Maxima and Minima - - - -	218-221
220. Illustrations - - - -	222-234

CHANGE OF VARIABLES.

221, 222. Use of a Third Independent Variable - - - -	234
223, 224. Reversion. Reciprocants - - - -	235-237
225. Transformation from System to System - - - -	237, 238
226. Change of Independents - - - -	239
227. Jacobians—Extension of notion - - - -	240
228. Derivation through Jacobians - - - -	240
229. Vanishing of Jacobians - - - -	241
230, 231. Converse - - - -	242, 243
232. Illustrations and Exercises - - - -	244-246
233. The Operator ∇^2 - - - -	247
234. The Potential Function - - - -	248
235. Orthogonal Transformation - - - -	248
Exercises - - - -	249, 250

ELIMINATION.

236. Systems of Curves - - - -	251
237. Differential Equations - - - -	251
238, 239. Systems of Rays and Circles - - - -	252
240. Generalization - - - -	253

ARTICLES	PAGES
241. Illustrations and Exercises - - -	254
242. New Functions - - -	255
243. Illustrations and Exercises - - -	255, 256
244, 245. Elimination of Functions - - -	257
246, 247. Functions of Functions - - -	257, 258
248, 249. Euler's Theorems on Homogeneous Functions -	259, 260
250. Relations of Operators - - -	261, 262
Exercises - - -	263, 264

CHAPTER VII.

PARTIAL INTEGRATION.

251, 252. Explanation - - -	265-268
253. Theorem of Mean Value - - -	269
254. Derivation as to Extremes - - -	270, 271
255. Change of Variables - - -	272, 273
256. Generalization - - -	274, 275
257. Geometric Interpretation - - -	276, 277
258, 259. Infinite Integrands - - -	278-280
260. Domain of Integration Extended - - -	281, 282
261. Products of Integrals - - -	283
262. Surface- and Line-Integrals - - -	284-286
263. Exact Differentials - - -	287, 288
264. Triple Integrals - - -	289
265. Space- and Surface-Integrals - - -	290, 291
266. Complanation - - -	292-294
267. Green's Theorem - - -	295, 296
Illustrations and Exercises - - -	297-305

CHAPTER VIII.

PARAMETRIC DERIVATION. DEFINITE INTEGRALS AS
FUNCTIONS.

268. Derivation as to Parameters - - -	306, 307
269. Integration as to Parameters - - -	308
Exercises - - -	309-313
270. The Function Γ or Π - - -	314
271. Fundamental Properties - - -	315-318
272. First Eulerian Integral - - -	319
Exercises - - -	320-323

CHAPTER IX.

CURVE TRACING.

ARTICLES	PAGES
273. General Methods - - - - -	324
274. Arrangement of Terms - - - - -	325
275. Nodes - - - - -	326
276. Plücker's Method - - - - -	327
277. Multiple Points - - - - -	327
278. Guide-Parabolas - - - - -	328-330
279. The Curve at ∞ - - - - -	331, 332
Illustrations and Exercises - - - - -	333-345
 NOTES - - - - -	 346

ERRATA.

Page 27, line 2, for cusp read salient.

Page 29, line 18, for sign read sine.

Page 40, line 11 from below, for $b^2 - \lambda^2$ read $\lambda^2 - b^2$.

Page 44, line 13, for ΔP read Δp .

Page 47, problem 7, read The general curve is the compressed hypocyloid,

$$\left(\frac{x}{a}\right)^{\frac{2}{3}} + \left(\frac{y}{b}\right)^{\frac{2}{3}} = 1.$$

Page 56, line 6 from below, for X read x .

Page 79, line 6, for $\phi'(u)_x dx$ read $\phi'(u) \cdot u_x dx$.

Page 79, line 10 from below, for d_x read dx .

Page 200, line 8, for spaces read space.

Page 237, line 10, for Schwartzian read Schwarzian.

Page 254, line 20, for Schwartzian read Schwarzian.



CHAPTER I.

FUNDAMENTAL NOTIONS AND OPERATIONS.

1. The Notion of Limit: Geometric Illustration.—

Denote by A the area of a circle, by I_n the area of a regular inscribed, and by C_n the area of a regular circumscribed, polygon of n sides; also let n increase without limit, as by continual doubling.

Then we know from elementary geometry:

(a) That A is *constant*—does not change in value.

(b) That I_n and C_n are not constant, but variable, I_n increasing and C_n decreasing as n increases.

(c) That I_n is always less and C_n always greater than A .

(d) That by making n great enough we may *make* the difference $C_n - I_n$, and still more the differences $A - I_n$ and $C_n - A$, *as small as we please*, and may *keep* them so for all greater values of n .

Let the student illustrate by a diagram.

2. **Algebraic Illustration.**—Consider the series, a geometric progression,

$$\frac{1}{2} + \frac{1}{4} + \frac{1}{8} + \frac{1}{16} + \dots + \frac{1}{2^n} + \dots \text{ in infinitum,}$$

and denote by S_n the sum of the first n terms.

Then
$$S_n = 1 - \frac{1}{2^n}.$$

By making n great enough, we may make $\frac{1}{2^n}$ as small as we please, **small at will**, and it will remain so for all following greater values of n ; hence we may bring and keep the *variable* S_n as close as we please to the constant 1.

But no matter how great we make n , we can never make $I_n=A$, nor $C_n=A$, nor $S_n=1$.

3. Definition.—The foregoing examples illustrate a state of case that in some form or other meets us at nearly every turn in higher mathematics both pure and applied: we have to deal, namely, with some varying magnitude, which changes its value according to some law and which may be brought, and may be kept during all succeeding stages of value, as close as we please to some *constant* value, without ever coinciding in value with that constant. In all such cases the **Constant** is called the **Limit** of the **Variable**.

4. It is equally essential that we be able to *bring* and be able to *keep* the variable close at will to the constant. Consider the series

$$\frac{3}{2} - \frac{3}{4} + \frac{9}{8} - \frac{15}{16} + \frac{33}{32} - \frac{63}{64} + \dots,$$

formed by adding $+1$ and -1 alternately to the terms of the progression in Art. 2. If we take an even number of terms, as $2m$, then the $+1$'s and -1 's annul each other in pairs, we have

$$S_{2m} = 1 - \frac{1}{2^{2m}},$$

and by making $2m$ great enough we may bring the variable S_{2m} close at will to the constant 1. But we *cannot keep* S_n close at will during all following stages of its value. For the value of S_{2m+1} is $2 - \frac{1}{2^{2m+1}}$, since in taking an odd number of terms the last $+1$ will not be annulled; and this value cannot be brought close at

will to 1 by enlarging m , though it may be brought close at will to another constant, 2. Accordingly, the general value of the sum S_n of the first n terms is seen to sway back and forth towards 1 and 2, according as n is even or odd. It may be *brought* close at will to either, but it can be *kept* close at will to neither; hence it has neither 1 nor 2 as limit; it has no limit at all.

Exercise.—Show that S_n of the series

$$\frac{3}{2} + \frac{5}{4} - \frac{15}{8} + \frac{17}{16} + \frac{33}{32} - \frac{127}{64} + \dots$$

approaches 1, 2, 3, for $n = 3m, 3m + 1, 3m + 2$.

5. Infinitesimals.—A magnitude small at will, which we may make and keep as small as we please, is often called an **Infinitesimal**. Thence, from Art. 3, *The difference between a variable and its limit is an infinitesimal*. Hence, also, *An infinitesimal is a variable whose limit is 0*.

It is important to observe that the actual value of the infinitesimal at any stage of its variation is a matter of complete indifference. Its essence is found exclusively in the fact that it is *small at will*, that we can make and keep it as small as we please, that its magnitude is wholly in our control.

6. Theorem I.—*Any finite multiple of an infinitesimal is itself an infinitesimal.*

Let σ be any infinitesimal, m any definite number; then $m\sigma$ is a finite multiple of σ , and it will be infinitesimal in case we can make and keep it as small as we please. Let us please to make and keep $m\sigma < \sigma'$, where σ' is infinitesimal; it may be chosen small at will, but we must suppose one such choice already made. We now choose $\sigma < \frac{\sigma'}{m}$: this we can do, since σ' is already chosen and σ is completely at our disposal. Then $m\sigma < \sigma'$; but σ' is small at will, much more than is $m\sigma$ small at will.

7. Theorem II.—*The sum of a finite number of infinitesimals is itself an infinitesimal.*

Let $\Sigma = \sigma_1 + \sigma_2 + \dots + \sigma_n$.

Then we may make and keep each and every one of the σ 's less than a previously chosen σ small at will; hence we may make and keep $\Sigma < n\sigma$; but $n\sigma$ is infinitesimal, much more than is Σ infinitesimal.

N.B.—The restriction that n be *finite* is important; if n increase indefinitely, neither $n\sigma$ nor Σ will in general remain infinitesimal.

8. Theorem III.—*If two variables, V and V' differ by an infinitesimal only, and one of them (V) have a limit L , then the other has the same limit.*

For we have $V - L = \sigma$, and $V' - V = \sigma'$, whence

$$V' - L = \sigma + \sigma',$$

that is, V' differs from L by an infinitesimal; hence L is the limit of V' .

Corollary.—If V and V' be always equal, and L be the limit of V , then L is also the limit of V' .

9. Theorem IV.—*The limit of the sum of a finite number of variables is the sum of their limits.*

Let v_1, v_2, \dots, v_n be the variables, l_1, l_2, \dots, l_n their limits. Then

$$v_1 = l_1 + \sigma_1, \quad v_2 = l_2 + \sigma_2, \quad \dots, \quad v_n = l_n + \sigma_n;$$

$$v_1 + v_2 + \dots + v_n = l_1 + l_2 + \dots + l_n + \sigma_1 + \sigma_2 + \dots + \sigma_n.$$

That is, the sum of the limits differs from the sum of the variables by an infinitesimal; hence the theorem.

Corollary.—The limit of the difference of two variables is the difference of their limits.

10. Theorem V.—*The limit of the product of a finite number of variables is the product of their limits, those limits being finite.*

For we have

$$v_1 v_2 \dots v_n = (l_1 + \sigma_1)(l_2 + \sigma_2) \dots (l_n + \sigma_n) \\ = l_1 l_2 \dots l_n + \text{a finite number of terms,}$$

each containing an infinitesimal factor. Each of these terms is infinitesimal, and so is their sum; hence $v_1 v_2 \dots v_n$ differs from $l_1 l_2 \dots l_n$ by an infinitesimal, hence the theorem.

11. Theorem VI.—*The limit of the quotient of two variables is the quotient of their limits, the limit of the divisor being finite.*

For we have

$$\frac{v_1}{v_2} = \frac{l_1 + \sigma_1}{l_2 + \sigma_2} = \frac{l_1}{l_2} - \frac{\frac{l_1 \sigma_2 - \sigma_1}{l_2}}{l_2 + \sigma_2},$$

the quotient of the v 's differs from the quotient of the l 's by an infinitesimal; hence the theorem.

N.B.—Observe the importance of the condition *finite* in these theorems, and how they fail on its removal. For instance, if a fixed length a be divided into n equal parts, for n increasing at will the length of each part is small at will, is infinitesimal; nevertheless, the sum of these n infinitesimals is not infinitesimal, but is a .

FUNCTIONS, DIFFERENCES, DERIVATIVES.

12. Definition.—*Two magnitudes so related that to values of the one correspond values of the other are called **Functions** of each other.*

Such are a number and its logarithm, or sine, or cosine; a circle's length or area and its radius; a sphere's surface and its volume; the volume of a given mass of gas and its tension; the elasticity of a medium and the velocity of undulation through it, and so on. In fact, we may

almost say that all scientific research is the study of functional relations. Knowing one of the magnitudes we may either calculate the other by some rule or formula, as in mathematics, or we may observe it, as in physics. That one of the two magnitudes to which we assign arbitrary values in order then to calculate or observe the corresponding values of the other is called the **Argument**, while the other is called the **function**. Note carefully that this distinction of argument and function is purely subjective, depending on our arbitrary choice, which itself follows convenience; objectively, each magnitude is alike a function of the other. The terms *independent variable* and *dependent variable* are often used instead of argument and function.

13. Notation and Classification.—The mathematical expression of functional relations between (say) x and y is

$$f(x, y) = 0, \quad F(x, y) = 0, \quad \phi(x, y) = 0, \text{ etc.}$$

(read, f -, or F -, or ϕ -function of x and y equals 0). Then f , F , ϕ are not symbols of magnitude, but of operation, indicating that when a certain set of operations is performed on x and y the result is 0 for all pairs of corresponding values of x and y . When these operations consist of a *finite* number of fundamental algebraical processes, namely, addition, subtraction, multiplication, division, involution, evolution, the function is said to be **algebraic**; otherwise, it is said to be **transcendental**. Thus

$$f(x, y) = x^3 - 3axy + y^3 \quad \text{and} \quad x^{\frac{2}{3}} + y^{\frac{2}{3}} - a^{\frac{2}{3}} = \phi(x, y),$$

are algebraic functions of x and y ; but

$$y \equiv \sin x = x - \frac{x^3}{3} + \frac{x^5}{5} - \frac{x^7}{7} + \dots$$

is a transcendental function of x , since no finite number of such operations as $\frac{x^n}{n}$ will produce the sine of x .

In the equation

$$f(x, y) = 0,$$

unsolved as to both x and y , each is said to be an **implicit** function of the other; but in

$$y = \sin x,$$

solved as to y , this latter is said to be an **explicit** function of x .

When to one value of the one variable there corresponds only one value of the other, this latter is called a **one-valued** or **unique** function of the former; but when to one value of the one variable there correspond more values than one of the other variable, this latter is called a **many-valued** function of the former. Thus in

$$y = sx + b,$$

y is an explicit one-valued function x , while x is an implicit one-valued function of y . In

$$x^3 - 3axy + y^3 = 0,$$

x and y are implicit three-valued functions of each other.

In $y^2 = 4qx$,

x is a one-valued, y is a two-valued function. In

$$y = \cos x,$$

y is an explicit one-valued function of x , while x is an implicit infinitely many-valued function of y .

Though we may not be able to solve the equation between x and y , yet we may always suppose it solved as to either.

Exercise.—Describe the functional relation between x and y in the following Equations:

$$xy = c^2; \quad x^2 \pm y^2 = a^2; \quad kx^2 + 2hxy + jy^2 + 2gx + 2fy + c = 0;$$

$$ay = e^{\frac{x}{a}} + e^{-\frac{x}{a}}; \quad y^{\frac{2}{3}} + x^{\frac{2}{3}} = a^{\frac{2}{3}}; \quad x = a(\theta - \sin \theta), \quad y = a(1 - \cos \theta).$$

14. Correspondences.—Pairs of corresponding values of x and y may be indicated by subscripts or accents. Thus

$(x_1, y_1), (x', y')$. Likewise $x_1 - x_2, y_1 - y_2$ and $x' - x, y' - y$ are pairs of corresponding **differences**, or changes in value of x and y . It is convenient to designate all such differences by the symbols $\Delta x, \Delta y$; also the letters h and k are much used for the same purpose. Subscripts may be attached to these symbols where there is need of greater precision, as is rarely the case.

15. Continuity.—If a be any special value of x , then the range of value from $a - h$ to $a + h'$ (where h and h' are positive, but at present not further defined) may be called the **neighbourhood** or **vicinity** of the value a . When h and h' are *small at will*, the neighbourhood may be called **immediate**.

When x may assume any value in the neighbourhood of a , it is said to be **continuous** in that neighbourhood.

When $y = f(x)$ and we can make and keep Δy small at will by making and keeping Δx small at will, that is, when to infinitesimal Δx there corresponds infinitesimal Δy , then y is called a **continuous** function of x .

It often happens that y is continuous for certain ranges of value of x , but *discontinuous* in the immediate vicinity of certain *critical* values of x . Thus, in $y = \tan x$, y is continuous in general; we have, in fact,

$$\Delta y = \tan(x + \Delta x) - \tan x = \frac{\{1 + (\tan x)^2\} \tan \Delta x}{1 - \tan x \tan \Delta x},$$

As long as x is finitely different from $\pm \pi/2$, $\tan x$ is finite, and we can make and keep the fraction (or Δy) small at will by making and keeping Δx small enough. But such is no longer the case as x nears $\pm \pi/2$ indefinitely; for then $\tan x$ increases (positively or negatively) beyond all limit, and as x passes through the value $\pi/2$, or as x changes by Δx (however small Δx may be) from

$$\pi/2 - \frac{\Delta x}{2} \text{ to } \pi/2 + \frac{\Delta x}{2},$$

$\tan x$ leaps from a very great positive value to an equal negative one, so that Δy , far from being small at will, is really made great at will by making Δx small at will. Hence the values $x = \pm(2n+1)\pi/2$ are **points of discontinuity** for the *tangent of x* .

Exercise.—Show that

$$y \equiv f(x) \equiv c \cdot \frac{\frac{1}{e^{x-a}} - 1}{\frac{1}{e^{x-a}} + 1}$$

is discontinuous for $x = a$.

16. Difference-Quotient.—Manifestly, in the study of functional dependence, the question how the changes in value of the one variable are related to the changes in value of the other variable must be of prime importance; manifestly also, a natural way to investigate the relation of these changes would be to study their quotient,—the argument-change, which is entirely under our control, being the divisor. Accordingly, let us examine the **Difference-Quotient**, $\frac{\Delta y}{\Delta x}$.

17. Illustrations.—A very few examples will suffice to teach us that the expression for this quotient is not in general simple, but very complex. In the case of y a linear function of x , $y = sx + b$, let us increase any value of x by Δx ; thus the corresponding value of y is increased by Δy , and

$$y + \Delta y = s(x + \Delta x) + b,$$

whence, on subtracting $y = sx + b$, we obtain

$$\Delta y = s\Delta x, \quad \frac{\Delta y}{\Delta x} = s.$$

Here indeed the relation is simple enough: Δy is obtained from Δx by multiplying by s . The geometric illustration needs no explanation.

18. But now consider the simple relation $y = x^2$. Δx and Δy being corresponding differences,

$$y + \Delta y = (x + \Delta x)^2 = x^2 + 2x \cdot \Delta x + \overline{\Delta x}^2$$

whence $\Delta y = 2x \cdot \Delta x + \overline{\Delta x}^2$,

and $\frac{\Delta y}{\Delta x} = 2x + \Delta x$.

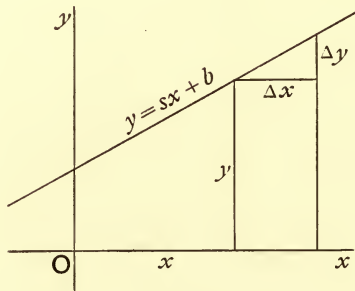

FIG. 1.

Similarly, for $y = x^3$, we obtain

$$\frac{\Delta y}{\Delta x} = 3x^2 + 3x \cdot \Delta x + \overline{\Delta x}^2;$$

while in the case $y = \tan x$ we have

$$\frac{\Delta y}{\Delta x} = \frac{(1 + \overline{\tan x}^2) \tan \Delta x}{(1 - \tan x \tan \Delta x) \Delta x}$$

When such complexity obtains in simple cases, it seems superfluous to examine complicated ones.

19. Derivatives.—However, it is a fact of observation, to be verified at every step of our progress, that the *Difference-Quotient*, no matter how unwieldy, in general breaks up into two parts: the one, independent of Δx , constant with respect to Δx ; the other, dependent on Δx , vanishing with Δx .

The event will show that the first part, the *independent constant* part, is of supreme importance, and accordingly

we give it a special name; we call it **The Derivative of y as to x** . Symbolically,

$$\frac{\Delta y}{\Delta x} = C(\Delta x) + V(\Delta x),$$

and we name $C(\Delta x)$ *Derivative of y as to x* .

20. Symbolism.—Of course we need a symbol as well as a name for this magnitude, such as

$$y_x, y', \dot{y}, D_x y, \frac{dy}{dx}.$$

We shall use all of these as quite equivalent, but not quite indifferently. The second, y' , is very convenient, but only when there can be no uncertainty as to the argument derivation; thus, when $y = f(x)$, y' or $f'(x)$ will uniformly denote the *derivative with respect to x* . The third, \dot{y} , is especially used when the argument of derivation is the *time*, as in Mechanics, where $\dot{y} = y_t =$ derivative of y as to t . The fourth, $D_x y$, or simply Dy where the argument of derivation is well understood, is the most convenient in general discussions, where the symbol D of derivation is used as an *operator* subject to certain laws of operation. The fifth, $\frac{dy}{dx}$, is the most common of all and is full of suggestion; unfortunately, being written in the *form* of a fraction, it is liable to be mistaken by the beginner for a fraction; a fraction, however, it is *not*, though in certain operations it obeys certain laws of fractions. In the main, and especially at first, the symbol y_x seems preferable.

21. Derivative as Limit.—Whenever the *Difference-Quotient*, $\frac{\Delta y}{\Delta x}$, falls into the two parts mentioned in Art. 19, then it is plainly a *variable* magnitude, changing its value as Δx changes, the values of x and y being regarded as fixed. Moreover this variable, varying with Δx , differs from a certain magnitude constant with respect to Δx by

a magnitude small at will, by an infinitesimal that vanishes with Δx . Hence by definition this constant with respect to Δx , this **Derivative** of y as to x , is **The Limit of the Difference-Quotient** for Δx vanishing—a new and most important definition of Derivative.

22. Differential Coefficients.—In accordance with this definition it would seem most natural to call this Limit not Derivative, but **Differential-Quotient**, and the less appropriate name *Differential coefficient* is, indeed, the one in general use. However, there is a distinction. It may happen, and, in fact, does happen, that the Limit of the Difference-Quotient may be perfectly definite for Δx positive and for Δx negative, but *not the same* for both cases; accordingly, we may have a *progressive* Differential-Quotient and a wholly different *regressive* Differential-Quotient, but *not* a Derivative. Only when the progressive is the same as the regressive Differential-Quotient is their common value named the Derivative (Art. 31).

23. Starting from this conception of the Derivative as the Limit of the Difference-Quotient, we may now establish certain useful propositions:

Theorem VII.—*The Derivative of the sum of a finite number of functions of an argument equals the sum of the Derivatives of the functions.*

Let $u = \phi(x)$, $v = \psi(x)$, etc., be the functions of x , and

$$y = f(x) = u + v + \dots$$

Let Δx , Δy , Δu , Δv , etc., be corresponding changes in x , y , u , v , etc., so that

$$y = f(x), \quad y + \Delta y = f(x + \Delta x), \quad \Delta y = f(x + \Delta x) - f(x), \text{ etc.},$$

then $y + \Delta y = u + \Delta u + v + \Delta v + \dots$

$$\Delta y = \Delta u + \Delta v + \text{ etc.},$$

$$\frac{\Delta y}{\Delta x} = \frac{\Delta u}{\Delta x} + \frac{\Delta v}{\Delta x} + \text{ etc.}$$

Since the limit of the sum is the sum of the limits,

$$y_x = u_x + v_x + \text{etc.}$$

Corollary.—If $y = u - v$, then $y_x = u_x - v_x$.

24. Theorem VIII.—*The Derivative of the product of two functions of the same argument equals the sum of the Derivatives of each factor multiplied by the other.*

Let $y = uv$, where u and v are functions of x , and let Δx , Δy , Δu , Δv be corresponding changes. Then

$$y + \Delta y = (u + \Delta u)(v + \Delta v) = uv + u \cdot \Delta v + v \cdot \Delta u + \Delta u \cdot \Delta v.$$

$$\Delta y = \Delta u \cdot v + u \cdot \Delta v + \Delta u \cdot \Delta v.$$

$$\frac{\Delta y}{\Delta x} = \frac{\Delta u}{\Delta x} \cdot v + u \cdot \frac{\Delta v}{\Delta x} + \frac{\Delta u \cdot \Delta v}{\Delta x}.$$

If either $\frac{\Delta u}{\Delta x}$ or $\frac{\Delta v}{\Delta x}$ has a finite limit, then $\frac{\Delta u \cdot \Delta v}{\Delta x}$ is a finite multiple of an infinitesimal, hence is itself infinitesimal; hence on taking limits

$$y_x = u_x \cdot v + u \cdot v_x.$$

Corollary.—If $y = uv \cdot w$, put $uv = z$; then

$$y_x = z_x w + z w_x = u_x v w + u v_x w + u v w_x,$$

and the proof may thus easily be extended to any number of factors.

We may write the result conveniently thus:

$$y = uvw, \quad y_x = uvw \left(\frac{u_x}{u} + \frac{v_x}{v} + \frac{w_x}{w} \right).$$

25. Theorem IX.—*The Derivative of a fraction equals the quotient of the Derivative of the numerator multiplied by the denominator, less the numerator multiplied by the Derivative of the denominator, divided by the squared denominator.*

Let $y = \frac{u}{v}$; then $vy = u$; whence $v_x y + v y_x = u_x$; whence

$$y_x = \frac{u_x v - u v_x}{v^2},$$

26. Theorem X.—If y be mediately a function of x , i.e., if $y = \phi(u)$ and $u = \psi(x)$, so that $y = f(x)$ through u , then the Derivative of y as to x equals the product of the Derivatives of y as to u and u as to x .

Let Δx , Δy , Δu be corresponding differences, then we have identically

$$\frac{\Delta y}{\Delta x} = \frac{\Delta y}{\Delta u} \cdot \frac{\Delta u}{\Delta x};$$

whence

$$y_x = y_u \cdot u_x.$$

Corollary.—Similarly in case of several media, as when

$$y = \phi(u), \quad u = \psi(v), \quad v = F(w), \quad w = f(x),$$

$$y_x = y_u \cdot u_v \cdot v_w \cdot w_x.$$

Mediate Derivation is exceedingly useful.

27. Theorem XI.—The Derivatives of y as to x and x as to y are reciprocal.

For, identically,

$$\frac{\Delta y}{\Delta x} \cdot \frac{\Delta x}{\Delta y} = 1,$$

whence, on taking limits,

$$y_x \cdot x_y = 1, \quad x_y = \frac{1}{y_x},$$

since plainly the constant 1, like every other constant, is its own limit.

28. Theorem XII.—An additive constant disappears in Derivation.

Let $y = u + c$, where c is constant as to x , then

$$y + \Delta y = u + \Delta u + c,$$

$$\Delta y = \Delta u, \quad \frac{\Delta y}{\Delta x} = \frac{\Delta u}{\Delta x}, \quad y_x = u_x.$$

This fact is sometimes expressed by saying that the Derivative of a constant is zero. By constant is uniformly meant a constant as to the argument of derivation.

29. Theorem XIII.—A multiplicative constant is unaffected by Derivation.

Let $y=cu$, where c is constant as to x , then

$$y + \Delta y = c(u + \Delta u),$$

$$\Delta y = c\Delta u, \quad \frac{\Delta y}{\Delta x} = c \frac{\Delta u}{\Delta x}, \quad y_x = cu_x.$$

Derivation interpreted Geometrically and Mechanically.

30. Geometrical Illustration.—Before proceeding, as we are now prepared to do, to the actual derivation of functions, it may be well to illustrate the purely analytic process in more than one way, in order to convince the beginner more fully both of its fundamental importance and of its perfect intelligibility.

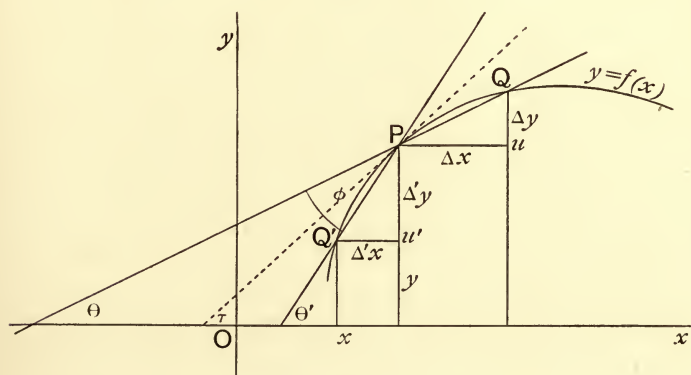

FIG. 2.

Let $y=f(x)$; then from Coordinate Geometry we know that this algebraic relation may, *in general*, be depicted geometrically by a curve whose *equation* is $y=f(x)$. Let P be any *ordinary* point of this curve, Q and Q' any two neighbouring points with P between them. Draw secants PQ and PQ' , making angles θ and θ' with $+x$ -axis. Let the coordinates of P be x, y ; of Q be $x + \Delta x, y + \Delta y$; of

Q' be $x + \Delta x'$, $y + \Delta y'$. Then in the triangles PUQ , $PU'Q'$, we have

$$\frac{\Delta y}{\Delta x} = \tan \theta, \quad \frac{\Delta' y}{\Delta' x} = \tan \theta'.$$

If now, by taking Q and Q' ever closer to P , we can *make and keep* (for all still closer approaches of Q and Q' to P) *the angle ϕ between the secants PQ and PQ' small at will*, then the secants tend to fall together as Q and Q' close down on P , and the fixed position to which both PQ and PQ' may be brought and kept close at will is called the *limiting position* of each, and a right line in that position is called **the tangent to the curve at P** . When such is the case the angles θ and θ' tend towards a common limiting value, which we shall uniformly denote by τ , while $\tan \theta$ and $\tan \theta'$ tend also toward a common limit $\tan \tau$, and since $\frac{\Delta y}{\Delta x}$, $\frac{\Delta' y}{\Delta' x}$ are always equal to $\tan \theta$, $\tan \theta'$ respectively, we have

$$\text{limit of } \frac{\Delta y}{\Delta x} = \tan \tau = \text{limit } \frac{\Delta' y}{\Delta' x}.$$

Now the common limit of these Difference-Quotients is by definition the Derivative of y as to x ; hence

$$y_x = \tan \tau;$$

i.e., the Derivative as to x of a function of x (for some special value of x) equals the tangent of the angle made with x -axis by the tangent, to the curve depicting the function in rectangular coordinates, at the point corresponding to the value of x .

31. Exceptional Cases.—It is essential to the foregoing definition of tangent that the secants through Q and Q' from P between Q and Q' should tend to coincidence as Q and Q' near P . Sometimes such is not the case, but PQ and PQ' tend to *different* limiting positions PT and PT' as Q and Q' near P , or indeed to no definite position

at all. Then the notion of **the tangent** at P fails; we may speak of tangent *up to* P and of tangent on from P but not of *the tangent at* P . But then the notion of Derivative fails also; there may be a Progressive Differential-Quotient (the limit of $\frac{\Delta y}{\Delta x}$) and a Regressive Differential-Quotient (the limit of $\frac{\Delta' y}{\Delta' x}$), but not a Derivative (for that value of x).

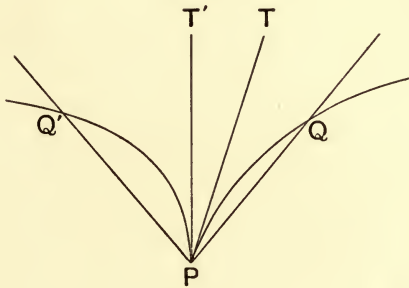

FIG. 3.

Observe likewise that when ϕ , which equals $\theta - \theta'$, is made and kept small at will, then the fluctuation in value of each angle, θ and θ' , is made and kept small at will. For the positions of Q and Q' , or, what is tantamount, the values of θ and θ' , are entirely independent of each other, so that any change in the value of either might produce an equal change in the value of their difference; hence the change in the value of either becomes small at will when the change in the value of their difference becomes small at will; *i.e.*, geometrically, each secant settles down toward a definite position and both secants toward the same position.

32. Problem of Tangents.—It is thus manifest that the problem of deriving a function is in general the analytic equivalent of the geometric problem of finding the tangent to a curve at a given point of the curve: *the problem of*

Derivation is geometrically interpreted *the problem of tangents*. If now we ask for the *Equation* of the tangent to the curve $y=f(x)$ at the point (x, y) the answer is

$$v - y = y_x(u - x),$$

where u and v are the current coordinates of a point on the tangent referred to the same rectangular axes, OX and OY . For this is the equation of a right line through (x, y) and having the proper slope to the x -axis as determined by y_x .

Exercise.—If ω be the angle between oblique axes, show that $y_x = \sin x / \sin(\omega - x)$.

33. Illustration from Mechanics.—In order to interpret the Derivative mechanically, let s be the *space* (of one dimension) or path traversed by the body (conceived as a point) during the *time* t ; also, let Δs be traversed in Δt , *i.e.*, let Δs and Δt be corresponding differences in s and t . Let us form the difference-quotient $\frac{\Delta s}{\Delta t}$. According to the most familiar notions it is the *average speed* (or velocity) during the time Δt . If the motion was uniform, then the body actually traversed Δs at this speed; if, however, the motion was not uniform but varied, then it is not certain that the body actually had this speed for any finite time however small, nevertheless this quotient is still by universal consent the *average speed*. If we make Δt and therewith Δs ever smaller and smaller, the quotient remains always the *average speed*, but it will in general vary in value as Δt varies, whatever be the law of the motion. If there *exists* any law connecting the space and the time, whether or not we know what it is, in other words, if the *space* be a *function* of the *time*, then in general this difference-quotient will break up into two parts, the one independent of Δt , the other vanishing with Δt . The first part is analytically what we have met with

repeatedly, namely, a *Derivative*, the derivative of the space as to the time; it is the *limit of the average speed* in the immediate neighbourhood of the instant t (i.e., the *end* of t and the *beginning* of Δt). Mechanically, however, this limit is not itself an average speed at all, it is not of the same nature as the variable difference-quotient $\frac{\Delta s}{\Delta t}$

For this quotient *never* assumes this limiting value, no matter how small Δt be made. And this is quite what we should expect and what the nature of the case demands. For motion implies duration, however small, of time, and change, however small, of place. When there is no lapse of time and no displacement there is no motion, and hence no speed (or velocity). In all strictness, there can be *no motion at an instant* and hence *no speed* (or velocity) at an instant. The concept of speed (or velocity) or motion will not combine with the concept of instant (or point of time) to form a compound concept. Nevertheless, it is an established and unchangeable usage to speak of *velocity at an instant* or *instantaneous velocity*. These expressions have in themselves no meaning, but we may (overlooking the inconsistency set forth above) *assign* them a meaning, namely, *the limit of the average velocity in the immediate neighbourhood of the instant*.

34. Of course, the question remains, is the game worth the candle? is this limit of such natural intrinsic importance for mechanics as to warrant us in giving it this name and lifting it into this prominence? This question cannot be answered *a priori*, in advance, but only *a posteriori*, from the event. We shall see at proper time and place that our justification is complete.

35. **Further Considerations.**—It is sometimes, indeed generally, said that the *velocity at an instant* is the (measure of the) space that *would have been traversed* in the next unit of time *if the velocity at the instant*

had remained constant during that unit. This definition is doubtless useful for certain purposes, but it has little logical value; for it manifestly defines the thing in terms of itself. It may with more propriety be said that the *instantaneous velocity*, whatever it be, characterizes the *state* of the body at each instant, but not the *action* of the body, in its passage from one state to another. We may accordingly assume two axes: one horizontal as time-axis, the other vertical as speed-axis, and laying off vertically ordinates to represent the speed at each instant we form by their ends the useful *curve of velocity* (or speed); or by means of radii vectores drawn from a fixed point, of length varying as the instantaneous speed, and parallel to the tangents to the path of the body, we may form another important curve, the *hodograph*, the radius vector to any point of which depicts geometrically the corresponding instantaneous velocity. In case of some actual motions we might have such a curve described by appropriate tachymetric mechanism. But the fact remains that the Derivative of the space as to the time, this limit of the average velocity, characterizes not the action but the state of the body, and is itself *not* a velocity though everywhere named so. In like manner the circle is not a regular polygon, though it is the limit of both in- and ex-polygons; the tangent is not (in general) a secant, though the limit of two sets of secants; and in general the limit, as a constant, is essentially different from the variable whose limit it is.

36. Lastly, it is conceivable, though perhaps not actual, that in case of impact with or without rebound, there should be sudden change, discontinuity, in the varying average velocity. Thus the notion of *instantaneous velocity* of impact would fail for the point in question. There would be and we might define instantaneous

velocity *up to and on from*, but not *at* the instant of impact, which corresponds precisely to the analytic phenomenon of progressive as well as regressive differential-coefficient, in the absence of Derivative proper.

ELEMENTARY DERIVATIONS.

37. Derivation of Rational Powers.—Leaving these subtleties, which the student must not be discouraged at not quite mastering on first reading, we proceed to derive the ordinary functions.

1. Let $y = x^n$, n being a positive integer.

$$y + \Delta y = (x + \Delta x)^n = x^n + nx^{n-1}\Delta x + \{\Delta x^2\},$$

where $\{\Delta x^2\}$ means terms involving at least the second power of Δx . Hence

$$\frac{\Delta y}{\Delta x} = nx^{n-1} + \{\Delta x\}; \quad \therefore y_x = (x^n)_x = nx^{n-1}.$$

If n were not a positive integer the $\{ \}$ would not consist of a finite number of infinitesimals, and we could not affirm its vanishing without more ado.

We might also have regarded x^n as the product of n equal factors, each x , and have applied Art. 24, remembering that the derivative of x as to x is 1.

2. Let $y = x^{\frac{p}{q}}$, where p and q are positive integers.

$y^q = x^p$; whence by mediate derivation

$$qy^{q-1}y_x = px^{p-1}, \quad y_x = \frac{p}{q}x^{\frac{p}{q}-1}.$$

3. Let $y = x^{-n} = \frac{1}{x^n}$, where n is rational.

By Art. 25, $y_x = -\frac{n}{x^{n+1}} = -nx^{-n-1}$.

We may obtain the same result by deriving $yx^n = 1$. So for all *rational* values of n we have the rule: to

derive x^n , multiply by the exponent and then reduce the exponent by 1.

For n irrational, see Art. 40.

38. Derivation of the Exponential.—Let $y = e^x$.

We assume, as known from Algebra, that

$$e^x = 1 + x + \frac{x^2}{2} + \frac{x^3}{3} + \dots + \frac{x^n}{n} + \dots = \sum_{n=0}^{\infty} \frac{x^n}{n!},$$

a series absolutely convergent for all finite values of x .

We have then

$$y + \Delta y = e^{x+\Delta x} = e^x \cdot e^{\Delta x} = e^x \left(1 + \Delta x + \frac{\overline{\Delta x^2}}{2} + \frac{\overline{\Delta x^3}}{3} + \dots \right),$$

$$\frac{\Delta y}{\Delta x} = e^x + e^x \left\{ \frac{\Delta x}{2} + \frac{\overline{\Delta x^2}}{3} + \dots \right\}.$$

Comparing the series in $\{ \}$ with the series for $e^{\Delta x} - 1$, namely, $\Delta x + \frac{\overline{\Delta x^2}}{2} + \frac{\overline{\Delta x^3}}{3} + \dots$, we find it less, term by term, throughout; but for Δx vanishing $e^{\Delta x} - 1$ converges upon 0 as limit; much more, then, is 0 the limit of $\{ \}$ for $\Delta x = 0$. Hence,

$$y_x = (e^x)_x = e^x,$$

a result of extraordinary simplicity and importance. By actually deriving the series for e^x term by term we see that it actually reproduces itself, but we are not authorized to derive an infinite series by deriving its terms separately.

Corollary.— $(e^u)_x = e^u \cdot u_x$; i.e., the derivative of an exponential = the exponential \times the derivative of the exponent.

Thus

$$(e^{ax})_x = a \cdot e^{ax}, \quad e^{x^2} = 2x \cdot e^{x^2}.$$

Also, $a^x = (e^{\log a})^x = e^{x \log a}$; hence $(a^x)_x = a^x \cdot \log a$.

39. Derivative of the Logarithm.—Let $y = \log x$, where \log means natural logarithm. Then $e^y = x$; whence $e^y \cdot y_x = 1$,

or
$$y_x = (\log x)_x = \frac{1}{x}.$$

The logarithm of x in any other system differs from the natural logarithm only by the modulus M , as a factor; hence M will appear in the Derivative as a multiplier. But other logarithms are seldom used.

Corollary.— $(\log u)_x = \frac{1}{u} \cdot u_x = \frac{u_x}{u}$; hence to derive the logarithm of a function, *derive the function and divide the result by the function.*

40. Derivative of Powers.—Let $y = x^n$, n being any constant as to x .

$$\text{Then} \quad \log y = n \log x, \quad \frac{y_x}{y} = \frac{n}{x},$$

$$y_x = (x^n)_x = nx^{n-1},$$

the complete generalization of Art. 37.

Special Cases.— $(\sqrt{x})_x = \frac{1}{2\sqrt{x}}$, $(\sqrt{u})_x = \frac{u_x}{2\sqrt{u}}$;

i.e., To derive the 2nd root of a function, *derive the radicand and divide by twice the radical.*

$$\left(\frac{1}{x}\right)_x = -\frac{1}{x^2}, \quad \left(\frac{1}{u}\right)_x = -\frac{u_x}{u^2}, \quad \{f(x)\}_x^n = n\{f(x)\}^{n-1}f'(x).$$

41. Derivatives of sine and cosine.—We pass over now to trigonometric functions, all of which depend on the *sine*.

Let $y = \sin x$; $y + \Delta y = \sin(x + \Delta x)$,

$$\Delta y = \sin(x + \Delta x) - \sin x = 2 \cos\left(x + \frac{\Delta x}{2}\right) \sin \frac{\Delta x}{2}.$$

$$\frac{\Delta y}{\Delta x} = \cos\left(x + \frac{\Delta x}{2}\right) \cdot \frac{\sin \frac{\Delta x}{2}}{\frac{\Delta x}{2}}.$$

From Trigonometry we know that the limit of the ratio of an infinitesimal angle to its sine is 1, and the limit of $\cos\left(x + \frac{\Delta x}{2}\right)$ is plainly $\cos x$; hence

$$y_x = (\sin x)_x = \cos x.$$

Corollary.— $(\sin u)_x = (\cos u) \cdot u_x$;

$$(\cos x)_x = \left(\sin \left(\frac{\pi}{2} - x \right) \right)_x = -\sin x.$$

42. Geometric Proof.—This fundamental relation may also be deduced geometrically, thus:

Let $AOP = x$, take the radius OP as 1; then the metric numbers of angle and corresponding arc are the same, so that AP is also the arc x , while CP represents the sine and OC the cosine of x ; *i.e.*, the metric numbers of CP and OC are the metric numbers of sine and cosine of x . Now, change x by $\Delta x = POQ$ or $= PQ$. Draw PD parallel and QD normal to OA , also the chord PQ . Then as Δx is

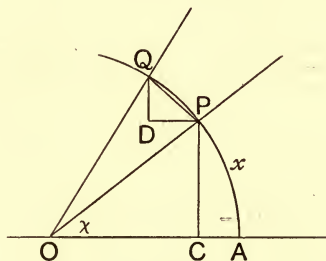

FIG. 4.

taken ever smaller and smaller, the chord PQ turns about P and tends to become normal to OP , the angle OPQ may be brought and kept close at will to a right angle. Hence the triangle PQD tends to become similar to POC , its angles differ only infinitesimally from those of POC . Hence we have the rigorously exact, *not* merely approximate, relation:

$$\text{Limit of } \frac{QD}{PQ} = \frac{OC}{OP}.$$

Moreover, we have the fundamental assumption:

$$\text{Limit of } \frac{\text{chord } PQ}{\text{arc } PQ} = 1;$$

also $QD = \Delta y = \Delta(\sin x)$, $\text{arc } PQ = \Delta x$, $\frac{OC}{OP} = \cos x$;

$$\text{Lim. } \frac{\Delta y}{\Delta x} = \text{Lim.} \left(\frac{QD}{\text{chord } PQ} \cdot \frac{\text{chord } PQ}{\text{arc } PQ} \right) = \frac{OC}{OP};$$

hence $y_x = (\sin x)_x = \cos x$.

Quite similarly, from the figure,

$$(\cos x)_x = -\sin x.$$

Analytically,

$$(\cos x)_x = \left\{ \sin \left(\frac{\pi}{2} - x \right) \right\}_x = \cos \left(\frac{\pi}{2} - x \right) (-1) = -\sin x.$$

Or thus,

$$\overline{\sin x^2} + \overline{\cos x^2} = 1, \quad 2 \sin x \cos x + 2 \cos x (\cos x)_x = 0,$$

$$(\cos x)_x = -\sin x.$$

43. Ratio of Chord and Arc.—The assumption in the foregoing proofs is so important as to call for special elucidation.

Let Q and Q' be two points of a curve C , and P a point between them. Draw tangents at Q and Q' , and let these points approach P . Then this state of case will

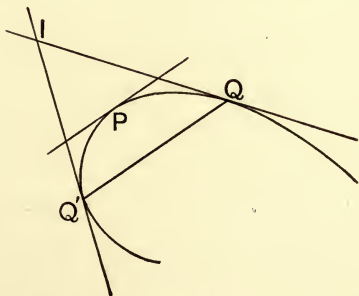

FIG. 5.

in general present itself: by taking Q and Q' close at will to P we may exclude all flexures from the arc QQ' , so that the tangent QI will turn only one way in turning round the arc into the position $Q'I$; also by approaching

Q and Q' to P we may make and keep (during all nearer approaches of Q and Q') the angle QIQ' close at will to a straight angle π . When this is the case, the triangle QIQ' tends to flatten out into a doubly laid tract QQ' ; meanwhile it always encloses the arc QQ' and the relation holds constantly:

$$QI + IQ' > \text{arc } QQ' > \text{chord } QQ'.$$

But $\text{Limit of } \frac{QI + IQ'}{\text{chord } QQ'} = 1;^*$

hence $\text{Limit of } \frac{\text{arc } QQ'}{\text{chord } QQ'} = 1.$

In such a case we may say the curve is *elementally straight* in the immediate neighbourhood of P . By this phrase we mean that if we cut out an ever smaller and smaller piece of the curve, always including P , and magnify

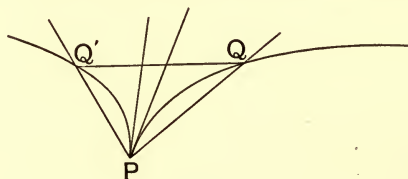

FIG. 6.

it to a constant apparent size, as with a microscope, then the smaller the piece cut out the straighter (or less curved) it will look. Such would *not* be the case if the curve

* In fact, if $a, b, c, \alpha, \beta, \gamma$ be the sides and opposite angles of the triangle QPQ' , then

$$\frac{a}{\sin \alpha} = \frac{b}{\sin \beta} = \frac{c}{\sin \gamma},$$

$$\begin{aligned} \therefore L \frac{a+b}{c} &= L \frac{\sin \alpha + \sin \beta}{\sin \gamma} \\ &= L \frac{2 \sin \frac{\alpha + \beta}{2} \cdot \cos \frac{\alpha - \beta}{2}}{\sin \gamma} = L \frac{2 \sin \frac{\pi - \gamma}{2} \cdot \cos \frac{\alpha - \beta}{2}}{2 \sin \frac{\gamma}{2} \cdot \cos \frac{\gamma}{2}} = L \frac{\cos \frac{\alpha - \beta}{2}}{\sin \frac{\gamma}{2}} = 1, \end{aligned}$$

for $\alpha = \beta = 0, \gamma = \pi$.

flexed itself indefinitely often in the vicinity of P , nor if P were a cusp (as in the figure), when the chord and tangents would tend to a definite triangular shape under the microscope.

44. The substitution of the chord for the arc, Δc for Δx , illustrates a very common artifice justified by the following important

Theorem XIV.—*The limit of the ratio of two variables, u and v , is the same as the limit of the ratio of two other variables, u' and v' , when the limits of the ratios of u to u' and v to v' are each 1.*

For we have identically,

$$\frac{u}{v} = \frac{u}{u'} \cdot \frac{u'}{v'} \cdot \frac{v'}{v}, \quad \text{and} \quad L \frac{u}{u'} = 1 = L \frac{v'}{v};$$

hence
$$\text{Lim. } \frac{u}{v} = \text{Lim. } \frac{u'}{v'}.$$

Observe the analogy with mediate derivation.

45. Other Modes of Proof.—We may avoid all geometric considerations by defining sine and cosine through imaginary exponentials, thus:

$$e^{ix} = \cos x + i \sin x, \quad e^{-ix} = \cos x - i \sin x;$$

$$\text{whence} \quad 2 \cos x = e^{ix} + e^{-ix}, \quad 2i \sin x = e^{ix} - e^{-ix}.$$

Deriving, we have at once

$$(\sin x)_x = \cos x, \quad (\cos x)_x = -\sin x.$$

The same results are reached, free from all geometric reference or dependence, by deriving the series for sine and cosine term by term:

$$\sin x = x - \frac{x^3}{\underline{3}} + \frac{x^5}{\underline{5}} - + \dots, \quad \cos x = 1 - \frac{x^2}{\underline{2}} + \frac{x^4}{\underline{4}} - + \dots$$

This process is admissible as applied to these series—a fact, however, not yet established.

46. Other Trigonometric Functions.—Since all the other trigonometric functions are expressible through sine and cosine, the student will find no trouble in deducing these results :

$$(\tan x)_x = 1/\overline{\cos x^2} = \overline{\sec x^2} = 1 + \overline{\tan x^2}.$$

$$(\cot x)_x = -1/(\overline{\sin x^2}) = -\overline{\csc x^2} = -(1 + \overline{\cot x^2}).$$

$$(\sec x)_x = \sin x/\overline{\cos x^2} = \sin x \overline{\sec x^2} = \sec x \cdot \tan x.$$

$$(\csc x)_x = -\cos x/\overline{\sin x^2} = -\cos x \cdot \overline{\csc x^2} = -\csc x \cdot \cot x.$$

47. Sense of the Derivative.—The signs of the foregoing Derivatives are noteworthy. When the difference-quotient $\frac{\Delta y}{\Delta x}$ is positive, and therefore when its limit, the Derivative y_x , is positive—for *unless* the limit be 0 it manifestly determines the sign of the whole expression $\frac{\Delta y}{\Delta x}$ —the meaning is that for Δx and Δy small enough *they both have the same sign*, are both +, or both -; *i.e.*, for y_x positive, the function y and its argument x increase or decrease *together*— y is then called an *increasing* function of x . Such are sine and tangent in first quadrant. But if y_x be negative it means that Δx and Δy , small enough, have *unlike signs*; as the argument increases the function decreases and is hence called a *decreasing* function of the argument. Such are cosine and cotangent in first quadrant.

INVERSE FUNCTIONS.

48. Definition.—When $y=f(x)$, then x must equal some function of y , say $x=\phi(y)$. These functions, f and ϕ , are then said to be *inverse functions* or *anti-functions* of one another. The sign of inversion is the negative index, -1, superscribed to the functional symbol. Thus

$$f = \phi^{-1}, \quad \phi = f^{-1},$$

so that $x = f^{-1}(y)$ and $y = \phi^{-1}(x)$.

We can pass at once from the inverse to the direct function. Thus, if

$$y = F^{-1}(x), \quad \text{then} \quad F(y) = x.$$

The logarithm and the exponential form a very important pair of inverse functions. Thus, if

$$y = \log x, \quad \text{then} \quad e^y = x,$$

and if $y = e^x$, then $\log y = x$.

49. Derivation of Inverse Functions.—We can always derive the anti-function when we can derive the function.

For let $y = f^{-1}(x)$, then $f(y) = x$,

whence $f'(y)y_x = 1$, $y_x = \{f^{-1}(x)\}_x = \frac{1}{f'(y)}$.

We may then in general express $f'(y)$ through x . Thus, let $y = \sin^{-1}x$, then $y_x = 1/\cos y$, or

$$\{\sin^{-1}(x)\}_x = 1/\sqrt{1-x^2}.$$

As to the sign of the $\sqrt{\quad}$, it is geometrically evident that angle and sign increase together in 4th and 1st quadrants, but not in 2nd and 3rd; hence the $\sqrt{\quad}$ is + for

$$-\pi/2 < y < \pi/2, \quad - \text{ for } \pi/2 < y < 3\pi/2.$$

Similarly, let the student show that

$$(\cos^{-1}x)_x = \frac{1}{\sqrt{1-x^2}}, \quad \{\tan^{-1}x\}_x = \frac{1}{1+x^2}, \quad (\sec^{-1}x)_x = \frac{1}{x\sqrt{x^2-1}}.$$

Continental mathematicians write *arcsin x* (read *arc whose sine is x*) instead of $\sin^{-1}x$ (read *anti-sine (of) x*), but the latter is both more convenient and more logical. Inverses of unique functions are not generally unique.

EXERCISES.

Derive the following expressions as to x :

- $x^0, x, x^2, x^3, x^7, x^{-9}, c/x, c/x^2, a/x^5, x^{\frac{3}{2}}, x^{-\frac{1}{2}}, b/x^{\frac{5}{3}}$.
- $\sqrt{1 \pm x^2}, \sqrt{a^2 \pm x^2}, \sqrt{x^2 \pm a^2}, \sqrt{a + 2bx + cx^2}, \sqrt[3]{x^3 + 3px^2 + 3qx + r}$.
N.B.— $\{\sqrt{1 \pm x^2}\}_x = \pm 2x/2\sqrt{1 \pm x^2} = \pm x/\sqrt{1 \pm x^2}$.
- $(a^2 - x^2)^{\frac{3}{2}}, (a^3 - x^3)^{\frac{4}{3}}, (ax^2 + 2bx + c)^{\frac{5}{3}},$
 $(ax^4 + 4bx^3 + 6cx^2 + 4dx + e)^{\frac{7}{3}}$.

By mediate derivation, first as to (), then as to x , we get

$$\{(a^2 - x^2)^{\frac{3}{2}}\}_x = \frac{3}{2}(a^2 - x^2)^{\frac{1}{2}}(-2x) = -3x\sqrt{a^2 - x^2}.$$

- $\frac{1+x}{\sqrt{1-x^2}}, \frac{x}{\sqrt{1 \pm x^2}}, \frac{\sqrt{1 \pm x}}{\sqrt{1 \mp x}}, \frac{\sqrt{a \pm \sqrt{x}}}{\sqrt{a \mp \sqrt{x}}}, \frac{\sqrt[4]{1 \pm x}}{\sqrt[4]{1 \mp x}},$
 $\left\{ \frac{ax^2 + 2bx + c}{a'x^2 + 2b'x + c'} \right\}^{\frac{1}{2}}$.
- $x(a^2 + x^2)\sqrt{a^2 - x^2}, \frac{\sqrt{1 \pm x^2} \pm \sqrt{x}}{\sqrt{1 \mp x^2}}, \left\{ \frac{1 \pm x\sqrt{2} + x^2}{1 \mp x\sqrt{2} + x^2} \right\}^{\frac{1}{2}}, \frac{\sqrt{1 \pm x^2} \pm x}{\sqrt{1 \pm x^2 \mp x}},$
 $\frac{\sqrt{1+x} \pm \sqrt{1-x}}{\sqrt{1+x} \mp \sqrt{1-x}}, x \pm \sqrt{x^2 - a^2}, (a^2 + x^2)^{\frac{1}{2}}/(a+x)^{\frac{1}{2}}, (ax^p + bx^q)^r.$

By logarithmic derivation we have for the first,

$$y_x = y \left(\frac{1}{x} + \frac{2x}{a^2 + x^2} - \frac{x}{a^2 - x^2} \right)$$

$$= (a^2 + 3x^2)\sqrt{a^2 - x^2} - \frac{x^2(a^2 + x^2)}{\sqrt{a^2 - x^2}} = \frac{a^4 + a^2x^2 - 4x^4}{\sqrt{a^2 - x^2}}.$$

- $\log \frac{1+x+x^2}{1-x+x^2}, \log \sqrt{\frac{a \pm x}{a \mp x}}, \log \frac{\sqrt{a^2 \pm x^2} + x}{\sqrt{a^2 \pm x^2} - x}, \log \frac{\sqrt{a+x} + \sqrt{a-x}}{\sqrt{a+x} - \sqrt{a-x}},$
 $\log(\log x),$
 $\{\log(x + \sqrt{x^2 - a^2})\}_x = \left\{ 1 + \frac{x}{\sqrt{x^2 - a^2}} \right\} / (x + \sqrt{x^2 - a^2}) = 1/\sqrt{x^2 - a^2}.$

- $y = e^{ax^2 + 2bx + c}, e^{a \cos x + b \sin x}, \log \left\{ \frac{a \cos x \mp b \sin x}{a \cos x \pm b \sin x} \right\}^{\frac{1}{2}}, e^{\tan mx},$
 $e^{ax} \sin px, e^{ax} (\sin px)^n, e^{ax} (\cos px)^n, e^{ax} \tan qx.$

For the first, $y_x = e^{ax^2 + 2bx + c} (2ax + 2b).$

$$8. y = \sin(ax^2), \quad u = \sin^{-1}\frac{x}{a}, \quad v = \tan^{-1}\frac{x}{a}, \quad \sin(mx + a), \quad \sin mx \cos nx, \\ (\sin mx)^p, \quad (\cos nx)^q, \quad (a \overline{\sin x^2} + b \overline{\cos x^2})^m, \quad \sqrt{\sin x}, \quad \sin \sqrt{x}, \\ \sqrt{\tan \sqrt{x}}. \quad y_x = 2ax \cos(ax^2), \quad u_x = 1/\sqrt{a^2 - x^2}, \quad v_x = a/(a^2 + x^2).$$

$$9. \sec^{-1}\frac{x}{a}, \quad \tan^{-1}x/\sqrt{a^2 - x^2}, \quad \sin^{-1}\frac{a^2 \pm x^2}{a^2 \mp x^2}, \quad \cos^{-1}\frac{3 + 5 \cos x}{5 + 3 \cos x}, \\ \tan^{-1}\left(\frac{x}{a} \tan^{-1}\frac{x}{a}\right). \quad y = \sec^{-1}\frac{x}{a}, \quad \sec y = \frac{x}{a}, \quad \cos y = \frac{a}{x}, \\ \sin y \cdot y_x = \frac{a}{x^2}, \quad y_x = \frac{a}{x^2 \sin y} = \frac{a}{x\sqrt{x^2 - a^2}}.$$

We may also write off this result immediately.

$$10. \log \sin^{-1}x, \quad \log \cos^{-1}x, \quad \log \tan^{-1}x, \quad \sin(\log x), \quad \log(\sin x), \\ \cos^{-1}(\log \tan x), \quad \sin^{-1}(1 - 2x^2), \\ \frac{1}{\sqrt{b^2 - a^2}} \log \frac{\sqrt{b+a} + \sqrt{b-a} \tan \frac{x}{2}}{\sqrt{b+a} - \sqrt{b-a} \tan \frac{x}{2}}.$$

$$D \log \sin^{-1}x = 1/\{\sqrt{1-x^2} \cdot \sin^{-1}x\}.$$

$$11. x^x, \quad e^{x^x}, \quad x^{x^x}, \quad \tan^{-1}\sqrt{(1 \pm x)/(1 \mp x)}, \quad \log^n x = \log \log \dots \log x, \quad x^y, \\ (\sin x)^{\cos x} + (\cos x)^{\sin x}, \quad \left(1 + \frac{1}{x}\right)^x + x^{(1+\frac{1}{x})}, \quad (\tan^{-1}x)^{\frac{1}{x}}, \\ \cos^{-1}(x\sqrt{1-x} - \sqrt{x-x^3}). \quad y = x^x, \quad \log y = x \log x, \\ y_x = x^x \{\log x + 1\}.$$

$$12. a^x, \quad \sin x \cos x \sqrt{1 - e^2(\sin x)^2}, \quad \log \frac{x^2 + ax \pm \sqrt{(x^2 + ax)^2 \mp bx}}{x^2 + ax \mp \sqrt{(x^2 + ax)^2 \pm bx}}.$$

$$13. \text{ If } ax^2 + 2hxy + by^2 + 2gx + 2fy + c = 0, \text{ find } y_x.$$

Here x and y are *implicit* functions of one another, but no new difficulty presents itself. We derive straightforward term by term, and then solve for y_x . Thus:

$$2ax + 2hy + 2hxy_x + 2byy_x + 2g + 2fy_x = 0,$$

$$\text{whence } y_x = -(ax + hy + g)/(hx + by + f).$$

$$14. \text{ Find } y_x \text{ when } x^m y^n = (x+y)^{m+n}, \quad (\sin x)^y = (\cos y)^x,$$

$$x^3 - 3axy + y^3 = 0, \quad x\sqrt{1+y} + y\sqrt{1+x} = 0, \quad \tan \log x = \frac{y-x^2}{x^2}.$$

15. If $y = \phi(t)$ and $x = \psi(t)$, prove that $y_x = \phi'(t)/\psi'(t)$.
16. If u and v be functions of x , prove that $u_v = u_x/v_x$.
17. Derive $x^{\frac{m}{n}}$ as to x^n , $\tan^{-1} \frac{2x}{1-x^2}$ as to $\sin^{-1} \frac{2x}{1+x^2}$, $x^{\sin x}$ as to $\log x$.
18. If $y = \sqrt{\tan x + \sqrt{\tan x + \sqrt{\tan x + \dots}}}$, prove
- $$x_y = (2y - 1)\overline{\cos x^2}.$$
19. Derive the sum S_n of n terms of a G.P. as to the ratio r .
20. From

$$\sin x = \sin(x+a)\sin(x+2a) \dots \sin(x+\overline{n-1}a) = (\sin nx)/2^{n-1},$$

where $na = \pi$, prove that

$$\cot x + \cot(x+a) + \dots + \cot(x+\overline{n-1}a) = n \cot nx,$$

$$\overline{\csc x^2} + \overline{\csc(x+a)^2} + \dots + \overline{\csc(x+\overline{n-1}a)^2} = n^2 \overline{\csc nx^2}.$$

APPLICATIONS TO GEOMETRY.

50. Tangent and Normal.—We shall now illustrate further the exceeding importance of the Derivative in problems involving tangency.

The **Eq. of the Tangent** to $y=f(x)$ at (x, y) is

$$v - y = y_x(u - x),$$

where u and v are the current coordinates. Hence the **Eq. of the Normal** is

$$y_x(v - y) + (u - x) = 0,$$

obtained by putting $-x_y$, instead of y_x .

Deduce the corresponding eqs. for oblique axes.

51. Subtangent, etc.—Now let the tangent at $P(x, y)$ to the graph of $y=f(x)$ cut the axes at T and U , and let the normal cut them at N and Q ; also let S be the projection of P on x -axis. Then plainly

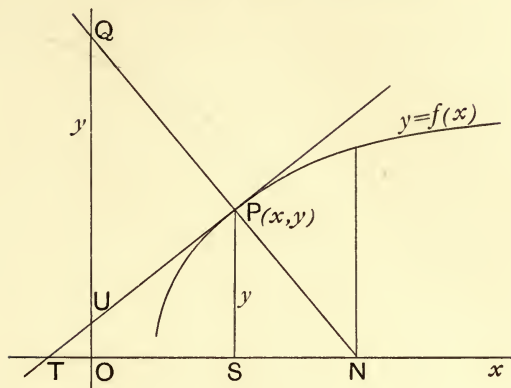

FIG. 7.

$$ST = \text{Subtangent} = y/y_x = y \cdot x_y,$$

$$SN = \text{Subnormal} = y \cdot y_x,$$

$$PT = \text{Tangent length} = y\sqrt{1+x_y^2},$$

$$PN = \text{Normal length} = y\sqrt{1+y_x^2},$$

$$OT = \text{Tangent intercept on } X\text{-axis} = x - y/y_x,$$

$$OU = \text{Tangent intercept on } Y\text{-axis} = y - x \cdot y_x = -OT \cdot y_x.$$

52. Derivative of the Arc.—It is common to denote by s the length of a curve, reckoned from some point appropriately chosen. Evidently, then, this s is a function of both x and y , and may be derived as to either. Let x be reckoned up to the point $P(x, y)$, and let $\Delta x = PD$, $\Delta y = DQ$, $\Delta s = \text{arc } PQ$ be corresponding changes in x, y, s ; also let $\Delta c = \text{chord } PQ$. Then

$$\overline{\Delta c}^2 = \overline{\Delta x}^2 + \overline{\Delta y}^2, \quad \frac{\Delta s}{\Delta x} = \frac{\Delta s}{\Delta c} \cdot \frac{\Delta c}{\Delta x}.$$

Now

$$\text{Lim. } \frac{\Delta s}{\Delta c} = 1, \quad \text{Lim. } \frac{\Delta c}{\Delta x} = \text{Lim. } \sqrt{1 + \left(\frac{\Delta y}{\Delta x}\right)^2} = \sqrt{1 + y_x^2} = c_x.$$

Hence, in general, $s_x = \sqrt{1 + y_x^2} = \sec \tau$.

S. A.

C

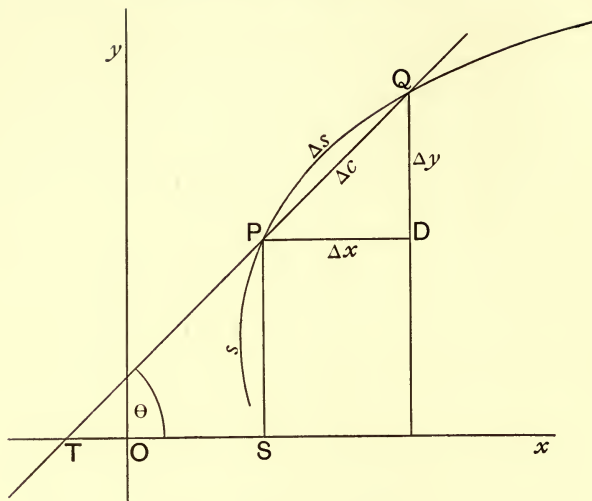

FIG. 8.

Hence

$$x_s = \cos \tau = 1/\sqrt{1+y_x^2},$$

and, similarly,

$$y_s = \sqrt{1+x_y^2}, \quad y_s = y_x/\sqrt{1+y_x^2} = \sin \tau.$$

53. In **Polar Coordinates** let S be the pole, Sx the polar axis, $P(r, \theta)$ any point on the graph of $f(r, \theta)=0$, τ as before, ϕ the *radial angle* of the radius vector r with the tangent at P ; let Δr , $\Delta \theta$, Δs be corresponding changes in r , θ , s , and $\Delta c = \text{chord } PQ$ as before; also let a *perpendicular to r through S* meet tangent and normal at T and N . Then, much as before,

$ST = \text{polar subtangent}, \quad SN = \text{polar subnormal},$

$PT = \text{polar tangent length}, \quad PN = \text{polar normal length}.$

About S describe the circle-arc PD , and draw the half-chord PD' perpendicular to SD . Then

$$\overline{\Delta c}^2 = \overline{D'Q}^2 + \overline{PD}^2,$$

$$\text{Lim. } \frac{\Delta s}{\Delta c} = 1, \quad \text{and} \quad \text{Lim. } \frac{PD'}{\text{arc } PD} = 1,$$

as we know.

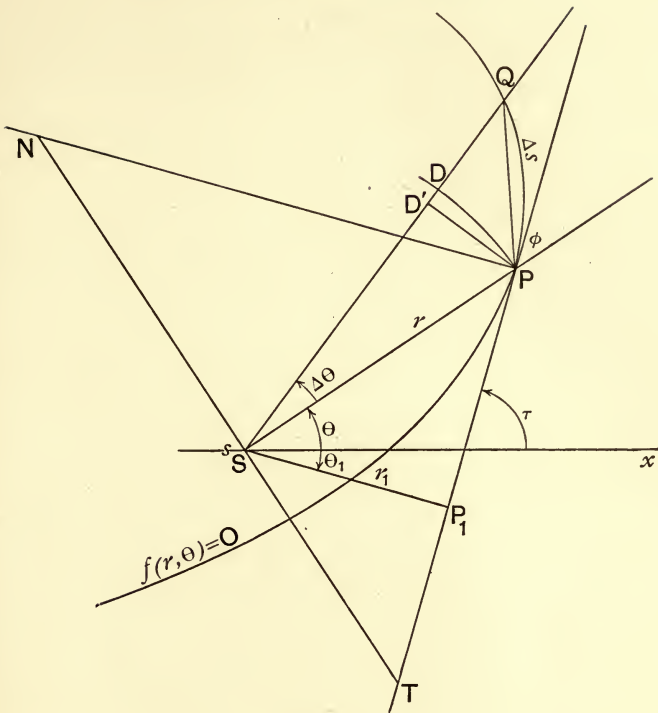

FIG. 9.

Furthermore,

$$\begin{aligned} DQ &= D'Q - D'D = D'Q - PD' \tan D'PD \\ &= D'Q - D'Q \cdot \tan SQP \cdot \tan D'PD. \end{aligned}$$

Hence

$$\text{Lim. } \frac{DQ}{D'Q} = \text{Lim. } (1 - \tan SQP \cdot \tan D'PD) = 1.$$

Hence, applying theorem Art. 43 to each side of the triangle PQD' and remembering that

$$DQ = \Delta r, \quad PD = r \Delta \theta,$$

we get

$$\text{Lim. } \left(\frac{\Delta s}{\Delta r} \right)^2 = \text{Lim. } \left(1 + \frac{r^2 \Delta \theta^2}{\Delta r^2} \right),$$

or

$$\frac{ds}{dr} = s_r = \sqrt{1 + r^2 \theta_r^2}.$$

54. Infinitesimals of Higher Order.—In passing we have here established the very important fact that the limit of the ratio, intercept on radius between chord and arc divided by chord, is zero; or

$$\text{Lim. } \frac{DD'}{PD'} = 0.$$

This fact is commonly expressed by saying that DD' is *infinitesimal of second order* with respect to PD' taken as infinitesimal of first order.

No obscurity need attach in the student's mind to the nature of these infinitesimals of higher order. Consider the three fractions $\frac{1}{n}, \frac{1}{n^2}, \frac{1}{n^3}$. If n be in our power to make as great as we will, then each of these fractions is in our power to make small at will, *each is infinitesimal*. As n increases each approaches 0, not, however, in the same way, but through very different series of values; *e.g.*, if n increase through the series of natural numbers, the fractions pass through these series of values:

$$\begin{array}{ccccccc} 1, & \frac{1}{2}, & \frac{1}{3}, & \frac{1}{4}, & \dots\dots & \frac{1}{10}, & \dots\dots \\ 1, & \frac{1}{4}, & \frac{1}{9}, & \frac{1}{16}, & \dots\dots & \frac{1}{100}, & \dots\dots \\ 1, & \frac{1}{8}, & \frac{1}{27}, & \frac{1}{64}, & \dots\dots & \frac{1}{1000}, & \dots\dots \end{array}$$

Always the ratio of the second fraction to the first is $\frac{1}{n}$, and of the third to the second is $\frac{1}{n}$ and of third to first is $\frac{1}{n^2}$. *These ratios are themselves* small at will, infinitesimal; in fact, there is in the first fraction only one factor small at will, $\frac{1}{n}$; but in the second there are two, $\frac{1}{n}$ and $\frac{1}{n}$, while in the third there are three, $\frac{1}{n}$ and $\frac{1}{n}$ and $\frac{1}{n}$, hence the names, *infinitesimals of first, second, third order*. Clearly the same reasoning may be extended to infinitesimals of any order. In the foregoing illus-

tration the factors are equal, but this circumstance is entirely unessential. In the case of DD' the *two* factors small at will are $D'Q$ and $\tan D'PD$; the removal of the first leaves the second still present, and therewith the quotient still infinitesimal, hence DD' is of second order.

55. Additional Formulae.—The other relations follow now without difficulty:

$$\text{L. } \angle PQD = \phi, \quad \text{L. } \tan PQD = \text{L. } \frac{PD'}{QD'} = \text{L. } \frac{PD}{QD} = \text{L. } \frac{r\Delta\theta}{\Delta r};$$

hence
$$\tan \phi = r\theta_r = r \frac{d\theta}{dr}.$$

Similarly
$$\sin \phi = r\theta_s, \quad \cos \phi = r_s.$$

In the right triangle TPN , since $SP = r$ is perpendicular to TN and $\angle N = \phi$, we have

$$ST = SP \tan SPT = r \tan \phi = r^2 \theta_r = r^2 \frac{d\theta}{dr},$$

$$SN = SP \cot SNP = r \cot \phi = r_s = \frac{dr}{d\theta},$$

$$PT = SP / \cos SPT = r / \cos \phi = r / r_s = r \frac{ds}{dr},$$

$$PN = SP / \sin SNP = r / \sin \phi = 1 / \theta_s = \frac{ds}{d\theta}.$$

If $SP_1 = p$ be the perpendicular from the origin on the tangent PT , and $\frac{1}{r} = u$ —a common and convenient substitution—then we have

$$ST = -\theta_u = -\frac{d\theta^*}{du}, \quad PP_1 = SP \cos \phi = r \frac{dr}{ds}.$$

Exercise.—Prove

$$p = r \sin \phi = r^2 \frac{d\theta}{ds}, \quad \frac{1}{p^2} = u^2 + \left(\frac{du}{d\theta}\right)^2.$$

* For

$$\frac{du}{d\theta} = u_r \cdot \frac{dr}{d\theta} = -\frac{1}{r^2} \cdot \frac{dr}{d\theta};$$

hence

$$\frac{d\theta}{du} = -r^2 \frac{d\theta}{dr} = -ST.$$

56. Angle between two Curves.—The angle between two intersecting curves at their point of intersection may be defined as the angle between their tangents at that point, which may be either of two supplemental angles. To find this angle, first find the point of intersection, then the value of y_x for each curve at that point, say y' and y'' , then tangent of angle between curves

$$= (y' - y'') / (1 + y'y''),$$

by Addition-theorem of tangent.

57. Pedal Curves: Definition.—As P traces the original curve C , the foot P_1 of the perpendicular p (or r_1), from the origin on the tangent will also trace a curve C_1 , called the **(First Positive) Pedal** of C with respect to the origin S . C_1 will itself have a F.P.P. with respect to S , which we write C_2 , and which is the **Second P.P.** of C with respect to S . Consistently, C is called the **First Negative Pedal** of C_1 and the **Second N.P.** of C_2 , while C_1 is the F.N.P. of C_2 , all with respect to S . Clearly this notation may be extended to any degree, and with respect not simply to S , but to any point in the plane.

58. Equations.—To find the Eq. of C_1 , we must express the coordinates (x_1, y_1) or (r_1, θ_1) of P_1 through the coordinates (x, y) or (r, θ) of P , in two eqs.; from these eqs. and the eq. of C , $f(x, y) = 0$, or $\phi(r, \theta) = 0$, we must then eliminate the coordinates of P , (x, y) or (r, θ) ; the result, or so-called *eliminant*, will be the eq. of C_1 , a relation holding between the coordinates, (x_1, y_1) or (r_1, θ_1) , of P_1 in every possible position of P . We remark in passing that

$$\theta_1 = xSP_1 = -\tau + \pi/2 \text{ or } \tau - \pi/2.$$

59. Pedal Equations.—It often happens that the relation between the radii vectores r and r_1 (or p as it is commonly called) of C and C_1 is very simple. This relation is called

the **Pedal Equation** of C and is especially useful in mechanics.

Illustrations.—1. The eq. of the ellipse is $\frac{x^2}{a^2} + \frac{y^2}{b^2} = 1$;
the tangent at (x, y) is $\frac{ux}{a^2} + \frac{vy}{b^2} = 1$; hence

$$p = r_1 = a^2 b^2 / \sqrt{a^4 y^2 + b^4 x^2}, * \quad \text{or} \quad \frac{x^2}{a^4} + \frac{y^2}{b^4} = \frac{1}{p^2};$$

also $x^2 + y^2 = r^2$; hence

$$a^2 b^2 + p^2 r^2 = (a^2 + b^2) p^2,$$

the pedal eq. sought.

2. Let $r^n = a^n \sin(n\theta)$. By deriving, $\frac{n}{r} \cdot r_\theta = n \cot(n\theta)$;
hence $\cot \phi = \cot(n\theta)$, $\phi = n\theta$. Also

$$p = r \sin \phi = r \sin(n\theta) = r \cdot \frac{r^n}{a^n};$$

hence $p = \frac{r^{n+1}}{a^n}$, the pedal eq. sought.

EXERCISES.

1. Discuss the common Apollonian parabola, $y^2 = 4qx$.

$$y_x = 2q/y = y/2x;$$

hence $ST = 2x$, $SN = 2q$; *i.e.*, The subtangent is bisected by the vertex (origin), the subnormal is a constant, the half-parameter. Find lengths of tangent and normal.

2. Discuss the logarithmic spiral, $r = a^\theta$. $r_\theta = a^\theta \cdot \log a = r \log a$;
 $\tan \phi = r/r_\theta = 1/\log a$, a constant, whence the name equi-angular spiral given to this curve. The student may continue the discussion.

*To get this, reduce $\frac{ux}{a^2} + \frac{vy}{b^2} - 1 = 0$ to the normal form, by dividing by $\sqrt{\frac{x^2}{a^4} + \frac{y^2}{b^4}}$, and put $u = v = 0$.

3. Discuss the logarithmic curve, $x = \log y$. $y_x = y$; hence $ST = y/y_x = 1$, a constant.

4. Discuss the Archimedean and hyperbolic spirals,

$$r = a\theta, \quad r\theta = a.$$

5. Under what angles do $y^2 = 4qx$ and $x^2 = 4qy$ intersect? The real points of intersection are $(0, 0)$ and $(4q, 4q)$. The values of the derivatives are $2q/y$ and $x/2q$. For $(0, 0)$ these values become ∞ and 0 , hence the values of τ are $\pi/2$ and 0 , the difference is $\pi/2$; hence at the origin the curves are perpendicular to each other. At $(4q, 4q)$ the values become $\frac{1}{2}$ and 2 , which are $\tan \tau_1$ and $\tan \tau_2$, hence $\tan(\tau_2 - \tau_1) = \frac{2 - \frac{1}{2}}{1 + 2 \cdot \frac{1}{2}} = \frac{3}{4}$; *i.e.*, the parabolas intersect under an angle whose tangent is $\frac{3}{4}$.

6. Show that in the hypocycloid $x^{\frac{2}{3}} + y^{\frac{2}{3}} = a^{\frac{2}{3}}$, the intercept on the tangent, between the axes, is constant, a .

7. For what values of r do the curves $x^{\frac{3}{2}} + y^{\frac{3}{2}} = a^{\frac{3}{2}}$ and $x^2 + y^2 = r^2$ touch each other? Do they meet at right angles? At what points?

8. Show that the confocal conics

$$\frac{x^2}{a^2} + \frac{y^2}{a^2 - \lambda^2} = 1 \quad \text{and} \quad \frac{x^2}{b^2} - \frac{y^2}{b^2 - \lambda^2} = 1$$

cross at right angles.

9. Prove that the hyperbolas $x^2 - y^2 = a^2$ and $xy = c^2$ cross at right angles.

10. For what value of c does the circle $x^2 + y^2 + 2y = c$ cut the parabola $x^2 = 4y$ orthogonally?

11. How do the parabolas $y^2 = 2ax + a^2$ and $y^2 = -2bx + b^2$ meet, and under what angle?

12. Show that in the catenary $y = \frac{a}{2}(e^{\frac{x}{a}} + e^{-\frac{x}{a}})$ the normal from the foot of the ordinate (S) on the tangent is constant in length.

13. Prove that in the tractrix $x = \sqrt{a^2 - y^2} + \frac{a}{2} \log \frac{a - \sqrt{a^2 - y^2}}{a + \sqrt{a^2 - y^2}}$ the tangent-length PT is constant.
14. In what parabola $y = cx^n$ (i.e., for what value of n) is the triangle bounded by axes and tangent constant in area?
15. In the hypocycloid $x^{\frac{2}{3}} + y^{\frac{2}{3}} = a^{\frac{2}{3}}$ show that the equation of the tangent is $2x \sin a + 2y \cos a = a \sin 2a$, where

$$x = a \overline{\cos a}^3, \quad y = a \overline{\sin a}^3;$$
 also that tangents mutually perpendicular meet on the curve $2r^2 = a^2 \overline{\cos 2\theta}^2$.
16. The F.P.P. of the equiaxal hyperbola $pr = a^2$ is Bernoulli's Lemniscate $r^3 = a^2 p$.
17. Apply the result in (2), Art. 59, to show that the Pedal Equations of Circle, Parabola and Cardioid are

$$pa = r^2, \quad p^2 = ar, \quad \text{and} \quad p^2 a = r^3.$$

ENVELOPES.

60. Pencils and Parameters.—Analytic Geometry has already familiarized the student with the notion of a **family** or **system** of curves, all defined by a single equation. Thus

$$y - y_1 = s(x - x_1)$$

is the eq. of a *pencil*, i.e., of a family of right lines, all passing the same point (x_1, y_1) . For any particular value of the direction-coefficient s , as 1, 2, -3 , we get a particular right line; by letting s range through the complete series of real values from $-\infty$ to $+\infty$, we get the complete system of right lines through (x_1, y_1) . The symbol or arbitrary, by change of which we pass from one member of the family to another, we may call the **parameter** of the family. It is constant for any particular member, but changes from member to member.

Exercise.—What systems are represented by these equations, and what are the parameters :

$$x^2 + y^2 = r^2, \quad y^2 = 2rx - x^2, \quad y = sx + \sqrt{1 + s^2}, \quad y = sx + \frac{q}{s},$$

$$y = sx + \sqrt{a^2 \pm s^2 b^2}, \quad x^2 + y^2 - 2gx + c = 0 ?$$

61. Intersection of Elements.—Now let

$$F(x, y; p) = 0 \dots\dots\dots(1)$$

be the eq. of a system of curves, the parameter being p . For any particular value of p we have a particular curve of the system; if we change this particular p into $p + \Delta p$ we get another curve of the system, namely

$$F(x, y; p + \Delta p) = 0 \dots\dots\dots(1')$$

These two curves will intersect, generally in real points, though it may be in imaginary points. By combining (1) and (1') we shall obtain the point (or points) of intersection (x_i, y_i) , though this result would rarely be of interest. In this result we may put $\Delta p = 0$; *i.e.*, we may find the limiting values of x_i and y_i for Δp vanishing; *i.e.*, we may find *the points of intersection of two consecutive curves* of the family. Thus, let $(x - p)^2 + y^2 = r^2$ be the eq. of a family of circles of constant radius r , their centres on the x -axis. Consider p as some particular value of the parameter, then this is the eq. of a particular member of the family and the equation of any other member will be

$$(x - p - \Delta p)^2 + y^2 = r^2.$$

Hence
$$(x - p)^2 - (x - p - \Delta p)^2 = 0,$$

or
$$(x - p + x - p - \Delta p)(x - p - x + p + \Delta p) = 0,$$

whence
$$x = p + \frac{\Delta p}{2},$$

a result evident from purely geometric considerations. For $\Delta p = 0$, $x = p$; *i.e.*, *two consecutive circles of the family intersect at the ends of a diameter normal to the centre-line.*

62. Intersection of Consecutives.—But instead of finding the points of intersection, whether of two consecutive or of two non-consecutive members, we may eliminate p between their eqs. (1) and (1'), and thus obtain a relation connecting x and y for *all* values of p . Then x and y will be x_i and y_i , since in eliminating p we tacitly assume that x and y are the same in the two eqs. Let the result of this elimination be $\phi(x_i, y_i; \Delta p) = 0$. This is the eq. of the locus of all points of intersection of pairs of curves of the family whose parameters differ by Δp . In this eq. put $\Delta p = 0$; the result, $\phi(x_i, y_i; 0) = 0$, is the eq. of the locus of the intersection of *consecutive* curves of the family. Thus in the preceding example on eliminating p we get

$$y = \pm \sqrt{r^2 - \left(\frac{\Delta p}{2}\right)^2},$$

i.e., the circles whose centres are Δp apart, intersect on two parallels to the x -axis distant from it $\sqrt{r^2 - \left(\frac{\Delta p}{2}\right)^2}$. On putting $\Delta p = 0$, we get $y = \pm r$ as locus of the intersections of pairs of consecutives. Both these results are geometrically evident. Draw the figure.

63. Envelopes.—The locus of the intersection of consecutives is particularly important because *the tangent to it at any point is in general tangent to the con-*

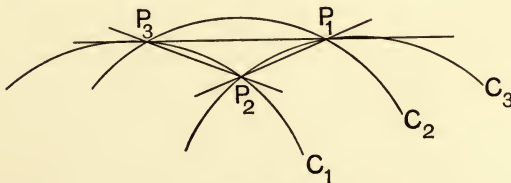

FIG. 10.

secutives intersecting at that point. In fact, consider three curves of the family, C_1, C_2, C_3 , corresponding to the parameters $p - \Delta p, p, p + \Delta p$; let C_2 and C_3 intersect

at P_1, C_3 and C_1 at P_2, C_1 and C_2 at P_3 ; draw the chords P_1P_2, P_2P_3, P_3P_1 . Now let Δp approach 0; then the curves tend to become consecutive, and the chords P_1P_2 and P_2P_3 tend to become tangent to C_3 and C_1 respectively; the points P_1 and P_3 are always on the locus of intersections, P_1P_3 is always a chord of this locus, *this locus tends toward the locus of intersections of consecutives as its limit*, and at the same time P_1, P_3 tend to become consecutive points, so that the chord P_1P_3 tends to become tangent to the locus of intersections of consecutives. If then the curves and this locus really admit of tangents in the neighbourhood of these P 's, the three chords flatten out towards one and the same limiting position as ΔP approaches 0; *i.e.*, the consecutive members have a common tangent with the locus of their intersection at their point of intersection; hence this locus is said to be itself tangent to the consecutives and is called the **envelope** of the family.

64. How to find Envelope.—While the foregoing may elucidate the nature of this locus of intersections of consecutives, the method employed to find its Eq. would generally prove to be excessively awkward. Instead of eliminating p and then taking the limit for Δp approaching 0, we may proceed more simply, thus:

$$F(x, y; p) = 0 \dots \dots \dots (1),$$

$$F(x, y; p + \Delta p) = 0 \dots \dots \dots (1').$$

Hence $F(x, y; p + \Delta p) - F(x, y; p) = 0 \dots \dots \dots (1'')$

hence $\frac{F(x, y; p + \Delta p) - F(x, y; p)}{\Delta p} = 0 \dots \dots \dots (1''')$

This Eq. (1''') we may now use instead of (1'). In it suppose the value of p taken from (1) to be inserted in place of p ; this would merely be *eliminating* p between (1) and (1''')—or, what is tantamount, between (1) and (1'), the thing we set out to do—and then let us take

the limit for Δp approaching 0. So we get as Eq. of the Envelope

$$F\{x, y; p(x, y)\}_p = 0.$$

This however is nothing but the derivative of F as to p , with the value of p taken from (1) substituted for p . Hence, to find the Envelope of $F(x, y; p) = 0$:

Rule.—Derive F as to p and then eliminate p by help of the original Eq.; in other words,

$$\text{Eliminate } p \text{ between } F = 0 \text{ and } F_p = 0.$$

65. Parameters with Conditions.—Often it is the case that there are two or n parameters in the family, but these parameters are then connected by 1 or $n - 1$ Eqs. of condition. Thus if we would find the Envelope of a straight line two fixed points of which slide on two rectangular axes, we have as Eq. of the family $\frac{x}{a} + \frac{y}{b} = 1$, and the parameters a and b are connected by the condition $a^2 + b^2 = d^2$ (d the tract between the fixed points). We may now eliminate one of the parameters, as b , derive as to the other, and then eliminate that other; or we may choose either one, as a , for the parameter, regard the other as a function of it (which is the case), and then proceed to derive both the Eq. of the family and the Eq. of condition as to this one parameter a . So we shall get four Eqs., from which we then eliminate the two parameters, a and b , along with the derivative of a as to b . Thus, in the problem proposed,

$$\frac{x}{a} + \frac{y}{b} - 1 = 0; \quad a^2 + b^2 = d^2.$$

$$\frac{x}{a} + \frac{y}{\sqrt{d^2 - a^2}} - 1 = 0 = F(x, y; a) = 0 \dots\dots\dots(1),$$

$$-\frac{x}{a^2} + \frac{ya}{(d^2 - a^2)^{\frac{3}{2}}} = 0 = F_a \dots\dots\dots(2).$$

Whence
$$\frac{x^2}{a^6} = \frac{y^2}{(d^2 - a^2)^3}, \quad \frac{x^{\frac{2}{3}}}{y^{\frac{2}{3}}} = \frac{a^2}{d^2 - a^2},$$

$$\frac{x^{\frac{2}{3}}}{x^{\frac{2}{3}} + y^{\frac{2}{3}}} = \frac{a^2}{d^2}, \quad a = \frac{dx^{\frac{1}{3}}}{\sqrt{x^{\frac{2}{3}} + y^{\frac{2}{3}}}};$$

and similarly,
$$b = \frac{dy^{\frac{1}{3}}}{\sqrt{x^{\frac{2}{3}} + y^{\frac{2}{3}}}}.$$

On substitution in $\frac{x}{a} + \frac{y}{b} = 1$ we get as Eq. of the Envelope

$$x^{\frac{2}{3}} + y^{\frac{2}{3}} = d^{\frac{2}{3}}.$$

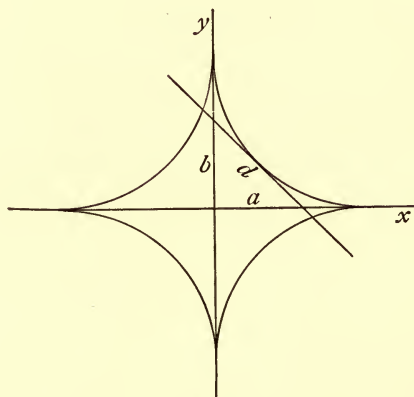

FIG. 11.

Otherwise, thus :

$$\frac{x}{a} + \frac{y}{b} - 1 = 0, \quad a^2 + b^2 = d^2; \quad -\frac{x}{a^2} - \frac{yb'}{b^2} = 0, \quad a + bb' = 0.$$

Here b' is derivative of b as to a , and we must eliminate a , b , b' from these four Eqs.

$$b' = -\frac{x}{y} \cdot \frac{b^2}{a^2}, \quad b' = -\frac{a}{b}; \quad \text{hence } \frac{x^{\frac{2}{3}}}{y^{\frac{2}{3}}} = \frac{a^2}{b^2};$$

hence $a = \frac{dx^{\frac{1}{3}}}{\sqrt{x^{\frac{2}{3}} + y^{\frac{2}{3}}}}$, as before, and the same result follows.

A still more elegant method of eliminating parameters by *undetermined multipliers* must for the present be reserved.

We also reserve the rigorous analytic proof that in general the locus of the intersections of consecutives actually touches every member of the family, and hence is properly named *Envelope*.

EXERCISES.

1. Find the envelope of a system of coaxal ellipses of constant area.

$$\text{Here } F(x, y; a, b) = \frac{x^2}{a^2} + \frac{y^2}{b^2} - 1 = 0, \text{ and } \pi ab = \pi c^2.$$

Hence

$$a^2y^2 + b^2x^2 - c^2 = 0, \quad ay^2 + bb'x^2 = 0, \quad b + ab' = 0;$$

$$a^2y^2 = b^2x^2, \quad 2a^2y^2 = c^2 = 2b^2x^2;$$

hence, $2xy = \pm c^2$, a pair of equiaxal hyperbolas, asymptotic to the axes of the ellipses.

2. Find the envelope of equal circles with centres on a given circle.

3. Find the envelope of the right line $y = sx + \frac{q}{s}$.

4. Through the ends of a given tract ($2a$) are drawn two parallels, and a transversal moves so that the rectangle of the intercepts on the parallels between it and the tract is constant (c^2); show that the envelope of the transversal is $\frac{x^2}{a^2} \pm \frac{y^2}{c^2} = 1$.

5. A moving right line forms with two fixed right lines a triangle of constant area; show that the envelope is an hyperbola asymptotic to the fixed lines.

6. Show that the four-cusped hypocycloid $x^{\frac{2}{3}} + y^{\frac{2}{3}} = c^{\frac{2}{3}}$ is the envelope of coaxal ellipses in which the sum of the axes is constant.

7. Show that the same hypocycloid is the envelope of the join of the projections on the axes of a point of an ellipse.

8. The centre of an ellipse, whose axes are fixed in size and direction, moves on another ellipse whose axes are the same in size and direction; show that the envelope of the moving ellipse is itself an ellipse coaxial with the fixed ellipse and similar.
9. Find the envelope of the polar of a point of an ellipse or hyperbola with respect to a coaxial ellipse or hyperbola.
10. A pair of mutually perpendicular tangents are drawn to an ellipse; show that the envelope of the join of the points of tangency is a confocal ellipse.
11. Show that the envelope of the join of the ends of conjugate diameters of a conic is a similar coaxial conic.
12. U and V are the projections on the x - and y -axis of a point P of the cubical parabola $y = ax^3$; show that the envelope of UV is another cubical parabola

$$27y + 4ax^3 = 0.$$

13. A fountain (*in vacuo*) throws up water in every direction with the same velocity; show that the envelope of all the parabolic jets is a paraboloid of revolution.
14. Show that the envelope of the drops of water flung from the rim of a wheel of radius a revolving with velocity $\sqrt{2gh}$ is a parabola $x^2 - a^2 = 4h(h - y)$.
15. Show that the envelope of the normals to $x^{\frac{2}{3}} + y^{\frac{2}{3}} = a^{\frac{2}{3}}$ is

$$(x + y)^{\frac{2}{3}} + (x - y)^{\frac{2}{3}} = 2a^{\frac{2}{3}}.$$

HIGHER DERIVATIVES.

66. Definition.—The first derivative of a function of x , $y = f(x)$ is in general itself a function of x , and may itself be derived as to x ; the result of this second derivation is called the *second derivative* as to x of the original function $y = f(x)$. Similarly, the derivative of the second

Derivative is called the *third Derivative*, and so on, *the derivative of the n^{th} Derivative being called the $(n+1)^{\text{th}}$ Derivative.*

67. Notation.—Higher Derivatives are denoted in several ways, as:

$$y'', y''', \dots y^{(n)}; y_{2x}, y_{3x}, \dots y_{nx}; \frac{d^2y}{dx^2}, \frac{d^3y}{dx^3}, \dots \frac{d^ny}{dx^n}$$

When the derivation is with regard to the time t , as in Mechanics, we may write \dot{y}, \ddot{y}, \dots

Still another form is often convenient, when we are dealing with derivation as a mere operation obeying certain laws: $Dy, D^2y, D^3y \dots D^ny$; and we speak of the **operator** D . Where any doubt might arise as to the argument of derivation, we may suffix it thus: D_x^2 . The various derivatives of $f(x)$ as to x are

$$f'(x), f''(x), f'''(x), \dots f^{(n)}(x).$$

Where we would denote not merely a derivative but the special value of one corresponding to some special value of the argument of derivation, as for $x=a$, we enclose the special argument value in the parenthesis instead of x . Thus: $f''(a)$ means the value of $f''(x)$ when $x=a$. Note carefully that the substitution of a for x takes place *after* the derivation, *not before*. It would be meaningless or impossible to substitute the constant or special value a for x , and *then* derive as to x . These remarks apply to all derivatives.

68. Formation of Higher Derivatives.—We will now learn to write down n^{th} derivatives immediately, without successive derivation.

1. The derivatives of x^r are in order,

$$rx^{r-1}, r(r-1)x^{r-2}, \dots r_n x^{r-n},$$

where
S. A.

$$r_n = r(r-1) \dots (r-n+1). \\ \text{D}$$

If r be a natural or count number (positive integer), then the n^{th} Derivative vanishes for $n > r$. If r be not natural, then in general no derivative vanishes.

2. The n^{th} Derivative of $(x+a)^r$ is $r_n(x+a)^{r-n}$.

3. The n^{th} Derivative of $\frac{1}{(x+a)}$ is $\frac{(-1)^n n!}{(x+a)^{n+1}}$.

4. The n^{th} Derivative of $\frac{1}{(x+a)^r}$ is $\frac{(-1)^n n! (r-1)!}{(x+a)^{n+r}}$.

5. We see it is easy to form any derivative of a fraction with but one linear factor (which may be repeated) involving x in the denominator. Now any proper rational fraction, as $f(x)/\phi(x)$, where f and ϕ are integral functions, may be decomposed as we learn in Algebra (see Appendix) into a finite number of part fractions of the form $A/(x+a)^r$. It may be that $x+a$ takes the imaginary form $x+u+iv$, but in that case there will also appear in the same degree the **conjugate** factor $x+u-iv$; on combining the n^{th} derivatives of

$$A/(x+u+iv)^r \text{ and } A'/(x+u-iv)^r,$$

the imaginary terms will annul, and we shall obtain a real numerator over the real denominator $(x+u^2+v^2)^{n+r}$.

6. The derivative of **sin** x is **cos** x , which is $\sin(x+\pi/2)$; hence deriving the sine merely increases its argument by the quarter-period, $\pi/2$; hence the n^{th} derivative of **sin** x is **sin** $\left(x+\frac{n\pi}{2}\right)$. Similarly the n^{th} derivative of **cos** x is **cos** $\left(x+\frac{n\pi}{2}\right)$.

7. The first derivative of the logarithm of a rational expression will yield fractions to which apply 4 and 5.

8. The exponential e^{ax} appears as a factor in all its derivatives, but after the first derivation it will generally be most convenient to apply the following **Theorem of Leibnitz for deriving a product**.

69. Theorem XV.—Let $y=uv$; derive it successively as to x .

$$y' = u'v + uv'.$$

$$y'' = u''v + 2u'v' + uv''.$$

$$y''' = u'''v + 3u''v' + 3u'v'' + uv'''.$$

$$y'''' = u''''v + 4u'''v' + 6u''v'' + 4u'v''' + uv''''.$$

We observe that the coefficients are the same as in the expansions of the Binomial $(u+v)$, and that the orders of the derivatives are the same as the degrees of the powers, if we count u and v as *zeroth* derivatives of themselves as to x , which we must do to be consistent. We naturally suspect the same law to hold for all higher derivatives and we easily prove it, thus: Assume

$$y^{(n)} = (uv)^{(n)} = \dots + {}_n C_r u^{(n-r)} v^{(r)} + {}_n C_{r+1} u^{(n-r-1)} v^{(r+1)} + \dots$$

—the Binomial expansion represented by two consecutive typical terms. We now ask what is the coefficient of the typical term containing $u^{(n-r)} v^{(r+1)}$ in the $(n+1)^{\text{th}}$ derivative, $y^{(n+1)} = (uv)^{(n+1)}$? Manifestly, on deriving $y^{(n)}$ only these two typical terms can contribute to the typical term sought; in all preceding terms the derivative of u is already too high, in all succeeding terms the derivative of v is already too high. But each of these terms will yield a contribution: the first on deriving the factor $v^{(r)}$, the second on deriving the factor $u^{(n-r-1)}$; hence the coefficient sought will be ${}_n C_r + {}_n C_{r+1}$ which $= {}_{n+1} C_{r+1}$. Hence, if the law holds for the n^{th} derivative it must hold for the $(n+1)^{\text{th}}$, and so for all; it does hold for the 4^{th} ; hence it holds for the 5^{th} and all higher.

The sum of the orders of derivation is the same for each term; as those of u descend, those of v ascend. We may choose either factor as v , but if either factor of the product be a positive integral power of x that factor should be taken as v , so that the series of terms may clearly be

seen to close with the proper derivative of v . Thus the n^{th} derivative of $x^3 \sin x$ is

$$\begin{aligned} x^3 \sin\left(x + \frac{n\pi}{2}\right) + 3nx^2 \sin\left(x + \frac{(n-1)\pi}{2}\right) \\ + 3n(n-1)x \sin\left(x + \frac{(n-2)\pi}{2}\right) \\ + n(n-1)(n-2) \sin\left(x + \frac{(n-3)\pi}{2}\right) \end{aligned}$$

all the higher derivatives of x^3 vanishing. In general, if x^c be the factor v , there will be $(c+1)$ terms, c being a *count* number, *i.e.*, whole and positive—only such numbers can be counted.

70. Derivatives of e^{ax} .—Denoting derivation by D , we have $De^{ax} = ae^{ax}$, $D^2e^{ax} = a^2e^{ax}$, ..., $D^ne^{ax} = a^ne^{ax}$. So it appears that the operator D before e^{ax} may be supplacd by the multiplier a , and hence, if $\phi(D)$ denotes a rational integral function of D , as $C_0 + C_1D + C_2D^2 + \dots + C_nD^n$, then $\phi(D)e^{ax} = \phi(a)e^{ax}$ —a very important result.

71. Derivatives of $e^{ax}X$.—Now let X be any function of x ; then we have

$$D(e^{ax}X) = ae^{ax}X + e^{ax}DX = e^{ax}(D+a)X.$$

Here $(D+a)X$ means $DX + aX$. Deriving again, we get

$$\begin{aligned} D^2(e^{ax}X) &= D\{e^{ax}(D+a)X\} = ae^{ax}(D+a)X + e^{ax}D(D+a)X \\ &= e^{ax}\{a(D+a)X + D(D+a)X\} = e^{ax}(D+a)^2X. \end{aligned}$$

Or, by Leibnitz' Theorem we have at once

$$D^2(e^{ax}X) = a^2e^{ax}X + 2ae^{ax}DX + e^{ax}D^2X = e^{ax}(a+D)^2X.$$

To establish this result generally, assume

$$D^n(e^{ax}X) = e^{ax}(a+D)^nX;$$

on deriving again,

$$D^{n+1}(e^{ax}X) = ae^{ax}(a+D)^nX + e^{ax}D(a+D)^nX = e^{ax}(a+D)^{n+1}X.$$

Hence, if this assumption be correct for any derivative, it is correct for the next higher; but it is correct for

the second; hence is correct for the third, hence for the fourth, and so on, *i.e.*,

$$D^n(e^{ax}X) = e^{ax}(D+a)^nX.$$

Exercise.—Obtain this result at once by Leibnitz' theorem.

72. Meaning of Operator.—It is important that the student know just what the operator $(D+a)$ signifies. Written out in full,

$$(D+a)^3X = D^3X + 3aD^2X + 3a^2DX + a^3X.$$

D and a obey the same laws of operation, but a^2X means the product of the magnitude a^2 multiplied into X while D^2X means the second derivative of X as to x ; a is a symbol of magnitude, D of operation.

The foregoing formula holds as well for negative as for positive n , and is specially important for n negative; however, we do not yet know what is meant by D^{-1} , D^{-2} , ... D^{-n} (see *infra*).

73. Application to Sine and Cosine.—We have

$$D \sin mx = m \cos(mx); \quad D^2 \sin mx = (-m^2) \sin mx,$$

so that to derive $\sin mx$ twice is to multiply by $(-m^2)$; *i.e.*, D^2 before, or operating on, $\sin mx$ may be supplaccd by $(-m^2)$. The same holds for $\cos mx$ as well. Now $f(D)$, if it be a rational integral function of D , may be separated into an even part $\phi(D^2)$ and an odd part $\psi_1(D)$, which latter may be written $D\psi(D^2)$,* where $\psi(D^2)$ is itself an even function of D . Hence

$$\begin{aligned} f(D)\sin mx &= \phi(D^2)\sin mx + D\psi(D^2)\sin mx \\ &= \phi(-m^2)\sin mx + D\psi(-m^2)\sin mx \\ &= \phi(-m^2)\sin mx + m\psi(-m^2)\cos mx. \end{aligned}$$

$$\text{Also, } f(D)\cos mx = \phi(-m^2)\cos mx - m\psi(-m^2)\sin mx.$$

* For we may collect all the even powers and call the sum of them $\phi(D^2)$; also the sum of all the odd powers we may call $\psi_1(D)$; out of each of these we take the factor D , leaving only even powers whose sum we write $\psi(D^2)$.

74. Extension of Theorem XV.—*Leibnitz' Theorem* general as it is, admits of the following important *generalization*:

$$D^r(uv) = uD^r(v) + {}_rC_1u'D^{r-1}(v) + u''{}_rC_2D^{r-2}(v) + \dots \\ + u^{(p)}{}_rC_pD^{r-p}(v) + \dots,$$

where for convenience the derivatives of u are denoted by accents, and the terms are arranged according to the rising indices of u . Multiply this equation by an arbitrary constant A_r and then take the sum of $(n+1)$ such terms in ascending order, *i.e.*, let r range from 0 to n . We shall then have

$$\sum_0^n A_r D^r(uv),$$

an integral function of $D(uv)$, say $f(D)(uv)$. Hence

$$\sum_0^n A_r D^r(uv) = u \sum_0^n A_r D^r(v) + u' \sum_0^n {}_rC_1 D^{r-1}(v) + \dots \\ + u^{(p)} \sum_0^n {}_rC_p D^{r-p}(v) + \dots$$

Now the first derivative as to D of $A_r D^r$ is $rA_r D^{r-1}$, the second derivative is

$$r(r-1)A_r D^{r-2} = {}_rC_2 \cdot [2 \cdot A_r D^{r-2},$$

the p^{th} derivative is ${}_rC_p \cdot [p \cdot A_r D^{r-p}$, and so on. On comparing these expressions with the series above we see these terms with the factorials struck out are the coefficients in the expansion. Hence we may write

$$fD(u, v) = uf(D)v + u'f'(D)v + \frac{u''}{[2]} \cdot f''(D)v + \frac{u'''}{[3]} \cdot f'''(D)v + \dots$$

If now u be some positive integral power of x , x^c , then this series will close with the $(c+1)^{\text{th}}$ term, since

$$D^{c+1}x^c = 0.$$

75. Operator xD .—Another important operator is xD ; prefixed to any symbol as u , it directs us to *derive as to x and then multiply by x* . Any integral power of this

operator, as $(xD)^n$, directs us to *repeat the operation* xD n times. Observe that $(xD)^n$ is quite different from $x^n D^n$, which latter means merely the n^{th} derivative multiplied by x^n . We have $(xD)x^r = rx^r$, $(xD)^2 x^r = (xD)rx^r = r^2 x^r$, so that (xD) before any power of x may be supplac'd by the exponent of that power,

$$(xD)^n x^r = r^n x^r.$$

Hence if $f(xD)$ be any sum of positive integral powers of xD ,

$$f(xD)x^r = f(r)x^r.$$

76. Relation of $(xD)^n$ and $x^n D^n$.—We naturally ask, how are $(xD)^n$ and $x^n D^n$ related? We have seen that

$$(xD)^n x^r = r^n x^r;$$

also $x^2 D^2 x^r = x^2 \{r(r-1)\} x^{r-2} = r(r-1)x^r$;

so that $x^n D^n x^r = r(r-1)(r-2) \dots (r-n+1)x^r$.

Now $(xD-1)x^r = (xD)x^r - x^r = rx^r - x^r = (r-1)x^r$,

and $(xD-2)x^r = (xD)x^r - 2x^r = rx^r - 2x^r = (r-2)x^r$,

so that $(xD-s)$ before x^r may be supplac'd by $(r-s)$. Hence making this substitution, we have

$$x^n D^n = xD(xD-1)(xD-2) \dots (xD-n+1).$$

77. Anti-Operators.—All the foregoing properties of these operators D and xD , proved for positive integral exponents, may easily be extended as mere formalities to negative integral exponents, by properly *defining the operator* with negative exponent. We say then that we shall denote by D^{-1} an operation that is precisely undone by D , so that DD^{-1} before, or operating on, a symbol, may be supplac'd by 1 as a multiplier; or

$$DD^{-1} = 1.$$

What then is $D^{-1}x^r$? We have

$$D\{D^{-1}x^r\} = 1 \cdot x^r = x^r;$$

but $D \frac{x^{r+1}}{r+1} = x^r$; hence $D^{-1}x^r = \frac{x^{r+1}}{r+1}$;

i.e., the operator D^{-1} directs us to increase the exponent of a power of x by 1 and then divide by the increased exponent. We may name and read D^{-1} *anti-derivative*.

Similarly, $DD^{-1}(e^{ax}) = D(D^{-1}e^{ax}) = e^{ax}$.

But $D\left(\frac{1}{a}e^{ax}\right) = e^{ax}$;

hence $D^{-1}e^{ax} = \frac{1}{a}e^{ax} = a^{-1}e^{ax}$,

and $D^{-r}e^{ax} = a^{-r}e^{ax}$;

i.e., any integral power of D operating on e^{ax} may be supplanced by a raised to the same power.

Let the student extend this generalization for negative integral powers of D to sine and cosine.

78. What is $D^{-n}(e^{ax}X)$?—We have seen that neither D nor D^{-1} operating on e^{ax} removes it—a very important peculiarity of the exponential; naturally, then, we *must* assume

$$D^{-n}(e^{ax}X) = e^{ax}Y,$$

where Y is an unknown function of X . Operating now with D^n on both sides, we get

$$D^n\{D^{-n}(e^{ax}X)\} = e^{ax}X = D^n(e^{ax}Y) = e^{ax}(D+a)^nY,$$

whence $X = (D+a)^nY$, or $Y = (D+a)^{-n}X$.

Hence $D^{-n}(e^{ax}X) = e^{ax}(D+a)^{-n}X$.

We know precisely what we mean by the operators

D and $(D+a)$ with any positive integral exponent. We have *defined* D^{-1} to indicate an operation that undoes the operation of D , and we have found how to perform this operation on x^r ; we have not yet learned, nor in fact shall we learn, how to perform this operation generally, on any function of x , but the operation retains its importance even when no longer feasible. Similarly, we *define* the operator $(D+a)^{-1}$ or $\frac{1}{D+a}$ to indicate an operation that undoes the operation of $(D+a)$ or is undone by the operation $(D+a)$; but we have not yet learned how to perform this operation on even the simplest expressions. But it is not necessary to know how to carry out the operation in order to reason about it as above; all we pretend to know about Y is that it is a function of x which turns into X when operated upon by the operator $(D+a)^n$. Sometimes, however, we may reduce the complex operation $(D+a)^{-1}$ back to the simple operation D^{-1} , and that is often a great gain. Thus,

$$(D+a)^{-n}X = e^{-ax}D^{-n}(e^{ax}X).$$

This means that in order to operate with $(D+a)^{-n}$ on X , we operate with D^{-n} on $e^{ax}X$ and then multiply by e^{-ax} . This inverse operation $(D+a)^{-1}$ is thus seen to be very complex, and does not admit of immediate execution.

Exercise.—Extend the theorems concerning the operator xD to the case of whole negative exponents.

79. Indefiniteness of Inverse Operations.—It must not be disguised from the student that in all this argument concerning inverse operators there has been made tacitly an important assumption. Thus, since

$$D(D^{-1}x^r) = x^r \quad \text{and} \quad D \frac{x^{r+1}}{r+1} = x^r,$$

it is concluded that

$$D^{-1}x^r = \frac{x^{r+1}}{r+1};$$

the assumed major premise is that functions which, being operated upon in the same way, yield the same results, are equal. But this is manifestly not universally true; for $Dx^3 = 3x^2$, and $D(x^3+c) = 3x^2$, but x^3 does not equal x^3+c . The fact is, as we shall soon learn, that these *inverse* or *anti*-operations are definite only as to the *form* of the result, but are wholly indefinite as to the value of the result; it is just as correct to write

$$D^{-1}(e^{ax}) = a^{-1}e^{ax} + c$$

(where c is constant as to x), as to write

$$D^{-1}(e^{ax}) = a^{-1}e^{ax}.$$

This indefiniteness is an exceedingly important characteristic of these inverse operations.

EXERCISES.

1. Write off the fifth Derivative of x^7 ; the fourth of x^3 ; the ninth of x^{-2} ; the third of $\frac{1}{x^4}$ and of $\frac{a}{(x-1)^3}$.
2. Find the n^{th} Derivatives of

$$\frac{c}{x^2 - a^2}, \quad \frac{cx}{(x-a)(x-b)}, \quad \frac{3x}{(2x-1)(x-2)},$$

$$\frac{x^2}{(x-1)(x-2)(x-3)}, \quad \frac{2x^2 + 3x - 1}{(x-1)^3(x-2)^2(x-3)}, \quad \frac{3x^3 - 2x^2 + x - 3}{(x-1)^2(x^2-9)}.$$

3. $y = \frac{1}{x^2 + a^2}$, to find $D^n y$.

We have $y = \frac{1}{x^2 + a^2} = \frac{1}{2ai} \left\{ \frac{1}{x-ai} - \frac{1}{x+ai} \right\}$; hence

$$D^n y = \frac{(-1)^n [n]}{2ai} \left\{ \frac{1}{(x-ai)^{n+1}} - \frac{1}{(x+ai)^{n+1}} \right\}$$

$$= \frac{(-1)^n |n|}{2ai} \left\{ \frac{(x+ai)^{n+1} - (x-ai)^{n+1}}{(x^2+a^2)^{n+1}} \right\}$$

$$= \frac{(-1)^n |n|}{(x^2+a^2)^{n+1}} \{ {}_n C_1 a^{n-1} x + {}_n C_3 a^{n-3} x^3 + \dots + {}_n C_{n-1} a x^{n-1} \}.$$

Or thus: put $x = a \cot \theta$; then $y = \frac{1}{a^2} \overline{\sin \theta^2}$, and

$$x + ai = a(\cot \theta + i) = \frac{a}{\sin \theta} (\cos \theta + i \sin \theta) = \frac{a}{\sin \theta} e^{i\theta},$$

$$x - ai = \frac{a}{\sin \theta} e^{-i\theta}.$$

Hence

$$D^n y = \frac{(-1)^n |n|}{2ai} \left\{ \frac{(x+ai)^{n+1} - (x-ai)^{n+1}}{(x^2+a^2)^{n+1}} \right.$$

$$= \frac{(-1)^n |n|}{2ai} \left\{ \frac{\overline{\sin \theta^{n+1}}}{a^{n+1}} (e^{i(n+1)\theta} - e^{-i(n+1)\theta}) \right\}$$

$$= \frac{(-1)^n |n|}{a^{n+2}} \overline{\sin \theta^{n+1}} \sin(n+1)\theta.$$

4. Find n^{th} Derivative of $y \equiv \frac{c}{x^2+x+1}$.

Here put $(x + \frac{1}{2}) = u$ and apply Ex. 3.

5. Find n^{th} Derivative of $y \equiv \frac{1}{(x+a)^2 + b^2}$.

Put $x+a = r \cos \theta$, $b = r \sin \theta$; whence

$$r^2 = (x+a)^2 + b^2, \quad \tan \theta = \frac{b}{x+a};$$

proceed as in Ex. 3.

6. $y = \tan^{-1} \frac{x}{a}$; find n^{th} Derivative. Derive and apply Ex. 3.

7. Find n^{th} Derivatives of $\frac{x}{x^2+a^2}$, $\frac{x^2-2x}{x^3+1}$, $x^2 \tan^{-1} x$, $\frac{a^3}{x^4-a^4}$,

$$\frac{1}{(x^2+a^2)(x^2+b^2)}, \quad \frac{x}{x^4+x^2+1}, \quad \ln^{-1} \frac{x}{a}.$$

8. Find n^{th} Derivatives of $x^3 e^{ax}$, $x^3 \sin ax$, $x^4 \cos ax$, $x^n a^x$, $x^n e^{ax} \sin bx$, $x^n e^{ax} \cos bx$.

9. Find n^{th} Derivatives of xy_1 , $x^2 y_2$, $x^3 y_3$, $x^4 y_4$, where y_n means the n^{th} Derivative of y as to x .

10. From $(1+x^2)y_2 + xy_1 - m^2y = 0$ deduce

$$(1+x^2)y_{n+2} + (2n+1)xy_{n+1} + (n^2 - m^2)y_n = 0,$$

and find y_n when $y = 0$.

11. Find n^{th} Derivatives of $\overline{\sin x^2}$, $\overline{\cos x^3}$, $\overline{\tan x^3}$.

12. Find n^{th} Derivatives of $x^3 \log x$ and $x^n \log x$.

13. $y = \frac{\cos x}{e^x}$; prove that $y_4 = -4y$, and thence show how to find any Derivative.

14. From $y = A \sin ax + B \cos ax$ derive the differential equations

$$y_2 + m^2y = 0 \quad \text{and} \quad y_{n+2} + m^2y_n = 0.$$

15. Obtain the differential equation $x^2y_2 + xy_1 + y = 0$ from

$$y = a \cos(\log x).$$

16. If u and v be functions of x establish the important relation

$$D_x \begin{vmatrix} u_1 & v_1 \\ u_2 & v_2 \end{vmatrix} = \begin{vmatrix} u_1 & v_1 \\ u_3 & v_3 \end{vmatrix},$$

when the suffixes denote order of derivation as to x .

17. Extend Ex. 16 to three functions u , v , w , and then to any number of functions of x .

18. Show that the n^{th} Derivative of $x^n y^n$, when $x+y=1$, is

$$\underline{n} \{ y^n - {}_n C_1^2 x y^{n-1} + {}_n C_2^2 x^2 y^{n-2} - \dots \}.$$

19. If $y = (c_0 + c_1x + c_2x^2 + \dots + c_nx^n)e^{ax}$, deduce the differential equation of the $(n+1)^{\text{th}}$ order $(D-a)^{n+1}y = 0$.

20. If $y = (c_0 + c_1x + c_2x^2 + \dots + c_nx^n)(A \cos ax + B \sin ax)$, deduce the differential equation of $2n^{\text{th}}$ order $(D^2 + a^2)^ny = 0$, and find what change to make in y when $(D^2 - a^2)y = 0$.

CHAPTER II.

INTEGRATION.

80. Problem of Areas.—One of the most important and frequent problems in Geometry is the problem of **Quadrature**, *i.e.*, of finding a *square* equal in area to some given figure, as a triangle, circle, ellipse, parabolic or hyperbolic segment, etc. In case of rectilinear figures the problem admits of ready solution by cutting them up into triangles and trapezoids, whose areas may be expressed either arithmetically or geometrically through equivalent squares. But when the figure is curvilinear in whole or in part, this method no longer applies, and new concepts are required, of which chief and regulative is the **Limit**.

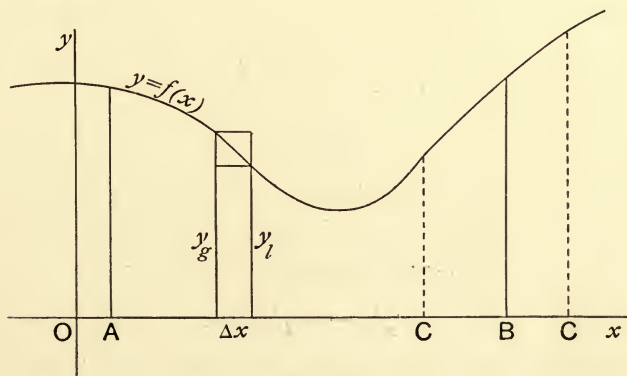

FIG. 12.

81. Illustration.—To illustrate, let it be required to find the area bounded by the x -axis, the graph of $y = f(x)$,

and the two end-ordinates corresponding to $x=a$ and $x=b$. Divide the base $AB \equiv b-a$ into n parts, not necessarily equal, but each small at will for n great at will, and denote each by Δx . Consider any strip standing on one of these sub-intervals, Δx . To different points in this Δx there correspond different values of x , and to these there correspond in general different values of y . Among these various y 's there will be a greatest and a least, or, in any case, one as great and one as small as any other; call them y_g and y_l . Then (except for the simple case of y constant, where this discussion would be superfluous), the rectangle of y_g and Δx is greater, while the rectangle of y_l and Δx is less, than the strip on Δx ; and if we form the sum of all such greater rectangles, and the sum of all such less rectangles, we shall have the one sum greater and the other sum less than the area in question, A ; or, in symbols,

$$\Sigma y_g \Delta x > A > \Sigma y_l \Delta x.$$

This double inequality holds always, however great n may be, and however the interval $b-a$ may be divided into sub-intervals. Now, if $y=f(x)$ be a **continuous** function of x , then by making each Δx small enough, we may make each fluctuation $y_g - y_l$ in the value of y for that Δx as small as we please; that is,

$$y_g - y_l < \sigma'$$

for each and every sub-interval Δx . Hence $\Sigma y_g \Delta x - \Sigma y_l \Delta x$, which is $\Sigma (y_g - y_l) \Delta x$, is $< \sigma' \Sigma \Delta x$, or $< \sigma' (b-a)$. Now $b-a$ is finite, hence $\sigma' (b-a)$ is small at will; or

$$\Sigma y_g \Delta x - \Sigma y_l \Delta x < \sigma.$$

Hence these two sums may be brought and kept close at will to each other in value; meantime the area A always lies fixed between them; hence each differs from this constant A by an infinitesimal; hence they have this

constant A as their *common limit*; moreover, if we sum similarly, using any intermediate value of y for each Δx , so that $y_g > y > y_v$, we shall get a sum between the two preceding sums, which therefore has this same A for its limit; *i.e.*,

$$A = \text{Limit } \Sigma y \Delta x,$$

y being *any* ordinate on the sub-interval Δx .

For this new concept, this limit of a summation, we need a new name and a new symbol; we name it **Integral** of y as to x between the **extremes** a and b , and we symbolize it thus:

$$A = \int_a^b y dx \equiv \int_a^b f(x) dx.$$

82. Integration not Summation.—Observe carefully that this symbol, though made up of several parts, is yet a whole, a unit, and we must not yield to the temptation to analyze it and seek out the meaning of each part. These parts are indeed full of distinct suggestion, but not of distinct significance. Thus, \int suggests Σ and dx suggests Δx , but \int is not Σ and dx is not Δx . The integral is in fact sharply distinguished from a summation: the latter *varies* with Δx and with the y 's chosen; the former is *constant*, is dependent neither on Δx nor on the y 's chosen. The integral is in fact as little like the summation as the circle is like the circumscribed or inscribed regular polygon. So, too, dx is very unlike Δx ; the latter is a linear magnitude, perfectly intelligible by itself, apart from any other symbol; but dx is not a magnitude at all, and is not intelligible apart from the general integral symbol, $\int \dots dx$. We may, and in fact often do, use dx and such symbols by themselves, but we do not interpret them magnitudinally as thus used. These symbols of operation obey certain laws of magnitudes without themselves being magnitudes. There is nothing

logically strange or surprising in this fact. We should not expect to be able to convert simply the proposition, *Symbols of magnitude obey certain laws of operation*, into *Symbols that obey certain laws of operation are symbols of magnitude*.

Of the separate symbolic use of dx (called **differential** of x) we shall speak hereafter; at present we view the whole integral symbol $\int_a^b \dots dx$ as a unit, a complete fusion of all its elements.

The **extremes** a and b are commonly called the *limits* of integration; but the term *limit* has already been appropriated to denote something entirely different, so that its use in this other sense seems unfortunate.

The function y or $f(x)$ may be called **Integrand**.

83. Deductions.—From this definition of Integral as Limit of a Sum, several properties follow at once:

(i.) Exchanging the extremes reverses the Integral; *i.e.*,

$$\int_b^a f(x) dx = - \int_a^b f(x) dx.$$

For, if we begin with $x=b$ and reckon backward to $x=a$, the y 's will not be affected, but each Δx will be reversed, therewith each term in the summation will be reversed; then on taking out the common factor (-1) we shall have the original summation, and hence, on taking the limit we shall get the original Integral, multiplied by (-1) .

(ii.) If a , b , c all lie in an interval where $f(x)$ is *integrable* (*i.e.*, for the present, where $f(x)$ is *finite, one-valued, and continuous*), then the Integral from a to b equals the sum of the Integrals from a to c , and from c to b ; or, in symbols,

$$\int_a^b f(x) dx = \int_a^c f(x) dx + \int_c^b f(x) dx.$$

For, manifestly, the summation from a to b equals the sum of the summations from a to c and from c to b ; then the limit of the sum equals the sum of the limits; hence, etc.

If c lies between a and b , both the part-integrals will be taken in the same sense; but if c lies without the interval a to b , then the integrals will be taken in opposite senses, and we must of course make sure that $f(x)$ is actually integrable up to c .

(iii.) A constant factor, k , may be placed indifferently within or without the sign of integration, \int . For by the *distributive* Law of Multiplication the factor k may be taken out of each summand and made a multiplier of the summation, thus:

$$\Sigma f(x)\Delta x \equiv \Sigma kF(x)\Delta x = k\Sigma F(x)\Delta x.$$

On taking the limits we get

$$\int kF(x)dx = k\int F(x)dx.$$

(iv.) The integral of the sum of a finite number of functions equals the sum of the integrals of the functions; *i.e.*,

$$\int_a^b \{f_1(x) + \dots + f_n(x)\} dx = \int_a^b f_1(x)dx + \dots + \int_a^b f_n(x)dx.$$

For the limit of the sum equals the sum of the limits.

Of course, the separate functions are supposed integrable within the extremes of integration, a and b ; note also that their number must be finite. Whether we may integrate an infinite series by integrating its terms separately, we leave as yet undecided.

(v.) The argument of integration x may be multiplied by any constant m if at the same time the integral be multiplied and the extremes divided by m , *i.e.*,

$$\int_a^b f(x)dx = m \int_{a/m}^{b/m} f(mx)dx = m \int_{a/m}^{b/m} F(x)dx.$$

For by merely writing mu for x we get

$$\int_a^b f(x)dx = \int_a^b f(mu)d(mu).$$

This is a mere change of name, but now in the summation $\Delta mu = m\Delta u$, howsoever the interval be cut up into sub-intervals. Hence

$$\int_a^b f(mu)d(mu) = m \int_{mu=a}^{mu=b} f(mu)du.$$

But when $mu = a$ and b , $u = a/m$ and b/m ; moreover, the function $f(mu)$ of mu equals some other function $F(u)$ of u ; lastly, and this is very important, it is indifferent what symbol we use for the argument of integrand and integration, whether we write

$$\int F(u)du \quad \text{or} \quad \int F(x)dx;$$

the extremes being unchanged, the range of value being the same, the mere change of name, as from u to x , has no effect on the value of the integral. Hence

$$\int_a^b f(x)dx = m \int_{a/m}^{b/m} F(x)dx,$$

if $f(mu) = F(u)$.

84. Theorem of Mean Value: XVI.—If $\phi(x)$ and $\psi(x)$ be two functions of x , both integrable from a to b , and $\psi(x)$ change not its sign in the interval a to b , then

$$\int_a^b \phi(x)\psi(x)dx = \phi(\bar{x}) \int_a^b \psi(x)dx,$$

where \bar{x} is some value between a and b .

For, if $\phi(x)$ vary at all in the interval, let G be the greatest and L the least value it assumes; then $G - \phi(x)$ and $\phi(x) - L$ are both positive throughout the interval

a to b . Also, let $\psi(x)$ be (say) positive from a to b ; then

$$G\psi(x) - \phi(x)\psi(x) \quad \text{and} \quad \phi(x)\psi(x) - L\psi(x)$$

are both positive from a to b . Hence

$$\int_a^b \{G\psi(x) - \phi(x)\psi(x)\}dx > 0, \quad \int_a^b \{\phi(x)\psi(x) - L\psi(x)\}dx > 0,$$

since in each all the terms of the sum, hence the sums themselves, and hence the limits of the sums, are positive. Hence

$$G \int_a^b \psi(x)dx > \int_a^b \phi(x)\psi(x)dx > L \int_a^b \psi(x)dx.$$

Hence there is some value M between G and L such that

$$\int_a^b \phi(x)\psi(x)dx = M \int_a^b \psi(x)dx,$$

and since $\phi(x)$ is continuous, in passing from the value L to the value G it must pass at least once through the intermediate value M ; for $x = \bar{x}$ let $\phi(x)$ attain the value M , so that $\phi(\bar{x}) = M$; then

$$\int_a^b \phi(x)\psi(x)dx = \phi(\bar{x}) \int_a^b \psi(x)dx.$$

If $\psi(x)$ be negative throughout the intervals a to b , no change worth mention is required in the reasoning. If θ denote a proper fraction that may take any value from 0 to 1 inclusive, then we may write

$$\bar{x} = a + (b - a)\theta \quad \text{and} \quad \int_a^b \phi(x)\psi(x)dx = \phi(a + \overline{b - a}\theta) \int_a^b \psi(x)dx.$$

85. Derivation of an Integral as to its extremes.—

It is plain that the Integral $I = \int_a^b f(x)dx$ is a function of its extremes a and b ; for by changing either one, the number of terms in the summation is changed, the range

of integration is varied, the area A is altered. Accordingly, we may seek to derive I as to b . We have

$$I = \int_a^b f(x)dx, \quad I + \Delta I = \int_b^{b+\Delta b} f(x)dx = I + \int_b^{b+\Delta b} f(x)dx;$$

$$\therefore \Delta I = \int_b^{b+\Delta b} f(x)dx = f(\bar{x}) \int_b^{b+\Delta b} dx = f(\bar{x}) \cdot \Delta b.$$

Here $\phi(x)$, of 84, = $f(x)$, and $\psi(x) = 1$; also $\int_b^{b+\Delta b} dx = \Delta b$,

for it is the limit of the sum of the Δx 's into which the interval from b to $b + \Delta b$ is cut, and this sum is always Δb .

(In general $\int_f^g dx = g - f$). Hence

$$\frac{\Delta I}{\Delta b} = f(\bar{x}) = f(b + \theta \Delta b); \quad \text{whence } I_b = f(b); \quad \text{i.e.,}$$

The Derivative of the Integral as to its upper extreme is the value of the Integrand at the upper extreme.

Let the student show in two ways that $I_a = -f(a)$. These values $f(b)$ and $f(a)$ are the end-ordinates of A , and may be called *Derivatives of the area* as to its abscissae.

Corollary.—If $a < u < b$, then $\left\{ \int_a^u f(x)dx \right\}_u = f(u)$.

86. Quadrature of Parabola.—Before proceeding further with the general theory of Integrals, it may be well to calculate or evaluate some of them, and thereby clinch our notions. Take, for instance, the ordinary Apollonian or quadratic Parabola $x^2 = py$, and let us compute the area from the vertex O out to $x = b = u$, $y = v$. Cut the interval u into n sub-intervals, each $= \Delta x = \frac{u}{n}$; then the

successive values of y_i are

$$0, \frac{1^2 \cdot u^2}{n^2 p}, \frac{2^2 \cdot u^2}{n^2 p}, \dots, \frac{(n-1)^2 u^2}{n^2 p},$$

and of y_g are

$$\frac{1 \cdot u^2}{n^2 p}, \frac{2^2 \cdot u^2}{n^2 p}, \dots, \frac{n^2 \cdot u^2}{n^2 p}.$$

Forming the sums and taking out the constant factors we get

$$\frac{u^2}{n^2 p} (0^2 + 1^2 + 2^2 + \dots + (n-1)^2) \frac{u}{n} < A,$$

$$\frac{u^2}{n^2 p} (1^2 + 2^2 + 3^2 + \dots + n^2) \frac{u}{n} > A.$$

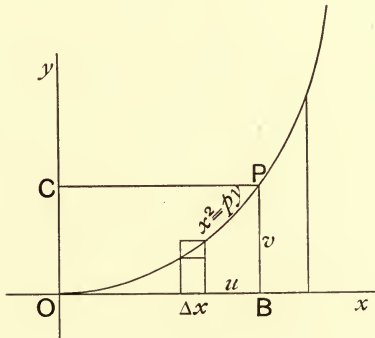

FIG. 13.

The sum of the squares of the first n natural numbers is

$$\frac{1}{6} n(n+1)(2n+1); \text{ hence, on cancelling } n^3,$$

$$\frac{1}{p} \cdot \frac{u^3}{6} \left(1 + \frac{1}{n}\right) \left(2 + \frac{1}{n}\right) > A > \frac{1}{p} \cdot \frac{u^3}{6} \left(1 - \frac{1}{n}\right) \left(2 - \frac{1}{n}\right).$$

Now letting n increase without limit we close down the two extremes in this inequation upon the constant mean value A , and we get as $\frac{1}{n}$ vanishes,

$$A = \frac{u^3}{3p} = \frac{u}{3} \cdot \frac{u^2}{p} = \frac{1}{3} uv = \frac{1}{3} OBPC.$$

Also
$$A = \int_0^u y dx = \int_0^u \frac{x^2}{p} dx = \frac{1}{p} \int_0^u x^2 dx = \frac{1}{p} \cdot \frac{u^3}{3},$$

hence
$$\int_0^w x^2 dx = \frac{w^3}{3}; \quad \text{hence} \quad \int_u^w x^2 dx = \frac{w^3}{3} - \frac{u^3}{3}.$$

87. Generalization.—Similarly for the general Parabola $x^m = cy$:

$$A = \int_0^u y dx = \frac{1}{c} \int_0^u x^m dx = \frac{1}{c} \text{Lim} \Sigma x^m \Delta x.$$

We divide the interval into n equal parts, $\Delta x = \frac{u}{n}$; the successive values of x are $0, \frac{u}{n}, \frac{2u}{n}, \dots, \frac{nu}{n}$.

Hence on taking out the common factor $\frac{u^m}{n^m}$,

$$\Sigma x^m \Delta x = \frac{u^m}{n^m} (1^m + 2^m + 3^m + \dots + n^m) \cdot \frac{u}{n}.$$

This sum of the m^{th} powers of the first n natural numbers may be expressed as a series of $(m+2)$ terms, arranged according to falling powers of n with finite coefficients functions of m , the first term being $\frac{n^{m+1}}{m+1}$; *i.e.*,

$$\begin{aligned} \Sigma x^m \Delta x &= \frac{u^{m+1}}{n^{m+1}} \left(\frac{n^{m+1}}{m+1} + \text{lower powers of } n \right) \\ &= \frac{u^{m+1}}{m+1} + \text{negative powers of } n. \end{aligned}$$

On letting n increase without limit, these $(m+1)$ negative powers all tend toward zero, the limit of their sum is 0, and we get

$$\text{Lim} \Sigma x^m \Delta x \equiv \int_0^u x^m dx = \frac{u^{m+1}}{m+1};$$

hence, too,
$$\int_u^w x^m dx = \frac{w^{m+1}}{m+1} - \frac{u^{m+1}}{m+1}, \quad A = \frac{uv}{m+1}.$$

Accordingly, to integrate x^m , m being natural, increase the exponent by 1, divide by the new exponent, and take the value of this result at the lower extreme from its value at the upper extreme.

88. Curve of Sines.—Find the area of an arch of the sinusoid, $y = \sin x$. Divide the interval from $x = 0$ to $x = u$ into n equal parts, $\Delta x = \frac{u}{n}$; we have then

$$\begin{aligned} \Sigma \sin x \Delta x &\equiv \left\{ \sin \frac{u}{n} + \sin \frac{2u}{n} + \dots + \sin \frac{nu}{n} \right\} \frac{u}{n} \\ &= \frac{2 \sin \left(\frac{1}{2} \cdot \frac{nu}{n} \right) \sin \frac{1}{2} \frac{(n+1)u}{n}}{\sin \left(\frac{1}{2} \cdot \frac{u}{n} \right)} \cdot \frac{u}{2n}. \end{aligned}$$

The Integral sought, $\int_0^u \sin x dx$, is the limit of this expression for n large at will. We take the limits of the factors separately: limit of $\sin \left(\frac{1}{2} \frac{nu}{n} \right)$ is of course $\sin \left(\frac{1}{2} u \right)$, as is also limit of $\sin \left(\frac{1}{2} \cdot \frac{(n+1)u}{n} \right)$, the limit of the product is therefore $\left(\sin \frac{1}{2} u \right)^2$; limit of $\frac{u}{2n} / \sin \frac{u}{2n}$ is 1; hence we have

$$\int_0^u \sin x dx = 2 \left(\sin \frac{1}{2} u \right)^2 = 1 - \cos u.$$

Hence $\int_u^w \sin x dx = (1 - \cos w) - (1 - \cos u) = -(\cos w - \cos u).$

Hence too, $\int_0^\pi \sin x dx = -(\cos \pi - \cos 0) = 2.$

Show that $\int_u^w \cos x = \sin w - \sin u,$

using $\cos a + \cos 2a + \dots + \cos na = \frac{\cos \frac{na}{2} \cdot \sin \frac{(n+1)a}{2}}{\sin a/2}$

89. The Logarithmic Curve.—Let the bounding graph be the logarithmic $y=e^x$. Cut the interval from $x=0$ to $x=u$ into n equal parts, $\Delta x = \frac{u}{n} = h$, and form the sum

$$\begin{aligned}\Sigma e^x \Delta x &\equiv (e^h + e^{2h} + e^{3h} + \dots + e^{nh})h \\ &= e^h \left(\frac{e^{nh} - 1}{e^h - 1} \right) h = e^h (e^u - 1) \frac{h}{e^h - 1} \\ &= e^h (e^u - 1) \frac{1}{1 + \frac{h}{2} + \frac{h^2}{3} + \dots}.\end{aligned}$$

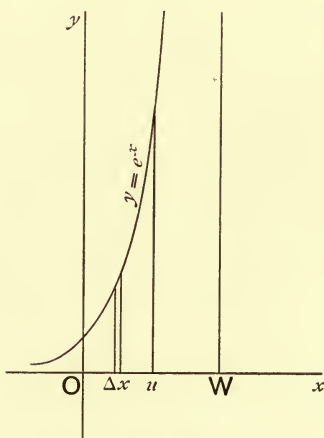

FIG. 14.

Hence
$$\text{Lim } \Sigma e^x \Delta x = \int_0^u e^x dx = e^u - 1,$$

and
$$\int_u^w e^x dx = e^w - e^u.$$

90. The Hyperbola.—Thus far we have cut up the range of integration into equal parts, but such a division is by no means necessary nor indeed always expedient. For example, let the graph $y=f(x)$ be the rectangular Hyperbola $xy=1$, referred to its asymptotes as axes,

and let the extremes be $x=1$ and $x=u$; we seek the Integral $\int_1^u \frac{dx}{x}$. We divide the interval 1 to u into n parts

in *geometric* progression at the points whose x 's are in order $1, h, h^2, h^3, \dots, h^n$, this last $=u$. The corresponding values of y are $1, h^{-1}, h^{-2}, h^{-3}, \dots, h^{-n}$, this last $=1/u$. The corresponding sub-intervals are

$$h-1, h(h-1), h^2(h-1), \dots, h^{n-1}(h-1).$$

We know from Analytic Geometry that the areas of the strips are all equal, and it is moreover plain that each is $< h-1$, but $> \frac{h-1}{h}$ or $> 1 - \frac{1}{h}$. Since there are n such, we

have
$$n(h-1) > A > n \left(1 - \frac{1}{h}\right); \text{ i.e.,}$$

$$\begin{aligned} A &= \int_1^u \frac{dx}{x} = \text{Lim } n(h-1) = \text{Lim}_{n=\infty} n \left(u^{\frac{1}{n}} - 1\right) = \text{Lim}_{r=0} \frac{(u^r - 1)}{r} \\ &= \text{Lim} \left(\frac{e^{r \log u} - 1}{r} \right) = \text{Lim} \left(\log u + \frac{r(\log u)^2}{2} + \dots \right) = \log u, \end{aligned}$$

(where $r = \frac{1}{n}$). Hence $\int_u^w \frac{dx}{x} = \log w - \log u = \log \frac{w}{u}$.

91. Need of better Method.—We have now integrated a number of the simpler functions, algebraic and transcendental, and have learned by trial that the process of integration is perfectly definite and leads to definite results. We might continue these researches and learn to integrate other functions. However, the method is a tedious one and depends for its success in each individual case upon our ability to bring our summation into a form convenient for the recognition of its limit. The question arises, Is there any general method for reckoning these limits that shall not depend upon our ingenuity in effecting a summation? *There is*, as may thus be made evident.



92. Integration in General.—Let $y=f(x)$ be finite, one-valued and continuous between $x=a$ and $x=b$, $y=a'$ and $y=b'$. Let $\Delta x_1, \Delta x_2, \dots, \Delta x_n$ be n sub-intervals into which $b-a$ is divided, and $\Delta y_1, \Delta y_2, \dots, \Delta y_n$ be the corresponding sub-intervals of $b'-a'$. Also let $\phi(x)$ be the derivative of $f(x)$ for every value of x in the interval a to b , or $\phi(x)=f'(x)$. Then by *Definition* of Derivative (Art. 19) we have

$$\frac{\Delta y}{\Delta x} = f'(x) + \sigma = \phi(x) + \sigma,$$

$$\Delta y = f'(x)\Delta x + \sigma\Delta x = \phi(x)\Delta x + \sigma\Delta x,$$

where σ is small at will and vanishes with Δx . This equation is *exact* and holds for everyone of the sub-intervals, $\Delta x_1, \Delta x_2, \dots, \Delta x_n$. Hence

$$\Sigma \Delta y = \Sigma f'(x)\Delta x + \Sigma \sigma\Delta x = \Sigma \phi(x)\Delta x + \Sigma \sigma \cdot \Delta x.$$

On taking the limits we obtain

$$b' - a' = \int_a^b f'(x)dx + \int_a^b \sigma dx = \int_a^b \phi(x)dx + \int_a^b \sigma dx.$$

Now

$$\int_a^b \sigma dx = \text{Lim. } \Sigma \sigma \cdot \Delta x = \text{Lim. } \bar{\sigma} \cdot \text{Lim. } \Sigma \Delta x,$$

where $\bar{\sigma}$ is some *mean* of the infinitesimals $\sigma_1, \sigma_2, \dots, \sigma_n$ corresponding to $\Delta x_1, \Delta x_2, \dots, \Delta x_n$, and is itself infinitesimal, since even the greatest of the σ 's is infinitesimal; also, by definition,

$$\text{Lim. } \Sigma \Delta x = \int_a^b dx = b - a \quad \text{and} \quad \text{Lim. } \bar{\sigma} = 0;$$

$$\text{hence} \quad \int_a^b \sigma dx = 0 \quad \text{and} \quad \int_a^b f'(x)dx = b' - a' = f(b) - f(a);$$

i.e., the integral of the derivative of a function is the value of that function at the upper extreme, less its value at the lower extreme, of integration.

93. Another Proof.—This same important fact may be elicited otherwise, thus: Let $I = \int_a^b \phi(x) dx$, and let $\phi(x)$ be the derivative of $f(x)$ for every value of x in the interval a to b ; then

$$\{I - f(b)\}_b = I_b - f'(b) = \phi(b) - f'(b) = 0,$$

and this result holds (see Cor., Art. 85) when b denotes *any* value in the range of integration. Now a derivative may of course vanish for some particular value of the argument; thus $2(x-c)$, the derivative of $(x-c)^2$, vanishes for $x=c$, and this by no means implies that $(x-c)^2$ is constant; but when the derivative vanishes for *every* value of the argument in a certain interval, then the function is constant within that interval. For if the function ($y = F(x)$) were discontinuous at any value of x , then in the neighbourhood of that value Δy would not be small at will and $\text{Lim. } \frac{\Delta y}{\Delta x}$ would not be 0; but if $y = F(x)$ be continuous, then it may be depicted geometrically by a curve, the tangent of whose slope to the x -axis is y_x ; and if this latter always = 0, then the curve is everywhere parallel to the x -axis, *i.e.*, it is a right line parallel to x -axis, *i.e.*, $y = a$ const. Hence, since $\{I - f(b)\}_b = 0$, $I - f(b) = C$.

To find this constant C we may give b any value in the range of integration; for $b = a$, $I = 0$ and $f(b) = f(a)$; hence $0 - f(a) = C$, or $I = \int_a^b \phi(x) dx \equiv \int_a^b f'(x) dx = f(b) - f(a)$.

94. Integration and Derivation.—While then the so-called *Integral Calculus* is in no wise dependent upon the so-called *Differential Calculus* for its fundamental notions or even processes, nevertheless the latter is invaluable to the former in discovering the *form* of the

Integral from the *form* of the Integrand. The law is that, *so far as form is concerned*, whenever we recognize the Integrand as the Derivative of a function, that function may be taken as the *form* of the Integral; the *value* of the Integral is then found as the difference of values of this function at the upper and lower extremes. But even if we could not *discover* a function which derived would yield the Integrand, or even if there were in the nature of the case *no* such function, the concept of the Integral would not suffer. This latter might still exist, and we might be able to calculate it, though it would be impossible to derive it and obtain the Integrand. Whenever then the Integrand is a Derivative—and this simple but very general case shall engage at present our exclusive attention, more difficult matters being held in reserve—the operation of **Integration**, so far as *form* is concerned, is merely the **Inverse of Derivation**.

If $\phi(x)$ is the Derivative of $f(x)$, then $f(x)$ is the Integral of $\phi(x)$.

Symbolically, $\int = D^{-1} = \frac{1}{D}$, $D = \int^{-1} = \frac{1}{\int}$, D and \int being symbols of operation, *not* of magnitude. So far as *form* only is concerned, the Integral is the **anti-Derivative** of the Integrand.

95. Definite and Indefinite Integrals.—It very often happens that we are concerned solely or principally with the *form* of the Integral. In such cases it is customary to omit the extremes and write

$$\int f(x)dx = \phi(x) \quad \text{or} \quad \int f(x)dx = \phi(x) + C.$$

These equations must be understood as declaring only the *form* of the Integral, *not* its *value*. In fact, the Integral is a mere form until the extremes of integration

are assigned; only then does it become a magnitude. The arbitrary constant C —constant, that is, with respect to x —is added because the form ϕ is for all purposes of derivation unaffected by presence or absence of additive constants; C would of course disappear in derivation. Such a mere *form* is called an **Indefinite Integral**, whereas the magnitude or value got by assigning extremes is called the **Definite Integral**.

Observe carefully that in the Indefinite Integral the argument-symbol is wholly indifferent; thus

$$\int f(x)dx = \int f(y)dy = \phi(x) = \phi(y) = \phi(u) = \text{etc.}$$

So, too, in the Definite Integral the argument of integration is indifferent; thus

$$\int_a^b f(x)dx = \int_a^b f(y)dy = \int_a^b f(u)du = \phi(b) - \phi(a).$$

The very great importance of the arbitrary constant C in giving generality to the Integral Form will be seen in dealing with Differential Equations.

It is common to make a double use of one symbol, as x , using it namely both as the argument of integration and also as the upper extreme. Thus we often write $\int_a^x f(x)dx$. There is no objection to this mode of writing, provided that no confusion result in the mind of the student.

96. Fundamental Forms.—We shall now use the theorem of Art. 94 to determine the form of a number of *Elementary Integrals*:

$$1. D \frac{x^{m+1}}{m+1} = x^m; \quad \therefore \int x^m dx = \frac{x^{m+1}}{m+1}.$$

$$2. D e^x = e^x; \quad \therefore \int e^x dx = e^x.$$

3. $De^u = e^u \cdot u_x$; $\therefore \int e^u u_x dx = e^u$.
4. $D \log x = \frac{1}{x}$; $\therefore \int \frac{dx}{x} = \log x$.
5. $D \log u = \frac{u_x}{u}$; $\therefore \int \frac{u_x}{u} = \log u$.
6. $D \sin x = \cos x$; $\therefore \int \cos x dx = \sin x$.
7. $D(-\cos x) = \sin x$; $\therefore \int \sin x dx = -\cos x$.
8. $D \sin u = \cos u \cdot u_x$; $\therefore \int \cos u \cdot u_x \cdot dx = \sin u$.
9. $D(-\cos u) = \sin u \cdot u_x$; $\therefore \int \sin u \cdot u_x dx = -\cos u$.
10. $D \tan x = (\sec x)^2$; $\therefore \int (\sec x)^2 \cdot dx = \tan x$.
11. $D \tan u = (\sec u)^2 \cdot u_x$; $\therefore \int (\sec u)^2 \cdot u_x \cdot dx = \tan u$.
12. $D(-\cot x) = (\csc x)^2$; $\therefore \int (\csc x)^2 dx = -\cot x$.
13. $D(-\cot u) = (\csc u)^2 u_x$; $\therefore \int (\csc u)^2 \cdot u_x \cdot dx = -\cot u$.
14. $D(\sin^{-1}x) = \frac{1}{\sqrt{1-x^2}}$; $\therefore \int \frac{dx}{\sqrt{1-x^2}} = \sin^{-1}x$.
15. $D(\cos^{-1}x) = \frac{-1}{\sqrt{1-x^2}}$; $\therefore \int \frac{-dx}{\sqrt{1-x^2}} = \cos^{-1}x$.
16. $D(\tan^{-1}x) = \frac{1}{1+x^2}$; $\therefore \int \frac{dx}{1+x^2} = \tan^{-1}x$.
17. $D(\sin^{-1}x/a) = \frac{1}{\sqrt{a^2-x^2}}$; $\therefore \int \frac{dx}{\sqrt{a^2-x^2}} = \sin^{-1}\frac{x}{a}$.
18. $D\left(\frac{1}{a} \tan^{-1}\frac{x}{a}\right) = \frac{1}{a^2+x^2}$; $\therefore \int \frac{dx}{a^2+x^2} = \frac{1}{a} \tan^{-1}\frac{x}{a}$.
19. $D(\sec^{-1}x) = \frac{1}{x\sqrt{x^2-1}}$; $\therefore \int \frac{dx}{x\sqrt{x^2-1}} = \sec^{-1}x$.

$$20. D\left(\frac{1}{a} \sec^{-1} \frac{x}{a}\right) = \frac{1}{x\sqrt{x^2-a^2}}; \quad \therefore \int \frac{dx}{x\sqrt{x^2-a^2}} = \frac{1}{a} \sec^{-1} \frac{x}{a}.$$

$$21. D\left(\frac{1}{2a} \log \frac{x-a}{x+a}\right) = \frac{1}{x^2-a^2}; \quad \therefore \int \frac{dx}{x^2-a^2} = \frac{1}{2a} \log \frac{x-a}{x+a}.$$

97. Change of Variable.—When the Integrand is not one of the foregoing forms it may often be reduced to one of them by an appropriate *change of argument of Integration*, thus:

$$D_x \phi(u) = \phi'(u) \cdot u_x, \quad \text{hence} \quad \int \phi'(u) u_x dx = \phi(u);$$

$$\text{also} \quad D_u \phi(u) = \phi'(u), \quad \text{hence} \quad \int \phi'(u) du = \phi(u).$$

$$\text{Hence} \quad \int \phi'(u) u_x dx = \int \phi'(u) du;$$

i.e., we may pass from an integration as to u over to an integration as to x by multiplying the integrand by the derivative of u as to x .

This change of the argument of integration is of the most frequent occurrence. The process may be called **Integration by substitution**, or **mediate Integration**, since it corresponds to mediate Derivation.

We see then, and this is extremely important, that under the Integral sign we may supplace du by $u_x dx$; or that, for purposes of *Integration*, the symbolic equation holds,

$$du = u_x dx.$$

Here du and dx are called *differentials* of u and x , and hence u_x is called the *differential coefficient* of u as to x . In the Integral Calculus, and especially in its applications to Physics, this notation is more convenient than the *Derivative* notation thus far employed; neither is it logically objectionable, if properly understood. But we must beware of attempting a magnitudinal interpretation. The symbols du and dx are *not* symbols of magnitude; no matter how small the change in u may be, it is *not*

equal to the corresponding change in x , multiplied by the Derivative of u as to x . Accordingly, when asked what we mean by the symbolism $du = u_x dx$, our answer must be we mean that the Derivative of u as to x is u_x ; thus $d(x^3) = 3x^2 dx$ means only that the Derivative of x^3 as to x is $3x^2$. This symbolism is convenient because we may at once operate on both sides by integration and obtain a formally correct result. Then on assigning the extremes we get a correct relation between *magnitudes*. Similarly,

$$d^2y = 6x dx^2$$

means simply that the *second* Derivative of y as to x is $6x$. From this point on we shall frequently employ this **Differential Notation**.

98. Another very important general method is that of **Integration by Parts**. We have

$$d(uv) = u dv + v du, \text{ or}$$

$$(uv)_x = uv_x + vu_x.$$

Whence
$$\int (uv)_x dx = \int uv_x dx + \int u_x v dx.$$

or
$$\int uv_x dx = uv - \int u_x \cdot v \cdot dx.$$

Hereby we make the Integral of uv_x depend on that of $u_x \cdot v \cdot dx$, and this latter may be much simpler; or still other advantages may accrue.

Illustrations.—1. Consider $\int x e^x dx$. Here we put $x = u$, $e^x = v_x$, hence $e^x = v$; hence

$$\int x e^x dx = x e^x - \int e^x dx = e^x(x - 1).$$

Similarly integrate $x^2 e^x$, $x^3 e^x$, ... $x^n e^x$.

$$\begin{aligned} 2. \int (\cos x)^2 dx &= \int (\cos x)(\cos x) dx = \sin x \cos x + \int (\sin^2 x)^2 dx \\ &= \sin x \cos x + \int (1 - \overline{\cos^2 x}) dx = \sin x \cos x + x - \int (\cos^2 x)^2 dx. \end{aligned}$$

Here the integral is made to depend on the same integral, and this may be found by simply treating it as an unknown and solving the equation; hence, transposing and dividing by 2, we get

$$\int \overline{\cos x^2} dx = \frac{1}{2}(x + \sin x \cos x); \quad \int \overline{\sin x^2} dx = \frac{1}{2}(x - \sin x \cos x)$$

3. $\int \sqrt{a^2 - x^2} dx$. Such radicals are generally more manageable in the denominator, accordingly we write

$$\int \sqrt{a^2 - x^2} dx = \int \frac{a^2 - x^2}{\sqrt{a^2 - x^2}} dx = a^2 \int \frac{dx}{\sqrt{a^2 - x^2}} - \int \frac{x^2 dx}{\sqrt{a^2 - x^2}}$$

The first Integral on the right we recognize as $\sin^{-1} \frac{x}{a}$; the second we integrate by parts, thus:

$$\begin{aligned} - \int \frac{x^2 dx}{\sqrt{a^2 - x^2}} &= \int x \left(\frac{-x}{\sqrt{a^2 - x^2}} \right) dx = \int x (\sqrt{a^2 - x^2})_x dx \\ &= x \sqrt{a^2 - x^2} - \int \sqrt{a^2 - x^2} dx. \end{aligned}$$

Here again the original \int depends on itself; hence

$$\int \sqrt{a^2 - x^2} \cdot dx = \frac{1}{2} \left(x \sqrt{a^2 - x^2} + a^2 \sin^{-1} \frac{x}{a} \right),$$

$$\text{or} \quad = \frac{1}{2} \left(x \sqrt{a^2 - x^2} - a^2 \cos^{-1} \frac{x}{a} \right),$$

a result of great significance and importance.

Exercise.—Put $x = a \sin \phi$ or $x = a \cos \phi$, and obtain the two results of (3) by help of (2).

4. It is natural to investigate now the integrals of $\sqrt{x^2 - a^2}$ and $\sqrt{x^2 + a^2}$. As in (3) we get

$$\int \sqrt{x^2 - a^2} \cdot dx = \frac{1}{2} \left(x \sqrt{x^2 - a^2} - a^2 \int \frac{dx}{\sqrt{x^2 - a^2}} \right),$$

$$\int \sqrt{x^2 + a^2} \cdot dx = \frac{1}{2} \left(x \sqrt{x^2 + a^2} + a^2 \int \frac{dx}{\sqrt{x^2 + a^2}} \right).$$

We are as yet unacquainted with any simple expression that on derivation yields $\frac{1}{\sqrt{x^2 \pm a^2}}$, so that we cannot integrate these expressions at once. However, their analogy with $\int \frac{dx}{\sqrt{a^2 - x^2}}$ is evident, and their significance may be easily made geometrically apparent.

99. Circle and Equiaxial Hyperbola.—Consider the equations of a circle and a rectangular Hyperbola:

$$x^2 + y^2 = a^2 \quad \text{and} \quad x^2 - y^2 = a^2,$$

which may be written

$$y^2 = (a+x)(a-x) \quad \text{and} \quad y^2 = (x+a)(x-a).$$

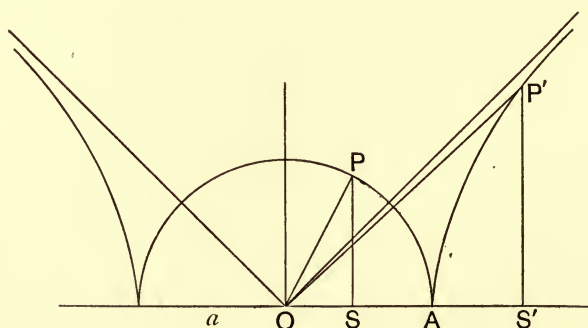

FIG. 16.

From the figure it is seen that when we divide any tract $2a$ *internally* and at each point of division erect as perpendicular ordinate the geometric mean of the parts $a+x$ and $a-x$, the locus of the ends of the ordinates is the *circle*, but when we divide externally the locus is the *hyperbola*. So closely related are these curves, apparently so unlike. If now we would compute the area of a half-segment, we have in the circle and in the hyperbola

$$\begin{aligned} APS &= \int_u^a \sqrt{a^2 - x^2} dx = \frac{1}{2} \left(x \sqrt{a^2 - x^2} + a^2 \int \frac{dx}{\sqrt{a^2 - x^2}} \right)_u^a \\ &= \frac{1}{2} \left(-u \sqrt{a^2 - u^2} + a^2 \int_u^a \frac{dx}{\sqrt{a^2 - x^2}} \right), \end{aligned}$$

$$\begin{aligned} AP'S' &= \int_a^{u'} \sqrt{x^2 - a^2} dx = \frac{1}{2} \left(x \sqrt{x^2 - a^2} - a^2 \int \frac{dx}{\sqrt{x^2 - a^2}} \right)_a^{u'} \\ &= \frac{1}{2} \left(u \sqrt{u^2 - a^2} - a^2 \int_a^{u'} \frac{dx}{\sqrt{x^2 - a^2}} \right), \end{aligned}$$

where $u = OS$ and $u' = OS'$.

Now, in the circle,

$$\frac{1}{2} u \sqrt{a^2 - u^2} = SOP,$$

hence

$$\frac{1}{2} a^2 \int_u^a \frac{dx}{\sqrt{a^2 - x^2}} = AOP;$$

but

$$AOP = \frac{1}{2} a^2 (\angle AOP),$$

hence

$$\int_u^a \frac{dx}{\sqrt{a^2 - x^2}} = \angle AOP = \cos^{-1} \frac{u}{a}.$$

100. Anti-Functions re-defined.—This last equation may be taken as the *definition* of this function, $\cos^{-1} \frac{u}{a}$. True, we have already the notions of cosine and anti-cosine defined for angles; but *if we had no such notions*, neither of cosine nor of anti-cosine nor of angle, this definition would serve us perfectly. Call this integral I for the moment and hold the upper extreme a fast, constant; then I is some function of the lower extreme u , since to any value of either there corresponds a value of the other. Hence

$$I = \psi(u) = \cos^{-1} \frac{u}{a}, \text{ and } \frac{u}{a} = \psi^{-1}(u) = \cos I.$$

If we put $a=1$, we have the cosine of a number, of a definite integral, defined as the lower extreme of that

integral; and it is important to observe that the cosine, the lower extreme of the integral, is a much simpler function than the anti-cosine, the integral itself.

101. Hyperbolic Cosine.—Turning now to the Hyperbola we have

$$\frac{1}{2}u'\sqrt{u'^2-a^2}=S'OP', \text{ hence } \frac{1}{2}a^2\int_a^{u'}\frac{dx}{\sqrt{x^2-a^2}}=AOP'; \text{ or}$$

$$\int_a^{u'}\frac{dx}{\sqrt{x^2-a^2}}=\frac{2\cdot AOP'}{a^2}, \text{ precisely as } \int_u^a\frac{dx}{\sqrt{a^2-x^2}}=\frac{2\cdot AOP}{a^2}.$$

Now we took the second of these Integrals as a *Definition* of a new function, namely, the *anti-cosine* of $\frac{u}{a}$, or a *number* whose cosine is $\frac{u}{a}$. Cosine here means (as we independently know) the ordinary or *circular* cosine, since AOP is a sector of a circle. But AOP' is a sector of a (rectangular) hyperbola; accordingly, we must, or at least we may, consistently *name* the first Integral, $\int_a^{u'}\frac{dx}{\sqrt{x^2-a^2}}$, the *hyperbolic anti-cosine* of $\frac{u'}{a}$, that is, a number whose *hyperbolic* cosine is $\frac{u'}{a}$, and we may write it thus:

$$\int_a^{u'}\frac{dx}{\sqrt{x^2-a^2}}=hc^{-1}\frac{u'}{a}.$$

Calling this Integral I' we have

$$\frac{u'}{a}=hcI'; \text{ and for } a=1, u'=hcI'.$$

102. Hyperbolic Sine.—Similarly we generate the concept of *hyperbolic sine*, thus:

Consider the conjugate rectangular hyperbola,

$$x^2-y^2=-a^2, \text{ or } y^2=x^2+a^2.$$

The area of the quadrilateral $OBQV'$ is

$$\int_0^u \sqrt{x^2 + a^2} dx = \frac{1}{2} \left(u\sqrt{u^2 + a^2} + a^2 \int_0^u \frac{dx}{\sqrt{x^2 + a^2}} \right).$$

Now $\frac{1}{2}u\sqrt{u^2 + a^2} = OQ'V'$;

hence $\frac{1}{2}a^2 \int_0^u \frac{dx}{\sqrt{x^2 + a^2}} = \text{hyp. sect. } OQ'B,$

or $\int_0^u \frac{dx}{\sqrt{x^2 + a^2}} = \frac{2 \cdot OQ'V'}{a^2}.$

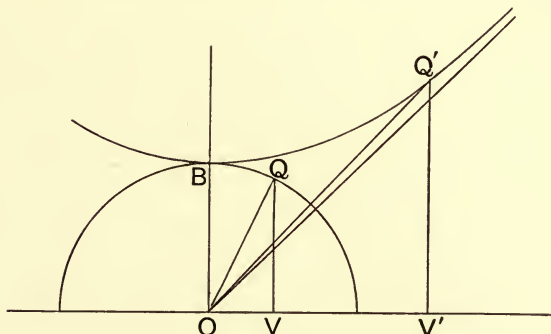

FIG. 17.

Similarly in the circle $x^2 + y^2 = a^2$ we have

$$OBQV = \int_0^u \sqrt{a^2 - x^2} dx = \frac{1}{2} \left(u\sqrt{a^2 - u^2} + a^2 \int_0^u \frac{dx}{\sqrt{a^2 - x^2}} \right);$$

$$\frac{1}{2}u\sqrt{a^2 - u^2} = OQV;$$

hence

$$\frac{1}{2}a^2 \int_0^u \frac{dx}{\sqrt{a^2 - x^2}} = \text{cir. sect. } OBQ, \text{ or } \int_0^u \frac{dx}{\sqrt{a^2 - x^2}} = \frac{2 \cdot OBQ}{a^2}.$$

103. Anti-hyper-functions.—We may now name this latter Integral (circular) *anti-sine* of $\frac{u}{a}$ and write it $\sin^{-1} \frac{u}{a}$; the Integral then is the analytic definition of this new function, anti-sine, while its value, the quotient

of the double sector by the squared radius, is the *geometric* definition of the same function. Herein there is implied no previous knowledge of sines, anti-sines, or angles. If now we would be consistent, we must name the corresponding Integral, $\int_0^u \frac{dx}{\sqrt{x^2+a^2}} = \frac{2 \cdot OBQ'}{a^2}$, the *hyperbolic*

anti-sine of $\frac{u}{a}$, and write it $I' = \text{hs}^{-1} \frac{u'}{a}$. This is another new function, named from analogy, and has two equivalent definitions, one analytic and one geometric. For $a=1$ we have

$$\int_0^{u'} \frac{dx}{\sqrt{1+x^2}} = \text{hs}^{-1} u' = 2OBP' = I'; \text{ or } u' = \text{hs } I'.$$

104. The Arguments Pure Numbers.—From the foregoing it would seem clear that these hyperbolic functions, sine, cosine, anti-sine, anti-cosine, are quite analogous to the ordinary (circular) sine, etc., and have like importance for pure analysis. If now it be asked, what *are* these magnitudes, circular anti-sine and hyperbolic anti-sine of $\frac{u}{a}$, the answer must be that they are *pure numbers*, completely defined by their definitions, analytic and geometric, and *this is enough*. It turns out, to be sure, that the first, circ. $\sin^{-1} \frac{u}{a}$, is the *same* number as the (natural) metric number of the angle POB , and of the arc PB ; hence the first Integral I may be interpreted geometrically as an angle or as a circular arc. This, however, is a circumstance quite extrinsic to the nature of anti-sine as now defined, and we must not expect to find its analogue in the hyperbolic anti-sine, which must *not* be understood as the metric number of the angle $Q'OB$.

105. Relations of the Functions.—The real relation subsisting between the circular and the hyperbolic

functions is of another and very different nature, which may be thus exhibited:

$$\int_v^1 \frac{dx}{\sqrt{x^2-1}} = hc^{-1}v = J; \quad \therefore v = hcJ.$$

Multiply both terms of the fraction by i , remembering $ii = -1$;

$$\therefore i \int_v^1 \frac{dx}{\sqrt{1-x^2}} = i \cos^{-1}v = J; \quad \therefore v = \cos \frac{J}{i} = \cos iJ^*;$$

$$\therefore hcJ = \cos \frac{J}{i} = \cos iJ.$$

Again,
$$\int_0^v \frac{dx}{\sqrt{1+x^2}} = hs^{-1}v = J; \quad \therefore v = hsJ.$$

Change x into iy , then v changes into v/i , and

$$i \int_0^{v/i} \frac{dy}{\sqrt{1-y^2}} = i \sin^{-1}v/i = J; \quad \therefore v = i \sin J/i = -i \sin iJ;$$

$$\therefore hsJ = i \sin J/i = -i \sin iJ.$$

Thus it appears that the hyperbolic functions equal corresponding circular functions of imaginary angles, but are themselves real.

106. Exponentials.—Now we have these expressions for sine and cosine in terms of imaginary exponentials:

$$\cos x = \frac{1}{2}(e^{ix} + e^{-ix}), \quad \sin x = \frac{1}{2i}(e^{ix} - e^{-ix});$$

whence we have for the hyperbolic functions:

$$hc x = \frac{1}{2}(e^x + e^{-x}), \quad hs x = \frac{1}{2}(e^x - e^{-x}),$$

the most convenient definitions of these functions. The equivalent series are worth noting:

$$hc x = 1 + \frac{x^2}{2} + \frac{x^4}{4} + \frac{x^6}{6} + \dots,$$

$$hs x = x + \frac{x^3}{3} + \frac{x^5}{5} + \frac{x^7}{7} + \dots$$

* Since $\frac{J}{i} = -iJ$ and $\cos(-iJ) = \cos(iJ)$, the cosine being an *even* function. Similarly for the sine, which however is an *odd* function.

differing from the series for cosine and sine only in the signs of the even terms.

107. Other Hyper-Functions.—We now define the other hyperbolic functions thus:

$$\operatorname{ht} x = \frac{\operatorname{hs} x}{\operatorname{hc} x} = \frac{e^x - e^{-x}}{e^x + e^{-x}}, \quad \operatorname{hct} x = \frac{1}{\operatorname{ht} x} = \frac{\operatorname{hc} x}{\operatorname{hs} x} = \frac{e^x + e^{-x}}{e^x - e^{-x}};$$

$$\operatorname{hsc} x = \frac{1}{\operatorname{hc} x}, \quad \operatorname{hesc} x = \frac{1}{\operatorname{hs} x}.$$

Now let the student prove:

1. $\overline{\operatorname{hc} x^2} - \overline{\operatorname{hs} x^2} = 1$, $\overline{\operatorname{ht} x^2} = 1 - \overline{\operatorname{hsc} x^2}$.
2. $D \operatorname{hs} x = \operatorname{hc} x$, $D \operatorname{hc} x = \operatorname{hs} x$.
3. $D \operatorname{ht} x = \overline{\operatorname{hsc} x^2} = 1 - \overline{\operatorname{ht} x^2} = 1/\overline{\operatorname{hc} x^2}$.
4. $D \operatorname{hsc} x = -\operatorname{hsc} x \cdot \operatorname{ht} x$.
5. $\operatorname{hs}(x \pm y) = \operatorname{hs} x \operatorname{hc} y \pm \operatorname{hc} x \operatorname{hs} y$.
6. $\operatorname{hc}(x \pm y) = \operatorname{hc} x \operatorname{hc} y \pm \operatorname{hs} x \operatorname{hs} y$.
7. $\operatorname{ht}(x \pm y) = (\operatorname{ht} x \pm \operatorname{ht} y)/(1 \pm \operatorname{ht} x \operatorname{ht} y)$.
8. The period of hs and hc is $2i\pi$, of ht and hct it is $i\pi$.
9. The hc and hsc are *even* functions, the others are *odd*.
10. Changing the argument by the half-period reverses hs and hc ; *i.e.*, $\operatorname{hs}(x \pm i\pi) = -\operatorname{hs} x$, $\operatorname{hc}(x \pm i\pi) = -\operatorname{hc} x$.
11. Hyperbolic sines of supplemental arguments are the same. Hyperbolic cosines of supplemental arguments are counter;

$$\textit{i.e.}, \operatorname{hs}(i\pi - x) = \operatorname{hs} x, \operatorname{hc}(i\pi - x) = -\operatorname{hc} x.$$

$$12. \operatorname{hs}(2x) = 2 \operatorname{hs} x \cdot \operatorname{hc} x; \operatorname{hc}(2x) = \overline{\operatorname{hc} x^2} + \overline{\operatorname{hs} x^2};$$

$$\operatorname{ht}(2x) = 2 \operatorname{ht} x / (1 + \overline{\operatorname{ht} x^2}).$$

$$13. \operatorname{hs} x + \operatorname{hs} y = 2 \operatorname{hs} \frac{x+y}{2} \cdot \operatorname{hc} \frac{x-y}{2},$$

and corresponding *prosthapheretic* formulae.

$$14. \operatorname{L} \int_{x=0}^x \frac{\operatorname{hs} x}{x} = \operatorname{L} \int_{x=0}^x \frac{\operatorname{ht} x}{x} = 1.$$

Hence it appears that the doctrines of circular and hyperbolic functions stand on equal footing and supplement each other.

108. Gudermannians.—We know that we may write the equation of the circle $x^2 + y^2 = a^2$, by use of a third independent variable θ , thus: $x = a \cos \theta$, $y = a \sin \theta$. This

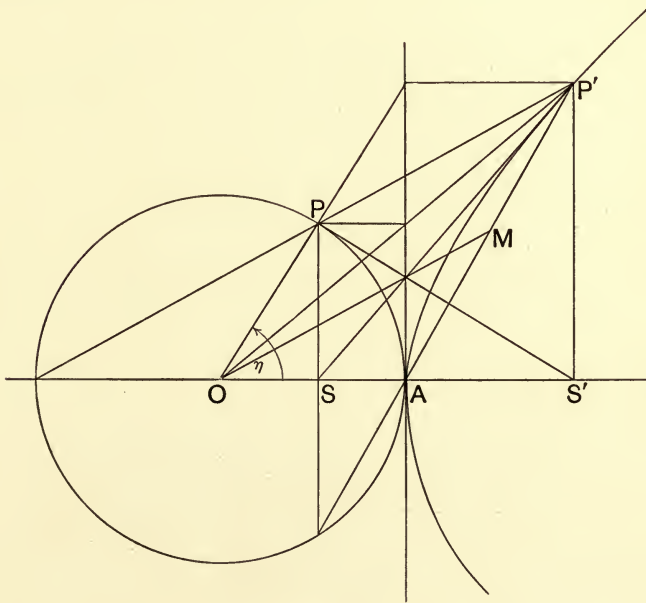

FIG. 18.

depends on the fact that $(\cos \theta)^2 + (\sin \theta)^2 = 1$. Similarly, since $\overline{\operatorname{hc} u^2} - \overline{\operatorname{hs} u^2} = 1$, we may write the equation of the rectangular hyperbola $x^2 - y^2 = a^2$ thus: $x = a \operatorname{hc} u$, $y = a \operatorname{hs} u$. Here u is the third independent variable, but is not an

arc, nor an angle, like θ . However, it stands related to the sector-area precisely as θ does; for

$$\frac{1}{2}a^2\theta = \text{circ. sect. } AOP \text{ and } \frac{1}{2}a^2u = \text{hyp. sect. } AOP'.$$

Moreover, it is remarkably related to an angle, for draw $S'P$ tangent to the circle at P , denote $\angle AOP$ by η , and we have $x = a \sec \eta$, $y = a \tan \eta$ as equations of the hyperbola $x^2 - y^2 = a^2$, this depending on the fact that

$$\overline{\sec \eta}^2 - \overline{\tan \eta}^2 = 1.$$

Comparing the values of x and also those of y we see

$$\text{hc } u = \sec \eta, \quad \text{hs } u = \tan \eta.$$

So it appears that u and η are functions of each other, and the relation between them having been especially studied by *Gudermann* it is proposed by Cayley to call η the *Gudermannian* of u and write $\eta = \text{gd } u$, whence $u = \text{gd}^{-1}\eta$. We may also call η *hyperbolic amplitude* of u : $\eta = \text{amh } u$, whence $u = \text{amh}^{-1}\eta$.

109. Geometric Property.—We have now

$$e^u = \text{hc } u + \text{hs } u = \sec \eta + \tan \eta,$$

whence, on passing to logarithms and reducing,

$$u = \log \tan \left(\frac{\pi}{4} + \frac{\eta}{2} \right).$$

We have also

$$\text{hc } u = \frac{1 + \left(\text{ht} \frac{u}{2} \right)^2}{1 - \left(\text{ht} \frac{u}{2} \right)^2}, \quad \text{and} \quad \sec \eta = \frac{1 + \left(\tan \frac{\eta}{2} \right)^2}{1 - \left(\tan \frac{\eta}{2} \right)^2};$$

or, since

$$\text{hc } u = \sec \eta,$$

$$\text{ht} \frac{u}{2} = \tan \frac{\eta}{2}.$$

The geometric significance of this result is that the same ray OM that halves the angle η , and therewith the circular sector AOP , halves also the hyperbolic sector AOP' , and therewith the chord AP' and so is the diameter conjugate

to the chord. For draw two rays from O , the one bisecting the circular sector, the other bisecting the hyperbolic sector; their equations are $y/x = \tan \eta/2$, and $y/x = \text{ht } \frac{u}{2}$; these two values of y/x are equal, hence the two rays are the same.

Exercise.—Tangents at P , P' and A concur with OM .

110. Ellipse and Hyperbola.—We derive the Ellipse $\frac{x^2}{a^2} + \frac{y^2}{b^2} = 1$ from the circle $\frac{x^2}{a^2} + \frac{y^2}{a^2} = 1$, and the Hyperbola $\frac{x^2}{a^2} - \frac{y^2}{b^2} = 1$, from the rectangular hyperbola $\frac{x^2}{a^2} - \frac{y^2}{a^2} = 1$, by merely shortening all their y 's in the ratio $b:a$; hence the equations of E and H are $x = a \cos \theta$, $y = b \sin \theta$, and $x = a \text{hc } u$, $y = b \text{hs } u$. The angle θ is called the *eccentric anomaly* of the point P in the Ellipse; by analogy we may call the number u the *hyperbolic eccentric anomaly* of P' in the Hyperbola.

Manifestly the areas of corresponding parts in circle and ellipse, in rectangular hyperbola and general hyperbola, will be in the constant ratio $a:b$; hence the area of the elliptic sector corresponding to θ is $\frac{1}{2}ab\theta$, and of the hyperbolic sector corresponding to u it is

$$\frac{1}{2}abu \equiv \frac{1}{2}ab \log \left(\frac{x}{a} + \frac{y}{b} \right).$$

111. Logarithmic Expression.—For $a=b=1$, in the conjugate rectangular Hyperbola $x^2 - y^2 = -1$, we have

$$x = \text{hs } u, \quad y = \text{hc } u = \sqrt{1+x^2};$$

hence $e^u = \text{hc } u + \text{hs } u = x + \sqrt{1+x^2},$

and $u = \text{hs}^{-1}x = \log(x + \sqrt{1+x^2}).$

But $\text{hs}^{-1}x = \int_0^x \frac{dx}{\sqrt{1+x^2}};$

hence

$$\int_0^x \frac{dx}{\sqrt{1+x^2}} = \log(x + \sqrt{1+x^2}), \quad \int_0^x \frac{dx}{\sqrt{a^2+x^2}} = \log(x + \sqrt{a^2+x^2}).$$

These results are useful when for any reason we would avoid the use of hyperbolic functions; they may be readily verified by derivation, and may indeed be obtained by the substitution of $z = x + \sqrt{a^2 + x^2}$, but such a process seems very arbitrary.

Exercise.—Express all the inverse hyperbolic functions through logarithms, as $\text{ht}^{-1}x = \log \sqrt{\frac{1+x}{1-x}}$.

112. Imaginary Integrals.—We have now integrated $\sqrt{a^2 + x^2}$, $\sqrt{a^2 - x^2}$, $\sqrt{x^2 - a^2}$; the remaining form $\sqrt{-a^2 - x^2}$, is reduced to one of the others by taking out the factor i or by putting $x = iu$, but yields a purely imaginary result. We see in fact that if in the general formula for area, $A = \int y dx$, we have $y = \sqrt{-a^2 - x^2}$, then $y^2 + x^2 + a^2 = 0$; whence it appears that the bounding curve is imaginary, with no real points in the plane of x and y .

113. Reduction to Standard forms.—When the radicand is the general quadratic, $Ax^2 + 2Bx + C$, we reduce it to the form of the sum or difference of two squares, $\pm u^2 \pm a^2$, by the substitutions $u = x + \frac{B}{A}$ and $a^2 = \frac{AC - B^2}{A^2}$. For

$$\begin{aligned} Ax^2 + 2Bx + C &= A \left\{ \left(x + \frac{B}{A} \right)^2 + \left(\frac{\sqrt{AC - B^2}}{A} \right)^2 \right\} \\ &= A \left\{ \left(x + \frac{B}{A} \right)^2 - \left(\frac{\sqrt{B^2 - AC}}{A} \right)^2 \right\}. \end{aligned}$$

The first or second form is preferred according as the **Discriminant** $AC - B^2$ is positive or negative. If A be negative, let $A = -A'$; then

$$\begin{aligned} \sqrt{A} \sqrt{u^2 - a^2} &= \sqrt{A'} \sqrt{a^2 - u^2}, \\ \sqrt{A} \sqrt{u^2 + a^2} &= i \sqrt{A'} \sqrt{u^2 + a^2}. \end{aligned}$$

EXERCISES.

1. $\int \frac{dx}{x^2 + x + 1} = \int \frac{d(x + \frac{1}{2})}{(x + \frac{1}{2})^2 + \frac{3}{4}} = \frac{2}{\sqrt{3}} \tan^{-1} \left(\frac{x + \frac{1}{2}}{\sqrt{3}/2} \right) = \frac{2}{\sqrt{3}} \tan^{-1} \frac{2x + 1}{\sqrt{3}}$.
2. $\int \frac{dx}{\sqrt{3x^2 - 5x + 4}} = \frac{1}{\sqrt{3}} \int \frac{d(x - \frac{5}{6})}{\sqrt{(x - \frac{5}{6})^2 + \frac{23}{36}}} = \frac{1}{\sqrt{3}} \operatorname{hs}^{-1} \left(\frac{6x - 5}{\sqrt{23}} \right)$.
3. $\int \frac{dx}{\sqrt{7 + 3x - 2x^2}} = \frac{1}{\sqrt{2}} \int \frac{d(x - \frac{3}{4})}{\sqrt{\frac{65}{16} - (x - \frac{3}{4})^2}} = \frac{1}{\sqrt{2}} \sin^{-1} \frac{4x - 3}{\sqrt{65}}$.
4. $\int \frac{dx}{(x-3)^2}$, $\int \frac{dx}{nx+a}$, $\int \frac{dx}{x^2}$, $\int \frac{dx}{a^2 + b^2x^2}$, $\int \sqrt[3]{x^2} dx$, $\int \frac{3dx}{5\sqrt[3]{x^5}}$,
 $\int (a - bx + cx^2 - dx^3) dx$, $\int \left(\frac{3}{x^3} - \frac{5}{x} + 3x - 7x^3 \right) dx$.
5. $\int \frac{4x^3 - 2x^2 + x - 3}{2^5 \sqrt{x^7}} dx$, $\int (3 + 4x)^3 dx$, $\int (2x^2 - 5x^3)^2 dx$,
 $\int \sqrt[3]{x^2} (\sqrt{x} - 2\sqrt[3]{x}) dx$, $\int \frac{\sqrt[5]{x}}{x} \left(3\sqrt[3]{x^4} - 2\sqrt{x^3} + \frac{2}{\sqrt[3]{x}} \right) dx$.
6. $\int \frac{5x}{3 + 4x} dx$, $\int \frac{2 + 3x}{4 + 12x + 9x^2} dx$, $\int \frac{5x}{(2 - 3x)^2} dx$,
 $\int \frac{3 + 10x}{(2 + 3x + 5x^2)^3} dx$, $\int \frac{x^3}{4(1 - 3x)} dx$, $\int \frac{x^5}{(2 - x)^2} dx$.
7. $\int \frac{dx}{-5 + 6x - x^2}$, $\int \frac{dx}{-x^2 + 6x - 13}$, $\int \frac{dx}{x^2 \pm x + 1}$, $\int \frac{dx}{x^4 - 16}$.
8. $\int \frac{dx}{x^2 - x - 1}$, $\int \frac{x^3}{(2x - 3)^3} dx$, $\int \frac{6}{x^2(6 - 5x)^2} dx$, $\int \frac{x^2 - 1}{x^3 + x} dx$.
9. $\int \frac{dx}{\sqrt{x^2 - 2ax}}$, $\int \frac{dx}{\sqrt{2ax - x^2}}$, $\int \frac{x^{\frac{3}{2}}}{\sqrt{2a - x}} dx$. [Put $x = a + v$.]
10. $\int \frac{dx}{\sqrt{a^2 - b^2x^2}}$, $\int \frac{dx}{a^2 + b^2x}$, $\int \frac{dx}{\sqrt{2abx - b^2x^2}}$, $\int \frac{dx}{\sqrt{b^2x^2 - 2abx}}$.

114. Powers of Sine and Cosine.—Integrating $(\cos x)^2$ and $(\sin x)^2$ by parts we have found,

$$\int (\cos x)^2 dx = \frac{1}{2}(x + \sin x \cos x), \quad \int (\sin x)^2 dx = \frac{1}{2}(x - \sin x \cos x).$$



The same method avails for higher integral powers, thus :

$$\begin{aligned} \int (\cos x)^n dx &= \int (\cos x)^{n-1} d(\sin x) \\ &= \sin x (\cos x)^{n-1} + (n-1) \int (\cos x)^{n-2} (\sin x)^2 dx \\ &= \sin x (\cos x)^{n-1} + (n-1) \int (\cos x)^{n-2} dx - (n-1) \int (\cos x)^n dx ; \\ \therefore \int (\cos x)^n dx &= \frac{1}{n} \{ \sin x (\cos x)^{n-1} + (n-1) \int (\cos x)^{n-2} dx \}. \quad (A) \end{aligned}$$

By this *Recursion-formula* we lower the exponent by 2; by repetition we may lower it to 1 if n be odd, or to 0 if n be even; in either case the integral is reduced to an elementary form.

The same formula may serve to raise the exponent by 2; we have but to change n into $m+2$ and solve the equation as to the second integral; then

$$\begin{aligned} \int (\cos x)^m dx \\ &= -\frac{1}{m+1} \{ \sin x (\cos x)^{m+1} - (m+2) \int (\cos x)^{m+2} dx \}. \dots (A') \end{aligned}$$

By repeated application we may raise an even negative exponent to 0, or an odd one to -1 ; but here we must pause, since for $m = -1$ we have $m+1=0$, and division by 0 has no sense; $\int \frac{dx}{\cos x}$ calls for special treatment.

Exercise.—Integrate similarly $(\sin x)^n$ and $(\sin x)^{-m}$.

115. Secant and Cosecant.—To integrate $\frac{1}{\cos x}$ we first integrate $\frac{1}{\sin x}$, thus;

Put $x=2u$; then

$$\int \frac{dx}{\sin x} = \int \frac{du}{\sin u \cos u} = \int \frac{(\sec u)^2 du}{\tan u} = \log \tan u = \log \tan \frac{x}{2}.$$

$$\int \frac{dx}{\cos x} = - \int \frac{d\left(\frac{\pi}{2} - x\right)}{\sin\left(\frac{\pi}{2} - x\right)} = - \log \tan\left(\frac{\pi}{4} - \frac{x}{2}\right) = \log \tan\left(\frac{\pi}{4} + \frac{x}{2}\right).$$

The devices here employed are very often useful.

Exercise.—Integrate $1/\cos x$ by the substitution $x = 2u$.

116. Odd Powers.—Other methods may be preferred in special cases. Thus, to integrate an *odd* positive power of the cosine we have

$$\int (\cos x)^{2p+1} dx = \int (\cos x)^{2p} \cos x dx = \int (1 - \sin^2 x)^p d(\sin x);$$

Now we expand the integrand and integrate its terms as to $\sin x$.

Exercise.—Integrate $\overline{\cos x^3}$, $\overline{\sin x^5}$, $\overline{\cos x^3 \sin x^4}$, $\overline{\cos x^4 \sin x^5}$; show how to integrate $\overline{\sin x^m \cos x^n}$, either m or n being odd.

117. Even Powers.—In case of only *even* powers we may use the *double angle*

$$2 \overline{\cos x^2} = 1 + \cos 2x, \quad 2 \overline{\sin x^2} = 1 - \cos 2x;$$

and we may reduplicate the angle until an *odd* power is attained, thus:

$$\begin{aligned} \int \overline{\cos x^6} dx &= \frac{1}{16} \int (1 + \cos 2x)^3 d2x \\ &= \frac{1}{16} \int (1 + 3 \cos 2x + 3 \overline{\cos 2x^2} + \overline{\cos 2x^3}) d(2x). \end{aligned}$$

All of the terms in () are now easily integrable as to $2x$. We may proceed thus with any product of positive even powers of sine and cosine, but the method is scarcely preferable to that of *recursion*.

Exercise.—Integrate $\overline{\cos x^4}$, $\overline{\sin x^6}$, $\overline{\sin x^4 \cos x^4}$, $\overline{\sin x^4 \cos x^6}$.

118. Powers of the *tangent* are integrated by *recursion*.

$$\begin{aligned}\int \overline{\tan x^n} dx &= \int \overline{\tan x^{n-2}(\sec x^2 - 1)} dx \\ &= \frac{1}{n-1} \overline{\tan x^{n-1}} - \int \overline{\tan x^{n-2}} dx.\end{aligned}$$

So we sink the exponent to 1 for n odd, to 0 for n even.

Exercise.—Integrate $\overline{\cot x^n}$ by two methods; also $\overline{\tan x^6}$, $\overline{\tan x^7}$.

119. **Special Integral.**—A very important integral is

$$\int \frac{dx}{a+b \cos x}$$

For $x=2u$,

$$\begin{aligned}\int &= 2 \int \frac{du}{a(\cos u^2 + \sin u^2) + b(\cos u^2 - \sin u^2)} \\ &= 2 \int \frac{du}{(a+b)\cos u^2 + (a-b)\sin u^2} = \frac{2}{a-b} \int \frac{\sec u^2 du}{\frac{a+b}{a-b} + \tan u^2} \\ &= \frac{2}{\sqrt{a^2-b^2}} \tan^{-1} \sqrt{\frac{a-b}{a+b}} \tan \frac{x}{2}, \text{ if } a > b.\end{aligned}$$

If $a < b$, show that $\int = \frac{2}{\sqrt{b^2-a^2}} \text{ht}^{-1} \sqrt{\frac{b-a}{b+a}} \tan \frac{x}{2}$.

If $a=b$, show that $\int = ?$

Exercises.—1. Prove

$$\int \frac{dx}{a+b \cos x} = \frac{1}{\sqrt{a^2-b^2}} \cos^{-1} \frac{a \cos x + b}{a+b \cos x},$$

$$\text{or} = \frac{1}{\sqrt{b^2-a^2}} \text{hc}^{-1} \frac{a \cos x + b}{a-b \cos x}, \text{ or} = \frac{1}{\sqrt{b^2-a^2}} \log \frac{\sqrt{b+a} + \sqrt{b-a} \tan \frac{x}{2}}{\sqrt{b+a} - \sqrt{b-a} \tan \frac{x}{2}}$$

2. Integrate $\frac{1}{a+b \sin x}$, $\frac{1}{a+b \text{hc } x}$, $\frac{1}{a+ \text{hs } x}$.

120. A more general integral is $\int \frac{dx}{a + b \cos x + c \sin x}$.

We reduce this to the form in Art. 119 by putting

$$b = r \cos a, \quad c = r \sin a,$$

$$\begin{aligned} \therefore a + b \cos x + c \sin x &= a + r(\cos x \cos a + \sin x \sin a) \\ &= a + r \cos(x - a). \end{aligned}$$

Similarly, when $hc x$ and $hs x$ supplace $\cos x$ and $\sin x$.

Exercise.—Integrate

$$1/(2 + 3 \cos x + 4 \sin x) \quad \text{and} \quad 1/(3 + 4 hc x + 3 hs x).$$

121. Functions of *multiple* angles are easily integrated.

$$\int \cos mx \, dx = \frac{1}{m} \int \cos mx \, d(mx) = \frac{1}{m} \sin mx.$$

Products of sine and cosine of multiple angles must be transformed into sums by the *prosthapheretic* formulae,

$$\int \sin mx \cos nx \, dx = \frac{1}{2} \int \{ \sin(m+n)x + \sin(m-n)x \} dx.$$

Exercise.—Integrate

$$\sin mx, \quad \cos 3x \sin 5x, \quad \cos 2x \cos 4x, \quad \sin 3x \sin 2x.$$

The more general problem of integrating any quotient of rational functions of sine and cosine, $\frac{f(\cos x, \sin x)}{\phi(\cos x, \sin x)}$, is waived for the present, as is also the problem of rationalizing or reducing certain other forms, particularly *binomials*, such as $x^m(a + bx^n)^{p/q}$.

122. **Simple Fractions.**—The integrands $\frac{1}{x-a}, \frac{1}{(x-a)^n}$, which present themselves very frequently, are recognized at once as the derivatives of

$$\log(x-a) \quad \text{and} \quad -\frac{1}{n-1} \cdot \frac{1}{(x-a)^{n-1}};$$

these latter are then the integrals of the former:

$$\int \frac{dx}{x-a} = \log(x-a), \quad \int \frac{dx}{(x-a)^n} = -\frac{1}{n-1} \cdot \frac{1}{(x-a)^{n-1}}.$$

When the denominator is a quadratic we have

$$\begin{aligned}\int \frac{bx+c}{x^2+a^2} dx &= \frac{b}{2} \int \frac{2x}{x^2+a^2} dx + c \int \frac{dx}{x^2+a^2} \\ &= b \log \sqrt{x^2+a^2} + \frac{c}{a} \tan^{-1} \frac{x}{a}.\end{aligned}$$

$$\begin{aligned}\int \frac{bx+c}{(x^2+a^2)^n} dx &= \frac{b}{2} \int \frac{2x dx}{(x^2+a^2)^n} + c \int \frac{dx}{(x^2+a^2)^n} \\ &= -\frac{b}{2(n-1)(x^2+a^2)^{n-1}} + c \int \frac{dx}{(x^2+a^2)^n}.\end{aligned}$$

To find this last \int , put $x = a \tan \phi$, $dx = a \sec^2 \phi \cdot d\phi$; then $\int \frac{dx}{(x^2+a^2)^n} = \frac{1}{a^{2n-1}} \int \cos^2 \phi^{2n-2} d\phi$ — a known form. If the numerator contained higher powers of x even up to x^{2n-1} , the same would answer, yielding lower powers of $\cos \phi$.

Exercises.—Integrate $\frac{2}{x-3}$, $\frac{3}{4-x}$, $\frac{6}{(x-5)^2}$, $\frac{2x^3-x^2+3x-4}{(x^2+2)^3}$.

123. The simple integrations of Art. 122 prepare us to attack the general problem of integrating **Rational Algebraic Functions** of the argument. Such a function is the quotient of two entire functions of the argument, as $\frac{f(x)}{\phi(x)}$, and we may suppose $f(x)$ of lower degree than $\phi(x)$; for if it were not, by division we could at once make it so. This fraction $f(x)/\phi(x)$ we now break up by known algebraic methods (see Appendix) into **part-fractions** of the forms $\frac{A}{(x-a)^n}$ and $\frac{Bx+c}{(x^2 \pm 2bx+c)^n}$. The first we integrate as in Art. 122; the second presents itself only when $c-b^2 > 0$, *i.e.*, when the factors of $x^2 \pm 2bx+c$ are imaginary. In that case we put $x \pm b = u$, $c-b^2 = a^2$, and get $\frac{Bu+c \pm bB}{(u^2+a^2)^n}$ which is of the form $\frac{bx+c}{(x^2+a^2)^n}$, integrated in Art. 122. All such rational fractions may thus be integrated.

124. Irrational Quadratics.—We have learned to integrate rational functions of x and also the radical $\sqrt{S} = \sqrt{Ax^2 + 2Bx + C}$; the question is natural: *What combinations of x and \sqrt{S} can we integrate?* The most general form of any rational function of the two is

$$\frac{R + T\sqrt{S}}{U + V\sqrt{S}}, \text{ which } = \frac{UR - VTS + (UT - RV)\sqrt{S}}{U^2 - V^2S} = \frac{W + X\sqrt{S}}{Y}$$

$$= \frac{W}{Y} + \frac{XS}{Y\sqrt{S}};$$

where the large letters are entire functions of x . The fraction $\frac{W}{Y}$ we integrate by Art. 123. The

fraction $\frac{XS}{Y\sqrt{S}}$ we break up on dividing by Y into $\frac{E}{\sqrt{S}}$ and $\frac{f(x)}{\phi(x)\sqrt{S}}$, where E is an entire function of x , and $f(x)$ is of

lower degree than $\phi(x)$. Let the highest term in E be Hx^h ; then on integrating by parts we can make $\int \frac{x^h dx}{\sqrt{S}}$

depend on $\int \frac{x^{h-1} dx}{\sqrt{S}}$, and by repeating the process we can make the integral finally depend on $\int \frac{dx}{\sqrt{S}}$ —a known form;

so $\frac{E}{\sqrt{S}}$ is integrable.

The proper fraction $f(x)/\phi(x)$ we break up as before into part-fractions of the forms $\frac{L}{(x-a)^n}$ and $\frac{Mx+N}{(A'x^2 + 2B'x + c')^p}$,

where $A'C' > B'^2$. To effect the integration $\int \frac{dx}{(x-a)^n \sqrt{S}}$

it suffices to put $x-a = \frac{1}{v}$; then S turns into Q/v^2 , where Q is a quadratic in v , dx turns into $-dv/v^2$, and the integral becomes $-\int \frac{v^{n-1} dv}{\sqrt{Q}}$, the form just treated.

In dealing with $\int \frac{Mx+N}{S^p \sqrt{S}} dx$, it is best to reduce S and S' simultaneously to the form of the sum or difference of two

squares, by the substitution

$$x = \frac{l + mz}{1 + z}.$$

The coefficients of the first powers of z in the transformed expressions of S and S' are

$$Alm + B(l+m) + C \quad \text{and} \quad A'lm + B'(l+m) + C'.$$

These we equate to zero, and thence determine first lm and $l+m$, then l and m . On carrying out the substitution our integral takes the form $\int \frac{\Sigma dz}{(z^2 + a'^2)^p \sqrt{\pm z^2 \pm a^2}}$, where Σ is a sum of powers of z lower than the $2p^{\text{th}}$. Integrating by parts we may now lower the exponent of $(z^2 + a'^2)$ down to 1; so that our \int is made finally to depend on one of three so-called **Normal Integrals**:

$$\begin{aligned} \text{(I.)} \int \frac{dz}{(z^2 + a'^2)\sqrt{z^2 + a^2}}, \quad \text{(II.)} \int \frac{dz}{(z^2 + a'^2)\sqrt{z^2 - a^2}}, \\ \text{(III.)} \int \frac{dz}{(z^2 + a'^2)\sqrt{a^2 - z^2}}. \end{aligned}$$

To effect these integrations we must pass over either to circular or to hyperbolic functions, thus:

Let $z = a \operatorname{hs} u$; then

$$dz = a \operatorname{hc} u du, \quad \sqrt{z^2 + a^2} = a \operatorname{hc} u, \quad z^2 + a'^2 = a^2 \overline{\operatorname{hs} u^2} + a'^2;$$

hence

$$\begin{aligned} \text{(I.)} \int &= \int \frac{du}{a'^2 + a^2 \overline{\operatorname{hs} u^2}} = \int \frac{d(\operatorname{ht} u)}{a'^2 + (a^2 - a'^2) \operatorname{ht} u^2} \\ &= \frac{1}{a' \sqrt{a^2 - a'^2}} \tan^{-1} \left(\frac{\sqrt{a^2 - a'^2}}{a'} \cdot \operatorname{ht} u \right), \end{aligned}$$

if $a^2 > a'^2$.

Exercises.—1. Putting $z = a \tan \phi$, show that

$$\text{(I.)} \int = \frac{1}{a' \sqrt{a^2 - a'^2}} \tan^{-1} \frac{z \sqrt{a^2 - a'^2}}{a' \sqrt{a^2 + z^2}}, \quad \text{or} \quad \frac{1}{a'^2} \cdot \frac{z}{\sqrt{a^2 + z^2}},$$

or
$$\frac{1}{2a'\sqrt{a'^2 - a^2}} \log \frac{a'\sqrt{a'^2 + z^2} + \sqrt{a'^2 - a^2}}{a'\sqrt{a'^2 + z^2} - \sqrt{a'^2 - a^2}},$$

according as $a^2 > a'^2$, or $a^2 = a'^2$, or $a^2 < a'^2$.

2. Putting $z = a \sec \phi$ and $z = a \sin \phi$, show that

$$(II.) \int = \frac{1}{2a'\sqrt{a'^2 + a^2}} \log \frac{z\sqrt{a'^2 + a^2} + a'\sqrt{z^2 - a^2}}{z\sqrt{a'^2 + a^2} - a'\sqrt{z^2 - a^2}}.$$

$$(III.) \int = \frac{1}{a'\sqrt{a'^2 + a^2}} \tan^{-1} \frac{z\sqrt{a'^2 + a^2}}{a'\sqrt{a^2 - z^2}}.$$

3. Integrate (II.) by $z = hc u$, and (III.) by $z = a \cos \phi$, $z = a \operatorname{ht} u$.

It appears that a rational function of x and \sqrt{S} is always integrable in terms of algebraic, logarithmic, circular and hyperbolic functions. The foregoing argument seems the simplest to *prove the integrability*; but the process indicated may not be the simplest for actually finding the integral.

125. Higher Functions.—Thus far the only radicands we have attempted have been of second degree, of the type, $S = Ax^2 + 2Bx + C$. In case the radicand is of first degree, $F = Ax + B$, it suffices to put $u = \sqrt{Ax + B}$; then $A dx = 2u du$, and any rational function of x and \sqrt{F} may be rationalized in u by this substitution. But the student may naturally inquire: what if the radicand be of third degree, as $T \equiv Ax^3 + 3Bx^2 + 3Cx + D$? where without loss of generality we may suppose $B = 0$.

The answer is that, precisely as the irreducible form $\int \frac{dx}{\sqrt{S}}$ gave rise to certain *simply periodic* circular and hyperbolic functions, of some of which indeed we already had knowledge, but which we defined through these integrals quite independently of any such previous knowledge, so the irreducible form $\int \frac{dx}{\sqrt{T}}$ gives rise to a new

class of functions, the **Elliptic** or **Doubly Periodic**, of supreme importance in Higher Analysis. We may write

$$u = \int_y^\infty \frac{dx}{\sqrt{4(x-e_1)(x-e_2)(x-e_3)}} = \int_y^\infty \frac{dx}{\sqrt{T(x)}}$$

Here y and u are plainly functions of each other, but exactly as the sine is a simpler function than the anti-sine in

$$I = \int_0^y \frac{dx}{\sqrt{1-x^2}} = \sin^{-1}y, \quad y = \sin I,$$

so the lower extreme y is here also a simpler function of the integral u than u is of the lower extreme y ; accordingly we write, following Weierstrass,

$$y = \wp(u), \quad u = \int_{\wp(u)}^\infty \frac{dx}{\sqrt{T(x)}}$$

The theory of the \wp -function cannot even be broached in this elementary work.

Exercise.—Show that $\wp'(u) + \sqrt{T(\wp u)} = 0$.

Hint: Deriving as to the lower extreme $\wp(u)$ we get

$$\frac{du}{d\wp} = -\frac{1}{\sqrt{T(\wp u)}}$$

whence, on inverting and transposing, $\wp' + \sqrt{T(\wp)} = 0$.

We may write $T(\wp) \equiv 4(\wp - e_1)(\wp - e_2)(\wp - e_3) \equiv 4\wp^3 - g_2\wp - g_3$, as is common, without loss of generality. Now show that

$$\wp'' = 6\wp^2 - \frac{1}{2}g_2, \quad \wp''' = 12\wp\wp'.$$

126. Exponentials and Trigonometric Functions.—Combinations of circular or hyperbolic with logarithmic or exponential functions or integral powers of the argument of integration will often yield to integration by parts, as

$$\int x^n \log x^m dx = \frac{1}{n+1} \left(x^{n+1} \log x^m - m \int x^n \log x^{m-1} dx \right),$$

$$\int x^n e^x dx = x^n e^x - n \int x^{n-1} e^x dx,$$

$$\int x^n e^{mx} dx = \frac{1}{m^{n+1}} \int (mx)^n e^{mx} d(mx) = \text{the foregoing form.}$$

$$\begin{aligned} \int e^x \cos x dx &= e^x \sin x - \int e^x \sin x dx \\ &= e^x \sin x + e^x \cos x - \int e^x \cos x dx, \end{aligned}$$

$$\therefore \int e^x \cos x dx = \frac{1}{2} e^x (\sin x + \cos x).$$

We may proceed similarly with many such forms.

127. Illustrations.—We shall now exemplify the foregoing methods:

1. $\int \frac{3x+2}{(x-1)(x-2)(x-3)} dx$. Decompose into part-fractions

$$\frac{3x+2}{D} \equiv \frac{A}{x-1} + \frac{B}{x-2} + \frac{C}{x-3};$$

$$3x+2 \equiv A \frac{D}{x-1} + B \frac{D}{x-2} + C \frac{D}{x-3}.$$

Put x in turn = 1, 2, 3; thence in turn

$$5 = 2A, \quad 8 = -B, \quad 11 = 2C;$$

whence

$$\begin{aligned} \int &= \frac{5}{2} \log(x-1) - 8 \log(x-2) + \frac{11}{2} \log(x-3) \\ &= \log \frac{(x-1)^{\frac{5}{2}} (x-3)^{\frac{11}{2}}}{(x-2)^8}. \end{aligned}$$

2. $\int \frac{5x^3-2}{x^4-8x^3+18x^2-27} dx$. The denominator

$$D = (x+1)(x-3)^3,$$

$$\frac{5x^3-2}{D} \equiv \frac{A}{(x-3)^3} + \frac{A'}{(x-3)^2} + \frac{A''}{(x-3)} + \frac{B}{x+1},$$

$$5x^3-2 \equiv \frac{A \cdot D}{(x-3)^3} + \{x-3\}^*;$$

for $x=3$, $133 = A4$, $A = \frac{133}{4}$.

* $\{x-3\}$ means terms containing $x-3$ as factor.

Substitute for A , transpose, and divide by $x-3$;

$$\therefore \frac{1}{4}(20x^2+60x+47) \equiv \frac{A' \cdot D}{(x-3)^3} + \{x-3\}_2;$$

for $x=3$, $\frac{4 \cdot 0 \cdot 7}{4} = A' \cdot 4$; $A' = \frac{4 \cdot 0 \cdot 7}{16}$.

Substitute for A' , transpose, and divide by $x-3$;

$$\therefore \frac{1}{16}(80x+73) \equiv \frac{A'' \cdot D}{(x-3)^3} + \{x-3\}_3; \text{ for } x=3, A'' = \frac{3 \cdot 1 \cdot 3}{6 \cdot 4}.$$

To find B , put $x+1=0$, or $x=-1$;

$$\therefore 5x^3-2 \equiv \frac{B \cdot D}{x+1} + \{x+1\}, \text{ or } -7 = B(-64), B = \frac{7}{64}.$$

Note that the multiplier of all the A 's is the same, namely, $D/(x-3)^3 \equiv x+1$.

$$\int = -\frac{133}{8(x-3)^2} - \frac{407}{16(x-3)} + \frac{64}{313} \log(x-3) + \frac{7}{64} \log(x+1).$$

$$3. \int \frac{x^5+4}{(x^2-2x+2)^3} dx = \int \frac{(u+1)^5+4}{(u^2+1)^3} du, \text{ if } u=x-1.$$

$$\frac{(u+1)^5+4}{(u^2+1)^3} \equiv \frac{Au+B}{(u^2+1)^3} + \frac{A'u+B'}{(u^2+1)^2} + \frac{A''u+B''}{(u^2+1)},$$

$$(u+1)^5+4 \equiv Au+B+(A'u+B')(u^2+1)+(A''u+B'')(u^2+1)^2.$$

For $u=i$, $-4i = Ai+B$; $\therefore A = -4$, $B=0$.

Substitute, transpose, and divide by u^2+1 ;

$$\therefore u^3+5u^2+9u+5 \equiv A'u+B'+(A''u+B'')(u^2+1).$$

For $u=i$, $8i = A'i+B'$; $\therefore A' = 8$, $B'=0$.

Substitute, transpose, divide by u^2+1 ;

$$\therefore u+5 \equiv A''u+B''; \quad \therefore A'' = 1, B'' = 5.$$

$$\int = -4 \int \frac{du}{(u^2+1)^3} + 8 \int \frac{du}{(u^2+1)^2} + \int \frac{u du}{u^2+1} + 5 \int \frac{du}{u^2+1}.$$

The third and fourth integrals are $\log \sqrt{u^2+1}$ and $5 \tan^{-1}u$; to find the first and second, put $u = \tan \phi$; then

$$\int \frac{du}{(u^2+1)^3} = \int \overline{\cos \phi}^4 d\phi = \frac{1}{4} \sin \phi (\overline{\cos \phi}^3 + \frac{3}{2} \cos \phi) + \frac{3}{8} \phi,$$

$$\int \frac{du}{(u^2+1)^2} = \int \overline{\cos \phi}^2 d\phi = \frac{1}{2} (\phi + \sin \phi \cos \phi).$$

Combining these results and returning to x we get

$$\int = -\frac{4x^2 - 8x + 7}{\{x^2 - 2x + 2\}^2} + \log \sqrt{x^2 - 2x + 2} + 5 \tan^{-1}(x - 1).$$

4. Putting $x = a \tan \phi$, show that

$$\int \frac{dx}{(a^2 + x^2)^n} = \frac{1}{2(n-1)a^2} \cdot \frac{x}{(a^2 + x^2)^{n-1}} + \frac{2n-3}{2(n-1)a^2} \int \frac{dx}{(a^2 + x^2)^{n-1}},$$

an important reduction.

5. $\int \frac{dx}{x^n - 1}$. We may consider n as odd; for if it were even, say $2m$, then we should have

$$x^{2m} - 1 = (x^m + 1)(x^m - 1), \quad \frac{1}{x^{2m} - 1} = \frac{1}{2} \left(\frac{1}{x^m - 1} - \frac{1}{x^m + 1} \right).$$

To factor $x^n - 1$, put $x = e^{i\alpha}$. Such will be the *form* of x when $x^n = 1$; for if $x = a + ib$, we have

$$a = r \cos \theta \text{ and } b = r \sin \theta, \quad x = r(\cos \theta + i \sin \theta) = re^{i\theta},$$

where

$$r = \sqrt{a^2 + b^2} = \text{modulus or absolute worth of } a + ib;$$

hence

$$x^n = 1 = r^n e^{in\theta} = r^n (\cos n\theta + i \sin n\theta),$$

$1 = r^n \cos n\theta$ and $0 = \sin n\theta$; hence $\cos n\theta = 1$, hence $r^n = 1$, hence $x^n = e^{in\theta}$ —in accord with the general proposition that the absolute worth of the n^{th} power (of a number) equals the n^{th} power of the absolute worth of that number. Now the only powers of e that $= 1$ are of the *form* $e^{2\pi i}$, where r is any integer positive or negative. For $e^{i\phi} = \cos \phi + i \sin \phi$; hence if $e^{i\phi} = 1$ we have $\cos \phi = 1$ and $\sin \phi = 0$, which two equations consist only when ϕ is some multiple of the period 2π . Hence, if $x^n = e^{in\theta} = 1$, we have

$$n\theta = 0, \text{ or } 2\pi, \text{ or } 4\pi, \dots \text{ or } -2\pi, \text{ or } -4\pi, \dots;$$

$$\theta = 0, \text{ or } \frac{2\pi}{n}, \text{ or } \frac{4\pi}{n}, \dots \text{ or } -\frac{2\pi}{n}, \text{ or } -\frac{4\pi}{n}, \dots;$$

$$x = 1, \text{ or } e^{i\theta_1}, \text{ or } e^{i\theta_2}, \dots \text{ or } e^{-i\theta_1}, \text{ or } e^{-i\theta_2}, \dots;$$

where $\theta_r = \frac{2r\pi}{n}$. It is plain there are only n distinct values of x , i.e., only n distinct n^{th} roots of 1; for $e^{2nr\pi + i\theta} = e^{i\theta}$. It is best to arrange these roots (except the real one) in pairs of conjugates or reciprocals, as $e^{i\theta_1}$ and $e^{-i\theta_1}$,—it is clear that the reciprocal of an n^{th} root of 1 is itself an n^{th} root of 1. We have then

$$\frac{n}{x^n - 1} = \frac{A}{x - e^{i\theta_1}} + \frac{A'}{x - e^{-i\theta_1}} + \frac{B}{x - e^{i\theta_2}} + \frac{B'}{x - e^{-i\theta_2}} + \dots + \frac{L}{x - 1}.$$

For $x = 1$ we have $n = nL$, whence $L = 1$. Generally,

$$n = \frac{x^n - 1}{x - e^{i\theta_1}} \cdot A + \{x - e^{i\theta_1}\},$$

whence $A = e^{i(n-1)\theta_1} = e^{-i\theta_1}$.

Similarly $A' = \dots\dots\dots = e^{i\theta_1}$.

Whence, remembering that $e^{i\theta} + e^{-i\theta} = 2 \cos \theta$, we get

$$\frac{A}{x - e^{i\theta_1}} + \frac{A'}{x - e^{-i\theta_1}} = \frac{2x \cos \theta_1 - 2}{x^2 - 2x \cos \theta_1 + 1}.$$

This then is the typical form of the part-fractions, the others are formed by changing the subscripts of θ . There are $\frac{n-1}{2}$ such part-fractions. We now have

$$\begin{aligned} & \int \frac{2x \cos \theta - 2}{x^2 - 2x \cos \theta + 1} dx \\ &= \cos \theta \int_1 \frac{2x - 2 \cos \theta}{x^2 - 2x \cos \theta + 1} dx - 2(1 - \cos^2 \theta) \int_2 \frac{dx}{x^2 - 2x \cos \theta + 1}; \\ & \int_1 = \log(x^2 - 2x \cos \theta + 1); \\ & \int_2 = \int \frac{d(x - \cos \theta)}{(x - \cos \theta)^2 + \sin^2 \theta} = \frac{1}{\sin \theta} \tan^{-1} \frac{x - \cos \theta}{\sin \theta}. \end{aligned}$$

Hence we have as final result :

$$\int \frac{dx}{x^n - 1} = \frac{1}{n} \left\{ \log(x-1) + \sum_{2r=n-1} \left(\cos \frac{2r\pi}{n} \log \left(x^2 - 2x \cos \frac{2r\pi}{n} + 1 \right) - 2 \sin \frac{2r\pi}{n} \tan^{-1} \frac{x - \cos \frac{2r\pi}{n}}{\sin \frac{2r\pi}{n}} \right) \right\}.$$

Show that $\int \frac{x^{m-1}}{x^n - 1} = \text{same}$, with mr for r in multipliers of \log and \tan^{-1} .

6. $\int \frac{dx}{x^n + 1}$. The linear factors of $x^n + 1$ are plainly

$$x - e^{\frac{\pi i}{n}}, \quad x - e^{-\frac{\pi i}{n}}, \quad x - e^{\frac{3\pi i}{n}}, \quad \dots \quad x - e^{\pm \frac{(2r-1)\pi i}{n}}, \quad \dots$$

since $e^{\pm \pi i} = e^{(2r \pm 1)\pi i} = -1$.

We may again combine conjugate terms and obtain results of the same form as in (5) with $2r-1$ put for $2r$.

7. $\int \frac{dx}{x^6 - 1} = \frac{1}{2} \int \frac{dx}{x^3 - 1} - \frac{1}{2} \int \frac{dx}{x^3 + 1} = ?$

8. $\int \frac{dx}{x^8 - 1} = \frac{1}{2} \int \frac{dx}{x^4 - 1} - \frac{1}{2} \int \frac{dx}{x^4 + 1}$
 $= \frac{1}{4} \int \frac{dx}{x^2 - 1} - \frac{1}{4} \int \frac{dx}{x^2 + 1} - \frac{1}{2} \int \frac{dx}{x^4 + 1} = ?$

9. $\int \frac{dx}{x^9 - 1}$. Put $u = x^3$, and decompose; or apply (5) at once.

10. $\int \frac{dx}{x^5 - 1}$, $\int \frac{dx}{x^7 - 1}$, $\int \frac{dx}{x^{10} - 1}$.

11. Multiply the numerators of the foregoing by x , x^2 , etc., and evaluate.

12. Find the area of an arch of the cycloid :

$$x = a(\theta - \sin \theta), \quad y = a(1 - \cos \theta),$$

$$\begin{aligned} A &= \int_0^{2\pi a} y \, dx = a^2 \int_0^{2\pi} (1 - \cos \theta)^2 d\theta \\ &= a^2 \left\{ \theta - 2 \sin \theta + \frac{\theta}{2} + \frac{\sin \theta \cos \theta}{2} \right\}_0^{2\pi} = 3\pi a^2. \end{aligned}$$

13. Find the length of a cycloidal arch.

Since $s_x = \sqrt{1 + y_x^2}$ and $s_y = \sqrt{1 + x_y^2}$, we have

$$s = \int \sqrt{1 + y_x^2} \, dx = \int \sqrt{1 + x_y^2} \, dy,$$

between proper extremes. Now

$$y_x = y_\theta \cdot \theta_x = \sin \theta / (1 - \cos \theta) = \cos \phi / \sin \phi = \cot \phi,$$

if $2\phi = \theta$. Hence

$$\sqrt{1 + y_x^2} = \sqrt{1 + \cot^2 \phi} = 1/\sin \phi;$$

$$dx = a(1 - \cos \theta) d\theta = 4a \sin^2 \phi d\phi.$$

Hence

$$s = 4a \int_0^\pi \sin \phi \, d\phi = 4a \left\{ -\cos \phi \right\}_0^\pi = 4a \left\{ \cos \phi \right\}_\pi^0 = 8a.$$

Here the extremes are 0 and 2π for θ , 0 and π for ϕ .

$$14. \int \frac{(\sin \theta)^3}{(\cos \theta)^5} d\theta = \int (\tan \theta)^3 \cdot (\sec \theta)^2 \cdot d\theta = \frac{1}{4} (\tan \theta)^4.$$

$$\begin{aligned} 15. \int \frac{dx}{\sin x \cos x^3} &= \int \frac{dx}{\tan x \cos x^4} = \int \frac{(1 + \tan^2 x) \sec x^2}{\tan x} dx \\ &= \log \tan x + \frac{1}{2} \tan x^2. \end{aligned}$$

$$16. \int \frac{\sqrt{\sin u} \cdot du}{(\cos u)^{\frac{5}{2}}} = \int \sqrt{\tan u} \cdot \sec u^2 \cdot du = \frac{2}{3} (\tan u)^{\frac{3}{2}}.$$

17. $\int \overline{\sin u^m \cos u^n} du$. This may be written

$$\int \overline{\tan u^m \cos u^{m+n+2}} d(\tan u),$$

since $\sin u = \tan u \cdot \cos u$ and $d \tan u = \sec^2 u du$. Now, if $m+n = -2c$, where c is a natural number, then

$$\overline{\cos u}^{m+n+2} = \{\overline{\sec u}^2\}^{c-1} = \{1 + \overline{\tan u}^2\}^{c-1};$$

hence the integrand is rational in $\tan u$ and integrable at once.

18. $\int \frac{x^4 dx}{x^6 - 2x^5 + x^4 + x^2 - 2x + 1}$

19. $\int \frac{dx}{(a^2 + x^2)^2}$, and show how to integrate $\int \frac{dx}{(a^2 + x^2)^n}$.

20. $\int \frac{dx}{(a^2 - x^2)^2}$, and show how to integrate $\int \frac{dx}{(a^2 - x^2)^n}$.

21. $\int \frac{dx}{a^4 + x^4}$. [Hint: $a^4 + x^4 = (a^2 + ax\sqrt{2} + x^2)(a^2 - ax\sqrt{2} + x^2)$.]

22. $\int \frac{cx dx}{a^4 + x^4}$, $\int \frac{cx^2 dx}{a^4 + x^4}$, $\int \frac{cx^3}{a^4 + x^4}$, $\int \frac{cx^5}{a^4 + x^4} dx$.

23. $\int \frac{11x^3}{(15 - 9x^2)^3} dx$, $\int \frac{a dx}{x + x^3}$, $\int \frac{a dx}{x^3(x^2 - 5)^5}$. [Put $x^2 = u$.]

24. $\int \frac{ax^5 dx}{3 - 2x^3}$, $\int \frac{ax^5 dx}{(5 - 7x^3)^3}$, $\int \frac{a dx}{x^4(5 + 3x^3)^2}$. [Put $x^3 = u$.]

25. $\int \frac{ax^5}{(1 + x^4)^2} dx$, $\int \frac{b dx}{7x + 3x^5}$, $\int \frac{b dx}{x^5(1 - x^4)^2}$. [Put $x^4 = u$.]

It is often well to put $x^n = u$, substitute, and then choose n so as to make the result as simple as possible.

26. $\int \frac{a dx}{x^7(x^6 - 2)^7}$, $\int \frac{ax^2 dx}{1 - x^6}$, $\int \frac{ax^3 dx}{(1 - x^2 + x^4)^2}$.

27. $\int \frac{x dx}{x^2 + 4x + 2}$, $\int \frac{dx}{(x^2 + 5x + 4)^2}$, $\int \frac{dx}{(x^2 + 5x + 4)^3}$,
 $\int \frac{dx}{(x^2 - 5x + 4)^4}$

28. $\int \frac{x^2 dx}{\sqrt{4 + 2x}}$. For $u = 4 + 2x$,

$$\int = \frac{1}{8} \int u^{\frac{3}{2}} du - \int u^{\frac{1}{2}} du + 2 \int \frac{du}{\sqrt{u}}$$

$$29. \int \frac{adx}{x^3\sqrt{5-2x}}, \int \frac{cdx}{x^3(1+x)^{\frac{3}{2}}}, \int \frac{2-x}{\sqrt[n]{a-x}} dx, \int \frac{cdx}{\sqrt[3]{x-a-b}}.$$

$$30. \int \frac{1-\sqrt[4]{x}}{1+\sqrt[4]{x}} dx, \int \frac{\sqrt{3x-7}}{x^3} dx, \int x\sqrt[3]{3x+7} dx.$$

$$31. \int \frac{x^{\frac{1}{2}}}{x^{\frac{1}{2}}+x^{\frac{1}{3}}} dx. \quad [\text{Hint: Put } u = x^{30}.]$$

$$32. \int \frac{x^{\frac{1}{4}}-x^{\frac{1}{3}}}{x^{\frac{1}{4}}+x^{\frac{1}{3}}} dx, \int x^4 \left(\frac{2+3x}{3-5x} \right)^{\frac{3}{2}} dx,$$

$$\int \frac{axdx}{(1+x)^{\frac{1}{2}}-(1+x)^{\frac{1}{3}}}. \quad [1+x=u^6.]$$

33. Show by deriving $(ax+b)^p(cx+d)^q \equiv P^pQ^q$ and then integrating the result that

$$\int P^pQ^{q-1}dx = \frac{P^pQ^q}{c(p+q)} - \frac{(ad-bc)p}{c(p+q)} \int P^{p-1}Q^{q-1}dx. \dots\dots(A)$$

This formula *lowers* the exponent of P by 1; solving as to the integral on the right we get a formula (A') for *raising* the exponent of P by 1.

$$34. \int (2+3x)^{\frac{2}{3}}(2-3x)^{\frac{1}{2}} dx, \int \frac{\sqrt{1+x}}{\sqrt{1-x}} dx, \int \frac{\sqrt{1+x}}{(1-x)^{\frac{3}{2}}} dx.$$

$$35. \int (au^n+b)^p u^{m-1} du. \quad \text{Put } u^n = x; \text{ then}$$

$$nu^{n-1} du = dx, \quad u^{m-1} du = u^{m-n} \cdot u^{n-1} du = \frac{1}{n} x^{\frac{m}{n}-1} dx;$$

$$\text{hence} \quad \int = \frac{1}{n} \int (ax+b)^p x^{\frac{m}{n}-1} dx.$$

Apply 33; whence

$$\begin{aligned} & \int (au^n+b)^p u^{m-1} du \\ &= \frac{1}{m+pn} \left\{ (au^n+b)u^m + bnp \int (au^n+b)^{p-1} u^{m-1} du \right\}. \dots(B) \end{aligned}$$

This formula *reduces* the exponent p by 1; solving as to the integral on the right we obtain a formula (B') for *raising* the exponent of (au^n+b) by 1.

$$36. \int (au^n + b)^p u^{m-1} du = \frac{1}{a(m+np)} \\ \times \left\{ (au^n + b)^{p+1} u^{m-n} - b(m-n) \int (au^n + b)^p u^{m-n-1} du \right\}. \dots (C)$$

This formula *lowers* the exponent of u by n , the exponent within the parenthesis; solving as to the integral on the right we obtain a formula (C') for *raising* the exponent of u by n .

$$37. \int x^4(1-x^2)^{\frac{3}{2}} dx \\ = -\frac{\sqrt{1-x^2}}{128} (16x^7 - 24x^5 + 2x^3 + 3x + 3 \sin^{-1}x).$$

Lower the exponents, first of x , then of $(1-x^2)$.

$$\text{Similarly } \int x^3(1-x^2)^{\frac{5}{2}} dx, \int x^5(1+x^2)^{\frac{3}{2}} dx, \int x^2(1-x^2)^{\frac{7}{2}} dx.$$

$$38. \int \frac{x^3 dx}{(1-x^2)^{\frac{3}{2}}} = \frac{2-x^2}{\sqrt{1-x^2}}, \int \frac{x^4 dx}{(1-x^2)^{\frac{3}{2}}} = \frac{3x-x^3}{2\sqrt{1-x^2}} - \frac{3}{2} \sin^{-1}x.$$

Lower exponent of x , raise exponent of $(1-x^2)$.

$$39. \int \frac{dx}{x^5 \sqrt{1-x^2}}, \int \frac{dx}{x^3(1-x^2)^{\frac{3}{2}}}; \text{ raise the exponents.}$$

$$40. \int \frac{x^m dx}{\sqrt{1-x^2}}, \int \frac{dx}{x^m \sqrt{1-x^2}}, \text{ for } m \text{ even and } m \text{ odd.}$$

41. $\int x^p(ax^2 + 2bx + c)^{\frac{q}{2}} dx$. Bring the parenthesis to the form of sum or difference of two squares, and proceed as before.

$$42. \int \frac{dx}{(x^2 - 4x + 3)^{\frac{1}{2}}} = \int \frac{d(x-2)}{(x-2)^2 - 1)^{\frac{1}{2}}} = \int \frac{du}{\sqrt{u^2 - 1}} = \text{hc}^{-1}u \\ = \text{hc}^{-1}(x-2) = \log(x-2 + \sqrt{x^2 - 4x + 3})$$

$$43. \int \sqrt{x^2 + x + 1} dx = \int \sqrt{u^2 + \frac{3}{4}} du \\ = \frac{1}{2} \left\{ u \sqrt{u^2 + \frac{3}{4}} + \frac{3}{4} \text{hs}^{-1} \frac{2u}{\sqrt{3}} \right\} \\ = \frac{1}{2} \left\{ (x + \frac{1}{2}) \sqrt{x^2 + x + 1} + \frac{3}{4} \text{hs}^{-1} \frac{2x+1}{\sqrt{3}} \right\},$$

or $\frac{1}{4} \{ (2x+1) \sqrt{x^2 + x + 1} + \frac{3}{2} \log(2x+1 + 2\sqrt{x^2 + x + 1}) \}$.

44. $\int x\sqrt{x^2+x+1} dx, \int x^2\sqrt{x^2+x+1} dx, \int \frac{x dx}{\sqrt{x^2+x+1}},$
 $\int \frac{x^2 dx}{(x^2+x+1)^{\frac{3}{2}}}.$
45. $\int x^{-2}\sqrt{x^2+x+1} dx, \int x^{-3}(x^2+x+1)^{\frac{3}{2}} dx,$
 $\int x^{-3}(x^2+x+1)^{-\frac{1}{2}} dx, \int x^{-2}(x^2+x+1)^{-\frac{3}{2}} dx.$
46. $\int \frac{dx}{\sqrt{ax^2+bx}}, \int \frac{dx}{\sqrt{ax^2-bx}}, \int \frac{x dx}{\sqrt{2ax-x^2}}, \int \frac{x^3 dx}{\sqrt{x^2-2ax}},$
 $\int \frac{x^2 dx}{\sqrt{x^2+2ax}}.$
47. $\int \frac{dx}{x\sqrt{2ax+x^2}}, \int \frac{dx}{x^2\sqrt{x^2-2ax}}, \int \frac{dx}{x^3\sqrt{2ax-x^2}},$
 $\int x^2\sqrt{2ax\pm x^2} dx.$
48. $\int \frac{dx}{(x\pm 1)\sqrt{1-x^2}}, \int \frac{dx}{(x+a)\sqrt{x^2-1}}, \int \frac{dx}{(x^2\pm a^2)\sqrt{1\pm x^2}},$
 $\int \frac{x dx}{(a^2\pm x^2)\sqrt{x^2\pm 1}}.$
49. $\int \frac{(x-1) dx}{(x^2-x+1)\sqrt{x^2+x+1}},$
 $\int \frac{(x-1) dx}{(5x^2-18x+17)\sqrt{10x^2-22x+13}}, \int \frac{(x^2+5) dx}{(x^2+1)^2\sqrt{1-x^2}}.$
50. $\int \frac{dx}{\sqrt{(x-a)(x-b)}} = 2 \operatorname{ht}^{-1} \sqrt{\frac{x-a}{x-b}}$
 $= 2 \log \frac{\sqrt{x-a} + \sqrt{x-b}}{\sqrt{a-b}};$
 $\int \frac{dx}{\sqrt{(a-x)(x-b)}} = 2 \tan^{-1} \sqrt{\frac{x-b}{a-x}}.$

CHAPTER III.

APPLICATIONS.

DEVELOPMENT IN SERIES.

128. A most important example of integration by parts, $\int uv_x dx = uv - \int u_x v dx$, is the following:

$$\begin{aligned} \int \phi'(y) dy &= y\phi'(y) - \int \phi''(y)y dy, \\ -\int \phi''(y)y dy &= -\frac{y^2}{2}\phi''(y) + \frac{1}{2}\int \phi'''(y)y^2 dy, \\ \frac{1}{2}\int \phi'''(y)y^2 dy &= \frac{y^3}{3}\phi'''(y) - \frac{1}{3}\int \phi^{iv}(y)y^3 dy. \end{aligned}$$

.....

$$\frac{(-1)^{n-1}}{\underline{n-1}} \int \phi^{(n)}(y)y^{n-1} dy = \frac{(-1)^{n-1}}{\underline{n}} \phi^{(n)}(y) + \frac{(-1)^n}{\underline{n}} \int \phi^{(n+1)}(y)y^n dy.$$

Taking 0 and h as extremes of integration, and remembering that $\int_0^h \phi'(y) dy = \phi(h) - \phi(0)$, we have, on adding,

$$\begin{aligned} \phi(h) = \phi(0) + h\phi'(h) - \frac{h^2}{2}\phi''(h) + \frac{h^3}{3}\phi'''(h) - + \dots \\ + \frac{(-1)^n}{\underline{n}} \int_0^h \phi^{(n+1)}(y)y^n dy. \end{aligned}$$

When the last term \int_0^h is neglected and n is increased without limit, the result is *Bernoulli's Series*. This has the

disadvantage of *alternating signs*, to remove which we may put $\phi(a-u)$ for $\phi(y)$; then

$$\int \phi'(a-u)du = u\phi'(a-u) + \int \phi''(a-u)u du,$$

since $\{\phi'(a-u)\}_u = -\phi''(a-u)$.

As before then, we get, on inserting extremes 0 and h ,

$$\begin{aligned} \phi(a) &= \phi(a-h) + h\phi'(a-h) + \frac{h^2}{2}\phi''(a-h) + \dots \\ &\quad + \frac{1}{n}\int \phi^{(n+1)}(a-u)u^n du. \end{aligned}$$

Now put $x+h$ for a , and there results

$$\begin{aligned} \phi(x+h) &= \phi(x) + h\phi'(x) + \frac{h^2}{2}\phi''(x) + \frac{h^3}{3}\phi'''(x) + \dots \\ &\quad + \frac{h^n}{n}\phi^{(n)}(x) + \frac{1}{n}\int_0^h \phi^{(n+1)}(x+h-u)u^n du. \end{aligned}$$

129. Taylor's Series.—This is by far the most important series, expansion, or development, in the Calculus. It was discovered and enounced by **Brooke Taylor** (*Methodus Incrementorum Directa et Inversa*, 1715), without, however, the last term or Integral, the so-called **Remainder**, n being boldly put $=\infty$. This Remainder, however, R_n , is plainly an essential part of the series, and only in case **Limit of R_n is 0** are we justified in omitting R_n and extending the series to ∞ . We notice further that the process by which this series is generated is admissible only when and as long as ϕ and its Derivatives and Integrals may be derived and integrated by parts. Such are the conditions, not so much of the **validity** as of the **existence** of **Taylor's Theorem**.

130. Lagrange's and Cauchy's Forms.—This *Remainder* R_n tells us nothing about what properties ϕ must have in the interval h , in order that $\text{Lim. } R_n = 0$; but it may be brought into several forms more or less convenient for

testing whether its limit be 0. Thus by the *Theorem of mean value*,

$$\begin{aligned} R_n &= \frac{1}{\lfloor n \rfloor} \int_0^h \phi^{(n+1)}(x+h-u) u^n du \\ &= \frac{1}{\lfloor n \rfloor} \phi^{(n+1)}(x+\theta h) \int_0^h u^n du = \frac{h^{n+1}}{\lfloor n+1 \rfloor} \phi^{(n+1)}(x+\theta h). \end{aligned}$$

Such is *Lagrange's form*. Similarly we deduce *Cauchy's*:

$$R_n = \frac{1}{\lfloor n \rfloor} \phi^{(n+1)}(x+\theta h) (1-\theta)^n h^n \int_0^1 du = \frac{(1-\theta)^n}{\lfloor n \rfloor} h^{n+1} \phi^{(n+1)}(x+\theta h).$$

Here θ , and therefore $1-\theta$, are *proper fractions*.

Note that the vanishing of the Limit of the Integral Remainder, $\text{Lim. } R_n = 0$, is the *necessary and sufficient* condition of the existence of Taylor's Formula; while the vanishing of Lagrange's or Cauchy's *form* of the Remainder is a *sufficient*, but *not* always a *necessary* condition.

131. Interpretation of the Series.—What does this series signify or effect? Suppose we know the value of $\phi(x)$ and its derivatives for some *special* value of the argument, as x ; then this series furnishes us a rule for calculating the value of ϕ for any other argument, $x+h$. For example, we know the value of sine and of its derivatives, sine and cosine, for the special argument-values, $0, \pi/6, \pi/4, \pi/3, \pi/2$; accordingly, this series enables us to calculate the value of sine for any other argument-value and express it through sine and cosine of any of these special values. In the general case we are said to *develop* or *expand* the function ϕ in the neighbourhood h of the special value x . For instance, let us *expand the sine in the neighbourhood of 0*. Here $x=0$, $\phi = \text{sine}$, $\phi' = \text{cosine}$, $\phi'' = -\text{sine}$, $\phi''' = -\text{cosine}$, $\phi^{iv} = \text{sine}$, etc.; also, for the special value 0 all the sines or even derivatives vanish, while the cosines or odd derivatives become alternately

+1 and -1; moreover, the Remainder, in Lagrange's form, is seen to be $\frac{h^{n+1}}{n+1} \sin\left(\frac{n+1}{2}\pi + \theta h\right)$, and this is certainly not greater than $\frac{h^{n+1}}{n+1}$, and the limit of this latter is 0; lastly, the resulting series is absolutely convergent for all finite values of h . We have, then,

$$\sin h = h - \frac{h^3}{3} + \frac{h^5}{5} - \frac{h^7}{7} + \dots = \sum (-1)^n \frac{h^{2n+1}}{2n+1}.$$

Such is the well-known development of the sine in the vicinity of the argument-value 0. Quite similarly, let the student develop *cosine* and the *exponential* e^h .

132. Stirling's Series.—The most important argument-value in whose neighbourhood we develop functions is the value 0. Putting $x=0$ yields us a special formula for this development, called after *Maclaurin*, but first given by *Stirling* (1717):

$$\begin{aligned} \phi(h) = \phi(0) + h\phi'(0) + \frac{h^2}{2}\phi''(0) + \dots \\ + \frac{h^n}{n}\phi^{(n)}(0) + \frac{1}{n} \int_0^h \phi^{(n+1)}(h-u)u^n du. \end{aligned}$$

Of course, the derivatives are to be formed *first*, and the critical argument-value 0 inserted *afterwards* (Art. 67). Clearly, any other symbol, as x, y, z , may be put for h .

133. Relation of the two Series.—Maclaurin's then is only a special case of Taylor's formula, for expansion in the vicinity of 0. But by a mere change of variable, equivalent to a change of origin, we may generalize Maclaurin's into Taylor's formula. For then x will take the place of 0 and $x+h$ of h in the function ϕ ; but the vicinity h remains unaffected. The student must note carefully the significance of the symbols in Taylor's series: x is the special or critical argument-value, $x+h$ is the

general argument-value, h is the neighbourhood. In Maclaurin's formula h has two quite distinct logical uses: on the left, in ϕ , it stands for $0+h$, the general argument-value; while on the right it denotes the neighbourhood—only in case the critical value is 0 will the general argument-value be the same as the neighbourhood. This double logical use of h rather obscures the significance of Maclaurin's formula. We may perhaps set the matter in clearer light by calling the critical argument-value a , the general argument-value u ; the vicinity will then be $u-a$, and we shall have

$$\phi(u) = \phi(a) + (u-a)\phi'(a) + \frac{(u-a)^2}{2} \cdot \phi''(a) + \dots + R_n.$$

For $a=0$, and only for $a=0$, this becomes Maclaurin's formula, and the neighbourhood $u-a$ coincides with the general argument-value u .

134. Development of Logarithm.—When a function can be developed in the neighbourhood of 0, Maclaurin's formula may be used, but not otherwise. Some functions do not admit of such development, as the logarithm; for plainly $\log x$ and all its derivatives become ∞ for $x=0$, wherefore our part-integrations used in the deduction of the formula are seen to be inadmissible. But we can develop the logarithm in the vicinity of the argument-value 1. Thus:

$$\begin{aligned} \phi(1) &= \log(1) = 0, & \phi'(1) &= \frac{1}{1} = 1, & \phi''(1) &= -1, \\ \phi'''(1) &= -\frac{1}{2}, & \phi^{iv}(1) &= \frac{1}{3}, & \dots & \phi^{(n+1)}(1) = (-1)^n \frac{1}{n}; \end{aligned}$$

whence

$$\log(1+h) = h - \frac{h^2}{2} + \frac{h^3}{3} - \frac{h^4}{4} + \dots + R_n.$$

Here by Lagrange's form we have

$$R_n = \frac{h^{n+1}}{n+1} \phi^{(n+1)}(x+\theta h) = (-1)^{n+1} \frac{h^{n+1}}{n+1} \frac{1}{(1+\theta h)^{n+1}}.$$

It is plain that for h not greater than 1 this expression approaches 0 as limit, but for $h > 1$ we cannot affirm so much. For negative h , however, this form of the remainder is unavailable, since $1 + \theta h$ may then be < 1 . But by Cauchy's,

$$R_n = \frac{(1-\theta)^n h^{n+1}}{n} \phi^{(n+1)}(x+\theta h) = (-1)^{n+1} \frac{(1-\theta)^n h^{n+1}}{(1+\theta h)^{n+1}}$$

$$= (-1)^{n+1} \left(\frac{h-h\theta}{1+\theta h} \right)^n \cdot \frac{h}{1+\theta h}.$$

If $h > -1$, then $\frac{h}{1+\theta h}$ is finite while $\left(\frac{h-h\theta}{1+\theta h} \right)^n$ is the n^{th} power of a proper fraction, and hence has 0 for limit. Hence

$$\log(1+h) = h - \frac{h^2}{2} + \frac{h^3}{3} - \frac{h^4}{4} + \dots \pm \frac{h^n}{n} \mp \dots \quad [-1 < h \leq 1.]$$

135. Another Series for Logarithm.—The series is convergent within this narrow neighbourhood but not without it. However, we may readily deduce another series with wider range of rapider convergence. For, to make the alternation in sign disappear,

$$\log(1-h) = -h - \frac{h^2}{2} - \frac{h^3}{3} - \frac{h^4}{4} - \dots,$$

$$\log(1+h) - \log(1-h) = \log \frac{1+h}{1-h} = 2 \left(h + \frac{h^3}{3} + \frac{h^5}{5} + \dots \right).$$

The improper fraction $\frac{1+h}{1-h}$ we may equate to $\frac{n+1}{n}$, then

$h = \frac{1}{2n+1}$, so that we get

$$\log(n+1) = \log n + 2 \left\{ \frac{1}{2n+1} + \frac{1}{3(2n+1)^3} + \frac{1}{5(2n+1)^5} + \dots \right\}.$$

Hence, knowing the logarithm of n , we may find that of $n+1$ by use of this very rapidly converging series; nor need n be integral.

136. Expansion of Anti-tangent.—Let us develop

$$\phi(x) = \tan^{-1}x$$

in the vicinity of 0. We have

$$\phi'(x) = \frac{1}{1+x^2} = \frac{1}{2i} \left(\frac{1}{x-i} - \frac{1}{x+i} \right),$$

$$\phi''(x) = -\frac{1}{2i} \left(\frac{1}{(x-i)^2} - \frac{1}{(x+i)^2} \right), \quad \phi'''(x) = \frac{2}{2i} \left(\frac{1}{(x-i)^3} - \frac{1}{(x+i)^3} \right),$$

$$\dots \phi^{(n+1)}(x) = (-1)^n \frac{n!}{2i} \left(\frac{1}{(x-i)^{n+1}} - \frac{1}{(x+i)^{n+1}} \right).$$

Hence $\phi(0) = 0$, $\phi'(0) = 1$, $\phi''(0) = 0$, $\phi'''(0) = -\frac{2}{3}$,

In general the even derivatives vanish for $x=0$, since $(-i)^{2p} = (+i)^{2p}$, and the odd derivatives are factorials with alternating signs; hence

$$\tan^{-1}x = x - \frac{x^3}{3} + \frac{x^5}{5} - \frac{x^7}{7} + \dots \pm R_n.$$

Let the student show that $\text{Lim. } R_n = 0$ for $-1 < x < +1$. Only within this narrow neighbourhood does the expansion hold.

137. Circle of Convergence.—It is common to deduce this series thus:

$$\tan^{-1}x = \int_0^x \frac{dx}{1+x^2} = \int_0^x (1-x^2+x^4-x^6+\dots)dx = x - \frac{x^3}{3} + \frac{x^5}{5} - \dots$$

But we have no logical right as yet to declare that the integral of the sum equals the sum of the integrals when the number of summands is not finite.

It is remarkable that the series should hold only within a certain range, whereas the integrand remains finite and devoid of peculiarity without that range; thus, for $x = \pm 2$,

$\frac{1}{1+x^2} = \frac{1}{1+4} = \frac{1}{5}$. It is the fact that the integrand becomes ∞ for $x = \pm i$, and that the absolute worth of i equals the absolute worth of 1, that limits the *circle of convergence* to the interior of the unit circle—a fact which the student may hereafter understand and appreciate.

138. We may now deduce the **Binomial Theorem** by developing $\phi(x) = (1+x)^m$ in the vicinity of 0, thus:

$$\phi^{(r)}(x) = m(m-1) \dots (m-r+1)(1+x)^{m-r},$$

$$\phi^{(r)}(0) = m(m-1) \dots (m-r+1) = m_{r-1}.$$

Hence

$$(1+x)^m = 1 + mx + \frac{m(m-1)}{2}x^2 + \dots + \frac{m_{r-1}}{r}x^r + \dots + R_n.$$

By Lagrange's form,

$$R_n = \frac{x^{n+1}}{n+1} \cdot m_n(1+\theta x)^{m-n+1},$$

the limit of which is 0 for x between $+1$ and -1 .

To expand $(a+x)^m$ we write

$$(a+x) = a\left(1 + \frac{x}{a}\right) \text{ or } = x\left(1 + \frac{x}{a}\right)$$

according as $a > x$ or $x > a$, and apply the preceding formula.

139. Newton's (?) Method.—Often the straight-forward derivation of ϕ would lead to very complicated expressions for the derivatives. In such cases it is well to find the simplest rational or integral relation connecting ϕ with its first derivatives, and then to derive the terms of this relation separately by Leibnitz's Theorem; in this way we may arrive at some simple general relation connecting the higher derivatives, from which we may then obtain them successively. Thus, suppose

$$\phi(x) = \cos(m \sin^{-1}x).$$

Then $\sqrt{1-x^2}\phi'(x) = -m \sin(m \sin^{-1}x),$

$$-\frac{x}{\sqrt{1-x^2}}\phi'(x) + \sqrt{1-x^2}\phi''(x)$$

$$= -m^2 \cos(m \sin^{-1}x) \cdot \frac{1}{\sqrt{1-x^2}} = -m^2 \phi(x) / \sqrt{1-x^2},$$

whence $(1-x^2)\phi''(x) - x\phi'(x) + m^2\phi(x) = 0.$

Derive n times this **Differential Equation** of *second order*:

$$(1-x^2)\phi^{(n+2)}(x) - 2nx\phi^{(n+1)}(x) - n(n-1)\phi^{(n)}(x) - x\phi^{(n+1)}(x) - n\phi^{(n)}(x) + m^2\phi^{(n)}(x) = 0,$$

or $(1-x^2)\phi^{(n+2)}(x) - (2n+1)x\phi^{(n+1)}(x) + (m^2-n^2)\phi^{(n)}(x) = 0.$

This is an equivalent Differential Equation of $(n+2)^{\text{th}}$ order. For the special value $x=0$, we have

$$\phi''(0) = -m^2\phi(0), \quad \phi^{(n+2)}(0) = (n^2 - m^2)\phi^{(n)}(0).$$

But $\phi(0) = 1, \phi'(0) = 0; \therefore \phi''(0) = -m^2,$

$$\phi^{iv}(0) = -m^2(2^2 - m^2), \quad \phi^{vi}(0) = \phi^{iv}(0)(4^2 - m^2),$$

and so on, while all the odd derivatives vanish. Hence $\cos(m \sin^{-1}x)$

$$= 1 - \frac{m^2}{2}x^2 - \frac{m^2(2^2 - m^2)}{4}x^4 - \frac{m^2(2^2 - m^2)(4^2 - m^2)}{6}x^6 - \dots$$

Let the student test R_n and the range of value of x .

140. Bernoulli's Numbers.—A very remarkable expansion

is that of $\frac{x}{e^x - 1}$, or still better, of $\frac{1}{2}x \frac{e^x + 1}{e^x - 1}$, which equals $\frac{x}{e^x - 1} + \frac{1}{2}x$. This latter is an *even* function of x , since it equals $\frac{x}{2} \text{cosec} \frac{x}{2}$, which is the product of *two odd* functions of x ; hence its expansion can contain only even powers of x .

If $\frac{x}{e^x - 1} = \phi(x)$, then $\phi(x)\{e^x - 1\} = x$; derive this equation successively, put $x=0$, and there results:

$$\phi(0) = 1, \quad \phi'(0) = -\frac{1}{2}, \quad \phi''(0) = \frac{1}{6}, \quad \phi'''(0) = 0, \quad \phi^{iv}(0) = -\frac{1}{30}, \text{ etc.}$$

We may, of course, insert these values and so obtain the expansion desired, but it is customary to write it somewhat otherwise, thus:

$$\begin{aligned} \frac{1}{2}x \frac{e^x + 1}{e^x - 1} &= \frac{x}{e^x - 1} + \frac{x}{2} \\ &= 1 + \frac{x^2}{2}B_1 - \frac{x^4}{4}B_2 + \dots + (-1)^{n-1} \frac{x^{2n}}{2n} \cdot B_n + \dots \end{aligned}$$

141. These B 's, called **Bernoulli's Numbers**, having been introduced into analysis by James Bernoulli (1654-1705) in his *Ars Conjectandi*, are of great interest and importance. They are fractions, apparently lawless in their values, yet only apparently. Fifteen were given by *Euler*, the next sixteen by *Rothe*, the next thirty-one by *Adams*, and *Glaisher* has published the first 250 up to nine decimal places, with their (Briggian) logarithms up to ten places. The first nine Bernoullians are in order :

$$\frac{1}{6}, \frac{1}{30}, \frac{1}{42}, \frac{1}{30}, \frac{5}{66}, \frac{691}{2730}, \frac{7}{6}, \frac{3617}{510}, \frac{43867}{798}.$$

Now let the student show that, putting $x=2u$,

$$u \operatorname{ht} u = 1 + \frac{u^2}{2} 2^2 B_1 - \frac{u^4}{4} 2^4 B_2 + \dots + (-1)^{n-1} \frac{u^{2n}}{2n} 2^{2n} B_n + \dots,$$

and putting $u=iv$,

$$v \cot v = 1 - \frac{v^2}{2} 2^2 B_1 - \frac{v^4}{4} 2^4 B_2 - \dots - \frac{v^{2n}}{2n} 2^{2n} B_n - \dots.$$

Also, expand the secant in the vicinity of 0, and writing

$$\sec x = 1 + \frac{x^2}{2} E_1 + \frac{x^4}{4} E_2 + \dots + \frac{x^{2n}}{2n} E_n + \dots,$$

where the E 's are *Euler's Numbers*, show that the first four *Eulerians* are in order : 1, 5, 61, 1385.

EXERCISES.

1. Prove $\log \sec x = \frac{x^2}{2} + 2 \frac{x^4}{4} + 16 \frac{x^6}{6} + 272 \frac{x^8}{8} + \dots$

2. Prove $\tan x = x + \frac{2}{3} x^3 + \frac{2^4}{5} x^5 + \frac{2^4 \cdot 17}{7} x^7 + \dots$

We have $\phi = \tan x$, $\phi' = 1 + \phi^2$, $\frac{1}{2} \phi'' = \phi \cdot \phi'$, etc.

3. Prove $e^{x \cos x} = 1 + x + \frac{x^2}{2} - \frac{x^3}{3} - \dots$, $e^{x \sec x} = 1 + x + \frac{x^2}{2} + \frac{2x^3}{3} \dots$

$$4. \text{ Prove } e^{\sin x} = 1 + x + \frac{x^2}{2} - \frac{3x^4}{4} - \frac{8x^5}{5} - \frac{3x^6}{6} + \dots$$

We have

$$\phi(x) = e^{\sin x}, \quad \phi'(x) = \phi \cdot \cos x, \quad \phi^{(n+1)} = \phi^{(n)} \cos x - n\phi^{(n-1)} \sin x - \text{etc.}$$

$$5. \text{ } e^{\tan x} = 1 + x + \frac{x^2}{2} + \frac{3x^3}{3} + \frac{9x^4}{4} + \dots$$

We have

$$\phi = e^{\tan x}, \quad \phi' = \phi(\sec x)^2 = \phi\psi, \quad \phi'' = \phi'\psi + \phi\psi', \quad \text{etc.}$$

$$6. \text{ Prove } \log \tan \left(\frac{\pi}{4} + x \right) = 2x + \frac{2^3}{3}x^3 + \frac{5 \cdot 2^5}{5}x^5 + \dots, \quad \text{and show that } \log \tan(45^\circ 0' 15'') = 0.00006315.$$

$$7. \text{ Prove } \sin nx = \cos x \left\{ n \sin x - \frac{n(n^2 - 2^2)}{3}(\sin x)^3 + \dots \right\}.$$

$$\cos nx = 1 - \frac{n^2}{2}(\sin x)^2 + \frac{n^2(-n^2 - 2^2)}{4}(\sin x)^4 - \dots$$

We put $\phi(u) = \cos(n \sin^{-1} u) = \cos nx$, and apply Art. 139. The series terminate for n even.

Similarly prove that

$$\sin(nx) = n \sin x - \frac{n(n^2 - 1^2)}{3}(\sin x)^3 + \frac{n(n^2 - 1^2)(n^2 - 3^2)}{5}(\sin x)^5 - \dots,$$

$$\cos(nx) = \cos x \left(1 - \frac{n^2 - 1}{2}(\sin x)^2 + \frac{(n^2 - 1^2)(n^2 - 3^2)}{4}(\sin x)^4 \dots \right),$$

series terminating for n odd.

8. Similarly putting $\phi(u) = \cos(n \cos^{-1} u) = \cos nx$, deduce terminating series in $\cos x$, for $\cos nx$ and $\sin nx$, for n even and for n odd, and by help of these series and the series of 7 obtain *two* expressions each for $\sin 3x$, $\sin 5x$, $\sin 7x$, $\sin 9x$, $\sin 2x$, $\sin 4x$, $\sin 6x$, $\sin 8x$, $\cos 3x$, $\cos 5x$, $\cos 7x$, $\cos 9x$, $\cos 2x$, $\cos 4x$, $\cos 6x$, $\cos 8x$.

9. Expand $\text{hs } x$, $\text{hc } x$, $\text{ht } x$, and $\text{hs}^{-1}x$, $\text{hc}^{-1}x$, $\text{ht}^{-1}x$.

$$10. \text{ Prove } \log(x + \sqrt{1+x^2}) = x - \frac{1}{2} \cdot \frac{x^3}{3} + \frac{1 \cdot 3}{2 \cdot 4} \cdot \frac{x^5}{5} - \dots$$

$$11. \text{ Prove } \frac{1}{x\sqrt{x^2-1}} = \frac{1}{x^2} + \frac{1}{2} \cdot \frac{1}{x^4} + \frac{1 \cdot 3}{2 \cdot 4} \cdot \frac{1}{x^6} + \dots$$

12. $\frac{\log(1+x)}{1+x} = c_1x - c_2x^2 + c_3x^3 - \dots$, where $c_n = 1 + \frac{1}{2} + \frac{1}{3} + \dots + \frac{1}{n}$.
13. Prove $2(\cos x)^2 = c_0 - c_2x^2 + c_4x^4 - \dots$, where $c_n = \frac{2^n}{n}$.
14. Prove $4(\cos x)^3 = k_0 - k_2x^2 + k_4x^4 - \dots$, where $k_n = \frac{3^n + 3}{n}$.
15. Prove $\cos x \operatorname{hc} x = 1 - k_2x^4 + k_4x^8 - \dots$, where $k_{2n} = \frac{2^n}{2n}$.
16. Prove $(1+x)^x = 1 + x^2 - \frac{1}{2}x^3 + \frac{5}{6}x^4 - \frac{3}{4}x^5 + \dots$.
17. Prove $\sin^{-1} \frac{2x}{1+x^2} = 2 \left(x - \frac{x^3}{3} + \frac{x^5}{5} - \frac{x^7}{7} + \dots \right)$.
18. Prove $\cos^{-1} \frac{x^2-1}{x^2+1} = \pi - \sin^{-1} \frac{2x}{1+x^2}$.
19. Prove by expanding $\operatorname{cosec} x$ that $\operatorname{cosec} 8'' \cdot 76 = 23546$, and if this angle be the sun's parallax, then the sun is distant 150,000,000 kilometres (*circa*).
20. In the preceding developments ascertain the limits of convergence.

EVANESCENT OR UNDETERMINED FORMS.

142. Removal of Factors.—It often happens that for a certain value of x , as $x=a$, both numerator and denominator of a fraction, $\frac{\phi(x)}{\psi(x)}$, become 0, and the fraction loses all meaning *in this form*. However, expressions may take many forms, yielding the same value on computation, and it is in fact generally possible to change the form that becomes indeterminate and senseless into some other that retains its sense and yields a definite value, even at the so-called **critical point** $x=a$. When $\phi(x)$ and $\psi(x)$ both vanish for $x=a$, there will generally be present in each, explicitly or implicitly, the factor $x-a$. When this latter

can be detected, the simplest needed change of form is effected by removing it from both ϕ and ψ . Thus the fraction $\frac{x^3 - a^3}{x^2 - a^2}$ takes the meaningless form $\frac{0}{0}$ for $x = a$, because of the presence in both terms of the factor $x - a$. Removing it, supposing $x \text{ not} = a$, we get the equivalent form $\frac{x^2 + ax + a^2}{x + a}$, and this takes the definite value $\frac{3}{2}a$ for $x = a$. In general, if

$$\phi(x) = (x - a)\phi_1(x) \quad \text{and} \quad \psi(x) = (x - a)\psi_1(x),$$

then $\frac{\phi(x)}{\psi(x)}$ takes the undetermined form $\frac{0}{0}$ for $x = a$, but always $= \frac{\phi_1(x)}{\psi_1(x)}$ (for $x \text{ not} = a$), and *this* value remains definite, namely, $\frac{\phi_1(a)}{\psi_1(a)}$, even for $x = a$. If the factor $x - a$ were repeated in both ϕ and ψ , so that

$$\phi(x) = (x - a)^r \phi_1(x), \quad \psi(x) = (x - a)^r \psi_1(x),$$

then we should reject $(x - a)^r$ from both terms.

143. Removal by Derivation.—Often, however, it will be difficult or impossible to recognize the vanishing factor or to perform the division required to reject it. In such cases we may generally employ derivation successfully.

For we may assume $\frac{\phi(x)}{\psi(x)} = \frac{(x - a)\phi_1(x)}{(x - a)\psi_1(x)}$, which we know $= \frac{\phi_1(x)}{\psi_1(x)}$ (for $x \text{ not} = a$), which $= \frac{\phi_1(a)}{\psi_1(a)}$, even for $x = a$.

Now, however,

$$\phi'(x) = \phi_1(x) + (x - a)\phi_1'(x), \quad \psi'(x) = \psi_1(x) + (x - a)\psi_1'(x).$$

Hence, if both $\phi_1'(a)$ and $\psi_1'(a)$ be finite, we have

$$\frac{\phi'(a)}{\psi'(a)} = \frac{\phi_1(a)}{\psi_1(a)},$$

and this we know $= \frac{\phi(a)}{\psi(a)}$.

144. Repeated Factors.—If the factor $(x-a)$ be repeated and present r times in ϕ and ψ , it will require r derivations to remove it, and we shall have

$$\phi^r(x) = \lfloor r \phi_1(x) + \{x-a\}_1, \quad \psi^r(x) = \lfloor r \psi_1(x) + \{x-a\}_2,$$

where $\{x-a\}_1$ and $\{x-a\}_2$ vanish with $x-a$ for *finite* derivatives of ϕ_1 and ψ_1 ; hence

$$\frac{\phi^r(a)}{\psi^r(a)} = \frac{\phi_1(a)}{\psi_1(a)},$$

and this we know
$$= \frac{\phi(a)}{\psi(a)}.$$

145. Illustrations.—Hence, to evaluate such illusory forms as $\frac{0}{0}$, we derive both numerator and denominator and form the quotient of these derivatives for the critical argument-value, as $x=a$; we continue this process until we arrive at a form not illusory for this critical value; the value of this form for the critical x is the value sought.

Thus

$$F(x) = \frac{\phi(x)}{\psi(x)} = \frac{e^x - e^{-x} - 2x}{x - \sin x} \text{ becomes } \frac{0}{0} \text{ for } x=0;$$

$$\frac{\phi'(x)}{\psi'(x)} = \frac{e^x + e^{-x} - 2}{1 - \cos x} \text{ again takes the form } \frac{0}{0} \text{ for } x=0;$$

$$\frac{\phi''(x)}{\psi''(x)} = \frac{e^x - e^{-x}}{\sin x} \text{ still takes the form } \frac{0}{0} \text{ for } x=0;$$

$$\frac{\phi'''(x)}{\psi'''(x)} = \frac{e^x + e^{-x}}{\cos x} = \frac{2}{1} = 2, \text{ for } x=0; \text{ hence } F(0) = 2.$$

Expanding the exponentials and the sine, we find the factor x actually present in third degree, wherefore a third derivation was necessary to remove it entirely:

$$\begin{aligned} \frac{\phi(x)}{\psi(x)} &= \frac{e^x - e^{-x} - 2x}{x - \sin x} \\ &= \frac{1 + x + \frac{x^2}{2} + \frac{x^3}{6} + \frac{x^4}{24} + \dots - \left\{ 1 - x + \frac{x^2}{2} - \frac{x^3}{6} + \frac{x^4}{24} \right\} - 2x}{x - \left\{ x - \frac{x^3}{6} + \frac{x^5}{120} - \dots \right\}} \\ &= \frac{\frac{2}{3}x^3 + \{x^5\}_1}{x^3 + \{x^5\}_2} = \frac{2 + \{3\{x^2\}_1\}}{1 + \{3\{x^2\}_2\}} \text{ (for } x \text{ not } = 0) = 2 \text{ for } x = 0. \end{aligned}$$

The method here followed is often very useful.

146. Application of Taylor's Series.—We may also treat the subject by aid of Taylor's theorem. Developing ϕ and ψ in the vicinity of a we have

$$\frac{\phi(x)}{\psi(x)} = \frac{\phi(a) + (x-a)\phi'(a) + \frac{(x-a)^2}{2}\phi''(a) + \dots + \frac{1}{n}\phi^n\{a + \theta(x-a)\}}{\psi(a) + (x-a)\psi'(a) + \frac{(x-a)^2}{2}\psi''(a) + \dots + \frac{1}{n}\psi^n\{a + \theta(x-a)\}}$$

Now if $\phi(a)=0$ and $\psi(a)=0$, then $x-a$ is plainly a factor of $\phi(x)$ and of $\psi(x)$, or at least of the controlling terms in the expansions of ϕ and ψ . Rejecting it we have

$$\text{Limit}_{x=a} \frac{\phi(x)}{\psi(x)} = \frac{\phi'(a)}{\psi'(a)}$$

If the successive derivatives of both ϕ and ψ vanish for $x=a$ up to but not including the n^{th} , then we have

$$\text{Limit}_{x=a} \frac{\phi(x)}{\psi(x)} = \text{Limit}_{x=a} \frac{\phi^{(n)}\{a + \theta(x-a)\}}{\psi^{(n)}\{a + \theta(x-a)\}} = \frac{\phi^{(n)}(a)}{\psi^{(n)}(a)},$$

always provided that any such limit really exists, that $\phi^{(n)}(x)$ and $\psi^{(n)}(x)$ do not lose their meaning for $x=a$. If they do, then this method of derivation fails.

147. Simplifications.—It often happens that we are able to recognize in ϕ or ψ , or both, certain factors that do *not* vanish, nor become infinite, for the critical value $x=a$. If $f(x)$ be any such factor, we may set it aside and introduce it finally into the result with its proper critical value $f(a)$. This observation is important, since we may thus sometimes greatly simplify and abridge our work. For instance, $u = \frac{\sin x - x \cos x}{(\sin x)^3}$ takes the form $\frac{0}{0}$ for $x=0$. Hence

$$\begin{aligned} \text{Lim}_{x=0} u &= \text{Lim}_{x=0} \frac{\sin x - x \cos x}{(\sin x)^3} = \text{Lim}_{x=0} \frac{\cos x - \cos x + x \sin x}{3(\sin x)^2 \cos x} \\ &= \text{Lim}_{x=0} \frac{x}{3 \sin x} = \frac{1}{3}. \end{aligned}$$

Here $\text{Lim}_{x=0} \cos x = 1$, which we insert instead of $\cos x$. The principle herein assumed is the familiar one: the limit of the product is the product of the limits.

148. The Form $\frac{\infty}{\infty}$.—There are several other illusory forms, all of which may be brought to the fundamental form $\frac{0}{0}$. Thus, if ϕ and ψ both become ∞ for $x=a$, the quotient $\frac{\phi(x)}{\psi(x)}$ takes the form $\frac{\infty}{\infty}$. But we may write

$$\frac{\phi(x)}{\psi(x)} = \frac{1}{\frac{\psi(x)}{\phi(x)}}, \text{ and this latter takes the form } \frac{0}{0}.$$

Deriving now we get .

$$\text{Lim} \frac{\phi(x)}{\psi(x)} = \text{L} \frac{\psi'(x)}{\frac{\psi(x)^2}{\phi(x)^2}} = \text{L} \frac{\psi'(x)}{\phi'(x)} \cdot \frac{\phi(x)^2}{\psi(x)^2} = \text{L} \frac{\psi'(x)}{\phi'(x)} \cdot \text{L} \frac{\phi(x)^2}{\psi(x)^2}$$

Whence, if $\text{L} \frac{\phi(x)}{\psi(x)}$ be not 0 but some definite,

$$L \frac{\phi(x)}{\psi(x)} = L \frac{\phi'(x)}{\psi'(x)};$$

whence it appears that in case ϕ and ψ both become ∞ we may proceed as when they both become 0.

149. Other Illusory Forms.—Another form is $\phi(x) - \psi(x)$ when ϕ and ψ become ∞ . This may be written

$$\phi(x) - \psi(x) = \frac{1}{u} - \frac{1}{v} = \frac{v - u}{uv} = \frac{0}{0},$$

where u and v become 0, as ϕ and ψ become ∞ .

The form $\frac{\phi(x)}{\psi(x)}$, where ϕ tends to 0 and ψ tends to ∞ for $x = a$ may be written $\frac{\phi(x)}{1} = \frac{0}{0}$.

The forms $\phi(x)^{\psi(x)}$, where ϕ tends to 1 and ψ to ∞ , or ϕ to ∞ and ψ to 0, or both tend to 0, assume the illusory forms $1^\infty, \infty^0, 0^0$; to evaluate them we pass to logarithms and proceed as before.

150. Illustrations.—1. For $x = 0, u \equiv \frac{\log \tan x}{\log \tan 2x} = \frac{\infty}{\infty}$. But

$$\text{Lim } u = L \frac{\overline{\sec x^2} \cdot \cot x}{2 \sec 2x^2 \cdot \cot 2x} = \frac{1}{2} L \frac{\sin 2x}{\sin x} = L \frac{\cos 2x}{\cos x} = 1.$$

2. For $x = 1, u \equiv \frac{x}{x-1} - \frac{1}{\log x}$ becomes $\infty - \infty$. But

$$u = \frac{x \log x - x + 1}{(x-1) \log x} = \frac{0}{0}.$$

Hence, by deriving,

$$Lu = L \frac{\log x + 1 - \frac{1}{x}}{\log x + 1 - \frac{1}{x}} = L \frac{\frac{1}{x}}{\frac{1}{x} + \frac{1}{x^2}} = \frac{1}{2}.$$

3. For $x = \infty, u \equiv 2^x \tan \frac{a}{2^x}$ becomes $\infty \cdot 0$. But for $x = -y,$

$$u = \frac{\tan(a \cdot 2^y)}{2^y}, \quad \text{and} \quad L u = L \frac{\tan(a \cdot 2^y)}{2^y} = \frac{0}{0};$$

hence

$$\lim_{y=-\infty} u = \lim_{y=-\infty} \frac{\{\sec(a2^y)\}^2 a \cdot 2^y \cdot \log 2}{2^y \log 2} = a.$$

4. For $x=0$, $u \equiv x^x$ becomes 0^0 . But

$$\log u = x \log x = \frac{\log x}{\frac{1}{x}} \text{ becomes } \frac{0}{0} \text{ for } x=0.$$

$$\text{Hence } L \log u = L \frac{\frac{1}{x}}{-\frac{1}{x^2}} = -x = 0; \quad \therefore u = e^0 = 1.$$

5. For $x = \infty$, $u \equiv x^{\frac{1}{x}}$ becomes ∞^0 . But

$$\log u \equiv \frac{\log x}{x} \text{ becomes } \frac{\infty}{\infty} \text{ for } x = \infty. \text{ Hence}$$

$$L \log u = \frac{\frac{1}{x}}{\frac{1}{x^2}} = 0 \text{ for } x = \infty; \quad \therefore u = e^0 = 1.$$

6. For $x = a$, $u \equiv (2 - x/a)^{\tan \frac{\pi x}{2a}}$ becomes 1^∞ . But

$$\log u \equiv \frac{\log\left(2 - \frac{x}{a}\right)}{\cot \frac{\pi x}{2a}} \text{ becomes } \frac{0}{0} \text{ for } x = a. \text{ Hence}$$

$$L \log u = L \frac{1/a}{\left(2 - \frac{x}{a}\right) \pi / 2a \sin \frac{\pi x}{2a}} = \frac{2}{\pi}; \quad \therefore u = e^{\frac{2}{\pi}}.$$

Here we set aside $\sin \frac{\pi x}{2a}$ with its critical value 1.

Sometimes a slight transformation is more effective than derivation, thus:

7. For $x=0$, $u \equiv x^{\frac{a}{m+n \log x}}$ becomes 0^0 . But

$$\log u = \frac{a \log x}{m + n \log x} = \frac{a}{n} - \frac{am}{n(m + n \log x)} = \frac{a}{n} \text{ for } x=0;$$

$$\therefore u = e^{a/n}.$$

Often **convergent expansions** may be used, thus :

8. For $x=0$, $u \equiv \frac{(1+x)^{\frac{1}{x}} - e}{x} = \frac{0}{0}$. Deriving, we get

$$L u = L(1+x)^{\frac{1}{x}-1} \left\{ \frac{1}{x} - \frac{(1+x) \log(1+x)}{x^2} \right\}.$$

Now $(1+x)^{\frac{1}{x}-1} \equiv \frac{(1+x)^{\frac{1}{x}}}{1+x}$, and this $= e$ for $x=0$. The $\{ \}$
 $= \left\{ \frac{1}{x} - \frac{1}{x} - \frac{1}{2} + \frac{x}{6} - \frac{x^2}{12} + \dots + \right\} = -\frac{1}{2}$ for $x=0$; $\therefore u = -e/2$.

9. For $x=0$, $u \equiv \left(\frac{\tan x}{x} \right)^{\frac{1}{x}}$ becomes $\left(\frac{0}{0} \right)$. But

$$\log u \equiv \frac{1}{x} \log \left(\frac{\tan x}{x} \right) = \frac{1}{x} \log \left(1 + \frac{x^2}{3} + \dots \right) = \frac{1}{x} \left(\frac{x^2}{3} + \{x^4\} \right),$$

and this vanishes for $x=0$; hence $u = e^0 = 1$.

10. For $x=0$, $u \equiv \frac{1}{(\sin x)^3} - \frac{1}{x^3}$ becomes $\infty - \infty$. But

$$u \equiv \frac{x^3 - (\sin x)^3}{x^3(\sin x)^3} = \frac{x^3 - x^3 \left(1 - \frac{x^2}{3} + \frac{x^4}{5} - \dots \right)^3}{x^6 \left(1 - \frac{x^2}{3} + \frac{x^4}{5} - \dots \right)^3} = \infty \text{ for } x=0.$$

Often a derivative presents itself under an illusory form and must then be evaluated by one of the foregoing methods, thus :

11. In $y^4 - a^2y^2 + 2a^2x^2 - x^4 = 0$, $y_x = \frac{2(x^3 - a^2x)}{2y^3 - a^2y}$ and this takes the form $\frac{0}{0}$ at the origin $(0, 0)$. But

$$L_{(0,0)} y_x = L_{(0,0)} \frac{6x^2 - 2a^2}{6y^2 - a^2} \cdot \frac{1}{y_x} = L \frac{6x^2 - 2a^2}{6y^2 - a^2} \cdot L \frac{1}{y_x};$$

whence $(L_{(0,0)} y_x)^2 = 2$, $L_{(0,0)} y_x = \pm \sqrt{2}$.

The graph of this equation is of 4th degree and has a **double point** at the origin. Let the student construct the curve in the vicinity of the origin and draw the two symmetric tangents.

NOTE.—It must be carefully observed that in the foregoing division of numerator and denominator by the common factor $x-a$ it is assumed that x does *not* equal a , but $x \neq a$. For $x=a$ this division would lose all sense. The most we can affirm of $\frac{\phi(x)}{\psi(x)} \equiv \frac{(x-a)\phi_1(x)}{(x-a)\psi_1(x)}$ is that it equals $\frac{\phi_1(x)}{\psi_1(x)}$ for all values of x not equal to a , that is, for $x \neq a$, and that it approaches the value $\frac{\phi_1(a)}{\psi_1(a)}$ as its **limit** as x approaches the critical value a indefinitely.

EXERCISES.

1. Show that $L \frac{x^4 - 5x^2 + 4}{x^4 - 3x^2 - 4}$ for $x = \pm 2$ is $\frac{3}{5}$.
2. Prove $L \frac{\sqrt{a+x} - \sqrt{2a}}{\sqrt{a+2x} - \sqrt{3a}} = \sqrt{\frac{3}{8}}$ for $x=a$.
3. Prove $L \frac{x^3 - 4ax^2 + 7a^2x - 2a^3 - 2a^2\sqrt{2ax-a^2}}{x^2 - 2ax - a^2 + 2a\sqrt{2ax-a^2}} = -5a$ for $x=a$.
4. Prove $L \frac{\sqrt{x} - \sqrt{a} + \sqrt{x-a}}{\sqrt{x^2-a^2}} = \frac{1}{\sqrt{2a}}$ for $x=a$. [Put $x=a+h$.]
5. Prove $L \frac{x - (n+1)x^{n+1} + nx^{n+2}}{(1-x)^2} = \frac{n(n+1)}{2}$ for $x=1$.
6. Prove $L \frac{x^x - x}{1-x + \log x} = -2$ for $x=1$.
7. Prove $L \frac{(x-2)e^{2x} + (x+2)e^x}{(e^x-1)^3} = \frac{1}{6}$ for $x=0$.
8. Prove $L \frac{x - \sin x}{x^3} = \frac{1}{6}$ for $x=0$.
9. Prove $L \frac{\sin x}{x^2} = \pm \infty$ according as x nears 0 from + or - side.
10. Prove $L \frac{\text{hs } x - x}{\sin x - x} = -2$ for $x=0$.
11. Prove $L \frac{\sin x - x \cos x}{(\sin x)^3} = \frac{1}{3}$ for $x=0$.

12. Prove $L \frac{\log \tan x}{\log \tan 2x} = 1$ for $x=0$.
13. Prove $L \{\overline{\operatorname{cosec} x^n - x^{-n}}\} = 0, \frac{1}{3}, \infty$ for $x=0$ and $n=1, 2, 3$.
14. Prove $L \left\{ \frac{1}{\log x} + \frac{1}{1-x} \right\} = \frac{1}{2}$ for $x=1$.
15. Prove $L \left\{ \frac{1}{\log(1+x)} - \frac{1}{x} \right\} = \frac{1}{2}$ for $x=0$.
16. Prove $L \left\{ \frac{\pi x - 1}{2x^2} + \frac{\pi}{x(e^{\pi x} - 1)} \right\} = 1 + \frac{1}{4} + \frac{1}{9} + \dots = \frac{\pi^2}{6}$ for $x=0$,
and $L \left\{ \frac{\pi}{4x} - \frac{\pi}{2x(e^{\pi x} + 1)} \right\} = 1 + \frac{1}{9} + \frac{1}{25} + \dots = \frac{\pi^2}{8}$ for $x=0$.
17. $L x^n \log x = 0$ for $x=0$, $n > 0$, but $= \infty$, $n \leq 0$. Thus it appears that $\log x$ increases (negatively) without limit as x nears 0, but its infinity is of lower than any finite order. Examine the same expression for $x = \infty$.
18. Prove $L x^x = 1$ for $x=0$.
19. Prove $L x^{x^n} = 1$ or 0 for $x=0$ according as $n > 0$ or < 0 .
20. Prove $L \left(\frac{\tan x}{x} \right)^{\frac{1}{x^n}} = 1, e^{\frac{1}{3}}, \infty$ for $x=0$ according as $n=1, 2, 3$.
21. Prove $L(1+sx)^{\frac{1}{x}+c} = e^s$ for $x=0$.
22. Prove $L x^{\frac{1}{x-1}} = e$ for $x=1$.
23. Prove $L \frac{\log x}{x-1} = 1$ for $x=1$ and $L \frac{a^x - b^x}{x+1} = \log \frac{a}{b}$ for $x=-1$.
24. Prove $L \frac{a + bx + cx^2 + \dots + lx^n}{A + Bx + Cx^2 + \dots + Lx^m} = 0, \frac{l}{L}, \infty$ for $x = \infty$ according as $m > n, m = n, m < n$; and $= \frac{a}{A}$ for $x=0$.
25. Prove $L \{ \operatorname{he} x - \cos x - x^2 \} / x^6 = \frac{1}{360}$ for $x=0$.
26. Prove $L \left\{ \frac{\sin u}{u} \right\}^{\binom{a}{u}^n} = 1, e^{-\frac{a^2}{6}}, 0$ for $u=0$, and $n=1, 2, 3$.
27. For $x = \frac{\pi}{2}$, prove $(\sin x)^{\tan x} = 1, (\sin x)^{(\tan x)^2} = e^{-\frac{1}{2}}$.

28. For $x = \infty$, $\sqrt[n]{a+x} = 1$, $\sqrt[n]{x^n+a^n} - x = 0$, $\left(1 + \frac{1}{x}\right)^x = e$.

29. Prove that $x^3 + y^3 - 3axy = 0$ has a double point at origin, and find values of y_x there.

30. Similarly for $(x^2 + y^2) = a^2(x^2 - y^2)$, $y^4 + (a^2 + x^2)y^2 = a^2x^2$,
 $(y^2 + ax)^2 = x^2(a^2 + 2ax - x^2)$, and $(y^2 - x^2)^2 = x^3 - 2axy^2$.

Ans. $y_x = \pm 1, \pm 1, \pm 1, \pm 1/\sqrt{2a}$. Interpret geometrically.

MAXIMA AND MINIMA.

151. Definitions.—When a varying magnitude increases up to but not above a certain value and then decreases, that value is called a **maximum**; when a varying magnitude decreases down to but not below a certain value and then increases, that value is called a **minimum**.

If the series of values through which the variable moves be discontinuous we may say that a maximum is greater, a minimum is less, than the adjacent values; thus in the Binomial expansion of even powers, the coefficient of the mid-term is the maximum. But if the series be continuous, then the notion of *adjacent* values is no longer exactly definable, and we must substitute the notion of values *close at will* in the series of values, saying a maximum is greater, a minimum is less, than any value close at will to it in the series of values of the variable. Symbolically, $f(a)$ is a maximum of $f(x)$ when $f(a) > f(a \pm h)$, and a minimum when $f(a) < f(a \pm h)$, h being *small at will*.

152. Relativity.—We notice that in these notions there is no reference to *absolute* but only to *relative* size; in fact, a maximum may very well be less than a minimum. Thus a boy may inflate his balloon to a diameter of 12 inches, then let it shrink to one of 10 inches; then inflate

it to 14 inches, then let it shrink to 6 inches; re-inflate it to 9 inches, let it shrink again, and so on. In this case 12, 14, 9 are the maximal diameters, while 10, 6 are the minimal; they alternate with each other, and the maximal 9 is less than the minimal 10.

153. General Analytic Condition.—The analytic problem of Maximum-Minimum is this: *Given any function of the argument x , as $u=f(x)$, required to find the values of x for which u is a maximum or a minimum.* The definition of Art. 151 yields us readily a *necessary* condition. For if we suppose x increasing, as we may, then so long as u increases the derivative u_x is *positive*, being the limit of the quotient of two positives Δy and Δx , or of two negatives $-\Delta y$ and $-\Delta x$; but so long as u decreases the derivative u_x is *negative*, being the limit of the quotient of a positive and a negative, Δy and $-\Delta x$ or $-\Delta y$ and Δx . Hence at that value of x which yields a maximum the derivative u_x must change its sign, with increasing x from $+$ to $-$; while at that value of x which yields a minimum the derivative u_x must also change its sign, but with increasing x from $-$ to $+$. This change of sign of the derivative u_x , from $+$ to $-$ for maximum, from $-$ to $+$ for minimum, is the *necessary* and *sufficient condition* that a value of x yield maximum or minimum of u .

154. Conditions in Detail.—If now u_x be *finite* and *continuous*, it can change its sign only in passing through the value 0; hence the *general condition*: For values of x that can yield a maximum or a minimum of u , the **first derivative u_x must vanish.** But even for u_x finite and continuous this condition though necessary is not *sufficient*. For u_x might sink down to the value 0 and then rise up from the value 0, and thus vanish, attaining the value 0 but not passing through the value 0, *not*

changing its sign. In that case the function u would increase more and more slowly, at last *stop* increasing and immediately *begin* again without ever decreasing at all. To test whether the derivative u_x actually *changes sign* when it vanishes, we must form the second derivative u'' or u_{2x} . While u_x is decreasing, sinking down to 0, the second derivative u_{2x} is negative; if now u_x passes through 0, keeps on decreasing, then u_{2x} remains negative; hence, *if $u_x=0$ and u_{2x} is negative, then u is maximum* for that critical x . On the other hand, if u_x sinks down to 0, but does not pass through 0, and then rises up from 0, then u_{2x} must first be negative for decreasing u_x and afterwards positive for increasing u_x ; that is, u_{2x} *must change its sign* from $-$ to $+$. But u_{2x} can change its sign, if it be *finite* and *continuous*, only in passing through 0. By precisely similar reasoning, which is left for the student to repeat, we show that if $u_x=0$ and u_{2x} be positive, then u is a minimum for that critical x ; while only if $u_{2x}=0$ may u_x increase up to 0 and then decrease down from 0 without ever changing its sign by passing through 0. Hence, finally,

$u_x=0$ is the *necessary* condition of change of sign in u_x ,
that is, of maximum or minimum, u_x being finite
and continuous. If then

$u_{2x} < 0$, u is a maximum for that critical x ; if

$u_{2x} > 0$, u is a minimum for that critical x ; if

$u_{2x} = 0$, the character of u remains undetermined.

155. Continued Vanishing of Derivatives.—If $u_{2x}=0$, quite similar reasoning will show that $u_{3x}=0$ is then the *necessary* condition of maximum or minimum, and that u will be maximum, or minimum, or perhaps neither, according as $u_{4x} < 0$, or > 0 , or $= 0$. In this last case we should then repeat with respect to u_{5x} and u_{6x} the preceding arguments with respect to u_x and u_{2x} , u_{3x} and u_{4x} . Let u_{nx} be the *lowest derivative* that does *not* vanish

then if n be **even**, u will be *maximum* or *minimum* according as $u_{nx} < 0$ or > 0 ; but if n be **odd**, then u is neither maximum nor minimum for the critical x in question. Throughout this reasoning the derivatives are supposed *finite* and *continuous*.

156. Use of Taylor's Theorem.—On the same supposition we obtain the same results by examining the behaviour of the function in the vicinity of a critical argument-value by help of Taylor's Theorem. For we have seen that if $f(a)$ be maximum or minimum, then the function-difference $f(a \pm h) - f(a)$ must *not* change sign with h , for h small at will. Now

$$f(a \pm h) - f(a) = \pm h f'(a) + \frac{h^2}{2} f''(a) \pm \frac{h^3}{3} f'''(a) \pm \dots \pm \frac{h^n}{n} f^{(n)}(a \pm \theta h).$$

It is evident that the signs of the *odd* terms *do* change and that the signs of the *even* terms *do not* change with h ; also, when the derivatives are finite and h small at will the term actually present with the lowest power of h will control the sign of the whole right-hand member—by making h small enough we can make that term $>$ the sum of all the others. Hence if this term be an **odd** one, or what is the same, if the lowest non-vanishing derivative be **odd**, then the left side does change sign with h , that is, $f(a)$ is greater than neighbouring values on one side of it, but less than neighbouring values on the other side; hence $f(a)$ is neither maximum nor minimum. But if this term be **even**, *i.e.*, if the lowest non-vanishing derivative be **even**, then the left side does *not* change sign with h , *i.e.*, either $f(a)$ is $>$ both $f(a+h)$ and $f(a-h)$ or $f(a)$ is $<$ both $f(a+h)$ and $f(a-h)$; hence $f(a)$ is either maximum or minimum. If this lowest even derivative (non-vanishing) be > 0 , then $f(a \pm h)$ is $> f(a)$, *i.e.*, $f(a)$ is a **minimum**; but if this derivative be < 0 , then $f(a \pm h)$ is $< f(a)$, *i.e.*, $f(a)$ is **maximum**.

157. Geometric Interpretation.—The geometric meaning of the condition $u_x=0$ is that the *tangent* to the curve $f(x)=u$, at the critical value of x , is *parallel to the x -axis*. Such will generally be the case at maximal and

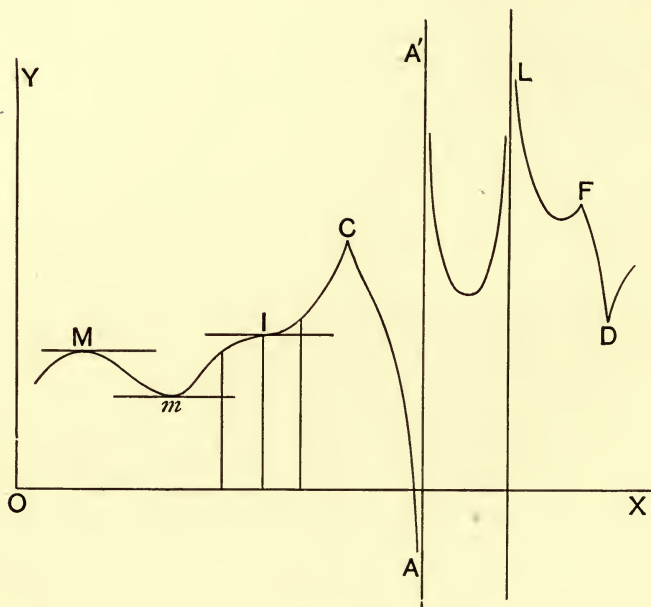

FIG. 19.

minimal points, as the figure indicates. But the tangent when thus parallel to x -axis may *cut* the curve at the point of contact, in which case there may be neither maximum nor minimum, as the figure also shows. This case is that of the vanishing of u_{2x} . This second derivative of u is the first derivative of u_x , *i.e.*, of the tangent of the slope of the tangent-line to the x -axis; as x increases this tangent-line rolls clockwise round the curve in the vicinity of a maximum, but counter-clockwise in the vicinity of a minimum. But for $u_{2x}=0$ this tangent-line may change from rolling clockwise to rolling counter-clockwise. Such a point where this sense of the rolling, and accordingly

the second derivative, changes sign is called a **point of inflexion**.

158. Rule for Practice.—We have then this *rule* for discovering maxima and minima: Derive the given function u as to x ; put the first derivative $u_x=0$; find the roots, $x_1, x_2, \dots x_n$ of this equation. Form the second derivative u_{2x} ; substitute in it these roots in place of x ; such roots as make this second derivative $u_{2x} > 0$ yield minimal values of u , such as make $u_{2x} < 0$ yield maximal values of u , but such as make $u_{2x} = 0$ may yield only points of inflexion in the graph $u=f(x)$. To test these we then form the higher derivatives, and reason concerning the successive pairs as concerning the first pair, u_x and u_{2x} .

159. Exceptional Cases.—Thus far the derivatives have been supposed finite and continuous, but such is not always the case. If the first derivative becomes ∞ , it may or may not change sign in passing through this value ∞ . A notable instance of change of sign is seen in the logarithmic sine, $u = \log \sin x$. Here we have

$$u_x = \frac{\cos x}{\sin x} = \cot x.$$

For $x=0$ (and supposed increasing) u_x leaps from $-\infty$ to $+\infty$; for $x=\pi$, it leaps from $+\infty$ to $-\infty$; and so on.

The simple function $u = \log x$ behaves similarly, $u_x = \frac{1}{x}$.

But in case of $u = -\frac{1}{x}$, we have $u_x = \frac{1}{x^2}$. This u_x becomes

∞ for $x=0$, but does *not* change sign. As x approaches 0, u_x rises towards ∞ ; as x passes through 0 and goes on increasing, u_x rises to ∞ but does not pass through it nor change sign, but sinks back into finity through the same series of positive values. In general, if $u = \frac{1}{x^n}$, then

u_x will or will not change sign for $x=0$ according as n is even or odd, as the student may readily show. Hence we should also test for maxima and minima by putting

$u_x = \infty$, and then observing whether or not it changes sign on increasing thus beyond limit.

160. Discontinuities.—If the derivatives be not continuous but finitely discontinuous, it is plain that u_x may change sign by springing, say, from the value $+3$ to -2 , or from -4 to $+\frac{1}{7}$. Such cases must in general be treated on their own merits by observing at what points or for what values of x such discontinuity in u_x takes place, and then examining the behaviour of u and u_x , or the character of the graph $u=f(x)$, in the immediate neighbourhood of such points. Such cases are illustrated in the *Exercises*. See Fig. 19.

161. Geometric Problems.—Hitherto the function u to be maximized or minimized has been supposed known, *given*. But in the most interesting problems, geometrical and mechanical, this function is *not given* but is only *implied* in the given conditions of the problem. The preliminary step will then be to *form this function*, after which formation the preceding methods are to be applied. It will very often, in fact generally, happen that this function u may be much more readily and elegantly expressed through *two* or more variables, as x and y , or x, y, z , than through a single one x . But in that case there will be found *one* or more equations of condition connecting these variables. If u be expressed through n variables, we must discover $(n-1)$ *equations of condition* connecting these n variables. Having found these $(n-1)$ equations, we may use them to eliminate $(n-1)$ of the variables, and thus leave u expressed through a single variable, as x . If this elimination, however, promise to be too tedious or difficult, we may merely *suppose* it performed, treat each of the $(n-1)$ variables as an unknown function of the one leading variable, as x , and then form u_x and equate it to 0 as already explained. This u_x will then contain *besides* x the $(n-1)$ other variables

and their first derivatives as to x ,—in all, $2n-2$ auxiliary variables. But we have $(n-1)$ equations of condition; these derived as to x yield us $(n-1)$ other equations of condition, or $(2n-2)$ such equations in all. With these we may now eliminate the $(2n-2)$ auxiliary variables and get a single equation in the single variable x . As derivation is often a simplifying process, it will often be easier to eliminate $(2n-2)$ variables after derivation than $(n-1)$ before. A still more elegant method of elimination by help of *Undetermined Multipliers* will be treated in a subsequent section.

162. Simplifications.—Various reflections will sometimes avail to simplify the function to be maximized or minimized. Thus if u be maximum or minimum, so are $u \pm c$, cu , u^n and $\log u$, while $\frac{c}{u^n}$ is minimum or maximum; and some one of these may be easier to deal with than u itself. Also, geometrical or mechanical considerations will often decide at once whether a certain critical value of x makes u a maximum, or a minimum, or neither, without investigation of higher derivatives. Such considerations will sometimes indicate unequivocally and very directly the maximum or minimum sought where the regular analytic process would be exceedingly complicated; they may even disclose the maximum or minimum when the analytic method would not at all.

EXERCISES.

1. Investigate $u \equiv f(x) \equiv ax - x^2$ for maxima and minima.

$$u' \equiv a - 2x, \text{ which vanishes for } x = \frac{a}{2},$$

$$u'' \equiv -2, \text{ which is negative for } x = \frac{a}{2};$$

$$\text{hence } u \text{ is max. for } x = \frac{a}{2}, \text{ and then } u = \frac{a^2}{4}.$$

Herewith is solved the problem of finding the maximum rectangle of given perimeter. For, let $2a$ be the perimeter, x one of the sides, then $a - x$ is a concurrent side and $ax - x^2$ is the area. Hence the maximum rectangle is a square of side $a/2$.

2. Investigate for maxima and minima $u = x^2\sqrt{4a^2 - x^2}$.

$$u' = 2x\sqrt{4a^2 - x^2} - \frac{x^3}{\sqrt{4a^2 - x^2}}; \text{ this vanishes for } x = 0, \text{ and}$$

for $x = \pm \frac{2}{3}a\sqrt{6}$. Also

$$u'' = \frac{(4a^2 - x^2)(8a^2 - 9x^2) + x^2(8a^2 - 3x^2)}{(4a^2 - x^2)^{\frac{3}{2}}}.$$

For $x = 0$, u'' is $+$; hence u is a minimum and $= 0$. For $x = \pm \frac{2}{3}a\sqrt{6}$, u'' is $-$; hence u is a maximum and $= \frac{1}{9}a^3\sqrt{3}$.

3. When is $u \equiv x^x$ maximal or minimal?

$u' = x^x(\log x + 1)$; this vanishes for $\log x = -1$, $x = 1/e$.

$$u'' = x^x \left\{ (\log x + 1)^2 + \frac{1}{x} \right\}, \text{ and this } = e \left(\frac{1}{e} \right)^{\frac{1}{e}} \text{ and is } + \text{ for } x = \frac{1}{e}.$$

Hence x^x is minimal and $= \left(\frac{1}{e} \right)^{\frac{1}{e}}$. There is no maximum.

4. When is $u \equiv \left(\frac{a}{x} \right)^x$ maximal or minimal?

$u' = u(\log a - \log x - 1)$; $u' = 0$ for $\log a/x = 1$, $x = a/e$.

$u'' = u'(\log a/x - 1) - u/x$; $u'' = -u/x$ for $x = a/e$; or

$u'' = -\frac{e}{a}(e)^{\frac{a}{e}}$, which is $-$ or $+$ according as a is $+$ or $-$.

Hence $u = e^{\frac{a}{e}}$ is maximal or minimal according as a is $+$ or $-$.

5. $u = \sin x$, $u' = \cos x$, $u'' = -\sin x$. Hence

$$u' = 0 \quad \text{for } x = (2n + 1)\pi/2;$$

$$u'' = -1 \quad \text{for } x = (4n + 1)\pi/2;$$

$$\text{and } u'' = +1 \quad \text{for } x = (4n + 3)\pi/2.$$

These results are evident from the well-known form of the curve. Similarly investigate $u = \cos x$.

6. $u = \sin x \cos 2x.$

$$u' = \cos x \cos 2x - 2 \sin x \sin 2x = \cos x \{\overline{\cos x^2} - 5 \overline{\sin x^2}\}.$$

$$u' = 0 \text{ for } x = (2n \pm 1)\pi/2, \text{ and for } x = 2n\pi \pm \sin^{-1} \sqrt{\frac{1}{6}}.$$

$$u'' = -\sin x(1 - 6 \overline{\sin x^2}) - 12 \sin x \overline{\cos x^2} = \sin x \{18 \overline{\sin x^2} - 13\}.$$

For $x = 2n\pi + \pi/2$, $\sin x = 1$, u'' is +, $u = -1$, a minimum.

For $x = 2n\pi - \pi/2$, $\sin x = -1$, u'' is -, $u = +1$, a maximum.

For $x = 2n\pi + \sin^{-1} \sqrt{\frac{1}{6}}$, $\sin x = \sqrt{\frac{1}{6}}$, u'' is -, $u = \frac{1}{9} \sqrt{6}$, a max.

For $x = 2n\pi - \sin^{-1} \sqrt{\frac{1}{6}}$, $\sin x = -\sqrt{\frac{1}{6}}$, u'' is +, $u = -\frac{1}{9} \sqrt{6}$, a min.

7. Find the dimensions of a cylindrical cup of constant volume c^3 and of minimal surface.

Let x = its height, y = radius of base. Then

$$u = 2\pi xy + \pi y^2 \text{ and } \pi xy^2 = c^3.$$

Hence $u = 2c^3/y + \pi y^2$, $u_y = -2c^3/y^2 + 2\pi y$, which = 0 for $\pi y^3 = c^3$, which = πxy^2 ; hence $x = y$; *i.e.*, the height equals the radius of the base. Without eliminating x we have

$$u' = 2\pi y + 2\pi xy' + 2\pi yy', \text{ and } \pi y^2 + 2\pi xy y' = 0.$$

Whence $y' = -y/2x$, and for $u' = 0$, $y' = -y/(x+y)$; hence, as before, $x = y$.

8. Find the rectangle of maximal area inscriptible in the ellipse $\frac{x^2}{a^2} + \frac{y^2}{b^2} = 1$.

The sides must be parallel to the axes and bisected by them; hence $u = 4xy$, whence $y + xy' = 0$. Also $\frac{x}{a^2} + \frac{yy'}{b^2} = 0$; so that $\frac{x^2}{a^2} - \frac{y^2}{b^2} = 0$, $\frac{x}{y} = \frac{a}{b}$; *i.e.*, the equi-conjugate diameters are diagonals of the rectangle.

9. Find the dimensions of a conical tent of given volume c^3 , and of minimal spread of canvas.

x = altitude, y = radius of base; $\frac{1}{3}\pi y^2 x = c^3$, and $\pi y \sqrt{x^2 + y^2}$ or $y^2(x^2 + y^2)$ is to be minimized. Hence $2yy'x + y^2 = 0$, $2yy'x^2 + 2y^2x + 4y^3y' = 0$; whence $x^2 + 2y^2 = 2x^2$, $x = y\sqrt{2}$.

Here, as in many problems of geometry and mechanics, it is unnecessary to consider higher derivatives, for it is plain there is a minimum, and equally plain that $y=0$ cannot yield it; hence the other relation must yield it.

10. Show that $\frac{(x+2)^3}{(x-3)^2}$ is maximum for $x=3$, minimum for $x=13$.

11. Show that $\sec x + \operatorname{cosec} x$ is maximum for $x = \pi/4$.

12. Examine $x^5 - 6x^4 + 6x^3 - 4$ for maximum and minimum.

13. Show that $x^3 - 3x^2 + 6x - 5$ has neither maximum nor minimum.

14. If $y' = (x-1)^4(x-2)^3(x-3)^2(x-4)$, discuss the curve near $x=1, 2, 3, 4$.

15. Show that 20 is a maximum and 19 a minimum of

$$4x^5 - 5x^4 + 20.$$

16. Prove that $-\frac{a+b+2\sqrt{ab}}{a+b-2\sqrt{ab}}$ is minimum, and its reciprocal maximum of $\frac{(x-a)(x-b)}{(x+a)(x+b)}$.

17. Prove that e is a minimum of $x/\log x$.

18. Show that $(0, 0)$ and $(a\sqrt[3]{2}, a\sqrt[3]{4})$ are maxima and minima points of $x^3 + y^3 = 3axy$.

Here $y' = \frac{x^2 - ay}{ax - y^2}$; hence for $y' = 0$, $ay = x^2$, whence the pairs of values. For $x=0, y=0$ both y' and y'' take the form $0/0$, but the limits are $y' = 0, y'' = \frac{2}{3}a$.

19. Show that $(\sin x)^2(\cos x)^3$ is maximum for $\tan x = \frac{2}{3}$, and generalize.

20. Prove that the radius of the circle about the origin and touching $\frac{x}{a} + \frac{y}{b} = 1$ is $\frac{ab}{\sqrt{a^2 + b^2}}$.

21. The central equation of a conic is $kx^2 + 2hxy + jy^2 = 1$; show that the radii of the inscribed and circumscribed circles are the roots of the quadratic $(ar-1)(br-1) = h^2r^2$.

22. Find the cone of maximum volume inscriptible in a given sphere.
23. Find the cone of maximum convex surface inscriptible in a given sphere.
24. Find the sphere which, being placed in a given conical cup full of water will displace a maximum.
25. Find the maximum rectangle that can be cut out of a given trapezoid.
26. Find the maximum rectangle that can be cut out of a given triangle.
27. Find the maximum rectangle inscriptible in a half-circle.
28. Out of four given tracts a, b, c, d construct the maximum quadrangle.

Hint: Let $\theta = \angle$ between a and d , $\phi = \angle$ between b and c . Then $a^2 + d^2 - 2ad \cos \theta = b^2 + c^2 - 2bc \cos \phi$, and we have $ad \sin \theta + bc \sin \phi$ to maximize. Whence

$$\phi_{\theta} = -\frac{ad \cos \theta}{bc \cos \phi} = \frac{ad \sin \theta}{bc \sin \phi}, \quad \sin \phi \cos \theta + \sin \theta \cos \phi = 0,$$

$\phi + \theta = \pi$, the quadrangle is encyclic.

29. The general equation of the conic is

$$kx^2 + 2hxy + jy^2 + 2gx + 2fy + c = 0;$$

show that for

$$x = \left\{ \begin{array}{l} F\sqrt{kj} \mp h\sqrt{F^2 - CJ} \\ C\sqrt{kj} \end{array} \right\},$$

$$y = \left\{ \begin{array}{l} -G\sqrt{kj} \pm j\sqrt{F^2 - CJ} \\ C\sqrt{kj} \end{array} \right\}$$

is a maximum respectively minimum, where the large letters are the co-factors of the corresponding small letters in the quadric,

$$\Delta = \begin{vmatrix} k & h & g \\ h & j & f \\ g & f & c \end{vmatrix}.$$

30. Show that $\frac{3}{8}\sqrt{3}$ is a maximum of $\sin x \cdot \sin y \cdot \sin z$ when $x + y + z = \pi$.
31. Show that 3 and $\frac{1}{27}(-1 + 7\sqrt{7})$ are maxima, while -1 and $\frac{1}{27}(-1 - 7\sqrt{7})$ are minima of $\cos x + \cos 2x + \cos 3x$.

32. Of all triangles having given base and given perimeter, find the one with maximum area.
33. Of all triangles having a given angle 2α and given area a^2 find the one of least perimeter.
34. From a point of a given circle draw two chords forming a given (peripheral) angle, so that the sum of the chords and the intercepted arc may be maxima. *Ans.*—The diameter through the point must halve the angle at the point.
35. Find the circular sector of fixed area and minimal boundary.
36. Find the maximum quadrangle with given diagonals inscribed in a given circle.
37. Find maximum or minimum quadrangle with given angles and perimeter. *Ans.*—The quadrangle must circumscribe a circle.
38. Find the right circular cylinder of given volume and least surface. *Ans.*—It is inscriptible in a cube.
39. Find the cone of given convex surface and maximum volume. *Ans.*—Squares of radius of base, height, and slant height are as $1 : 2 : 3$.
40. Find the cone of given total surface and maximum volume. *Ans.*—Slant height = $3(\text{radius of base})$.
41. Inscribe in a given cone a cylinder of maximum convex surface. *Ans.*—Height = diameter of base.
42. Show that in a given sphere the same inscribed cone has both maximum volume and maximum convex surface. If $f(a)$ be maximum respectively minimum of $f(x)$, then there must be two values $f(a+h)$ and $f(a-h')$, for h and h' very small that are equal, both less respectively greater than $f(a)$. This fact is often useful in solving geometric problems.
43. A ray of light from A strikes a surface S at P and is refracted to B ; the velocity before refraction is v and

after refraction v' ; find the relation of the angles of incidence and refraction, i and i' , when the time is a minimum. (Fermat.)

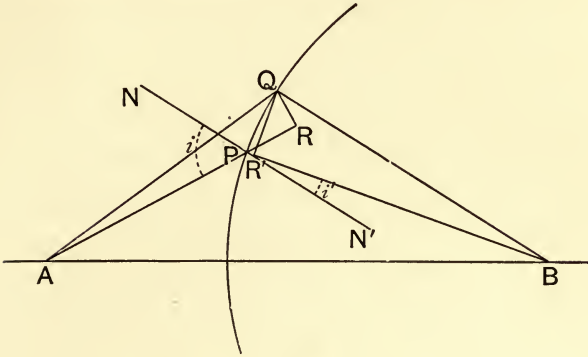

FIG. 20.

Let APB and AQB be two paths described in the same time t , and close at will to each other. Then

$$AP/v + PB/v' = t = AQ/v + QB/v'.$$

Hence $PR/v = PR'/v'$, where QR and QR' are elementary arcs of circles about A and B as centres, and the limits of their ratios to the corresponding rectilinear elements are 1. Hence we have $v/v' = \text{Lim } PR/PR' = \sin i/\sin i'$, which is *Snell's Law of Refraction*.

Sometimes purely geometric considerations readily yield results only with difficulty to be reached by analysis.

44. Find a point the sum of whose distances from three fixed points A, B, C is a minimum. Suppose the sum of the distances from A and B to be what you will, as s ; then the point P is somewhere on an ellipse of axis major s about A and B as foci, and the distance d from C will be least for the point on the normal to this ellipse from C ; and this normal CP bisects the angle APB . Similarly, AP and BP must bisect BPC and CPA ; hence AP, BP, CP trisect the round angle at P .

This celebrated problem, proposed by Fermat to Torricelli, was solved by him in three ways and communi-

cated to Viviani, who also solved it *non nisi iteratis oppugnationibus*. Let the student show that P is found by constructing through A, B, C an equilateral triangle and drawing normals to the sides through A, B, C .

Still otherwise, mechanically, thus: Suppose a continuous homogeneous elastic band to pass round smooth pegs at A, B, C, P ; then the three tensions from P to A, B, C will be equal, and hence the three angles at P will be equal, and the total length $PA + PB + PC$ will be minimum in equilibrium.

45. Show that DEF is a triangle of minimum perimeter inscribed in ABC when AD, BE, CF are altitudes of the triangle ABC .

46. Find the radius of the circle where the segment of an arc of given length s is a maximum. *Ans.*— $r = s/\pi$.
This problem is solved geometrically in Pappus' *Collections*.

47. Find the point on the centre line between two spheres whence the greatest amount of sphere-surface may be seen. *Ans.*—The centre-tract is divided in the ratio

$$r^{\frac{3}{2}} : r'^{\frac{3}{2}}.$$

48. Find the greatest ellipse and parabolic arc that may be cut from a given cone.

CHAPTER IV.

GEOMETRICAL INTERPRETATION OF HIGHER DERIVATIVES.

163. Order of Contact.—Let $y=f(x)$ and $\eta=\phi(x)$ be equations of two curves referred to the same rectangular axes, and let us, if possible, develop both f and ϕ in the neighbourhood of $x=a$. Then

$$y \equiv f(x) = f(a) + (x-a)f'(a) + \frac{(x-a)^2}{2}f''(a) + \dots$$

$$+ \frac{(x-a)^n}{n}f^{(n)}\{a + \theta(x-a)\}.$$

$$\eta \equiv \phi(x) = \phi(a) + (x-a)\phi'(a) + \frac{(x-a)^2}{2}\phi''(a) + \dots$$

$$+ \frac{(x-a)^n}{n}\phi^{(n)}\{a + \theta(x-a)\}.$$

When convenient we may put $x=a+h$, $x-a=h$.

$$y - \eta = f(x) - \phi(x)$$

$$= f(a) - \phi(a) + (x-a)\{f'(a) - \phi'(a)\} + \frac{(x-a)^2}{2}\{f''(a) - \phi''(a)\} + \dots$$

This expression $y - \eta$ is the distance apart of the two curves measured on a common ordinate corresponding to the common abscissa x : the curves are far apart or close together according as $y - \eta$ is large or small. If the curves meet for $x=a$, then let b be the common value of y and η ; the curves have then contact of *zerorth* order at the point (a, b) , and the term $f(a) - \phi(a)$ falls away. Let us consider

the relations of the curves near this common point. For $x-a$ (or h) small at will, the first term of the difference $y-\eta$, namely $(x-a)\{f'(a)-\phi'(a)\}$, may be made to control the sign of the whole difference, for the sum of all the other terms may be made smaller than this first term, the derivatives of course supposed finite. Also, for the same value of $x-a$ the difference $y-\eta$ will be smaller or greater according as more or less of the corresponding derivatives $f'(a)$ and $\phi'(a)$, $f''(a)$ and $\phi''(a)$, are equal.

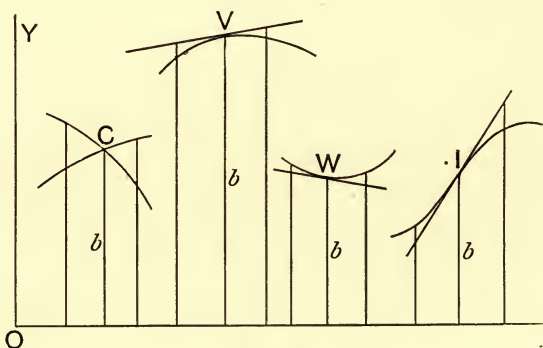

FIG. 21.

Hence the curves lie close together near (a, b) or part abruptly according as more or less of the successive corresponding derivatives are equal in pairs. Hence, if only $f(a)=\phi(a)$, we say there is contact of *zeroth* order, that is, the curves merely intersect at (a, b) ; if, besides, $f'(a)=\phi'(a)$, they have contact of *first* order; if, besides, $f''(a)=\phi''(a)$, they have contact of *second* order, and so on. If, finally, $f^{(n)}(a)=\phi^{(n)}(a)$, while the higher derivatives are unequal, they are said to have contact of n^{th} order.

164. Tangency of Curves.—The equation of the tangent to $y=f(x)$ at (a, b) is

$$y=b+(x-a)f'(a)=f(a)+(x-a)f'(a),$$

and of the tangent to $\eta=\phi(x)$ at (a, b) it is

$$\eta=b+(x-a)\phi'(a)=\phi(a)+(x-a)\phi'(a),$$

all higher derivatives of f and ϕ vanishing. If now $f'(a) = \phi'(a)$, *i.e.*, if the curves have contact of *first* order then these tangents are the same line; and, conversely, if these tangents be the same line, then the curves have contact of first order, for then $f'(a) = \phi'(a)$. Such then is the meaning of contact of first order. Two curves having such contact, *i.e.*, having a common tangent, are said to touch each other, or be tangent to each other.

165. Concavity and Convexity.—Let us consider more carefully the relation of the curve

$$y = f(x) = f(a) + (x-a)f'(a) + \frac{(x-a)^2}{2}f''(a) + \dots,$$

and its tangent, $y = f(a) + (x-a)f'(a)$. At any point the difference of ordinates or the vertical distance between curve and tangent is

$$\frac{(x-a)^2}{2}f''(a) + \frac{(x-a)^3}{3}f'''(a) + \dots$$

The lowest term in this power-series, *i.e.*, the term containing the lowest derivative that does not vanish, controls the sign of the series, for $x-a$ small at will; if this derivative be *even*, then the power of $x-a$ is *even* and does *not* change sign with $x-a$, *i.e.*, the tangent does *not* cut the curve at (a, b) but lies on the same side of the curve both for $x < a$ and for $x > a$. If this lowest even non-vanishing derivative be $+$, then the y of the curve is greater than the y of the tangent, which lies below the curve; the curve is then named **convex** towards the x -axis. If, however, this same derivative be $-$, then the y of the curve is less than the y of the tangent, which lies above the curve; the curve is then named **concave** towards the x -axis. But if the lowest non-vanishing derivative be *odd*, then the power of $x-a$ is odd, the term *changes sign* with $x-a$; *i.e.*, the y of the

curve is greater on one side of (a, b) than the y of the tangent, but is less on the other side: *i.e.*, the tangent cuts the curve at (a, b) , and the curve itself is convex on one side of (a, b) but concave on the other side, towards the x -axis. Hence the curve is said to *change the direction of its curvature* at (a, b) , which is called a **point of inflexion** for the curve (fig. 21).

166. Curvature.—But we have not yet said what we mean by the curvature of a curve, and we must define this concept accurately before we can use it intelligently. Suppose, then, that P and Q are two points on a curve, let the tangents at these points meet at T and the normals at N . Denote the inner angle of the normals, which equals the outer angle of the tangents, and is called the angle of **contingence**, by ν , and denote the arc-length PQ by s . Then ν is the angle through which the tangent (or normal) has turned as the point of contact has travelled from P to Q . If for a fixed arc-length s this angle be

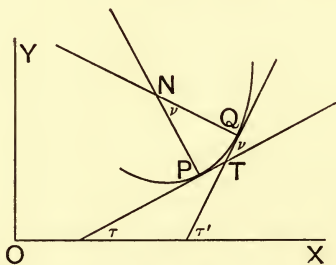

FIG. 22.

small, then the curve is flat, does not bend rapidly; but if this angle be large, then the curve is sharp, it bends rapidly. Hence we name the quotient $\frac{\nu}{s}$, of the angle through which the tangent turns by the path over which the point travels, the *average curvature* of the arc s ,—the angle ν itself being called the *total curvature* of the arc. If now we let the point Q approach the point P , both ν and

s become infinitesimals, Δv and Δs , and the limit of the average curvature $\frac{\Delta v}{\Delta s}$ is called the *instantaneous curvature*, or simply the **curvature** at the point P . We may denote it by κ and write $\kappa = \frac{dv}{ds}$.

167. The problem now presents itself, to express κ through the ordinary Cartesian x and y of the point P . If τ and τ' be the slopes of the tangent to the x -axis, it is plain that $v = \tau' - \tau$, hence $\Delta v = \Delta \tau$ and

$$\kappa = \frac{d\tau}{ds} = \frac{d\tau}{d(\tan \tau)} \cdot \frac{d(\tan \tau)}{dx} \cdot \frac{dx}{ds}.$$

Now $\tan \tau = \frac{dy}{dx}$, hence $\frac{d \tan \tau}{dx} = \frac{d^2 y}{dx^2}$; also

$$\frac{d\tau}{d \tan \tau} = (\cos \tau)^2 = 1 / \left\{ 1 + \left(\frac{dy}{dx} \right)^2 \right\} = \left(\frac{dx}{ds} \right)^2;$$

hence $\kappa = \frac{d^2 y}{dx^2} / \left\{ 1 + \left(\frac{dy}{dx} \right)^2 \right\}^{\frac{3}{2}} = y'' / (1 + y'^2)^{\frac{3}{2}}$.

168. **Uniform Curvature.**—From the equation of a straight line, $y = sx + b$, we have $y' = s$, $y'' = 0$; hence $\kappa = 0$, *the curvature of a straight line is zero*. From the equation of a circle, $x^2 + y^2 = r^2$, we have

$$y' = -\frac{x}{y}, \quad y'' = -\frac{y - y'x}{y^2} = -\frac{x^2 + y^2}{y^3} = -\frac{r^2}{y^3};$$

hence $\kappa = \frac{1}{r}$; *the curvature of a circle is constant and equals the reciprocal of the radius*.

Can we convert this proposition simply? *i.e.*, are all curves with constant curvature circles? To answer this question we must find all curves with constant curvature; to do this we must pass back from the differential equation

$\frac{y''}{(1 + y'^2)^{\frac{3}{2}}} = \frac{1}{c}$, which declares the curvature to be a constant

$1/c$, to some equivalent and *equally general* relation between the finite coordinates, x and y , which will be the equation of all curves of constant curvature $1/c$; *i.e.*, we must *integrate* the differential equation. To do this we multiply both members by y' and get

$$\frac{y''y'}{(1+y'^2)^{\frac{3}{2}}} = \frac{y'}{c}.$$

Now we *recognize* the right member as the derivative of y/c , and the left as the derivative of $-(1+y'^2)^{-\frac{1}{2}}$; hence these two expressions can differ at most by a *constant only*, which we may write conveniently b/c ; hence

$$-(1+y'^2)^{-\frac{1}{2}} = \frac{y}{c} - \frac{b}{c}, \quad 1+y'^2 = \frac{c^2}{(y-b)^2},$$

$$y' = \frac{\sqrt{c^2 - (y-b)^2}}{y-b}, \quad \text{or} \quad \frac{dx}{dy} \equiv x_y = \frac{(y-b)}{\sqrt{c^2 - (y-b)^2}}.$$

Here we *recognize* the left member as the derivative of x as to y , and the right as the derivative of $-\sqrt{c^2 - (y-b)^2}$ as to y ; hence these expressions can differ at most *only by a constant*, say a ; hence

$$x-a = -\sqrt{c^2 - (y-b)^2}, \quad \text{or} \quad (x-a)^2 + (y-b)^2 = c^2.$$

But this is the general equation of a circle of radius c about the point (a, b) as centre; hence *all curves of constant curvature are circles*. Accordingly, the straight line is conceived as a circle of infinite radius, of curvature 0.*

169. Standard of Curvature.—The circle having this *peculiar* property, that its curvature at all of its points is the same, namely, the reciprocal of its radius, we adopt the circle as the standard of reference in all matters of

*The straight line is the limit of a circle whose radius increases without limit.

curvature. The circle having the same curvature as a given curve at a given point is called the *circle of curvature*, and its radius the *radius of curvature* of that curve at that point.

Now draw the tangent T to the curve $y=f(x)$ at the point $P(a, b)$. The right line through P normal to the tangent is named the **normal** to the curve at that point. Draw it. All circles through P with centres on this normal will have a common tangent at P , namely, the tangent to the curve at P , and hence are said to be tangent to the curve at P . These circles will have radii ranging from 0 to ∞ , curvatures ranging from ∞ to 0; they degenerate toward a mere point in the one direction,

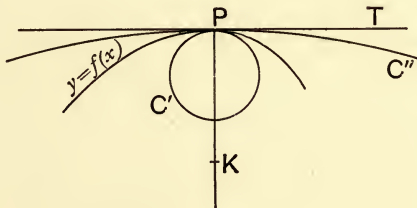

FIG. 23.

towards a right line in the other. Some, as C' , will manifestly bend away from the common tangent more rapidly than the curve does, others, as C'' , less rapidly; between these will lie one that bends away just as rapidly as the curve does. This is the circle of curvature in position and is called the **osculatory circle**, and its centre K is called the **centre of curvature** of the curve for the point P . This *osculatory circle* has the same first and second derivatives as the curve at this point; no other of the circles through P has the same second derivative, though all have the same first derivative, for no other has the same curvature; hence this osculatory circle nestles up to the curve at the point P closer than any other circle can; hence the name *osculatory*.

170. Centre of Curvature.—For each point P of the curve C there is a corresponding centre of curvature K ; and we now naturally ask what relation connects the coordinates (x, y) of P with the coordinates (u, v) of K ? How shall we find the latter, knowing the former? Calling the radius of curvature ρ , we have from the figure at once

$$u = x - \rho \sin \tau, \quad v = y + \rho \cos \tau,$$

or
$$u = x + \rho \sin \tau, \quad v = y - \rho \cos \tau,$$

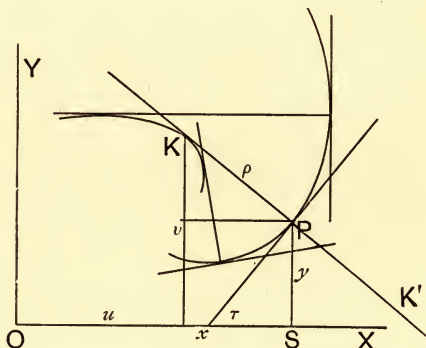

FIG. 24.

according as ρ is laid off towards K or K' . There seems to inhere in ρ a certain ambiguity of sign as is plain from any of its expressions, as $\rho = ds/d\psi$. Here the sign of ρ depends upon our choice in reckoning the angle ψ and the arc. Again $\rho = (1 + y'^2)^{\frac{3}{2}}/y''$. Here the sign depends on our choice of sign for the radical $\sqrt{1 + y'^2}$. We choose to make ρ always + and to lay it off toward the *concave* side of the curve; so that for y'' positive we take $+\sqrt{1 + y'^2}$, but for y'' negative we take $-\sqrt{1 + y'^2}$. With this understanding we may write always

$$u = x - \rho \sin \tau, \quad v = y + \rho \cos \tau.$$

Then on putting

$$\sin \tau = \frac{y'}{\sqrt{1 + y'^2}}, \quad \cos \tau = \frac{1}{\sqrt{1 + y'^2}},$$

we get
$$u = x - \frac{y'(1+y'^2)}{y''}, \quad v = y + \frac{1+y'^2}{y''},$$

formulae of universal applicability.

171. Evolute.—If now we combine these two equations with the equation of the curve C we may eliminate x and y , obtaining an equation between u , v , and constants. This equation holding for the coordinates of the centre of curvature K for every point of the curve C is the equation of the *locus of this centre of curvature* K . This locus is named **Evolute** of the curve C . Denote it by E . With respect to its evolute, the curve itself C may be called **Involute**.

172. Relation to Involute.—The propriety of these names may thus be evidenced; let us derive v as to u , regarding each as a function of x .

$$\frac{dv}{dx} = 3y' - \frac{(1+y'^2)y'''}{y''^2}, \quad \frac{du}{dx} = -3y'^2 + y' \frac{(1+y'^2)y'''}{y''^2} = -y' \frac{dv}{dx}.$$

Hence
$$v_u = \frac{dv/du}{dx/dx} = -\frac{1}{y_x}, \quad y_x \cdot v_u = -1.$$

But y_x and v_u are the tangents of the angles which the two tangents at P and K make with x -axis; hence these tangents are normal to each other, *i.e.*, the **normal to the Involute is tangent to the Evolute**.

Now let us derive both ρ and the arc s' of the evolute with respect to x . We have

$$\frac{d\rho}{dx} = (1+y'^2)^{\frac{1}{2}} \left(3y' - \frac{(1+y'^2)y'''}{y''^2} \right) = (1+y'^2)^{\frac{1}{2}} \frac{dv}{dx}.$$

$$\frac{ds'}{dx} = \sqrt{\left(\frac{du}{dx}\right)^2 + \left(\frac{dv}{dx}\right)^2} = (1+y'^2)^{\frac{1}{2}} \frac{dv}{dx}.$$

Hence
$$\frac{d\rho}{dx} = \frac{ds'}{dx}, \quad \text{hence } \rho = s' + c.$$

Accordingly, if a cord be kept stretched while it is unwound from the evolute, regarded as a groove, the

free end of the cord will trace an involute. In fact, every point of the cord, as it leaves the groove begins to trace an involute, and every point of any length of the cord kept stretched beyond the groove also traces an involute. This is geometrically evident, and also analytically from the indefiniteness of c in $\rho = s' + c$. Hence to any involute there corresponds one perfectly definite

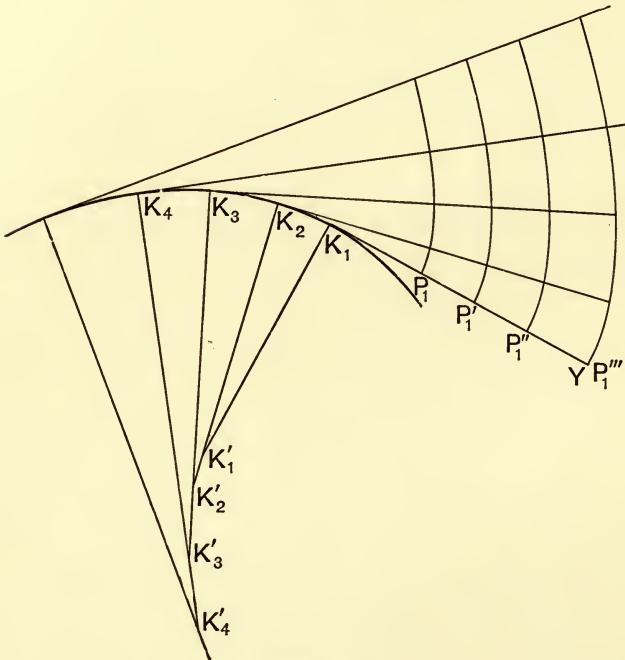

FIG. 25.

evolute, but to any evolute there corresponds an infinity of *parallel* (equidistant) involutes; precisely as a function has one and only one perfectly definite derivative, while a derivative has an infinity of integral functions differing among themselves by constants.

In the derivatives $d\rho/dx$ and ds/dx we chose $(1+y'^2)^{\frac{1}{2}}$ with the same sign which yielded $\rho = s' + c$, and corresponded to an *unwinding* of the cord *from* the evolute;

but we might have taken $(1+y'^2)^{\frac{1}{2}}$ with opposite sign, which would have yielded $\rho = -s' + c$, and would have corresponded to a *winding* of the cord upon the evolute, —the involutes are unaltered.

Exercise.—Obtain the foregoing two properties by deriving $u = x - \rho \sin \tau$ and $v = y + \rho \cos \tau$ as to s .

173. Hence, too, it appears that the **centre of curvature** is the **limit of the intersection of two normals**, or is the **intersection of two consecutive normals**, and may be so defined.

The angle of contingence in the involute evidently equals the corresponding angle of contingence in the evolute, or $\Delta\tau = \Delta\tau'$. Also $\Delta s' = \Delta\rho$, $\rho' = L \frac{\Delta s'}{\Delta\tau'} = \frac{d\rho}{d\tau}$. But $\rho = \frac{ds}{d\tau}$, hence $\rho' = \frac{d^2s}{d\tau^2}$: *i.e.*, the radius of curvature of the evolute is the second derivative of the arc-length as to the angle of slope in the involute.

If A be the area between involute, evolute, and any two ρ 's, then we have approximately

$$2\Delta A = \rho\Delta s = \rho^2 \cdot \Delta\tau,$$

and accurately, $2\frac{dA}{ds} = \rho$, $2\frac{dA}{d\tau} = \rho^2$,

whence A may be found by integration.

Any chord of the osculating circle drawn through the point of contact is called a *chord of curvature*,—every direction has such a chord.

It is now manifest that the *evolute* is the *envelope of the normals to the involute*, and in fact it may be so defined.

174. Let us now resume the general consideration of the **higher contact of curves**. As before

$$y = f(x) = f(a) + hf''(a) + \frac{h^2}{2}f'''(a) + \frac{h^3}{3}f^{(4)}(a) + \dots,$$

$$\eta = \phi(x) = \phi(a) + h\phi'(a) + \frac{h^2}{2}\phi''(a) + \frac{h^3}{3}\phi'''(a) + \dots$$

We have seen that $f(a) = \phi(a)$ means that the curves meet for $x = a$; the additional equality $f'(a) = \phi'(a)$ means they have the same direction, a common tangent, contact of first order; the still additional equality $f''(a) = \phi''(a)$ means they have the same curvature, radius of curvature, centre of curvature, and have contact of second order,—since all of these depend only on first and second derivatives.

If now one of the curves, as $y = f(x)$, be given completely, but the other, $\eta = \phi(x)$, be given only as to its species, as circle, ellipse, cycloid, or the like, with arbitrary parameters in its equation, we may raise the question, what curve of this species has closest contact with the given curve, what is the highest order of contact possible for a curve of this species, with the given curve (at the given point)? The answer will depend on how many derivatives of the curve in question we can equate to corresponding derivatives of the given curve; and this in turn will depend on how many disposable constants there are in the equation of the curve in question. If there be $(n+1)$ such arbitraries, then we may impose $(n+1)$ conditions,

$f(a) = \phi(a)$, $f'(a) = \phi'(a)$, $f''(a) = \phi''(a)$, ... $f^{(n)}(a) = \phi^{(n)}(a)$; *i.e.*, we can bring about contact of n^{th} order. Thus, the equation of the straight line, $y = sx + b$ contains but two parameters, s and b ; hence contact of first order, mere tangency, is in general the closest possible between it and a curve. But the general equation of the circle, $x^2 + y^2 + 2gx + 2fy + c = 0$, has three arbitraries, g , f , c ; hence contact of second order, osculation, is in general the closest possible between a circle and a curve. On the other hand the general equation of the parabola,

$$(y + sx)^2 + 2gx + 2fy + e = 0,$$

has four disposables; hence a parabola may be found having contact of third order with the given curve. The

conic in general, $kx^2 + 2hxy + jy^2 + 2gx + 2fy + e = 0$, has five parameters,—so that a conic may be found having contact of fourth order.

175. Curves of Closest Contact.—We may regard the matter from still another point of view. We may, in general, impose upon a curve as many distinct conditions as there are parameters in its general equation; then solving the equations of condition we find such values for the parameters as satisfy the conditions. The simplest form of these (n) conditions is that the curve goes through (n) given points. Thus we may require of a straight line that it pass through two (and only two) points of the curve. Let these points approach to coincidence; we get, in general, a tangent at the point of union of the points. Similarly, we may make a circle pass through three given points of the curve, but no more; as all these approach to coincidence, the circle becomes tangent to the curve,

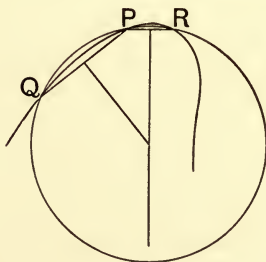

FIG. 26.

and since it can have, in general, no more than three points in common with the curve, its contact must be the closest possible, must be of second order,—it osculates the curve. We may, in fact, *define* the osculating circle as one through *three consecutive* points of the curve. Quite similarly the osculating parabola goes through four, the osculatory conic through five, consecutive points of the curve, *i.e.*, the osculatory conic is the *limit* in size,

shape, and position, to which the conic through five points of the curve tends as these five points approach each other, become consecutive.

176. Exceptional Points.—But while we cannot require a straight line to pass through three given points of a curve, it may yet happen that the straight line through two prescribed points of the curve passes through a neighbouring third point and that these three points tend simultaneously to coincidence. Thus, when P is held

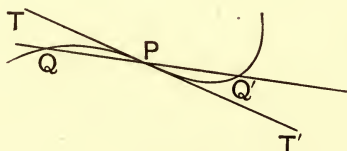

FIG. 27.

fast and the secant turns about it, the points of intersection Q and Q' in opposite sides of P tend to fall together on P ; when they do so the secant becomes a tangent through three consecutive points of the curve,—it has contact of second order. Hence second derivative for the curve equals second derivative for the tangent; this latter is 0, hence the former is 0, as we have already seen. Such a point P is called a point of **Inflexion** or of *contrary flexure*. The secant may even go through four points that tend to fall together on some one point as the secant turns about that point. At such a *point of undulation* the tangent has contact of third order with the curve, and hence both 2nd and 3rd derivatives of the curve must vanish, while the tangent does not cross the curve. Of course still higher degrees of contact are possible for the tangent.

177. Maximal and Minimal Curvature.—Similarly, though we cannot require a circle to go through more

than three given points of the curve, yet the circle through these three (Fig. 28) may go through a fourth neighbouring point of the curve, and all four may tend to fall together on the same point P . At P then the osculatory circle goes through four consecutive points, has its first three derivatives the same as the curves, has contact of third order. In general, as the osculatory circle agrees with the curve in 1st and 2nd, but not

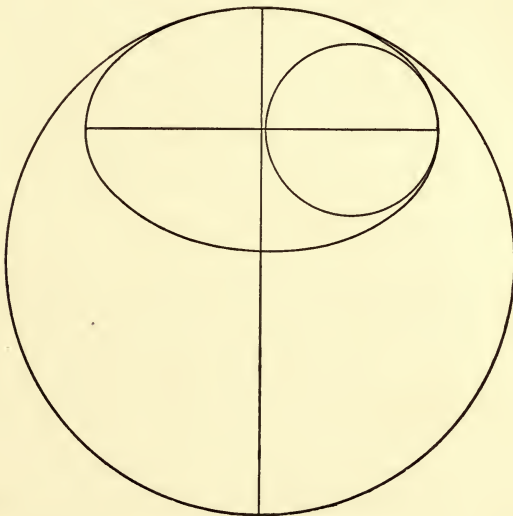

FIG. 28.

in 3rd and higher derivatives, the differences of the y 's (of curve and circle) must change sign with h . The circle must *cut the curve*—on the one side of P , where the *curve* bends less, it lies between circle and tangent; on the other side of P , when the *circle* bends less it lies between curve and tangent. But when four points fall together in P , the curve and circle agree in 3rd derivatives, but not in 4th and higher, the difference of the y 's, $y - \eta$, does *not* depend on the sign of h , the circle lies wholly within or wholly without the curve, near the point P ,

and we have in P a point of maximal or minimal curvature. Such are the vertices of conics.

178. Another Conception of the Osculatory Circle.—Of the three points through which the osculatory circle must pass we may at once let two fall together in P —then the circle becomes tangent to the curve—and let the third point Q approach P ; then the tangent circle turns into the osculatory circle. This change is effected by letting the centre slip along the normal drawn through P . If the curve be symmetric as to the normal in the *immediate* neighbourhood of P , as in case of maximal or minimal curvature, then to Q must correspond R , and these two points of intersection of curve and circle fall together on P , making four consecutive points, and there-with contact of third order.

179. Application to the Conic.—This conception of the osculatory circle yields a neat construction of it for any point of a conic. Let the circle tangent at P cut the curve again in Q and Q' , and let QQ' cut the tangent at

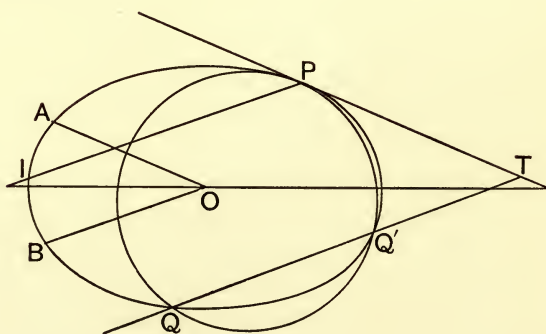

FIG. 29.

P in T . Then by the power-property of the circle $TP^2 = TQ \cdot TQ'$, and by the corresponding property of conics $TP^2/TQ \cdot TQ' = OA^2/OB^2$. Hence the half-diameters OA and

OB parallel to TP and TQ are equal, hence they are isoclinal to the axis of the conic; hence their parallels TP and TQ' are isoclinal to the axis, for every position of Q ; hence the limit of TQ' , namely, the chord of curvature PI is also isoclinal to the axis with TP . Hence, to construct the circle osculatory at P , draw through P a chord of the conic isoclinal with the tangent at P to the axis of the conic; the mid-normal of this chord meets the normal to the conic in the centre of curvature. Also, for any chord of curvature of any curve,

$$PI = \text{Lim } TQ' = \text{Lim } TP^2/TQ.$$

180. Illustrations.—1. Find radius of curvature and evolute of the Apollonian parabola, $y^2 = 4qx$.

$$y' = 2q/y = \sqrt{q/x}, \quad y'' = -q/xy = -\sqrt{q}/2x^{\frac{3}{2}}.$$

$$\rho = \frac{(1+y'^2)^{\frac{3}{2}}}{y''} = 2(x+q)^{\frac{3}{2}}/\sqrt{q} = \frac{2r^{\frac{3}{2}}}{\sqrt{q}}, \quad r \text{ being focal radius.}$$

For the origin $r = q$, hence $\rho = 2q$.

For $x = \infty$, $\rho = \infty$, the curve tends to become straight. To find the evolute we form the expressions for u and v , coordinates of a point on it, and then eliminate x and y from these expressions by help of the equation of the parabola. $u = x - y'(1+y'^2)/y''$, $v = y + (1+y'^2)/y''$. Whence

$$u = 3x + 2q, \quad x = \frac{u - 2q}{3}; \quad v = -\frac{xy}{q}, \quad qv^2 = 4x^3.$$

Hence, by equating values of x^3 ,

$$v^2 = \frac{4}{27q}(u - 2q)^3,$$

the *semi-cubical* parabola.

The focus of the Apollonian parabola lies midway between the vertices of the two parabolas; the length of

an arc of the semi-cubical is

$$\rho - 2q = 2 \frac{(x+q)^{\frac{3}{2}}}{q^{\frac{1}{2}}} - 2q.$$

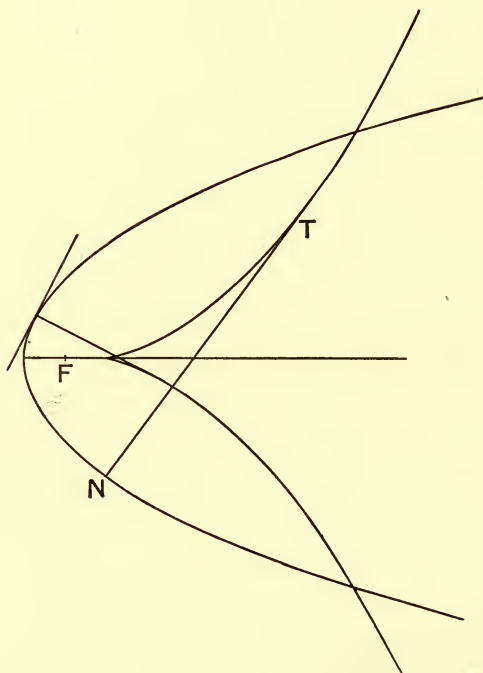

FIG. 30.

It is plain that to rectify evolutes is easy, and this semi-cubical parabola was in fact the first curve rectified algebraically. (NEIL, 1657.)

2. Find curvature and evolute of the *ellipse*, $\frac{x^2}{a^2} + \frac{y^2}{b^2} = 1$.

$$y' = -\frac{b^2}{a^2} \cdot \frac{x}{y}, \quad 1 + y'^2 = (a^4 y^2 + b^4 x^2) / a^4 y^2, \quad y'' = -\frac{b^4}{a^2 y^3}.$$

$$\rho = a^2 b^2 \left(\frac{x^2}{a^4} + \frac{y^2}{b^4} \right)^{\frac{3}{2}}. \quad \text{At the ends of the axes } \rho_1 = \frac{b^2}{a}, \quad \rho_2 = \frac{a^2}{b}.$$

Remembering that $a^2y^2 + b^2x^2 = a^2b^2$, we get

$$u = (a^2 - b^2)x^3/a^4, \quad v = -(a^2 - b^2)y^3/b^4,$$

whence $(au)^{\frac{2}{3}} + (bv)^{\frac{2}{3}} = (a^2 - b^2)^{\frac{2}{3}}$, an *asteroid*.

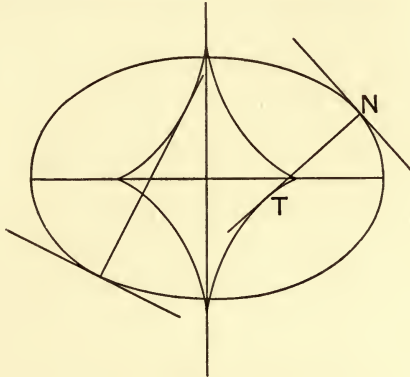

FIG. 31.

3. Find the curvature and evolute of the *hyperbola*,

$$\frac{x^2}{a^2} - \frac{y^2}{b^2} = \pm 1.$$

4. Find the curvature and evolute of the *cycloid*,

$$x = a\theta - a \sin \theta, \quad y = a - a \cos \theta.$$

$$y' = \cot \frac{\theta}{2}, \quad 1 + y'^2 = \left(\csc \frac{\theta}{2}\right)^2, \quad y'' = -\frac{1}{4a} \left(\csc \frac{\theta}{2}\right)^4.$$

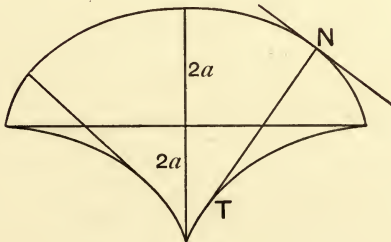

FIG. 32.

Hence $\rho = 4a \sin \theta/2$, which is seen to be double the intercept of the normal between curve and x -axis.

For the vertex, $\rho = 4a$.

In finding the evolute put

$$\phi = \frac{1}{2}\theta; \text{ then}$$

$$u = 2a(\phi - \sin \phi \cos \phi) + 4a \sin \phi \cos \phi = a(\theta + \sin \theta),$$

$$v = 2a(\sin \phi)^2 - 4a(\sin \phi)^2 = -a(1 - \cos \theta).$$

But these are the equations of a cycloid referred to the tangent at its vertex and its axis as coordinate axes. Hence, the evolute of a cycloid is an equal cycloid with its vertices at the cusps of the involute. Suppose the whole figure inverted, the point P to be weighted, the cycloidal arcs to be rigid grooves; then we should have a cycloidal pendulum, whose properties we shall hereafter study.

5. Find the radius of curvature at the origin and at (1, 3) for the curve $y = x + 3x^2 - x^3$. *Ans.* $\cdot 4714\dots, \infty$.

6. To find the curvature at the origin we may assume (by Stirling's formula) $y = y'x + \frac{y''}{2}x^2 + \dots$, put this development for y in the equation of the curve, and thence equating coefficients to 0 obtain the values of y' and y'' , and thence of the curvature.

$$\text{Thus in } lx + my + kx^2 + 2hxy + jy^2 + \dots = 0,$$

$$\text{we obtain } (l + my')x + (k + 2hy' + jy'^2 + \frac{1}{2}my'')x^2 + \dots = 0,$$

$$\text{whence } l + my' = 0, y' = -\frac{l}{m}, \text{ and } k + 2hy' + jy'^2 + \frac{1}{2}my'' = 0,$$

whence finding y' and y'' and substituting in ρ , we obtain

$$\rho = \frac{1}{2} \cdot \frac{(l^2 + m^2)^{\frac{3}{2}}}{km^2 - 2hlm + j'l^2}.$$

7. Find the curvature at the origin of

$$y^2 - 3xy + 2x^2 - x^3 + 4y^4 = 0.$$

Ans. The radii of curvature are $\frac{5}{2}\sqrt{5}$ and $-\sqrt{2}$; the two branches curve oppositely.

8. If we take a tangent and normal at any point of a curve as X - and Y -axes, then the equation of any circle tangent to the curve at the origin is $x^2 = 2ry - y^2$; for the osculatory circle, therefore, $2\rho - y = \frac{x^2}{y}$. For y small at will, the x and y of the curve approach a ratio of equality with the x and y of this osculatory circle, hence

$$\text{Lim}(2\rho - y) = \text{Lim} \frac{x^2}{y}, \text{ or } \rho = \text{Lim} \frac{x^2}{2y}.$$

So, if the Y -axis be the tangent, $\rho = \text{Lim} \frac{y^2}{2x}$.

Apply this **Method of Newton** to show that the radii of curvature of the conics at the vertices are the half-parameters, using the relation $y^2 = \frac{2b^2}{a}x \pm \frac{b^2}{a^2}x^2$.

9. Determine the parabola, with axis parallel to X -axis, that touches $a^2x = y^3$ most closely at (a, a) .

Ans. $3(2y - a)^2 = a(x - 4a)$.

10. Prove that the circle $x^2 + y^2 - 6x - 6y + 10 = 0$ and the parabola $x^{\frac{1}{2}} + y^{\frac{1}{2}} = z$ have contact of third order at $(1, 1)$.

11. Two curves with common tangent at a point may have contact there of *fractional* order. Describe about the point a circle of radius r small at will; let s be the arc of this circle intercepted between the curves, form the ratio $\frac{s}{r}$, and develop it in rising powers of r , thus:

$$s/r = ar^l + a_1r^{l+1} + \dots + \dots$$

Then the *lowest* exponent l of r in this power-series tells the *order of contact* of the curves.

Thus the cycloid $x = 2(\theta - \sin \theta)$, $y = 2(1 - \cos \theta)$ and the semi-cubical parabola $y^3 = 9x^2$ have contact of order $5/2$

at the origin; the two parabolas $y^4 = x^3$ and $y^5 = x^4$ have contact of order $\frac{1}{4}$ at the origin.

12. Find the parabolas with axes parallel to X and Y , and having contact of second order at $(a, 2a)$ with $x^2 + y^2 = 5a^2$.

Ans. $(5y - 8a)^2 = 2a(7a - 5x)$ and $(5x - a)^2 = 16a(11a - 5y)$.

13. The curve $y^2(2r - x) = x^3$ is called the Cissoid of Diocles; show that its centre of curvature is

$$\left(\frac{rx(5x - 12r)}{3(2r - x)^2}, \frac{8ry}{3x} \right),$$

its radius of curvature $\frac{r\sqrt{x(8r - 3x)^3}}{3(2r - x)^2}$,

and its evolute $27y^4 + 1152r^2y^2 + 4096r^3x = 0$.

CHAPTER V.

VARIOUS PROBLEMS OF INTEGRATION.

181. We were conducted to the notion of integral and the process of integration by the problem of **Quadrature**. But there are many other problems for which the same process furnishes a ready solution, the simplest of which may be here grouped together.

In case of rectangular Cartesian coordinates we have already found the expression for an area bounded by the X -axis, the graph of $y=f(x)$ and end-ordinates to be

$$A = \int y dx = \int f(x) dx$$

between proper extremes.

In case of other boundaries we cut the area into strips parallel to either axis, as Y -axis, express the varying

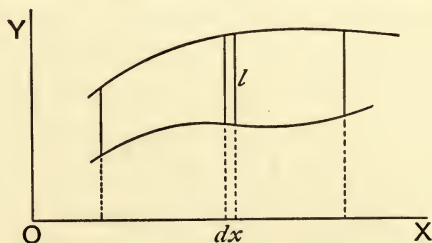

FIG. 33.

length l of the strip as a function of x , say $\phi(x)$, and integrate as to x ; hence

$$A = \int l dx = \int \phi(x) dx$$

between proper extremes.

In case of polar coordinates we have

$$\frac{1}{2}r^2\Delta\theta < \Delta A < \frac{1}{2}(r + \Delta r)^2\Delta\theta,$$

$$\frac{1}{2}r^2 < \frac{\Delta A}{\Delta\theta} < \frac{1}{2}(r + \Delta r)^2;$$

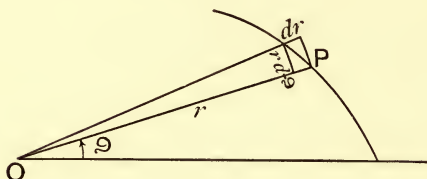

FIG. 34.

whence
$$\frac{dA}{d\theta} = A_\theta = \frac{1}{2}r^2,$$

whence
$$A = \frac{1}{2} \int r^2 d\theta = \frac{1}{2} \int r^2 \frac{d\theta}{dr} \cdot dr$$

between proper extremes.

Thus, to find area between first and second spires of the spiral of Archimedes $r = a\theta$, we have

$$A_2 = \frac{1}{2} \int_0^{4\pi} r^2 d\theta = \frac{a^2}{2} \int_0^{4\pi} \theta^2 d\theta = \frac{a^2}{2} \cdot \frac{64}{3} \pi^3.$$

Herein, however, we have reckoned the area of the first spire twice, once in the integration from 0 to 2π , and again in the integration from 2π to 4π . Calling it A_1 we have

$$A_1 = \frac{1}{2} \int_0^{2\pi} r^2 d\theta = \frac{a^2}{2} \cdot \frac{8}{3} \pi^3.$$

Hence the area sought

$$A_2 - 2A_1 = 8a^2\pi^3 = \pi \cdot 2\pi a \cdot 4\pi a = \pi r_1 \cdot r_2$$

= area of ellipse whose half-axes are the initial and final radii.

Exercise.—Find the area between n^{th} and $(n+1)^{\text{th}}$ spires.

182. Rectification is finding the length of a curve. We have found for plane curves, calling this length s ,

$$s_x = \frac{ds}{dx} = \sqrt{1 + y_x^2}, \quad s_y = \frac{ds}{dy} = \sqrt{1 + x_y^2};$$

whence $s_t = \frac{ds}{dt} = \frac{ds}{dx} \cdot \frac{dx}{dt} = \sqrt{x_t^2 + y_t^2}.$

Hence $s = \int \sqrt{1 + y_x^2} \cdot dx = \int \sqrt{1 + x_y^2} \cdot dy = \int \sqrt{x_t^2 + y_t^2} \cdot dt.$

Here t is any third independent variable on which x and y depend separately, and of course proper extremes must be inserted.

Thus, to rectify the cycloid, we have

$$x = a(\theta - \sin \theta), \quad y = a(1 - \cos \theta), \quad x_\theta = a(1 - \cos \theta), \quad y_\theta = a \sin \theta,$$

$$s = a \int_0^{2\pi} \sqrt{2 - 2 \cos \theta} d\theta = 4a \int_0^\pi \sin \frac{\theta}{2} d\frac{\theta}{2} = 4a(1 + 1) = 8a.$$

In case of polar curves we have

$$s_r = \sqrt{1 + r^2 \theta_r^2}, \quad s_\theta = \sqrt{r_\theta^2 + r^2}, \quad s_t = \sqrt{r_t^2 + r^2 \theta_t^2}.$$

Hence

$$s = \int \sqrt{1 + r^2 \theta_r^2} \cdot dr = \int \sqrt{r_\theta^2 + r^2} \cdot d\theta = \int \sqrt{r_t^2 + r^2 \theta_t^2} \cdot dt,$$

where t is as above, and proper extremes are to be inserted. As aids to the memory these symbolismes, suggested by the figures, are very useful:

$$ds^2 = dx^2 + dy^2, \quad ds^2 = dr^2 + (r d\theta)^2.$$

Exercise.—Rectify the parabola and the spiral of Archimedes.

183. Cubature is finding the volume of a solid. The general problem cannot be discussed here, but only a special case of great importance, namely: *When the area of a plane section of the solid is a known function of the distance of that section from a fixed parallel plane, say the YZ -plane, normal to X .* We suppose the solid cut into thin slices by planes normal to X and Δx apart.

Then, if $S(x)$ be the area of such a section, we see at once, precisely as in quadrature, that for the volume we have

$$V = \int S(x) dx$$

between proper extremes. If $S(x)$ be a known and integrable function of x , we can then obtain V .

A case of equal simplicity and importance is that of **Solids of Revolution**, generated by turning an area bounded by the axis of revolution (which we take for X -axis), the graph of $y=f(x)$, and two end-ordinates as y_1 and y_2 corresponding to x_1 and x_2 . If the area is turned completely round, then manifestly the sections are circles whose radii are the y 's, and $S(x) = \pi y^2$.

Hence $V = \pi \int y^2 dx$, with proper extremes.

If the area be turned not through the round angle 2π but through 2α , we put α for π in the formula.

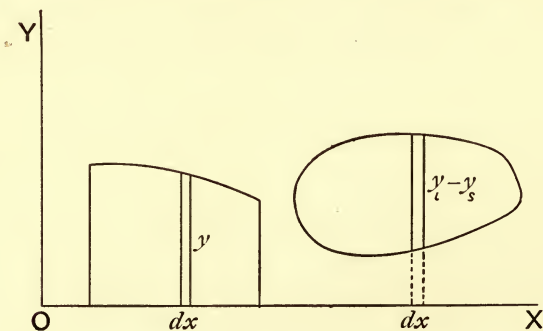

FIG. 35.

If the generating area lie not on but *without* the axis of revolution, then the volume generated will be a **ring**, and the section $S(x)$ will not be a circle but the band between two concentric circles, and for y^2 in the preceding formula, we must put $y_l^2 - y_s^2$.

Thus, to find the volume of the ellipsoid $\frac{x^2}{a^2} + \frac{y^2}{b^2} + \frac{z^2}{c^2} = 1$ we reflect that for any special value of x the section is

the ellipse $\frac{y^2}{b^2} + \frac{z^2}{c^2} = \frac{a^2 - x^2}{a^2}$, of which the area $S(x)$ is $\frac{\pi bc(a^2 - x^2)}{a^2}$. Integrating this between the extremes $x = -a$ and $x = a$ we get $V = \frac{4}{3}\pi abc = \frac{2}{3}$ circumscribing cylinder.

For the paraboloid of revolution we have $y^2 = 4qx$, integrating which between $x = 0$ and $x = a$ (for which let $y = b$), the student will find $V = \frac{1}{2}a\pi b^2 = \frac{1}{2}$ volume of circumscribing cylinder.

To find the volume of a *circular* ring generated by revolving a circle of radius r about an axis distant b from its centre, take the axis of revolution for X -axis, and the perpendicular through the centre for Y -axis; then the equation of the circle is $x^2 + (y - b)^2 = r^2$.

For any special value of x the two values of y are

$$y_1 = b + \sqrt{r^2 - x^2}, \quad y_2 = b - \sqrt{r^2 - x^2};$$

hence

$$y_1^2 - y_2^2 = 4b\sqrt{r^2 - x^2};$$

$$\therefore V = 4\pi b \int_{-r}^r \sqrt{r^2 - x^2} dx = 2\pi b \cdot \pi r^2.$$

Exercises.—1. Find the volume of a sphere.

2. Consider the ellipsoid $\frac{x^2}{a^2} + \frac{y^2}{b^2} + \frac{z^2}{c^2} = 1$, the circumscribing cylinder about the z -axis, the single hyperboloid $\frac{x^2}{a^2} + \frac{y^2}{b^2} - \frac{z^2}{c^2} = 1$, and the asymptotic cone $\frac{x^2}{a^2} + \frac{y^2}{b^2} - \frac{z^2}{c^2} = 0$; integrate each from $-c$ to $+c$ and compare the volumes. *Ans.* As 1 : 2 : 3 : 4.

3. Find the volume of an *elliptic* ring.

184. Quadrature of Revolutes (*Surfaces of Revolution*).

—Such a surface is traced by the graph of $y = f(x)$ turned about the X -axis (Fig. 35). In this revolution any element of the curve, as Δs , and its chord Δc will each trace out a narrow ribbon, and as the limit of $\frac{\Delta s}{\Delta c} = 1$, we may find the sum of the ribbons traced by

all the Δs 's, that is, the whole surface swept out by any length s of the curve $y=f(x)$, by taking the limit of the sum, that is, the integral, of the ribbons traced by the various Δc 's; such a ribbon traced by Δc is the convex surface of the frustum of a right circular cone, which may be treated as a trapezoid of altitude Δc , its bases being $2\pi y$ and $2\pi(y + \Delta y)$; the area is $2\pi\left(y + \frac{\Delta y}{2}\right)\Delta c$; and we have finally for the surface swept out

$$\begin{aligned} S &= 2\pi \int y ds = 2\pi \int y \sqrt{1 + x_y'^2} \cdot dy \\ &= 2\pi \int f(x) \sqrt{1 + y_x'^2} \cdot dx = 2\pi \int y \sqrt{x_i'^2 + y_i'^2} \cdot dt, \end{aligned}$$

each integral taken between proper extremes.

Thus, to find the surface of the *paraboloid*, traced by

$$y^2 = 4qx, \quad x_y = y/2q,$$

$$S = 2\pi \int y \sqrt{1 + x_y'^2} dy = \frac{\pi}{2q} \int \sqrt{4q^2 + y^2} \cdot 2y dy = \frac{\pi}{3q} (4q^2 + y^2)^{\frac{3}{2}}.$$

For the extremes 0 and b this is

$$\frac{8}{3} \pi q^2 \left\{ \left(\frac{b^2}{4q^2} + 1 \right)^{\frac{3}{2}} - 1 \right\}.$$

To find the surface of a *cycloidal spindle*, generated by turning an arch of the cycloid about its base, we have

$$x = a(\theta - \sin \theta), \quad y = a(1 - \cos \theta), \quad x_\theta = a(1 - \cos \theta), \quad y_\theta = a \sin \theta.$$

Hence, on substituting and putting $\theta/2 = \phi$, we get

$$\begin{aligned} S &= 2\pi \int_0^{2\pi} y \sqrt{x_\theta'^2 + y_\theta'^2} d\theta = 16\pi a^2 \int_0^\pi \sin^3 \phi d\phi \\ &= 16\pi a^2 \int_\pi^0 (1 - \cos^2 \phi) d \cos \phi = \frac{64}{3} \pi a^2. \end{aligned}$$

Exercises.—1. Find the volume and the surface generated by revolving a wave-length of the sinusoid $y = \sin x$ about X .

2. If the catenary $y/a = hc x/a$ be turned about X , prove that

$$V = \frac{1}{2} aS, \quad S = \pi(ax + sy).$$

185. Averages.—It is often very important to know what is the *arithmetic mean* or *average* of a number of values of a variable, which is defined as *the sum of the values divided by the number of the values*. Thus, if the vertices of a triangle be (x_1, y_1) , (x_2, y_2) , (x_3, y_3) , the average x and y are and may be written:

$$\bar{x} = \frac{x_1 + x_2 + x_3}{3}, \quad \bar{y} = \frac{y_1 + y_2 + y_3}{3}.$$

This point (\bar{x}, \bar{y}) is then the *average* or *mean point* of the three vertices.

When the number of values n is very large we use the sign of summation, Σ , thus:

$$\bar{x} = \frac{\Sigma x}{n}, \quad \bar{y} = \frac{\Sigma y}{n}.$$

Thus far all points have entered our reckoning alike, but it often happens that all the points have not the same valence or significance for our reckoning. If we ask for the mean point (or centre) of population in any region, we sum the distances of the inhabitants from (say) a fixed north and south line and likewise from a fixed east and west line; dividing each sum by the number of inhabitants we get the average distance north (or south), and the average distance east (or west), and all the inhabitants enter the reckoning alike. The point whose coordinates are these distances, which is thus at the average distance from the two axes or base-lines, may be called the *centre of population*. But if we would determine the centre of wealth of the same region, manifestly the inhabitants would not all enter the reckoning alike. We should then consider each person resolved into as many units as he possesses dollars, and then proceed precisely as before, summing the distances of the units and dividing by the sum of the units. This, however, would be exactly the same as to multiply the distance of each inhabitant by the number of his dollars,

sum the products, and divide by the sum of the multipliers. Calling such multipliers m_1, m_2, \dots, m_n we have for the averages,

$$\bar{x} = \frac{\Sigma mx}{\Sigma m}, \quad \bar{y} = \frac{\Sigma my}{\Sigma m}.$$

We should proceed quite similarly in finding the average or mean point or centre of any other magnitude distributed over any plane region. The multipliers, the m 's, merely show the relative *valence*, significance or weight, with which the various points in the region enter into our reckoning. We may call them the *weights* or the **mass-numbers**, where neither weight nor mass connotes anything physical, but may indeed refer to intelligence, ignorance, virtue, vice, or the like. It is not necessary that we know how to measure these but only what is the law of their relative distribution. In case, and only in case, of even or uniform distribution we may set each $m=1$.

If now the mass or agent under consideration, whatever it be, is spread out continuously over the region in question, then we must suppose the region cut up into *elementary* regions, each of which has an elementary mass Δm . By multiplying each Δm by the greatest corresponding x and summing, we should get a sum $\Sigma x_g \Delta m$, too great; by multiplying by the smallest corresponding x and summing we get a sum $\Sigma x_s \Delta m$, too small; the common limit of these two sums for the elementary regions, and therefore the elementary masses, taken small at will, is plainly the correct value, $\int x dm$. In like manner Σm becomes $\int dm$, and the integration is to be extended over the whole region in question. The quotient

$$\bar{x} = \frac{\int x dm}{\int dm}$$

is then the average x of the mass in question. So

$$\bar{y} = \frac{\int y dm}{\int dm}.$$

If the mass be distributed along a *line*, as in case of an electric current, the determination of one average ordinate as \bar{x} may suffice. But if it be distributed through a solid, as in case of a body charged with weight, heat, or magnetism, the similar determination of an average z ,

$$\bar{z} = \frac{\int z dm}{\int dm},$$

will be necessary.

186. The mass-centre definite.—At this point a very important question arises: Is this average or mean point (x, \bar{y}, \bar{z}) a definite point, the same for all coordinate systems, or does it vary with the axes chosen? If it does so vary, it plainly has no scientific value. To answer this question, we take two systems of axes, XYZ and UVW ; then by well-known formulae of transformation, the origin remaining unchanged, we have

$$u = a_1x + a_2y + a_3z, \quad v = b_1x + b_2y + b_3z, \quad w = c_1x + c_2y + c_3z,$$

where the constants, a 's, b 's, c 's need not be further defined. Multiplying by Δm we get, for any element,

$$u \Delta m = a_1x \Delta m + a_2y \Delta m + a_3z \Delta m,$$

and so for v and w . Summing, taking the limit of the sum, and dividing by $\int dm = M$, we get

$$\frac{\int u dm}{M} = a_1 \frac{\int x dm}{M} + a_2 \frac{\int y dm}{M} + a_3 \frac{\int z dm}{M}.$$

By definition of $\bar{u}, \bar{x}, \bar{y}, \bar{z}$, we have then

$$\bar{u} = a_1\bar{x} + a_2\bar{y} + a_3\bar{z};$$

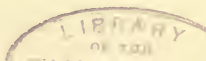

and so, too,

$$\bar{v} = b_1\bar{x} + b_2\bar{y} + b_3\bar{z},$$

$$\bar{w} = c_1\bar{x} + c_2\bar{y} + c_3\bar{z}.$$

Hence $(\bar{u}, \bar{v}, \bar{w})$ is the same point as $(\bar{x}, \bar{y}, \bar{z})$. Similarly, let the student show that the mean point is not affected by a mere change of origin. Hence, this point is the same for all coordinate systems, it depends solely on the distribution of the agent over the region in question. It is appropriately named *mass-centre* or *centroid* of the mass-system.

187. First Moment.—The product mx of a mass m by its distance x from the Y -axis (or YZ -plane) is called the (*first*) **moment** of that mass with respect to that axis or plane. Manifestly, the mass-system would balance itself about any right line through the mass-centre, which is thus seen to be nearly (though not quite) the same as the *centre of gravity*. With respect to any such right line, taken (say) as x -axis, we have $\bar{y} = 0$, hence

$$\bar{y}M = 0 = \int y dm$$

= the moment of the whole system about x -axis.

188. Higher Moments.—If we multiply the mass m not by its distance but by its **squared distance** r^2 from any axis, we obtain a product mr^2 , of great significance in mechanics, commonly but ineptly called (after Euler) the *moment of inertia* of the mass as to the axis; better named the **second** (or *quadratic*) **moment of mass**; perhaps best of all the **inertance** (so named by Prof. Brown Ayres) of the mass with respect to the axis. We might, of course, form 3rd, 4th, ..., n^{th} moments by multiplying m by r^3, r^4, \dots, r^n , but these products are not of any such importance.

If there be a system of discrete masses m_1, m_2 , etc., the inertance of the system is the sum $\sum mr^2$ of the products

$m_1r_1^2, m_2r_2^2,$ etc. But if the mass be distributed continuously, then manifestly the inertance of the system is the integral $\int r^2 dm,$ the integration to be extended over the whole region affected by the agent in question.

189. Radius of Gyration.—If now we take the *average* r^2 for the whole system by dividing the whole inertance by the whole mass, we shall obtain a very important new notion, namely, the (squared) **radius of gyration** of the mass with respect to the axis.

Denoting this radius by $k,$ we have

$$k^2 = \frac{\int r^2 dm}{\int dm}, \quad k^2 \int dm = k^2 M = \int r^2 dm,$$

whence it appears that the inertance of the whole system is the same as if the whole mass were concentrated at the end of the radius of gyration, just as the whole moment of the system is the same as if the whole mass were collected at the mass-centre, but with this difference: the *mass-centre* is fixed and definite for any given system without any regard to axes, whereas the *radius of gyration* is definite for each axis, but varies from axis to axis.

190. Parallel Axes.—An axis through the mass-centre may be called a **principal axis**, and the radius of gyration as to it a **principal** radius of gyration. If now we can

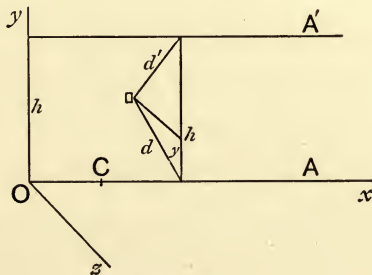

FIG. 36.

find such a principal radius of gyration, we can easily find the radius with respect to any parallel axis. For let A

be any axis through the mass-centre C , A' any parallel axis distant h , k and k' the radii of gyration as to A and A' . Taking A for X -axis, any perpendicular between A and A' for Y -axis, and the perpendicular to these two for Z -axis, we have for any elementary mass m ,

$$\begin{aligned} \text{Inertance as to } A &= md^2, & \text{Inertance as to } A' &= md'^2; \\ d'^2 &= d^2 + h^2 \pm 2hy; \end{aligned}$$

hence for the system

$$\int md'^2 = \int md^2 + h^2 \int m \pm 2h \int ym.$$

The last term is 0, since C is the mass-centre. Hence

$$Mk'^2 = Mk^2 + Mh^2, \text{ or } k'^2 = k^2 + h^2.$$

Hence, to find the (squared) radius of gyration as to any axis, find it for the parallel principal axis and add the squared distance between the axes.

191. Normal Axes.—When the region is plane, the inertance about any axis OZ normal to it equals the sum of the inertances about any two rectangular axes OX, OY through O in the plane. For if m be any mass at any point P distant y, x, r from OX, OY, OZ , then

$$mx^2 + my^2 = mr^2;$$

hence, on summing,

$$\int x^2 dm + \int y^2 dm = \int r^2 dm.$$

Hence too, on dividing by M or $\int dm$, and calling the radii k_x, k_y, k_z , $k_z^2 = k_x^2 + k_y^2$.

These theorems, of 190 and 191, are very useful.

192. Density.—The quotient of the mass in any region, divided by the region itself (*i.e.*, strictly, the quotient of the metric numbers), is called the *average density* of the mass in that region. The limit of this *average density* in the *immediate vicinity* of any point P may be called

the *density*, δ , at that point. Hence in integration over a line, surface, or solid, we may supplace dm by $\delta \cdot ds$, $\delta \cdot dS$, $\delta \cdot dV$. Only in case the distribution of mass is uniform may we put $\delta=1$ throughout. Otherwise, we must know δ as some function of r , in order to integrate.

193. Theorems of Pappus (Guldin).—The integrals for volume and surface of revolution, $\pi \int y^2 dx$ (or, more generally, $\pi \int (y_2^2 - y_1^2) dx$) and $2\pi \int y ds$ admit of very remarkable interpretation. Writing $2\pi \int \frac{y}{2} \cdot y dx$, we may

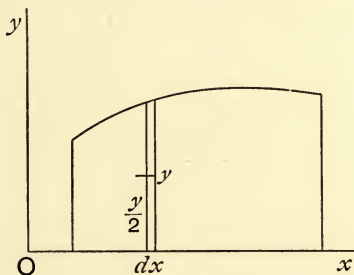

FIG. 37.

regard $y dx$ as the area of an elementary strip and $\frac{y}{2}$ as the distance of the mass-centre of that strip from the x -axis; hence $\frac{y}{2} \cdot y dx$ is the moment of that strip as to the x -axis; hence $\int \frac{y}{2} \cdot y dx$ is the moment of the whole area in question as to the x -axis; but this moment is $\bar{y} \cdot A$, A being the area; hence

$$V = \pi \int y^2 dx = 2\pi \bar{y} \cdot A.$$

Now $2\pi \bar{y}$ is the path of the mass-centre turned about the x -axis; hence, *The volume generated in revolving a plane area about an axis outside of the area, but in the plane, equals the product of the area by the path of its mass-centre.*

194. Similarly, $y ds$ is the moment of the line-element ds with respect to the x -axis, and $\int y ds$ the moment of the whole line as to the x -axis; hence

$$\int y ds = s \cdot \bar{y}, \quad S = 2\pi \int y ds = 2\pi \bar{y} \cdot s;$$

i.e. *the surface of revolution equals in area the rectangle (or product) of the revolving arc and the path of its mass-centre.*

These two beautiful theorems are usually ascribed to **Guldinus** (1577-1643), who seems to have discovered them about 1620, though he did not prove them rigorously. But they were known (at least the first) much earlier to **Pappus** (*circa* 340 A.D.), who gives it in his *Mathematical Collections*, and who perhaps was the first to prove it. By their help we may find any one of the three magnitudes: A , V , \bar{y} , or S , s , \bar{y} , when the other two are known.

195. **Choice of Elements.**—In obtaining areas, volumes, moments, by simple integration it is important to make judicious choice of the *element*, which appears under the \int as dA , dV , etc., so that the argument of integration shall have the same value throughout the element. Thus, in finding the moment of an area as to the Y -axis we choose as *element* a narrow strip parallel to the y -axis, for the whole of which x has the same value; but in finding the quadratic moment of an area about an axis normal to it we should choose as element a narrow circular ring with centre on the axis, because throughout such a ring the argument of integration r would have the same value. In dealing with such problems mathematics shows itself to be “etherealized common sense.”

196. **Symmetry.**—Determinations of mass-centre are often much facilitated by simple geometric considera-

tions, especially of *symmetry*. Thus, from the definitions, it is clear that the mass-centre of a system is the mass-centre of the mass-centres of all the distinct parts of that system. If all these part-mass-centres lie in a plane or on a right line, then the mass-centre of the whole lies in this plane or on this right line. In case of *uniform* distribution, if there be a *plane of symmetry*, then the mass-centre of each pair of symmetric points lies in this plane; hence the mass-centre of the system lies in this plane of symmetry. If there be two such planes, it must lie in each, *i.e.*, in their intersection, the *axis of symmetry*; if there be three, it must lie in each, *i.e.*, at their intersection, the *centre of symmetry*. Generally, if there be an axis of symmetry, it must contain the mass-centre of each pair of symmetric points, and hence of the whole system; and similarly, if there be a centre of symmetry.

197. Illustrations.—1. Find the mass-centre of a tract $OA = a$ when the density varies as the n^{th} power of the distance from O . Here $\delta = cx^n$, $dm = \delta \cdot dx = cx^n dx$,

$$\bar{x} = \frac{c \int_0^a x \cdot x^n dx}{c \int_0^a x^n dx} = \frac{n+1}{n+2} \cdot a.$$

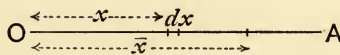

This is a result of high generality and great importance.

For $n=0$, *i.e.*, for uniform distribution, $\bar{x} = a/2$, the mass-centre is the mid-point of the tract. If OA be the median of a plane triangle, it will contain the mass-centre of any infinitesimal strip parallel to the base; the length of such a strip varies as the distance from the vertex O ; hence the density along OA varies as the distance from

O , hence $\bar{x} = \frac{2}{3}OA = \frac{2}{3}a$; *i.e.*, the mass-centre of a plane triangular area is on (each) median, two-thirds of the distance from the vertex—a point independently known to be the *intersection of the medians*.

If O be the vertex, and A the mass-centre of the base, of a cone or pyramid, then the mass-centre of every section parallel to the base lies on OA ; the mass of every such section (or infinitesimal slice), and hence of every such mass-centre, varies as the squared distance from O ; hence in this case $n=2$ and $\bar{x} = \frac{3}{4}OA$, *i.e.*, the mass-centre of the cone or pyramid lies on the median tract (from vertex to mass-centre of base) three-fourths of the distance from the vertex.

Manifestly, similar reasoning might be applied to higher extents, of 4, 5, ... n -dimensions, corresponding to tract, triangle, pyramid.

2. Find the mass-centre of a uniform circular arc of angle 2α . For x -axis take OA conjugate to the chord BC . The mass-centre lies on this axis (why?), and

$$\bar{x} = \frac{\int x ds}{\int ds} = \frac{\int r \cos \theta \cdot r d\theta}{\int r d\theta} = r \frac{\sin \alpha}{\alpha} = OG.$$

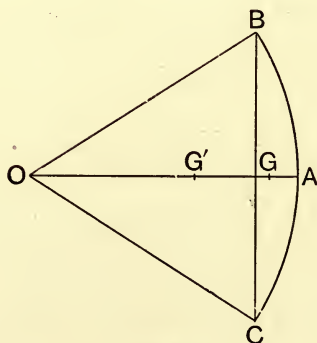

FIG. 38.

Here, because of symmetry, it suffices to extend the integration over the half-arc from $\theta=0$ to $\theta=\alpha$.

3. To find the mass-centre of a uniform circular sector of angle 2α , we note that the centroid of every elementary circular strip will be on the axis of symmetry, which will thus be laden with mass from O out to G *proportionally to the distance from O* ; hence

$$\bar{x} = OG' = \frac{2}{3}r \frac{\sin \alpha}{\alpha}.$$

4. Find \bar{y} for an arch of the cycloid

$$x = a(\theta - \sin \theta), \quad y = a(1 - \cos \theta).$$

We know the length is $8a$, hence we have

$$\begin{aligned} 8a\bar{y} &= \int y ds = a^2 \int_0^{2\pi} (1 - \cos \theta) \sqrt{2 - 2 \cos \theta} d\theta \\ &= 8a^2 \int_0^\pi \left(\sin \frac{\theta}{2}\right)^3 d\frac{\theta}{2} = -8a^2 \left(\cos \frac{\theta}{2} - \frac{1}{3} \cos \frac{\theta^3}{2}\right)_0^\pi = 8a^2 \frac{4}{3}; \\ \bar{y} &= \frac{4}{3}a. \end{aligned}$$

The mass-centre is on the axis, one-third of the distance from vertex.

5. Find the radius of gyration, of a uniform linear rod, of length a , as to an axis normal to it, through one end.

Putting $\delta = 1$, we have

$$dm = dx, \quad k^2 = \frac{\int_0^a x^2 dx}{\int_0^a dx} = \frac{1}{3}a^2.$$

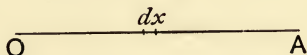

For the same rod, as to an axis through the mid-point,

$$k^2 = \frac{1}{12}a^2.$$

6. Find k^2 for a uniform circular plate, of radius a , as to an axis normal to it, through its centre.

Putting $\delta=1$, we have

$$dm = 2\pi r dr, \quad k^2 = \frac{2\pi \int_0^a r^2 \cdot r dr}{2\pi \int_0^a r dr} = \frac{1}{2}a^2.$$

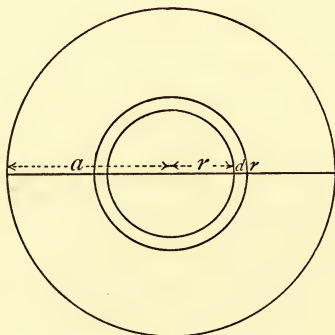

FIG. 39.

The like holds for a right circular cylinder as to its axis.

7. For the same plate, as to a diameter, $k^2 = \frac{1}{4}a^2$ (Art. 191).

8. For a right circular cylinder, as to an element as axis,

$$k^2 = \frac{3}{2}a^2.$$

9. For a rectangle (ab), as to b as axis, $k^2 = \frac{1}{3}a^2$; as to an axis normal to it through its centre, $k^2 = \frac{1}{12}(a^2 + b^2)$.

10. For a linear rod, OA , of mass varying as the n^{th} power of the distance from O , as to a normal axis through O ,

$$k^2 = \frac{\int_0^a x^2 \cdot cx^n dx}{\int_0^a cx^n dx} = \frac{n+1}{n+3}a^2.$$

Hence for a uniform isosceles triangle as to a parallel through its vertex to its base b , h being the altitude,

$$k^2 = \frac{1}{2}h^2.$$

11. Prove that the mass-centre of a parabolic half-segment VAP (V the vertex, A on the axis, P on the curve) is $(\frac{3}{8}VA, \frac{3}{8}AP)$.

12. Find mass-centre of a parabolic arc VP , using as equations of parabola $x=u^2, y=2\sqrt{qu}$.

13. Find k^2 for half-segment VAP (Ex. 11) as to VA , as to AP , as to VB (parallel to AP), as to PB (parallel to VA), and as to normals to VAP through V, A, P and B .

14. Find k^2 for parabolic arc VP as to VA , and AP .

15. Find centroid of elliptic quadrant OAB .

16. Find k^2 for elliptic quadrant OAB as to OA, OB , and the axis through O normal to OA and OB .

17. Find the area of a paraboloid of revolution about the axis of the parabola. *Ans.* $\frac{4}{3}\pi\{(x+q)\sqrt{y^2+4q^2}-4q^2\}$.

Find also the centroid of this surface.

18. Find the volume of the foregoing paraboloid ($2\pi qx^2$), and the abscissa of its centroid ($\frac{2}{3}x$).

19. Find k^2 for the paraboloid surface as to VA, AP, VB , and their common perpendicular.

20. Find k^2 for the paraboloidal volume as to the same axes.

21. Find the volumes of the revolutes of the elliptic quadrant OAB about OA and about OB . *Ans.* $\frac{2}{3}\pi ab^2, \frac{2}{3}\pi a^2b$.

22. Find the areas of the revolutes of the elliptic quadrant OAB about OA and OB .

$$\text{Ans. } \pi ab\left(\sqrt{1-e^2} + \frac{1}{e} \sin^{-1}e\right), \pi\left(a^2 + \frac{b^2}{2e} \log \frac{1+e}{1-e}\right).$$

23. Find the centroids of the surfaces and volumes of the foregoing ellipsoids.

24. Find k^2 for the foregoing ellipsoidal surfaces and volumes as to OA, OB , and the normal to both.

25. The equation of the hyperbola referred to its asymptotes is $4xy = a^2 + b^2 = 4c^2$; find the area and centroid of a segment bounded by the curve, the x -axis, and two ordinates. Also the volume generated by rotating this hyperbolic segment about the x -axis; also the centroid of this volume; also the area of the surface traced by the revolving arc, and its centroid: also k^2 for both surface and volume and segment itself as to the x -axis; notice the result for x infinite.

26. Show that the centroid of the area between the cissoid $x^3 = y^2(2r - x)$, and its asymptote $x = 2r$ is $(\frac{5}{3}r, 0)$; the volume of the revolute about the asymptote is $2\pi^2r^3$; and the centroid of the half-volume is $(2r, \frac{4r}{\pi})$; find also k^2 for this volume as to the asymptote.

27. The equation of the logarithmic curve is $y = a \log \frac{x}{a}$; find the volume of the revolute about X -axis of the curve below the X -axis ($2\pi a^3$), its centroid $(\frac{a}{8}, 0)$, and its k^2 as to X -axis ($6a^2$); also the volume of the revolute of the same curve about Y -axis is $(\frac{1}{2}\pi a^3)$, its centroid $(0, -a/2)$, and its k^2 as to Y -axis.

28. Find centroid of an arch of the cycloid $(\pi a, \frac{5}{8}a)$, the volume of its revolute about its base ($5\pi^2 a^3$) and its surface $\frac{64}{3}\pi a^2$; also the centroid of the half-volume $(a(\frac{\pi}{2} + \frac{64}{45\pi}), 0)$, and of the half-surface $(\frac{2}{15}a, 0)$; also the volume swept out by area bounded by half-arch, tangent at vertex, and Y -axis turned about Y -axis is $(\pi a^3(\frac{1}{2}\pi^2 - 8/3))$, and its surface $(\frac{32}{3}\pi a^2)$, the centroid of the volume $(0, \frac{27\pi^2 - 128}{18\pi^2 - 96}a)$, and of the surface $(0, \frac{2}{15}a)$; find also k^2 for these surfaces and volumes as to X -axis and Y -axis.

29. Find the whole length ($16a$) of the cardioid

$$x = 2a \cos \theta - a \cos 2\theta, \quad y = 2a \sin \theta - a \sin 2\theta,$$

the centroid of half-periphery ($-\frac{3}{5}a, \frac{8}{5}a$), the volume of the revolute about X -axis ($\frac{64}{3}\pi a^3$), the centroid of this volume ($-\frac{3}{5}a, 0$), and k^2 as to X -axis.

30. Find the area ($\frac{3}{8}\pi a^2$) of the asteroid $x^{\frac{2}{3}} + y^{\frac{2}{3}} = a^{\frac{2}{3}}$, its length ($6a$), the centroid of a quadrant ($\frac{256a}{315\pi}, \frac{256a}{315\pi}$), and of the arc ($\frac{2}{5}a, \frac{2}{5}a$), the volume of the revolute of this arc about the X -axis ($\frac{16}{105}\pi a^3$), and its surface ($\frac{6}{5}\pi a^2$); also k^2 as to X -axis.

CHAPTER VI.

FUNCTIONS OF TWO OR MORE INDEPENDENT VARIABLES. PARTIAL DERIVATIVES.

198. Double Dependence.—Thus far we have considered only functions of a single argument, as

$$F(x, y) = 0, \quad y = f(x); \quad \phi(r, \theta) = 0, \quad r = \phi(\theta).$$

Any such functional relation is, in general, depicted geometrically by a curve in the plane of (x, y) or (r, θ) , so that our calculus has thus far, in a sense, been *linear*.

But often we meet with magnitudes that depend not on one argument only but on two or more arguments, which are themselves quite independent of each other. Thus, the area of a rectangle depends on its two dimensions, base and altitude, and these may be wholly unconnected with each other, so far as size is concerned. The volume of a certain mass of gas depends both on the pressure and on its absolute temperature; the velocity of undulation depends both on the density and on the elasticity of the medium; the logarithm depends both on the number and on the base of the system. So, too, the volume of a cuboid depends on its three dimensions, length, breadth, thickness, all of which may be entirely independent of each other. Such a functional dependence of one magnitude on two others independent of each other may be expressed in symbols thus:

$$F(x, y; z) = 0, \quad z = f(x, y); \quad \phi(\theta, \phi; r) = 0, \quad r = \psi(\theta, \phi).$$

199. The geometric depiction of such a relation is in general a **surface**. We may, in fact, assign any pair of arbitrary values to x and y , that is, we may choose any point (x, y) in the plane of XY . To this choice corresponds one (there may be several but we are concerned with only one) value of the *function* z . From the point (x, y) we measure up (or down) this value of z , and so come to a point (x, y, z) ; and this we may do for every point (x, y) in the XY -plane. Imagine, then, a very fine needle z long, erected at every such point; the ends of these needles (or z -ordinates) will form a *surface*,

$$f(x, y; z) = 0.$$

Conversely, suppose any point of this surface projected parallel to the Z -axis on the XY -plane; to this point there corresponds a certain z (the projector) and a certain pair of values, x and y , the coordinates of the projection, and these three values satisfy the equation $F(x, y; z) = 0$. Similarly we may reason about $\psi(\theta, \phi; r) = 0$; θ and ϕ —the former corresponding to longitude, the latter to latitude—determine a direction out from O , and to any such direction or right line corresponds a value of r , which, being laid off, brings us to a point of the surface

$$\psi(\theta, \phi; r) = 0.$$

200. Parallel Sections.—If in

$$F(x, y; z) = 0 \quad \text{or} \quad z = f(x, y)$$

we put $y = b$ (a constant), the result

$$F(x, b; z) = 0 \quad \text{or} \quad z = f(x, b)$$

will be the equation of a curve in the plane of ZX , or, what is the same, in the plane parallel to ZX , and distant b along the Y -axis. Plainly such a curve is changed in position only by *simply pushing* the plane of ZX along the Y -axis. The equation $y = b$ is the equation of a plane parallel to ZX and distant b from it; and this curve

$z = f(x, b)$, which results from combining $y = b$ with $z = f(x, y)$, is the intersection of this plane with our surface, $z = f(x, y)$. Similarly, $z = f(a, y)$ or $F(a, y; z) = 0$ is the intersection of our surface with a plane $x = a$, parallel to YZ . If through every point of this curve of intersection there be drawn a parallel to X , we shall obtain a cylindric surface (or cylinder) whose equation is

$$z = f(a, y) \quad \text{or} \quad F(a, y; z) = 0.$$

In this equation x does not appear, as plainly it should not, since the relation between y and z is the same for all sections parallel to YZ . Similarly

$$z = f(x, b) \quad \text{or} \quad F(x, b; z) = 0$$

is the equation of a cylinder parallel to Y , cutting the surface $z = f(x, y)$ or $F(x, y; z) = 0$ in a plane parallel to ZX .

201. Tangency.—Consider now two planes parallel to YZ and two parallel to ZX . Let the first pair cut the surface $z = f(x, y)$ along two curves

$$z = f(a, y) \quad \text{and} \quad z = f(a + \Delta x, y),$$

and the second pair along the two curves

$$z = f(x, b) \quad \text{and} \quad z = f(x, b + \Delta y).$$

They cut out in the plane of XY a small rectangle with sides Δx and Δy , and they cut out in the surface a small quadrilateral $ABCD$, whose projection on XY is the rectangle of Δx and Δy . These four points determine four planes, BCD , ACD , ABD , ABC . The first pair meet on the diagonal chord CD , the second pair on AB . These chords AB and CD do not in general meet, but if as Δx and Δy tend toward zero, these four *secant* planes all tend to fall together in one and the same position, no matter how the ratio $\Delta y/\Delta x$ varies, *then* we say, this limiting

position of the secant-planes* is the tangent-position, and the plane in that position is *tangent to the surface* $z=f(x, y)$ at the point (a, b, c) — c being the value of z corresponding to $x=a, y=b$; we may furthermore say the surface is *elementally plane* in the immediate vicinity of (a, b, c) . Just as a curve may have sharp points or other singularities

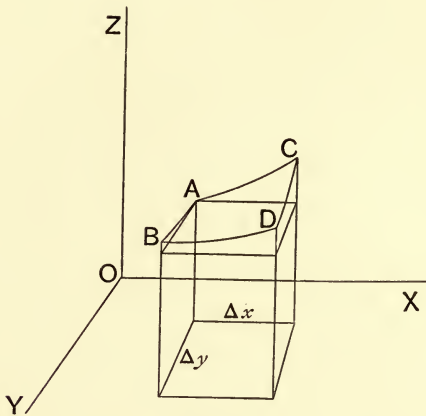

FIG. 40.

where it is not *elementally straight*, and the notion of tangent-line loses its definiteness or uniqueness, so a surface may have sharp points or other singularities where it is not elementally plane, and the notion of tangent-plane loses its definiteness or uniqueness—for instance, the vertex of a cone. But we have no present concern with such singularities.

202. Partial Derivatives.—Suppose then a plane T , tangent to $z=f(x, y)$ at (a, b, c) . The plane $x=a$ cuts the surface along the curve $z=f(a, y)$, and also cuts T in a straight line which is manifestly the tangent to $z=f(a, y)$. The equation of this tangent, in its own plane, is

*Or simply of the one plane ABC , which is enough to consider, as B and C move up to the fixed A in any manner whatever.

$z - c = z_y(y - b)$, where in z_y we must put b and c for y and z . This z_y is merely the derivative of z as to y , the limit of the difference-quotient $\Delta_y z / \Delta y$, when x is constant, namely a , and y varies; hence it is called **Partial Derivative** of z as to y , and is conveniently written $\frac{\partial z}{\partial y}$ (Jacobi).

Similarly, the plane $y = b$ cuts T in a straight line tangent to $z = f(x, b)$, and the equation of this tangent in its own plane is $z - c = z_x(x - a)$, where in z_x we must put a and c for x and z . Here z_x or $\frac{\partial z}{\partial x}$ is the *partial derivative* of z as to x , the limit of the difference-quotient $\Delta_x z / \Delta x$ when y is constant, namely b , and x varies. Observe that $\Delta_x z$ and $\Delta_y z$ may be quite different.

203. Equations of Tangent Plane.—If now we ask, What is the equation of this plane, T , tangent at (a, b, c) ? if there be any such tangent-plane, the answer is

$$z - c = z_x(x - a) + z_y(y - b).$$

For this is the equation of some plane, being linear in x, y, z ; it meets the plane $x = a$ in the right line $z - c = z_y(y - b)$, and the plane $y = b$ in the right line $z - c = z_x(x - a)$; but T goes through these same two lines; hence this plane is T , since only one plane can go through both the lines.

The *normal* form of the equation of a plane is

$$x \cos \alpha + y \cos \beta + z \cos \gamma - p = 0,$$

where α, β, γ are the angles made with the axes X, Y, Z by the perpendicular p from the origin O on the plane; the cosines of α, β, γ are the *direction-cosines* of p . Comparing this equation with the one above, from which it can differ only by a factor m , we see that

$$z_x = m \cos \alpha, \quad z_y = m \cos \beta, \quad -1 = m \cos \gamma;$$

$$z_x^2 + z_y^2 + 1 = m^2(\cos^2 \alpha + \cos^2 \beta + \cos^2 \gamma) = m^2;$$

$$\cos \alpha = z_x / \sqrt{z_x^2 + z_y^2 + 1}, \quad \cos \beta = z_y / \sqrt{\quad}, \quad \cos \gamma = -1 / \sqrt{\quad}.$$

204. The Equations of the Normal, N , to the surface $z = f(x, y)$ at the point (a, b, c) are

$$\frac{x-a}{\cos \alpha} = \frac{y-b}{\cos \beta} = \frac{z-c}{\cos \gamma}, \text{ or } \frac{x-a}{z_x} = \frac{y-b}{z_y} = -\frac{z-c}{1}.$$

For if (x, y, z) be any point on this normal, then $x-a$, $y-b$, $z-c$ are the projections on X, Y, Z of the tract of this normal from (a, b, c) to (x, y, z) ; and each of these projections, divided by the proper direction-cosine, must yield the tract itself; hence the first triple equality, and dividing by m we get the second.

Any plane through this normal cuts the surface in a *normal section*.

205. Simultaneous Changes in x and y .—If x varies and y remains constant, as $y=b$, then we have for $\Delta_x z$, the change in z along the surface, *parallel to ZX* ,

$$\Delta_x z = f(x + \Delta x, y) - f(x, y).$$

Similarly for the change in z , *parallel to YZ* ,

$$\Delta_y z = f(x, y + \Delta y) - f(x, y).$$

If now both x and y change we shall have for the *total* resulting change in z ,

$$\Delta z = f(x + \Delta x, y + \Delta y) - f(x, y).$$

The question naturally arises: Have the quotients $\Delta z/\Delta x$, $\Delta z/\Delta y$ any definite limits as Δx , Δy tend to zero, no matter how, provided only that y_x remains finite, and z_x , z_y definite in the immediate vicinity of (x, y, z) ? (Fig. 40.)

We form the identity

$$\frac{f(x + \Delta x, y + \Delta y) - f(x, y)}{\Delta x} \equiv \frac{f(x + \Delta x, y + \Delta y) - f(x, y + \Delta y)}{\Delta x} + \frac{f(x, y + \Delta y) - f(x, y)}{\Delta y} \cdot \frac{\Delta y}{\Delta x}.$$

The first quotient on the right becomes $\frac{f(x + \Delta x, y) - f(x, y)}{\Delta x}$

for Δy vanishing first, and this becomes z_x for Δx vanishing; but for Δx vanishing first it becomes at once

$$\frac{\partial f(x, y + \Delta y)}{\partial x} \equiv (z + \Delta_y z)_x,$$

and this will become

$$\frac{\partial f(x, y)}{\partial x} \equiv z_x,$$

for Δy vanishing, *not always* but *only when* $(z + \Delta_y z)_x$ is itself a continuous function of y . So it appears that the *order* of vanishing of Δx and Δy is not wholly and always a matter of indifference. More generally, when will the first term on the right pass over into the same limiting value z_x , *no matter how* Δx and Δy approach 0, successively or simultaneously? The second term gives us no concern, but always passes over into $z_y \cdot y_x$. The answer is that the *difference-quotient must be a uniformly continuous function both of Δx and of y* ; that is, we must be able to find two independent ranges of value for Δx and Δy in the vicinity of (x, y) , such that within them, within the small rectangle of Δx and Δy , the difference-quotient shall not vary so much as σ —a previously assigned magnitude small at will; symbolically, we must have

$$\left[\frac{f(x + \Delta x, y + \Delta y) - f(x, y + \Delta y)}{\Delta x} - \frac{f(x + \theta \Delta x, y + H \Delta y) - f(x, y + H \Delta y)}{\theta \Delta x} \right] < \sigma,$$

where θ and H are proper fractions ranging from 0 to 1 inclusive, and the [] is to be taken *absolutely*, regardless of sign.

206. When this necessary and sufficient condition is satisfied we may pass to the limit and get

$$\frac{dz}{dx} = \frac{\partial f}{\partial x} + \frac{\partial f}{\partial y} \cdot \frac{dy}{dx};$$

or symmetrically,

$$dz = \frac{\partial f}{\partial x} dx + \frac{\partial f}{\partial y} dy.$$

Such is the **Theorem of Total Differential**. The last equation declares that the (so-called) *Total Differential* of z is the sum of the (so-called) *Partial Differentials* of z (or of f , which is the same) with respect to the independent arguments x and y . Both the symbolism and the expression in words are *convenient*, but they have in themselves no meaning, or at least no magnitudinal import, apart from the first equation, which has a definite magnitudinal meaning, namely: *The total derivative of z as to x equals the sum of partial derivatives of z (or f) as to x , and of z as to y , this latter multiplied by the derivative of y as to x , whatever it may be.*

207. **Limitations of the Theorem.**—Observe carefully that the theorem of total differential holds only when the surface $z=f(x, y)$ is *elementally plane* at (x, y) ; that is, only when the secant-plane ABC through

$$(x, y, z), (x + \Delta x, y, z + \Delta_x z), (x, y + \Delta y, z + \Delta_y z),$$

tips only infinitesimally, this way and that, as Δx and Δy vary independently, but settles down to one and the same tangent-position, no matter how B and C close down on A , no matter how Δx and Δy approach 0. This will not be the case at such a point as the vertex of a cone. Thus, in case of the cone

$$z^2 = x^2 + y^2, \quad z_x = \frac{x}{\sqrt{x^2 + y^2}}, \quad z_y = \frac{y}{\sqrt{x^2 + y^2}},$$

and these values are perfectly definite *except at the vertex*, the origin $(0, 0, 0)$, where they lose all determinateness.

So, too, the tangent-plane is definite for every point of the surface except the vertex, where the secant-plane through the vertex and two neighbouring points does not settle down to one and the same position, but rolls round the vertex as the two neighbouring points circle round closer and closer to the vertex.

207*. Tortuous Curves.—Closely connected with the subject of curved surfaces is that of curves in spaces, sometimes called *curves of double curvature*, but better, *winding, twisted, or tortuous curves*. They are such as do not lie in any part in a plane. Any such curve may be regarded as the intersection of two surfaces, and hence is determined by their two equations :

$$F_1(x, y, z) = 0, \quad F_2(x, y, z) = 0.$$

Or each of its three variable coordinates may be regarded as function of a third independent magnitude t , so that its three equations would be :

$$x = f_1(t), \quad y = f_2(t), \quad z = f_3(t).$$

From these, by elimination of t , the two, $F_1 = 0$ and $F_2 = 0$, would flow.

The tangent is defined as for plane curves. If it be sloped α, β, γ to x, y, z , then plainly,

$$x_s = \cos \alpha, \quad y_s = \cos \beta, \quad z_s = \cos \gamma;$$

also $s_t = \sqrt{x_t^2 + y_t^2 + z_t^2}$; where s = arc-length.

Hence, if u, v, w be coordinates of the tangent at the point (x, y, z) , then the tangent is

$$\frac{u-x}{x_t} = \frac{v-y}{y_t} = \frac{w-z}{z_t}.$$

The plane through (x, y, z) normal to the tangent is called the **Normal Plane**; hence it is

$$(u-x)x_t + (v-y)y_t + (w-z)z_t = 0.$$

The Equation of *any* plane through (x, y, z) is

$$A(u-x) + B(v-y) + C(w-z) = 0. \dots\dots\dots(1)$$

If this plane goes through the neighbour point

$$(x + \Delta x, \quad y + \Delta y, \quad z + \Delta z),$$

then $A(u - x - \Delta x) + B(v - y - \Delta y) + C(w - z - \Delta z) = 0,$

whence $A\Delta x + B\Delta y + C\Delta z = 0. \dots\dots\dots(2)$

If besides it go through the point neighbour to this latter, that is, through

$$(x + \Delta x + \Delta^2 x, \quad y + \Delta y + \Delta^2 y, \quad z + \Delta z + \Delta^2 z),$$

where $\Delta^2 x$ means $\Delta(\Delta x)$, a difference of a difference, then

$$A(u - x - \Delta x - \Delta^2 x) + B(v - y - \Delta y - \Delta^2 y) + C(w - z - \Delta z - \Delta^2 z) = 0,$$

whence $A\Delta^2 x + B\Delta^2 y + C\Delta^2 z = 0. \dots\dots\dots(3)$

If now we divide (2) and (3) by Δt and $\overline{\Delta t^2}$, and take the limits for Δt vanishing, we get

$$A(u - x) + B(v - y) + C(w - z) = 0, \quad Ax_t + By_t + Cz_t = 0,$$

$$Ax_{2t} + By_{2t} + Cz_{2t} = 0,$$

whence on eliminating A, B, C we obtain

$$(y_t z_{2t} - z_t y_{2t})(u - x) + (z_t x_{2t} - x_t z_{2t})(v - y) + (x_t y_{2t} - y_t x_{2t})(w - z) = 0$$

as equation of the plane through *three* consecutive points of the curve. As we can require no more of a plane than to go through three points, it follows that this plane lies as close to the curve as possible, it has the highest order of contact possible for a plane with the curve at (x, y, z) ; hence it is called the **osculatory plane**.

The normal to this plane is called **Binormal** to the curve, since it is normal to *two* curve-elements neighbouring to (x, y, z) . Its equation is

$$(u - x)/A = (v - y)/B = (w - z)/C;$$

its direction-cosines are

$$\cos \lambda = A/D, \quad \cos \mu = B/D, \quad \cos \nu = C/D, \quad D = \sqrt{A^2 + B^2 + C^2}.$$

It is often very expedient to choose the arc-length s as the independent variable t . Then denoting by $\Delta\tau$ the angle (called **contingent**) between two neighbouring tangents we have

$$\tau_t = \frac{d\tau}{ds} = D = \sqrt{\{(y'z'' - y''z')^2 + (z'x'' - z''x')^2 + (x'y'' - x''y')^2\}}$$

where ' and '' denote derivation as to s .

Now since $x'^2 + y'^2 + z'^2 = 1$ and $x'x'' + y'y'' + z'z'' = 0$,

$$D = \sqrt{\{x''^2 + y''^2 + z''^2 - (x'x'' + y'y'' + z'z'')^2\}} = \sqrt{x''^2 + y''^2 + z''^2},$$

$$\text{or } D = \sqrt{(\cos \alpha)_s^2 + (\cos \beta)_s^2 + (\cos \gamma)_s^2}.$$

This magnitude D , the limit of the ratio of the change in angle to the change in arc, is called, consistently with Art. 166, the **first curvature** of the curve, or the curvature in the osculatory plane. Its reciprocal, $\frac{ds}{d\tau}$, is called *radius of first curvature*, and is denoted by $\rho = s_\tau$.

All right lines in the normal plane are normal to the curve at (x, y, z) ; but the intersection of the osculatory plane with the normal plane is named **Principal Normal**. Its direction-cosines are readily seen to be

$$\cos L = (\cos \alpha)_\tau = \rho x'', \quad \cos M = (\cos \beta)_\tau = \rho y'', \quad \cos N = (\cos \gamma)_\tau = \rho z''.$$

The **Centre of Curvature** is on this P.N., distant ρ from (x, y, z) ; hence its coordinates are

$$\xi = x + \rho^2 x'', \quad \eta = y + \rho^2 y'', \quad \zeta = z + \rho^2 z'',$$

as we obtain by projecting ρ on the axes.

As the point $P(x, y, z)$ passes through Δs along the curve, not only does the tangent line turn through the contingent angle $\Delta\tau$, but the osculatory plane also turns through the angle $\Delta T'$ called **angle of torsion**.

The ratio $\frac{\Delta T'}{\Delta s}$ is the *average torsion* of the curve in the vicinity of $P(x, y, z)$ and its limit T_s is the instantaneous **torsion** at the point P , called also *second curvature*. Its reciprocal $\frac{ds}{dT'} = r$ is called **radius of torsion**, or of *second curvature*. The value of the torsion is

$$\frac{dT'}{ds} = \sqrt{\{(\cos \lambda)_s^2 + (\cos \mu)_s^2 + (\cos \nu)_s^2\}};$$

for the angle between the two osculatory planes equals the angle between their binormals, and we have just found such an expression for $\frac{d\tau}{ds}$, we have only to write λ, μ, ν for α, β, γ .

This expression for the torsion or twist of the curve assumes a remarkably elegant form. We have $\cos \lambda = A/D$,

hence
$$\overline{(\cos \lambda)}_s^2 = (A'D - AD')^2/D^4,$$

and so for the other cosines. Adding the three, and remembering $A^2 + B^2 + C^2 = D^2$, and hence

$$2(AA'DD' + BB'DD' + CC'DD') = 2D^2D',$$

we obtain
$$(T_s)^2 = D^2(A'^2 + B'^2 + C'^2 - D'^2)/D^4.$$

Now
$$A = \begin{vmatrix} y' & y'' \\ z' & z'' \end{vmatrix} \quad \text{and} \quad A' = \begin{vmatrix} y' & y''' \\ z' & z''' \end{vmatrix} \quad (\text{Art. 224}),$$

as is seen at once on actually deriving as to s .

Now consider A'^2 ; it is $y'^2 z'''^2 + y'''^2 z'^2 - 2y'z'y''z'''$. Form the sum $A'^2 + B'^2 + C'^2$, and remember $x'^2 + y'^2 + z'^2 = 1$, there results

$$\begin{aligned} x'''^2 + y'''^2 + z'''^2 - x'^2 x'''^2 - y'^2 y'''^2 - z'^2 z'''^2 \\ - 2(x'y'x''y''' + y'z'y''z''' + z'x'z''x''') \end{aligned}$$

which
$$= x'''^2 + y'''^2 + z'''^2 - (x'x''' + y'y''' + z'z''')^2.$$

Now consider the determinant

$$\Delta = \begin{vmatrix} x' & y' & z' \\ x'' & y'' & z'' \\ x''' & y''' & z''' \end{vmatrix}$$

Square it, remembering

$$x'^2 + y'^2 + z'^2 = 1, \quad x'x'' + y'y'' + z'z'' = 0, \quad x''^2 + y''^2 + z''^2 = D^2,$$

and
$$x'x''' + y'y''' + z'z''' = DD';$$

hence
$$\Delta^2 = \begin{vmatrix} 1 & 0 & x'x''' + y'y''' + z'z''' \\ 0 & D^2 & DD' \\ x'x''' + y'y''' + z'z''' & DD' & x''^2 + y''^2 + z''^2 \end{vmatrix}$$

$$= D^2\{x'''^2 + y'''^2 + z'''^2 - (x'x''' + y'y''' + z'z''')^2 - D^2\}.$$

Hence
$$(T_s)^2 = \frac{\Delta^2}{D^4}, \quad \text{or} \quad T_s = \frac{\Delta}{D^2} = \frac{\Delta}{A^2 + B^2 + C^2},$$

and A, B, C are seen to be derivatives of Δ as to x'', y'', z'' . When, and only when, $\Delta = 0$, the curve is *plane*.

The square root of the sum of the squared curvatures is named **total curvature**, and its reciprocal is named **radius of total curvature** of the curve; that is,

$$K = \sqrt{\tau_s^2 + T_s^2} = \sqrt{\frac{1}{\rho^2} + \frac{1}{r^2}} = \frac{1}{R}.$$

The sphere that passes through $P(x, y, z)$ and through *three* adjacent points of the curve has manifestly the closest possible contact with the curve—since the general equation of the sphere $\overline{x-a}^2 + \overline{y-b}^2 + \overline{z-c}^2 = r^2$, contains only *four* arbitraries—and is accordingly the **osculatory** sphere for the curve at that point. As the centre of the osculatory circle is the intersection of two consecutive normals, so the centre of the osculatory sphere is the intersection of three consecutive normal planes.

Its distance from the osculatory plane is $\frac{d\rho}{d\tau} = r \frac{d\rho}{ds}$ and its squared radius is $\rho^2 + r^2 \left(\frac{d\rho}{ds}\right)^2$.

The curve in space that corresponds to the circle in the plane, as being homeoidal throughout, is the **Helix** or **circular spiral**. Its equations are

$$x = a \cos \theta, \quad y = a \sin \theta, \quad z = b\theta.$$

These declare that the curve lies on a circular cylinder of radius a , and that the ascent of the curve on the cylinder is uniform, varying directly as the angle θ , the rotation round the cylinder.

The Helix that has all the foregoing geometric elements (except osculatory sphere) the same as the curve at $P(x, y, z)$, is called **osculatory Helix**. The parameters a and b of this helix are determined from the equations $\rho = \frac{a^2 + b^2}{a}$, $r = \frac{a^2 + b^2}{b}$.

They are $a = r \cdot \frac{r\rho}{r^2 + \rho^2}$, $b = \rho \cdot \frac{r\rho}{r^2 + \rho^2}$.

Envelopes of Surfaces.—The equation $F(x, y, z; p) = 0$ for any particular value of p represents a particular surface; if p range in value, the equation represents a varying surface or a system of surfaces, whose members correspond to the various values of p . Precisely as in the case of plane curves, two members

will in general intersect ; the curve of intersection is determined by the two equations $F(x, y, z; p)=0$, $F(x, y, z; p+\Delta p)=0$; and for consecutive members the intersection is determined by $F=0$ and $F_p=0$. If we eliminate p between these two equations, we shall obtain a general relation holding for all such intersections, or **Characteristics**, as they are called. The totality of such intersections of consecutive members is called the **Envelope** of the system of surfaces ; its equation is the *eliminant* of p between $F=0$ and $F_p=0$.

N.B.—This p -eliminant is the **Discriminant** as to p of the equation $F=0$, of course equated to 0. This p -discriminant is the product of the squared differences of the roots of $F(p)=0$, so that its vanishing is the condition of the existence of equal roots. That it is also the p -eliminant appears plainly thus :

Suppose
$$F(p) = (p-a)(p-b) \dots (p-l),$$

and let no root $a, b \dots l$, be repeated. Then

$$F'(p) = (p-b) \dots (p-l) + \{p-a\},$$

where $\{p-a\}$ means terms containing $(p-a)$.

Hence $F(a)=0$, but $F'(a)$ does not $=0$. The same may be said of $b, \dots l$; hence if $F(p)=0$ have no *equal* roots, then $F(p)=0$ and $F'(p)=0$ have no *common* root. The equations $F(p)=0$ and $F'(p)=0$ do not consist.

But if $F(p)=(p-a)^2(p-b) \dots (p-l)$, that is, if a root a be repeated, if $F(p)=0$ have equal roots, then

$$F'(p) = 2(p-a)(p-b) \dots (p-l) + \{(p-a)^2\}.$$

Hence $F(p)=0$ and $F'(p)=0$ for $p=a$, or $F(p)=0$ and $F'(p)=0$ when and only when $F(p)=0$ has *equal roots*. Hence if we eliminate p between $F(p)=0$ and $F'(p)=0$, we shall obtain the relation that must connect $a, b, c \dots l$ in order that $F(p)=0$ may have equal roots. Hence the p -eliminant and the p -discriminant, since each by vanishing states the same fact of equal roots, can at most differ from each other by a factor.

Hence if there be an *Envelope* of a system of curves or surfaces, its equation will be the p -eliminant or p -discriminant equated

to 0. But it by no means follows that this equation will actually be the equation of an Envelope. On the contrary, the equation is the equation of the locus of all points for which $F(p)=0$ has equal roots. This locus will include the envelope if there be any envelope, but may include other points or assemblages of points where the roots of $F(p)=0$ are equal. Such other points are *nodes*, where two or more branches of a curve intersect, and *cusps* where two or more branches meet without intersecting. Here the p -eliminant or p -discriminant equated to 0 may yield a *node-locus* or a *cusp-locus*, as well as an envelope. Further discussion belongs to Differential Equations.

It may be that two *consecutive characteristics* intersect, or that *three* consecutive members (surfaces) meet in a point. In that case we must have, by precisely similar reasoning

$$F(p)=0, \quad F'(p)=0, \quad \text{and} \quad F''(p)=0.$$

Eliminating p we should then have two equations in x, y, z determining the locus of the intersections of consecutive characteristics. This envelope of characteristics is called **cuspidal edge**.

If the system of surfaces consist of *planes*, then the characteristics are *right lines*; then the *elementary strip* between two neighbouring characteristics may be considered *plane*. Calling the successive characteristics 1, 2, 3 ... n , we may turn the strip 12 about 2 into the plane of 23; then this double strip, 12 and 23, about 3 into the plane of 34, and so on, thus stripping off the whole surface and flattening it out into a plane surface. Such a surface is accordingly said to be **developable**. The characteristics of the system, or the elements of the developable surface, are tangents to the cuspidal edge; the osculatory planes of this edge, since they contain each two characteristics (elements), touch the developable surface. This latter is thus doubly an envelope; both of the tangent lines and of the osculatory planes of the cuspidal edge.

The partial differential equation of the developable surface may be obtained thus:

Let $z = lx + my + n$ be the moving osculatory plane; then two of the parameters, as l and m , must be functions of the third, as n ; or $l = \phi(n)$, $m = \psi(n)$. Hence

$$z = \phi(n) \cdot x + \psi(n) \cdot y + n, \dots\dots\dots(1)$$

where n takes the place of the parameter p in the preceding.

Hence $0 = \phi'(n) \cdot x + \psi'(n) \cdot y + 1, \dots\dots\dots(2)$

and $0 = \phi''(n) \cdot x + \psi''(n) \cdot y. \dots\dots\dots(3)$

Eliminating n between (1) and (2) yields the *characteristic*; eliminating n from (1), (2), (3) yields two equations determining the cuspidal edge.

Deriving partially as to x and y we get $z_x = \phi(n)$, $z_y = \psi(n)$, whence $z_y = f(z_x)$;

$$z_{xx} = \phi'(n) \cdot n_x, \quad z_{yy} = \psi'(n) \cdot n_y, \quad z_{xy} = \phi'(n) \cdot n_y = \psi'(n) \cdot n_x.$$

Hence $(z_{xy})^2 = z_{xx} \cdot z_{yy}$ or $s^2 = rt$, as it is common to write, following Euler, is the *Partial Differential Equation of Developables*.

The Equation $z_y = f(z_x)$ may be read thus:

A surface is developable when the partial derivatives of z as to x and y are related independently of x, y, z .

208. In case we conceive of both x and y as dependent on a third variable t , we may write the theorem for Total Differential thus:

$$\frac{dz}{dt} = \frac{df}{dt} = \frac{\partial f}{\partial x} \cdot \frac{dx}{dt} + \frac{\partial f}{\partial y} \cdot \frac{dy}{dt},$$

a formula symmetrical and extensible to any number of independent variables. We may write z or f indifferently, always using d for *total* and ∂ for *partial* derivation.

In case of *implicit* relation, $F(x, y, z) = 0$, we may conceive all three variables as dependent on a fourth, t , and then we have

$$\frac{dF}{dt} = \frac{\partial F}{\partial x} \cdot \frac{dx}{dt} + \frac{\partial F}{\partial y} \cdot \frac{dy}{dt} + \frac{\partial F}{\partial z} \cdot \frac{dz}{dt} = 0,$$

from which of course $\frac{dz}{dt}$ (or $\frac{dx}{dt}$ or $\frac{dy}{dt}$) is found at once.

We have in fact

$$\frac{dz}{dt} = -\frac{\frac{\partial F}{\partial x}}{\frac{\partial F}{\partial z}} \cdot \frac{dx}{dt} - \frac{\frac{\partial F}{\partial y}}{\frac{\partial F}{\partial z}} \cdot \frac{dy}{dt},$$

whence by comparison

$$\frac{\partial f}{\partial x} \equiv \frac{\partial z}{\partial x} \equiv z_x = -\frac{\frac{\partial F}{\partial x}}{\frac{\partial F}{\partial z}}, \quad \frac{\partial f}{\partial y} \equiv \frac{\partial z}{\partial y} \equiv z_y = -\frac{\frac{\partial F}{\partial y}}{\frac{\partial F}{\partial z}}.$$

These expressions are often useful. We may now write the equations of tangent-plane and of normal more symmetrically, thus:

$$(x-a)\frac{\partial F}{\partial x} + (y-b)\frac{\partial F}{\partial y} + (z-c)\frac{\partial F}{\partial z} = 0,$$

$$(x-a)\left/\frac{\partial F}{\partial x} = (y-b)\left/\frac{\partial F}{\partial y} = (z-c)\left/\frac{\partial F}{\partial z}.*\right.$$

209. Higher Derivatives.—In forming *pure* higher partial derivatives, as to any one variable, no difficulty presents itself; we write them $z_{2x} \equiv \frac{\partial^2 z}{\partial x^2} \equiv \frac{\partial^2 f}{\partial x^2}$, $F_{2y} \equiv \frac{\partial^2 F}{\partial y^2}$, etc., and derive straight forward. But we may also form *mixed* higher partial derivatives, by deriving, as to one variable, the derivative as to another variable; thus, $z_{xy} \equiv \frac{\partial^2 z}{\partial x \partial y}$ means the derivative as to y of the derivative of z as to x , $z_{yx} \equiv \frac{\partial^2 z}{\partial y \partial x}$ means derivative as to x of the derivative of z as to y . Now if we take any product of powers of x and y as $x^r y^s = z$, we get

$$z_x = r x^{r-1} y^s, \quad z_{xy} = r s x^{r-1} y^{s-1},$$

$$z_y = s x^r y^{s-1}, \quad z_{yx} = r s x^{r-1} y^{s-1};$$

* Of course, in these partial derivatives x, y, z must be supplaccd by a, b, c , their values at the point of tangence.

here, then, $z_{xy} = z_{yx}$ —the order of derivation is indifferent. This holds for every term of a finite series of products of powers of x and y , hence it holds for any such series itself. The question then arises: Does it always hold? and if not always, under what conditions does it hold? The answer is that *it holds for every point (x, y) in whose immediate vicinity both z_x and z_{yx} (or z_y and z_{xy}) are continuous functions of both x and y .*

For a careful investigation of these conditions, as well as for illustration of exceptional cases, the student is referred to Vol. II.

210. These two propositions concerning the **Total Differential** and the **order of Derivation** are cardinal in the doctrine of Partial Derivation. They are commonly stated with too great generality, and the proofs adduced are not rigorous. With these propositions established, under proper conditions, the further discussion is easy. Thus, to find the second Total Derivative of z as to t , we

$$\begin{aligned} \text{have } \frac{dz}{dt} &= \frac{\partial f}{\partial x} \cdot \frac{dx}{dt} + \frac{\partial f}{\partial y} \cdot \frac{dy}{dt}, \text{ whence} \\ \frac{d^2z}{dt^2} &= \frac{\partial^2 f}{\partial x^2} \cdot \frac{dx}{dt} \cdot \frac{dx}{dt} + \frac{\partial^2 f}{\partial x \partial y} \cdot \frac{dy}{dt} \cdot \frac{dx}{dt} + \frac{\partial f}{\partial x} \cdot \frac{d^2x}{dt^2} \\ &\quad + \frac{\partial^2 f}{\partial y \partial x} \cdot \frac{dx}{dt} \cdot \frac{dy}{dt} + \frac{\partial^2 f}{\partial y^2} \cdot \frac{dy}{dt} \cdot \frac{dy}{dt} + \frac{\partial f}{\partial y} \cdot \frac{d^2y}{dt^2}, \text{ or} \\ \frac{d^2z}{dt^2} &= \frac{\partial^2 f}{\partial x^2} \cdot \left(\frac{dx}{dt}\right)^2 + 2 \frac{\partial^2 f}{\partial x \partial y} \cdot \frac{dx}{dt} \cdot \frac{dy}{dt} + \frac{\partial^2 f}{\partial y^2} \cdot \left(\frac{dy}{dt}\right)^2 \\ &\quad + \frac{\partial f}{\partial x} \cdot \frac{d^2x}{dt^2} + \frac{\partial f}{\partial y} \cdot \frac{d^2y}{dt^2}. \end{aligned}$$

We note that $(dt)^2$ divides every term in this equation, and we may conveniently omit it; but then we must understand d to mean derivation as to t , if the resulting equation is to have any magnitudinal import, to be anything more than a convenient symbolism.

If $t=x$ or $t=y$ the equation becomes simpler, but less symmetric.

We may proceed similarly to form higher derivatives.

We note that in d^2z the first three terms, containing ∂^2f , have the Binomial coefficients in order, 1, 2, 1; forming d^3z we shall find that the terms containing ∂^3f have also the Binomial coefficients in order, 1, 3, 3, 1; and by reasoning quite like that used in proving Leibnitz's Theorem we may establish this fact generally.

211. Taylor's Theorem Extended.—We now inquire whether and in what form we can develop z , a function of independent x and y , in the neighbourhood of any pair of values x and y ; that is, whether Taylor's Theorem may be extended to functions of two independent arguments. We attempt then to expand $f(x+h, y+k)$ in the vicinity of (x, y) , but we conceive of the two arguments as functions of a third arbitrary t , and write $f(x+th, y+tk)$, which becomes $f(x+h, y+k)$ for the special case, $t=1$. Accordingly z becomes some function of t , as

$$z = f(x+th, y+tk) = f(u, v) = \phi(t),$$

where for convenience we put u, v for $x+th, y+tk$. Suppose now that f is a continuous function of its arguments in the vicinity defined by h and k , then ϕ is a continuous function of t in the same vicinity, and if Maclaurin's Theorem holds for ϕ , we have

$$\phi(t) = \phi(0) + t\phi'(0) + \frac{t^2}{2}\phi''(0) + \dots + \frac{t^n}{n} \cdot \phi^{(n)}(\theta t),$$

or for the special case $t=1$,

$$\phi(1) = \phi(0) + \phi'(0) + \frac{1}{2}\phi''(0) + \dots + \frac{1}{n}\phi^{(n)}(\theta).$$

Now suppose furthermore that f and its partial derivatives, pure and mixed, are continuous as to both arguments; then we may form the Total Derivative of ϕ as to t , thus:

$$\phi'(t) = \frac{\partial f(u, v)}{\partial u} \cdot \frac{du}{dt} + \frac{\partial f(u, v)}{\partial v} \cdot \frac{dv}{dt}, \text{ and so for } \phi''(t).$$

But since $u = x + th$ and $v = y + tk$,

$$\frac{\partial f}{\partial u} = \frac{\partial f}{\partial x}, \quad \frac{\partial f}{\partial v} = \frac{\partial f}{\partial y},$$

$$\frac{du}{dt} = h, \quad \frac{dv}{dt} = k;$$

while all the higher derivatives of u and v as to t vanish, leaving for the higher total derivatives of $\phi(t)$ as to t only the *Binomial forms* of Art. 210, thus:

$$\phi'(t) = h \frac{\partial f(u, v)}{\partial u} + k \frac{\partial f(u, v)}{\partial v}, \quad \phi'(0) = h \frac{\partial f(x, y)}{\partial x} + k \frac{\partial f(x, y)}{\partial y};$$

$$\phi''(t) = h^2 \frac{\partial^2 f(u, v)}{\partial u^2} + 2hk \frac{\partial^2 f(u, v)}{\partial u \partial v} + k^2 \frac{\partial^2 f(u, v)}{\partial v^2},$$

$$\phi''(0) = h^2 \frac{\partial^2 f(x, y)}{\partial x^2} + 2hk \frac{\partial^2 f(x, y)}{\partial x \partial y} + k^2 \frac{\partial^2 f(x, y)}{\partial y^2}$$

$$= \left(h^2 \frac{\partial^2}{\partial x^2} + 2hk \frac{\partial^2}{\partial x \partial y} + k^2 \frac{\partial^2}{\partial y^2} \right)_1 f(x, y) = \left(h \frac{\partial}{\partial x} + k \frac{\partial}{\partial y} \right)^2 f(x, y).$$

Here $()_1$ is an *operator* operating on $f(x, y)$, and $()^2$ is the same operator more compactly written. Similarly,

$$\phi'''(0) = \left(h \frac{\partial}{\partial x} + k \frac{\partial}{\partial y} \right)^3 f(x, y),$$

and so on. Hence on substitution

$$\phi(1) = f(x+h, y+k)$$

$$= f(x, y) + \left(h \frac{\partial}{\partial x} + k \frac{\partial}{\partial y} \right) f(x, y) + \frac{1}{2} \left(h \frac{\partial}{\partial x} + k \frac{\partial}{\partial y} \right)^2 f(x, y) +$$

$$\dots + \frac{1}{n} \left(h \frac{\partial}{\partial x} + k \frac{\partial}{\partial y} \right)^n f(x+\theta h, y+\theta k).$$

In case this last term, the remainder R_n , converges towards 0, we may omit it and extend the series without limit, and may then write:

$$f(x+h, y+k) = e^{h \frac{\partial}{\partial x} + k \frac{\partial}{\partial y}} f(x, y).$$

Such is Taylor's Theorem, or the *Theorem of Mean Value* as it may be called, for functions of two inde-

pendents; it may be readily extended to functions of three, four, or n independents, *if we define* accurately beforehand what we mean by continuity of derivatives in case of such a function. Putting x and y each $=0$, and then writing x and y for h and k , we shall obtain Maclaurin's form, which expands $f(x, y)$ in the vicinity of $(0, 0)$,

$$f(x, y) = f(0, 0) + \left(x \frac{\partial}{\partial x} + y \frac{\partial}{\partial y}\right) f(0, 0) \\ + \frac{1}{2} \left(x \frac{\partial}{\partial x} + y \frac{\partial}{\partial y}\right)^2 f(0, 0) + \dots$$

212. Application.—Now as Taylor's series was used to disclose the character of a curve in the vicinity of a point, so this extended form may be used to disclose the character of a surface near any point. To this end let us take the *normal* to the surface at the point in question as Z -axis, and the tangent plane as XY -plane. We must then develop $z = f(x, y)$ in the neighbourhood of $(0, 0, 0)$ by the formula just given. Here we have on the right $f(0, 0) = 0$, since $z = 0$, for $x = 0, y = 0$; also $\frac{\partial f}{\partial x} = 0$ and $\frac{\partial f}{\partial y} = 0$ at the origin $(0, 0, 0)$, since XY is the tangent plane; hence

$$2z = \left\{ x^2 \frac{\partial^2 f(0, 0)}{\partial x^2} + 2xy \frac{\partial^2 f(0, 0)}{\partial x \partial y} + y^2 \frac{\partial^2 f(0, 0)}{\partial y^2} \right\}_2 + \{ \dots \}_3,$$

where all the terms in $\{ \}_3$ are at least of third degree in x and y . Hence by taking x and y small enough we may make $\{ \}_3$ *small at will in comparison with* $\{ \}_2$; or, on putting $x = r \cos \theta, y = r \sin \theta$,

$$\frac{\partial^2 f}{\partial x^2} = A, \quad \frac{\partial^2 f}{\partial x \partial y} = B, \quad \frac{\partial^2 f}{\partial y^2} = C,$$

$$\frac{2z}{r^2} = A \overline{\cos^2 \theta} + 2B \cos \theta \sin \theta + C \overline{\sin^2 \theta} + \sigma,$$

where σ is small at will for x, y, z, r small at will. Since A, B, C are in general finite, it is seen that z is *infinitesimal of second order*.

213. Osculating Paraboloid.—Let us now consider the surface (a conicoid)

$$2z = Ax^2 + 2Bxy + Cy^2,$$

and compare it with $z = f(x, y)$.

For $x = a$, $2z = Aa^2 + 2Bay + Cy^2$ in a plane parallel to YZ , a parabola; so for $y = b$; hence the conicoid is a *Paraboloid*.

For $z = c$, $2c = Ax^2 + 2Bxy + Cy^2$, and this section parallel to XY is an ellipse or an hyperbola according as $AC - B^2 > 0$ or < 0 ; hence the paraboloid is elliptic or hyperbolic according as $AC - B^2 > 0$ or < 0 .

The section made with $z = f(x, y)$ by the plane $z = c$ is *not* the conic $2c = Ax^2 + 2Bxy + Cy^2$, but by taking c small enough we may make the other terms in $\{...\}_3$ *small at will* in comparison with $Ax^2 + 2Bxy + Cy^2$; in other words we have

$$\text{Lim} \frac{2z}{r^2} = A \overline{\cos^2 \theta} + 2B \overline{\cos \theta \sin \theta} + C \overline{\sin^2 \theta};$$

that is, the section of the paraboloid by the plane $z = c$ is the *limit* of the section of the surface by the same plane. Moreover this $\text{Lim} \frac{2z}{r^2}$ is the curvature of the *normal section* made with either surface by a normal plane through z -axis, the equation of the plane being $\theta = \kappa$ (a constant). For, on referring to Art. 179, Fig. 29, we see that $TP = r$, $TQ = z$. Hence the corresponding normal sections of paraboloid and surface agree in curvature; accordingly the former is called the *paraboloid of curvature* or *osculating paraboloid* for this point of the surface. For these two reasons we take it as representing the surface at this point, the two have the same shape in the immediate vicinity of this point.

214. Indicatrix.—The sections of the paraboloid by planes $z = c$ parallel to the tangent-plane XY are similar conics

$$Ax^2 + 2Bxy + Cy^2 = 2c,$$

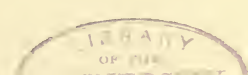

of which the simplest

$$Ax^2 + 2Bxy + Cy^2 = 1,$$

thought as in the XY -plane, may be taken as the type; its shape will indicate the shape of the surface near this point O , whence it is called the **Indicatrix** (Dupin). For $AC - B^2 > 0$ the indicatrix is an *ellipse*, the paraboloid is *elliptic*, the surface is *cup-shaped*, the point is *synclastic*; for $AC - B^2 < 0$ the indicatrix is an *hyperbola*, the paraboloid is *hyperbolic*, the surface is *saddle-shaped*, the point is *anticlastic*—the tangent-plane cuts the surface in two intersecting lines.

215. Illustration.—In order to envisage these results more distinctly, let us suppose our surface $z = f(x, y)$ to be a snow-covered mountain range, the z -axis vertical, the x -axis lying with the range north and south; then the section of the plane $x = a$ will be an undulating (say black) line along the range, the section or trace of the plane $y = b$ will be a waving line across the range, the trace of the plane $z = c$ will be a *contour* line around the range. As the plane $z = c$ rises up, the contour trace of it may shrink and break up into a number of distinct closed lines girdling the peaks; as $z = c$ rises higher, each of these contracts and finally vanishes in a point, the apex of a peak, as the plane becomes tangent. Near such a *synclastic* point the plane cuts off a *cup-like* piece of the surface. At such a point both the other traces, of $x = a$ and $y = b$, attain maxima, and we have

$$\frac{\partial z}{\partial x} = 0, \quad \frac{\partial z}{\partial y} = 0.$$

The like may be said of a *depression* (or inverted peak), at the lowest point of which $z = c$ becomes tangent, while the traces of $x = a$ and $y = b$ attain minima, and

$$\frac{\partial z}{\partial x} = 0, \quad \frac{\partial z}{\partial y} = 0.$$

Near such points the contour lines become approximately ellipses.

But there are not only peaks and depressions in such a range, there are also *passes*, *down from* which the range falls on two opposite sides, *up from* which it rises on the others. At such a point the surface is saddle-shaped, the plane $z=c$ becomes tangent but cuts the surface along two intersecting lines; of the two traces made by $x=a$ and $y=b$, one attains a maximum and the other a minimum, while both $\frac{\partial z}{\partial x}=0$ and $\frac{\partial z}{\partial y}=0$. Such a *pass inverted* at the bottom of a lake becomes a *bar* (think of the range reflected in a horizontal mirror). Near such an *anticlastic* point the contour lines are approximately hyperbolas.

216. Curvature.—Now what the foregoing doctrine of the Indicatrix teaches is that *in general* every point of the surface is thus either a *cup*-point or a *saddle*-point, and not merely these peak- and pass-points, where the first partial derivatives $\frac{\partial z}{\partial x}$ and $\frac{\partial z}{\partial y}$ vanish: sections about *every* point perpendicular to the normal at that point *tend* toward either an elliptic or an hyperbolic shape. Returning now to the normal sections, the traces of a plane turning about the normal or z -axis, we have for the curvature of such a section

$$\text{Lim} \frac{2z}{r^2} = \frac{1}{\rho} = A \overline{\cos^2 \theta} + 2B \sin \theta \cos \theta + C \overline{\sin^2 \theta}.$$

For a section at right angles to this we put $\theta' = \theta + \pi/2$, and obtain

$$\frac{1}{\rho'} = A \overline{\sin^2 \theta} - 2B \cos \theta \sin \theta + C \overline{\cos^2 \theta}$$

whence $\frac{1}{\rho} + \frac{1}{\rho'} = A + C$, a constant (Euler). This constant has been named *curvature of the surface*, and is of use

especially in the mathematical theory of capillarity, but the now accepted **measure of curvature** is the *Gaussian* $\frac{1}{RR'}$, where R and R' are the radii of curvature of the principal normal sections, *i.e.* the sections made by planes through the *axes of the Indicatrix*. If this latter be an ellipse, then it is plain that R and R' are the maximum and minimum radii of curvature corresponding to major and minor axes; they are called *principal radii* of curvature.

The axes of the indicatrix are tangents to the principal sections: if a point *starts* to move on one of these principal sections, the indicatrix will *start* to move also, turning its axes about the point, and therewith turning the normal section. If the point follows up this turning of the axis and normal section, keeping always on the latter and *facing* always along the former, it will trace out on the surface a path whose tangent at every point is the axis of the indicatrix. Such a line is called a **line of curvature** of the surface. Through every point there pass in general two and only two lines of curvature, perpendicular to each other.

When the indicatrix is a *circle* the radii of curvature become equal, any two diameters at right angles may be taken as axes, any two mutually perpendicular sections as principal sections, and the point may trace out a line of curvature by *starting* out on any normal section; hence lines of curvature converge all around upon this point, which is called a *cyclic point* or *umbilicus*.

217. Solid Angles.—We recall (Art. 166) that the angle through which the tangent turns in passing from P to Q , or the angle between the *normals* at P and Q , was named *total curvature* of the arc PQ ; its ratio to PQ , the *average curvature* of PQ ; and the limit of this ratio as Q neared P , the *instantaneous curvature* at P . In order

to form an analogous concept for surfaces, we bound off an area S on the surface, to correspond to PQ ; at each point of this boundary we draw a normal,—but do these normals determine an angular magnitude, as do the normals at P and Q ? Assuming that any such magnitude, if there be any so determined, will not be affected by moving them each *parallel to itself*, we assume a unit-sphere (of radius 1), and from its centre draw a parallel to each normal along the boundary. These parallels form a cone-surface, which piercing the sphere-surface bounds off on it a piece S' corresponding to S . The sphere-surface being uniform (homeoidal), the area S' may be taken as *measure of the opening of the cone*, and this latter being thus exactly measurable we name **solid angle** of the cone, or of the normals. When the cone flattens out to a plane, S' becomes a hemisphere of area 2π ; hence the *solid angle* formed by a plane about one of its own points equals the round angle 2π , or rather has the *same metric number* 2π as the round angle, though it is an entirely different magnitude; and the *whole solid angle* about any point in space is (or strictly has for its metric number) 4π .*

The notion of solid angle formed by the normals being thus made precise, we now define, by analogy, the *average curvature* of S to be the *ratio of the solid angle about S to the area of S* , and the *limit* of this ratio as S contracts down upon the point P we name the *instantaneous curvature at P* .

Now it has been proved (by Gauss) that the instantaneous curvature, as thus defined, equals $\frac{1}{RR'}$; also that it equals $(AB - C^2)/(1 + z_x^2 + z_y^2)^2$;

*The *unit-solid angle* here tacitly assumed is the so-called *stere-radian* (Halsted), which is subtended on the *unit-sphere* by an area equal to the *unit-square*, whose side is the *unit-length*.

also that the average curvature of S remains unchanged however S be bent without stretching.

Hence, if $AB - C^2 = 0$, the curvature is 0; and if this hold for every point of S , then may S be flattened out (being regarded as a perfectly flexible inextensible film) on a plane, which also has zero curvature at every point; S is then said to be *developable*.

218. Maxima and Minima.—We have already seen from geometrical considerations that the general conditions for the existence of a maximum or minimum of $z = f(x, y)$ are

$$z_x = 0, \quad z_y = 0, \quad AB - C^2 > 0.$$

But hereby we are not enabled to distinguish maximum from minimum. The same conditions may be established analytically, thus

$$\begin{aligned} f(x+h, y+k) - f(x, y) \\ = (hz_x + kz_y)_1 + \frac{1}{2}(h^2A + 2hkB + k^2C)_2 + T, \end{aligned}$$

where T contains terms of at least third degree in h and k . Now if $f(x, y)$ be either maximum or minimum, then the right member of this equation must not change sign for any pair of infinitesimal values of h and k , $f(x, y)$ must be greater (or less) than *any* $f(x+h, y+k)$ in the immediate vicinity. But for h and k small at will, the sign of the right member is controlled by ()₁, since all following terms are of higher degree, *unless*

$$hz_x + kz_y = 0;$$

however, ()₁ manifestly changes sign with h and k , being of odd degree; hence there can be no maximum nor minimum in general unless $hz_x + kz_y = 0$ for all infinitesimal values of h and k . Now the fact is a simple but an important one, that in order for the sum of a number of *independent* variables to vanish, the coefficients of each must vanish separately. For we may equate all but one of the variables to 0, and that one to a value

different from 0; then the coefficient of that one must be 0, since the whole sum is 0; and so for the other coefficients. Hence we must have $z_x=0, z_y=0$. The sign of the right member now depends on $()_2$, which must be <0 for maximum, >0 for minimum, and must not change sign for h and k small at will. This $()_2$ may be written

$$\frac{1}{A} \{(Ah + Bk)^2 + k^2(AC - B^2)\}.$$

In this expression $(Ah + Bk)^2$ is positive: if then $AC - B^2 < 0$, by choosing h and k properly we may make the whole $\{ \}$ positive or negative at will, hence maximum and minimum are then impossible. But if $AC - B^2 > 0$, then the whole $\{ \}$ is positive, or at least not negative, for all values of h and k , and $\frac{1}{A} \{ \}$ is $+$ or $-$, yielding minimum or maximum, according as A is $+$ or $-$.

The same holds for $AC - B^2 = 0$, in which case the indicatrix is a parabola.*

Similar analysis shows that for $u = f(x, y, z)$ to be maximum or minimum we must have

$$u_x = 0, \quad u_y = 0, \quad u_z = 0,$$

while the controlling expression

$$\left(h \frac{\partial u}{\partial x} + k \frac{\partial u}{\partial y} + l \frac{\partial u}{\partial z} \right)^2 \\ = h^2 \frac{\partial^2 u}{\partial x^2} + 2hk \frac{\partial^2 u}{\partial x \partial y} + k^2 \frac{\partial^2 u}{\partial y^2} + 2hl \frac{\partial^2 u}{\partial x \partial z} + 2kl \frac{\partial^2 u}{\partial y \partial z} + l^2 \frac{\partial^2 u}{\partial z^2}$$

*In this case $\{ \}$ will be $+$ *except* along the right line $Ah + Bk = 0$, i.e., $Ax + By = 0$, which represents two coincident tangents to contour lines. We should now investigate the cubic $(hz_x + kz_y)^3$, which must vanish for $Ah + Bk = 0$, if there is to be maximum or minimum, and the biquadratic $(hz_x + kz_y)^4$ must be independent in sign of h and k for $Ah + Bk = 0$. In this case the contour lines coincide through a finite length, and we have a *locus* or *ridge* of maxima (*resp.* minima), as around the crater of a volcano.

must not change sign for h, k, l at will. This may be written

$$\frac{1}{u_{xx}}(hu_{xx} + ku_{xy} + lu_{xz})^2 + \frac{1}{u_{xx}\Delta_3}(k\Delta_3 + l\Delta_2)^2 + \frac{\Delta}{\Delta_3}l^2.$$

where Δ is the so-called **Hessian**

$$\begin{vmatrix} u_{xx} & u_{xy} & u_{xz} \\ u_{yx} & u_{yy} & u_{yz} \\ u_{zx} & u_{zy} & u_{zz} \end{vmatrix},$$

and Δ_2, Δ_3 are the minors of u_{yz}, u_{zz} . In order for this sum of squares not to change sign with h, k, l at will, the coefficients must have the same sign; hence Δ_3 must be +, and then u is maximum or minimum according as u_{xx} and Δ are both - or both +.

In case the terms of second order also vanish, further and tedious investigations will be necessary, but often geometric considerations will resolve all doubts very simply.

219. Relative Maxima and Minima.—Thus far we have supposed x and y quite independent of each other, but we often inquire for maxima and minima when some equation of condition connects x and y . This is like seeking, not the peaks or depressions of the whole mountain range, but the highest and lowest points on some trail over the range. We may at once generalize the problem and ask for the maxima and minima of a function of $(m+n)$ arguments subject to m conditions: $\phi_1=0, \phi_2=0, \dots, \phi_m=0$. Theoretically we may eliminate m arguments, and then treat the resulting function of n independent arguments according to Art. 218; or we may select n arguments for independents, treat the other m arguments as dependents, derive the original function and the m equations with respect to the n independents, and then eliminate; but both these methods will generally be tedious and often impracticable, owing to the difficulty

of elimination. Preferable is Lagrange's *Method of Undetermined Multipliers*.

Let $f(x_1, x_2, \dots, x_{m+n})$ be the function to be maximized or minimized, $\phi_1(x_1, x_2, \dots, x_{m+n})=0, \phi_2=0, \dots, \phi_m=0$ the m equations of condition. We form a *new* function $F(x_1, x_2, \dots, x_{m+n})=f-\lambda_1\phi_1-\lambda_2\phi_2-\dots-\lambda_m\phi_m$, where the λ 's are undetermined multipliers. Since the ϕ 's are always equal to 0 separately, the values of f and F are always equal, and we now seek the maxima and minima of F regarding all the x 's as independent. These will be the maxima or minima of f , since $F=f$, under the m conditions; for the values of the x 's will contain the λ 's, and these latter, being at our disposal, we can choose so as to fulfil the m conditions. In other words we form the $(m+n)$ partial derivatives of F as to the x 's and equate each to zero, thus:

$$\frac{\partial F}{\partial x_1} = \frac{\partial f}{\partial x_1} - \lambda_1 \frac{\partial \phi_1}{\partial x_1} - \dots - \lambda_m \frac{\partial \phi_m}{\partial x_1} = 0, \dots, \frac{\partial F}{\partial x_{m+n}} = 0.$$

These $(m+n)$ equations, with the m conditions, $\phi_1=0, \dots, \phi_m=0$, make $(2m+n)$ equations, which suffice to determine $(2m+n)$ magnitudes, namely, $(m+n)$ x 's and m λ 's.

Maxima and Minima thus existing under such restrictions or equations of condition are called **Relative** Maxima and Minima.

Undetermined multipliers may be used quite similarly in finding *Envelopes* when n parameters are subject to $n-1$ conditions: if $f(x, y; p_1, \dots, p_n)=0$ be the equation of the system of curves, and $\phi_1(p_1, p_2, \dots, p_n)=0, \phi_2=0, \dots, \phi_{n-1}=0$ be the conditions on the parameters, then we form the new function

$$F(x, y; p_1, \dots, p_n) = f(x, y; p_1, \dots, p_n) - \lambda_1\phi_1 - \dots - \lambda_{n-1}\phi_{n-1} = 0$$

and equate to 0 each partial derivative of F as to the p 's; we have then in all $2n$ equations, from which we

can eliminate $(2n-1)$ symbols, the p 's and λ 's, and obtain a relation $\psi(x, y)=0$, the equation of the *Envelope*.

It is often well to retain the λ 's as long as possible in the calculation and express the variables through them; often, too, the partial derivative equations, $\frac{\partial F}{\partial x_1}=0$, etc., may be interpreted to declare adequately the state of geometric fact, without finding the x 's.

220. Illustrations.—1. Find the equations of the tangent-plane and of the normal to the sphere

$$x^2 + y^2 + z^2 - a^2 = 0.$$

Here $F_x=2x$, $F_y=2y$, $F_z=2z$; hence if u, v, w be current coordinates for the plane and the normal we have for the plane

$$2x(u-x) + 2y(v-y) + 2z(w-z) = 0,$$

or since (x, y, z) is on the sphere,

$$xu + yv + zw = a^2;$$

and for the normal

$$\frac{u-x}{2x} = \frac{v-y}{2y} = \frac{w-z}{2z}, \text{ or } \frac{u}{x} = \frac{v}{y} = \frac{w}{z},$$

the equations of a right line through the origin, *i.e.* the centre.

2. Similarly for the ellipsoid $\frac{x^2}{a^2} + \frac{y^2}{b^2} + \frac{z^2}{c^2} - 1 = 0$, the paraboloids $\frac{x^2}{a^2} + \frac{y^2}{b^2} = 4\frac{z}{n}$, and the hyperboloids

$$\frac{x^2}{a^2} + \frac{y^2}{b^2} - \frac{z^2}{c^2} \pm 1 = 0,$$

and show that the plane tangent to the conicoid

$$kx^2 + jy^2 + iz^2 + 2hxy + 2gxz + 2fyz + 2lx + 2my + 2nz + d = 0$$

is $kux + jvy + iwz + h(uy + vx) + g(uz + wx) + f(vz + wy)$

$$+ l(u+x) + m(v+y) + n(w+z) + d = 0.$$

3. In optics we meet with a plane

$$lx + my + nz - d = 0,$$

whose parameters l, m, n, d are so related that

$$l^2 + m^2 + n^2 - 1 = 0, \text{ and } \frac{l^2}{d^2 - a^2} + \frac{m^2}{d^2 - b^2} + \frac{n^2}{d^2 - c^2} = 0;$$

what is the envelope of this plane? what surface does it touch?

We form the new function $F = f - \lambda\phi - \mu\psi$, which $= f$ for $\phi = 0$ and $\psi = 0$.

Now regarding the four parameters l, m, n, d as independent we must have the total derivative of F as to all the parameters $= 0$, and therefore the partial derivatives as to l, m, n, d each $= 0$. That is,

$$x - 2\lambda l - 2\mu \frac{l}{d^2 - a^2} = 0, \dots\dots\dots(1)$$

$$y - 2\lambda m - 2\mu \frac{m}{d^2 - b^2} = 0, \dots\dots\dots(2)$$

$$z - 2\lambda n - 2\mu \frac{n}{d^2 - c^2} = 0, \dots\dots\dots(3)$$

$$-1 + 2\mu d \left\{ \frac{l^2}{(d^2 - a^2)^2} + \frac{m^2}{(d^2 - b^2)^2} + \frac{n^2}{(d^2 - c^2)^2} \right\} = 0. \dots(4)$$

Multiply (1), (2), (3) by l, m, n and add;

$$\therefore 2\lambda = d. \dots\dots\dots(5)$$

Multiply (1), (2), (3) by x, y, z and add;

$$\therefore x^2 + y^2 + z^2 - d^2 = r^2 - d^2 = 2\mu \left\{ \frac{lx}{d^2 - a^2} + \frac{my}{d^2 - b^2} + \frac{nz}{d^2 - c^2} \right\}. (6)$$

In (1), (2), (3), transpose, square, and add;

$$\therefore r^2 - d^2 = \mu/\lambda. \dots\dots\dots(7)$$

Hence from (5) and (7), $2\mu = d(r^2 - d^2). \dots\dots\dots(8)$

Substitute for 2λ and 2μ in (1), (2), (3);

$$\therefore \frac{x}{r^2 - a^2} = \frac{ld}{d^2 - a^2}, \quad \frac{y}{r^2 - b^2} = \frac{md}{d^2 - b^2}, \quad \frac{z}{r^2 - c^2} = \frac{nd}{d^2 - c^2}. \dots(9)$$

Multiply these by x, y, z ; then from (6), by adding,

$$\frac{x^2}{r^2 - a^2} + \frac{y^2}{r^2 - b^2} + \frac{z^2}{r^2 - c^2} = 1;$$

subtract $\frac{x^2 + y^2 + z^2}{r^2} = 1;$

$$\therefore \frac{a^2 x^2}{r^2 - a^2} + \frac{b^2 y^2}{r^2 - b^2} + \frac{c^2 z^2}{r^2 - c^2} = 0.$$

This is the **Wave-Surface** of *Fresnel*.

4. Find the equation of the tangent planes of a cone, the vertex being the origin.

The equation of the cone is $z = x\phi(y/x)$, whence if u, v, w be current coordinates for the plane,

$$x(w - z) = z(u - x) + (xu - yv)\phi'(y/x).$$

This equation of the plane is satisfied for $u = v = w = 0$, for all values of x, y, z ; hence all such planes pass through the origin, the vertex, while for $x = y = z = 0$ the equation loses all meaning.

5. Find the pedal surface as to the origin (locus of foot of normal from origin to tangent plane) of

$$\frac{x^2}{a^2} + \frac{y^2}{b^2} + \frac{z^2}{c^2} = 1.$$

The tangent plane is

$$\frac{xu}{a^2} + \frac{yv}{b^2} + \frac{zw}{c^2} = 1;$$

the normal is $\frac{a^2 u}{x} = \frac{b^2 v}{y} = \frac{c^2 w}{z} = \lambda^2.$

Hence $xu = a^2 u^2 / \lambda^2, \quad yv = b^2 v^2 / \lambda^2, \quad zw = c^2 w^2 / \lambda^2;$

hence $\lambda^2 = u^2 + v^2 + w^2.$

Also $\frac{x}{a} = \frac{au}{\lambda^2}, \quad \frac{y}{b} = \frac{bv}{\lambda^2}, \quad \frac{z}{c} = \frac{cw}{\lambda^2}.$

Hence on squaring and adding,

$$a^2 u^2 + b^2 v^2 + c^2 w^2 = (u^2 + v^2 + w^2)^2 = r^4.$$

This is *Fresnel's Surface of Elasticity*.

Show that the tangent plane is

$$(2r^2 - a^2)ux + (2r^2 - b^2)vy + (2r^2 - c^2)wz = r^4,$$

and is distant $r^4/\sqrt{a^4u^2 + b^4v^2 + c^4w^2}$ from the origin.

6. Investigate the *circular spiral* or *helix*.

Its equations are $x = a \cos \theta$, $y = a \sin \theta$, $z = b\theta$.

Its projection on XY is $x^2 + y^2 = a^2$; its projections on YZ and ZX are sinusoids: $y = a \sin z/b$, $x = a \cos z/b$; the length of a spire is $2\pi\sqrt{a^2 + b^2}$; $\cos \gamma$ is constant ($= b/\sqrt{a^2 + b^2}$), hence tangent cuts all elements of the cylinder under the same angle, the curve is the isogonal trajectory of the elements of the cylinder; also $\cos \nu$ is constant ($= a/\sqrt{a^2 + b^2}$), hence the binormals and therefore the osculatory planes are like-sloped to Z ; also $\cos N$ is constant ($= 0$), hence the principal normals are all parallel to XY ; all the curvatures and the radius of the osculatory sphere are also constant.

7. Investigate the *conical spiral*.

Its equations are $x = t \cos(a \log t)$, $y = t \sin(a \log t)$, $z = bt$.

It lies on the cone $x^2 + y^2 = z^2/b^2$; its projection on XY is a logarithmic spiral $r = e^{\phi/a}$, where $\tan \phi = y/x$; γ is constant; the curve cuts all elements of the cone isogonally, under the $\sin^{-1} a/\sqrt{1 + a^2 + b^2}$; binormals and hence osculatory planes are all like-sloped to Z , principal normals all parallel to XY ; the radius of torsion is $(1 + a^2 + b^2)t/ab$, the radius of first curvature is proportional hereto

$$(1 + a^2 + b^2)t/a\sqrt{1 + a^2}, \text{ etc.}$$

8. Investigate the curve of intersection of the two cylinders $x^2 + z^2 = a^2$ and $y^2 + z^2 = b^2$.

The tangent is $ux + wz = a^2$, $vy + wz = b^2$.

Normal plane is $\frac{u}{x} + \frac{v}{y} - \frac{w}{z} = 1$.

Osculatory plane is

$$b^2x^3u - a^2y^3v + (a^2 - b^2)z^3w = a^2b^2(a^2 - b^2).$$

Tangent lengths to YZ , ZX , XY are mx^2 , my^2 , mz^2 ,

where
$$m = \sqrt{\frac{1}{x^2} + \frac{1}{y^2} + \frac{1}{z^2}}.$$

Osculatory plane is also

$$b^2x^3u - a^2y^3v + (b^2x^2 - a^2y^2)zw = a^2b^2(x^2 - y^2).$$

And so on.

9. Investigate the *spherical ellipse*.

Its equations are $x^2 + y^2 + z^2 = r^2$, $\frac{x^2}{a^2} + \frac{y^2}{b^2} + \frac{z^2}{c^2} = 1$.

Forming the difference of these equations we see the curve lies on a cone; eliminating x , y , z in turn, we see it lies on three cylinders, namely,

$$\left(\frac{c^2}{a^2} - 1\right)x^2 + \left(\frac{c^2}{b^2} - 1\right)y^2 = c^2 - r^2,$$

and two other such.

If (l, m, n) be a point on the curve, then

$$\left(\frac{c^2}{a^2} - 1\right)l^2 + \left(\frac{c^2}{b^2} - 1\right)m^2 = c^2 - r^2,$$

whence by subtraction and simple reductions

$$\frac{x^2 - l^2}{a^2(b^2 - c^2)} = \frac{y^2 - m^2}{b^2(c^2 - a^2)} = \frac{z^2 - n^2}{c^2(a^2 - b^2)},$$

the last expression following from symmetry.

These equations of the curve are the most convenient.

We have

$$y_x = \frac{x}{y} \cdot \frac{b^2(c^2 - a^2)}{a^2(b^2 - c^2)}, \quad y_{2x} = -\frac{b^4(c^2 - a^2)(c^2 - r^2)}{a^2(c^2 - b^2)^2} \cdot \frac{1}{y^3},$$

and the others follow from symmetry.

All the geometric elements may now be expressed readily. The sum of the distances (measured on great circles) from two fixed points on the sphere to any point of the spherical ellipse is constant, hence the name.

10. Investigate the intersection of the circular cylinder $x^2 + y^2 = a^2$ and the parabolic cylinder $z^2 = 2qx$.

By addition and subtraction we obtain

$$(x - q)^2 + y^2 + z^2 = a^2 + q^2, \quad (x + q)^2 + y^2 - z^2 = a^2 + q^2,$$

so that the intersection lies on a sphere and on a simple hyperboloid of revolution. The geometric elements are now easy to express.

11. Investigate the *equable spherical spiral*, i.e., the intersection of the sphere $x^2 + y^2 + z^2 = 4a^2$ with the cylinder $x^2 + y^2 = 2ax$ through the sphere-centre.

$$\rho = \frac{(2a + x)^{\frac{3}{2}}}{(10a + 3x)^{\frac{1}{2}}}.$$

12. Find the envelope of the plane that bounds with the coordinate planes a pyramid of constant volume, k^3 .

We have
$$\frac{x}{a} + \frac{y}{b} + \frac{z}{c} = 1, \quad abc = 6k^3;$$

we form
$$U = \frac{x}{a} + \frac{y}{b} + \frac{z}{c} - 1 + \lambda(abc - 6k^3);$$

then
$$U_a = -\frac{x}{a^2} + \lambda bc = 0, \quad -\frac{y}{b^2} + \lambda ca = 0, \quad -\frac{z}{c^2} + \lambda ab = 0;$$

whence
$$\frac{x}{a} = \frac{y}{b} = \frac{z}{c} = \frac{1}{3} \quad \text{and} \quad 9xyz = 2k^3.$$

13. Find the envelope of a system of equal spheres, their centres on a circle about the origin in XY , radius c .

We have
$$(x - a)^2 + (y - b)^2 + z^2 = r^2, \quad a^2 + b^2 = c^2.$$

The result is
$$c + \sqrt{x^2 + y^2} = \sqrt{r^2 - z^2}.$$

14. Find the area of a central section of an ellipsoid. The equations are

$$\frac{x^2}{a^2} + \frac{y^2}{b^2} + \frac{z^2}{c^2} = 1 \quad \text{and} \quad lx + my + nz = 0,$$

and we find the axes of the elliptic section by maximizing-minimizing $r^2 = x^2 + y^2 + z^2$. Hence

$$U = x^2 + y^2 + z^2 - \lambda \left(\frac{x^2}{a^2} + \frac{y^2}{b^2} + \frac{z^2}{c^2} - 1 \right) - 2\mu(lx + my + nz);$$

$$\frac{1}{2}U_x = x - \frac{\lambda x}{a^2} - \mu l = 0, \quad y - \frac{\lambda y}{b^2} - \mu m = 0, \quad z - \frac{\lambda z}{c^2} - \mu n = 0.$$

Multiply by x, y, z and add; hence $\lambda = r^2$, thence

$$x = \frac{\mu a^2 l}{a^2 - r^2},$$

and so for y and z ; whence forming $lx + my + nz$,

$$\frac{a^2 l^2}{r^2 - a^2} + \frac{b^2 m^2}{r^2 - b^2} + \frac{c^2 n^2}{r^2 - c^2} = 0.$$

The product of the roots r_1^2 and r_2^2 of this equation is

$$a^2 b^2 c^2 / (a^2 l^2 + b^2 m^2 + c^2 n^2);$$

hence $\text{Area} = \pi abc / \sqrt{a^2 l^2 + b^2 m^2 + c^2 n^2}$.

15. Find the maximum and minimum radii of a central section of the *surface of elasticity*.

The equations are

$$(x^2 + y^2 + z^2)^2 \equiv r^2 = a^2 x^2 + b^2 y^2 + c^2 z^2, \quad lx + my + nz = 0,$$

and we must maximize respectively minimize r or r^2 .

Proceeding as in 14 we obtain

$$\frac{l^2}{r^2 - a^2} + \frac{m^2}{r^2 - b^2} + \frac{n^2}{r^2 - c^2} = 0,$$

a quadratic in r^2 with real positive roots, hence the r 's are real. This equation yields the velocities of undulation in a crystalline doubly refracting medium.

16. Maximize $ax + by + cz$ when $x^2 + y^2 + z^2 = 1$, and interpret geometrically. *Ans.* $\sqrt{a^2 + b^2 + c^2}$.

17. Maximize the cuboid inscribed in an ellipsoid.

Here $u = xyz$, and $\frac{x^2}{a^2} + \frac{y^2}{b^2} + \frac{z^2}{c^2} = 1$; hence $u = abc / \sqrt{27}$.

18. How must the prime factors of a number enter into it that it may have as many divisors as possible? (Waring.)

Let a, b, \dots, l be the prime factors and $a^\alpha \cdot b^\beta \cdot \dots \cdot l^\lambda =$ the number N . The divisors are found by taking a, b, \dots singly or in any combination; the factors due to a are $a^0, a^1, a^2, \dots, a^\alpha$, and these may be taken in any combination with the b 's, etc. Hence the total number of different factors is $M = (\alpha + 1) \cdot (\beta + 1) \cdot \dots \cdot (\lambda + 1)$. This M attains maximum when its logarithm does; hence we maximize

$$\log M \equiv u = \log(\alpha + 1) + \log(\beta + 1) + \dots + \log(\lambda + 1);$$

or $V = \Sigma \log(\alpha + 1) - \frac{1}{\mu} \Sigma \alpha \log a - \frac{1}{\mu} \log N;$

$$V_\alpha = \frac{1}{\alpha + 1} - \frac{1}{\mu} \cdot \log a = 0, \quad V_\beta = \frac{1}{\beta + 1} - \frac{1}{\mu} \cdot \log b = 0, \text{ etc.}$$

Hence

$$\mu = (\alpha + 1) \log a = \log a^\alpha + \log a = \log b^\beta + \log b = \text{etc.}$$

Hence if n be the number of different prime factors a, b, \dots, l , we have

$$n\mu = \Sigma \log a^\alpha + \Sigma \log a = \log N + \log ab \dots l = \log Na \dots l,$$

or $\mu = (\log Nab \dots l)/n, \quad \alpha + 1 = (\log Nab \dots l)/n \log a,$

and so on. Hence

$$\alpha + 1 : \beta + 1 : \dots : \lambda + 1 = \frac{1}{\log a} : \frac{1}{\log b} : \dots : \frac{1}{\log l}.$$

19. Show that among cuboids the cube has greatest volume with given surface and least surface with given volume.

20. Show that $\frac{1}{3}$ is a maximum product of the cosines of the angles of a plane triangle.

21. Find maximum and minimum radii of curvature

of a curved surface. Denoting (with Euler) $z_x, z_y, z_{2x}, z_{xy}, z_{2y}, 1+p^2+q^2$, by p, q, r, s, t, κ^2 , we have

$$\frac{\kappa}{\rho} = rx^2 + 2sxy + ty^2,$$

under the condition

$$(1+p^2)x^2 + 2pqxy + (1+q^2)y^2 - 1 = 0.$$

Introduce λ and derive as to x and y ; thence

$$rx + sy - \lambda\{(1+p^2)x + pqy\} = 0,$$

$$sx + ty - \lambda\{(1+q^2)y + pqx\} = 0.$$

Multiply by x respectively y and add; thence $\lambda = \kappa/\rho$. Substitute and collect terms in x and y ; thence

$$x\left\{\frac{\kappa}{\rho}(1+p^2) - r\right\} = -y\left\{\frac{\kappa}{\rho}pq - s\right\},$$

$$y\left\{\frac{\kappa}{\rho}(1+q^2) - t\right\} = -x\left\{\frac{\kappa}{\rho}pq - s\right\},$$

Multiply these equations together, divide by xy , and there results:

$$\rho^2(rt - s^2) - \kappa\rho\{(1+p^2)t - 2pqrs + (1+q^2)r\} + \kappa^2(1+p^2+q^2) = 0,$$

a quadratic for determining ρ .

22. Show that $(a^{\frac{1}{4}} + b^{\frac{1}{4}})^{-4}$ is maximum of

$$xyz/(a+x)(x+y)(y+z)(z+b).$$

23. If AA', BB', CC' be altitudes of an acute-angled triangle, show that $A'B'C'$ of all triangles inscribed in ABC has least perimeter.

24. Find distance (or minimum tract) from a fixed point to a fixed right line.

25. Find axes of ellipse cut out of the elliptic cylinder $4x^2 + y^2 = 1$ by the plane $12x - 3y + 4z = 0$. *Ans.* $\sqrt{13}$ and $\frac{1}{2}\sqrt{13}$; direction cosines are as $-3:4:12$, and as $4:12:-3$.

26. Find axes of section of

$$3x^2 + 2y^2 + z^2 = 1 \text{ by } 12x + 4z = 3y.$$

Ans. $\sqrt{\frac{13}{17}}$, $\sqrt{\frac{15}{9}}$; direction cosines as 3 : -4 : -12, and as 4 : 12 : -3.

27. Find dimensions of strongest beam that can be cut from a cylindric tree of diameter d , the cohesion varying as the breadth and squared depth. *Ans.* $d\sqrt{\frac{1}{3}}$, $d\sqrt{\frac{2}{3}}$.

28. Show that in

$$u = (x + y + z)^3 - 3(x + y + z) - 24xyz + a^3$$

the triplet (1, 1, 1) yields a maximum, (-1, -1, -1) a minimum, while (± 1 , 0, 0), (0, ± 1 , 0), (0, 0, ± 1) are *anticlastic* (neither maximum nor minimum).

29. Find when Venus appears brightest.

Let E , V , S be Earth, Venus, Sun;

$$EV = x, \quad SE = a, \quad SV = b.$$

The brightness varies directly as $1 + \cos SEV$, inversely as x^2 ;

$$\cos SEV = \frac{x^2 + b^2 - a^2}{2bx}, \quad 1 + \cos SEV = \frac{(x + b)^2 - a^2}{2bx}.$$

Hence $u = \frac{(x + b)^2 - a^2}{x^3}$; whence for maximum,

$$x = -2b + \sqrt{b^2 + 3a^2}.$$

For $a = 300$, $b = 217$ (circa); whence $x = 129.1$, and

$$SEV = 39^\circ 43' 28'' \text{ (circa),}$$

about 64 days before and after inferior conjunction.

30. To inscribe a maximum ellipse in a given triangle.

OAB the given Δ , $OA = a$, $OB = b$, $\angle AOB = \omega$; take OA , OB as X - and Y -axes; let (u, v) be the centre of the ellipse; then its equation is

$$k(x - u)^2 + 2h(x - u)(y - v) + j(y - v)^2 = 1.$$

Since X is tangent, $y=0$ must yield equal roots in x , or what is tantamount, in $x-u$; hence the discriminant

$$kjv^2 - k - h^2v^2 = 0, \text{ or } k = (kj - h^2)v^2 = Cv^2,$$

where C is the *criterion* and is >0 for an ellipse.

$$\text{Similarly, } j = Cu^2; \quad h = \sqrt{C^2u^2v^2 - C}; \quad u^2 = j/C.$$

To find area of ellipse, solve as to $y-v$;

$$\therefore jy = jv - h(x-u) \pm \sqrt{j - C(x-u)^2}.$$

The difference of these two y 's is the chord parallel to Y ; hence

$$\begin{aligned} \text{Area} &= \sin \omega \int_0^{2u} (y_1 - y_2) dx = \sin \omega \cdot \frac{2}{j} \int_{-u}^u \sqrt{j - C(x-u)^2} \cdot d(x-u) \\ &= 2 \sin \omega \frac{\sqrt{C}}{j} \int_{-u}^u \sqrt{u^2 - (x-u)^2} d(x-u) = \frac{\pi \sin \omega}{\sqrt{C}}. \end{aligned}$$

Hence the problem is to maximize $\frac{1}{\sqrt{C}}$. This C contains k, h, j ; we may eliminate them, and express C in terms of u and v , by validating the third condition, that AB touch the ellipse. The equation of AB is $y = sx + b$, or $y - v = s(x - u) + d$, where $s = -\frac{b}{a}$ and $d = us - v + b$. On substituting this value of $y - v$ the roots of the original equation in $x - u$ must again become equal; hence

$$(k + 2hs + js^2)(d^2 - 1) - d^2(h + js)^2 = 0;$$

hence $kj - h^2$ or $C = (k + 2hs + js^2)/d^2$

$$= (ka^2 + 2hab + jb^2)/(av + bu - ab)^2.$$

Divide by C , remember $h^2 = C^2u^2v^2 - C$, and put $z = av + bu$; then clear of fractions, destroy the terms a^2v^2 and b^2u^2 , divide by ab , and there results

$$2\sqrt{u^2v^2 - \frac{1}{C}} = ab + 2uv - 2z.$$

Square, transpose, factor, and there results

$$(4uv + ab - 2z)(2z - ab) = 4/C.$$

We equate now to 0 the partial derivatives as to the independents u and v , so that

$$(4v - 2b)(2z - ab) + (4uv + ab - 2z)2b = 0,$$

$$(4u - 2a)(2z - ab) + (4uv + ab - 2z)2a = 0.$$

Multiply by a respectively $(-b)$ and add; there results either $2z - ab = 0$, which makes $C = \infty$, and must be rejected, or else, on simplifying, $av = bu$. Whence on eliminating v there results $6u^2 - 5au + a^2 = 0$; whence

$$u = \frac{1}{2}a \text{ or } \frac{1}{3}a, \quad v = \frac{1}{2}b \text{ or } \frac{1}{3}b.$$

The point $(a/2, b/2)$ is the mid-point of AB and does not concern us; it makes $C = 0$ and so yields no ellipse but a parabola; the point $(a/3, b/3)$ is the centroid of the Δ , and is the centre sought.

$$\text{Hence the area} = \frac{\pi ab}{2\sqrt{27}} \sin \omega = \frac{\pi}{\sqrt{27}} (\text{area of } \Delta).$$

Show the points of touch are mid-points of the sides.

31. Similarly show that the min. ellipse about a Δ has the mass-centre of the Δ for its centre and has an area = $\frac{4\pi}{\sqrt{27}}$ (area of Δ). These are Euler's Problems.

32. Show that if $f(x, y) = 0$ and $\phi(x, y) = 0$ meet orthogonally, then $f_x \cdot \phi_x + f_y \cdot \phi_y = 0$; and conversely.

Similarly, if $f(x, y, z) = 0$, $\phi(x, y, z) = 0$ meet orthogonally then $f_x \cdot \phi_x + f_y \cdot \phi_y + f_z \cdot \phi_z = 0$; and conversely.

Hint: The formulae merely declare the cosine of the angle between the normals to be 0.

33. Trace the system of conicoids

$$\frac{x^2}{a^2 + \lambda} + \frac{y^2}{b^2 + \lambda} + \frac{z^2}{c^2 + \lambda} = 1$$

for λ varying from $+\infty$ to $-\infty$, showing that the

surface starts as an ∞ sphere, and becomes successively ellipsoid, single hyperboloid, double hyperboloid, imaginary ellipsoid as λ passes through $-c^2$, $-b^2$, $-a^2$, and show the surfaces are confocal, and each set (of ellipsoids, single hyperboloids, double hyperboloids) cuts the other two sets orthogonally.

34. Show that the systems of anchor-rings

$$(x^2 + y^2 + z^2 + a^2)^2 = 4a^2\lambda^2(x^2 + y^2),$$

of spheres, $x^2 + y^2 + z^2 - 2a\mu z = a^2$,

of planes, $y = vx$, cut each other orthogonally for all values of λ , μ , v .

35. Show that the equation of a tore (formed by revolving a circle of radius a about an axis z in its plane, distant d from its centre) is

$$(x^2 + y^2 + z^2 + a^2 + d^2)^2 = 4d^2(x^2 + y^2);$$

and that this tore has a circular **ridge** of maxima and one of minima for z —where?

Compare this with Example 13.

CHANGE OF VARIABLES.

221. Use of a third Independent Variable.—In Coordinate Geometry a frequent and important problem is that of the Transformation of Coordinates, to pass from one set of coordinates to another, as from rectilinear to polar, or *vice versa*. The analogous problem in the Calculus, to pass from one set of variables to another, is of like importance.

Perhaps the simplest general case that arises is that of *expressing the derivatives of y as to x through the derivatives of each as to a third variable, say t* . We

have then $y_t = y_x \cdot x_t$, whence $y_x = y_t/x_t = \frac{y'}{x'}$, if we denote by accents derivation as to t .

$$y_{2x} \equiv \frac{d^2 y}{dx^2} = \frac{y'' \cdot x' - y' x''}{x'^3} = \left| \begin{array}{cc} y'' & x'' \\ y' & x' \end{array} \right| x'^3,$$

where we note that in order to derive as to x , we first derive as to t , and then divide the result by x' ; or in symbols, $\frac{d}{dx} = \frac{1}{x_t} \cdot \frac{d}{dt}$.

The numerator in this result is a noteworthy determinant form, which we may generalize and write thus

$$D_{ns} = \left| \begin{array}{cc} y^{(n)} & x^{(n)} \\ y^{(s)} & x^{(s)} \end{array} \right|,$$

where the indices denote derivation as to t .

If now we derive this as to t we get

$$D'_{ns} = y^{(n+1)}x^s + y^{(n)}x^{(s+1)} - y^{(s+1)}x^{(n)} - y^s x^{(n+1)} = D_{(n+1)s} + D_{n(s+1)}$$

$$\text{We have now} \quad y_{2x} \equiv \frac{d^2 y}{dx^2} = D_{21}/x'^3,$$

whence

$$y_{3x} = \frac{d^3 y}{dx^3} = \frac{(D_{31} + D_{22})x'^3 - 3x'^2 x'' D_{21}}{x'^7} = \frac{D_{31} \cdot x' - 3x'' D_{21}}{x'^5},$$

and the higher derivatives may be similarly written off.

222. A special case, that of **exchanging argument and function**, arises for $t = y$; we then express the derivatives of y as to x through those of x as to y .

$$y_x = \frac{1}{x_y}, \quad y_{2x} = -\frac{x_{2y}}{(x_y)^3}, \quad y_{3x} = \frac{-x_y x_{3y} + 3(x_{2y})^2}{(x_y)^5},$$

since $y'' = y''' = 0$.

Similarly we may form the higher derivatives, but the expressions are cumbrous.

223. Reversion of Series.—By help of Taylor's Theorem we may obtain a larger comprehension of this last problem.

Denoting by k the function-difference $f(x+h) - f(x)$ corresponding to the argument-difference h , we have

$$k = hf' + h^2 \frac{f''}{2} + h^3 \frac{f'''}{3} + \dots,$$

when the f 's are the special values for the argument x of the derivatives as to x of $y \equiv f(x)$. Denoting $\frac{f^{(n)}}{n} \equiv \frac{y^{(n)}}{n}$ by d_n , we have $k = d_1 h + d_2 h^2 + d_3 h^3 + \dots$.

Similarly, if $x \equiv f^{-1}(y) = \phi(y)$, we shall have a function-difference $h \equiv \phi(y+k) - \phi(y)$ corresponding to the argument-difference k , and if $e_n = \frac{\phi^{(n)}}{n} \equiv \frac{x^{(n)}}{n}$, we shall have by Taylor's Theorem $h = e_1 k + e_2 k^2 + e_3 k^3 + \dots$.

Now to deduce this series for h from the series for k is to **revert** this latter series; to accomplish this reversion we must express the e 's through the d 's, that is, the derivatives of x as to y through the derivatives of y as to x ; hence this problem of *exchanging* function and argument is analytically the same as the problem of *reverting a power-series*, namely, Taylor's Series. We solve this latter problem by substituting for h in the first series its value given in the second series, namely, $h = e_1 k + \text{etc.}$; the result is a power-series in k , and we express the e 's through the d 's by the familiar method of equating to 0 the coefficients of the powers of k , thus:

$$\begin{aligned} d_1 e_1 - 1 &= 0, & d_1 e_2 + d_2 e_1^2 &= 0, & d_1 e_3 + 2d_2 e_1 e_2 + d_3 e_1^3 &= 0, \\ d_1 e_4 + d_2 (2e_1 e_3 + e_2^2) + 3d_3 e_1^2 e_2 + d_4 e_1^4 &= 0, & \text{etc.} \end{aligned}$$

In each of these equations, but the first, the *sum* of the subscripts of the e 's in each term is constant; the *number* of e -factors in each term is the subscript of the d -factor, while the numeral coefficients are combinatorials. Higher equations may be easily written down. Hence express the e 's through the d 's.

224. Reciprocants.—This old problem of reversion has acquired a new interest under the treatment of Sylvester (*American Journal of Mathematics*, Vol. VIII., p. 196, IX., p. 1, 113, 297) who has studied those functions of the d 's that pass over into like functions of the e 's, changing form either not at all or else only by some power of x_y as a factor; such functions he calls **Reciprocants**, *pure* if they do not contain y_x , *mixed* if they do. Thus the *Mongian* $d_2^2 d_5 - 3d_2 d_3 d_4 + 2d_3^3$ is a pure reciprocant; while the *Schwartzian* $d_1 d_3 - d_2^2$ is mixed. Reciprocants emerge in *Elimination* (Art. 241).

Exercises.—1. Show that the radius of curvature ρ

$$= s_t^{\frac{3}{2}} \left| \begin{array}{cc} y'' & x'' \\ y' & x' \end{array} \right|.$$

2. Show that $4d_3 d_4 - 5d_3^2$ is a pure, and $2d_1 d_4 - 5d_2 d_3$ a mixed, reciprocant.

3. Show that the derivative of the determinant

$$\left| \begin{array}{ccc} y_1^{(n-1)} & y_2^{(n-1)} & \dots y_n^{(n-1)} \\ y_1^{(n-2)} & y_2^{(n-2)} & \dots y_n^{(n-2)} \\ \dots & \dots & \dots \\ y'_1 & y'_2 & \dots y'_n \\ y_1 & y_2 & \dots y_n \end{array} \right|$$

where the indices denote derivations as to the common argument t , of the y 's, is the same determinant with only the first row increased by 1 in order of derivation, *i.e.* changed into $y_1^{(n)} y_2^{(n)} \dots y_n^{(n)}$.

Hint: Prove it when $n=2$; then, using this result, prove it for n =any positive integer.

4. Extend the foregoing theorem to the determinant

$$\left| \begin{array}{ccc} y_1^{(n+s)} & y_2^{(n+s)} & \dots y_n^{(n+s)} \\ \dots & \dots & \dots \\ y_1^{(1+s)} & y_2^{(1+s)} & \dots y_n^{(1+s)} \end{array} \right|.$$

225. Transformation from System to System.—The next problem is to pass from a system (x, y) to another

system (u, v) , and corresponds exactly to a transformation of coordinates in a plane. We suppose x and y expressed through u and v , thus:

$$x = \phi(u, v), \quad y = \psi(u, v);$$

then taking u as argument, we have

$$x_u = \phi_u + \phi_v \cdot v_u, \quad y_u = \psi_u + \psi_v \cdot v_u,$$

whence

$$y_x = \frac{y_u}{x_u} = \frac{\psi_u + \psi_v \cdot v_u}{\phi_u + \phi_v \cdot v_u},$$

$$y_{2x} \equiv \frac{d^2y}{dx^2} \equiv (y_x)_u / x_u$$

$$= \frac{(\psi_{2u} + 2\psi_{uv}\phi_u + \psi_{2v} \cdot v_u^2 + \psi_v \cdot v_{2u})_1 (\phi_u + \phi_v v_u)_2 - (\phi)_1 \cdot (\psi)_2}{(\phi_u + \phi_v \cdot v_u)^3}$$

This formula is cumbrous, and it is in general better to find y_x in terms of u and v , then derive the result as to u , and divide by x_u .

The most important special case is to pass from rectangular to polar coordinates, $+x$ being the polar axis. We have then

$$x = r \cos \theta, \quad y = r \sin \theta;$$

$$x_\theta = r_\theta \cos \theta - r \sin \theta, \quad y_\theta = r_\theta \sin \theta + r \cos \theta,$$

$$y_x \equiv y_\theta / x_\theta = \frac{r_\theta \sin \theta + r \cos \theta}{r_\theta \cos \theta - r \sin \theta}$$

$$y_{2x} \equiv \frac{d^2y}{dx^2} \equiv (y_x)_\theta / x_\theta = \frac{r^2 + 2r_\theta^2 - r \cdot r_{2\theta}}{(r_\theta \cos \theta - r \sin \theta)^2}$$

If ' denote derivation say as to t , then we have

$$x' = r' \cos \theta - r \sin \theta \cdot \theta', \quad y' = r' \sin \theta + r \cos \theta \cdot \theta';$$

whence

$$x x' + y y' = r r', \dots\dots\dots(1)$$

$$x y' - y x' = r^2 \theta', \dots\dots\dots(2)$$

$$x'^2 + y'^2 = r'^2 + r^2 \theta'^2. \dots\dots\dots(3)$$

Equations (1) and (2) we form directly, equation (3) we get by solving (1) and (2) as to x' and y' , squaring, adding, remembering always that $x^2 + y^2 = r^2$. We may

also get (1) by deriving $x^2 + y^2 = r^2$; (2) declares the equality of two elementary triangles in Cartesian and in polar coordinates, and (3) declares the equality of the elementary arcs in the two systems.

Exercises.—1. Express the radius of curvature in polars.

2. Transform $\tan \phi = r\theta_r$ to Cartesians.

226. Change of Independents.—Our next problem is to pass from one set of *two* independent arguments (x, y) to another set (u, v) , these two sets of independents being connected by the relations:

$$x = \phi(u, v), \quad y = \psi(u, v),$$

and we shall of course have to deal with some function of x and y , as $z = f(x, y)$. We inquire into the relations of the partial derivatives of z as to these two sets of variables,

$$z_u \equiv f_u = f_x \cdot x_u + f_y \cdot y_u, \quad f_v = f_x \cdot x_v + f_y \cdot y_v;$$

since f depends on u and v through x and y . But generally we seek f_x and f_y ; and

$$f_x = \frac{f_u \cdot y_v - f_v \cdot y_u}{x_u \cdot y_v - x_v \cdot y_u} = \left| \begin{array}{cc} f_u & y_u \\ f_v & y_v \end{array} \right| \bigg/ \left| \begin{array}{cc} x_u & y_u \\ x_v & y_v \end{array} \right|.$$

The terms of this fraction are very interesting forms; their great importance for analysis was first perceived by Jacobi, and hence they have been named (by Salmon) **Jacobians**. We may write concisely

$$f_x \equiv \frac{\partial f}{\partial x} = \frac{\left| \begin{array}{cc} \frac{\partial f}{\partial u} & \frac{\partial f}{\partial v} \\ \frac{\partial y}{\partial u} & \frac{\partial y}{\partial v} \end{array} \right|}{\left| \begin{array}{cc} \frac{\partial x}{\partial u} & \frac{\partial x}{\partial v} \\ \frac{\partial y}{\partial u} & \frac{\partial y}{\partial v} \end{array} \right|} \equiv \frac{\frac{\partial(f, y)}{\partial(u, v)}}{\frac{\partial(x, y)}{\partial(u, v)}} \equiv \frac{J(f, y; u, v)}{J(x, y; u, v)}.$$

Of course,

$$f_y \equiv \frac{\partial f}{\partial y} = \frac{J(x, f; u, v)}{J(x, y; u, v)}.$$



for partial derivatives. Thus, if $x = r \cos \theta$, $y = r \sin \theta$ be two systems of independent arguments, (x, y) and (r, θ) , we have $\frac{\partial x}{\partial r} = \cos \theta$, and also, since $x^2 + y^2 = r^2$, $\frac{\partial r}{\partial x} = \frac{x}{r} = \cos \theta$, whence $\frac{\partial x}{\partial r} \cdot \frac{\partial r}{\partial x} = \overline{\cos \theta^2}$ and *not* $= 1$. It is *not* the partial derivatives themselves but their *Jacobians* that are inverted by inverting the order of dependence among the symbols. This observation suggests the question whether in any other relations, as in mediate derivation, of which the foregoing is really a special case, the Jacobian plays the rôle of the ordinary derivative. We have

$$\frac{d\phi}{du} \cdot \frac{du}{dx} = \frac{d\phi}{dx},$$

and from analogy we should *suspect*

$$\frac{\partial(\phi, \psi)}{\partial(u, v)} \cdot \frac{\partial(u, v)}{\partial(x, y)} = \frac{\partial(\phi, \psi)}{\partial(x, y)},$$

where ϕ and ψ are functions of u and v , which are themselves functions of x and y . Now

$$\begin{aligned} & \left| \begin{array}{cc|cc} \phi_u & \phi_v & u_x & v_x \\ \psi_u & \psi_v & u_y & v_y \end{array} \right| \\ &= \left| \begin{array}{cc|cc} \phi_u \cdot u_x + \phi_v \cdot v_x & \phi_u \cdot u_y + \phi_v \cdot v_y & \phi_x & \phi_y \\ \psi_u \cdot u_x + \psi_v \cdot v_x & \psi_u \cdot u_y + \psi_v \cdot v_y & \psi_x & \psi_y \end{array} \right|, \end{aligned}$$

which confirms our conjecture; and plainly the same form of proof holds good for n functions $\phi_1, \phi_2, \dots, \phi_n$ of n independents x_1, x_2, \dots, x_n , through n mediate independents u_1, u_2, \dots, u_n .

229. Vanishing of the Jacobian.—We know that the vanishing of $\frac{du}{dx}$ signifies that u is constant with respect to x , and the question is natural, what does the vanishing of the analogous Jacobian $\frac{\partial(u, v)}{\partial(x, y)}$ signify? We should

naturally suspect some *constant relation between u and v* regarded as functions of x and y .

Suppose then

$$f(u, v) = 0.$$

Hence
$$\frac{\partial f}{\partial x} \equiv \frac{\partial f}{\partial u} \cdot \frac{\partial u}{\partial x} + \frac{\partial f}{\partial v} \cdot \frac{\partial v}{\partial x} = 0.$$

$$\frac{\partial f}{\partial y} \equiv \frac{\partial f}{\partial u} \cdot \frac{\partial u}{\partial y} + \frac{\partial f}{\partial v} \cdot \frac{\partial v}{\partial y} = 0.$$

These equations are linear and *homogeneous* in f_u and f_v ; hence, *if they consist*, we must have

$$\begin{vmatrix} u_x & v_x \\ u_y & v_y \end{vmatrix} = 0, \quad \text{or} \quad \frac{\partial(u, v)}{\partial(x, y)} = 0.$$

Quite similarly let the student show that if a relation $f(u, v, w) = 0$ holds among three functions, u, v, w , of three independents x, y, z , then the *Jacobian must vanish*:

$$\frac{\partial(u, v, w)}{\partial(x, y, z)} = 0;$$

and let him extend the proof to the general case of n functions, u_1, \dots, u_n , of n independents, x_1, \dots, x_n .

230. Does the **converse** hold? If the Jacobian vanishes, does some relation hold among the functions?

Suppose
$$\frac{\partial(u, v)}{\partial(x, y)} \equiv \begin{vmatrix} u_x & u_y \\ v_x & v_y \end{vmatrix} = 0.$$

By the law for mediate partial derivation we have

$$\frac{\partial(u, v)}{\partial(x, y)} = \frac{\partial(u, v)}{\partial(u, y)} \cdot \frac{\partial(u, y)}{\partial(x, y)} \equiv \begin{vmatrix} 1 & u_y \\ v_u & v_y \end{vmatrix} \cdot \begin{vmatrix} u_x & u_y \\ 0 & 1 \end{vmatrix} = (v_y - u_y v_u) u_x = 0.$$

We note that y_x vanishes, since x and y are independent, but we are not yet sure whether v_u vanishes or not. Hence either $u_x = 0$, or $v_y = v_u \cdot u_y$.

If $u_x = 0$, then, from the original Jacobian, either $u_y = 0$, or $v_x = 0$; if both $u_x = 0$ and $v_x = 0$, then both u and v are independent of x and at most are functions of y alone, and

on eliminating y between them, we get *some relation between u and v only*; but if both $u_x=0$ and $u_y=0$, then u contains neither x nor y , it is *constant* as to both, is not actually a function of either—a possible case which we need not consider further.

If on the other hand $v_y=v_u \cdot u_y$, two cases arise: first, suppose $v_u=0$; then v is independent of u , but then $v_y=0$, hence v is independent of y , and precisely as before either $v_x=0$, or $u_y=0$; if $v_x=0$, then v is independent of x also, is an absolute constant—a case we reject as before—but if $u_y=0$, then both u and v depend on x alone, and on eliminating x we get *some relation between u and v only*. If, however, v_u does not $=0$, then v is a function of u , there holds *some relation between u and v* . Hence always, *if both u and v are genuine functions of x and y , neither a mere constant, the vanishing of the Jacobian signifies that some relation exists between u and v* —they are not independent, one is expressible through the other.

231. Now let $\frac{\partial(u, v, w)}{\partial(x, y, z)}=0$. As before, we have

$$\frac{\partial(u, v, w)}{\partial(x, y, z)} = \frac{\partial(u, v, w)}{\partial(u, v, z)} \cdot \frac{\partial(u, v, z)}{\partial(x, y, z)} = \begin{vmatrix} 1, & u_v, & u_z \\ v_u, & 1, & v_z \\ w_u, & w_v, & w_z \end{vmatrix} \cdot \begin{vmatrix} u_x, & u_y, & u_z \\ v_x, & v_y, & v_z \\ 0, & 0, & 1 \end{vmatrix} = 0.$$

Hence one of the two determinant factors must $=0$. If the second $=0$, then we have just seen that *some relation holds between u and v* , which may or may not contain z as a constant. In either case, by combining this relation with $u=f_1(x, y, z)$, $v=f_2(x, y, z)$, $w=f_3(x, y, z)$, we may eliminate x, y, z , and get a *relation among u, v, w* . If on the other hand the first factor $=0$, and the derivatives of the functions as to each other, namely, u_v, v_u, w_u, w_v do *not* all $=0$, then *some relation holds among them*, for the derivatives all vanish in case they are all independent of each other. Combining any such relation with the

three given equations for u, v, w , we may again eliminate x, y, z , and obtain a *relation among* u, v, w . But if the derivatives of the functions as to each other all vanish, then w_z must $=0$, hence w must then be independent of z , and $w =$ some function of x , or of y , or of both, or an absolute constant. In this result, from $u=f_1, v=f_2, w=f_3$, we may substitute x and y in terms of u, v, z , and get $w = \phi(u, v)$, for in this result we know z can *not* appear, since we have just seen that w is independent of $z, w_z=0$; and this again is a *relation among* u, v, w . In all cases, then, if u, v, w are genuine functions of x, y, z , and no one of them a mere constant, the vanishing of the Jacobian indicates the *existence of some relation connecting* u, v, w . By precisely similar reasoning let the student extend the proposition to the case of n functions of n independents.

The foregoing argument may be greatly simplified apparently by at once assuming, in the determinant factor, that u, v, w are independent of each other; but it seems inept to assume their independence in order straightway to prove them dependent.

232. Illustrations and Exercises.—1. Transform

$$\frac{x + yy_x}{(1 + y_x^2)^{\frac{1}{2}}} \text{ to } \frac{r}{(1 + r^2 \theta_r^2)^{\frac{1}{2}}}.$$

2. Transform $x^4 y_{2x} + 2x^3 y_x + a^2 y = 0$ into $y_{2z} + a^2 y = 0$ by putting $xz = 1$

3. Transform $xy_{2x} + 2y_x + a^2 xy = 0$ into $z^4 y_{2z} + a^2 y = 0$ by $xz = 1$.

Hint: In this important change of the argument into its *reciprocal*, we have $z_x = -\frac{1}{x^2} = -z^2$; hence

$$y_x = -y_z \cdot z^2, \quad y_{2x} = (-z^2 \cdot y_{2z} - 2z \cdot y_z)(-z^2) = z^4 y_{2z} + 2z^3 \cdot y_z.$$

We derive on the right each time as to z , and multiply

the result by $(-z^2)$; then out of y_x, y_{2x} , etc., we form the equation to be transformed.

4. Transform $(1-x^2)y_{2x}-xy_x+a^2y=0$ by $x=\sin v$;

$$x_v = \cos v = \sqrt{1-x^2}; \quad y_x = y_v / \cos v,$$

$$y_{2x} = (y_{2v} \cos v + y_v \sin v) / \cos^3 v.$$

The result is $y_{2v} + a^2y = 0$.

5. Transform $\frac{d^2y}{dx^2} + \frac{2x}{1+x^2} \cdot \frac{dy}{dx} + \frac{y}{(1+x^2)^2} = 0$ by $x = \tan u$.

$$\frac{dx}{du} = \sec^2 u, \quad \frac{du}{dx} = \frac{1}{1+x^2}, \quad \frac{dy}{dx} = \frac{dy}{du} \cdot \frac{du}{dx},$$

$$\frac{d^2y}{dx^2} = \frac{d^2y}{du^2} \cdot \frac{du^2}{dx^2} + \frac{dy}{du} \cdot \frac{d^2u}{dx^2}.$$

The result is $\frac{d^2y}{du^2} + y = 0$.

6. Transform the linear differential equation

$$x^n \frac{d^n y}{dx^n} + C_1 x^{n-1} \frac{d^{n-1} y}{dx^{n-1}} + \dots + C_{n-1} x \frac{dy}{dx} + C_n y = 0 \text{ by } x = e^\theta.$$

$$\frac{dx}{d\theta} = e^\theta, \quad \frac{dy}{dx} = \frac{dy}{d\theta} \cdot \frac{d\theta}{dx} = \frac{dy}{d\theta} \cdot e^{-\theta}; \quad \frac{d^2y}{dx^2} = \left(\frac{d^2y}{d\theta^2} - \frac{dy}{d\theta} \right) e^{-2\theta}.$$

Hence $x \frac{dy}{dx} = \frac{dy}{d\theta}, \quad x^2 \frac{d^2y}{dx^2} = \frac{d^2y}{d\theta^2} - \frac{dy}{d\theta},$ etc.

This may be written symbolically,

$$\left(x \frac{d}{dx} \right) y = \frac{d}{d\theta} y, \quad \left(x^2 \frac{d^2}{dx^2} \right) y = \frac{d}{d\theta} \left(\frac{d}{d\theta} - 1 \right) y = D(D-1)y,$$

where **the operator** D means *derivation* as to θ .

Similarly,

$$\left(x^3 \frac{d^3}{dx^3} \right) y = D(D-1)(D-2)y = \frac{d^3y}{d\theta^3} - 3 \frac{d^2y}{d\theta^2} + 2 \frac{dy}{d\theta}; \text{ etc.}$$

Hence the original equation becomes linear with

constant coefficients. Carefully distinguish $x^n \frac{d^n}{dx^n}$ from $\left(x \frac{d}{dx}\right)^n$. The first operator directs us to derive n times and multiply the result by x^n , hence

$$\left(x^n \frac{d^n}{dx^n}\right)x^r = r(r-1)\dots(r-n+1)x^r;$$

but the second requires us to derive as to x , multiply the result by x , and then continue the process; hence $\left(x \frac{d}{dx}\right)^n x^r = r^n x^r$. Also $\left(x \frac{d}{dx}\right)^n y = \left(\frac{d}{d\theta}\right)^n y$, if $x = e^\theta$.

7. In Cartesian and polar coordinates show that

$$\frac{\partial x}{\partial r} = \frac{\partial r}{\partial x} = \cos \theta = \frac{x}{r} = \frac{x}{\sqrt{x^2 + y^2}},$$

$$\frac{\partial y}{\partial r} = \frac{\partial r}{\partial y} = \sin \theta = \frac{y}{r} = \frac{y}{\sqrt{x^2 + y^2}},$$

while

$$\frac{\partial x}{\partial \theta} = -r \sin \theta = -y, \quad \frac{\partial \theta}{\partial x} = -\frac{y}{x^2 + y^2} = -\frac{y}{r^2} = -\frac{\sin \theta}{r},$$

$$\frac{\partial y}{\partial \theta} = r \cos \theta = x, \quad \frac{\partial \theta}{\partial y} = \frac{x}{x^2 + y^2} = \frac{x}{r^2} = \frac{\cos \theta}{r}.$$

Now $\frac{\partial u}{\partial x} = \frac{\partial u}{\partial r} \cdot \frac{\partial r}{\partial x} + \frac{\partial u}{\partial \theta} \cdot \frac{\partial \theta}{\partial x} = \cos \theta \cdot \frac{\partial u}{\partial r} - \frac{\sin \theta}{r} \cdot \frac{\partial u}{\partial \theta}$.

Thus establish these equations of operators:

$$\frac{\partial}{\partial x} = \cos \theta \frac{\partial}{\partial r} - \frac{\sin \theta}{r} \frac{\partial}{\partial \theta}, \quad \frac{\partial}{\partial y} = \sin \theta \frac{\partial}{\partial r} + \frac{\cos \theta}{r} \frac{\partial}{\partial \theta}$$

$$r \frac{\partial}{\partial r} = x \frac{\partial}{\partial x} + y \frac{\partial}{\partial y}, \quad \frac{\partial}{\partial \theta} = x \frac{\partial}{\partial y} - y \frac{\partial}{\partial x}.$$

Also

$$\frac{\partial x}{\partial r} \cdot \frac{\partial r}{\partial x} = \frac{\partial y}{\partial \theta} \cdot \frac{\partial \theta}{\partial y} = \cos^2 \theta,$$

$$\frac{\partial x}{\partial \theta} \cdot \frac{\partial \theta}{\partial x} = \frac{\partial y}{\partial r} \cdot \frac{\partial r}{\partial y} = \sin^2 \theta$$

233. The Operator ∇^2 .—An extremely important partial differential expression is the sum of the pure second derivatives,

$$\frac{\partial^2 V}{\partial x^2} + \frac{\partial^2 V}{\partial y^2} \quad \text{and} \quad \frac{\partial^2 V}{\partial x^2} + \frac{\partial^2 V}{\partial y^2} + \frac{\partial^2 V}{\partial z^2},$$

and in practical applications it is often necessary to transform to polar and spherical coordinates. Now

$$\begin{aligned} \frac{\partial^2 V}{\partial x^2} &= \frac{\partial}{\partial x} \left(\frac{\partial V}{\partial x} \right) = \left(\cos \theta \frac{\partial}{\partial r} - \frac{\sin \theta}{r} \cdot \frac{\partial}{\partial \theta} \right) \left(\cos \theta \frac{\partial V}{\partial r} - \frac{\sin \theta}{r} \cdot \frac{\partial V}{\partial \theta} \right) \\ &= \cos \theta \frac{\partial}{\partial r} \left(\cos \theta \frac{\partial V}{\partial r} - \frac{\sin \theta}{r} \cdot \frac{\partial V}{\partial \theta} \right) \\ &\quad - \frac{\sin \theta}{r} \cdot \frac{\partial}{\partial \theta} \left(\cos \theta \frac{\partial V}{\partial r} - \frac{\sin \theta}{r} \cdot \frac{\partial V}{\partial \theta} \right) \\ &= \overline{\cos \theta^2} \frac{\partial^2 V}{\partial r^2} - \frac{2 \sin \theta \cos \theta}{r} \cdot \frac{\partial^2 V}{\partial r \partial \theta} + \frac{\overline{\sin \theta^2}}{r^2} \cdot \frac{\partial^2 V}{\partial \theta^2} \\ &\quad + \frac{\overline{\sin \theta^2}}{r} \cdot \frac{\partial V}{\partial r} + \frac{2 \sin \theta \cos \theta}{r^2} \cdot \frac{\partial V}{\partial \theta}. \end{aligned}$$

We exchange the notions of x and y by changing θ into its complement $\frac{\pi}{2} - \theta$; so we may get $\frac{\partial}{\partial y}$ and $\frac{\partial^2}{\partial y^2}$ at once from $\frac{\partial}{\partial x}$ and $\frac{\partial^2}{\partial x^2}$; or we may proceed as above.

Hence
$$\frac{\partial^2 V}{\partial x^2} + \frac{\partial^2 V}{\partial y^2} = \frac{\partial^2 V}{\partial r^2} + \frac{1}{r} \cdot \frac{\partial V}{\partial r} + \frac{1}{r^2} \cdot \frac{\partial^2 V}{\partial \theta^2}.$$

To transform the operator $\frac{\partial^2}{\partial x^2} + \frac{\partial^2}{\partial y^2} + \frac{\partial^2}{\partial z^2}$, commonly written ∇^2 , to spherical coordinates r (radius vector), θ (longitude), ϕ (polar distance), we first project r on Z -axis and XY -plane, whence

$$z = r \cos \phi, \quad \text{and (say)} \quad r' = r \sin \phi;$$

we then project this projection r' on X - and Y -axes,

$$x = r' \cos \theta, \quad y = r' \sin \theta.$$

We now pass by the formula just established from (x, y) to (r', θ) , we then add $\frac{\partial^2}{\partial z^2}$ and pass by the same formula from (z, r') to (r, ϕ) , then we substitute for $\frac{1}{r'} \frac{\partial V}{\partial r'}$ and $\frac{1}{r'^2}$, and so obtain

$$\nabla^2 V = \frac{\partial^2 V}{\partial r'^2} + \frac{2}{r'} \frac{\partial V}{\partial r'} + \frac{1}{r'^2} \frac{\partial^2 V}{\partial \phi^2} + \frac{\cot \phi}{r'^2} \frac{\partial V}{\partial \phi} + \frac{1}{r'^2 \sin^2 \phi} \frac{\partial^2 V}{\partial \theta^2}.$$

234. The Potential Function, so fundamental in higher physics, satisfies, according to the theorem of Laplace, generalized by Poisson, the equation,

$$\nabla^2 V = -4\pi\epsilon,$$

ϵ being the density at (x, y, z) . Hence the great significance of the operator ∇^2 . The coordinates, r', θ, z are called *cylindric*.

It is worth noting that the system of relations

$$x = r \cos \theta \sin \phi, \quad y = r \sin \theta \sin \phi, \quad z = r \cos \phi,$$

may readily be extended to four-dimensional space by projecting the radius vector on the fourth rectangular axis, say U , and on the XYZ space; if ψ be the angle of projection (on U) we have then at once,

$$x = r \cos \theta \cdot \sin \phi \cdot \sin \psi, \quad y = r \sin \theta \cdot \sin \phi \cdot \sin \psi,$$

$$z = r \cos \phi \cdot \sin \psi, \quad u = r \cos \psi,$$

and we may now transform the operator

$$\frac{\partial^2}{\partial x^2} + \frac{\partial^2}{\partial y^2} + \frac{\partial^2}{\partial z^2} + \frac{\partial^2}{\partial u^2}$$

to the coordinates (r, θ, ϕ, ψ) , and these results the student may generalize for space of n -dimensions.

235. Orthogonal Transformation.—If $O(X, Y, Z)$ and $O(U, V, W)$ be two sets of rectangular axes, the passage

from one to the other is called an **orthogonal transformation**. The formulae are

$$x = l_1 u + m_1 v + n_1 w, \quad y = l_2 u + m_2 v + n_2 w, \quad z = l_3 u + m_3 v + n_3 w,$$

where the l 's are the direction-cosines of U, V, W with respect to X , and so for the m 's and n 's; and these are connected by nine equations:

$$l_1^2 + l_2^2 + l_3^2 = 1, \text{ and so on; } \quad l_1^2 + m_1^2 + n_1^2 = 1, \text{ and so on;}$$

$$l_1 l_2 + m_1 m_2 + n_1 n_2 = 0, \text{ and so on.}$$

Now remembering these relations and that

$$\frac{\partial f}{\partial u} = \frac{\partial f}{\partial x} \cdot \frac{\partial x}{\partial u} + \frac{\partial f}{\partial y} \cdot \frac{\partial y}{\partial u} + \frac{\partial f}{\partial z} \cdot \frac{\partial z}{\partial u}, \quad \frac{\partial^2 f}{\partial u^2} = \frac{\partial}{\partial u} \left(\frac{\partial f}{\partial u} \right),$$

let the student show that

$$\frac{\partial^2 f}{\partial u^2} + \frac{\partial^2 f}{\partial v^2} + \frac{\partial^2 f}{\partial w^2} = \frac{\partial^2 f}{\partial x^2} + \frac{\partial^2 f}{\partial y^2} + \frac{\partial^2 f}{\partial z^2};$$

i.e., the operator ∇^2 is unaffected by orthogonal transformation.

EXERCISES.

1. If $x_1^2 + x_2^2 + \dots + x_n^2 = r^2$, $V = f(x_1, x_2, \dots, x_n)$, show that

$$x_1 \frac{\partial V}{\partial x_1} + x_2 \frac{\partial V}{\partial x_2} + \dots + x_n \frac{\partial V}{\partial x_n} = r \frac{\partial V}{\partial r}.$$

2. Show that $1/r \equiv 1/\sqrt{x^2 + y^2 + z^2}$ vanishes when operated upon by ∇^2 .

3. Similarly show that $\theta \equiv \tan^{-1} y/x$ vanishes when operated on by $\frac{\partial^2}{\partial x^2} + \frac{\partial^2}{\partial y^2}$.

4. Show that $\nabla^2 \log \tan \phi/2 = 0$ where $\tan \phi = x/z \cos \theta$.

5. If V be a function of $r = \sqrt{x^2 + y^2 + z^2}$ alone, prove

$$\nabla^2 V = V_{2r} + \frac{2}{r} V_r;$$

and generally for V a function of $r = \sqrt{x_1^2 + x_2^2 + \dots + x_n^2}$, prove $\nabla^2 V = V_{2r} + \frac{n-1}{r} V_r$.

6. Given $x = r \cos \theta$, $y = r \sin \theta$, $z = \log r$; show that

$$r(xD_x + yD_y)^2 u = rD_r(rD_r - 1)u = D_z(D_z - 1)u. \text{ (Art. 249)}$$

7. The Equation of Legendre is commonly written

$$\frac{d}{dx} \left\{ (1 - x^2) \frac{dP}{dx} \right\} + n(n+1)P = 0;$$

transform this by putting $x = \cos \theta$; also by $1 - x^2 = z^2$,

$$\text{and } x^2 - 1 = \frac{1}{4} \left(u - \frac{1}{u} \right)^2.$$

$$\text{Ans. } \frac{d}{d\theta} \left(\sin \theta \frac{dP}{d\theta} \right) + n(n+1) \cos \theta \cdot P = 0;$$

$$z(1 - z^2) \frac{d^2 P}{dz^2} + (1 - 2z^2) \frac{dP}{dz} + n(n+1)zP = 0;$$

$$u^2(1 - u^2) \frac{d^2 P}{du^2} - 2u^3 \frac{dP}{du} + n(n+1)(u^2 - 1) = 0.$$

Observe that $D_x = -D_\theta / \sin \theta$, $D_x = -D_z \cdot \frac{\sqrt{1 - z^2}}{z}$, and so on.

8. Show that if $x = e^\theta$, $y = e^\phi$, $z = e^\psi$, ... the formula

$$r(xD_x + yD_y + zD_z + \dots)^n u = \Delta(\Delta - 1)(\Delta - 2) \dots (\Delta - n + 1)u$$

still holds, but Δ must mean $D_\theta + D_\phi + D_\psi + \dots$.

Observe merely that $D_\theta = D_x \cdot x_\theta = e^\theta \cdot D_x = xD_x$, etc.

9. When can you change $aV_x + bV_y$ into AV_ξ or BV_η by turning axes about origin?

Remember $\xi = x \cos \alpha - y \sin \alpha$, $\eta = x \sin \alpha + y \cos \alpha$.

10. When can you similarly turn $aV_x + bV_y + cV_z$ into AV_ξ , or $BV_\eta + CV_\zeta$, etc.?

11. Show that by turning rectangular axes you may change

$$aV_{2x} + 2bV_{xy} + cV_{2y} \text{ into } AV_{2\xi} + BV_{2\eta}.$$

12. Extend 11 to space of 3, 4, ... n dimensions.

13. Transform

$$(D_x^2 + D_y^2)u + k^2u = 0 \text{ and } (D_x^2 + D_y^2 + D_z^2)u + k^2u = 0 = (\nabla^2 + k^2)u$$

to polar coordinates.

14. Transform $(x^2D_x^2 + y^2D_y^2)u$ by means of $\log x = \theta$, $\log y = \phi$.

Hint: We may write it $(\Delta^2 + \Delta - 2xyD_{xy}^2)u$ (Art. 250).

15. Similarly transform $(x^2D_x^2 + y^2D_y^2 + z^2D_z^2 + xD_x + yD_y + zD_z)u$.

ELIMINATION.

236. Systems of Curves.—We know that the equation of a curve in general contains certain *parameters* or *arbitrary constants*, the particular values of which distinguish one curve from another of the same *family* or *system*. Thus $x^2 + y^2 = r^2$ is the equation of a circle about the origin, of radius r . For any particular value of r , as 1 or 3, we get a particular circle; letting r range in value from 0 to ∞ we get the whole system or family of such circles about the origin. There is a simple infinity of such circles, or there are ∞^1 such circles. So too

$$\overline{x-a^2} + \overline{y-b^2} = r^2$$

is the equation of any circle in the XY -plane. Here there are three arbitraries, a, b, r ; by letting these range, r from 0 to ∞ , a and b from $-\infty$ to $+\infty$, we get all circles in the plane, no two the same. There are ∞^3 such circles, a triple infinity, an infinity of infinities of infinities. So there are ∞^2 straight lines in the plane, and ∞^5 conics.

237. Differential Equations.—If now we derive the equation $x^2 + y^2 = r^2$, of the system of circles about the origin, we get

$$x + yy_x = 0 \quad \text{or} \quad y_x = -\frac{x}{y}.$$

Hereby we *eliminate* the parameter r and obtain a *differential equation*, so called from the presence of the derivative or *differential coefficient*, y_x . This equation expresses a geometric property, namely, *the tangent at (x, y) is normal to the radius vector to (x, y)* —a property belonging to *all circles* about the origin and to *no other curves*. Hence this differential equation characterizes or defines the system of circles quite as precisely as the original finite equation $x^2 + y^2 = r^2$. The presence of the derivative y_x imparts the same generality to the differ-

ential equation that the presence of the arbitrary constant r imparts to the finite equation.

238. Systems of Rays.—The equation of the two-fold infinity of right lines in the plane is $y = sx + b$, whence

$$y_x = s, \quad y_{2x} = 0.$$

We observe that one derivation does not suffice to eliminate both parameters, s and b ; a second derivation is necessary. The result, $y_{2x} = 0$, is a differential equation of *second order*, since it contains a *second* derivative and none higher. It declares a geometric property, namely, that the *curvature*, $\kappa = \frac{y_{2x}}{(1 + y_x^2)^{\frac{3}{2}}}$, of all such lines is 0.

Moreover, if we retrace our steps, integrating this differential equation $y_{2x} = 0$ twice, we shall get $y = sx + b$, where s and b are quite arbitrary; *i.e.*, we shall get the original ∞^2 of right lines and *naught else*. This geometric property of 0-curvature at all points belongs in fact to *all right* lines and to *no other* lines. Hence the differential equation, $y_{2x} = 0$, expressing this property, *defines* the totality of right lines perfectly; the presence of the *second* derivative imparts exactly the same generality as the presence of *two* parameters.

239. Systems of Circles.—Once more, the equation of all circles in the plane is

$$(x - a)^2 + (y - b)^2 = r^2,$$

whence

$$x - a + (y - b)y_x = 0, \quad 1 + y_x^2 + (y - b)y_{2x} = 0,$$

whence

$$\frac{(1 + y_x^2)^3}{y_{2x}^2} = r^2.$$

This differential equation of second order declares that the radius of curvature in any circle is a constant, namely r , the radius of the circle; and retracing our steps by integration we show (Art. 168) that this property charac-

terizes circles only, it may be taken as definition of circle. But the differential equation still contains an arbitrary r , to remove which we again derive, obtaining

$$y_x - \frac{(1 + y_x^2)y_{3x}}{y_{2x}^2} = 0.$$

This expression is the tangent of the angle, called "deviation" (Trançon) or "aberrancy of curvature" (Salmon), between the normal at $P(x, y)$ and the medial PM of the infinitesimal chord normal to this normal; this angle, and hence its tangent, vanishes (as we know) for all points of all circles, but for *no other* curves. Retracing our steps by integration we shall get the original equation. Hence this property, and the differential equation expressing this property, may be taken as definition of the totality of circles, ∞^3 , in the plane XY . The presence of the *third* derivative imparts the same generality as the presence of *three* arbitrary constants.

240. Generalization.—We may now see that if we derive n times any equation,

$$F(x, y, c_1, c_2, \dots, c_n) = 0,$$

containing n constants or parameters, c_1, \dots, c_n , we shall get n equations, $F' = 0, F'' = 0, \dots, F^{(n)} = 0$, and by combining these with the original $F = 0$ we obtain $(n+1)$ equations, from which we may eliminate the n c 's and obtain a differential equation of n^{th} order (since it contains an n^{th} derivative), the equivalent of the original $F = 0$ with n parameters. By some analytic device we may eliminate all the c 's at one stroke, or we may eliminate them one by one, and in this or that order. The question arises, will all of these methods and orders lead indifferently to the same differential equation as result? So, too, we may retrace our steps by the most diverse paths, and the question comes up, will all of these paths lead to one and the same primitive finite equation? Both

these questions are to be answered affirmatively, as already illustrated; but adequate discussion is too abstruse and difficult for this stage of our study. It is to be observed that the *primitive* (so-called) obtains its high generality through the presence of the n arbitraries, whereas the differential equation obtains equal generality through its order, the n^{th} , whereby it expresses some intrinsic property of all such curves and of no others, and so defines them perfectly. The doctrine of differential equations is the most profound and far-reaching of mathematical disciplines.

The expression, equated to zero, yielded by elimination of the constants we may call the *eliminant* of the primitive. In case this latter be a complete rational algebraic function of x and y , this eliminant will be a *reciprocant*; for it must be indifferent whether we derive as to x or as to y .

241. Illustrations and Exercises.—1. Show that the eliminant of the hyperbola $xy+ax+by+c=0$ is the *Schwartzian* $2y_x y_{3x} - 3y_{2x}^2 = 0$, and show that this is a reciprocant. We have

$$\begin{aligned} y + xy_x + a + by_x &= 0, & 2y_x + (x+b)y_{2x} &= 0, \\ & & 3y_{2x} + (x+b)y_{3x} &= 0, \end{aligned}$$

whence the Schwartzian on eliminating $x+b$. Passing from x to y as argument (Art. 222), or deriving as to y and eliminating, we see that the eliminant is a reciprocant.

2. Find the eliminant of the most general parabola $(ax+by)^2+2cx+2dy+1=0$, and prove it a reciprocant.

3. Show that the eliminant of the general conic

$$kx^2 + 2hxy + jy^2 + 2gx + 2fy + c = 0$$

is the *Mongian*

$$9y_{2x}^2 y_{5x} - 45y_{2x} y_{3x} y_{4x} + 40y_{3x}^3 = 0,$$

and show that it is a reciprocant. Three derivations

remove c, g, k ; deriving this last result twice we get three equations homogeneous in h, j, f ; put the determinant of the coefficients of h, g, f equal to 0; reduce it, and the equation discovered by Monge results.

242. New Functions.—We have already learned that transcendental functions may be removed by simple derivation. Thus if

$$y = \log x, \quad y = \sin^{-1}x, \quad y = \text{hs}^{-1}x,$$

then
$$y_x = \frac{1}{x}, \quad y_x^2 = \frac{1}{(1-x^2)}, \quad y_x^2 = \frac{1}{(1+x^2)}.$$

The real significance of these results lies in the fact that when we attempt to pass back from the differential equation to an equivalent finite equation we are compelled to *introduce* these transcendental functions *even though we may never have heard of them before*. What names or symbols we shall use for them is of course arbitrary, but their properties all lie in the differential equation that requires them for its integration. Thus it appears that the solution or integration of differential equations may give rise to countless new functions, of which the differential equations may themselves be regarded as *definitions*.

243. Illustrations and Exercises.—1. Eliminate the transcendentals from $y = e^x \cos x$. We have

$$y_x = y - e^x \sin x, \quad y_{2x} = y_x - y - e^x \sin x = 2y_x - 2y.$$

2. Free $y = \sin \frac{y}{x}$ from transcendentals. We have

$$y = x \sin^{-1}y, \quad y' = \frac{y}{x} + \frac{xy'}{\sqrt{1-y^2}}, \quad x^2 y' = \sqrt{1-y^2}(xy' - y).$$

3. Remove transcendentals and the independent θ from the equations of the cycloid

$$x = a(\theta - \sin \theta), \quad y = a(1 - \cos \theta).$$

$$\frac{dx}{d\theta} = a(1 - \cos \theta) = y, \quad \frac{dy}{d\theta} = a \sin \theta, \quad \frac{dy}{dx} = \frac{\sin \theta}{1 - \cos \theta} = \frac{a \sin \theta}{y},$$

$$\frac{y^2 \left(\frac{dy}{dx}\right)^2}{a^2} + \frac{(a-y)^2}{a^2} = 1, \quad \text{or} \quad yx^2 - \frac{2a}{y} + 1 = 0.$$

Of course we can eliminate θ without derivation, but the result would contain a transcendental.

4. Remove the independent t from the relations

$$\frac{d^2x}{dt^2} = X, \quad \frac{d^2y}{dt^2} = Y,$$

when X and Y are functions of x and y , but not of t . We have (Art. 221)

$$y_{2x} = \frac{y_{2t} \cdot x_t - y_t \cdot x_{2t}}{(x_t)^3} = \frac{Y - y_x \cdot X}{(x_t)^2};$$

$$\text{hence } (x_t)^2 = \frac{Y - X y_x}{y_{2x}}; \quad 2x_t \cdot x_{2t} \cdot t_x = 2X = \frac{d}{dx} \left(\frac{Y - X y_x}{y_{2x}} \right).$$

5. Eliminate a from $(x+y)(a + \log y) - ye^{\frac{x}{y}}$.

$$\text{Ans. } xy = y_x(x^2 + (x+y)^2 e^{-\frac{x}{y}}).$$

6. Eliminate k, h, j from $kx^2 + 2hxy + jy^2 = 1$.

$$\text{Ans. } y_{3x}(xy_x - y) = 3xy_{2x}.$$

7. Eliminate constants and exponentials from

$$ae^x + be^{-x} = a'e^y + b'e^{-y}.$$

$$\text{Ans. } (y_{3x} + y_x^3 - y_x)(1 - y_x^2) + 3y_x y_{2x}^2 = 0.$$

8. Eliminate a from $x = ae^{-y} + y - 1$.

9. Eliminate a from $x + y = \tan(y - a)$.

10. Eliminate c from $y^2 = 2cx + c^3$.

11. Eliminate a and b from $y + b = hc(x - a)$.

12. Eliminate a and b from $\log y = ae^x + be^{-x}$.

$$\text{Ans. } yy_{2x} - y_x^2 = y^2 \log y.$$

13. Eliminate a and b from $\log y = (x+a)/(x+b)$.

14. Eliminate a and b from $y = x \left(a - \sin^{-1} \frac{b}{x} \right)$.

244. Elimination of Functions.—As ordinary derivation with respect to one argument serves to eliminate arbitrary *constants* and *transcendentals*, so partial derivation as to more than one independent argument may serve to eliminate arbitrary *functions*. Thus, let $az = +a\phi(ay - bx)$, x and y being independent; then

$$a \frac{\partial z}{\partial x} = -a\phi'(ay - bx)b, \quad a \frac{\partial z}{\partial y} = a\phi'(ay - bx)a;$$

whence
$$a \frac{\partial z}{\partial x} + b \frac{\partial z}{\partial y} = 0.$$

If now, by appropriate methods not here treated, we pass back from this result, a *partial differential equation*, we shall find that the equivalent finite relation involves an arbitrary function of $ay - bx$, such as above is denoted by ϕ , and has been eliminated. Geometric illustration is possible, but shall not here be attempted.

245. A second derivation will suffice for the elimination of a second arbitrary function. Thus,

$$z = x\phi(ax^2 + by^2) + y\psi(ax^2 + by^2),$$

to eliminate ϕ and ψ .

$$z_x = \phi + 2ax(x\phi' + y\psi'), \quad z_y = \psi + 2by(x\phi' + y\psi');$$

$$axz_y - byz_x = ax\psi - by\phi;$$

whence

$$az_y + axz_{yx} - byz_{xx} = a\psi + 2ax(ax\psi' - by\phi');$$

$$-bz_x - byz_{xy} + axz_{yy} = -b\phi + 2by(ax\psi' - by\phi');$$

$$a^2x^2z_{yy} - 2abxyz_{xy} + b^2y^2z_{xx} - ab(axz_x + yz_y) + z = 0,$$

or
$$\left\{ \left(ax \frac{\partial}{\partial y} - by \frac{\partial}{\partial x} \right)^2 - ab \left(x \frac{\partial}{\partial x} + y \frac{\partial}{\partial y} \right) + 1 \right\} z = 0.$$

246. Functions of Functions.—Suppose now we would eliminate a function of a function, as ϕ in $\phi\left(\frac{x^a}{u^d}, \frac{y^b}{u^d}\right) = 0$.

We have, putting $x^a/u^d = \alpha$, $y^b/u^d = \beta$,



$$\phi_x = \phi_a \cdot a_x + \phi_\beta \cdot \beta_x = \phi_a \cdot \frac{a}{x} \cdot a - \phi_a \cdot \frac{d}{u} \cdot a \cdot u_x - \phi_\beta \cdot \frac{d}{u} \cdot \beta \cdot u_x$$

or
$$\frac{u}{d} \cdot a \cdot \phi_a = \frac{x}{a} \cdot a \cdot \phi_a \cdot u_x + \frac{x}{a} \cdot \beta \cdot \phi_\beta \cdot u_x.$$

Similarly
$$\frac{u}{d} \cdot \beta \cdot \phi_\beta = \frac{y}{b} \cdot a \cdot \phi_a \cdot u_y + \frac{y}{b} \cdot \phi_\beta \cdot \beta \cdot u_y;$$

whence on adding and rejecting the common factor, we get

$$\frac{u}{d} = \frac{x}{a} \cdot u_x + \frac{y}{b} \cdot u_y.$$

Let the student extend this result to the case of three independents, x, y, z , and then to n independents, x_1, \dots, x_n .

247. Functions of two Functions.—Let us consider a function of two arbitrary functions of different functions of the independents, as

$$z = \phi(xy) \cdot \psi\left(\frac{y}{x}\right).$$

$$z_x = y\phi' \cdot \psi - \frac{y}{x^2} \cdot \phi \cdot \psi', \quad z_y = x \cdot \phi' \cdot \psi + \frac{1}{x} \cdot \phi \cdot \psi'.$$

Hence we form the two simpler equations

$$xz_x + yz_y = 2xy\phi'\psi, \quad x(yz_y - xz_x) = 2y\phi\psi'.$$

By deriving these we get four more equations and introduce two more unknowns ϕ'' and ψ'' ; we shall then have seven equations whence we may eliminate the six unknowns, $\phi, \psi, \phi', \psi', \phi'', \psi''$.

$$z_x + xz_{xx} + yz_{xy} = 2y\phi'\psi + 2xy^2\phi''\psi - \frac{2y^2}{x} \cdot \phi'\psi',$$

$$z_y + yz_{yy} + xz_{xy} = 2x\phi'\psi + 2x^2y\phi''\psi + 2y\phi'\psi',$$

$$-z_x - xz_{xx} + yz_{xy} = -2\frac{y}{x^2}\phi\psi' - 2\frac{y^2}{x^3}\phi\psi'' + \frac{2y^2}{x} \cdot \phi'\psi',$$

$$z_y + yz_{yy} - xz_{xy} = \frac{2}{x}\phi\psi' + \frac{2y}{x^2}\phi\psi'' + 2y\phi'\psi';$$

$$yz_y - xz_x + y^2z_{yy} - x^2z_{xx} = 4y^2\phi'\psi',$$

$$(yz_y + xz_x)(yz_y - xz_x) = 4y^2\phi'\psi'\phi\psi = 4y^2z\phi'\psi';$$

hence finally,

$$x^2z_x^2 - y^2z_y^2 = (x^2z_{xx} - y^2z_{yy} + xz_x - yz_y)z.$$

The second pair of derivations immediately above are seen to be unnecessary. They yield on combination the same result as the first pair, but such need not always be the case. In general, the order of derivation that produces sufficient equations to effect the elimination will produce more than sufficient; we shall then have several choices of eliminations, each leading to a partial differential equation; or rather we shall have a set of eliminants, partial differential equations, the equivalent of the original equation containing the arbitrary functions. It would be out of place to enter here more deeply into this matter. The foregoing examples sufficiently illustrate the methods to be followed.

248. A very important example of the elimination of arbitrary functions is presented in Euler's **Theorems on Homogeneous Functions**. The peculiarity of such a function of any number of arguments, x, y, z , etc., is that the sum of the exponents of the arguments in each term is the same, namely, n , the degree of the function itself. Hence if u or H_n be such a function we have $u = H_n = \sum Cx^a y^b z^c \dots$, where $a + b + c + \dots = n$. Hence if we take out x^n there can remain only expressions of *zeroth* degree in x, y, z, \dots , that is, only quotients $\frac{y}{x}, \frac{z}{x}, \dots$; hence we have $u = H_n = x^n \phi\left(\frac{y}{x}, \frac{z}{x}, \dots\right)$.

From this equation we may now eliminate ϕ . For if we operate on any term $Cx^a y^b z^c \dots$ with $x \frac{\partial}{\partial x}$, that is, derive as to x and multiply by x , we reproduce that term multiplied by the exponent of x , as a ; hence if we operate on any term with

$$\dots \left(x \frac{\partial}{\partial x} + y \frac{\partial}{\partial y} + z \frac{\partial}{\partial z} + \dots \right),$$

we shall reproduce that term multiplied by the sum of the exponents, that is, by n ; hence operating on u , the sum of such terms, with the same operator we shall reproduce u multiplied by n , that is,

$$\left(x\frac{\partial}{\partial x} + y\frac{\partial}{\partial y} + z\frac{\partial}{\partial z}\right)u = nu,$$

the first of *Euler's Theorems*, and hereby ϕ is eliminated.

249. General Proof.—If each of the arguments x, y, z, \dots be multiplied by the same multiplier μ , then this μ will be introduced into each term with the same exponent n , the sum of the exponents of x, y, z, \dots ; hence u will be multiplied by μ^n . Such would plainly not be the case unless the sum of exponents were in each term the same, n . Hence this important property may serve as *definition* of homogeneous function of n^{th} degree in x, y, z, \dots . Putting $\mu = 1 + t$ we have

$$H_n(x + xt, y + yt, z + zt, \dots) = (1 + t)^n H_n(x, y, z, \dots).$$

This equation implies the main properties of such homogeneous functions. For we may expand the left side by Taylor's theorem (Art. 211) in the vicinity of (x, y, z, \dots) , and the right side by the Binomial theorem; equating then the coefficients of like powers of t , we shall get

Euler's theorems :

$$x\frac{\partial u}{\partial x} + y\frac{\partial u}{\partial y} + \dots = nu;$$

$$x^2\frac{\partial^2 u}{\partial x^2} + 2xy\frac{\partial^2 u}{\partial x \partial y} + \frac{\partial^2 u}{\partial y^2} + \dots = n(n-1)u;$$

$$x^3\frac{\partial^3 u}{\partial x^3} + 3x^2y\frac{\partial^3 u}{\partial x^2 \partial y} + 3xy^2\frac{\partial^3 u}{\partial x \partial y^2} + y^3\frac{\partial^3 u}{\partial y^3} + \dots = n(n-1)(n-2)u;$$

etc.

We may write these operators on u thus :

$$\left(x\frac{\partial}{\partial x} + y\frac{\partial}{\partial y} + \dots\right), \quad \left(x\frac{\partial}{\partial x} + y\frac{\partial}{\partial y} + \dots\right)^2,$$

and so on, where the subscribed h reminds us to take only the *homogeneous* terms of *highest* degree. For instance,

$$\left(x \frac{\partial}{\partial x} + y \frac{\partial}{\partial y}\right)^2 u = x^2 \frac{\partial^2 u}{\partial x^2} + 2xy \frac{\partial^2 u}{\partial x \partial y} + y^2 \frac{\partial^2 u}{\partial y^2},$$

and does *not* equal

$$\left(x \frac{\partial}{\partial x} + y \frac{\partial}{\partial y}\right) \left(x \frac{\partial}{\partial x} + y \frac{\partial}{\partial y}\right) u,$$

for this latter equals

$$x^2 \frac{\partial^2 u}{\partial x^2} + 2xy \frac{\partial^2 u}{\partial x \partial y} + y^2 \frac{\partial^2 u}{\partial y^2} + \left(x \frac{\partial u}{\partial x} + y \frac{\partial u}{\partial y}\right).$$

Now this latter $() = nu$; hence

$$\left(x \frac{\partial}{\partial x} + y \frac{\partial}{\partial y} + \dots\right) \left(x \frac{\partial}{\partial x} + y \frac{\partial}{\partial y} + \dots\right) = \left(x \frac{\partial}{\partial x} + y \frac{\partial}{\partial y} + \dots\right)^2 = n^2 u,$$

so that the operator $\left(x \frac{\partial}{\partial x} + \dots\right)$ or $(xD_x + \dots)$ is equivalent to the multiplier n , and is plainly the natural generalization of the operator (xD) of Art. 75. Write it Δ .

250. Relation of ${}_h\Delta^n$ and Δ^n .—We have found (Art. 76) that $x^n D^n = xD(xD-1)(xD-2)\dots(xD-n+1)$; does any like relation hold for this Δ , the generalization of xD ? Write ${}_h\Delta^n$ for $\{x^n D_x^n + C_{n,1} x^{n-1} D_x^{n-1} D_y \dots\}$, the *homogeneous* result of expanding ${}_h(xD_x + yD_y + \dots)^n$ according to the Multinomial Theorem; also write Δ^n for

$$(xD_x + yD_y + \dots)^n,$$

the operation Δ repeated n times. Then we have ${}_h\Delta^1 = \Delta^1$, and we have just seen (in case of two independents, x and y , and the proof holds plainly for any number) that $\Delta^2 = {}_h\Delta^2 + \Delta$, or ${}_h\Delta^2 = \Delta(\Delta-1)$. This reminds us of $x^2 D^2 = xD(xD-1)$, and leads us to suspect there holds the corresponding general relation:

$${}_h\Delta^n = \Delta(\Delta-1)(\Delta-2)\dots(\Delta-n+1).$$

To test this we assume the relation for the index n , and inquire whether it holds then for $n+1$. Now we readily prove that $\Delta({}_h\Delta^n) = {}_h\Delta^{n+1} + n{}_h\Delta^n$.

For suppose ${}_h\Delta^n$ expanded by the Multinomial Theorem and operate on it with Δ . All terms in the result that involve derivatives of $(n+1)^{\text{th}}$ order, as

$$\frac{\partial^{n+1}}{\partial x^a \partial y^b \dots} \text{ (or } D_x^a D_y^b \dots \text{),}$$

where $a+b+\dots=n+1$, must come from terms in ${}_h\Delta^n$ by applying derivation to factors that are themselves derivatives (all of n^{th} order), as $\frac{\partial^n}{\partial x^{a-1} \partial y^b \dots}$ or $\frac{\partial^n}{\partial x^a \partial y^{b-1} \dots}$, and the total numeral coefficient C of this resulting type-term will be the sum of the numeral coefficients c_x, c_y, \dots of these contributory terms; moreover, the exponents of x, y, \dots will each in turn be increased by 1 as we operate (on the derivative factors) with $x D_x, y D_y, \dots$; the same set of indices will result from each of these contributory terms, and the total resultant term will be

$$C x^a y^b \dots \frac{\partial^{n+1}}{\partial x^a \partial y^b \dots}$$

But this C , for each such resultant term, is obtained in precisely the same way, as the sum of precisely the same c 's in multiplying the n^{th} power of the multinomial $(x D_x + y D_y + \dots)$ by the multinomial itself; hence the result thus far is of the same form as in the ordinary multinomial expansion, and we obtain ${}_h\Delta^{n+1}$ as the result of operating with Δ on the derivatives in ${}_h\Delta^n$. The rest of the complete result is obtained by operating with Δ on the powers of x, y, \dots , in ${}_h\Delta^n$; but in this operation the derivatives count as constant factors only, and the whole expression ${}_h\Delta^n$ is homogeneous of n^{th} degree in x, y, \dots ; hence the theorem for Δ operating on such quantics applies, namely, the operator Δ is equivalent to

the multiplier n ; hence this part of the result is $n_h\Delta^n$; that is,

$$\Delta({}_h\Delta^n) = {}_h\Delta^{n+1} + n_h\Delta^n.$$

Hence

$${}_h\Delta^{n+1} = {}_h\Delta^n(\Delta - n).$$

That is, if ${}_h\Delta^n = \Delta(\Delta - 1)(\Delta - 2)\dots(\Delta - n + 1)$,

then ${}_h\Delta^{n+1} = \Delta(\Delta - 1)(\Delta - 2)\dots(\Delta - n + 1)(\Delta - n)$.

The relation is known to hold for $n=2$, hence it holds for $n=3$, etc.

If now the operand u be *homogeneous* of m^{th} degree in x, y, \dots , we may put m for Δ , and hence obtain

$${}_h\Delta^{n+1}u = m(m-1)(m-2)\dots(m-n)u,$$

which is Euler's *General Theorem for Quantics*.

Equations non-homogeneous in coordinates x, y may be made homogeneous by supplanting these with the ratios $\frac{x}{z}, \frac{y}{z}$ and then multiplying by the highest power, z^n , of z ; x, y, z may then be treated as **triangular**, *trilinear*, or **homogeneous** coordinates, which reduce to ordinary Cartesian for $z=1$.

Similarly for x, y, z supplanted with $\frac{x}{u}, \frac{y}{u}, \frac{z}{u}$, where x, y, z, u may be *tetrahedral* or *quadriplanar* coordinates, and so on for higher spaces.

EXERCISES.

1. Eliminate functions from $y = \cos \log x, y = \log \cos x, y = \log \tan x, y = \tan \log x, y = \sin^{-1} \log x, y = \log \sin^{-1} x$.

Ans. $x^2y'' + xy' + y = 0, y'' - y'^2 - 1 = 0, y''^2 + 4y'^2 - y'^4 = 0$, etc.

2. Eliminate functions and constants A, B , from

$$y = Ae^{c \sin^{-1} x} + Be^{c \cos^{-1} x}.$$

Ans. $\{(1 - x^2)D^2 - xD - c^2\}y = 0$.

3. Eliminate constants and log from $y = (a + b \log x + \sqrt{\log x^2})x^2$.

$$\text{Ans. } (x^2 D^2 - 3x D + 4)y = 2x^2.$$

4. Eliminate functions from $z = x \sin^{-1} \frac{y}{x} + \phi(x)$.

$$\text{Ans. } z_y \cdot \sqrt{x^2 - y^2} = x.$$

5. If $\left(\frac{1}{z} - \frac{1}{y}\right) = \phi\left(\frac{1}{x} - \frac{1}{y}\right)$, prove $x^2 D_x z + y^2 D_y z = z^2$.

6. If u be the sum of two homogeneous functions of x and y , of m^{th} and n^{th} degrees, prove

$$\{x \Delta^2 - (m + n - 1) \Delta + mn\} u = 0.$$

7. Extend (6) to the sum of three quantities in x and y , and then to the sum of r such quantities, of degrees n_1, n_2, \dots, n_r .

$$\text{Ans. } \left| \begin{array}{c} \dots\dots\dots \\ \Delta^p u, n_1^p, n_2^p, \dots, n_r^p \\ \dots\dots\dots \\ \dots\dots\dots \end{array} \right| = 0, p \text{ ranging from } 0 \text{ to } r.$$

8. Eliminate ϕ and ψ from $u = \phi[x + \psi(y)]$.

$$\text{Ans. } D_x u \cdot D_{xy} u = D_y u \cdot D_{xx} u.$$

9. If $\phi(u^2 - x^2) = 0$, then plainly $\frac{u_x}{x} = \frac{1}{u}$; generalize this result

$$\text{for } \phi(u^2 - x^2, u^2 - y^2, \dots) = 0. \quad \text{Ans. } \frac{u_x}{x} + \frac{u_y}{y} + \dots = \frac{1}{u}.$$

10. If $\phi\{s(u-x)\} = 0$, when $s = u + x$, then plainly $u \cdot u_x = x$, or $(s-x)u_x = s-u$; similarly, if $\phi\{s^{\frac{1}{n}}(u-x), s^{\frac{1}{n}}(u-y)\} = 0$, then $(s-x)u_x + (s-y)u_y = s-u$; generalize this result, showing that if $\phi\{s^{\frac{1}{n}}(u-x_1), s^{\frac{1}{n}}(u-x_2), \dots, s^{\frac{1}{n}}(u-x_n)\} = 0$, then $\Sigma(s-x)u_x = s-u$, where $s = u + \Sigma x$.

CHAPTER VII.

PARTIAL INTEGRATION.

251. Partial derivation, or differentiation, as commonly called, implies as its inverse, **Partial Integration**. This latter implies at least *two* independent arguments, and is entirely distinct from *integration by parts* as well as from repeated integration as to the same argument, both of which processes involve but one argument. The simplest example of this process is afforded by the attempt to evaluate the area of a plane surface bounded

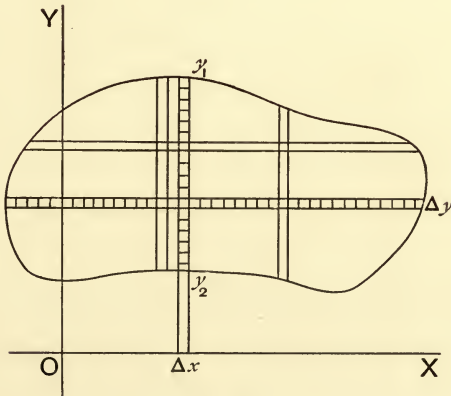

FIG. 41.

by curves. We cut it up into small rectangles or *elements of surface*, each of which we designate by ΔS , distinguishing them when necessary, as is rare, by subscripts, $\Delta_1 S$, $\Delta_2 S$, ... so that to find the total area we shall have

to form the sum $\Sigma\Delta S$, and take the limit of this sum $\int dS$, so that $A = \int dS$.

Actually to carry out this summation, or this single total integration as such, would not in general be feasible, however. Accordingly, we suppose the surface to be crossed by a double system of parallels to Y and X , Δx and Δy apart. The area of surface-element is then $\Delta S = \Delta x \cdot \Delta y$, and the summation $\Sigma\Delta S$ becomes $\Sigma(\Delta x \cdot \Delta y)$. In performing the process last indicated, we first sum all the elementary rectangles in one strip (say) parallel to Y . In this process Δx is constant and may be placed outside the summatorial, thus, $\Delta x \Sigma \Delta y$. This latter expression denotes now a partial summation, namely, with respect to y , x and Δx being constants throughout the length of the strip. To complete the summation we must sum all such strips, that is, we must sum with respect to x and form the expression $\Sigma(\Delta x \Sigma \Delta y)$. If now we seek the limits of these expressions, we shall get for the first a strip parallel to Y , $\Delta x \int dy$, or $\Delta x(y_1 - y_2)$, where y_1 and y_2 are the values of y at the upper and lower ends of the strip, and these y 's may be expressed through x , if we know the bounding curve or its equation. The second limit, namely, of the complete double summation, may now be written

$$\int(dx \int dy), \text{ or } \int dx(y_1 - y_2), \text{ or } \int(y_1 - y_2)dx,$$

and means the *limit* of the *sum* of all such strips parallel to Y . This latter form, $\int(y_1 - y_2)dx$, is nothing but our familiar quadrature integral, $\int y dx$, extended to the case where the lower boundary is not the X -axis. This second integration can in general be performed when $y_1 - y_2$ is expressed through x . The first integration is properly termed **partial**, for in it x is constant, the integration

being parallel to Y , and y alone varies, ranging from y_2 to y_1 . The second integration as to x has nothing peculiar about it, but is precisely such as we have heretofore been executing. The double integral may be written $\int(dx\int dy)$, but the form $\int(\int dy)dx$ or $\iint dydx$ is more common. In this latter there is no instruction as to the *order* in which the integrations are to be performed, and it is geometrically evident that the order is indifferent: we may sum for a strip parallel to X , obtaining $\Delta y \Sigma \Delta x$ or $\Delta y \int dx$, and then sum all such strips, obtaining

$$\Sigma\{\Delta y(\Sigma \Delta x)\} \text{ or } \int(dy\int dx);$$

and this result is nothing but the whole area, as before.

252. Integration of $f(x, y)$.—But now let us suppose that some function of x and y , as $z=f(x, y)$, is attached to each point in this bounded surface—the value of z may of course be depicted geometrically by a length erected at (x, y) normal to the plane of XY . As before we cut up the surface into elements ΔS , and form the summation $\Sigma z \Delta S$, and take its limit $\int z dS$. The extremes of this integration are not two values of S , or two points (x, y) , as in simple quadrature, but the whole line of values or points (x, y) along the bounding curve; the integral is no longer a **line-integral**, extended along a line, as x -axis, but is a **surface-integral**, extended over the whole bounded surface. As before, we sum (resp. integrate) at first *partially* along a strip parallel (say) to Y , thereby keeping x constant, and then sum (resp. integrate) all such strips. We symbolize these operations thus:

$$\Sigma \Sigma z \Delta x \Delta y, \quad \iint z dx dy.$$

But the question arises: does the summation $\Sigma z \Delta S$ always approach the *same* limit, $\int z dS$, no matter how the surface S be cut up into bits, nor in what order they be summed? Let us consider the case of z , a *finite, unique, continuous* function both of x and of y throughout the surface or domain of integration, itself *wholly in finity*. Then plainly the integral $\int z dS$ is represented geometrically by the volume whose base is S , whose top is the surface $z=f(x, y)$, whose side is the cylinder formed by the z 's along the border of S . Since this volume is one and the same, and is yielded however we cut up S and in whatever order we sum, it follows that the integral $\int z dS$ is likewise unique. A purely analytic investigation that shall take a wider range, dropping some of the foregoing conditions, is reserved for the present.

Illustration.—Find the volume of the ellipsoid $\frac{x^2}{a^2} + \frac{y^2}{b^2} + \frac{z^2}{c^2} = 1$. The three coordinate planes cut the ellipsoid into eight congruent (resp. symmetric) octants, so it will suffice to integrate z over one quadrant of the ellipse $\frac{x^2}{a^2} + \frac{y^2}{b^2} = 1$. Hence

$$\begin{aligned} V &= 8 \int z dS = 8c \int_0^a dx \int_0^{b\sqrt{a^2-x^2}} \sqrt{1 - \frac{x^2}{a^2} - \frac{y^2}{b^2}} dy \\ &= \frac{8c}{a^2 b} \int_0^a dx \int_0^{b\sqrt{a^2-x^2}} \sqrt{b^2(a^2-x^2) - a^2 y^2} d(ay) \\ &= \frac{8c}{a^2 b} \int_0^a dx \cdot \frac{1}{2} \left\{ ay \sqrt{b^2(a^2-x^2) - a^2 y^2} + b^2(a^2-x^2) \sin^{-1} \frac{ay}{b\sqrt{a^2-x^2}} \right\}_0^{b\sqrt{a^2-x^2}} \\ &= \frac{2\pi bc}{a} \int_0^a (a^2-x^2) dx = \frac{4}{3} \pi abc, \end{aligned}$$

the ellipsoid is the geometric mean of the three spheres on its

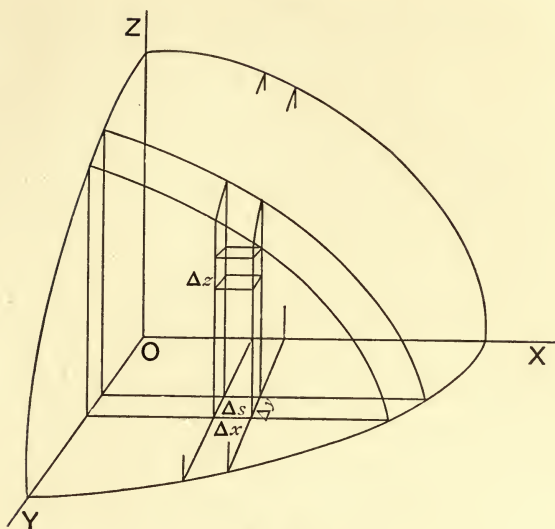

FIG. 42.

three axes as diameters, their volumes being $\frac{4}{3}\pi a^3$, $\frac{4}{3}\pi b^3$, $\frac{4}{3}\pi c^3$. We may think of the ellipsoid as a *strained sphere*, produced by compressing the sphere along two conjugate diameters, in the ratios $\frac{b}{a}$ and $\frac{c}{a}$.

253. Theorem of Mean Value.—By reasoning precisely like that in Art. 84, we show that if

$$f(x, y) = \phi(x, y) \cdot \psi(x, y),$$

where ϕ and ψ , and therefore f are integrable throughout S , and if ψ does not change sign anywhere in S , then

$$\begin{aligned} \int \phi(x, y) \psi(x, y) dS &= \phi(x, y)_m \cdot \int \psi(x, y) dS \\ &= (l + \theta(G - l)) \int \psi(x, y) dS, \end{aligned}$$

where l and G are the least and the greatest values of ϕ in S , and $0 \leq \theta \leq 1$.

254. Derivation as to Extremes.—The double integral

$$\int_a^{\alpha} \int_b^{\beta} f(x, y) dx dy$$

is clearly a function of the integrand f and of the independent extremes of integration a, b and α, β ; where it must be noted, as already shown in the preceding illustration, that, if we integrate first as to y and then as to x , the extremes of y -integration will be functions of x , but the extremes of x -integration will be constants; similarly, if we exchange x and y . It is also a *continuous* function of these extremes and may in general be derived with respect to them, as may thus be shown.

$$I(a, \beta) = \int_a^{\alpha} \int_b^{\beta} f(x, y) dx dy,$$

$$I(a + \Delta a, \beta + \Delta \beta) = \int_a^{\alpha + \Delta a} \int_b^{\beta + \Delta \beta} f(x, y) dx dy = I + \Delta I;$$

$$\begin{aligned} \Delta I &= I(a + \Delta a, \beta + \Delta \beta) - I(a, \beta) \\ &= \int_a^{\alpha + \Delta a} \int_b^{\beta + \Delta \beta} z dx dy - \int_a^{\alpha} \int_b^{\beta} z dx dy \\ &= \int_a^{\alpha + \Delta a} \int_b^{\beta + \Delta \beta} z dx dy - \int_a^{\alpha} \int_b^{\beta + \Delta \beta} z dx dy \\ &\quad + \int_a^{\alpha} \int_b^{\beta + \Delta \beta} z dx dy - \int_a^{\alpha} \int_b^{\beta} z dx dy \\ &= \int_a^{\alpha + \Delta a} \int_b^{\beta + \Delta \beta} z dx dy + \int_a^{\alpha} \int_b^{\beta + \Delta \beta} z dx dy \\ &= \int_a^{\alpha + \Delta a} \int_b^{\beta + \Delta \beta} z dx dy + \int_b^{\beta + \Delta \beta} \int_a^{\alpha} z dx dy = A \cdot \Delta a + B \cdot \Delta \beta \end{aligned}$$

where B and A are mean values of

$$\int_a^{\alpha} z dx \quad \text{and} \quad \int_b^{\beta + \Delta \beta} z dy$$

these being finite, and Δa , $\Delta \beta$ being small at will, it follows that ΔI is also small at will; *i.e.*, I is *continuous*. We observe in passing that ΔI is part of a cylindric layer or rim around the original cylindric volume that depicts the integral geometrically. For $\Delta \beta = 0$,

$$\begin{aligned} \frac{\Delta I}{\Delta a} &= A = \int_b^\beta z dy = \frac{I(a + \Delta a, \beta) - I(a, \beta)}{\Delta a} \\ &= \left\{ \int_a^{a + \Delta a} dx \int_b^\beta f(x, y) dy \right\} / \Delta a. \end{aligned}$$

Here $\int_b^\beta f(x, y) dy$ is the integrand of the integration as to x from a to $a + \Delta a$; if in this interval this integrand be continuous, then it (and therewith its equal $\frac{\Delta I}{\Delta a}$) actually attains the mean value A ; and if, in the immediate vicinity of $x = a$, the function f or z be a uniformly continuous function of x for y anywhere in the interval of b to β , then on passing to the limit we obtain

$$\frac{\partial I}{\partial a} = \int_b^\beta f(a, y) dy;$$

and similarly, under similar conditions,

$$\frac{\partial I}{\partial \beta} = \int_a^a f(x, \beta) dx,$$

so that *symbolically*

$$dI = \frac{\partial I}{\partial a} \cdot da + \frac{\partial I}{\partial \beta} \cdot d\beta \quad \text{or} \quad \frac{dI}{dt} = \frac{\partial I}{\partial a} \cdot \frac{da}{dt} + \frac{\partial I}{\partial \beta} \cdot \frac{d\beta}{dt}.$$

Such is the *Theorem of Total Differential*. Similarly with respect to the lower extremes. Also, *in general*

$$\frac{\partial^2 I}{\partial a \partial \beta} = \frac{\partial^2 I}{\partial \beta \partial a},$$

the order of derivation as to the extremes is indifferent. Hence the definite double integral with independent ex-

tremes is a continuous function of those extremes; and if in the immediate vicinity of those extremes the integrand be a uniformly continuous function of the extreme in question, regardless of the other argument, then the theorems hold for the total differential and the interchangeable order in derivation.

255. Change of Variables.—As in single, so in double, integration, it is often required to change the variables or arguments of integration. In the first case such a change meant another way of cutting up into sub-intervals the total interval of integration, from $x=a$ to $x=b$; in this second case such a change means cutting up in another way the surface S over which we integrate, and it is essential to the notion of integral that the result be independent both of the manner of sub-division and of the order of summation. In simple quadrature we had the symbolic formula $du = u_x \cdot dx$ or $dx = x_u du$ for changing the variable of integration; in words, *to pass from integration as to x over to integration as to u , multiply the integrand by the derivative of x as to u* , the extremes of course being changed appropriately.

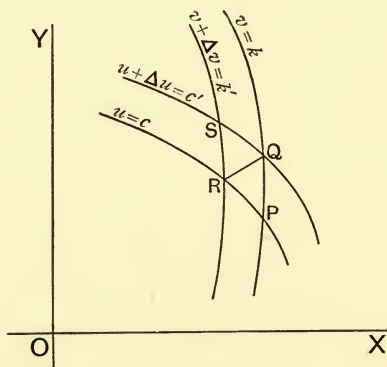

FIG. 43.

Now we have already seen that in many relations, in case of two independents, the *Jacobian* of (u, v) as to

(x, y) supplaces the simple derivative of u as to x , so that we suspect that there holds the symbolic equation

$$dudv = J(u, v; x, y) dx dy \quad \text{or} \quad dx dy = J(x, y; u, v) dudv,$$

a suspicion readily confirmed thus:

Let x and y be rectangular Cartesians, and draw any system of neighbouring lines along each of which u is constant, also another such system along each of which v is constant. The whole surface S is thus cut up into a number of curvilinear quadrilaterals, which we take for surface-elements. Consider one of them, as $PQRS$; its vertices are the points

$$(u, v), (u + \Delta u, v), (u + \Delta u, v + \Delta v), (u, v + \Delta v),$$

or in Cartesians

$$(x, y), [x + (x_u + \sigma_1)\Delta u, y + (y_u + \sigma_1')\Delta u],$$

$$[x + (x_u + \sigma_1)\Delta u + (x_v + \sigma_2)\Delta v, y + (y_u + \sigma_1')\Delta u + (y_v + \sigma_2')\Delta v],$$

$$[x + (x_v + \sigma_2)\Delta v, y + (y_v + \sigma_2')\Delta v].$$

$PQRS$, as the double of PQR , is given (close at will) by

$$\begin{vmatrix} 1, & x, & y, \\ 1, & x_q, & y_q, \\ 1, & x_r, & y_r, \end{vmatrix}$$

where x_q, y_q and x_r, y_r are coordinates of Q and R .

On subtracting the second row from the third, and the first from the second, and setting out $\Delta u \Delta v$, we have

$$\begin{vmatrix} x_u + \sigma_1, & y_u + \sigma_1' \\ x_v + \sigma_2, & y_v + \sigma_2' \end{vmatrix} \Delta u \Delta v,$$

which we may take for the *element of area*—the σ 's of course being infinitesimals. On summing we have

$$\Sigma \Sigma z \Delta x \Delta y = \Sigma \Sigma z \begin{vmatrix} \text{Det.} \\ \Delta u \Delta v, \end{vmatrix}$$

whence, on passing to the limit,

$$\iint z dx dy = \iint z \begin{vmatrix} x_u, & y_u \\ x_v, & y_v \end{vmatrix} dudv = \iint z \frac{\partial(x, y)}{\partial(u, v)} dudv.$$

Hence, in order to pass from integration as to (x, y) over to integration as to (u, v) , multiply the integrand by the Jacobian of (x, y) as to (u, v) . In case X and Y are not rectangular it will suffice to multiply $\Delta x \Delta y$ by the sine of the angle between X and Y .

We note that

$$dx dy = J(x, y; u, v) du dv$$

is a mere symbolism that holds good under the integral sign, but has no magnitudinal import outside.

Illustration.—Pass from rectangular Cartesian to polar coordinates. Here $x = r \cos \theta$, $y = r \sin \theta$; hence

$$x_r = \cos \theta, \quad x_\theta = -r \sin \theta, \quad y_r = \sin \theta, \quad y_\theta = r \cos \theta.$$

Hence $J = r$ and $dx dy = r dr d\theta$.

From the figure this is also geometrically evident.

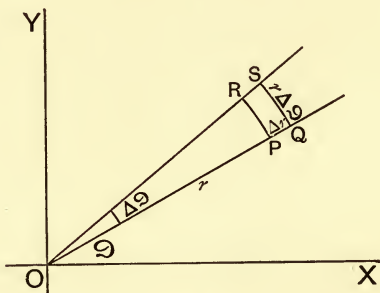

FIG. 44.

256. Generalization.—The foregoing result is so remarkable that we may well ask, *can it be generalized?* Suppose, then, we have n independents (x, y, z, \dots) , functions of n other independents (u, v, w, \dots) . Assign to the second set any n systems of simultaneous changes, as

$$\Delta_1 u, \Delta_1 v, \Delta_1 w, \dots; \quad \Delta_2 u, \Delta_2 v, \Delta_2 w, \dots; \quad \dots; \quad \Delta_n u, \Delta_n v, \Delta_n w, \dots$$

Let the corresponding n systems of changes in the first set be

$$\Delta_1 x, \Delta_1 y, \dots; \quad \Delta_2 x, \Delta_2 y, \dots; \quad \dots; \quad \Delta_n x, \Delta_n y, \dots$$

Form the quotient of the determinants of these two groups of changes, namely,

$$\left| \begin{array}{c} \Delta_1 x, \Delta_2 y, \Delta_3 z, \dots \\ \Delta_1 u, \Delta_2 v, \Delta_3 w, \dots \end{array} \right| \Bigg/ \left| \begin{array}{c} \Delta_1 u, \Delta_2 v, \Delta_3 w, \dots \\ \Delta_1 x, \Delta_2 y, \Delta_3 z, \dots \end{array} \right|.$$

Now we have $\Delta_1 x$ = the sum of the changes in x due to the changes $\Delta_1 u, \Delta_1 v$, etc., so that we may write

$$\Delta_1 x = \frac{\Delta x}{\Delta u} \cdot \Delta_1 u + \frac{\Delta x}{\Delta v} \cdot \Delta_1 v + \dots$$

following the analogy of total differentials, where the quotient $\frac{\Delta x}{\Delta u}$ can differ from the partial derivative $\frac{\partial x}{\partial u}$ only by an infinitesimal σ_1 , so that

$$\text{Lim } \frac{\Delta x}{\Delta u} = \frac{\partial x}{\partial u}, \text{ etc.}$$

On making these substitutions we recognize the *numerator* of the foregoing determinant-quotient as the product of the denominator by the corresponding determinant of the foregoing difference-quotients*; that is, by

$$\left| \begin{array}{c} \frac{\Delta x}{\Delta u}, \frac{\Delta y}{\Delta v}, \frac{\Delta z}{\Delta w}, \dots \\ \Delta_1 u, \Delta_2 v, \Delta_3 w, \dots \end{array} \right|.$$

Hence this last determinant equals the foregoing quotient*; hence on taking the limits we have

$$\begin{aligned} \text{Lim } \left| \begin{array}{c} \frac{\Delta x}{\Delta u}, \frac{\Delta y}{\Delta v}, \dots \\ \Delta_1 u, \Delta_2 v, \dots \end{array} \right| &= \left| \begin{array}{c} \frac{\partial x}{\partial u}, \frac{\partial y}{\partial v}, \dots \\ \Delta_1 u, \Delta_2 v, \dots \end{array} \right| \\ &= \text{Lim } \left| \begin{array}{c} \Delta_1 x, \Delta_2 y, \dots \\ \Delta_1 u, \Delta_2 v, \dots \end{array} \right| \Bigg/ \left| \begin{array}{c} \Delta_1 u, \Delta_2 v, \dots \\ \Delta_1 x, \Delta_2 y, \dots \end{array} \right|. \end{aligned}$$

Accordingly we may take as **definition** of the most generalized Jacobian the equation

$$J(x, y, \dots; u, v, \dots) = \text{Lim } \left| \begin{array}{c} \Delta_1 x, \Delta_2 y, \dots \\ \Delta_1 u, \Delta_2 v, \dots \end{array} \right| \Bigg/ \left| \begin{array}{c} \Delta_1 u, \Delta_2 v, \dots \\ \Delta_1 x, \Delta_2 y, \dots \end{array} \right|.$$

*Strictly, they differ by infinitesimals only.

257. Geometric Interpretation.—Hence we may regard the Jacobian as the derivative of the system x, y, \dots with respect to the system u, v, \dots . Now, however, we know what we *mean* by the derivative of the *magnitude* x as to the *magnitude* u , namely, the limit of the quotient of the corresponding *magnitudes* Δx and Δu , the corresponding changes in the magnitudes x and u ; is the Jacobian also the limit of the ratio of two corresponding magnitudes, the corresponding changes in two magnitudes? In answer, we observe that the system u, v, \dots determines for any set of values of u, v, \dots a point P in the n -fold extent in which u, v, \dots are laid off as (say) rectangular Cartesians. A linear relation among these coordinates, as $l_1 u + m_1 v + \dots = k_1$, will determine a simple $(n-1)$ -fold extent, as a line in a plane, a plane in (our) space, a space in a four-fold extent, etc. Hence $(n+1)$ such linear relations will bound off completely the simplest-bounded part of n -fold extent in this n -fold space,—as two points bound a tract in a line, three lines a triangle in a plane, four planes a tetraeder in (our) space, five (of our) spaces a five-pointed portion of four-fold space (four-wayed spread), etc., all of which are the simplest-bounded portions of their respective extents.

Now, when all these $(n+1)$ extents fall together, then and only then this extent thus bounded by them flattens down to that one $(n-1)$ -fold extent and vanishes, becomes 0, as an n -fold extent. But then and only then the $(n+1)$ points forming the vertices of the simplest-bounded n -fold extent, where the $(n-1)$ -fold extents intersect in sets of n , all fall into one and the same $(n-1)$ -fold extent,—as when two ends of a tract fall together in a point, or three sides of a triangle fall together in a line, or four faces of a tetraeder fall together in a plane, etc. But then and only then the coordinates of the $(n+1)$ points, (u, v, \dots) , (u, v, \dots) , ... (u_n, v_n, \dots) , all satisfy

the same linear relation, the equation of the $(n-1)$ -fold extent, $lu + mv + \dots = k$; and the condition that $(n+1)$ such homogeneous linear equations hold among the $(n+1)$ unknowns l, m, \dots, k is that the determinant of the coefficients vanish; *i.e.* on bringing the last column, of 1's, the coefficients of k , into the first place,

$$\begin{vmatrix} 1, u, v, w, \dots \\ 1, u_1, v_1, w_1, \dots \\ 1, u_2, v_2, w_2, \dots \\ \dots\dots\dots\dots\dots\dots \\ 1, u_n, v_n, w_n, \dots \end{vmatrix} = 0 = \begin{vmatrix} u_1 - u, & v_1 - v, & \dots \\ u_2 - u_1, & v_2 - v_1, & \dots \\ \dots\dots\dots\dots\dots\dots \\ u_n - u_{n-1}, & v_n - v_{n-1}, & \dots \end{vmatrix} = \Delta.$$

This determinant Δ is n -dimensional, it is geometrically a portion of the n -fold extent; also, it vanishes when, and only when, the simplest-bounded n -fold extent under consideration vanishes; hence the two can differ, if at all, only by a constant numerical factor, which actually turns out to be $\lfloor n$,—as for $n=2$, $\Delta=2$ (triangle); for $n=3$, $\Delta=6$ (tetraeder); etc. Now these differences $u_1 - u, u_2 - u_1, \dots, v_1 - v, \dots$ are nothing but $\Delta_1 u, \Delta_2 u, \dots, \Delta_1 v, \dots$, so that Δ is nothing but the denominator in the determinant-quotient of Art. 256; which accordingly is merely $\lfloor n$ times the simplest-bounded n -fold extent in question. Similarly the numerator of the same quotient is merely $\lfloor n$ times the corresponding simplest-bounded n -fold extent when x, y, z, \dots are rectangular Cartesians dependent on u, v, w, \dots . Moreover, when u, v, w, \dots are neither rectangular nor rectilinear coordinates, but curvilinear, then the differences $\Delta_1 u, \dots, \Delta_1 v, \dots$ will indeed be small arcs, but, *in general*, the *limits* of the ratios of these arcs to their chords being 1, we may put the chords for the arcs without affecting the limit, so that the same result will hold in general for u, v, \dots any kind of coordinates. Likewise, by similar reasoning, it will hold for x, y, \dots any sort of coordinates. If x, y, \dots were not rectangular, the determinant in question would still differ from the

extent in question by only a constant factor, the *generalized sine* of the *higher angle* determined by the axes at the origin. Finally, then, it appears that the Jacobian is in nature a true derivative, namely, the *limit* of a difference-quotient, the differences being simplest-bounded corresponding n -fold extents, or elements of the n -fold extent, as determined in the two systems of coordinates.

258. Infinite Integrands.—Thus far the integrand has been assumed finite and definite throughout the domain of integration. But sometimes it becomes infinite or indeterminate at certain points, for certain values of the argument of integration. Let $x=c$ be such a value, in case of the simple integral $\int_a^b f(x)dx$, so that $f(c)$ is ∞ , or perhaps indeterminate. Then $\int_a^b f(x)dx$ in general loses all meaning; but if the two integrals

$$\int_a^{c-\sigma_1} f(x)dx \quad \text{and} \quad \int_{c+\sigma_2}^b f(x)dx$$

approach each a definite limit as the infinitesimals σ_1 and σ_2 approach 0 independently, then the sum of these two limits is called the **Principal Value** of the integral $\int_a^b f(x)dx$, and is taken as *the* value. This means that our result is definite and unique, got by extending the integration close at will to the point c on both sides. Such is certainly the case *whenever the infinity of $f(x)$ at $x=c$ is determinately lower than the infinity of $\frac{1}{x-c}$, that is, algebraically lower than first degree.* For then

$$\left| f(x) \right| < \left| \frac{A}{(x-c)^n} \right|,$$

where the vertical bars mean *absolute worth* or *sign disregarded*, and n is < 1 . Hence

$$\left| \int_{c+\sigma}^{c+\sigma'} f(x) dx \right| < \left| A \int_{c+\sigma}^{c+\sigma'} \frac{dx}{(x-c)^n} \right| = \left| \frac{A}{1-n} (\sigma'^{1-n} - \sigma^{1-n}) \right|,$$

and this latter expression is infinitesimal for n finitely < 1 ; that is, we can approach the integration on both sides so close to the point $x=c$ that no further approach can make the value of either integral fluctuate by more than an infinitesimal. The like holds in certain cases even when n is not *assignably* less, but still less, than 1, but manifestly fails for $n \geq 1$; for then

$$\left| \int_{c+\sigma}^{c+\sigma'} f(x) dx \right| \geq \left| A \log \frac{\sigma'}{\sigma} \right|,$$

and this latter fluctuates indeterminately with σ and σ' .

When, as x approaches c , the integrand sways between indefinitely great values positive and negative, but does not tend to settle down upon any order of infinitude, the *principal value* is definite.

It may happen that the integrand becomes infinite determinately or indeterminately at a number of discrete points; the foregoing reasoning holds as to each such point. If the infinity be determinately < 1 or be indeterminate at each of the points, the *principal value* is definite; but otherwise there is no such value, the integral loses all meaning.

It may even happen that these critical values of x , or critical points, heap themselves indefinitely close together in some small region of value, they become infinite in number in a finite sub-interval; in that case the integral loses all meaning for such sub-interval.

259. Infinite Integrands (*continued*). Similar reasoning holds for integrands becoming infinite in double integration. If $f(x, y)$ becomes ∞ at the point (p, q) , then the surface $z=f(x, y)$ at this point shoots up without limit, and the question is, What contribution does this

needle-peak make to the volume? We enclose the point by a small circle of radius σ , so that on this circle

$$x = p + \sigma \cos \theta, \quad y = q + \sigma \sin \theta,$$

$$\text{and} \quad \iint f(x, y) dx dy = \iint (p + \sigma \cos \theta, q + \sigma \sin \theta) \sigma d\sigma d\theta.$$

We draw a second circle about (p, q) , of radius σ' , and integrate over the ring between the two. If then, as σ and σ' independently tend to 0, no matter how, the integral over this ring, the cylindric lamina, tends to 0 as its limit, then by extending the integration ever nearer and nearer to (p, q) we cannot make the value of the integral fluctuate except infinitesimally, the volume or integral will settle down upon a definite limit as the integration closes down upon (p, q) . The question, then, is about the volume of the cylindric lamina: Does its base shrink faster than its height expands? If so, it is infinitesimal, but not otherwise. Now its base is $< \pi \sigma^2$; hence if its height $z \equiv f(x, y)$ be $< A/\sigma^n$, that is, if the order of z 's infinitude at (p, q) be n , we have the integral over the ring or the volume of the lamina $< \pi A \sigma^{2-n}$, and this is infinitesimal when and only when $n < 2$. For $n \geq 2$ we have the volume of the cylindric lamina

$$\geq 2\pi A \log \frac{\sigma}{\sigma'},$$

and this is manifestly infinite or indeterminate, fluctuating with the σ 's, that is, with the nearness to (p, q) .

Suppose now that z becomes infinite at a number of discrete points; then the volume would shoot up these infinite needle-peaks here and there, and the preceding would apply in each case. Or these ∞ -points might be heaped together so as to form a **linear set**, to fill out a line or curve-length anywhere in S . Then the solid would shoot up infinitely as a knife-edge or mountain-ridge over this line or curve, of length (say) l , and the

question is, What contribution does this ridge make to the volume? We bound off a strip about this l in S , (say) σ wide, on each side of l . Then $l\sigma$ is the area of this base of the ridge; then if all along this ridge z be $< A/\sigma^m$, the contribution of this ridge to the volume is certainly $< lA\sigma^{1-m}$, and this is infinitesimal when and only when $m < 1$. Hence *the integral over S remains finite even when the integrand becomes infinite along a finite curve in S , but only in degree less than 1.*

260. Extension of domain of Integration.—Thus far, both in simple and in double integration, the domain of integration has been finite, as from a to b or over the finite S . But often we have occasion to extend this range indefinitely, and the question arises: Does the integral still remain finite? In case of a simple integral,

$\int_a^\infty f(x)dx$, we might at once change the variable to $z = \frac{1}{x}$,

then we have

$$\int_a^\infty f(x)dx = - \int_{\frac{1}{a}}^0 f\left(\frac{1}{z}\right) \frac{dz}{z^2} = \int_0^{\frac{1}{a}} f\left(\frac{1}{z}\right) \frac{dz}{z^2}.$$

The question then becomes, Does the integrand $f\left(\frac{1}{z}\right)\frac{1}{z^2}$ become ∞ in the neighbourhood of $z=0$? and we already know that the integral remains definite only when the order of the integrand's infinitude is < 1 . Now $\frac{1}{z^2}$ becomes, at (0) , ∞ of order 2; hence $f\left(\frac{1}{z}\right)$ must then become 0 of order > 1 , that is, must become ∞ of order < -1 ; hence in order for *the integral*

$$\int_a^b f(x)dx$$

to remain finite as b nears ∞ , the integrand $f(x)$ must

vanish of order > 1 as x approaches ∞ , or its degree of nullitude must be > 1 , or it must have at ∞ a zero of order > 1 —all which expressions are tantamount.

In case of double integration we might employ a similar transformation, but we vary the method thus: Suppose the domain S to enlarge without limit in every direction. Then plainly the integral or volume must increase without limit unless the height $z \equiv f(x, y)$ in all the remote regions of S at the same time decreases without limit, the solid must thin out indefinitely in every direction. The question then is, How fast must it thin out? About the origin O we draw two circles of radii R and R' ; the area of the ring between them is

$$\pi(R^2 - R'^2) \equiv \pi(R + R')(R - R').$$

Now let both R and R' increase without limit; then the contribution to the integral or volume made by this cylindric lamina will be $\pi(R + R')(R - R')z_m$, where z_m is the average or mean height of the lamina. Now each of the factors $R + R'$ and $R - R'$ becomes or may become ∞ with R —we have only, for instance, to take R' great at will and then R twice as great; hence the base of the lamina becomes ∞ in second degree; hence if z becomes infinitesimal of only second degree the product or volume will be finite but indeterminate, varying with the ratio of R to R' ; hence the integral loses all meaning. If z becomes infinitesimal of degree lower than 2, the product or volume will become ∞ , and the integral again loses meaning. But if z vanish (become infinitesimal) of degree higher than 2, then on cancellation the product will retain an infinitesimal factor, and the cylindric ring will have a volume small at will, and the integral will fluctuate only infinitesimally as S enlarges without limit, and the limit of the integral or volume will be the true and only value of the integral extended over the whole plane.

Most frequently S will not extend over the whole plane but only over some region of it bounded by some unclosed line or lines, as by a parabola, or by an hyperbola and its asymptotes. In such a case the upper extremes, α and β , become ∞ in definite way or ways, and our general method is to evaluate the integral for α and β finite, and observe how the value thus obtained fluctuates as α and β grow without limit. Only when, on taking α and β large enough, all further fluctuation caused by taking them still larger is infinitesimal, does the integral approach a limit and retain meaning.

It sometimes happens that, even when the double integral loses its significance in general, it may yet attain definite value for a definite succession of integrations; in that case such a value is called a **singular value**, and importance attaches to it in the theory and application of the so-called Fourier's integrals.

261. Products of Integrals.—Sometimes the integrand z breaks up into two factors, functions the one solely of x , the other solely of y , as $z \equiv f(x, y) \equiv \phi(x) \cdot \psi(y)$, while the extremes are constant, so that the domain S is a rectangle of sides $\alpha - a$, $\beta - b$ parallel to X and Y . In that case

$$I \equiv \int_a^\alpha \int_b^\beta \phi(x) \cdot \psi(y) dx dy = \int_a^\alpha \phi(x) dx \cdot \int_b^\beta \psi(y) dy,$$

which means we are to integrate along a strip parallel to Y , along which both $\phi(x)$ and dx (or Δx) are constant and accordingly may be set outside the sign of integration as to y ; the integral of this strip is a constant

$$B \equiv \int_b^\beta \psi(y) dy,$$

which may be set in front of

$$\int_a^\alpha \phi(x) dx, \text{ so that } I = B \int_a^\alpha \phi(x) dx.$$

This latter integral is another constant A , so that, finally,

$$I \equiv \int_a^\alpha \int_b^\beta \phi(x)\psi(y) dx dy = A \cdot B = \left\{ \int_a^\alpha \phi(x) dx \right\} \cdot \left\{ \int_b^\beta \psi(y) dy \right\},$$

i.e., the double integral between constant extremes, *i.e.*, over a rectangle with sides parallel to the axes, of the product of two functions, one of x and one of y , equals the product of the integrals of these functions.

This result reminds us of Theorem V., Art. 10, and may be reached by applying the same, thus:

$$\int_a^\alpha \phi(x) dx = L \sum_m \phi(x_m) \Delta x_m, \quad \int_b^\beta \psi(y) dy = L \sum_n \psi(y_n) \Delta y_n;$$

$$\int_a^\alpha \phi(x) dx \cdot \int_b^\beta \psi(y) dy = L \sum_m \phi(x_m) \Delta x_m \cdot L \sum_n \psi(y_n) \Delta y_n$$

$$= L \left\{ \sum_m \phi(x_m) \Delta x_m \cdot \sum_n \psi(y_n) \Delta y_n \right\}$$

$$= L \sum_m \sum_n \phi(x_m) \cdot \psi(y_n) \cdot \Delta x_m \cdot \Delta y_n = \int_a^\alpha \int_b^\beta \phi(x)\psi(y) dx dy.$$

262. Surface and Line Integrals.—Continuing our study of the analogies of simple and double integrals, we remark that the value of the first is expressible through *extreme* or *end values* of the *derivand*, of which function the integrand is the derivative, thus:

$$\int_a^\alpha f(x) dx = \phi(\alpha) - \phi(a), \quad \text{where } \phi' = f;$$

and we naturally ask, Is $\iint f(x, y) dx dy$ expressible through the *extreme* or *border values* of a function (derivand) of which f is derivative?" To answer this question we suppose S any domain with simple or multiple border (simply or multiply connected or compendent, *ein-oder mehr-fach zusammenhängend*), *e.g.*, with triple border;

over it we will integrate

$$f \equiv \frac{\partial \phi}{\partial x} = \frac{\partial \psi}{\partial y},$$

and first as to x . We agree to reckon positively the border S composed of s' , s'' , s''' , so that S shall always lie to the *left* of the arrow as it compasses S . We may push the axes so as to bring S wholly within first quadrant. Then we regard f as everywhere 0 except in the region bounded by s . We integrate along a strip Δy (or dy) wide and parallel to X . The effective integ-

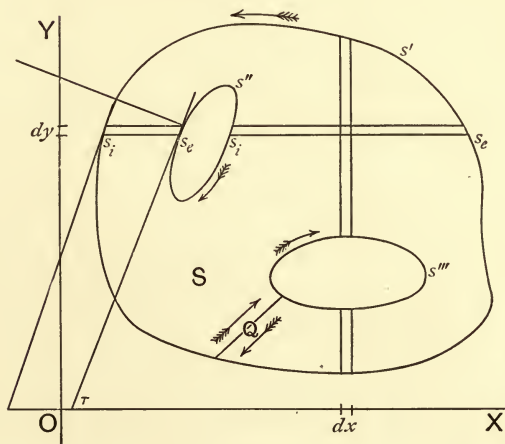

FIG. 45.

ration begins where we enter S at ds_i , and ends where we pass out of S at ds_e . Along this strip f is a function of x only, is constant as to y , and Δy (or dy) is constant; hence we may set out dy and integrate $\frac{\partial \phi}{\partial x}$ as to x , which integration yields $\phi_e - \phi_i$. Hence the contribution made to the total integral by a strip parallel to X is $(\phi_e - \phi_i)dy$, where ϕ_e and ϕ_i are the extreme values of ϕ , at points of *exit* and *init*. If we enter and pass out of S several times in course of integration along the strip,

as at B and C , nothing new arises; instead of the one difference of ϕ 's we have a succession of differences

$$(\phi_e - \phi_i)_1 + (\phi_e - \phi_i)_2 + \dots,$$

one for each part of the strip lying in S , and dy is the same for all. Hence the total double integral over S becomes

$$\int_b^{\beta} (\phi_e - \phi_i) dy,$$

all the ϕ 's considered. This form is not convenient but becomes so on changing the variable of integration from y to s . For at every point of *exit* we have

$$\frac{dy}{ds} = \sin \tau = \sin \nu,$$

where ν = slope with respect to $+Y$ of normal to ds , the normal being drawn inward; and at every point of entrance

$$\frac{dy}{ds} = -\sin \tau = -\sin \nu.$$

Hence substituting for dy we obtain

$$\iint f(x, y) dx dy \equiv \iint \frac{\partial \phi}{\partial x} dx dy = \int \phi \sin \tau ds = \int \phi \sin \nu ds,$$

where the integration as to s is to be extended round s completely, along the whole border s , in positive sense. Similarly by integrating first along a strip parallel to Y we shall obtain

$$\iint f(x, y) dx dy \equiv \iint \frac{\partial \psi}{\partial y} dx dy = - \int \psi \cos \tau ds = - \int \psi \cos \nu ds.$$

Here then the original **surface-integral** is expressed as a **line-integral** extended over the *line* bounding the *surface*, over a system of *end-values* of the original derivand. The same formula may of course be used to turn a line-integral into a surface-integral.

The advantage of introducing the slope ν of the normal, as to Y , instead of the slope τ of the tangent, as to X , will appear in dealing with triple integrals.

When S is multiply connected we may make it simply connected by *slitting* it as in the figure, along Q ; the *two edges of the slit* then count as parts of the border s , and the two integrations along these two edges, being opposite in sense and of the same integrand, *annul* each other.

263. Exact Differentials.—A case of special importance presents itself when ϕ and ψ are partial derivatives as to x and y of the same function $F(x, y)$, so that

$$\phi = \frac{\partial F}{\partial x}, \quad \psi = \frac{\partial F}{\partial y},$$

and therefore
$$\frac{\partial \phi}{\partial y} = \frac{\partial \psi}{\partial x}.$$

Hence, from the theorem of total differential,

$$\partial F = \phi dx + \psi dy,$$

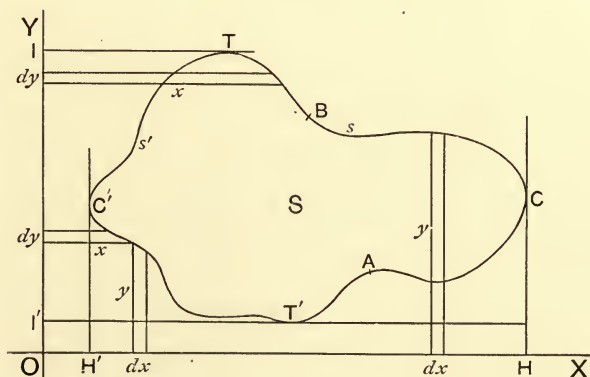

FIG. 46.

which latter expression is accordingly called an *exact differential*. Let us integrate this E.D. all round S ; then

$$\begin{aligned} \int (\phi dx + \psi dy)_{\text{along } s} &= \int (\phi \cos \nu + \psi \sin \nu) ds \\ &= \iint \left(\frac{\partial \psi}{\partial x} - \frac{\partial \phi}{\partial y} \right) dx dy_{\text{over } S} = 0; \end{aligned}$$

i.e., The integral of an E.D. of $F(x, y)$ vanishes when extended positively round a domain in which F is everywhere unique, with F_{xy} and F_{yx} everywhere equal and integrable—a result that may hold even when F_{xy} is unequal to F_{yx} at discrete points or along a line, but not over an area however small.

Hence, if two lines (or paths of integration) s and s' , as ACB and $AC'B$, bound completely such a region S , then

$$\int (\text{E.D.})_{\text{along } s} - \int (\text{E.D.})_{\text{along } s'} = 0,$$

for we compass S completely by traversing s *positively* and s' *negatively*. Hence

$$\int (\text{E.D.})_{\text{along } s} = \int (\text{E.D.})_{\text{along } s'};$$

i.e., Integrals of an E.D. from A to B along two paths bounding completely such a domain S , are equal—a proposition of far-reaching significance.

Illustration.—Let $F = xy$, then $\int (\text{E.D.}) = \int (ydx + xdy)$, and we are to extend it completely round S . Now $\int ydx$ along $C'AC$ yields area $C'H'CA$, and $\int ydx$ along CBC' yields area $HCBC'H'$ in opposite or negative sense; hence $\int ydx$ all round S yields area S *negative*. Similarly $\int xdy$ along $T'CT$ yields area $I'T'CTI$; $\int xdy$ along $TC'T'$ yields area $TIIT'C'$ *negative*; hence $\int xdy$ all round S yields area S *positive*; hence $\int (ydx + xdy) = \int d(xy) = 0$, when extended all round S .

If now we suppose F some other function of x and y , then our integration round S may not yield a simple area as above, so that we shall not *see* the result so clearly, but the reasoning will remain unchanged. The integration round S may be regarded as walling S in, the height of the wall at each point being the value of the integrand at that point. In the illustration the height is the ordinate (resp. abscissa) of the

point. When the wall turns out *negative*, it is to be conceived as built *downward*. In the general case the height is not the ordinate nor the abscissa, but some other function of the point. What the theorem affirms is that the amount of walling *up* equals the amount of walling *down*.

If now we change the sign of (say) ydx , we shall get $xdy - ydx$, *not* an exact differential, and this integrated round S yields *not* 0, but *twice the area* S . Further discussion must be reserved.

264. Triple Integrals.—The foregoing doctrine in general admits of easy extension to higher multiple integrals. Thus, if there be any portion of space, or volume, V , we may suppose it cut up into a triple system of cuboidal elements by a triple system of planes normal to X, Y, Z respectively, and $\Delta x, \Delta y, \Delta z$ apart. The volume of any such cuboid will be $\Delta x, \Delta y, \Delta z$, and V will be the limit of the sum of all such elements:

$$V = L\Sigma\Delta V = L\Sigma\Sigma\Sigma\Delta x \cdot \Delta y \cdot \Delta z = \iiint dx dy dz.$$

The triple Σ is to be understood thus: Choose any pair $\Delta x, \Delta y$, that is, any rectangular element in the plane XY , and sum for all the corresponding Δz 's; the result is a small rectangular prismoid of right section $\Delta x \Delta y$ extending clear through the volume V from z_i to z_e ; hence this contribution to the total sum is $(z_e - z_i)\Delta x \Delta y$. Of course, if the volume is folded or hollow (multiply connected), there will be several entrances and as many exits, so that $z_e - z_i$ will be $(z_e - z_i)_1 + (z_e - z_i)_2 + \dots$. Now, holding Δx fast, sum all such prismoids for all corresponding Δy 's; the result is a lamina, Δx thick and parallel to YZ . Lastly sum all such laminae, and the limit of the result is the volume V . But this is nothing but a triple integration, first as to z , then as to y , then as to x . The extremes of z, z_e and z_i , are determined by the equation of the surface bounding V , hence are in general functions of both x and y ; the extremes of y are determined by the

equation of the curve of section of the surface made by the plane parallel to YZ , and hence are in general functions of x ; the extremes of x are absolute constants, intercepts on X of tangent-planes normal to x . (See Fig. 42.)

If, now, we are called on to integrate $F(x, y, z)$ throughout V , $\iiint F(x, y, z) dx dy dz$, our space-intuition fails us; at each point of V we should have to imagine erected a normal to our own three-fold space and of length F , but we cannot imagine any such normal. Nevertheless, no analytic difficulty is present; we merely suppose each element $dx dy dz$ *weighted* with a multiplier F varying from point to point, and proceed to integrate precisely as before. If F be n -dimensional in x, y, z , the result will be $(n+3)$ -dimensional in the extremes of x, y, z .

Thus far F has been supposed finite, continuous, unique, and V wholly in finity. Whether the triple integral loses or retains meaning in case any of these conditions be removed, must be tested as with double integrals. Similar interpretations and limitations apply to higher multiple integrals.

265. Space- and Surface-Integrals.—As line- and surface-integrals may be turned into each other, so may surface- and space-integrals. Let it be required to integrate $F(x, y, z)$ throughout a volume V bounded by a surface S , let

$$F = \frac{\partial \phi}{\partial x} = \frac{\partial \psi}{\partial y} = \frac{\partial \chi}{\partial z},$$

let the element of the bounding surface S be ΔS (or dS), and let λ be the slope of the normal to ΔS , with respect to X . We now integrate $F = \frac{\partial \phi}{\partial x}$ along a prism parallel to X , of right section $\Delta y \Delta z$; the contribution of this elementary prism to the total integral is $(\phi_e - \phi_i) \Delta y \Delta z$, and of course, if the volume be folded or hollow so that

the prism has several entrances and exits, we shall have $\phi_e - \phi_i = (\phi_e - \phi_i)_1 + (\phi_e - \phi_i)_2 + \dots$. Hence the total integral will be $\iint (\phi_e - \phi_i) dy dz$ extended over the complete projection of the space V on YZ . But now we may change the variable of integration from (y, z) to S , remembering that $L \frac{\Delta y \Delta z}{\Delta S} = \cos \lambda = L \frac{\Delta n}{\Delta x}$, where Δn is the element on the normal, corresponding to Δx on X . Hence, under the integral sign, $dy dz = \cos \lambda dS = \frac{\partial n}{\partial x} dS$. If this normal be drawn *inward*, λ will be in second or third quadrant, and

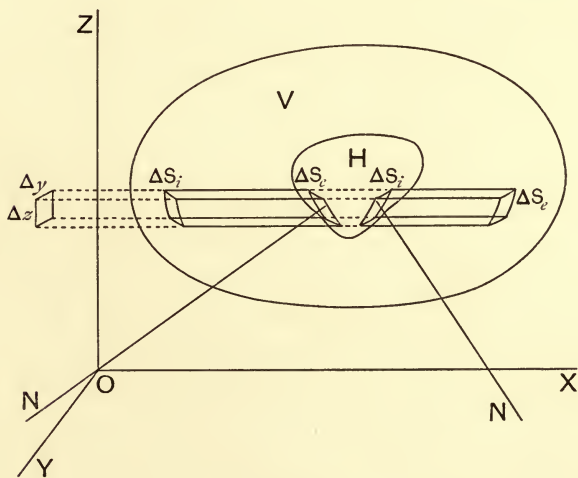

FIG. 47.

$\cos \lambda$ consequently $-$, at all points of exit of the prism, but λ will be in fourth or first quadrant, and $\cos \lambda$ consequently $+$, at all points of entrance. If the normal be drawn *outward*, the opposite will hold. In either case $\phi_e dS$ and $\phi_i dS$ take the same sign, dS being taken always positively, and our total integral becomes $\pm \int \phi \frac{\partial n}{\partial x} dS$ extended over the whole bounding surface S . Similarly

we proceed with the integrals of $\frac{\partial\psi}{\partial y}$ and $\frac{\partial\chi}{\partial z}$, and there results the convenient form:

$$\iiint\left(\frac{\partial\phi}{\partial x} + \frac{\partial\psi}{\partial y} + \frac{\partial\chi}{\partial z}\right) dx dy dz = \pm \int\left(\phi \frac{\partial n}{\partial x} + \psi \frac{\partial n}{\partial y} + \chi \frac{\partial n}{\partial z}\right) dS.$$

which turns a space-integral into a surface-integral, and *vice versa*.

266. Complanation.—The simplest case of surface-integral is presented in the problem of quadrature of a curved surface, or *complanation*, as it is sometimes called, where the multiplier of the surface-element, dS , is the constant, 1. To evaluate the area we proceed thus:

Let A' be the projection on the plane P' of any area A in the plane P inclined to P' at the angle (PP') ; then

$$A' = A \cos(PP').$$

For consider any rectangle in A with sides parallel and perpendicular to the intersection I of the planes; by projection the parallel sides will not be altered in length, but the perpendicular ones will be shortened in the ratio $\cos(PP') : 1$; hence the area of the rectangle will be decreased in the same ratio. This conclusion is at once extended from rectangle to parallelogram and any triangle, and thence to any rectilinearly bounded area, since this may be resolved into triangles. If the area be curvilinearly bounded, then inscribe and circumscribe polygonal areas, I_n and C_n of n sides, and let I_n' , C_n' be their projections. Then

$$I_n < A < C_n, \text{ and } I_n' < A' < C_n';$$

also
$$I_n' = I_n \cdot \cos(PP'), \quad C_n' = C_n \cdot \cos(PP')$$

at every stage of variation. As n increases towards ∞ , I_n and C_n close down upon the common limit A , I_n' and C_n' upon the common limit A' , and we have

$$A' = A \cdot \cos(PP').$$

Indeed, it suffices to imagine the area A resolved into narrow rectangles (or covered with spider lines) perpendicular to the intersection I ; in projection, the breadth of each such strip is unaltered, while the length is shortened in the common ratio $\cos(PP'):1$; hence, as before.

Now take XY as the plane of projection P' , and cut it into elementary rectangles by two systems of planes: the one perpendicular to Y and Δx apart, the other perpendicular to X and Δy apart. They cut the curved surface S into curvilinear quadrangles as $ABCD$ (Fig. 40). Pass also a system of planes through each such BC and perpendicular to XY . Pass a secant-plane K through A, B, C ; also a plane P tangent to S at the point T anywhere within ABC . We thus inscribe and circumscribe S with n -faced polyhedrons, I_n and C_n . By taking n large enough, Δx and Δy each small at will, we establish the inequality

$$I_n < S < C_n,$$

and for n increasing towards ∞ both I_n and C_n close down upon the common limit S , since the secant-plane K and the tangent-plane P settle down towards the same limiting position as the triangle ABC closes down, no matter how, upon T . Moreover, the projection of the plane triangle ABC is always $\frac{1}{2}\Delta x\Delta y$, and $=ABC \cdot \cos \gamma'$, where γ' is the inclination of K to XY . On passing to the limit γ' becomes γ , the inclination of the tangent-plane P to the plane XY , and we obtain

$$S = \text{Lim. } \Sigma \frac{\Delta x \Delta y}{\cos \gamma} = \iint \frac{1}{\cos \gamma} \cdot dx dy.$$

The extremes of integration must be properly determined, and we notice that the multiplier $\frac{1}{2}$ falls away, as there are two triangles, ABC and BCD , projected into the whole $\Delta x \Delta y$. We obtain the same result at once by regarding the surface as the limit of the sum of elements, one in

each tangent-plane, about the points of tangence; each of these equals its own projection $\Delta x \Delta y$ divided by the appropriate cosine of inclination, $\cos \gamma$. If the surface be not everywhere elementally flat, but have singularities, as sharp points and the like, these must be cut out, and the infinitesimal regions about them considered separately.

The inclination γ is the same as the slope of the normal at T to the Z -axis; hence, from Art. 203,

$$1/\cos \gamma = \sqrt{z_x^2 + z_y^2 + 1},$$

if the surface be $z = f(x, y)$.

Also, $1/\cos \gamma = \sqrt{F_x^2 + F_y^2 + F_z^2}/F_z$,

for $F(x, y, z) = 0$.

Very often x, y, z are expressed as functions of two independents, u and v , thus:

$$x = \phi(u, v), \quad y = \psi(u, v), \quad z = \chi(u, v),$$

whence by elimination,

$$z = f(x, y) \quad \text{or} \quad F(x, y, z) = 0.$$

Hence

$$z_u = z_x \cdot x_u + z_y \cdot y_u \quad \text{and} \quad z_v = z_x \cdot x_v + z_y \cdot y_v$$

whence

$$z_x = J(z, y; u, v)/J(x, y; u, v),$$

$$z_y = J(x, z; u, v)/J(x, y; u, v),$$

Substituting these values of z_x and z_y under the $\sqrt{\quad}$, and remembering that in passing from the independents (x, y) to the independents (u, v) , the element $dx dy$ under the integral sign changes into $J(x, y; u, v) du dv$, we get

$$S = \iint \frac{1}{\cos \gamma} \cdot dx dy = \iint \sqrt{J_x^2 + J_y^2 + J_z^2} \cdot du dv,$$

where J_x, J_y, J_z are the three Jacobians above; they may be obtained from the *rectangular array*

$$\left\| \begin{array}{ccc} x_u & y_u & z_u \\ x_v & y_v & z_v \end{array} \right\|$$

by deleting the columns in order.

Lastly, to integrate any function as $M(x, y, z) \equiv W(u, v)$ over the surface, we multiply by M , respectively W , under the \iint and proceed as in ordinary double integration. Herewith we regard each element of the surface as loaded with a mass $M \equiv W$, whatever it may be, as electricity, pressure, flow, or what not, and we take the integral or limit of the sum, $\int M \cdot dS$ or $\int W \cdot dS$, of all such loaded surface-elements.

Thus suppose any agent, as electricity, spread over the ellipsoid

$$\frac{x^2}{a^2} + \frac{y^2}{b^2} + \frac{z^2}{c^2} = 1,$$

so that its density at the point P equals the distance p , from the origin to the plane tangent at that point; find the total charge. We have to calculate $\int p dS$ over the ellipsoid; also

$$p = 1 / \sqrt{\frac{x^2}{a^4} + \frac{y^2}{b^4} + \frac{z^2}{c^4}}, \quad \text{and} \quad 1 / \cos \gamma = \frac{c^2}{z} \sqrt{\frac{x^2}{a^4} + \frac{y^2}{b^4} + \frac{z^2}{c^4}};$$

$$\therefore \int p dS = 8c^2 \iint \frac{dx dy}{z} = 8c \iint dx dy / \sqrt{1 - \frac{x^2}{a^2} - \frac{y^2}{b^2}} = 4\pi abc.$$

The double integration is extended over one quadrant of the ellipse

$$\frac{x^2}{a^2} + \frac{y^2}{b^2} = 1$$

for one octant, and there are eight octants.

267. Green's Theorem.—Perhaps the most important example of the transformation of integrals is the following. Let U and U' be two functions of (x, y, z) , whose values are given for every point in a region of space V ; and it is required to integrate $U_x \cdot U'_x + U_y \cdot U'_y + U_z \cdot U'_z$ throughout V . We have

$$U_x \cdot U'_x = (U \cdot U'_x)_x - U \cdot U''_{xx}.$$

Hence integral

$$I = \iiint \{ (U \cdot U_x')_x + (U \cdot U_y')_y + (U \cdot U_z')_z \} dV \\ - \iiint U (U_{xx'} + U_{yy'} + U_{zz'}) dV.$$

If, now, UU_x' , UU_y' , UU_z' be finite and continuous, or at least integrable throughout V , we may apply Art. 265, so that

$$I = - \int U \cdot \frac{\partial U'}{\partial n} \cdot dS - \iiint U \cdot \nabla^2 U' dx dy dz,$$

since

$$U_x' \cdot \frac{\partial x}{\partial n} + U_y' \cdot \frac{\partial y}{\partial n} + U_z' \cdot \frac{\partial z}{\partial n} = \frac{\partial U'}{\partial n}.$$

This transformation requires that U and U' and the first derivatives of U' be unique, finite, and continuous throughout the region of integration V ; if also the first derivatives of U be likewise unique, finite, and continuous throughout the same region, then we may exchange the notions and symbols U and U' in the formula above; and on equating the two expressions for I , there results

$$\iiint \{ U \cdot \nabla^2 U' - U' \nabla^2 U \} dV = \int \left\{ U' \frac{\partial U}{\partial n} - U \frac{\partial U'}{\partial n} \right\} dS.$$

This remarkable relation, first enounced by Green in his famous Essay, printed at Nottingham (1828), escaped notice till 1847, when Thomson, now Lord Kelvin, perceived its great significance for mathematical electricity. It was then republished in Crelle's *Journal* (Vols. 39, 44, 47). By its aid may be determined the *potential function* U for every point within a closed region where the U is given for every point of the bounding surface S , and $\nabla^2 U$ for every point of the interior region. In practice, U or its first derivatives will generally suffer some discontinuity in the interior at some point or along

some line or over some surface; these must then be bounded off and their boundaries reckoned to S , but the detailed treatment belongs to the *theory of the potential*, and lies beyond the range of this volume.

ILLUSTRATIONS AND EXERCISES.

1. Find the Jacobian for passing from rectangular to cylindrical coordinates.

We have $x=r \cos \theta$, $y=r \sin \theta$, $z=z$. Hence $J=r$; hence under integral sign, $dx dy dz=r dr d\theta dz$. This is also geometrically evident; for, to find an element of volume we draw about Z a system of coaxial cylinders and consider the tube bounded by two such with radii r and $r+dr$; we cut this into rings by planes normal to Z and consider the ring bounded by two such corresponding to z and $z+dz$; lastly, we cut this ring into cuboidal blocks by planes through Z and consider the block cut out by two such corresponding to θ and $\theta+d\theta$. The three edges of such a block are plainly dr , dz , and $r d\theta$, and under the integral sign we may write its volume $r dr d\theta dz$.

2. Find the Jacobian for passing to spheric coordinates.

We have $x=\rho \sin \phi \cos \theta$, $y=\rho \sin \phi \sin \theta$, $z=\rho \cos \phi$. Hence $J=\rho^2 \sin \phi$ and $dx dy dz=\rho^2 \sin \phi d\rho d\theta d\phi$.

We may envisage this geometrically thus: About the origin lay a system of concentric spheres and consider the shell bounded by two such with radii ρ and $\rho+d\rho$; cut this shell into rings by cones about Z (polar axis), vertex O , and consider the ring formed by two such corresponding to ϕ and $\phi+d\phi$; cut this ring into cuboidal blocks by half-planes (of longitude) through Z and consider the block cut out by two such corresponding to θ and $\theta+d\theta$. Three concurrent orthogonal edges of this block are $d\rho$, $\rho d\phi$, $\rho \sin \phi d\theta$, and for its volume we may write, under \iiint , $\rho^2 \sin \phi d\rho d\theta d\phi$.

3. Find formula for length of a tortuous curve.

If (x, y, z) and $(x + \Delta x, y + \Delta y, z + \Delta z)$
be ordinary neighbour points of the curve, then

$$\overline{\Delta c}^2 = \overline{\Delta x}^2 + \overline{\Delta y}^2 + \overline{\Delta z}^2;$$

hence, for t the independent,

$$\frac{\Delta c}{\Delta t} = \left\{ \left(\frac{\Delta x}{\Delta t} \right)^2 + \left(\frac{\Delta y}{\Delta t} \right)^2 + \left(\frac{\Delta z}{\Delta t} \right)^2 \right\}^{\frac{1}{2}} = \frac{\Delta c}{\Delta s} \cdot \frac{\Delta s}{\Delta t}.$$

Taking the limits and remembering $L \frac{\Delta c}{\Delta s} = 1$, we have

$$s_t = \frac{ds}{dt} = \{x_t^2 + y_t^2 + z_t^2\}^{\frac{1}{2}}, \quad s_x = \sqrt{1 + y_x^2 + z_x^2}.$$

Under the \int we may write $ds = \sqrt{dx^2 + dy^2 + dz^2}$, and we may freely use the symbolism $ds^2 = dx^2 + dy^2 + dz^2$, which however obtains magnitudinal import only when d signifies *derivation*, say as to t .

To find s we integrate between proper extremes.

4. In finding s , pass from the system (x, y, z) to (u, v, w) .

Denoting derivations as to t, u, v, w by $', 1, 2, 3$, we have $x' = x_1 \cdot u' + x_2 \cdot v' + x_3 \cdot w'$, and so on for y' and z' ;

$$x'^2 + y'^2 + z'^2 = A^2 u'^2 + B^2 v'^2 + C^2 w'^2 + 2(Dv'w' + Ew'u' + Fu'v'),$$

where

$$A^2 = x_1^2 + y_1^2 + z_1^2, \quad B^2 = x_2^2 + y_2^2 + z_2^2, \quad C^2 = x_3^2 + y_3^2 + z_3^2,$$

$$D = x_2 x_3 + y_2 y_3 + z_2 z_3, \quad E = x_3 x_1 + y_3 y_1 + z_3 z_1, \quad F = x_1 x_2 + y_1 y_2 + z_1 z_2.$$

The system (x, y, z) is orthogonal, the coordinate surfaces (planes) through the point (x, y, z) meet at right angles; if now the system (u, v, w) be also orthogonal, if the coordinate surfaces ($u = \text{a constant}$, $v = \text{another}$, $w = \text{another}$) through the same point (u, v, w) meet also at right angles, then D, E, F , being proportional to the cosines of mutual inclinations of these surfaces (or their tangent planes) at this point, must vanish; and if $\lambda_1,$

μ_1, ν_1 be the slopes as to X, Y, Z of the normal at this point to the surface $u = \text{constant}$, then we have

$$\cos \lambda_1 = \frac{x_1}{A}, \quad \cos \mu_1 = \frac{y_1}{A}, \quad \cos \nu_1 = \frac{z_1}{A};$$

and so for λ_2 , etc.

But if we know u, v, w in terms of x, y, z , then we may denote by subscripts $_1, _2, _3$ derivations as to x, y, z and proceed precisely as before; u, v, w being orthogonal,

$$ds^2 = du^2 + dv^2 + dw^2.$$

Putting $a^2 = u_1^2 + u_2^2 + u_3^2$, and so for b^2 and c^2 , we have

$$\cos \lambda_1 = \frac{u_1}{a}, \quad \cos \mu_1 = \frac{v_1}{a}, \quad \cos \nu_1 = \frac{w_1}{a};$$

and so for λ_2 , etc.

Hence $\frac{x_1}{A} = \frac{u_1}{a}$, and eight other such relations.

Hence $x_1u_1 + y_1v_1 + z_1w_1 = Aa$, and so on.

Now $x' = x_1u' + x_2v' + x_3w'$, and so for y', z' ,

$$u' = u_1x' + u_2y' + u_3z', \quad \text{and so for } v', w'.$$

In this latter expression, for u' , substitute the values of x', y', z' and collect; so

$$u' = (x_1u_1 + y_1v_1 + z_1w_1)u' + \text{terms in } v' \text{ and } w'.$$

This relation holds whatever v' and w' may be; hence, putting each = 0, we obtain

$$x_1u_1 + y_1v_1 + z_1w_1 = 1 = Aa.$$

Hence, of course, $Aa = Bb = Cc = 1$; $ABC = 1/abc$.

Now, remembering $\frac{x_1}{A} = \frac{u_1}{a}$, etc., form the Jacobians

$$|x_1y_2z_3| \quad \text{and} \quad |u_1v_2w_3|;$$

there results

$$\frac{\partial(x, y, z)}{\partial(u, v, w)} \cdot abc = \frac{\partial(u, v, w)}{\partial(x, y, z)} \cdot ABC;$$

whence

$$\frac{\partial(x, y, z)}{\partial(u, v, w)} = \pm ABC, \quad \frac{\partial(u, v, w)}{\partial(x, y, z)} = \pm abc.$$

If dn_1, dn_2, dn_3 be differentials on the three normals to the three surfaces through (u, v, w) , show that

$$Adu = dn_1, \quad Bdv = dn_2, \quad Cdw = dn_3.$$

5. If $V = f(x, y, z) = \phi(u, v, w)$, show that

$$V_x^2 + V_y^2 + V_z^2 = a^2 V_u^2 + b^2 V_v^2 + c^2 V_w^2,$$

$$\nabla^2 V = abc \left\{ \left(\frac{a}{bc} V_u \right)_u + \left(\frac{b}{ca} V_v \right)_v + \left(\frac{c}{ab} V_w \right)_w \right\}.$$

Apply these results when u, v, w are spheric coordinates.

6. If $\frac{x^2}{a^2+u} + \frac{y^2}{b^2+u} + \frac{z^2}{c^2+u} = 1$, and so for v and w , then these three conicoids are confocal: an ellipsoid, an hyperboloid, and its conjugate, and they are at right angles at every intersection. Prove

$$x^2 = (a^2 + u)(a^2 + v)(a^2 + w)/(a^2 - b^2)(a^2 - c^2), \text{ etc. ;}$$

$$\frac{1}{4}A^2 = (a^2 + u)(b^2 + u)(c^2 + u)/(u - v)(u - w), \text{ etc.}$$

Show that the central normals on the three planes tangent at (u, v, w) are the halves of the a, b, c of Ex. 4.

7. Find the area of an ellipse by cutting it up into elements by radii and concentric similar ellipses.

If $\frac{x^2}{a^2} + \frac{y^2}{b^2} = 1$ be the E , then $\frac{x^2}{a^2 u^2} + \frac{y^2}{b^2 u^2} = 1$ is a similar concentric E , and $y = \frac{b}{a} \tan v \cdot x$ is a radius. Also $x = au \cos v, y = bu \sin v$ for any such E . Hence

$$J(x, y; u, v) = abu;$$

hence

$$\text{Area} = ab \int_0^{2\pi} \int_0^1 u du dv = 2\pi ab \int_0^1 u du = \pi ab.$$

8. Find the same area, dividing it by confocal E 's and H 's.

The equation of a confocal E is $\frac{x^2}{u^2 + a^2 e^2} + \frac{y^2}{u^2} = 1$, where

$2u$ is the minor axis of the confocal, and e is the eccentricity of the given E . Also

$$x = \sqrt{u^2 + a^2e^2} \cdot \cos v, \quad y = u \cos v;$$

and a confocal hyperbola is

$$\frac{x^2}{a^2e^2(\cos v)^2} - \frac{y^2}{a^2e^2(\sin v)^2} = 1.$$

Hence $J(x, y; u, v) = \{u^2 + a^2e^2(\sin v)^2\} / \sqrt{u^2 + a^2e^2}$, and

$$\text{Area} = \int_0^b \int_0^{2\pi} J \, du \, dv = \pi \int_0^b \frac{2u^2 + a^2e^2}{\sqrt{u^2 + a^2e^2}} \, du = \pi ab.$$

Draw diagrams illustrating (7) and (8).

9. By analogous methods find volume of ellipsoid.
10. Find area cut out of the paraboloid of revolution $\frac{x^2}{a} + \frac{y^2}{b} = 2z$ by the elliptic cylinder $\frac{x^2}{a^2} + \frac{y^2}{b^2} = c^2$.

Choosing x and y as independents we must integrate

$$\sqrt{1 + z_x^2 + z_y^2} \equiv \sqrt{1 + \frac{x^2}{a^2} + \frac{y^2}{b^2}}.$$

Put $x = cau \cos v$, $y = cbu \sin v$, so that $J = abc^2u\sqrt{1 + c^2u^2}$,

$$\begin{aligned} \text{Area} &= abc^2 \int_0^1 \int_0^{2\pi} u\sqrt{1 + c^2u^2} \, du \, dv = 2\pi abc^2 \int_0^1 u\sqrt{1 + c^2u^2} \, du \\ &= \frac{2}{3}\pi ab \{(1 + c^2)^{\frac{3}{2}} - 1\}. \end{aligned}$$

11. Find area of the skew quadrilateral formed by two pairs of right lines on the hyperbolic paraboloid $z = xy$.

The quadrilateral is cut out by two planes, $x = a$, $x = a'$, parallel to YZ , and two others, $y = b'$, $y = b$, parallel to ZX . Take as new origin the point $(a', b', 0)$ and reckon

$$\int_0^a \int_0^{b'} \sqrt{1 + x^2 + y^2} \, dx \, dy.$$

12. Find the volume bounded by the circular cylinders $x^2 + y^2 = a^2$ and $x^2 + z^2 = a^2$, and the surface of each inside the other.
- Ans.*— $\frac{1}{3}6a^3$, $8a^2$.

13. Find the volume bounded by

$$\left(\frac{x}{a}\right)^{\frac{2}{3}} + \left(\frac{y}{b}\right)^{\frac{2}{3}} + \left(\frac{z}{c}\right)^{\frac{2}{3}} = 1.$$

Put $x = a(\cos u \sin v)^3$, $y = b(\sin u \sin v)^3$, $z = c(\cos v)^3$,

then $J = 9ab(\sin u \cos u)^2(\sin v)^5 \cos v$,

the extremes for both u and v are 0 and $\pi/2$, and the volume is repeated in each octant. *Ans.*— $\frac{3}{5}$ of circumscribed ellipsoid. Into what quadrilaterals do the curves $u = \text{const.}$, $v = \text{const.}$ cut up the plane XY ?

14. Find the quadratic moment as to its axes of a homogeneous ellipsoid $\frac{x^2}{a^2} + \frac{y^2}{b^2} + \frac{z^2}{c^2} = 1$.

For the quadratic moment A , B , C as to YZ , ZX , XY we have

$$A = \iiint x^2 dx dy dz.$$

the density being 1. The extremes are not constant (Art. 253); to make them constant we introduce new variables by the relations

$$x = au, \quad y = bv\sqrt{1-u^2}, \quad z = cw\sqrt{(1-u^2)(1-v^2)},$$

then $J = abc(1-u^2)\sqrt{1-v^2}$,

and the extremes are $(-1, 1)$, $(-1, 1)$, $(-1, 1)$.

$$A = a^3bc \int_{-1}^1 \int_{-1}^1 \int_{-1}^1 u^2(1-u^2)\sqrt{1-v^2} du dv dw = \frac{4}{15}\pi a^3bc = \frac{a^2}{5}M.$$

So $B = \frac{b^2}{5}M$, $C = \frac{c^2}{5}M$, and the axial moments are

$$\frac{b^2 + c^2}{5}M, \quad \frac{c^2 + a^2}{5}M, \quad \frac{a^2 + b^2}{5}M.$$

15. Determine the same moment when only similar concentric coaxial laminae are homogeneous, *i.e.*,

$$\delta = \frac{x^2}{l^2} + \frac{y^2}{m^2} + \frac{z^2}{n^2}.$$

Here $A = \iiint x^2 \delta dx dy dz$, and proceeding as before we find

Moment as to X

$$= \frac{4}{15} \pi abc \left\{ \frac{a^2}{l^2} (b^2 + c^2) + 3 \left(\frac{b^4}{m^2} + \frac{c^4}{n^2} \right) + b^2 c^2 \left(\frac{1}{m^2} + \frac{1}{n^2} \right) \right\}.$$

Apply method of (14) to find volume of ellipsoid.

16. Show that the area of $(x^2 + y^2 + z^2)^2 = a^2(x^2 - y^2)$ is $\frac{1}{2} \pi^2 a^2$, and describe the surface geometrically. Use spherical coordinates.

17. Enneper's *Minimal Surface* has the equations

$$x = u^3 - 3uv^2 - 3u, \quad y = 3u^2 - 3v^2, \quad z = v^3 - 3uv^2 - 3v;$$

show that the rectangle of the four lines of curvature, $u = 1$, $u = 2$, and $v = 3$, $v = 4$, has an area $2252\frac{3}{5}$.

18. Show that the *centre of pressure* on a circular disc just submerged vertically is $\frac{1}{4}r$ below its centre.

We have

$$\bar{x} = \frac{\iint x \cdot x dx dy}{\iint x dx dy},$$

the vertical diameter and the horizontal tangent being X and Y , and the integration being extended over the circle.

19. Show that the Newtonian attraction of a homogeneous spherical shell, on a mass-point without it, is the same as if the mass of the shell were at its centre.

Let P be the point of unit-mass, O the centre of the shell, and consider any zone-element cut out by planes perpendicular to OP . Let a = radius of shell, $c = OP$, $r = PZ$ = distance of zone from P , $\theta = POZ$, $\phi = OPZ$. Then plainly the components of attraction perpendicular to OP annul each other in pairs, the resultant is along PO . The mass of the zone for $\delta = 1$ is $2\pi a^2 \sin \theta d\theta$, its total attraction is $2\pi a^2 \sin \theta d\theta / r^2$, the component C along PO is $2\pi a^2 \sin \theta \cos \phi d\theta / r^2$, and this must be integrated

from $\theta = 0$ to $\theta = \pi$. Also

$$r^2 = c^2 + a^2 - 2ca \cos \theta, \quad \cos \phi = (c - a \cos \theta)/r.$$

Taking as new variable $x = a \cos \theta$ we obtain

$$C = 2\pi a^2 \int_{-a}^a \frac{(c+x)dx}{(c^2 + a^2 + 2acx)^{\frac{3}{2}}} = \frac{4\pi a^2}{c^2}.$$

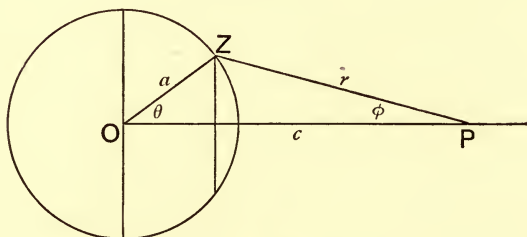

FIG. 48.

But this is the attraction of an equal mass, $4\pi a^2$, at O . Show this holds when P touches the shell outside. Also that it holds for a solid sphere composed of concentric homogeneous layers, *i.e.*, when δ varies only with the distance from the centre. Show also that the total attraction vanishes for P inside the shell, and inquire how it varies for P inside a solid sphere composed of concentric homogeneous layers.

The analogous problem for an ellipsoid composed of similar concentric coaxial homogeneous shells is interesting, important, and celebrated, but not in place here.

20. A hemisphere of radius a is bored into halves by an auger of diameter a ; show that the spherical area left is $4a^2$.
21. A smooth cylindric tree is cut down and the stroke of the axe is sloped on each side 45° to the axis of the tree; find the volume of wood and area of bark chopped away.
22. A mass is spread uniformly ($\delta=1$) over a closed surface S , inside which is a unit-mass at $U(a, b, c)$; find the total tension normal to S due to the attraction of U .

Denote by dS the element of surface, as at P , and let $UP=r$; then the normal tension at P due to U is

$\frac{\cos v}{r^2} dS$, where v is the angle UPN , and PN is the normal drawn inward. We must then reckon $\int \frac{\cos v}{r^2} dS$ over the whole of S . Draw about U a unit-sphere and lay about dS an elementary cone with vertex U ; and first suppose S simple and everywhere concave towards U . Then the integrand $\cos v/r^2$ is nothing but a Jacobian, the limit of the ratio of the surface-element to the corresponding unit-sphere-element. For a sphere-surface about U , and through P , radius r , would be sloped v to S at P , hence its element cut out by the elementary cone would be the projection of the element of S , that is, would be $\cos v dS$, and the central projection of this on the unit-sphere is $\cos v dS/r^2$. Hence to integrate this latter over S yields the same as to integrate 1 over the unit-sphere, and this latter yields the area 4π . Hence

$$\int \frac{\cos v}{r^2} dS = 4\pi.$$

Mere considerations of sign will now show that this result holds even when S is multiple or folded. Show that when U is on S the integral equals 2π , and vanishes for U without S .

If a mass M be any way distributed inside S , the total normal tension on S will be $4\pi M$. (Gauss.)

CHAPTER VIII.

PARAMETRIC DERIVATION. DEFINITE INTEGRALS AS FUNCTIONS.

268. Derivation as to Parameters.—We have seen (Art. 85), that $\int_a^a f(x)dx$ is a function of the form f , and of the extremes a and a , but not of x ; and we have learned to derive it as to a and a , though the study of a derivation as to the form f would not be in place here. If, however, $f(x)$ contain an arbitrary or *parameter* p , then $I \equiv \int f(x, p)dx$ will contain p and be a function of p , and hence in general may be derived as to p . Thus, omitting extremes, with which we have no present concern,

$$I \equiv \int x^{p-1} dx = \frac{x^p}{p}, \text{ hence } I_p = \frac{x^p}{p} \left(\log x - \frac{1}{p} \right).$$

Here we integrated and then derived, but we may derive under the integral sign and then integrate with the same result, thus:

$$I_p = \int x^{p-1} \log x dx = \frac{x^p}{p} \log x - \frac{1}{p} \int x^{p-1} dx = \frac{x^p}{p} \left(\log x - \frac{1}{p} \right).$$

So, if

$$I = \int \cos px \cdot dx, \text{ then } I_p = (px \cos px - \sin px)/p^2,$$

whether we integrate and derive, or derive and integrate. Does this commutative law hold in general?

If $\phi'(x) = f(x)$, then $I \equiv \int_a^{\alpha} \phi'(x^p) dx = \phi(\alpha, p) - \phi(a, p)$;

whence, by integrating and then deriving, we have

$$I_p = \phi_p(\alpha, p) - \phi_p(a, p) \equiv \frac{\partial}{\partial p} \left\{ \phi(x, p) \right\}_a^{\alpha}.$$

Also, by deriving and then integrating, we have

$$\begin{aligned} I_p &= \int_a^{\alpha} \left\{ \phi'(x, p) \right\}_p dx = \int_a^{\alpha} \left\{ \phi_p(x, p) \right\}' dx \\ &= \left\{ \phi_p(x, p) \right\}_a^{\alpha} = \phi_p(\alpha, p) - \phi_p(a, p). \end{aligned}$$

Symbolically,

$$D_x^{-1} \cdot D_p f(x, p) = D_p \cdot D_x^{-1} f(x, p).$$

We have found *in general* the order of derivation as to independents, and also the order of integration, interchangeable; here we find the order of the two processes, derivation and integration, likewise *in general* interchangeable. We may establish this highly important result by straightforward derivation as to the parameter, thus:

$$I \equiv \int_a^{\alpha} f(x, p) dx, \quad I + \Delta I = \int_a^{\alpha} f(x, p + \Delta p) dx;$$

$$\frac{\Delta I}{\Delta p} = \int_a^{\alpha} \frac{f(x, p + \Delta p) - f(x, p)}{\Delta p} dx = \int_a^{\alpha} \frac{\partial f(x, p)}{\partial p} dx + \int_a^{\alpha} V(\Delta p) dx,$$

where $V(\Delta p)$ is the infinitesimal vanishing with Δp . Now

in general $\int_a^{\alpha} V(\Delta p) dx$ is also infinitesimal, vanishing with

Δp ; hence, in general, on taking the limits,

$$\frac{\partial I}{\partial p} = \int_a^{\alpha} \frac{\partial f(x, p)}{\partial p} dx.$$

Of course, it is herewith assumed that $f(x, p)$ is actually derivable as to p , and $f_p(x, p)$ actually integrable as to x

throughout the range, from a to a . The figure illustrates geometrically. The change from p to $p + \Delta p$ changes the bounding curve; the waving strip is the change in I , its

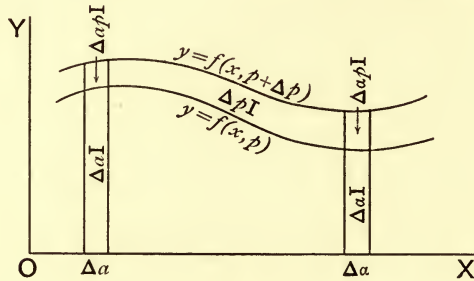

FIG. 49.

varying width is the varying Δy or Δf due to Δp . Hence the name *differentiatio de curva in curvam*. If a and a contain p , then

$$\left\{ \int_a^a f(x, p) dx \right\} = f(a, p) \frac{\partial a}{\partial p} - f(a, p) \frac{\partial a}{\partial p} + \int_a^a \frac{\partial f(x, p)}{\partial p} dx.$$

269. Integration as to Parameters.—Since $\int_a^a f(x, p) dx$ is in general a function of p , as $F(p)$, we may integrate it as to p , thus:

$$\int_b^\beta \left\{ \int_a^a f(x, p) dx \right\} dp = \int_b^\beta F(p) dp = \int_b^\beta \int_a^a f(x, p) dx dp,$$

a definite double integral, to which the discussion of double integrals applies. In particular, f being a continuous function both of x and of p , and the extremes independent constants, *the order of integration is indifferent*. Both derivation and integration as to parameters are fruitful of important results in the evaluation of integrals.

The double integral $I \equiv \int_a^a \int_b^\beta f(x, y; p) dx dy$ is plainly a function of p , and may in general be derived and

integrated as to p . The integral being geometrically a volume on a base S with varying height $z=f(x, y; p)$, the change Δp would entail a change ΔI represented geometrically by a lamina of varying thickness $\Delta_p z$ spread over the undulating top of the volume I . If the border of S be changed by the change Δp , then there would be laid round the cylindric volume a cylindric lamina of varying thickness.

EXERCISES.

1. From

$$\int_0^1 x^{p-1} dx = \frac{1}{p} \quad (p > 0),$$

prove by derivation (n times) as to p

$$\int_0^1 x^{p-1} (\log x)^n dx = (-1)^n \frac{n!}{p^{n+1}};$$

and by integrating as to p ,

$$\begin{aligned} \int_a^b dp \int_0^1 x^{p-1} dx &= \int_0^1 dx \int_a^b x^{p-1} dp \\ &= \int_0^1 \frac{x^{b-1} - x^{a-1}}{\log x} dx = \log \frac{b}{a}. \quad (a > 0, b > 0.) \end{aligned}$$

2. By deriving

$$\int_0^\infty e^{-px} dx = \frac{1}{p}$$

as to p (n times), prove

$$\int_0^\infty e^{-px} x^n dx = \frac{n!}{p^{n+1}} \quad (p > 0);$$

and by integration as to p ,

$$\int_1^p dp \int_0^\infty e^{-px} dx = \int_0^\infty dx \int_1^p e^{-px} dp = \int_0^\infty \frac{e^{-x} - e^{-px}}{x} dx = \log p.$$

3. From

$$\int_0^{\infty} \frac{dx}{x^2 + a^2} = \frac{1}{a} \cdot \frac{\pi}{2},$$

prove by deriving as to $p \equiv a^2$ that

$$\int_0^{\infty} \frac{dx}{(x^2 + a^2)^n} = \frac{1 \cdot 3 \cdot 5 \dots (2n-3)}{2 \cdot 4 \cdot 6 \dots (2n-2)} \cdot \frac{1}{a^{2n-1}} \cdot \frac{\pi}{2}.$$

4. Integrating by parts, prove that, for $a > 0$,

$$\int_0^{\infty} e^{-ax} \sin bx dx = \frac{b}{a^2 + b^2} \int_0^{\infty} e^{-ax} \cos bx = \frac{a}{a^2 + b^2}.$$

Hence by derivation and integration as to a ($a > 0$, $\beta > 0$),

$$\int_0^{\infty} e^{-ax} x \sin bx dx = \frac{2ab}{(a^2 + b^2)^2} \int_0^{\infty} e^{-ax} x \cos bx dx = \frac{a^2 - b^2}{(a^2 + b^2)^2};$$

$$\int_0^{\infty} \frac{e^{-ax} - e^{-\beta x}}{x} \sin bx dx = \tan^{-1} \frac{\beta}{b} - \tan^{-1} \frac{a}{b},$$

$$\int_0^{\infty} \frac{e^{-ax} - e^{-\beta x}}{x} \cos bx dx = \frac{1}{2} \log \frac{\beta^2 + b^2}{a^2 + b^2}.$$

The third integral is a continuous function, both of a and of β , even for a decreasing and β increasing without limit; hence for $a=0$, $\beta=\infty$,

$$\int_0^{\infty} \frac{\sin bx}{x} dx = \pm \frac{\pi}{2},$$

according as $b > 0$ or $b < 0$.

For $b=0$ every element of the \int vanishes, hence $\int=0$, so that the \int is discontinuous, making two leaps, from $-\frac{\pi}{2}$ to 0, and from 0 to $\frac{\pi}{2}$, as b changes from $-\sigma$ to 0, and from 0 to $+\sigma$.

Now put $b+a$ and $b-a$ for b , add and subtract, and prove

$$\int_0^{\infty} \frac{\cos ax \cdot \sin bx}{x} dx = \frac{\pi}{2}, \quad \int_0^{\infty} \frac{\sin ax \cdot \cos bx}{x} dx = 0, \quad (b > a)$$

and
$$\int_0^{\infty} \frac{\sin 2ax}{x} dx = \frac{\pi}{2}, \quad \text{for } b = a.$$

Note that, for $a = 0$, the resulting

$$\int_0^{\infty} \sin bx dx \quad \text{and} \quad \int_0^{\infty} \cos bx dx$$

lose all meaning, since at ∞ both sine and cosine oscillate endlessly between -1 and $+1$. But for $a > 0$ the factor e^{-ax} under the \int becomes at ∞ infinitesimal of infinite order, and multiplied into $\sin bx$ and $\cos bx$ reduces their oscillations at ∞ within $-\sigma$ and $+\sigma$, so that

$$\int_0^{\infty} e^{-ax} \sin bx dx \quad \text{and} \quad \int_0^{\infty} e^{-ax} \cos bx dx$$

are definite.

5. Prove
$$\int_0^{\infty} e^{-ax} \sin x dx = \frac{1}{a^2 + 1},$$

and then derive as to a ; also integrate as to a , and prove

$$\int_0^{\infty} \frac{1 - e^{-ax}}{x} \cdot \sin x dx = \tan^{-1} a.$$

6. Similarly prove

$$\int_0^{\infty} e^{-ax} \cos x dx = \frac{a}{a^2 + 1};$$

derive as to a , also integrate as to a , and prove

$$\int_0^{\infty} \frac{1 - e^{-ax}}{x} \cdot \cos x dx = \log \sqrt{a^2 + 1}.$$

7. Multiplying

$$\int_0^{\infty} \frac{\cos ax \cdot \sin bx}{x} dx = \frac{\pi}{2} \quad \text{by } e^{-bx},$$

and integrating as to b from 0 to ∞ , prove for all real values of a ,

$$\int_0^{\infty} \frac{\cos ax}{c^2 + x^2} dx = \frac{\pi}{2} \cdot \frac{e^{\mp ac}}{c},$$

according as $a > 0$, $a < 0$, $a = 0$.

8. Prove
$$\int_0^{\infty} \frac{x \sin ax}{c^2 + x^2} dx = \pm \frac{\pi}{2} \cdot e^{\mp ac},$$

according as $a > 0$, $a < 0$. Does this hold for $a = 0$?
Can we derive again?

Prove also, by integrating as to a , from 0 to ∞ , that

$$\int_0^{\infty} \frac{\sin ax}{x(c^2 + x^2)} dx = \pm \frac{\pi}{2c^2} (1 - e^{\mp ac}), \quad (a > 0 \text{ or } a < 0).$$

Also derive as to c ; and why not integrate as to c ?

9. $P \equiv \int_0^{\infty} e^{-x^2} dx = \int_0^{\infty} e^{-y^2} dy$ is the *probability-integral*. By Art. 261,

$$P^2 = \int_0^{\infty} e^{-x^2} dx \cdot \int_0^{\infty} e^{-y^2} dy = \int_0^{\infty} \int_0^{\infty} e^{-(x^2+y^2)} dx dy.$$

Here S is the first quadrant; for polar coordinates $J = r$, and the extremes are 0 and ∞ for r , 0 and $\frac{\pi}{2}$ for θ .

Hence

$$P^2 = \int_0^{\infty} \int_0^{\frac{\pi}{2}} e^{-r^2} r dr d\theta = \frac{\pi}{4} \int_0^{\infty} e^{-r^2} d(r^2) = \frac{\pi}{4};$$

$$P \equiv \int_0^{\infty} e^{-x^2} dx = \frac{\sqrt{\pi}}{2}, \quad 2P = \int_{-\infty}^{\infty} e^{-x^2} dx = \sqrt{\pi}.$$

Observe that $z = e^{-x^2-y^2}$ is a surface cutting Z at $z = 1$, and sinking thence symmetrically over the whole XY plane; $2P$ is numerically the area between X and $z = e^{-x^2}$, the section of this surface with XZ , and $4P^2$ the volume between this surface and XY .

10. In $2P$ put $x = u\sqrt{a}$ (a of course > 0) and prove

$$\int_{-\infty}^{+\infty} e^{-au^2} du = \sqrt{\frac{\pi}{a}}, \quad \int_{-\infty}^{+\infty} e^{-au^2} u^{2n} du = \frac{1 \cdot 3 \cdot 5 \dots (2n-1)}{(2a)^n} \cdot \sqrt{\frac{\pi}{a}}.$$

For x put $u \pm a$ and show

$$\int_{-\infty}^{+\infty} e^{-u^2 \pm 2au} du = \sqrt{\pi} e^{a^2}.$$

Put $u = v\sqrt{a}$, $b = 2a\sqrt{a}$; whence

$$\int_{-\infty}^{+\infty} e^{-av^2 \mp bv} dv = \sqrt{\pi/a} \cdot e^{b^2/4a}.$$

Multiply $\frac{1}{\sqrt{a}} = \frac{2}{\sqrt{\pi}} \int_0^{\infty} e^{-au^2} du$ by $\cos a$ and integrate as to a ; so

$$\int_0^{\infty} \frac{\cos a}{\sqrt{a}} da = \frac{2}{\pi} \int_0^{\infty} \cos a da \int_0^{\infty} e^{-au^2} du.$$

The integrand $\cos a e^{-au^2}$ is throughout continuous and vanishes in ∞ degree for $a = \infty$; hence the integrations are exchangeable; on integrating twice by parts,

$$\int_0^{\infty} e^{-au^2} \cos a da = \frac{u^2}{u^4 + 1};$$

and this integrated as to u from 0 to ∞ yields $\pi/2\sqrt{2}$ *; hence, finally,

$$\int_0^{\infty} \frac{\sin a}{\sqrt{a}} da = \sqrt{\frac{\pi}{2}}. \quad (\text{Euler.})$$

Obtain a like result on putting $\sin a$ for $\cos a$.

11. Since sine and cosine in the first quadrant range through the same values in opposite order, we have

$$\int_0^{\frac{\pi}{2}} (\cos x)^n dx = \int_0^{\frac{\pi}{2}} (\sin x)^n dx.$$

Also, since $\sin 0 = 0$ and $\cos \pi/2 = 0$, by Reduction-formula (Art. 114),

$$\int_0^{\frac{\pi}{2}} (\cos x)^n dx = \frac{n-1}{n} \int_0^{\frac{\pi}{2}} (\cos x)^{n-2} dx.$$

* By the formula $\int_0^{\infty} \frac{x^m dx}{x^n + 1} = \frac{\pi}{n} / \sin \frac{m+1}{n} \pi$, for $n > m + 1$.

For $n = 2m - 1, 2m, 2m + 1$, denote the \int by O, E, O' ; then

$$O = \frac{2m-2}{2m-1} \cdot \frac{2m-4}{2m-3} \cdots \frac{4}{5} \cdot \frac{2}{3}, \quad O' = \frac{2m}{2m+1} \cdot O,$$

$$E = \frac{2m-1}{2m} \cdot \frac{2m-3}{2m-2} \cdots \frac{1}{2} \cdot \frac{\pi}{2}.$$

Also, $0 \cong \cos x \cong 1$,

$$\therefore (\cos x)^{2m-1} > (\cos x)^{2m} > (\cos x)^{2m+1}, \quad O > E > O',$$

\therefore on substituting and dividing by the coefficient of $\pi/2$,

$$\frac{2}{1} \cdot \frac{2}{3} \cdot \frac{4}{3} \cdots \frac{2m}{2m-1} > \frac{\pi}{2} > \frac{2}{1} \cdot \frac{2}{3} \cdot \frac{4}{3} \cdots \frac{2m}{2m-1} \cdot \frac{2m}{2m+1}.$$

Here $\pi/2$ is shut in between two continued products that differ only by the factor $2m/(2m+1)$; as m increases without limit this factor converges upon 1, the products close down upon each other and upon $\pi/2$ always between them; hence

$$\frac{\pi}{2} = \text{Lim} \left(\frac{2}{1} \cdot \frac{2}{3} \cdot \frac{4}{3} \cdot \frac{4}{5} \cdot \frac{6}{5} \cdot \frac{6}{7} \cdots \text{in infinitum} \right).$$

This remarkable result, obtained by Wallis, is given here as the first example of a number expressed through an infinite product, a form of expression now common in Higher Analysis.

270. The function Γ or Π .—For $p=1$, the result in Ex. 2, Art. 269, takes the form:

$$\int_0^{\infty} e^{-x} x^n dx = \lfloor n,$$

n a positive integer. But even for n not integral, on integrating by parts,

$$\int_0^{\infty} e^{-x} x^n dx = \left\{ -e^{-x} x^n \right\}_0^{\infty} + n \int_0^{\infty} e^{-x} x^{n-1} dx = n \int_0^{\infty} e^{-x} x^{n-1} dx.$$

The two integrals have the same form, differing only by the factor n . It was Euler who first perceived the importance of this form, and treated it as a function of n ; Legendre named it accordingly *Eulerian Integral of second species*, and denoted the latter integral above by $\Gamma(n)$ (read *Gamma-Function of n*), so that the first would be $\Gamma(n+1)$, and the relation holds:

$$\Gamma(n+1) = n\Gamma(n).$$

But a more convenient equivalent is the Gaussian

$$\Pi(n) = \int_0^{\infty} e^{-x} x^n dx,$$

so that $\Gamma(n+1) = \Pi(n) = n\Pi(n-1)$.

Both Euler and Lagrange preferred

$$\Gamma(n) = \int_0^1 \left(\log \frac{1}{u}\right)^{n-1} du,$$

obtained by putting u for e^{-x} , but for most purposes the original form is better. For $x^n = v$,

$$\Gamma(n) = \frac{1}{n} \int_0^{\infty} e^{-v^{\frac{1}{n}}} dv,$$

whence $\Gamma(\frac{1}{2}) = 2 \int_0^{\infty} e^{-v^2} dv = \sqrt{\pi} = \Pi(-\frac{1}{2})$.

For n negative $\Gamma(n)$, thus defined, becomes ∞ .

271. Fundamental properties of Γ and Π .—This integral is like a *factorial*, since $\lfloor n = n \lfloor n - 1$, but the factorial loses all sense for fractional arguments, whereas

$$\Gamma(\frac{1}{2}) = \sqrt{\pi} = \Pi(-\frac{1}{2}),$$

so that Γ or Π may be considered as the *generalized factorial*. By means of this *factorial property* we may find $\Gamma(n)$ for any positive n , knowing $\Gamma(n)$ for $0 < n \leq 1$, thus:

$$\begin{aligned} \Gamma(\frac{7}{2}) &= \Gamma(\frac{5}{2} + 1) = \frac{5}{2} \Gamma(\frac{3}{2} + 1) \\ &= \frac{5}{2} \cdot \frac{3}{2} \Gamma(\frac{1}{2} + 1) = \frac{5}{2} \cdot \frac{3}{2} \cdot \frac{1}{2} \Gamma(\frac{1}{2}) = \frac{15}{8} \sqrt{\pi}. \end{aligned}$$

Moreover, if n be a proper fraction, so is $1-n$, and

$$\Gamma(1-n) = \int_0^{\infty} e^{-y} y^{-n} dy,$$

$$\Gamma(n) \cdot \Gamma(1-n) = \int_0^{\infty} \int_0^{\infty} e^{-x-y} x^{n-1} y^{-n} dx dy.$$

We may transform this \iint by a substitution of Jacobi's, useful in dealing with definite integrals: $x+y=u$, $y=uv$: whence

$$\begin{aligned} J=u, \quad \Gamma(n)\Gamma(1-n) &= \int_0^{\infty} \int_0^1 e^{-uv} v^{-n} (1-v)^{n-1} du dv \\ &= \int_0^1 v^{-n} (1-v)^{n-1} dv = 2 \int_0^{\pi/2} (\tan \theta)^{1-2n} d\theta, \quad (v = \sin^2 \theta). \end{aligned}$$

Since $1-2n$ is not integral, there is no very simple way to evaluate this integral; the following seems good as any:

Consider

$$I \equiv \int \frac{x^{m-1} dx}{x^n + e^{ai}}, \quad \text{for } n > m-1, \quad \pi \equiv a \geq -\pi.$$

Resolve $x^n + e^{ai}$ into n factors $x-r_1, x-r_3, \dots, x-r_{2n-1}$, where

$$r_k = e^{i \frac{a+\pi k}{n}} = e^{ip_k} = \cos p_k + i \sin p_k, \quad \text{for } k=1, 3, 5 \dots 2n-1.$$

$$\frac{x^{m-1}}{x^n + e^{ai}} = \frac{A_1}{x - e^{ip_1}} + \frac{A_3}{x - e^{ip_3}} + \dots + \frac{A_{2n-1}}{x - e^{ip_{2n-1}}}.$$

Hence $nA_k = e^{i(m-n)p_k} = -e^{(a-1)ai} \cdot e^{\pi aik}$, ($a = m/n$).

Hence

$$nI = -e^{(a-1)ai} \cdot \{e^{\pi ai} \log(x - e^{ip_1}) + e^{3\pi ai} \log(x - e^{ip_3}) + \dots\} + C.$$

Now if $u+iv$ be any complex number, we have

$$u = \rho \cos \phi, \quad v = \rho \sin \phi, \quad u+iv = \rho e^{i\phi}, \quad \rho^2 = u^2 + v^2, \quad \phi = \tan^{-1} \frac{v}{u}.$$

Hence $\log(u+iv) = \log \rho + i\phi = \frac{1}{2} \log(u^2 + v^2) + i \tan^{-1} \frac{v}{u}$.

Hence $\log(x - e^{ip_k}) = \log(x - \cos p_k - i \sin p_k)$

$$= \frac{1}{2} \log(x^2 - 2x \cos p_k + 1) - i \tan^{-1} \frac{\sin p_k}{x - \cos p_k} = U_k - i V_k.$$

We must evaluate I between 0 and ∞ . The U 's and V 's remain continuous throughout this range of integration; each U vanishes for $x=0$, but increases continuously with x . However,

$$x^2 - 2x \cos p_k + 1 = x^2 \{1 - (2x \cos p_k - 1)/x^2\},$$

$$\therefore U_k = \log x + \frac{1}{2} \log \{1 - (2x \cos p_k - 1)/x^2\}.$$

Hence, on summing the U 's, the multiplier of $\log x$

$$= e^{\pi a i} + e^{3\pi a i} + \dots + e^{(2n-1)\pi a i} = e^{\pi a i} \cdot \frac{1 - e^{2n\pi a i}}{1 - e^{2\pi a i}} = 0,$$

since $na = m$ and $e^{2m\pi i} = 1$ for m an integer; hence the multiplier of $\log x$ vanishes absolutely throughout the range of integration, the total contribution of the integrals of $\log x$ is 0. But for $m = n$, a would = 1, the divisor $1 - e^{2\pi a i}$ would = 0, and our conclusion would fail; in fact, the integral would = ∞ . Neither would $1 - e^{2m\pi i} = 0$ for m not integral; hence, at most, $m = n - 1$. Also the other part of U_k , $\frac{1}{2} \log \{ \}$, manifestly vanishes for $x = \infty$; hence the total contribution to I made by the U 's is 0.

As for the V 's, it is readily seen that $p_k < 2\pi$, that each V is continuous, and becomes = ± 0 for $x = \infty$, and that V_k becomes = $-p_k$ for $x = 0$. Hence

$$\left\{ I \right\}_0^\infty = \frac{i}{ne^{ai}} \Sigma (p_k \mp 0) \cdot e^{imp_k}, \text{ where } k = 1, 3, 5, \dots, 2n - 1.$$

To calculate $\Sigma \frac{\alpha + k\pi}{n} \cdot e^{\frac{\alpha + k\pi}{n} mi}$, we observe that this type-term is the derivative as to mi of $e^{\frac{\alpha + k\pi}{n} mi}$; hence this Σ is the derivative as to mi of $\Sigma_1 e^{\frac{\alpha + k\pi}{n} mi}$; and this

$$\Sigma_1 = e^{\frac{(\alpha + \pi)mi}{n}} \left\{ \frac{e^{2\pi mi} - 1}{\frac{2\pi mi}{n} - 1} \right\} = M \cdot \frac{N}{D}$$

To find Σ we derive this Σ_1 as to mi , and denoting such derivation by ', we have

$$\Sigma = M' \cdot \frac{N}{D} + M \cdot \frac{N'}{D} - M \cdot \frac{N \cdot D'}{D^2}, \text{ which } = \frac{MN'}{D};$$

since, for m an integer, $N=0$. Hence

$$\Sigma = e^{\frac{(\alpha+\pi)mi}{n}} \cdot 2\pi \cdot \frac{1}{e^{\frac{2\pi mi}{n}} - 1} = -i \cdot e^{\frac{\alpha mi}{n}} \cdot \frac{\pi}{\sin \frac{m\pi}{n}}.$$

Hence

$$\int_0^\infty \frac{x^{m-1}}{x^n + e^{\alpha i}} dx = \frac{\pi}{n \sin \frac{m\pi}{n}} \cdot e^{\left(\frac{m}{n}-1\right)\alpha i},$$

Putting $u = x^n$, $a = m/n$, we get

$$\int_0^\infty \frac{u^{a-1}}{u + e^{\alpha i}} du = \frac{\pi}{\sin a\pi} \cdot e^{(a-1)\alpha i},$$

a result fundamental for the doctrine of definite integrals.

Thus far a has been a positive proper *fraction*; but if a be *irrational*, it will lie between two such fractions, $\frac{w}{v}$ and $\frac{w+1}{v}$, and the value of the integral will lie between two integrals, evaluated as above, corresponding to these fractions; and by closing down the fractions upon the irrational a as their common limit, we may close down the two integrals evaluated as above upon their common limit, of the form given above, even for a irrational.

For $a=0$, and $u=(1-v)/v$, the equation above takes the form

$$\int_0^1 \frac{(1-v)^{a-1}}{v^a} dv = \frac{\pi}{\sin a\pi};$$

hence finally

$$\int_0^1 v^{-n}(1-v)^{n-1} dv = \Gamma(n)\Gamma(1-n) = \frac{\pi}{\sin n\pi} = 2 \int_0^{\pi/2} (\tan \theta)^{1-2n} d\theta,$$

one of the most beautiful, remarkable, and important of Euler's discoveries.

272. **First Eulerian Integral.**—On writing $x = u^2$,

$$\int_0^\infty e^{-x} x^{m-1} dx = \Gamma(m) = 2 \int_0^\infty e^{-u^2} u^{2m-1} du,$$

$$\int_0^\infty e^{-y} y^{n-1} dy = \Gamma(n) = 2 \int_0^\infty e^{-v^2} v^{2n-1} dv.$$

Hence

$$\Gamma(m) \cdot \Gamma(n) = 4 \int_0^\infty \int_0^\infty e^{-(u^2+v^2)} u^{2m-1} v^{2n-1} du dv.$$

Pass to polar coordinates; then $J = r$, and we have

$$\Gamma(m) \cdot \Gamma(n) = 2 \cdot 2 \int_0^\infty e^{-r^2} r^{2(m+n)-1} dr \cdot \int_0^{\pi/2} \cos \theta^{2m-1} \sin \theta^{2n-1} d\theta.$$

The first integral, $2 \int_0^\infty \dots dr$, is $\Gamma(m+n)$; hence

$$\begin{aligned} \Gamma(m) \cdot \Gamma(n) / \Gamma(m+n) &= 2 \int_0^{\pi/2} \cos \theta^{2m-1} \sin \theta^{2n-1} d\theta \equiv B(m, n) \\ &= B(n, m), \end{aligned}$$

the value being unaffected by exchange of m and n .

This B , named (by Legendre) *First Eulerian Integral*, is thus expressible through three Γ 's. For $x = \cos^2 \theta$ it takes the form

$$B(m, n) = \int_0^1 x^{m-1} (1-x)^{n-1} dx = \int_0^1 x^{n-1} (1-x)^{m-1} dx = B(n, m).$$

Just as the relation $\cos a = \sin(\pi/2 - a)$ reduces the calculation of sine and cosine for the first quadrant down to the calculation of them for the first octant, so the second fundamental relation

$$\Gamma(n) \Gamma(1-n) = \pi / \sin n\pi$$

reduces the calculation of $\Gamma(n)$, for n between 0 and 1, down to the calculation for n between 0 and $\frac{1}{2}$; and a table of Γ 's for this range of argument-value enables us to find Γ for any positive argument. Further discussion

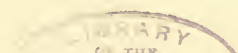

of these Eulerians and actual calculation would lead beyond the range of this volume, into the Doctrine of Infinite Products; but it may be well to remark that a definition of Γ by help of this doctrine will give the function a meaning even for negative arguments.

EXERCISES.

1. Translate foregoing properties of Γ into properties of Π .

2. Find area bounded in 1st quadrant by $x^{\frac{1}{m}} + y^{\frac{1}{n}} = a^{\frac{1}{n}}$.

Hint: Put $x = a(\sin \theta)^{2n}$. *Ans.* $\frac{1}{2}na^2(\Gamma n)^2/\Gamma 2n$.

3. Find centroid of that area. $\bar{x} = \bar{y} = \frac{2}{3}a(\Gamma 2n)^2/\Gamma 3n$.

4. Find volume in 1st quadrant bounded by

$$\left(\frac{x}{a}\right)^{\frac{1}{m}} + \left(\frac{y}{b}\right)^{\frac{1}{n}} + \left(\frac{z}{c}\right)^{\frac{1}{p}} = 1,$$

and centroid of that volume.

Ans. $V = abc\Pi m \cdot \Pi n \cdot \Pi p / \Pi(m+n+p)$;

$\bar{x}V = \Pi 2m \cdot \Pi n \cdot \Pi p / \Pi(2m+n+p)$.

5. Generalize the property

$$\int_0^1 x^{m-1}(1-x)^{n-1}dx = \Gamma m \cdot \Gamma n / \Gamma(m+n)$$

into the theorem of Dirichlet:

If $I \equiv \iiint \dots x_1^{a_1-1} x_2^{a_2-1} \dots dx_1 dx_2 \dots$, where the integration extends throughout the region where

$$(x_1 a_1)^{p_1} + (x_2 a_2)^{p_2} + \dots \leq 1,$$

and the x 's, a 's, α 's, and p 's are all positive, then

$$I = \frac{p_1 \cdot p_2 \dots p_n}{a_1^{a_1} \cdot a_2^{a_2} \dots a_n^{a_n}} \cdot \frac{\Gamma p_1 a_1 \cdot \Gamma p_2 a_2 \dots \Gamma p_n a_n}{\Gamma(p_1 a_1 + p_2 a_2 + \dots p_n a_n + 1)}.$$

We make the border condition linear by the substitution

$$x_1 a_1 = u_1^{p_1}, \quad x_2 a_2 = u_2^{p_2}, \quad \text{etc.};$$

then $u_1 + u_2 + \dots + u_n \leq 1$ is the condition. Also

$$x^a \alpha^a = u^{pa}, \quad x^{a-1} dx = \frac{p}{\alpha^a} \cdot u^{pa-1} du,$$

for each index 1, 2, ..., n . Hence

$$I = \frac{p_1 \cdot p_2 \cdots p_n}{\alpha_1^{a_1} \cdot \alpha_2^{a_2} \cdots \alpha_n^{a_n}} \cdot \iint \dots \int u_1^{p_1 a_1 - 1} \cdot u_2^{p_2 a_2 - 1} \dots du_1 du_2 \dots$$

The extremes are determined by $u_1 + u_2 + \dots + u_n \leq 1$; hence they are: for u_n , 0 and $1 - u_1 - u_2 \dots - u_{n-1}$; for u_{n-1} , 0 and $1 - u_1 - u_2 \dots - u_{n-2}$, etc.; for u_1 , 0 and 1. The variability of these extremes complicates the problem excessively, but we can make the extremes constant by introducing a new set of variables by the equations:

$$u_1 = v_1, \quad u_2 = (1 - v_1)v_2, \quad u_3 = (1 - v_1)(1 - v_2)v_3, \quad \dots, \\ u_n = (1 - v_1)(1 - v_2) \dots (1 - v_{n-1})v_n.$$

In the Jacobian of this substitution all the elements on one side of the diagonal are 0, since u_1 contains only v_1 , u_2 only v_1 and v_2 , etc.; hence

$$J = \text{diagonal term} = (1 - v_1)^{n-1} (1 - v_2)^{n-2} \dots (1 - v_{n-1}).$$

The extremes for each v are now 0 and 1, as we easily prove step by step, beginning at v_1 , thus: for $u_1 = 0$ and 1, $v_1 = 0$ and 1; for $u_2 = 0$, $v_2 = 0$, and for $u_2 = 1 - u_1 = 1 - v_1$, $v_2 = 1$, etc. This substitution is suggested by the case of two variables, is extended by analogy, and is tested as above.

On substituting in I , the extremes become these constants 0 and 1, the integrations are independent of each other, and the integral of the product becomes the product of the integrals as to each of the v 's. We begin with the integration in v_n :

$$\int_0^1 v_n^{t_n - 1} (1 - v_n)^{1 - 1} dv_n = \frac{\Gamma 1 \cdot \Gamma t_n}{\Gamma(t_n + 1)}, \quad \text{where } t = pa;$$

$$\int_0^1 v_{n-1}^{t_{n-1} - 1} (1 - v_{n-1})^{t_n} dv_{n-1} = \frac{\Gamma t_{n-1} \cdot \Gamma(t_n + 1)}{\Gamma(t_{n-1} + t_n + 1)}; \quad \text{and so on.}$$

On forming the product all the denominators *but the last* are cancelled by factors in the numerator, and we obtain the result enounced.

6. Write the border condition ..

$$w \equiv (x_1 a_1)^{\frac{1}{p_1}} + \dots + (x_n a_n)^{\frac{1}{p_n}} \leq h,$$

form the new integral

$$I' = \int \dots \int x_1^{a_1-1} \dots x_n^{a_n-1} f(w) dx_1 \dots dx_n,$$

and prove by reasoning like the foregoing:

$$I' = I \cdot \int_0^h f(w) w^{p_1 a_1 + \dots + p_n a_n - 1} dw. * \quad (\text{Liouville.})$$

7. Use Dirichlet's theorem in quadrature of ellipse and cubature of ellipsoid.

8. Use Liouville's extension to find mass of unit-sphere composed of homogeneous concentric spherical shells of varying radius r , the density varying as $1/\sqrt{1-r^2}$.

We must integrate $1/\sqrt{1-x^2-y^2-z^2}$ throughout the region where $x^2+y^2+z^2 \leq 1$, and for the first octant,

$$I = (\Gamma_{\frac{1}{2}})^3 / 8\Gamma_{\frac{3}{2}} = \pi/4.$$

The integral multiplier of I is $\int_0^1 \frac{\sqrt{w}}{\sqrt{1-w}} dw = \pi/2$; hence $I' = \frac{\pi^2}{8} = \frac{M}{8}$. Generalize this for n variables.

9. Prove $\int_0^1 x^{m-1} (-\log x)^{n-1} dx = \Gamma n / m^n$. (Put $u = x^m$.)

10. Prove $\int_0^1 \frac{x^{m-1}(1-x)^{n-1}}{(x+a)^{m+n}} dx = B(m, n) / a^n (1+a)^m$. (Abel.)

* I is here the same as in (5), but with the +1 omitted from the argument of Γ in the denominator.

11. Prove $\int_0^{\infty} \frac{x^{a-1}}{(1+x)^b} dx = B(a, b-a)$, for $b > a$. (Put $x = \frac{1}{u} - 1$.)

12. Prove $\Gamma r \cdot \Gamma(2r) \cdot \Gamma(3r) \dots \Gamma(1-r) = (2\pi)^{\frac{1}{2}(\frac{1}{r}-1)} r^{\frac{1}{2}}$, for $r = \frac{1}{n}$.

Employ $\Gamma r \cdot \Gamma(1-r) = \pi/\sin r\pi$; remember

$$\frac{\sin nz}{\sin z} = 2^{n-1} \sin\left(\frac{\pi}{n} - z\right) \sin\left(\frac{\pi}{n} + z\right) \sin\left(\frac{2\pi}{n} - z\right) \sin\left(\frac{2\pi}{n} + z\right) \dots,$$

the last pair of factors being

$$\sin\left(\frac{\pi}{2} \pm z\right) \text{ or } \sin\left(\frac{n-1}{2n}\pi \pm z\right),$$

according as n is even or odd; and put $z=0$.

CHAPTER IX.

CURVE TRACING.

273. This extensive, difficult, and important subject can be treated here not adequately, but only in measure to meet the more frequent needs of the student.

Given the equation of a curve, we may inquire :

A. What is its general course? How shall we draw it roughly?

B. How is it to be drawn, how does it behave, in the vicinity of certain critical points?

C. How is it to be drawn towards infinity?

We answer A. by several observations as determinations, like the following, made in any order :

1. Its intercepts on X resp. Y are found by equating y resp. x to 0, and solving the resulting equation for x resp. y ; approximate roots suffice.

2. If the exponents of x resp. y be all *even*, then the curve is symmetric as to Y resp. X ; if the exponents of both x and y be all even, then it is symmetric as to both Y and X ; if all the terms be of even or all of odd degree, then if (x, y) be on the curve so is $(-x, -y)$, and the curve is symmetric as to the origin, in opposite quadrants (*e.g.* $xy=a^2$), the origin bisects every chord through it and is the *centre* of the curve; if the equation be symmetric *as to x and y* , not changing when x and y are exchanged, then the curve is symmetric as to the line $y=x$; if, on changing y into $-y$, the equation becomes symmetric as to x and y , then the curve is symmetric as

to $x = -y$; and other symmetries may sometimes be detected by simple transformations.

3. Find *maxima* and *minima* of y resp. x , where the tangent is parallel to X resp. Y , by equating y_x resp. x_y to 0. Herewith the concavity resp. convexity of the curve will be determined in certain vicinities.

4. Determine any points of **inflexion**, where the curve changes from convex to concave, and *vice versa*; at such points d^2y/dx^2 must change sign, and in general vanish.

5. If convenient, solve the equation as to x or y or each, notice how either coordinate changes as the other changes, and for what value or values (if any) of either the other becomes imaginary; *loops* may often be thus detected.

6. If the form of the curve be not revealed by any such considerations, it may be well to pass to polars by the relations $x = \rho \cos \theta$, $y = \rho \sin \theta$; or a change of origin or axes may be helpful.

274. Arrangement of Terms.—In order to study the rational integral algebraic curve $F(x, y) = 0$ in the neighbourhood of critical points, it is generally best to collect terms of the same degree, and express $F(x, y)$ as a sum of binary quantics, thus :

$$F(x, y) = u_0 + u_1 + u_2 + u_3 + \dots + u_n,$$

where

$$u_0 = a_0, \quad u_1 = a_1x + b_1y, \quad u_2 = a_2x^2 + 2b_2xy + c_2y^2,$$

$$u_3 = a_3x^3 + 3b_3x^2y + 3c_3xy^2 + d_3y^3,$$

and so on. For $x = \rho \cos \theta$, $y = \rho \sin \theta$ these become

$$\phi(\rho, \theta) = v_0 + v_1 + v_2 + v_3 + \dots + v_n,$$

where

$$v_0 = a_0, \quad v_1 = \rho(a_1 \cos \theta + b_1 \sin \theta),$$

and so on.

If the critical point be the origin, then $a_0 = 0$; if it be not the origin, transfer the origin to it; we may

suppose this done and accordingly omit u_0 . Then $u_1=0$ or $v_1=0$, $u_2=0$ or $v_2=0$, and so on, are all equations of right lines through the origin O , being homogeneous in x and y ; also $u_1=0$ or $v_1=0$, $u_1+u_2=0$ or $v_1+v_2=0$, $u_1+u_2+u_3=0$ or $v_1+v_2+v_3=0$, etc., are curves of 1st, 2nd, 3rd degrees, etc., through the origin O and closely touching the curve in question. Of these, $u_1=0$ or $v_1=0$ is the right line tangent at the origin; for on combining this equation with $F(x, y)=0$ or $\phi(\rho, \theta)=0$, we see that the resulting equation has two roots $=0$ in x , or in y , or in ρ , as the case may be; that is, $u_1=0$ or $v_1=0$ meets $F=0$ or $\phi=0$ at O in *two* points, or is tangent. Similarly, the conic $u_1+u_2=0$ or $v_1+v_2=0$ meets the curve at O in *three* consecutive points, and is hence called *osculating conic*; like remarks apply to the cubic, quartic, etc.

275. Nodes.—If $u_1=0=v_1$, then the equation $F=0=\phi$ begins with u_2 or v_2 , that is, with terms of 2nd degree; then $u_2=0$ or $v_2=0$ is the equation of a *pair of right lines tangent* to the curve at O . The factors of u_2 may be real and unequal, when the tangents are real and separate; or real and equal, when the tangents are real and coincident; or imaginary, when the tangents are imaginary; according as the *discriminant* of u_2 , namely $b_2^2 - a_2c_2$ is >0 , or $=0$, or <0 . In the first case two *branches* of the curve pass through O , the generating point passes through O twice, the point O is a *double point* or *crunode* of the curve; in the second case, two branches of the curve reach but do not in general pass through O , the generating point attains the position O but retires from it on the same tangent, the origin O is a *cusp* or *spinode*; in the third case no contiguous points of the curve lie about O , the generating point attains the position O discontinuously, along no path, the origin O is an *isolated* or *conjugate point* or *acnode*.

276. Plücker's Method.—Perhaps clearer notions may be obtained thus: Suppose a point to *glide along* a right line while the right line *turns about* the point; then the point *traces* a curve, and the right line *envelopes* (as tangent) the same curve. If Δs be the change in arc-length, corresponding to $\Delta \tau$, the change in direction of the tangent, or the angle through which the right line turns while the point traces Δs , then, as we know, $\Delta \tau / \Delta s = \text{average curvature}$, and $d\tau / ds = \text{instantaneous curvature}$.

Now at a *point of inflexion* the generating point glides still along the right line in the same sense, but the right line stops turning in one sense and begins to turn in the opposite sense; at a *cusp* the right line keeps on turning in the same sense, but the generating point stops moving in one sense along the right line and begins to move in the opposite sense.

A relation connecting s and τ , telling how the point glides as the line turns, is called the **intrinsic equation** of the curve, since it contains no reference to *extrinsic* coordinate axes or the like, but determines the curve by its inner nature. Such equations are often useful.

277. Multiple Points.—Returning from this digression we remark that if $u_1 = 0$ and $u_2 = 0$ ($v_1 = 0 = v_2$), then $F = 0 = \phi$ begins with u_3 or v_3 with terms of 3rd degree. Hence three values of ρ , each $= 0$, will satisfy $\phi = 0$, or three pairs of 0-values of x and y satisfy $F = 0$; that is, the origin O is a *triple point* of the curve. Also, $u_3 = 0$ is the equation of *three right lines* tangent at O , real and separate, or (two or more) coincident or (two) imaginary, according to the discriminant of u_3 . We may extend this reasoning to multiple points of any order.

In order to detect such points in the first place, we observe that y_x must lose its uniqueness where there exist

more than one tangent. Accordingly, we write off the system

$$F=0, F_x+F_y \cdot y_x=0, \dots\dots\dots(1)$$

$$F_{xx}+2F_{xy} \cdot y_x+F_{yy} \cdot y_x^2+F_y \cdot y_{xx}=0 \\ = (F_x+F_y \cdot y_x)^2+F_y \cdot y_{xx}, \dots\dots\dots(2)$$

$$(F_x+F_y \cdot y_x)^3+3(F_{xy}+F_{yy} \cdot y_x)y_{xx}+F_y \cdot y_{xxx}=0, \text{ etc.} \dots\dots(3)$$

Now in general y_x is given by (1) *uniquely*; but if $F_x=0=F_y$, then it is given by (2) or $(F_x+F_y \cdot y_x)^2=0$, a quadratic giving

$$y_x = \frac{-F_{xy} \pm \sqrt{F_{xy}^2 - F_{xx} \cdot F_{yy}}}{F_{yy}}$$

If *all the second derivatives*, F_{xx} , F_{xy} , F_{yy} , also vanish, then *three* values of y_x are given by the cubic

$$(F_x+F_y \cdot y_x)^3=0,$$

and so on.

Hence, for a double point solve simultaneously

$$F=0, F_x=0, F_y=0,$$

and find y_x from (2); for a triple point solve

$$F=0, F_x=0, F_y=0, F_{xx}=F_{xy}=F_{yy}=0,$$

and find y_x from (3); and so on.

For helpful devices see special works on *Curve Tracing*, as Frost's, Johnson's, Salmon's *Higher Plane Curves*, etc.

278. In drawing a curve near a singular point, as the origin O , it is well to have some better guide than the tangents, and some kind of *parabola* will generally offer itself as a close approximation. For we can usually pick out two quantities, u 's, that will be controlling, in comparison with which all the others are *small at will* near O . To discover these we *plot* the u 's, representing the term $ax^m y^n$ by the point $A(m, n)$, using exponents for coordinates; also let $B(p, q)$ and $C(r, s)$ depict the

terms bx^py^q and cx^ry^s . Draw the right line AB ; then if C lie *beyond* this line, from the origin O , the term cx^ry^s will be small at will, near O , for at least one branch of the curve; and if all the other terms are depicted by points lying beyond AB , then are they all infinitesimal in comparison with these two terms, so that these two are the controlling terms, and this branch of the curve near O approximates the parabola $ax^my^n + bx^py^q = 0$, or $ax^{m-p} + by^{q-n} = 0$. For along this parabola it is plain

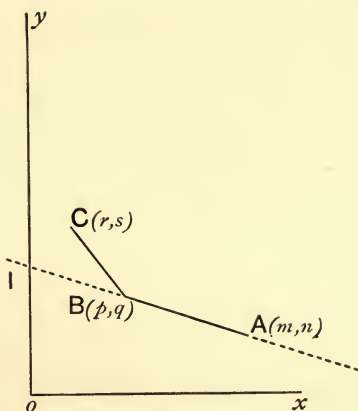

FIG. 50.

that the two terms, though of *different degrees*, must be of the *same order of magnitude*, otherwise their sum could not be 0; thus for n large at will, $\frac{a}{n^2}$ could not annul $\frac{b}{n}$. Hence regarding y as infinitesimal of 1st order, we

must have $x^{\frac{m-p}{q-n}}$ also infinitesimal of 1st order, hence x itself must be infinitesimal of order $\frac{q-n}{m-p}$, and this is $-\tan \tau$, where τ is the inclination of AB to OX ; hence the infinitesimality of the terms ax^my^n and bx^py^q is of order $n - m \tan \tau \equiv q - p \tan \tau$, and this is geometrically nothing but OI , the intercept of AB on Y . So, too, the order of

infinitesimality of $cx^r y^s$ is $s - r \tan \tau$, that is, the intercept on Y of the parallel to AB drawn through C ; this order is therefore higher, and hence this term may be neglected, if C lie beyond AB . It may happen that several lines like AB can be drawn, so that all other depicting points will lie beyond the two; in that case there will be as many branches of the curve through O .

It will be well for the student to draw the parabolas

$$y^m = x^n;$$

for $(m, n) = (1, 1); (1, 2); (1, 3); \dots; (2, 1); (2, 2); \dots (3, 1); \dots$

Illustration.— $ay^4 + 3a^2y^2x + 2x^3y^2 - ax^4 = 0$.

Depicting the terms in order by the points A, B, C, D , we see that the lines are AB and BD ; hence at the origin the branches

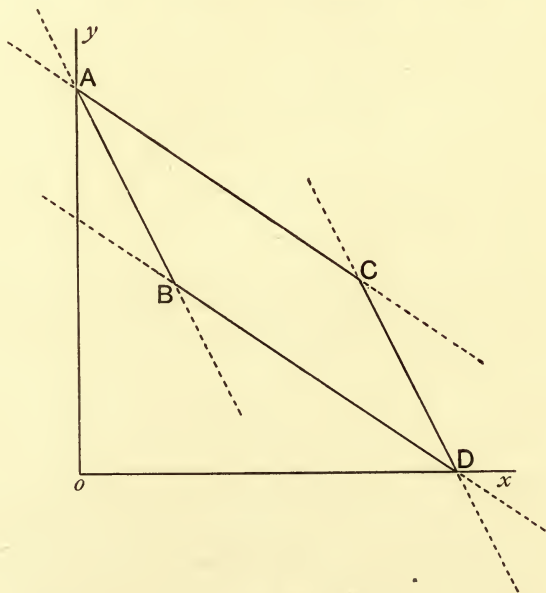

FIG. 50A.

approximate the parabolas $y^2 + 3ax = 0$ and $3ay^2 = x^3$. Draw them for $a = 1$.

279. The curve at ∞ .—In order to study the curve in remote regions of the plane, we again ask what curve it approaches as x or y or ρ increases without limit. In case $F(x, y)=0$ be rational, integral, and algebraic, we may use the method of Art. 278, but now we draw AB so as to be *beyond* all other depicting points C ; then the terms $ax^m y^n$ and $bx^p y^q$ are *great at will* (in remote regions) in comparison with every such term $cx^r y^s$, and at ∞ the curve approximates to $ax^m y^n + bx^p y^q = 0$. Thus, in the foregoing illustration AC and CD are two such lines, and the curve approximates at ∞ the parabolas $ay^2 + 2x^3 = 0$ and $2y^2 = ax$. The most important case of approximation is when *the difference between two corresponding ordinates* (either x or y) *approaches 0 as the other ordinate* (either y or x) *approaches ∞* . In such case the two curves are said to be *asymptotic*. Thus the quadratic curve $y = ax^2 + 2bx + c$ and the cubic

$$y = ax^2 + 2bx + c + \frac{d}{x}$$

are asymptotic, since for a common x the difference $\frac{d}{x}$ between the corresponding y 's approaches 0 as x approaches ∞ . Of course, the most important asymptotic lines are right lines, and they are called **Asymptotes**.

If then we can bring the equation of the curve to the form

$$y = sx + b + \frac{c}{x} + \frac{d}{x^2} + \dots,$$

then $y = sx + b$ is an asymptote.

But this cannot always be done, and the asymptotes must be discovered otherwise. Accordingly, we reflect that an asymptote must meet the curve in at least two points at ∞ , and we ask *for what values of s and b does $y = sx + b$, on combination with $F(x, y) = 0$, yield at least two ∞ roots in x ?*

Putting $y = sx + b$, we may write $F(x, y)$ thus:

$$\begin{aligned} F(x, y) &= u_n + u_{n-1} + u_{n-2} + \dots + u_0; \\ 0 &= x^n f_n\left(\frac{y}{x}\right) + x^{n-1} f_{n-1}\left(\frac{y}{x}\right) + \dots \\ &= x^n f_n\left(s + \frac{b}{x}\right) + x^{n-1} f_{n-1}\left(s + \frac{b}{x}\right) + \dots \\ &= x^n f_n(s) + x^{n-1} \{b f_n'(s) + f_{n-1}(s)\} + \dots \end{aligned}$$

This last expression is yielded by Taylor's theorem. There will be two ∞ values of x when, and only when, the two coefficients of the two highest powers, x^n and x^{n-1} , vanish; that is, when $f_n(s) = 0$ and $b f_n'(s) + f_{n-1}(s) = 0$.

Now $f_n(s) = 0$, being of n^{th} degree in s , has n roots, s_1, s_2, \dots, s_n ; and to each of these corresponds a value of b , as $b_1 = -f_{n-1}(s_1)/f_n'(s_1)$, etc.; and to each such pair of values corresponds a right line, as $y = s_1 x + b_1$, $y = s_2 x + b_2$, etc.; and these n right lines are the n asymptotes of the curve of n^{th} degree. Of course, some may be coincident, some imaginary; but if n be odd, at least one must be real; that is, a rational integral algebraic curve of odd degree has at least one real asymptote. It is indeed evident that such a curve cannot be *closed*. But among these n asymptotes may be the *Right Line at ∞* , with p points of contact with the curve, hence counting as p tangents at ∞ , and reducing the number of *asymptotes proper* (in finity) to $n - p$; thus, in $y^2 = 4ax$, $n - p = 2 - 2 = 0$, since $s = \pm 0$ and $b = \pm \infty$.

In case the term in y^n be missing from F , the term in s^n will also be missing on substitution, and, accordingly, one of the asymptotes yielded as above will be missing. But this vanishing of the highest power of s simply means that one value of s is ∞ , that is, *one asymptote is parallel to Y* . Or, in this case, we may exchange the notions of x and y , substitute $ty + a$ for x , and proceed as before. Let the student show that *the asymptotes parallel to the*

axes are obtained by equating to 0 the coefficients of the highest powers of x and of y , when possible.

The foregoing and many other methods will become clearer in practice, which will also disclose various higher singularities of transcendental curves.

ILLUSTRATIONS AND EXERCISES.

1. Investigate the *Witch of Agnesi* (1718-1799).

The geometric property is $OM : OB = MQ : MP$.

The equation is $x^2y = 4a^2(2a - y)$ or $y = 8a^3/(x^2 + 4a^2)$.

A glance at this equation shows that

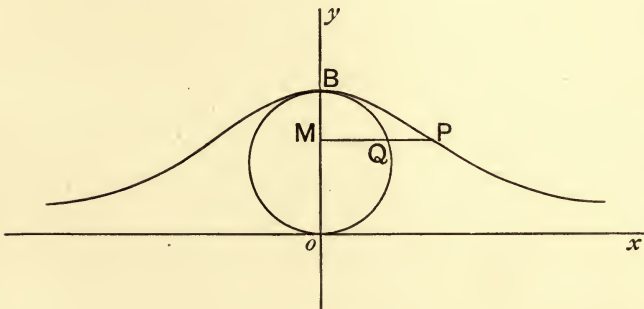

FIG. 51.

- (a) The curve is symmetric as to Y ; (b) y is a maximum, $2a$, for $x=0$; (c) the curve lies wholly above x , there is no negative y ; (d) $y=0$ for $x=\infty$, X is an asymptote, the other asymptotes are imaginary. By deriving twice, we find $y'' = 8a^3(6x^2 - 8a^2)/(x^2 + 4a^2)^3$, whence $y'' = 0$ for $x = \frac{2a\sqrt{3}}{3}$, two points of inflection; within them the curve is concave, without convex, to X .

2. Investigate the *Cisloid* of Diocles (?-?).

The geometric property is $OP = QT$.

The equation is $y^3 = x^2(2a - y)$ or $x^2 = \frac{y^3}{2a - y}$.

- (a) The curve is symmetric as to Y .
 (b) It lies above X , only $+y$'s are possible.
 (c) It lies below $y = 2a$, $y > 2a$ makes x imaginary.
 (d) For $y = 2a$, $x = \infty$; $y = 2a$ is an asymptote, the other asymptotes are imaginary.

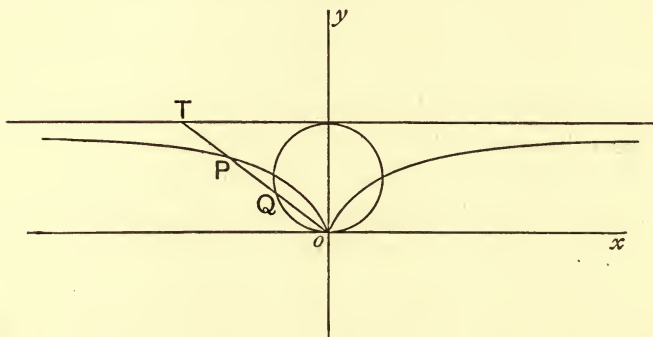

FIG. 52.

- (e) $y_x = \frac{2x(2a - y)}{x^2 + 3y^2}$ takes the form $\frac{0}{0}$ at origin, and the equation takes the form $2ax^2 - y(x^2 + y^2) = 0$; whence it appears that the Y -axis, $x = \pm 0$, is the double tangent, and the origin is a keratoid cusp.

3. Investigate the *Lemniscate* of Bernoulli.

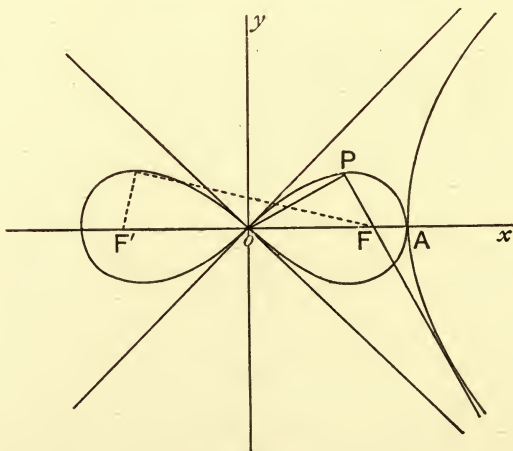

FIG. 53.

It is the locus of a point, the product of whose distances from two fixed points, $2c$ apart, is the constant c^2 .

Let the student show that it is the central pedal of the rectangular hyperbola, and that its equation is

$$\rho^2 = a^2 \cos 2\theta \quad \text{or} \quad (x^2 + y^2)^2 = a^2(x^2 - y^2), \quad (a^2 = 2c^2).$$

- (a) The curve lies wholly within the circle $\rho = a$.
- (b) It is symmetric as to X , as to Y , and as to O .
- (c) It lies wholly within the right lines $x \pm y = 0$, for $|x| < |y|$ the curve is imaginary.
- (d) At O it approaches $x \pm y = 0$, which are tangents there, so that O is a double point and point of inflexion for each tangent or branch.
- (e) It is throughout concave towards X .

4. Trace $xy = e^x$.

5. Investigate the *Folium Cartesii*.

The equation is $x^3 + y^3 - 3axy = 0$.

(a) The curve goes through O , where it approaches $xy = 0$, the axes, which are tangents, and O is a double point.

(b) $x = y$ is an axis of symmetry, which it may be

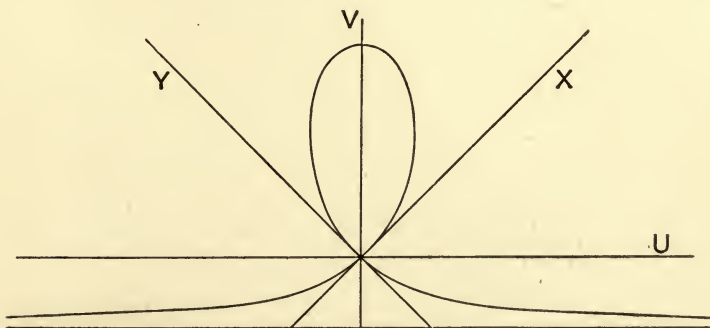

FIG. 54.

well to take for a new axis of abscissa by the equations

$$x = (u - v)\sqrt{\frac{1}{2}}, \quad y = (u + v)\sqrt{\frac{1}{2}},$$

whence

$$\sqrt{2}(u^3 + 3uv^2) - 3a(u^2 - v^2) = 0 \quad \text{or} \quad v^2 = \frac{u^2 \left(\frac{3a}{\sqrt{2}} - u \right)}{3 \left(u + \frac{a}{\sqrt{2}} \right)},$$

so that $u^2 - v^2 = 0$ is now the equation of the tangent at O . Also for $v = 0$ we have

$$u_1 = 0, \quad u_2 = 0, \quad u_3 = \frac{3}{2}a\sqrt{2}.$$

For $u > \frac{3a}{\sqrt{2}}$ the value of v is imaginary, and also for $u < -\frac{a}{\sqrt{2}}$, so that the curve does not extend beyond these values of u . For $0 < u < \frac{3a}{\sqrt{2}}$ the value of v is always finite, so that the curve has a loop; let the student find the maximum v^2 . For $u + \frac{a}{\sqrt{2}} = 0$, v becomes ∞ , so that this line is an asymptote; its equation is

$$x + y + a = 0.$$

6. Investigate the curve $x^2y + 9y = 3x$.

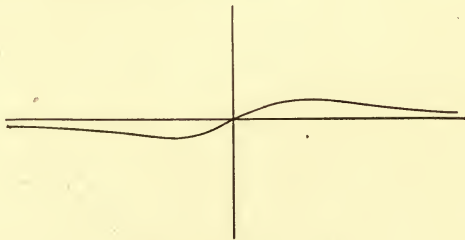

FIG. 55.

(a) The curve passes through and is symmetric as to O , lying wholly in 1st and 3rd quadrants.

(b) It has a maximum $y = \frac{1}{2}$ for $x = 3$, and a minimum $y = -\frac{1}{2}$ for $x = -3$.

(c) The second derivative

$$y'' = \frac{6x(x^2 - 27)}{(x^2 + 9)^3},$$

vanishes for $x=0$ or $\pm\sqrt{27}$, and also changes sign, hence the origin and the points

$$(3\sqrt{3}, \frac{1}{4}\sqrt{3}), \quad (-3\sqrt{3}, -\frac{1}{4}\sqrt{3})$$

are points of inflexion.

(d) For $x = \pm \infty$, $y = \pm 0$, so that X is an asymptote.

6A. Investigate the curve $\rho = a \cos 4\theta$.

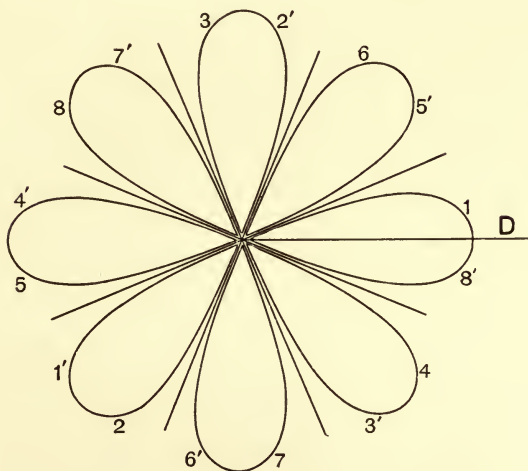

FIG. 56.

As θ ranges from $-\frac{\pi}{8}$ to $+0$, ρ ranges from 0 to a ; as θ ranges from 0 to $\frac{\pi}{8}$, ρ ranges from a to 0; hereby one loop is yielded. As θ ranges from $\frac{\pi}{8}$ to $\frac{3\pi}{8}$, ρ ranges from 0 to $-a$, and from $-a$ to 0 again, which negative values are to be laid off backward from 0; hereby loop (2) is traced. A new loop is traced for each octant-range of θ , alternately positively and negatively. A point in continuous motion (the end of $+\rho$ resp. $-\rho$) passes eight times through O , which is an octuple point.

Similarly for $\rho = a \cos n\theta$, $\rho = a \sin n\theta$. Let the student show that the curve has n loops for n odd, but $2n$ loops for n even.

7. Trace the curves $\rho \cos n\theta = a$ (Cotes' spirals), the inverses of the preceding, and draw the asymptotes.
8. Trace the indented curve $\rho = 3 + \cos 5\theta$.
It lies between the circles $\rho = 2$ and $\rho = 4$, touches each at the vertices of a regular pentagon, and has ten points of inflexion.
9. Show that the curve $x^2(a^2 - x^2) = y^2(a^2 + x^2)$ may be derived from B.'s lemniscate by lengthening each ρ in the ratio $\sec \theta : 1$.
10. Trace the Cardioid $\rho = a \left(\cos \frac{\theta}{2} \right)^2$.

This belongs to the important group $\rho^n = a^n \cos n\theta$.

11. Trace the Limaçon of Pascal, $\rho = a + b \cos \theta$.
12. Trace the Trident, $x^3 - axy = a^3$ or $y = \frac{x^2}{a} - \frac{a^2}{x}$.

It meets X at $x = a$, where it has a point of contrary flexure; for $x > a$ it rises, approaching the parabola $x^2 = ay$; for $x = \pm 0$, $y = \mp \infty$, the curve is asymptotic to Y on both sides; for $x = -a/\sqrt[3]{2}$, y is a minimum, $= \frac{3}{2}a\sqrt[3]{2}$.

13. Trace $x^5 - 5a^2xy^2 + 2y^5 = 0 = F$.

Here $f_n(s) = 2s^5 + 1$ (Art. 279), which, equated to 0, yields $s = -\frac{1}{\sqrt[5]{2}}$ and four imaginary roots, hence there is

only one real asymptote. Also $f_{n-1}(s) = 0$, hence from $bf'_n(s) + f_{n-1}(s) = 0$ we see that $b = 0$, and the asymptote passes through O . Since $u_1 = 0$ and $u_2 = 0$, O is a triple point; the tangents are $x = 0$, $y = +0$, $y = -0$, the last two coincident. This last result we may obtain analytically, thus: At O ,

$$F' = 0; \quad F_x = 5x^4 - 5a^2y^2 = 0; \quad F_y = 10y^4 - 10a^2xy = 0;$$

$$F_{xx} = 20x^3 = 0; \quad F_{xy} = -10a^2y = 0; \quad F_{yy} = 40y^3 - 10a^2x = 0;$$

$$F_{xxx} = 60x^2 = 0; \quad F_{xxy} = 0; \quad F_{xyy} = -10a^2; \quad F_{yyy} = 120y^2 = 0.$$

Hence to determine y_x we have the cubic

$$(F_x + F_y \cdot y_x)^{(3)} = 0 = 0 + 3 \cdot 0 + 3(-10a^2)y_x^2 + 0 \cdot y_x^3,$$

of which the three roots are $y_x = \infty$ or $+0$ or -0 , which yield, as above, X as a double, and Y as a single, tangent.

14. Trace $y^2 - x^2(x - a) = 0$.

For $x=0, y=0$, the origin is a point of the curve. For all other values of $x < a$, y is imaginary; hence O is isolated. The tangents at O are imaginary, as appears thus: At O ,

$$F = 0, F_x = -3x^2 + 2ax = 0, F_y = 2y = 0;$$

$$F_{xx} = -6x + 2a = 2a, F_{xy} = 0, F_{yy} = 2;$$

hence from

$$F_{xx} + 2F_{xy} \cdot y_x + F_{yy} \cdot y_x^2 = 0, y_x = \pm \sqrt{-a}.$$

The curve consists of one infinite branch cutting X orthogonally for $x = a$, and with two symmetric points of inflexion for $x = \frac{2}{3}a$.

15. Show that $ay^2 = x^3$ has a cusp at O .

16. All curves of third degree may be produced from

$$y^2 = Ax^3 + 3Bx^2 + 3Cx + D = A(x - a)(x - b)(x - c)$$

by projection. Trace this latter on five suppositions:

- (1) a, b, c real and unequal; (2) a and b equal; (3) b and c equal; (4) a, b, c all equal; (5) b and c imaginary.

17. Trace the Strophoid, $x(x^2 + y^2) = a(x^2 - y^2)$; the Catenary,

$$y = a \operatorname{hc} \frac{x}{a};$$

$$x = \sqrt{a^2 - y^2} + a \{ \log(a - \sqrt{a^2 - y^2}) - \log y \};$$

and the Logarithmic curve, $x = \log y$.

18. Trace the Asteroid, $x^{\frac{2}{3}} + y^{\frac{2}{3}} = a^{\frac{2}{3}}$, and show that its evolute is similar, but twice as great.

19. Trace the Equiangular Spiral, $\rho = ae^{c\theta}$, where c is cotangent of the constant angle, and show that its evolute is a congruent spiral; also trace the Parabolic spirals, $\rho = a\theta^n$, for $n = 1, -1$, and $-\frac{1}{2}$; also the Probability curve, $y = e^{-x^2}$.

20. Trace the curve, $y = \sin \frac{\pi}{x}$.

For $x=1$, $y=0$; for $x>1$ the curve rises to a maximum at $(2, 1)$; thence for $x>2$ it sinks down asymptotically

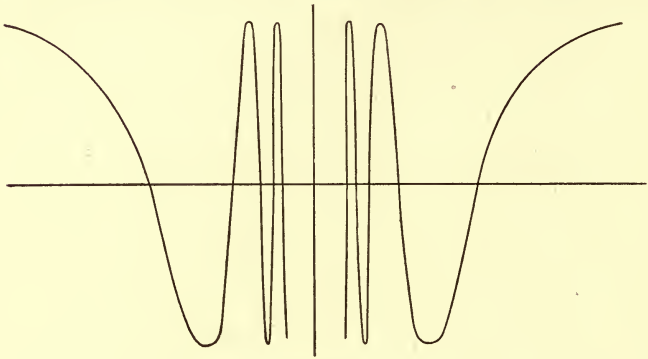

FIG. 57.

towards X . For x between 1 and $\frac{1}{2}$, it forms an arch below X ; for x between $\frac{1}{2}$ and $\frac{1}{3}$, it forms an arch above X ; for x between $\frac{1}{n}$ and $\frac{1}{n+1}$, it forms an arch above or below X , according as n is even or odd. For x approaching 0, n approaching ∞ , these waves retain the same amplitude 2, but are crowded together more and more, so that for $x=0$, at O , the curve loses all definite character, the sine is in fact *not defined* for infinite arguments. The curve is symmetric as to the origin.

21. Trace $y = x \sin \frac{\pi}{x}$.

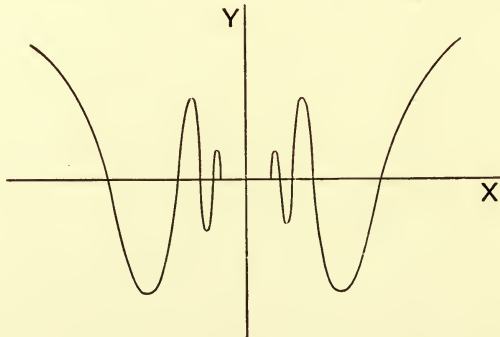

FIG. 58.

The curve crosses X at $x=1$, thence with increasing x it rises towards the asymptote, $y=\pi$. For x decreasing towards 0, the waves in the preceding example die away toward 0-amplitude at O . The curve is symmetric as to Y .

22. Trace (a) $y^2 = \sin \frac{\pi}{x}$, and (b) $y^2 = x \sin \frac{\pi}{x}$.

The undulations in Ex. 20 are changed in shape but not in amplitude in (a); those of Ex. 21 are changed in shape and increased in amplitude in (b); in both (a) and (b) they are reflected above and below X , and vanish from the plane for y^2 negative, y imaginary, leaving for $-1 < x < 1$, two symmetric series of detached arcs that shrink, and in (b) sink, toward 0 at O . The asymptotes in (b) are $y = \pm \sqrt{\pi}$.

23. Trace $y^2 = x \left(\sin \frac{\pi}{x} \right)^2$.

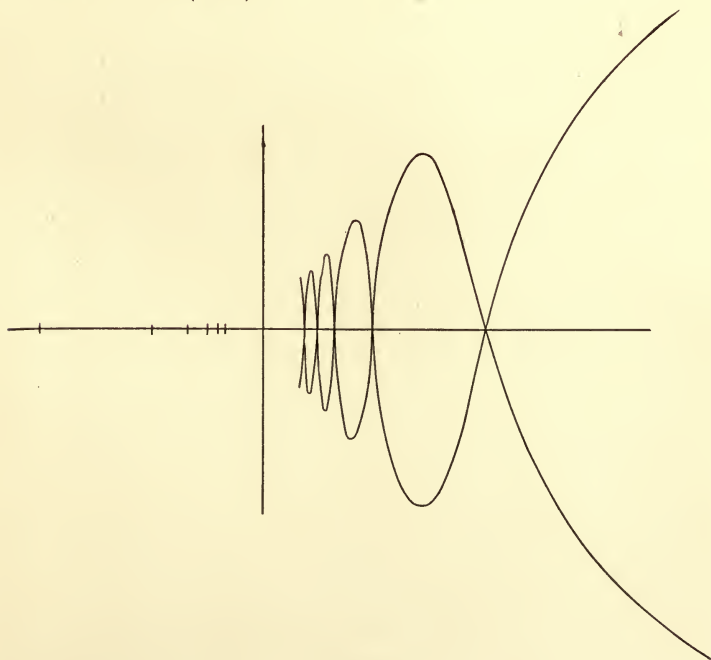

FIG. 59.

For $x+$, the vanishing imaginary arcs of Ex. 23 reappear as real; but for $x-$, the whole curve vanishes as imaginary, leaving only a *series of isolated points* on the negative X -axis, for

$$-x = 1, \frac{1}{2}, \frac{1}{3}, \dots, \frac{1}{n}, \dots,$$

and these are heaped together infinitely towards O . Such a series is called by Vincent a *branche pointillée*.

24. Trace $y = x^x$, $y = x^{x^x}$, $y = x^{\frac{1}{x}}$.

25. Trace $y = x \log x$.

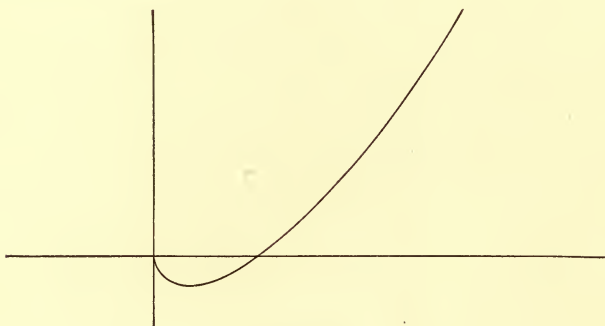

FIG. 60.

The curve meets X at $x=0$ and $x=1$; it has a minimum $y = -\frac{1}{e}$ for $x = \frac{1}{e}$; for $x=e$, $y=e$; for $x=0$, $y=0$; for x negative, y is imaginary, the single branch of the curve stops at O , which is accordingly called a *stop point* or *point d'arrêt*. The *progressive* differential coefficient becomes $-\infty$ at O , the *regressive* becomes imaginary; the tangent *on from* O is Y .

26. Trace $y^n = x^m \log x$ and $y = e^{\frac{1}{x}}$.

27. Trace $y = \frac{e^{\frac{1}{x}} - 1}{e^{\frac{1}{x}} + 1} = \frac{1 - e^{-\frac{1}{x}}}{1 + e^{-\frac{1}{x}}}$.

These expressions being in general equivalent, the curve is symmetric as to O . For $x = +0$ (nearing 0 through

positive values), $y = +1$, for $x = -0$, $y = -1$, the curve suffers discontinuity at the origin, the two branches stop

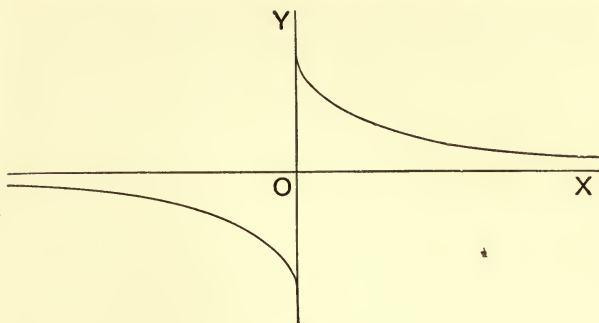

FIG. 61.

at $(0, +1)$ and $(0, -1)$. Let the student find the points of flexure and the asymptote.

28. Trace $y = x \frac{e^{\frac{1}{x}} - 1}{e^{\frac{1}{x}} + 1}$.

Here the factor x introduces symmetry as to Y , and dissolves the foregoing discontinuity in y , but works a similar discontinuity in y_x . For in the vicinity of O we have

$$\text{progressive differential coefficient} = \lim_{x \rightarrow 0^+} \frac{y}{x} = \lim_{x \rightarrow 0^+} \frac{e^{\frac{1}{x}} - 1}{e^{\frac{1}{x}} + 1} = 1,$$

$$\text{regressive differential coefficient} = \lim_{x \rightarrow 0^-} \frac{y}{x} = \lim_{x \rightarrow 0^-} \frac{e^{\frac{1}{x}} - 1}{e^{\frac{1}{x}} + 1} = -1,$$

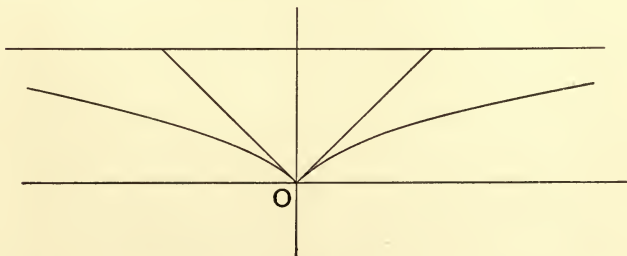

FIG. 62.

while the notion of derivative proper fails. The branches

diverge at right angles. Such a point of finite divergence of branches is called a **salient point** (*point saillant*).

29. Trace $x^5 + 2a^2x^2y - a^3y^2 = 0 = F$, or $y = \frac{x^2}{a} \left(1 \pm \sqrt{\frac{x+a}{a}} \right)$.

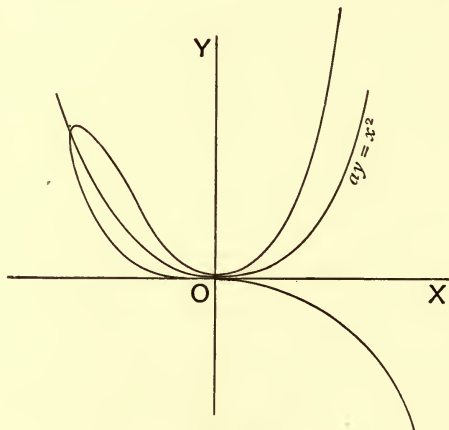

FIG. 63.

At O , $F_x = 0 = F_y = F_{xx} = F_{xy}$, $F_{yy} = -2a^3$, hence $y_x = \pm 0$, so that O is a double point, and apparently a cusp. But from the value of y we see at once that for $x=0$ (at O) $y_{xx} = \frac{4}{a}$ or 0 , according as we take the $\sqrt{\quad} +$ or $-$, that is, for the upper or the lower branch of the curve. Hence this lower branch has also an inflexion at O . Such a point, where cusp and inflexion combine to form a double cusp of both species, is called a point of **Osculinflexion** (Cramer). Observe that the parabola $ay = x^2$ bisects all chords of the curve parallel to Y , it is a kind of curvilinear diameter.

30. Trace the Conchoid, $(x^2 + y^2)^2(x - a)^2 = b^2x^2$; the Quadratrix,

$$y = (a - x) \tan(\pi x/2a);$$

the Cartesian oval,

$$(x^2 + y^2 - 2ax + k^2)^2 = b^2(x^2 + y^2);$$

and the Cassinian oval,

$$(x^2 + y^2)^2 + a^4 = 2a^2(x^2 - y^2) + c^4.$$

31. Trace $x(x+y)^2 \pm a^2y = 0$.

For $+a^2$ the curve has the *parallel* asymptotes $x+y \pm a=0$, a third asymptote $x=0$, and is inflected at O ; ∞ is a *node*. For $-a^2$, the parallel asymptotes are imaginary, ∞ is an *acnode*.

32. Trace $a^4(b^2 - x^2) = x^4(y - c)^2$.

Here Y is asymptotic to the real branches, and X is asymptotic to the imaginary branches.

33. Trace $x^4 + 2a^3y - a^2y^2 = 0$.

There are two parabolic asymptotes $x^2 = \pm a(y - a)$.

34. Trace $\rho = a(\cos \theta - \cos 2\theta)$ and $\rho = a(\sin \theta - \sin 2\theta)$.

35. Trace $xy = \sin \pi x$, $xy = \sin \frac{\pi}{x}$, and generalize.

NOTES.

Page 17. For another view of the relation of Derivative and Differential Coefficient, see Stolz, *Grundzüge der Differential- und Integralrechnung*, p. 27.

Page 97. By Trigonometry, $1 + \cos 2a = 2(\cos a)^2$,

$$1 - \cos 2a = 2(\sin a)^2;$$

hence
$$\cos 2a = \frac{1 - (\tan a)^2}{1 + (\tan a)^2}, \quad \sin 2a = \frac{2 \cdot \tan a}{1 + (\tan a)^2};$$

that is, sine and cosine, and therefore all other simple trigonometric functions of an angle are expressible rationally through the *tangent of the half-angle*. Hence, to integrate $\int F dx$, where F is a rational function of the ordinary trigonometric functions of x , we put $x = 2y$, and $u = \tan y$; then F passes over into ϕ , a rational function of u , and dx is supplaccd by $\frac{du}{1+u^2}$, and we have only to integrate, as to u , a rational function of u , which is easily done by Part-Fractions. Let the student extend the reasoning to functions of hyperbolic functions. This *tangent of the half-angle* is an extremely important and useful new variable. This observation was originally intended for Vol. II., but is in place here.

Page 125. That Derivation in the vicinity of the critical value $x = a$ does actually remove the vanishing factor $x - a$ from both numerator and denominator, may also be shown thus:

Let $F(x) = \frac{\phi(x)}{\psi(x)}$, and $\phi(a) = 0$, $\psi(a) = 0$; then to evaluate

$$F(a) \equiv \frac{\phi(a)}{\psi(a)},$$

we note that identically
$$\frac{\phi(x)}{\psi(x)} \equiv \frac{\frac{\phi(x) - \phi(a)}{x - a}}{\frac{\psi(x) - \psi(a)}{x - a}}, \quad \text{for } x \text{ not } = a.$$

If now we take the Limit of both sides for $x=a$, the left side becomes $\frac{\phi(a)}{\psi(a)}$, and the right side becomes $\frac{\phi'(a)}{\psi'(a)}$, and we observe that both numerator and denominator of the right member are divided by $x-a$.

Page 173. The notion of *arc-length* presents some logical difficulty. We can easily fix the meaning of *equal*, *greater*, and *less*, in case of tracts, segments of straight lines, because all such are homœoidal throughout, and hence may be compared immediately by superposition. Like may be said of arcs of equal circles, and of congruent circular spirals. So we may compare integers directly, by counting them off, or fractions by reducing them to a common denominator and then counting off the numerators. The parts of the magnitudes compared here fit on one another, and the question is simply of excess, or defect, or neither.

But such comparison is not possible between arcs of different curves, as unequal circles, or arcs in general from different regions of the same curve, as from near the vertices (major and minor) of an ellipse; nor between any arc and a straight segment; since in none of these cases is superposition possible,—no part of the one magnitude will fit on any part of the other.

In order then to compare arcs, we first refer them to the simplest standard, the straight line, which may be supposed broken up into a polygon of sides small at will, as a rational number into fractions. Accordingly we inscribe and circumscribe the arc with polygons of n sides, and these we may suppose parallel in pairs. Then as n increases and each side decreases the two polygons close down upon each other indefinitely,—the one always increasing in length, the other always decreasing,—so that the difference between their lengths becomes σ , small at will; but neither ever becomes comparable in any part with any part of the arc lying always between the two. The area of the strip or ring between the polygons tends to vanish, but does not vanish for any finite value of n however great, so that we cannot by such process *prove* that the arc has length at all, in the sense in which the rectilinear polygons have length. It seems then that our only recourse must be to an Assumption in the form of a Definition: We assume that the arc has length, and we define that length to be the common Limit-length of both inscribed and circumscribed polygons of n sides when each side becomes small at will as n becomes large at will.

The question remains, Will this arc-length, this Limit, be the

same, no matter how the polygons be inscribed and circumscribed? This amounts to the pure analytic question: Is the value of the Definite Integral entirely independent of the way in which the interval or region of Integration is cut up into elements or sub-intervals? The answer is in general *Yes*, but the proof would not be in place in this volume.

Similar remarks apply to *Complanation* of surfaces. Quite analogous, in pure Arithmetic, is the genesis of the notion of an Irrational Number, as itself not any rational number, but the Limit of a series of rational numbers, $n_1, n_2, n_3, \dots, n_k, \dots$, formed after some definite law, and such that the difference

$$|n_{k+s} - n_k|$$

may be made and kept small at will, for all values of s , by taking k large enough; or, still better, as the common Limit of two such series, $\dots n_k \dots$ and $\dots n'_k \dots$, where $n'_k > n_k$.

INDEX.

[Numerals refer to pages]

- Abel, 322.
Aberrancy, 253.
Acnode, 326.
Agnesi, 333.
Algebraic, 6.
Angle of curves, 38.
Angles, solid, 216.
Anomaly, 91.
Anticlastic, 214.
Anti-functions, 83.
Anti-operators, 55.
Anti-tangent, 119.
Arc, 25, 33.
Areas, 61, *passim*.
Argument, 6, *passim*.
Array, rectangular, 294.
Asteroid, 167.
Asymptotes, asymptotic, 331.
Attraction, 303.
Averages, 18, 177.
Axes, normal, 182.
Axes, parallel and principal, 181.

Bernoulli, 113, 121, 334.
Binomials, 120, 201.
Binormal, 201.

Cartesius, 335.
Cauchy, 114.
Centre of curvature, 155.
Centroid, 180.
Characteristic, 205.
Chord, 25.
Circle of convergence, 119.
Circle of curvature, 155.

Cisoid, 170, 333.
Complanation, 292.
Concavity and convexity, 151.
Confocals, 300.
Conjugates, 50.
Contact, 149, 159, 161.
Contingence, 152, 201.
Continuity, 8.
Convergent expansions, 131.
Coordinates, cylindric, 248.
 polar, 34, 274.
 spheric, 247.
Correspondence, 7.
Cosecant, 94.
Cosine, 23, 84, *passim*.
Cramer, 344.
Crunode, 326.
Cubature, 173.
Curvature, 152-3, 215-6.
 centre of, 155, 159, 202,
 lines of, 216.
 maximal and minimal, 162.
 order of, 169.
 radius of, 155.
 total, 204.
Cusp, 326.
Cuspidal edge, 206.
Cyclic points, 216.
Cycloid, 167, 176.

Density, 182.
Dependence, multiple, 192.
Derivation, mediate, 14.
Derivatives, 10, 48, 195, 208,
 passim.

- Developables, 206-7.
 Deviation, 253.
 Difference-quotient, 9.
 Differential, coefficient, 12.
 equations, 121, 251.
 notation, 80.
 total, 199.
 Diocles, 170, 333.
 Dirichlet, 320.
 Discriminant, 92, 205.
 Double angle, 95.
 Double points, 131.
 Doubly periodic functions, 102.
 Dupin, 213.

 Elasticity, surface of, 224, 228.
 Eliminant, 205, 251, *sqq.*
 Elliptic functions, 102.
 Enneper, 303.
 Envelopes, 43, 204.
 Euler(ian), 122, 215, 313, 315, 319.
 Evanescents, 124.
 Evolute, 157.
 Exact differentials, 287.
 Exceptional cases, 139.
 Explicit, 7.
 Exponential, 22, 102.
 Extremes, 64, 67, *passim.*

 Fermat, 147.
Folium Cartesii, 335.
 Fourier, 283.
 Fresnel, 224.
 Frost, 328.
 Function, 5, 314, *passim.*
 Fundamental forms, 77.

 Gamma-function, 315.
 Gauss(ian), 216-7, 305, 315.
 Green, 295.
 Gudermannian, 89.
 Guldinus, 184.
 Gyration, 181.

 Halsted, 217.
 Helix, 204.
 Higher Functions, 101.
 Hodograph, 20.

 Hyperbolic Functions, 84, *passim.*
 Hypocycloid, 47.

 Illusory forms, 129.
 Implicit, 7.
 Indicatrix, 213.
 Inertance, Inertia, 180.
 Infinitesimal, 3, *passim.*
 Infinite products, 314, 320.
 Inflexion, 152, 162, 325.
 Integral, 63, *passim.*
 Integrand, 64, *passim.*
 Integrand, infinite, 278-9.
 Integration, 63, *passim.*
 Integration by parts, 80.
 Intersections, 42, 43.
 Intrinsic equations, 327.
 Inverse functions, 28.
 Involute, 137.
 Irrational quadratics, 99.

 Jacobi(an), 316, 239, *passim.*
 Johnson, 328.

 Kelvin, 296.
 Keratoid, 334.

 Lagrange, 114.
 Laplace, 248.
 Legendre, 315.
 Leibnitz, 50, 54.
 Lemniscate, 334.
 Limit, 1, *passim.*
 Linear set, 280.
 Line-integral, 286.
 Liouville, 322.
 Logarithm, 22.
 Loops, 325.

 Maclaurin, 116.
 Mass-centre, 178-9.
 Maxima and minima, 134, 218.
 Maximum-minimum theorem, 66.
 Mean value, 66.
 Mediate derivation, 14.
 Mediate integration, 29.
 Mixed higher derivatives, 208.
 Moment, 180.

- Monge, Mongian, 254.
 Multiple dependence, 192.
 Multiple points, 327.

 Neighbourhood, 8.
 Neil, 166.
 Newton, 120, 169.
 Nodes, 206, 326.
 Normal, 32, 102.
 Normal integrals, 100.

 Operators, 49, 54, 247.
 Orthogonal transformation, 249.
 Osculatory circle, 155, 164.
 conic, 326.
 paraboloid, 213.
 plane, 201.
 sphere, 204.
 Oscul-inflexion, 344.

 Pappus, 183.
 Parabolas, 165.
 Paraboloid, osculating, 213.
 Parallel axes, 191.
 Parallel sections, 193.
 Parameters, 41, 45, 306, *passim*.
 Part-fractions, 12.
 Partial derivatives, 195.
 Pedals, 38.
 Plücker, 327.
 Poisson, 248.
 Potential function, 248.
 Powers, even and odd, 95.
 Pressure, centre of, 303.
 Principal value, 278.
 Probability-curve, 339.
 Probability-integral, 312.
 Products, infinite, 314, 320.
 Progressive differential coefficient, 98.
 Pure higher derivatives, 208.

 Quadrature, 61, 68, *passim*.

 Radius of curvature, 155.
 Radius of torsion, 202.
 Rational algebraic functions, 98.
 Reciprocants, 237.

 Rectangular array, 294.
 Rectification, 173.
 Recursion, 94.
 Refraction, 147.
 Regressive differential coefficient, 12.
 Remainder, 114.
 Removal of factors, 124.
 Reversion of series, 255.
 Revolutes, 175.
 Revolution, Solids of, 174.

Saillant, point, 17, 344.
 Salmon, 328.
 Schwarzian, 237, 254.
 Secant, 94.
 Sense, 28.
 Series, 2, 116, *passim*.
 Simultaneous changes, 197.
 Sine, 23, *passim*.
 Snell, 147.
 Solid Angles, 216.
 Speed, 18.
 Spinode, 326.
 Spirals, 204, 225, 227.
 Stere-radian, 217.
 Stirling, 116.
 Subnormal and subtangent, 33.
 Substitution, 79.
 Surface of elasticity, 224, 228.
 Sylvester, 237.
 Symbolism, 11, *passim*.
 Symmetry, 184.
 Synclastic, 214.

 Tangency, 150, 194.
 Tangents, 16, 32.
 Taylor, 114, 211.
 Theorem of mean value, 211.
 Torricelli, 147.
 Torsion, 202.
 Tortuous curves, 200.
 Total curvature, 204.
 Total differential, 199.
 Transcendental, 6.
 Transon, 253.
 Triple integrals, 289.

Umbilicus, 216.
 Undulation, point of, 162.
 Unique, 7.
 Undetermined multipliers, 141,
 221.
 Value, mean, 66.
 Value, principal, 278.

Value, singular, 283.
 Variable, change of, 234, *sqq.*
 Velocity, 19.
 Viviani, 148.
 Waring, 229.
 Wave-surface, 224.

THE END.



U. C. BERKELEY LIBRARIES



065399183

QA

303

S653

1898

v. 1

MATH

MATH/ST.
LIBRARY

07/26/01

